

Pin layout

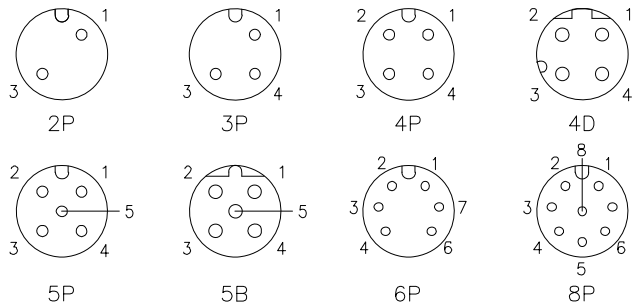

Technical specifications:

Coupling: Threaded coupling  
 Termination: screw  
 Pollution degree: 3  
 Temperature range: -20°C ~ +80°C  
 Degree of protection: IP67 when mated  
 Mating cycles: ≥500  
 Suitable cable Dia: A:4~6mm;B:6~8mm  
 Wire gauge: 2~5Pin:AWG22; 6~8Pin:AWG24

Materials:

Contact: Brass  
 Contact plating: Gold plated  
 Contact insert: TPU Black  
 Base shell: Zinc nickel plated  
 Hex nut: Brass nickel plated  
 Seal: NBR

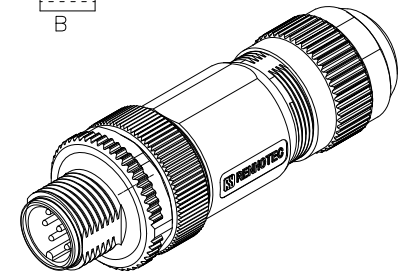
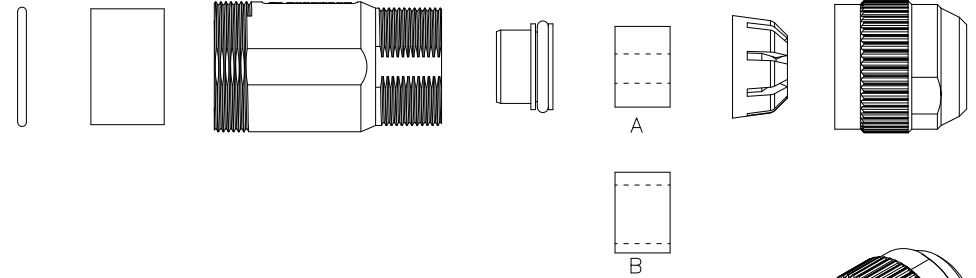
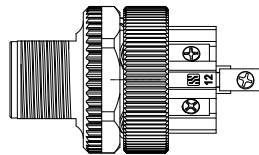
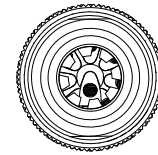
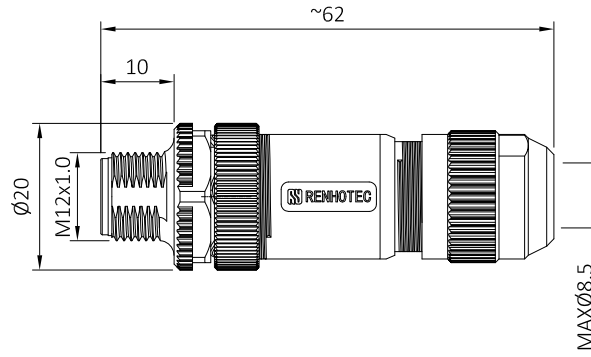
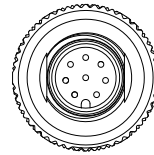

PIN	2	3	4	4D	5	5B	6	8
Rated voltage/Current	4A/250V	4A/250V	4A/250V	4A/250V	4A/60V	4A/60V	2A/30V	2A/30V
Rated pulse voltage	2500V	2500V	2500V	2500V	1500V	1500V	800V	800V
Insulation resistance (MΩ)	≥ 100	≥ 100	≥ 100	≥ 100	≥ 100	≥ 100	≥ 100	≥ 100
Contact resistance (mΩ)	≤ 5	≤ 5	≤ 5	≤ 5	≤ 5	≤ 5	≤ 5	≤ 5

-TOLERANCES- UNLESS OTHERWISE SPECIFIED	DOSIN INDUSTRIAL(HK)CO.,LTD 江门市德索连接器有限公司 Jiangmen Dosin Connector Co., LTD Web: <a href="https://www.dosinconn.cn/">https://www.dosinconn.cn/</a> Mailbox: <a href="mailto:sale@dosin.cn">sale@dosin.cn</a> Tel: (0086)769-81153906				
	PART DESCRIPTION: M12 Male connector,Assembly,Shielded				
UNLESS OTHERWISE SPECIFIED TOLERANCES FOR MILLIMETERS ARE: 0.5 - 8mm ± 0.20mm 8 - 30mm ± 0.25mm 30 - 120mm ± 0.30mm	Appr:	JIM.KING			
	Check:	Date	Scale	Unit	Type
	Draw:	2023.08.08	Free	MM	Z
P/N:		DS869MCS0439			Page
					1/1

## X-ON Electronics

Largest Supplier of Electrical and Electronic Components

*Click to view similar products for [Standard Circular Connector](#) category:*

*Click to view products by [dosinconn](#) manufacturer:*

Other Similar products are found below :

[600273N007](#) [6134-336-13149](#) [6134-337-11149](#) [6134-337-2390](#) [6134-341-17149](#) [67-02E12-60PX](#) [CXS3102A181S](#) [75-190611-03S](#) [75-474014-05S](#) [75-474211-03P](#) [75-474618-04S](#) [75-474620-07P](#) [799539-000](#) [805-005-07NF11-19PC](#) [805-005-07NF15-7PA](#) [FMP.2M.310.XLCT](#) [836783-1](#) [862256-1](#) [866857-1](#) [867865-1](#) [PT08P-14-19S](#) [PT08P-14-5S](#) [QCM019PC2DC012B](#) [121583-0217](#) [121667-0020](#) [RD10A16-19-P6CS051/1](#) [RD16A14-12-S6CS051/2](#) [1301240268](#) [1301240275](#) [DCU-08BFEA-LL7001](#) [RM15WTP-CP\(5\)\(71\)](#) [14482](#) [16283-18](#) [1877910-1](#) [206039-3](#) [206323-1](#) [207002-2](#) [207682-1](#) [CA06COME14SA7P](#) [211777-1](#) [JL04-1012CK\(05\)-R](#) [JL04V-2A28-11PE-R](#) [JL04V-2E10SL-3PE-B-R](#) [JL04V-2E20-15PE-B-R](#) [JL04V-2E20-4PE-B-R](#) [JL04V-6A24-11SE-EB-R](#) [JN1AS04MK1X](#) [JN1HS10PLKS2](#) [JN2AS04MK2X-R](#) [JN2DS10SL3-R](#)