

**Features**

- Input voltage: up to 35V
- Output voltage: 5V
- Output current up to 500 mA, internal thermal overload protection and short-circuit current limiting.

**TO-252**

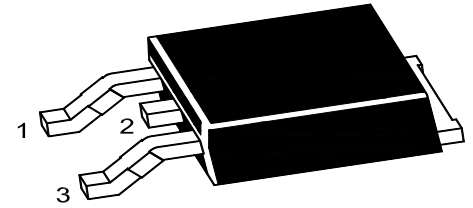

1. VIN 2. GND 3. VOUT

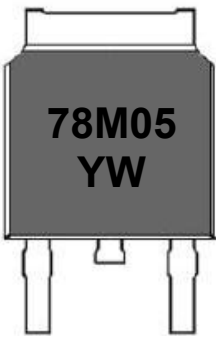
	<b>Marking code</b>											
	<b>78M05 YW</b>	78M05: Product code										
		Y: Year code	2022	2023	2024	2025	2026	2027	2028	2029	2030	2031
	W: Week code	G	H	J	K	A	B	C	D	E	F	
	Weeks	1~26			27~52			53				
	code	A~Z			a~z			z				

**Absolute Maximum Ratings**

Ratings at 25°C ambient temperature unless otherwise specified.

Parameter	Symbol	Value	Unit
Input Voltage	$V_I$	35	V
Thermal Resistance, Junction-to-Air	$R_{\theta JA}$	100	°C/W
Operating Temperature Range	$T_{OPR}$	-40 to +125	°C
Storage Temperature Range	$T_{STG}$	-65 to +150	°C

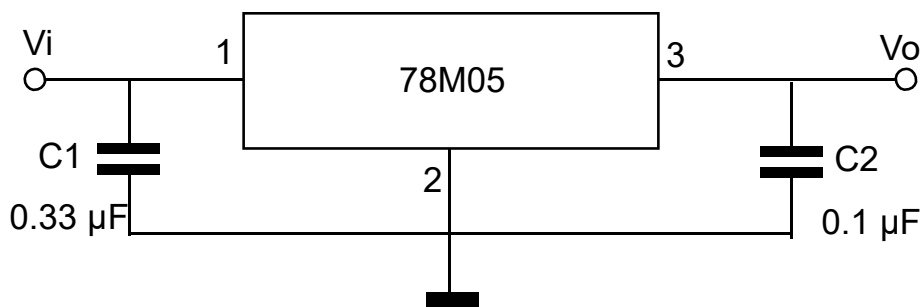

**Electrical Characteristics**

 Ratings at  $V_I=10V, I_O=350mA, C_I=0.33\mu F, C_O=0.1\mu F$ , With heat sink, unless otherwise specified.

Parameter	Symbol	Test Conditions	Min.	Typ.	Max.	Unit
Output Voltage	$V_O$		4.8	5.0	5.2	V
		$V_I=7V$ to $20V, 5mA \leq I_O \leq 350mA$	4.75	5.0	5.25	
Line Regulation	$\Delta V_O$	$V_I=7V$ to $25V, I_O=200mA$	--	--	100	mV
Load Regulation	$\Delta V_O$	$V_I=10V, 5mA \leq I_O \leq 200mA$	--	--	50	mV
		$V_I=10V, 5mA \leq I_O \leq 500mA$	--	--	100	mV
Dropout Voltage	$V_D$	$I_O=350mA$	--	2	--	V
Quiescent Current	$I_Q$		--	--	6	mA
Quiescent Current Change	$\Delta I_Q$	$V_I=10V, 5mA \leq I_O \leq 350mA$	--	--	0.5	mA
		$8V \leq V_I \leq 25V, I_O=200mA$	--	--	0.8	mA
Output Voltage Drift	$\Delta V_O / \Delta T$	$I_O=5mA, 0 \leq T_J \leq 125^\circ C$	--	0.5	--	mV/ $^\circ C$
Supply Voltage Rejection	SVR	$8V \leq V_I \leq 18V, f=120Hz, I_O=300mA$	62	--	--	dB
Output Noise Voltage	$V_N$	$10Hz \leq f \leq 100Hz$	--	40	--	$\mu V$
Short Circuit Current	$I_{SC}$	$V_I=35V$	--	200	--	mA



Typical Characteristic Curves

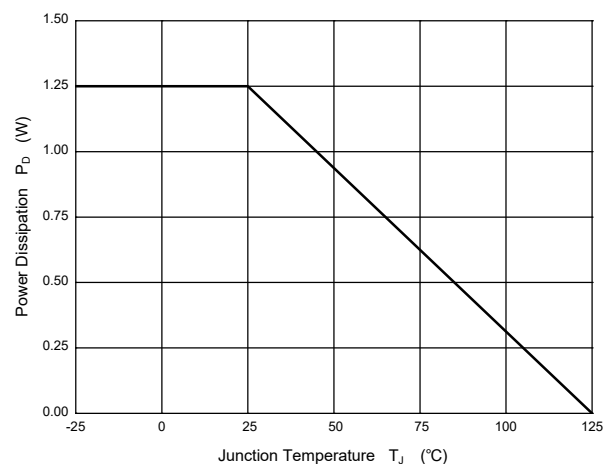
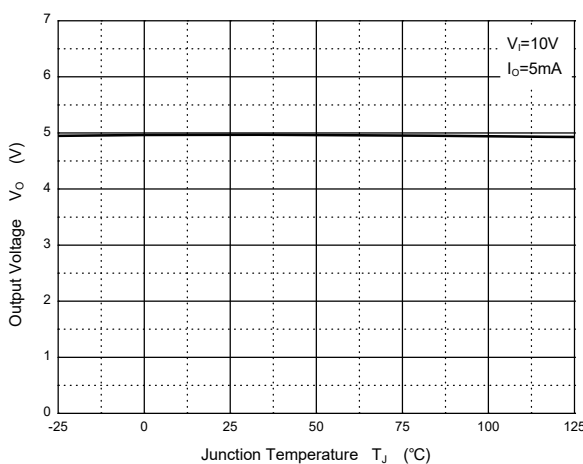
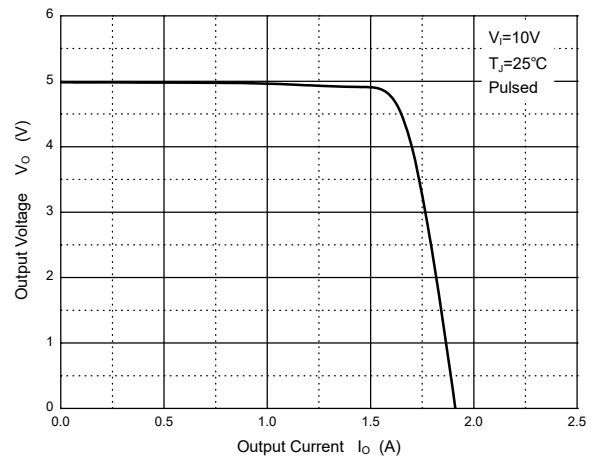
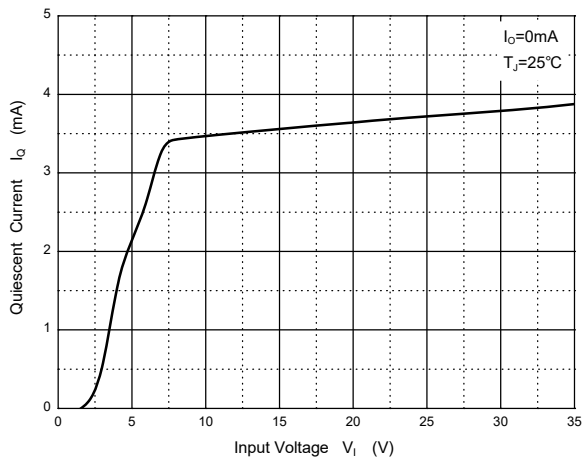
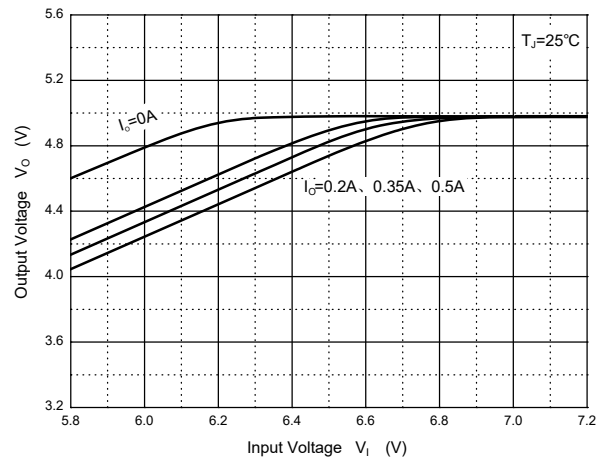
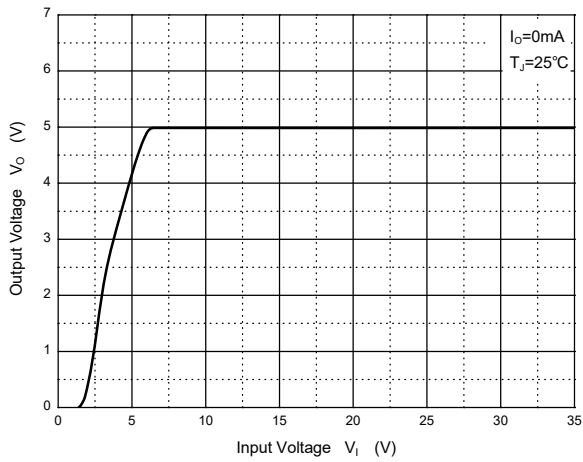

## Package Outline

TO-252

Dimensions in mm

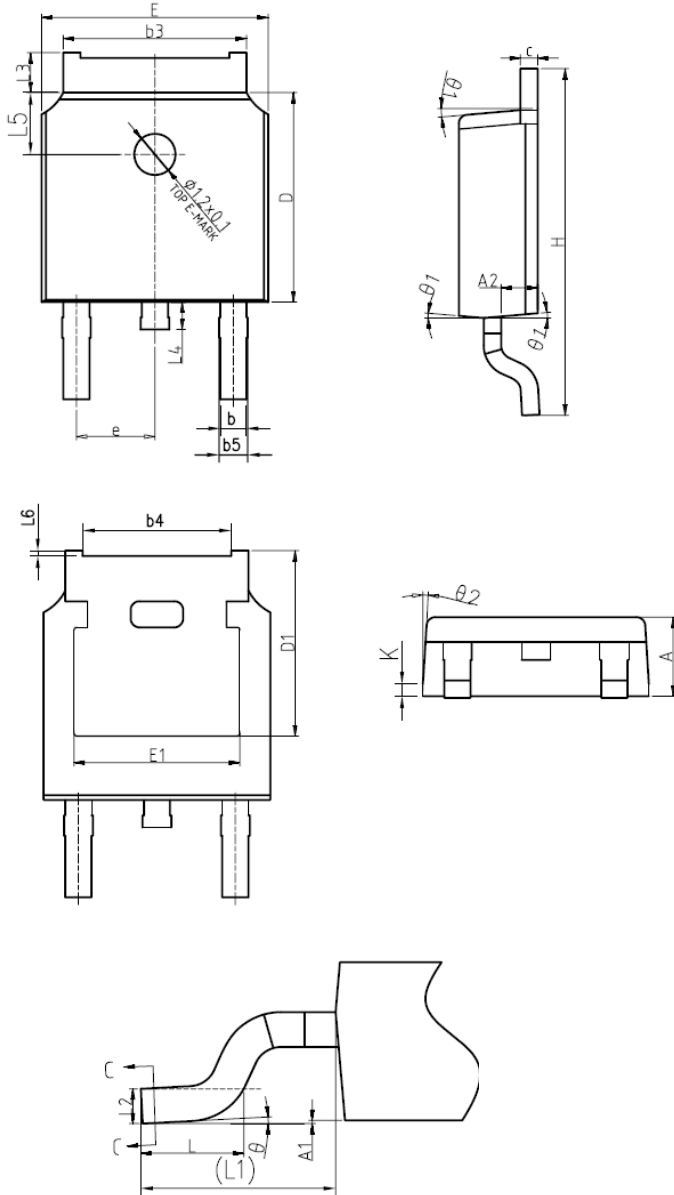

Symbol	mm		
	Min.	Nom.	Max.
*A	2.20	2.30	2.38
*A1	0.00	--	0.10
A2	0.97	1.07	1.17
*b	0.72	0.78	0.85
b1	0.71	0.76	0.81
*b3	5.23	5.33	5.46
b4	4.27	4.32	4.37
b5	0.72	0.88	0.93
*c	0.47	0.53	0.58
c1	0.46	0.51	0.56
*D	6.00	6.10	6.20
D1	5.30REF		
*E	6.50	6.60	6.70
E1	4.70	4.83	4.92
*e	2.286BSC		
*H	9.90	10.10	10.30
L	1.40	1.50	1.70
L1	2.90REF		
L2	0.51BSC		
*L3	0.90	--	1.25
*L4	0.60	0.80	1.00
L5	1.70	1.80	1.90
L6	0	0.047	0.123
$\theta$	0°	--	8°
* $\theta 1$	5°	7°	9°
$\theta 2$	5°	7°	9°
K	0.40REF		
带*为检验尺寸			

## Ordering Information

Device	Package	Shipping
78M05	TO-252	2,500PCS/Reel&13inches

## X-ON Electronics

Largest Supplier of Electrical and Electronic Components

*Click to view similar products for [Linear Voltage Regulators](#) category:*

*Click to view products by [DOWO](#) manufacturer:*

Other Similar products are found below :

[LV5684PVD-XH](#) [MCDTSA6-2R](#) [L7815ACV-DG](#) [LV56801P-E](#) [UA7805CKC](#) [714954EB](#) [ZMR500QFTA](#) [BA033LBSG2-TR](#)

[NCV78M05ABDTRKG](#) [LV5680P-E](#) [L79M05T-E](#) [L78LR05D-MA-E](#) [NCV317MBTG](#) [NTE7227](#) [MP2018GZD-33-P](#) [MP2018GZD-5-P](#)

[LV5680NPVC-XH](#) [ZTS6538SE](#) [UA78L09CLP](#) [UA78L09CLPR](#) [CAT6221-PPTD-GT3](#) [MC78M09CDTRK](#) [NCV51190MNTAG](#)

[BL1118CS8TR1833](#) [BL8563CKETR18](#) [BL8077CKETR33](#) [BL9153-33CC3TR](#) [BL9161G-15BADRN](#) [BL9161G-28BADRN](#)

[BRCO7530MMC](#) [CJ7815B-TFN-ARG](#) [LM317C](#) [GM7333K](#) [GM7350K](#) [XC6206P332MR](#) [HT7533](#) [LM7912S/TR](#) [LT1764S/TR](#) [LM7805T](#)

[LM338T](#) [LM1117IMP-3.3/TR](#) [HT1117AM-3.3](#) [HT7550S](#) [AMS1117-3.3](#) [HT7150S](#) [78L12](#) [HT7550](#) [HT7533-1](#) [HXY6206I-2.5](#) [HT7133](#)