

## ■ Features

- High Current Capability
- Low Forward Voltage Drop
- Extremely Fast Switching Speed

## ■ Mechanical Data

- package:SOT-23
- Flammability rating of epoxy resin: UL 94V-0
- Mounting Position: Any

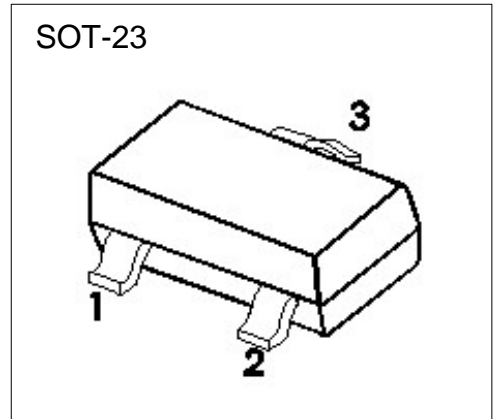

## ■ Ordering Information

Part Number	Package	Marking	Packing	Quantity per reel	Reel Size
BAS40	SOT-23	43	Tape & Reel	3000 PCS	7 inches
BAS40-06	SOT-23	46	Tape & Reel	3000 PCS	7 inches
BAS40-05	SOT-23	45	Tape & Reel	3000 PCS	7 inches
BAS40-04	SOT-23	44	Tape & Reel	3000 PCS	7 inches

## ■ Pin Configuration

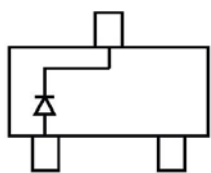

BAS40

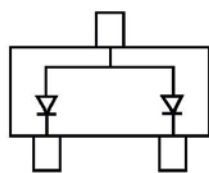

BAS40-06

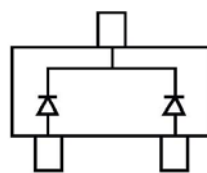

BAS40-05

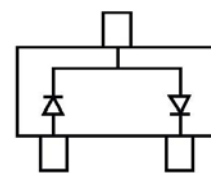

BAS40-04

**Maximum Ratings & Thermal Characteristics**(Ratings at 25°C ambient temperature unless otherwise specified.)

Parameters	Symbol	Limit	Unit
Maximum repetitive peak reverse voltage	VRRM	40	V
Maximum DC blocking voltage	VDC	40	V
Maximum average forward rectified current	IFM	200	mA
Typical thermal resistance	R $\theta$ JA	500	°C/W
Power Dissipation	PD	200	mW
Junction Temperature	Tj	125	°C
Storage temperature range	TSTG	-50-+150	°C

**Electrical Characteristics**(Ratings at 25°C ambient temperature unless otherwise specified)

Parameters	Symbol	Test conditions	Min	Typ	Max	Unit
Maximum forward voltage	VF1	IF = 1mA			380	mV
	VF2	IF = 40mA			1000	
Maximum reverse breakdown voltage	VR	IR=10uA	40			V
Maximum reverse current	IR	VR=30V			200	nA
Type junction capacitance	CD	VR = 0V, f = 1MHz			5	pF
Reverse Recovery time	trr	IF=IR=10mA Irr=1XIR, RL=100Ω			5	ns



### ■ Typical Characteristics

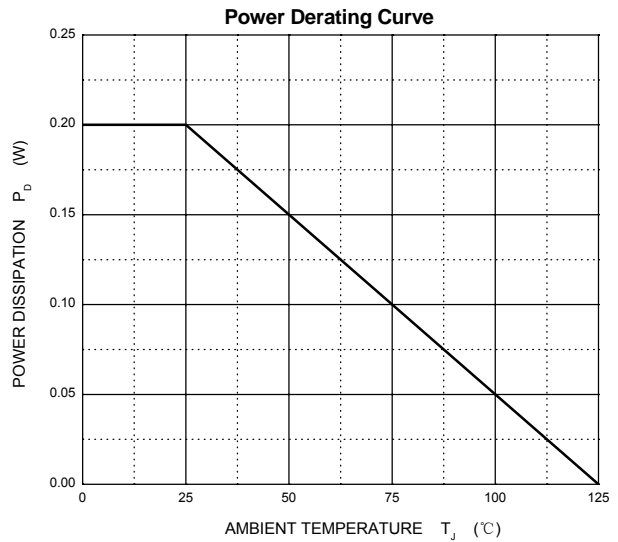
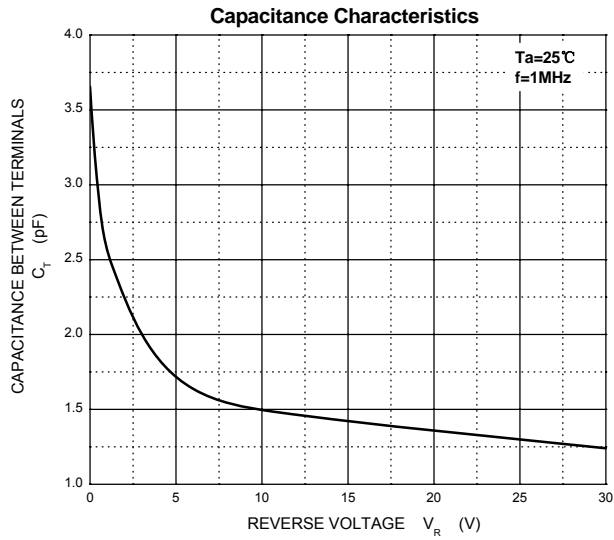
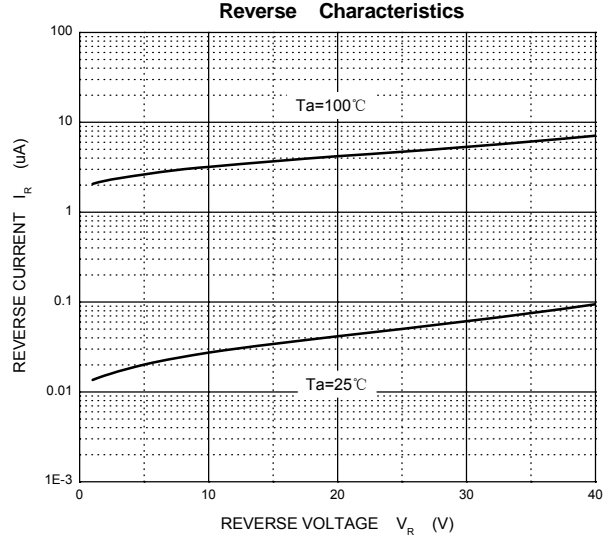
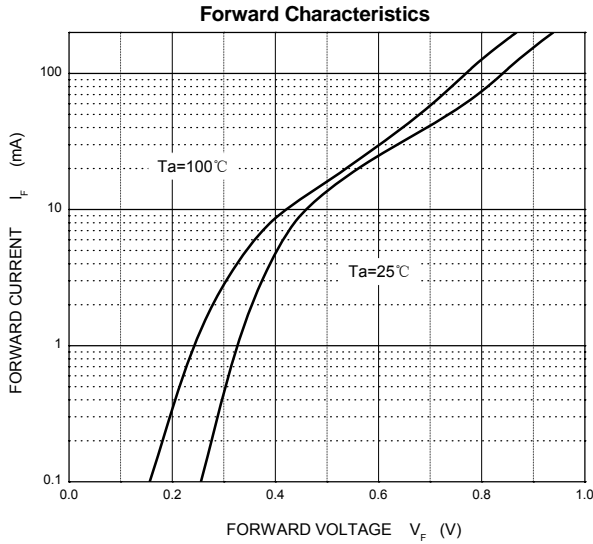



■ SOT-23 Package Outline Dimensions

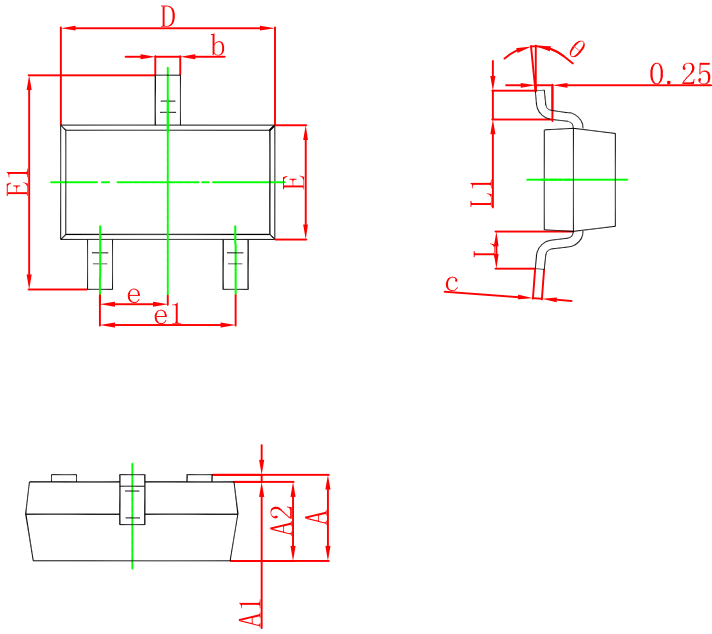

Symbol	Dimensions In Millimeters	
	Min	Max
A	0.900	1.150
A1	0.000	0.100
A2	0.900	1.050
b	0.300	0.500
c	0.080	0.150
D	2.800	3.000
E	1.200	1.400
E1	2.250	2.550
e	0.950 TYP	
e1	1.800	2.000
L	0.550 REF	
L1	0.300	0.500
$\theta$	0°	8°

## X-ON Electronics

Largest Supplier of Electrical and Electronic Components

*Click to view similar products for [Schottky Diodes & Rectifiers](#) category:*

*Click to view products by [DOWO](#) manufacturer:*

Other Similar products are found below :

[MA4E2039](#) [MMBD301M3T5G](#) [HFA35HB60C](#) [RB160M-50TR](#) [D83C](#) [BAS16E6433HTMA1](#) [BAS 3010S-02LRH](#) [E6327](#) [BAT 54-02LRH](#)  
[E6327](#) [NRVBAF360T3G](#) [NSR05F40QNXT5G](#) [NTE555](#) [JANS1N6640](#) [SS3003CH-TL-E](#) [GA01SHT18](#) [CRS10I30A\(TE85L,QM](#)  
[MBRA140TRPBF](#) [MBRB30H30CT-1G](#) [BAT 15-04R](#) [E6152](#) [JANTX1N5712-1](#) [DMJ3940-000](#) [SB007-03C-TB-E](#) [NRVBB20100CTT4G](#)  
[NRVBM120LT1G](#) [NTSB30U100CT-1G](#) [CRG04\(T5L,TEMQ\)](#) [ACDBA1100LR-HF](#) [ACDBA1200-HF](#) [ACDBA240-HF](#) [ACDBA3100-HF](#)  
[CDBQC0530L-HF](#) [ACDBA260LR-HF](#) [ACDBA1100-HF](#) [10BQ015-M3/5BT](#) [NRVBM120ET1G](#) [VSSB410S-M3/5BT](#) [1N5819T-G](#)  
[PDS1040Q-13](#) [B160BQ-13-F](#) [SDM05U20CSP-7](#) [BAS 70-07](#) [E6433](#) [B140S1F-7](#) [HSM560Je3/TR13](#) [DDB2265-000](#) [ZHCS506QTA](#)  
[HSM190Je3/TR13](#) [B330AF-13](#) [ACDBUC0230-HF](#) [SDM1U100S1F-7](#) [MBR10200CTF-G1](#) [CDLL5712](#)