

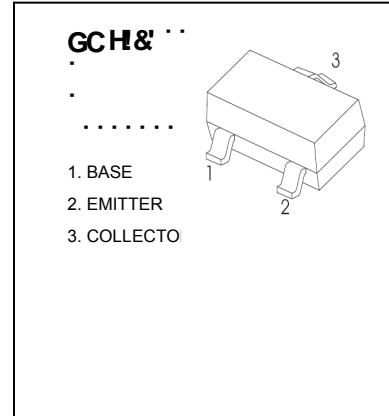

.....67, %± TRANSISTOR (NPN)

: 95HI F9G

- For general AF applications
- High collector current
- High current gain
- Low collector-emitter saturation voltage
- Complementary types: BC807 (PNP)



A5L-AI A F5HB; Gfh1&) °C i b`Ygg`cH Yfk jgY`bcHXL`

Grna Vc`	DUFUa YHf`	JUi Y`	I b]h
J76c`	Collector-Base Voltage	50	V
J79c`	Collector-Emitter Voltage	45	V
J96c`	Emitter-Base Voltage	5	V
7`	Collector Current -Continuous	0.5	A
D7`	Collector Power Dissipation	0.3	W
H^	Junction Temperature	150	°C
H_glf`	Storage Temperature	-55-150	°C

9 @7 HF 7 5 @7 < 5 F 5 7 H9F -GH7 G`fh1&) °C i b`Ygg`cH Yfk jgY`gdYWZ`YXL`

..... DUFUa YHf`	Grna Vc`	HYgh V`bX]hcbg`	A in	Typ`	A ax	Unit
7c`YWcf!VUgY VfYU_Xck b`j`c`HJ`Y`	V _{CB0}	I _C = 10μA, I _E =0	50			V
7c`YWcf!Ya]Hf`VfYU_Xck b`j`c`HJ`Y`	V _{CE0}	I _C = 10mA, I _B =0	45			V
9a]Hf`!VUgY VfYU_Xck b`j`c`HJ`Y`	V _{EBO}	I _E = 1μA, I _C =0	5			V
7c`YWcf`W HcZZW ffYbh	I _{CB0}	V _{CB} = 45 V, I _E =0			0.1	μA
9a]Hf`W HcZZW ffYbh	I _{EBO}	V _{EB} = 4V, I _C =0			0.1	μA
87`W ffYbh[U]b`.....	h _{FE(1)}	V _{CE} = 1V, I _C = 100mA	100		600	
	h _{FE(2)}	V _{CE} = 1V, I _C = 500mA	40			
7c`YWcf!Ya]Hf`gUhi fU]cb`j`c`HJ`Y`	V _{CE(sat)}	I _C = 500mA, I _B = 50mA			0.7	V
6 UgY!Ya]Hf`gUhi fU]cb`j`c`HJ`Y`	V _{BE(sat)}	I _C = 500mA, I _B = 50mA			1.2	V
6 UgY!Ya]Hf`j`c`HJ`Y`	V _{BE}	V _{CE} = 1 V, I _C = 500mA			1.2	V
7c`YWyf`WUdUW]UbW`	C _{ob}	V _{CB} =10V, f=1MHz		10		pF
HfUbg]hcb`Z`Yei`YbWni	f _T	V _{CE} = 5 V, I _C = 10mA f=100MHz	100			MHz

7 @ GG= 7 5 HCB`C: `h_{FE`%}

FUb`	67, %±!%`	67, %±!&`	67, %±!(\$`
FUb[Y`	%%\$!&) \$`	% \$!(\$ \$`	&) \$!* \$ \$`
AUf_]b[`	* 5`	* 6`	* 7`

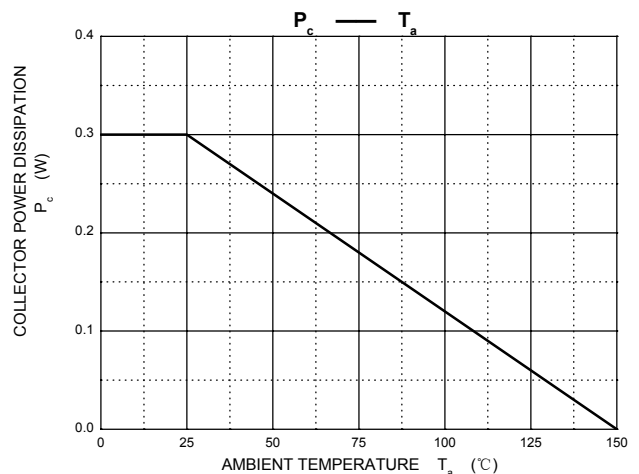
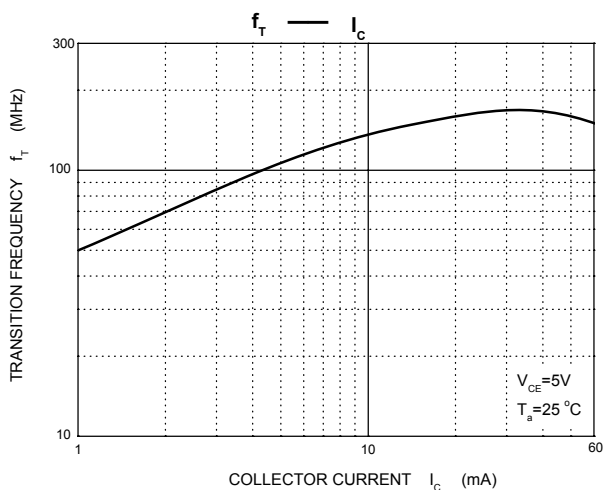
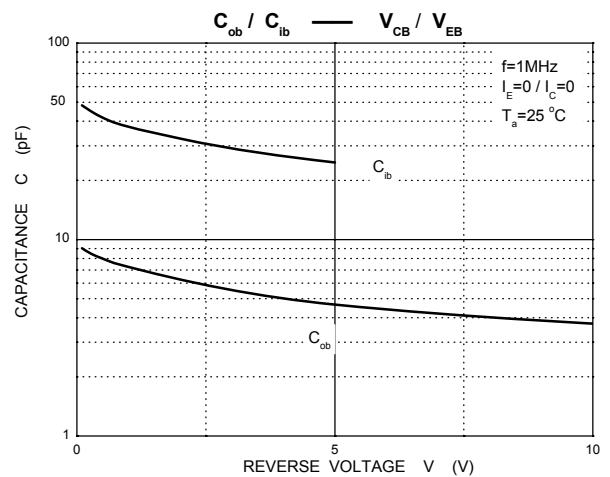
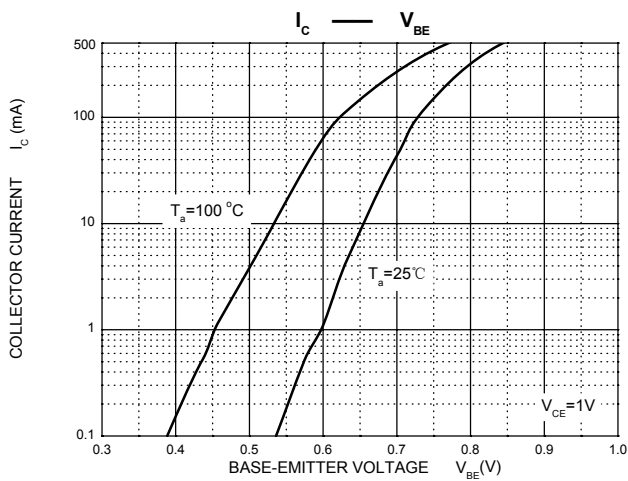
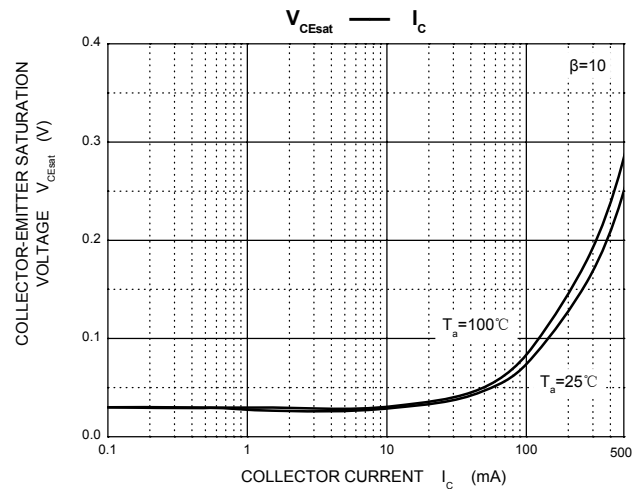
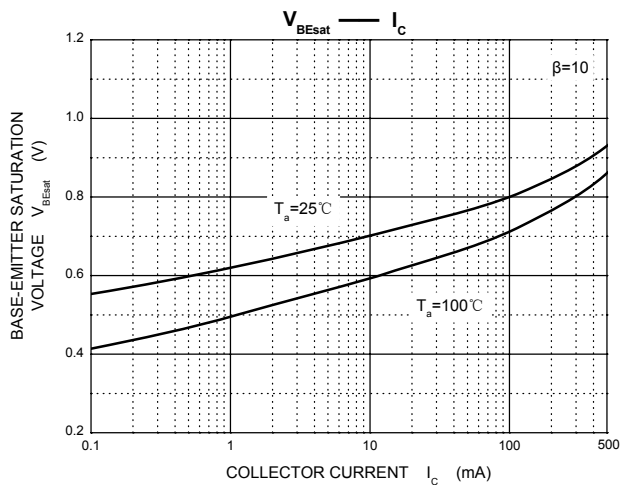
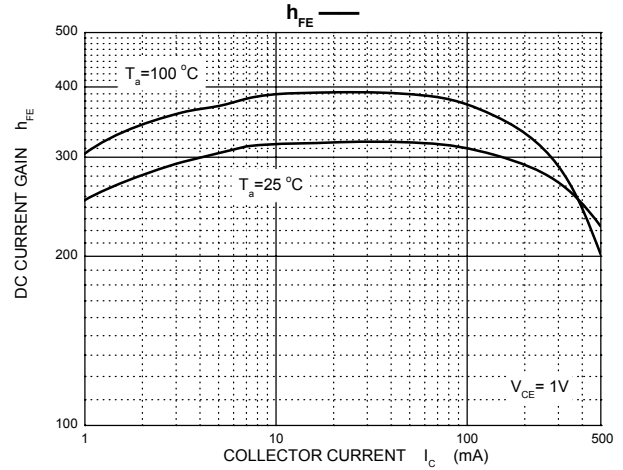
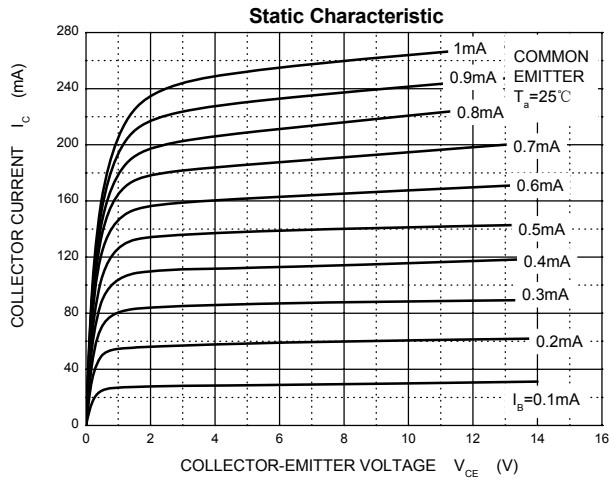

X-ON Electronics

Largest Supplier of Electrical and Electronic Components

Click to view similar products for [Bipolar Transistors - BJT category](#):

Click to view products by [DOWO manufacturer](#):

Other Similar products are found below :

[619691C](#) [MCH4017-TL-H](#) [MJ15024/WS](#) [MJ15025/WS](#) [BC546/116](#) [BC556/FSC](#) [BC557/116](#) [BSW67A](#) [HN7G01FU-A\(T5L,F,T](#)
[NJVMJD148T4G](#) [NSVMMBT6520LT1G](#) [NTE187A](#) [NTE195A](#) [NTE2302](#) [NTE2330](#) [NTE2353](#) [NTE316](#) [IMX9T110](#) [NTE63](#) [NTE65](#)
[C4460](#) [SBC846BLT3G](#) [2SA1419T-TD-H](#) [2SA1721-O\(TE85L,F\)](#) [2SA1727TLP](#) [2SA2126-E](#) [2SB1202T-TL-E](#) [2SB1204S-TL-E](#) [2SC5488A-](#)
[TL-H](#) [2SD2150T100R](#) [SP000011176](#) [FMC5AT148](#) [2N2369ADCSM](#) [2SB1202S-TL-E](#) [2SC2412KT146S](#) [2SC4618TLN](#) [2SC5490A-TL-H](#)
[2SD1816S-TL-E](#) [2SD1816T-TL-E](#) [CMXT2207 TR](#) [CPH6501-TL-E](#) [MCH4021-TL-E](#) [BC557B](#) [TTC012\(Q\)](#) [BULD128DT4](#) [JANTX2N3810](#)
[Jantx2N5416](#) [US6T6TR](#) [KSF350](#) [068071B](#)