



■ Features

- Uni-directional ESD protection of two lines
- 70Watts peak pulse power (tp = 8/20μs)
- Working voltage: 5V
- Ultra low capacitance: 0.5pF typical
- Low clamping voltage
- Ultra low leakage: nA level
- Up to 2-line protects
- IEC 61000-4-2 ±15kV contact ±20kV air
- IEC 61000-4-5 (Lightning) 4.5A (8/20μs)

■ Applications

- Cellular Handsets and Accessories
- Notebooks and Handhelds
- Portable Instrumentation
- Set Top Box
- Industrial Controls
- Server and Desktop PC

■ Mechanical Data

- Package:SOT-23
- Molding compound flammability rating: UL 94V-0
- RoHS/WEEE Compliant

■ Schematic & PIN Configuration

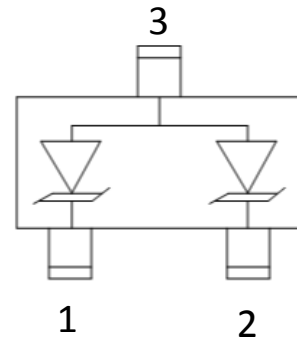

■ Ordering Information

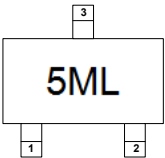
Part Number	Package	Marking	Packing	Reel Size
ESD5302F	SOT-23		3000 Tape & Reel	7 inches

■ Absolute Maximum Rating($T_A=25^{\circ}\text{C}$ unless otherwise Specified)

Parameter	Symbol	Value	Unit
Reverse Power	Ppk	70	W
Reverse Peak Current	IPP	4.5	A
Reverse Standoff Voltage	VESD	± 20 ± 15	kV
Junction Temperature	TJ	-55 to +125	$^{\circ}\text{C}$
Storage Temperature	Tstg	-55 to +150	$^{\circ}\text{C}$

■ Electrical Characteristics($T_A=25^{\circ}\text{C}$ unless otherwise Specified)

Parameter	Symbol	Test Condition	Min	Typ	Max	Unit
Reverse Working Voltage	VRWM				5.0	V
Breakdown Voltage	VBR	$I_T = 1\text{mA}$	6.0	7.5	8.5	V
Reverse Leakage Current	IR	VRWM = 5.0V			0.5	μA
Clamping Voltage	VC	IPP = 1A (8 x 20 μs pulse)		9	11	V
Clamping Voltage	VC	IPP = 4.5A (8 x 20 μs pulse)		13	15	V
Junction Capacitance	CJ	VR = 0V, f = 1MHz, pin 1 or pin 2 to pin 3		0.5	0.6	pF
Junction Capacitance	CJ	VR = 0V, f = 1MHz, between pin 1 and pin 2		0.3	0.35	pF

■ Electrical Parameters ($T_A = 25^{\circ}\text{C}$ unless otherwise noted)

Symbol	Parameter
I_T	Test Current
IPP	Maximum Reverse Peak Pulse Current
Vc	Clamping Voltage @Ic

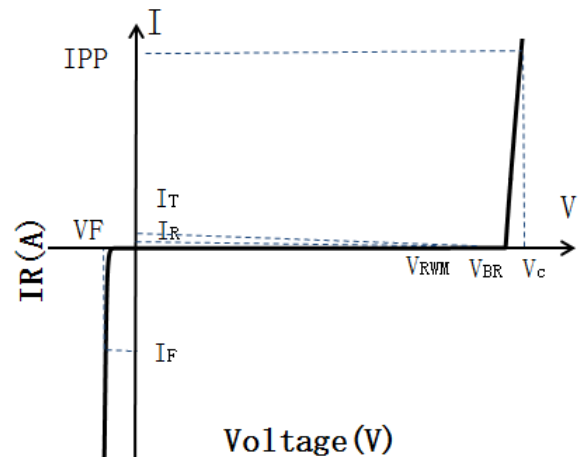



■ Typical Characteristics($T_A=25^{\circ}\text{C}$ unless otherwise Specified)

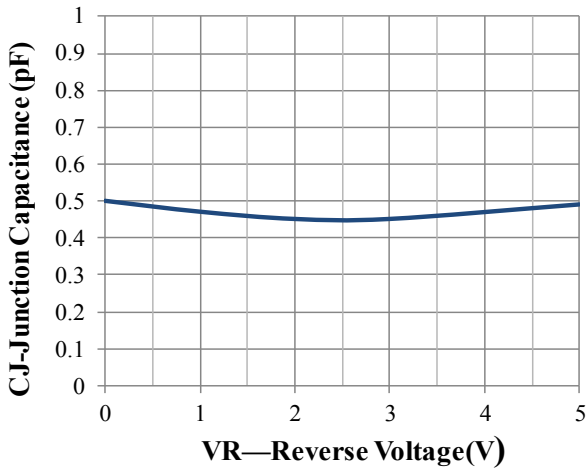

Junction Capacitance vs. Reverse Voltage

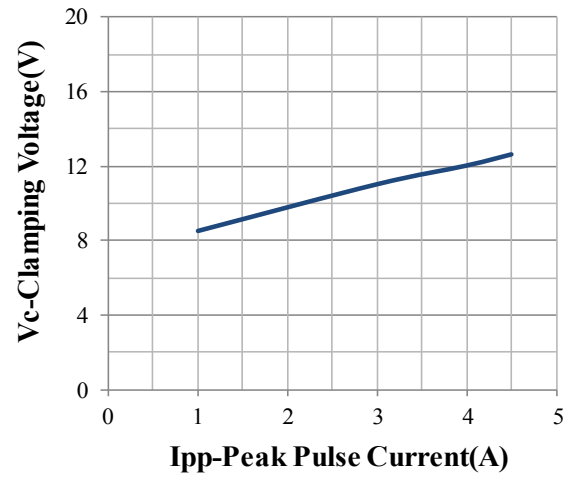

Clamping Voltage vs. Peak Pulse Current

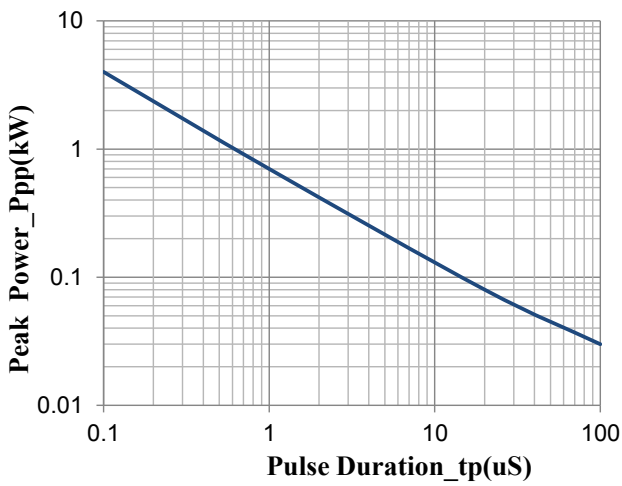

Peak Pulse Power vs. Pulse Time

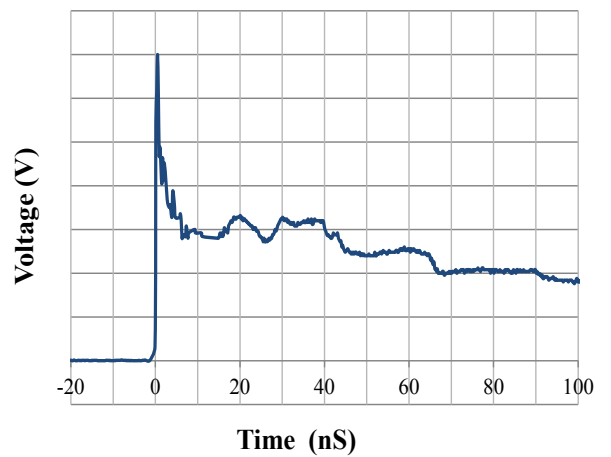

IEC61000-4-2 Pulse Waveform

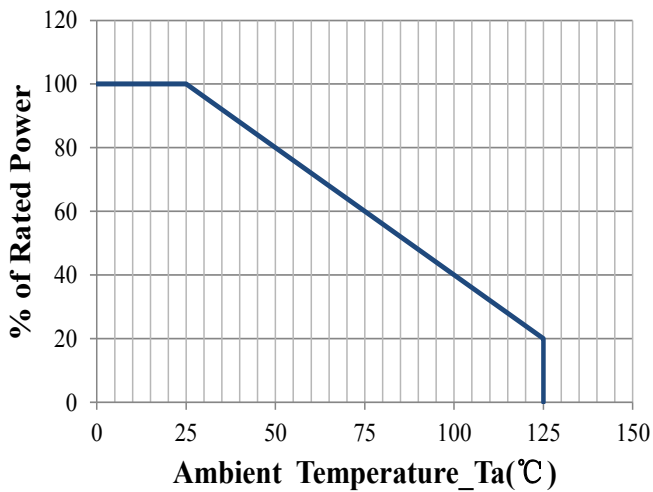

Power Derating Curve

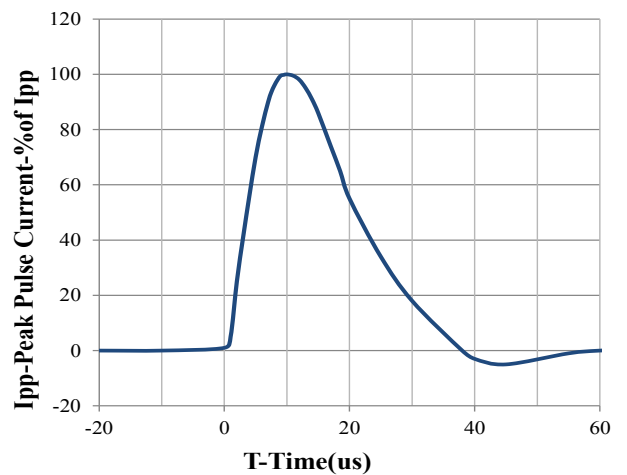

8 X 20us Pulse Waveform



■ Outline Drawing – SOT-23

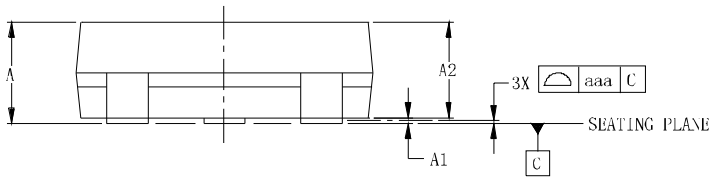
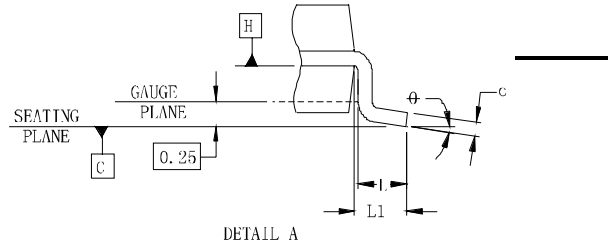
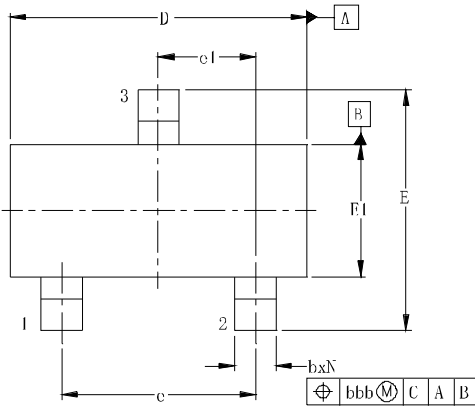

DIM	DIMENSIONS					
	INCHES			MILLIMETERS		
	MTN	NOM	MAX	MTN	NOM	MAX
A	.035	—	.044	0.89	—	1.12
A1	.000	—	.004	0.01	—	0.10
A2	.035	.037	.040	0.88	0.95	1.02
b	.012	—	.020	0.30	—	0.51
c	.003	—	.007	0.08	—	0.18
D	.110	.114	.120	2.80	2.90	3.04
E	.082	.093	.104	2.10	2.37	2.64
E1	.047	.051	.055	1.20	1.30	1.40
e	.075			1.90 BSC		
e1	.037			0.95 BSC		
L	.015	.020	.024	0.40	0.50	0.60
L1	.022			(0.55)		
N	3			3		
θ	0°	—	8°	0°	—	8°
aaa	.001			0.10		
bbb	.008			0.20		

X-ON Electronics

Largest Supplier of Electrical and Electronic Components

Click to view similar products for [ESD Suppressors / TVS Diodes](#) category:

Click to view products by [DOWO](#) manufacturer:

Other Similar products are found below :

[60KS200C](#) [D18V0L1B2LP-7B](#) [D5V0F4U5P5-7](#) [NTE4902](#) [P4KE27CA](#) [P6KE11CA](#) [P6KE8.2A](#) [SA60CA](#) [SA64CA](#) [SMBJ12CATR](#)
[SMBJ33CATR](#) [SMBJ6.5A](#) [SMBJ8.0A](#) [ESD101-B1-02ELS](#) [E6327](#) [ESD112-B1-02EL](#) [E6327](#) [ESD7451N2T5G](#) [19180-510](#) [CPDT-5V0USP-](#)
[HF](#) [3.0SMCJ33CA-F](#) [3.0SMCJ36A-F](#) [HSPC16701B02TP](#) [JANTX1N6126A](#) [D3V3Q1B2DLP3-7](#) [D55V0M1B2WS-7](#) [SCM1293A-04SO](#)
[ESD200-B1-CSP0201](#) [E6327](#) [SM12-7](#) [CEN955](#) [W/DATA](#) [VESD12A1A-HD1-GS08](#) [CPDQC5V0-HF](#) [D1213A-01LP4-7B](#) [ESD101-B1-02EL](#)
[E6327](#) [AOZ8808DI-03](#) [5KP15A](#) [5KP48A](#) [5KP90A](#) [ESD3V3D7-TP](#) [15KPA36A-LF](#) [P4KE56CA](#) [P4KE68A](#) [P4KE91CATR](#) [P6KE120A](#)
[P6KE13CA](#) [P6KE43CA](#) [P6KE6.8CA](#) [P6KE8.2](#) [P6SMBJ20CA](#) [JANTX1N6072A](#) [SR2835ESKG](#) [SA90CA](#)