

## ■ Features

- Low Zener Impedance
- Power Dissipation of 500mW
- High Stability and High Reliability

## ■ Mechanical Data

- package:SOD-123
- Polarity: Color band denotes cathode end
- Flammability rating of epoxy resin: UL 94V-0
- Mounting Position: Any.

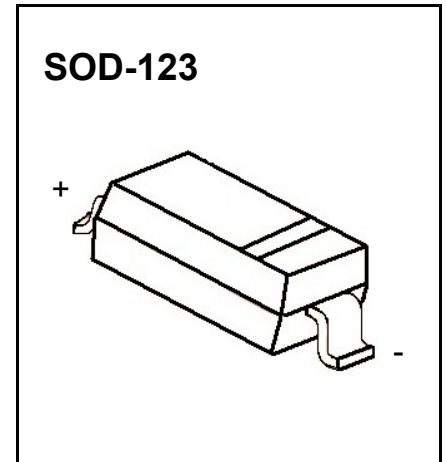

## ■ ORDERING INFORMATION

- Part Number: MMSZ52xxB
- Package: SOD-123
- Quantity per reel: 3,000 pcs
- Packing: Tape & Reel
- Reel Size: 7 inches

## ■ Maximum Ratings & Thermal Characteristics(Ratings at 25°C ambient temperature unless otherwise specified.)

Parameters	Symbol	Value	Unit
Power Dissipation	Pd	500 <sup>1)</sup>	mW
Forward Voltage @IF=10mA	Vf	0.9 <sup>2)</sup>	V
Thermal Resistance, Junction-to-Ambient	R <sub>θJA</sub>	340 <sup>3)</sup>	°C/W
Thermal Resistance, Junction-to-Lead	R <sub>θJL</sub>	150 <sup>3)</sup>	°C/W
Storage temperature range	Ts	-65-+150	°C

- 1) Device mounted on ceramic PCB: 7.6mm x 9.4mm x 0.87mm with pad areas 25mm<sup>2</sup>
- 2) Short duration test pulse used to minimize self-heating effect
- 3) Thermal Resistance measurement obtained via infrared Scan Method.
- 4) f=1KHz

**Electrical Characteristics**(Ratings at 25°C ambient temperature unless otherwise specified)

Type Number	Code	Zener Voltage Range (Note 2)				Maximum Zener Impedance (Note 4)			Maximum Reverse Current	
		$V_Z@I_{ZT}$			$I_{ZT}$	$Z_{ZT}@I_{ZT}$	$Z_{ZK}@I_{ZK}$	$I_{ZK}$	$I_R$	$V_R$
		Nom(V)	M	Max(V)	mA	$\Omega$		mA	$\mu A$	V
MMSZ5221B	C1	2.4	2.28	2.52	20	30	1200	0.25	100	1.0
MMSZ5223B	C3	2.7	2.57	2.84	20	30	1300	0.25	75	1.0
MMSZ5225B	C5	3.0	2.85	3.15	20	30	1600	0.25	50	1.0
MMSZ5226B	G1	3.3	3.14	3.47	20	28	1600	0.25	25	1.0
MMSZ5227B	G2	3.6	3.42	3.78	20	24	1700	0.25	15	1.0
MMSZ5228B	G3	3.9	3.71	4.10	20	23	1900	0.25	10	1.0
MMSZ5229B	G4	4.3	4.09	4.52	20	22	2000	0.25	5	1.0
MMSZ5230B	G5	4.7	4.47	4.94	20	19	1900	0.25	5	2.0
MMSZ5231B	E1	5.1	4.85	5.36	20	17	1600	0.25	5	2.0
MMSZ5232B	E2	5.6	5.32	5.88	20	11	1600	0.25	5	3.0
MMSZ5233B	E3	6.0	5.70	6.30	20	7	1600	0.25	5	3.5
MMSZ5234B	E4	6.2	5.89	6.51	20	7	1000	0.25	5	4.0
MMSZ5235B	E5	6.8	6.46	7.14	20	5	750	0.25	3	5.0
MMSZ5236B	F1	7.5	7.13	7.88	20	6	500	0.25	3	6.0
MMSZ5237B	F2	8.2	7.79	8.61	20	8	500	0.25	3	6.5
MMSZ5238B	F3	8.7	8.27	9.14	20	8	600	0.25	3	6.5
MMSZ5239B	F4	9.1	8.65	9.56	20	10	600	0.25	3	7.0
MMSZ5240B	F5	10	9.50	10.50	20	17	600	0.25	3	8.0
MMSZ5241B	H1	11	10.45	11.55	20	22	600	0.25	2.0	8.4
MMSZ5242B	H2	12	11.40	12.60	20	30	600	0.25	1.0	9.1
MMSZ5243B	H3	13	12.35	13.65	9.5	13	600	0.25	0.5	9.9
MMSZ5244B	H4	14	13.30	14.70	9.0	15	600	0.25	0.1	10
MMSZ5245B	H5	15	14.25	15.75	8.5	16	600	0.25	0.1	11
MMSZ5246B	J1	16	15.20	16.80	7.8	17	600	0.25	0.1	12
MMSZ5248B	J3	18	17.10	18.90	7.0	21	600	0.25	0.1	14
MMSZ5250B	J5	20	19.00	21.00	6.2	25	600	0.25	0.1	15
MMSZ5251B	K1	22	20.90	23.10	5.6	29	600	0.25	0.1	17
MMSZ5252B	K2	24	22.80	25.20	5.2	33	600	0.25	0.1	18
MMSZ5253B	K3	25	23.75	26.25	5.0	35	600	0.25	0.1	19
MMSZ5254B	K4	27	25.65	28.35	5.0	41	600	0.25	0.1	21
MMSZ5255B	K5	28	26.60	29.40	4.5	44	600	0.25	0.1	21
MMSZ5256B	M1	30	28.50	31.50	4.2	49	600	0.25	0.1	23
MMSZ5257B	M2	33	31.35	34.65	3.8	58	700	0.25	0.1	25
MMSZ5258B	M3	36	34.20	37.80	3.4	70	700	0.25	0.1	27
MMSZ5259B	M4	39	37.05	40.95	3.2	80	800	0.25	0.1	30



■ Typical Characteristics

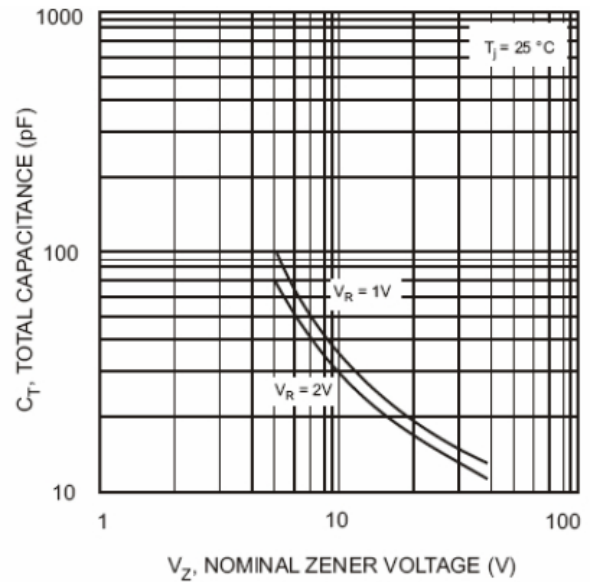
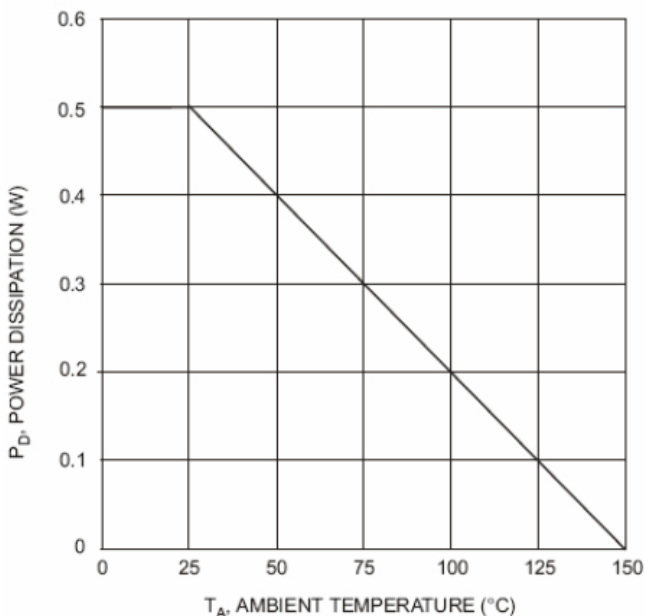
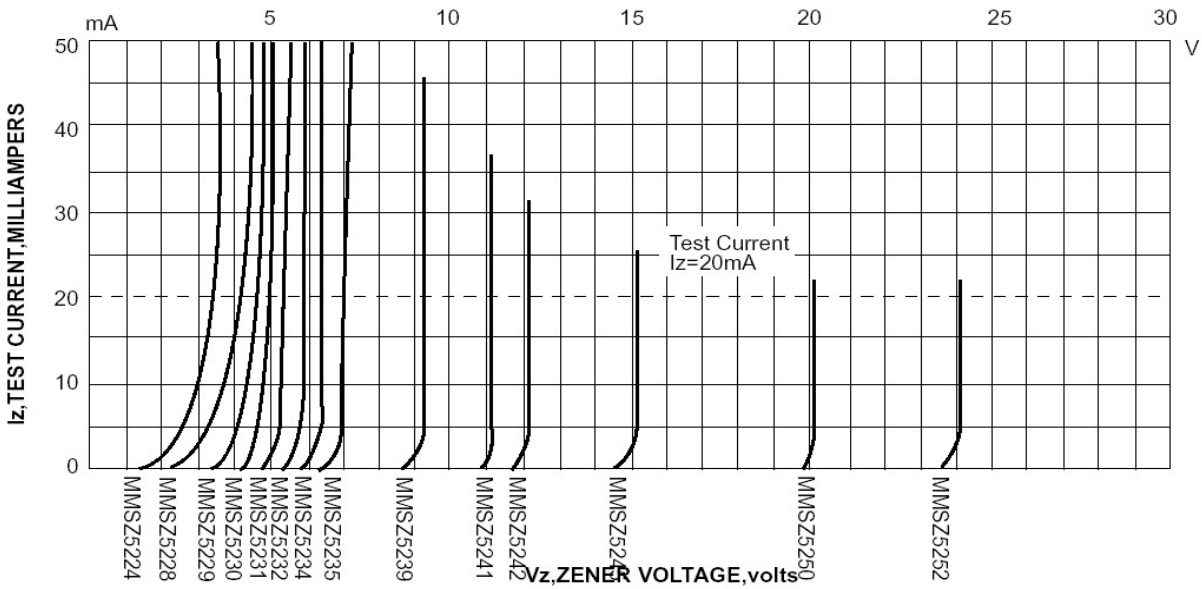

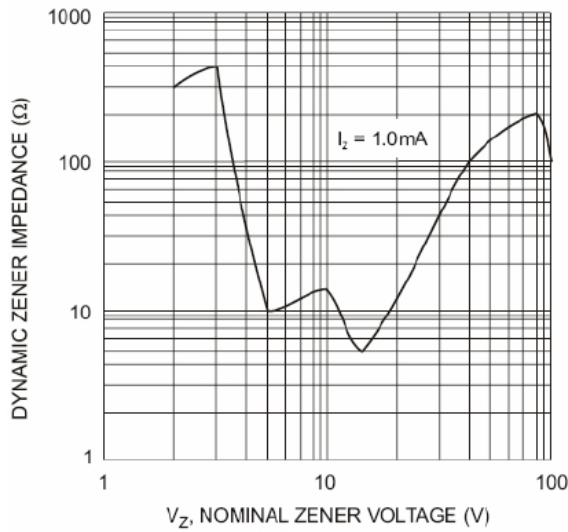

Fig. 3 Zener Voltage vs. Zener Impedance

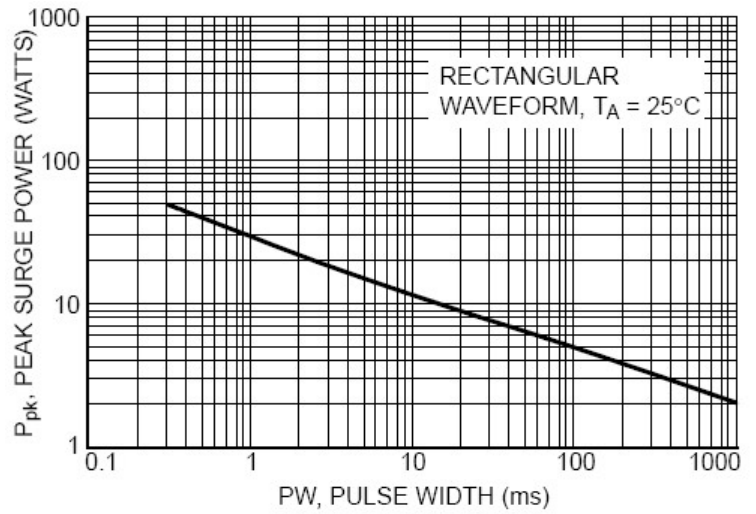
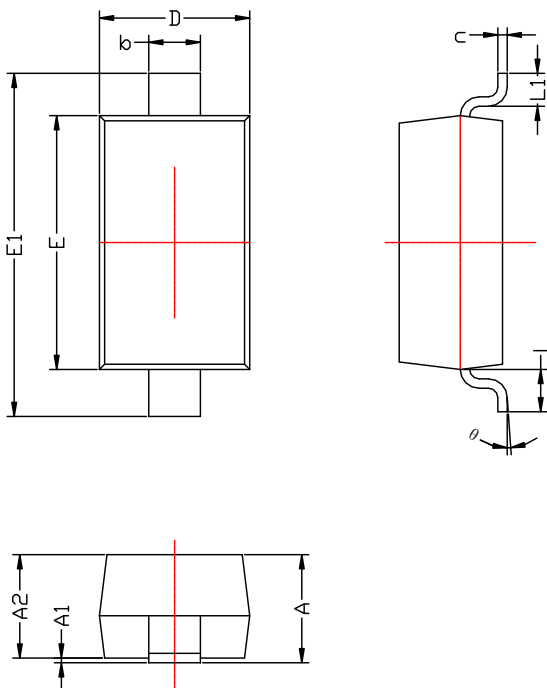

Fig. 4. Maximum Nonrepetitive Surge Power

■ SOD-123 Package Outline Dimensions



Symbol	Dimensions	
	MIN	MAX
A	1.050	1.250
A1	0.000	0.100
A2	1.050	1.150
b	0.450	0.650
c	0.080	0.150
D	1.500	1.700
E	2.600	2.800
E1	3.550	3.850
L	0.500REF	
L1	0.250	0.450
θ	0°	8°

## X-ON Electronics

Largest Supplier of Electrical and Electronic Components

*Click to view similar products for [Zener Diodes](#) category:*

*Click to view products by [DOWO](#) manufacturer:*

Other Similar products are found below :

[RKZ13B2KG#P1](#) [DL5234B](#) [1N4682](#) [1N4693](#) [1N4732A](#) [1N4736A](#) [1N4750A](#) [1N4759ARL](#) [1N5241B](#) [1N5365B](#) [1N5369B](#) [1N747A](#)  
[1N964B](#) [1N966B](#) [1N968B](#) [1N972B](#) [JANS1N4974US](#) [1N4692](#) [1N4702](#) [1N4704](#) [1N4711](#) [1N4714](#) [1N4745ARL](#) [1N4752ARL](#) [1N4760ARL](#)  
[1N5221B](#) [1N5242BTR](#) [1N5350B](#) [1N5352B](#) [1N961BRR1](#) [1N964BRL](#) [RKZ5.1BKU#P6](#) [3SMAJ5946B-TP](#) [3SMAJ5950B-TP](#)  
[MMSZ5230BQ-13-F](#) [MMSZ5232BQ-13-F](#) [BZX84C7V5](#) [3SMAJ5945B-TP](#) [3SMAJ5947B-TP](#) [3SMBJ5941B-TP](#) [DZ2S240M0L](#) [SMAZ27-](#)  
[TP](#) [ZMM5224B-7](#) [RD16UM-T1-A](#) [RD39S-T1-A](#) [RD10S-T1-A](#) [CDZT2R5.6B](#) [1N4762A G](#) [Z1SMA18](#) [JANTX1N4553B](#)