

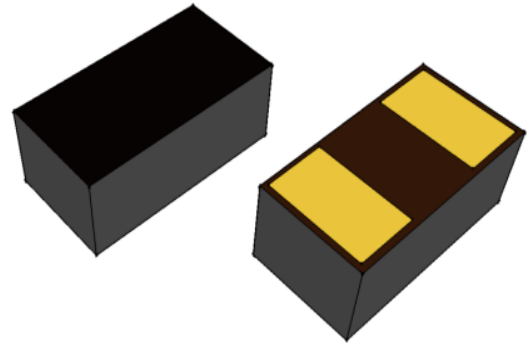

Features

- The best ESD protection for high speed, low voltage applications
- RoHS compliant and halogen free
- Ultra low capacitance, 0.05 pF (typ.)
- Low leakage current (<10nA)
- Fast response time (<1ns)
- Bi-directional, single line protection
- Surface mount



Applications

- Smart Phone/Mobile Internet Device
- Laptop/Desktop Computer
- Antennas
- High Speed Ethernet
- USB 2.0
- Lightning and Thunder Bolt Interface

Mechanical Data

- Surface mount
- RoHS Compliant
- Halogen Free

Schematic & PIN Configuration

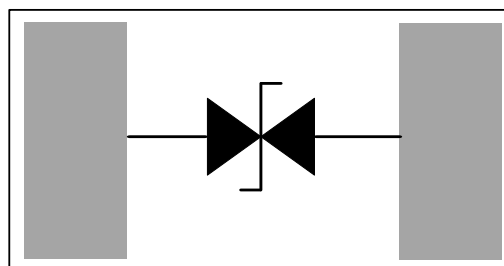



Absolute Maximum Rating

Rating	Symbol	Conditions	Value	Units
ESD per IEC 61000-4-2 (Air) ESD per IEC 61000-4-2 (Contact)	V_{ESD}		15 8	kV
Lead Soldering Temperature	T_L		260(10seconds)	°C
Operating Temperature	T_O		-55 to + 125	°C
Storage Temperature	T_{stg}		-40 to + 125	°C

Electrical Characteristics

Parameter	Symbol	Conditions	Min	Typical	Max	Units
Continuous Operating Voltage	V_{DC}				14	V
Trigger Voltage	V_T	IEC61000-4-2 8KV contact discharge		450		V
Leakage Current	I_L	$V_{DC}=14V, T=25^{\circ}C$			10	nA
Clamping Voltage	V_C	IEC61000-4-2 8KV contact discharge		40		V
Capacitance	C_p	Measured at 10MHz		0.05		pF
ESD Pulse Withstand	Pulses	IEC61000-4-2 8KV contact discharge	1000			



ESD Clamping Test

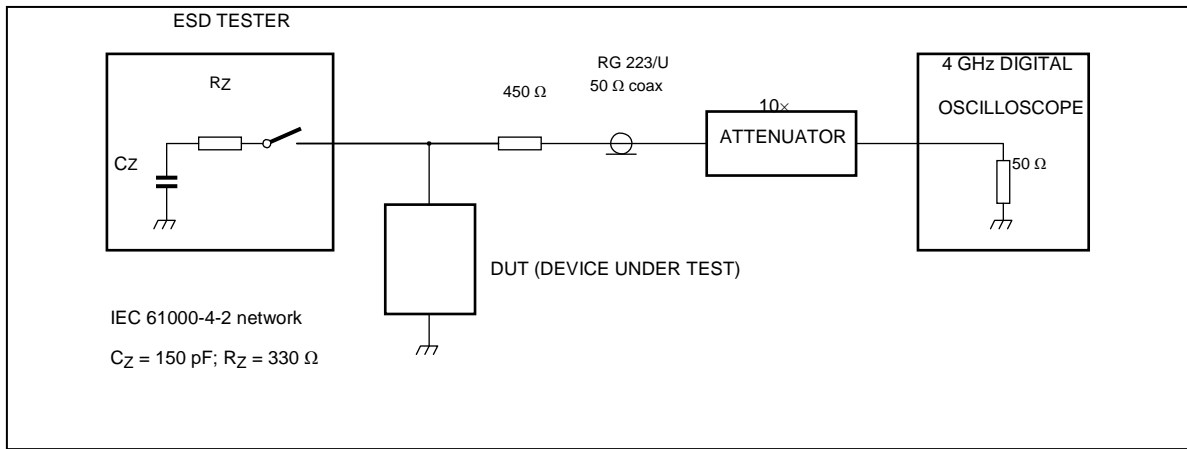

Fig.1 ESD Clamping Test Waveform

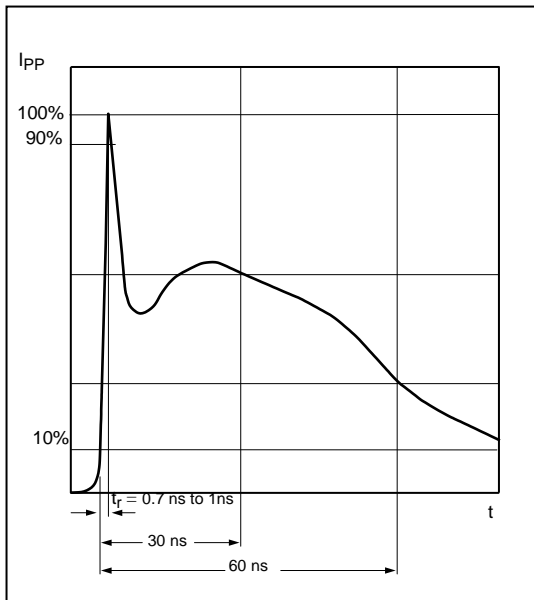

Fig.3 Capacitance VS Frequency

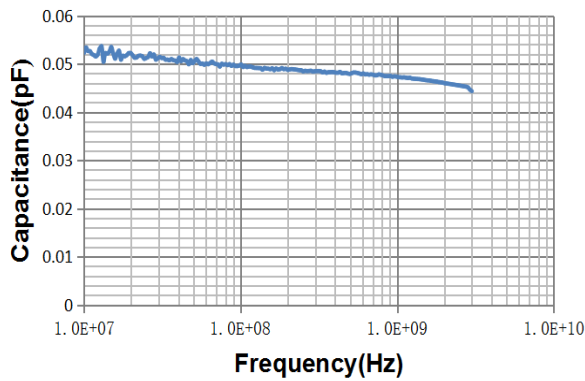
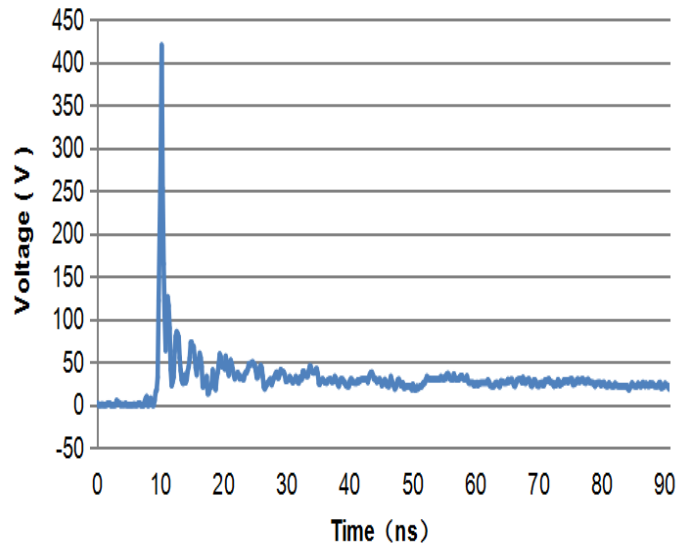
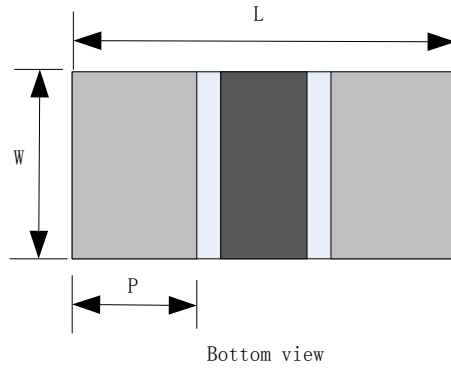

Fig.2 ESD Waveform after Clamping





Outline Drawing



Dimension	Unit: Millimeters		
	Min.	Typ.	Max.
L	0.90	1.00	1.10
W	0.42	0.52	0.62
P	0.15	0.25	0.35
H	0.25	0.38	0.45

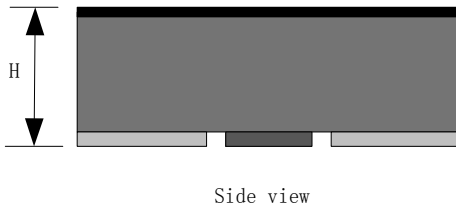

X-ON Electronics

Largest Supplier of Electrical and Electronic Components

Click to view similar products for [ESD Suppressors / TVS Diodes](#) category:

Click to view products by [DOWO](#) manufacturer:

Other Similar products are found below :

[60KS200C](#) [D18V0L1B2LP-7B](#) [D5V0F4U5P5-7](#) [NTE4902](#) [P4KE27CA](#) [P6KE11CA](#) [P6KE8.2A](#) [SA60CA](#) [SA64CA](#) [SMBJ12CATR](#)
[SMBJ33CATR](#) [SMBJ6.5A](#) [SMBJ8.0A](#) [ESD101-B1-02ELS](#) [E6327](#) [ESD112-B1-02EL](#) [E6327](#) [ESD7451N2T5G](#) [19180-510](#) [CPDT-5V0USP-](#)
[HF](#) [3.0SMCJ33CA-F](#) [3.0SMCJ36A-F](#) [HSPC16701B02TP](#) [JANTX1N6126A](#) [D3V3Q1B2DLP3-7](#) [D55V0M1B2WS-7](#) [SCM1293A-04SO](#)
[ESD200-B1-CSP0201](#) [E6327](#) [SM12-7](#) [CEN955](#) [W/DATA](#) [VESD12A1A-HD1-GS08](#) [CPDQC5V0-HF](#) [D1213A-01LP4-7B](#) [ESD101-B1-02EL](#)
[E6327](#) [AOZ8808DI-03](#) [5KP15A](#) [5KP48A](#) [5KP90A](#) [ESD3V3D7-TP](#) [15KPA36A-LF](#) [P4KE56CA](#) [P4KE68A](#) [P4KE91CATR](#) [P6KE120A](#)
[P6KE13CA](#) [P6KE43CA](#) [P6KE6.8CA](#) [P6KE8.2](#) [P6SMBJ20CA](#) [JANTX1N6072A](#) [SR2835ESKG](#) [SA90CA](#)