	
Nominal Voltage	1.45 V
Rated Capacity	100 mAh at 3000 ohm to 1.1 V @ 21°C and 50% RH
Typical Impedance (Fresh)	9.0 ohm @ 1kHz
Typical Weight	0.3 g (0.01 oz)
Volume	0.08 cm ³ (0.005 in ³)
Terminals	Flat
Operating Temperature Range	0°C to 50°C (32°F to 122°F)
Recommended Storage Temperature	5°C to 30°C with 40-80% RH
Shelf Life	4 years unactivated @ 21°C
Designation	ANSI: 7005Z IEC: PR70

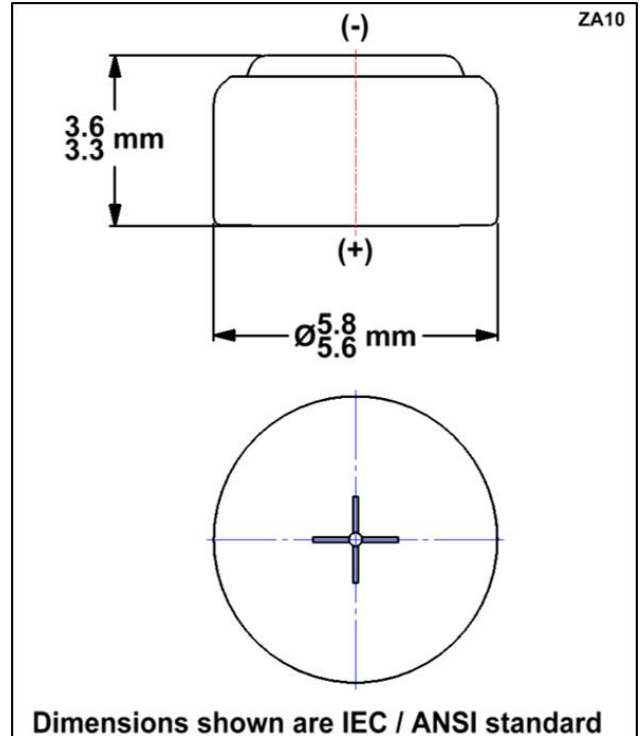

Typical Discharge Characteristics at 21°C (70°F) and 50% RH

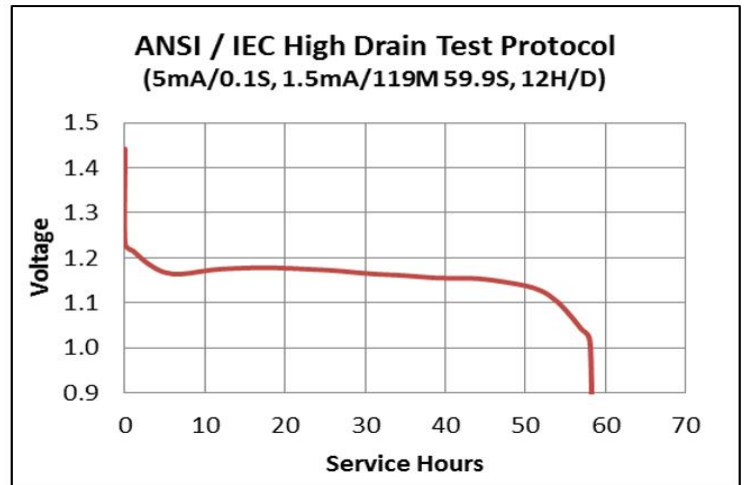
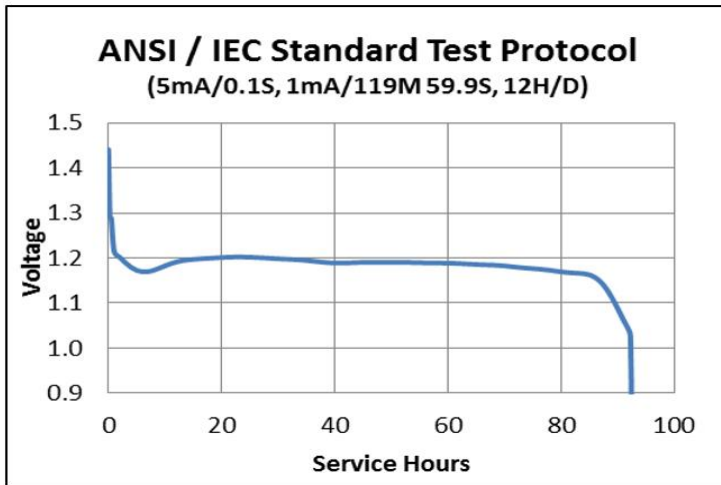

Berkshire Corporate Park
Bethel, CT. 06801 U.S.A.
Telephone: Toll-free 1-800-544-5454
www.duracell.com

Delivered capacity is dependent on the applied load, operating temperature and cut-off voltage. Please refer to the charts and discharge data shown for examples of the energy/service life that the battery will provide for various load conditions.

X-ON Electronics

Largest Supplier of Electrical and Electronic Components

Click to view similar products for [Battery Packs](#) category:

Click to view products by [Duracell](#) manufacturer:

Other Similar products are found below :

[R101-B](#) [4600 726 406](#) [4610 726 406](#) [312G-U1](#) [55615602059](#) [55615703012](#) [55750404014](#) [DL1/3N](#) [4606 726 406](#) [4607 726 406](#) [ZA13](#)
[LR03/AAA/MN2400\(K4\)](#) [LR03 MAXELL S4](#) [LR1130 MAXELL B10](#) [LR14-MN1400-C K2](#) [LR1/910A](#) [LR41 MAXELL B10](#) [LR43](#) [LR43](#)
[MAXELL B10](#) [LR6 MAXELL S4](#) [E23A](#) [E90](#) [55615201501](#) [55750201501](#) [625302](#) [625304](#) [637871](#) [638006](#) [6LF22/9V/MN1604\(K1\)C&B](#)
[6LF22/9V/MN1604 PLUS](#) [6LR61](#) [SR626SW MAXELL](#) [SR920SW MAXELL](#) [7K67 J](#) [55615303059](#) [GP 15AU ULTRA PLUS B4](#) [GP15E](#)
[GP1604GLF-2UE1](#) [GP 1604 ULTRA PLUS](#) [GP 24AU ULTRA PLUS B4](#) [10 ET](#) [675 ET](#) [11A B5](#) [A544](#) [A76-U10](#) [13G U2](#) [7733](#)
[4112101411](#) [4 022 211 111](#) [GP24A/FO2 SUPER](#)