

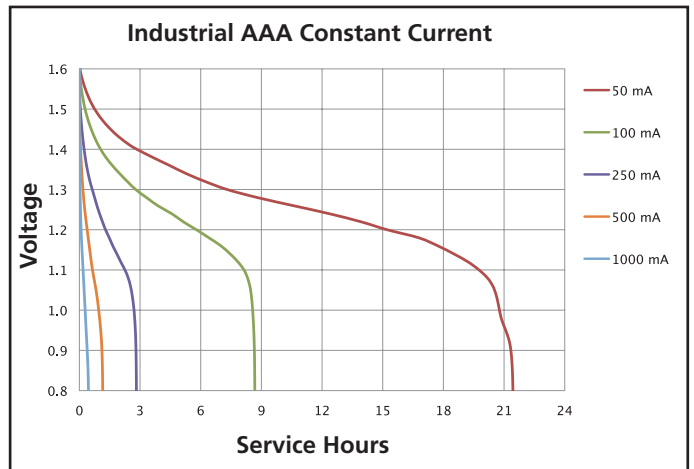

Nominal voltage	1.5 V
Impedance	250 m-ohm @ 1 kHz
Typical weight	11 g (0.4 oz)
Typical volume	3.5 cm ³ (0.2 in ³)
Terminals	Flat
Storage temperature range	5°C to 30°C (41°F to 86°F)
Operating temperature range	-20°C to 54°C (-4°F to 130°F)
Designation	IEC: LR03

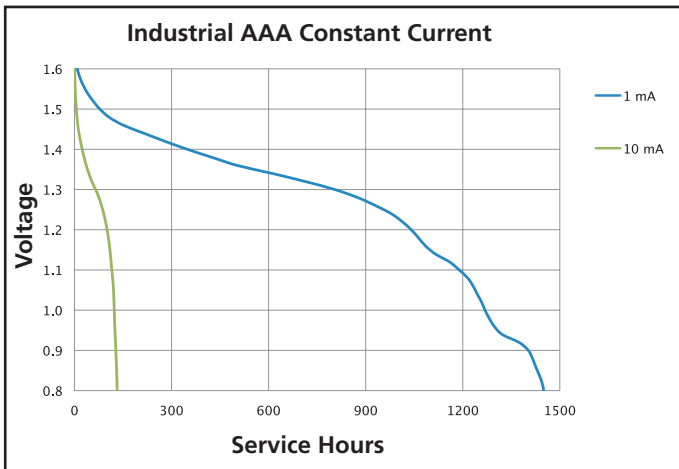

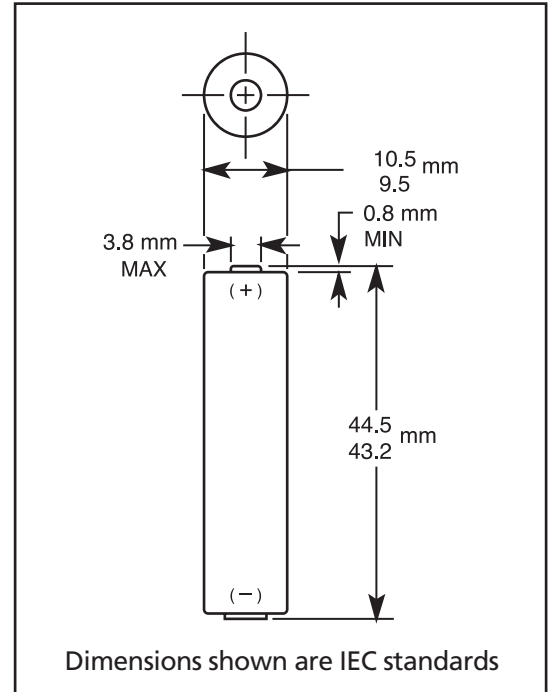
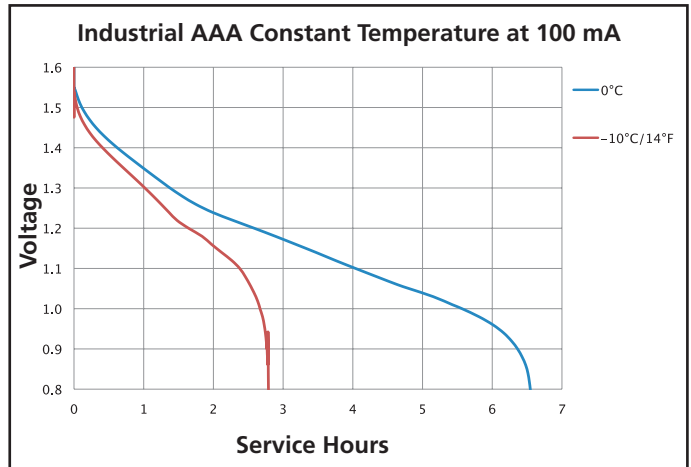
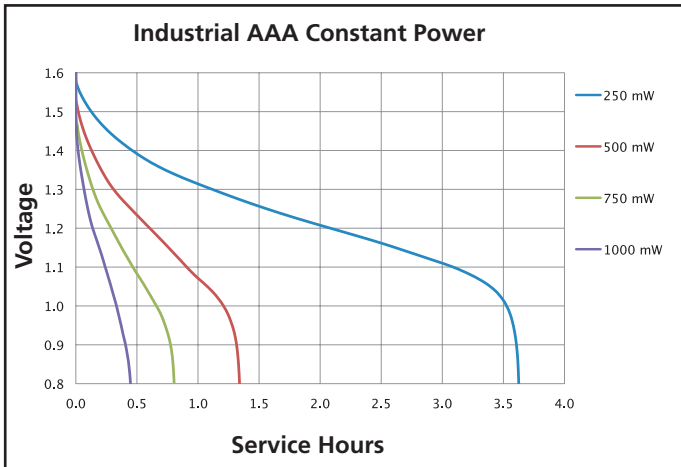
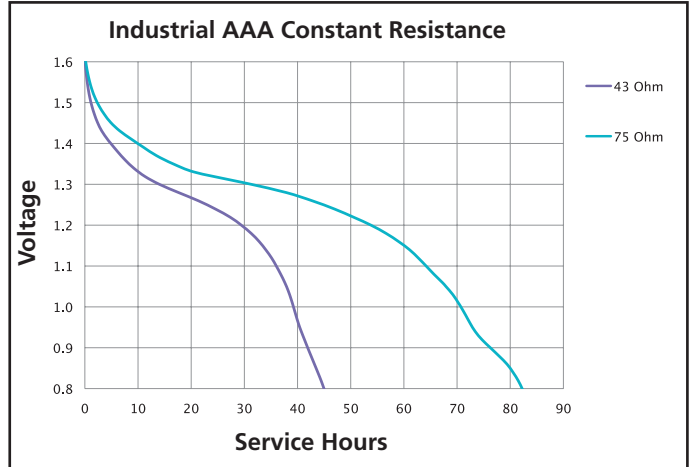
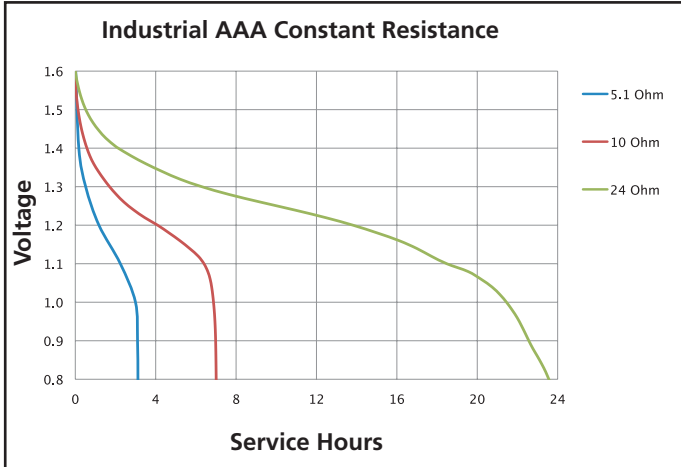

X-ON Electronics

Largest Supplier of Electrical and Electronic Components

Click to view similar products for [Duracell](#) manufacturer:

Other Similar products are found below :

[MS76B](#) [PC134A](#) [CEF27 2XAA 2XAAA](#) [DRN5923](#) [CEF14 2XAA 2XAAA](#) [DRC6104](#) [PX32AB](#) [DRC6101](#) [DRC6105](#) [DRF5982](#) [DRG5945](#)
[DRN5926](#) [DRP5962](#) [DRS5964](#) [DRC6103](#) [DRP5952](#) [DRP5960](#) [DRP5954](#) [5000394002852](#) [DRN6112](#) [DRO5941](#) [675 ET](#) [DRN5921](#)
[DRC5908](#) [364 D364 V364 SR60](#) [DRG5946](#) [DRS6120](#) [10 ET](#) [DRO5940](#) [DRN6113](#) [DRC5901](#) [DRN5930](#) [DRN5924](#) [DRC5911](#) [DRP5958](#)
[DRP5953](#) [DRS5963](#) [DRO5942](#) [ACCU-R3/750/DR](#) [DURACELL AA 1300MAH BLISTER B4](#) [DRF5983](#) [392](#) [DRO5943](#) [DRS5965](#)
[LR3/AAA/MN2400\(K4\) PLUS POWER](#) [DRS5962](#) [7K67 J](#) [13 ET](#) [DRS5960](#) [DRC5905](#)