

# DURACELL®

DURALOCK  
POWER PRESERVE™



## PLUS POWER

# MN1300

## Size: D (LR20)

Alkaline-Manganese Dioxide Battery

Zn/MnO<sub>2</sub>

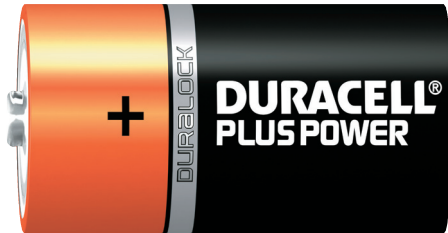

Nominal voltage	1.5 V
Impedance	136 m-ohm @ 1 kHz
Typical weight	139 g (4.9 oz)
Typical volume	56.4 cm <sup>3</sup> (3.4 in <sup>3</sup> )
Terminals	Flat
Storage temperature range	5°C to 30°C (41°F to 86°F)
Operating temperature range	-20°C to 54°C (-4°F to 130°F)
Designation	IEC: LR20

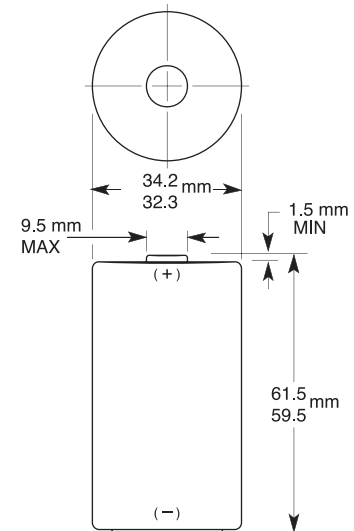

Dimensions shown are IEC standards

Plus Power D Constant Current

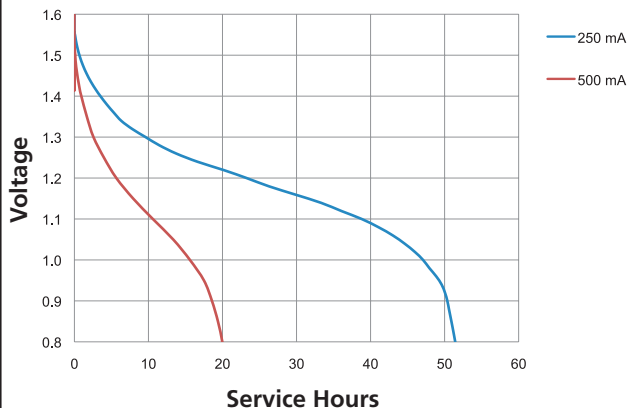

Plus Power D Constant Current

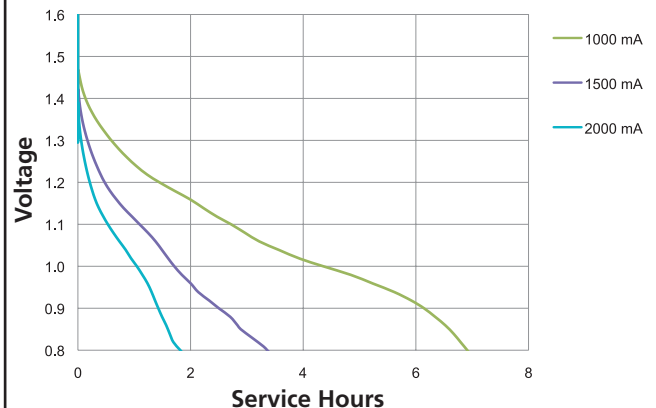

# DURACELL®

BATTERIES

Berkshire Corporate Park  
Bethel, CT. 06801 U.S.A.  
Telephone: Toll-free 1-800-544-5454  
www.duracell.com

Delivered capacity is dependent on the applied load, operating temperature and cut-off voltage. Please refer to the charts and discharge data shown for examples of the energy/service life that the battery will provide for various load conditions.

# DURACELL®



## PLUS POWER

# MN1300 Size: D (LR20)

Alkaline-Manganese Dioxide Battery

Zn/MnO<sub>2</sub>

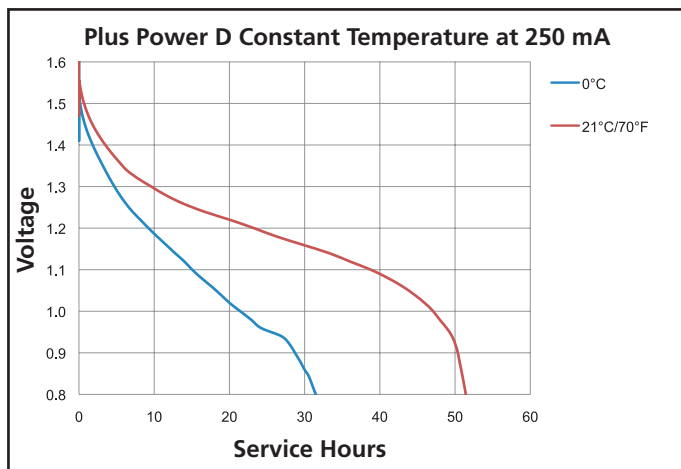
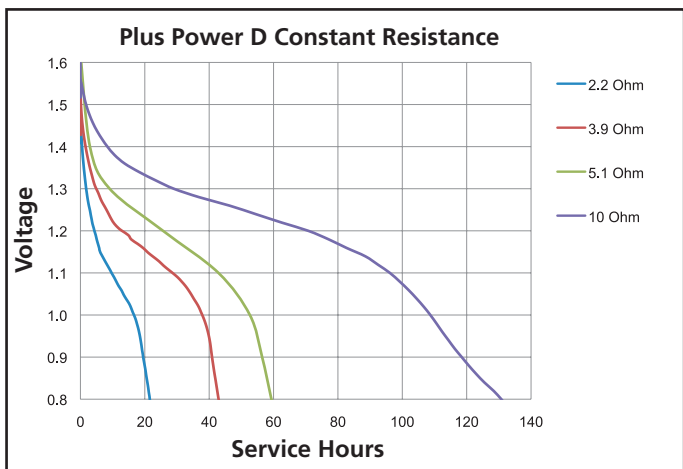
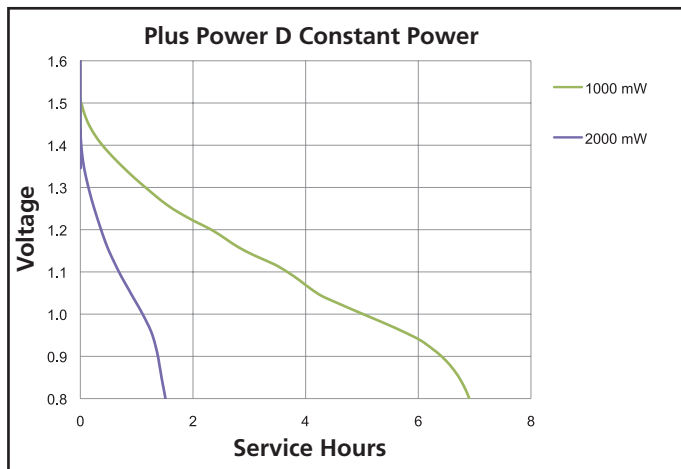
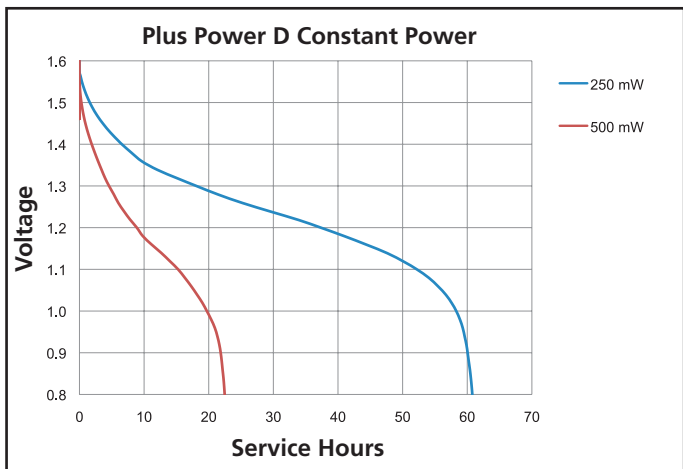

# DURACELL®

BATTERIES

Berkshire Corporate Park  
Bethel, CT. 06801 U.S.A.  
Telephone: Toll-free 1-800-544-5454  
www.duracell.com

Delivered capacity is dependent on the applied load, operating temperature and cut-off voltage. Please refer to the charts and discharge data shown for examples of the energy/service life that the battery will provide for various load conditions.

## X-ON Electronics

Largest Supplier of Electrical and Electronic Components

*Click to view similar products for [Battery Packs](#) category:*

*Click to view products by [Duracell](#) manufacturer:*

Other Similar products are found below :

[2280309-1](#) [R101-B](#) [4114 210 501](#) [4120 210 501](#) [4600 726 406](#) [4610 726 406](#) [312G-U1](#) [55615703012](#) [3LR12](#) [4103 210 392](#) [4103 210 394](#)  
[4106 210 392](#) [4106 210 394](#) [4223 210 501](#) [4606 726 406](#) [4607 726 406](#) [ZA13](#) [LR03/AAA/MN2400\(K4\)](#) [LR03 MAXELL S4](#) [LR1130](#)  
[MAXELL B10](#) [LR14-MN1400-C K2](#) [LR1/910A](#) [LR41 MAXELL B10](#) [LR43](#) [LR43 MAXELL B10](#) [LR6 MAXELL S4](#) [11012](#) [E23A](#) [E90](#)  
[625302](#) [625304](#) [637871](#) [638006](#) [6LF22/9V/MN1604\(K1\)C&B](#) [6LF22/9V/MN1604 PLUS](#) [6LR61](#) [SR626SW MAXELL](#) [SR920SW](#)  
[MAXELL](#) [7K67 J](#) [55615303059](#) [GP14A S2](#) [GP15E](#) [GP1604GLF-2UE1](#) [GP 1604 ULTRA PLUS](#) [23733](#) [10 ET](#) [675 ET](#) [11A B5](#) [A544](#) [A76-](#)  
[U10](#)