

DURACELL®

DURALOCK
POWER PRESERVE™



PLUS POWER

MN2400

Size: AAA (LR03)

Alkaline-Manganese Dioxide Battery

Zn/MnO₂



Nominal voltage	1.5 V
Impedance	250 m-ohm @ 1 kHz
Typical weight	11 g (0.4 oz)
Typical volume	3.5 cm ³ (0.2 in ³)
Terminals	Flat
Storage temperature range	5°C to 30°C (41°F to 86°F)
Operating temperature range	-20°C to 54°C (-4°F to 130°F)
Designation	IEC: LR03

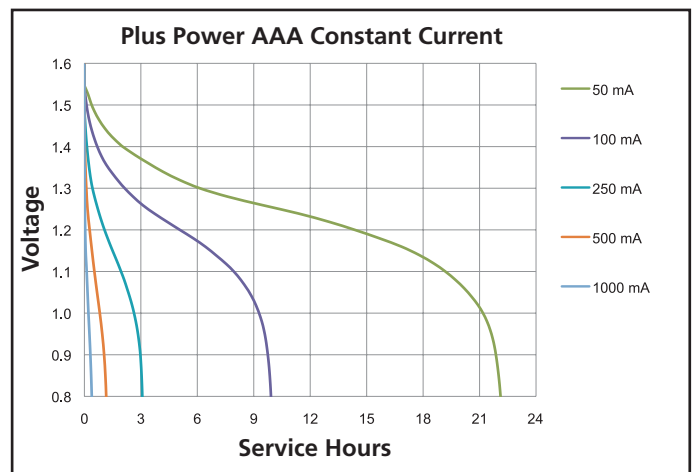
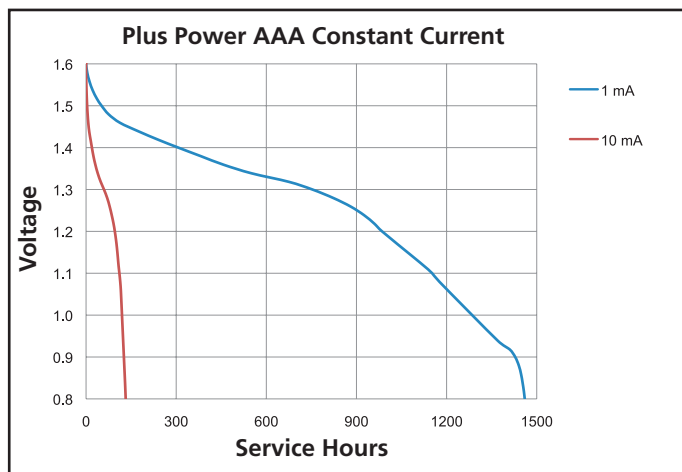
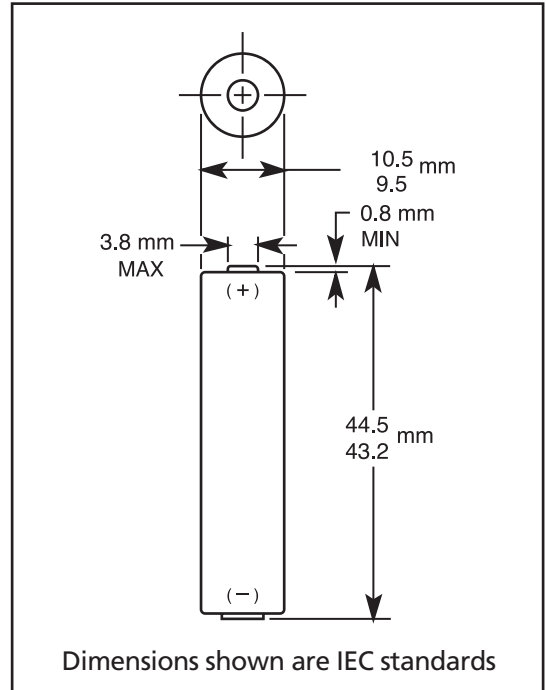

DURACELL®

BATTERIES

Berkshire Corporate Park
Bethel, CT. 06801 U.S.A.
Telephone: Toll-free 1-800-544-5454
www.duracell.com

Delivered capacity is dependent on the applied load, operating temperature and cut-off voltage. Please refer to the charts and discharge data shown for examples of the energy/service life that the battery will provide for various load conditions.

DURACELL®

DURALOCK
POWER PRESERVE™



PLUS POWER

MN2400

Size: AAA (LR03)

Alkaline-Manganese Dioxide Battery

Zn/MnO₂

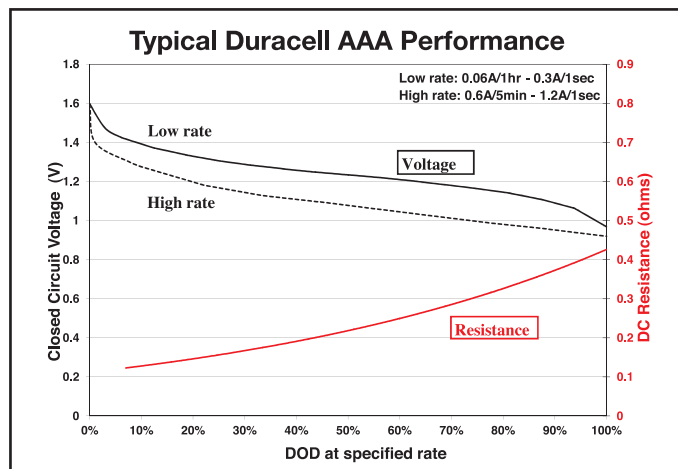
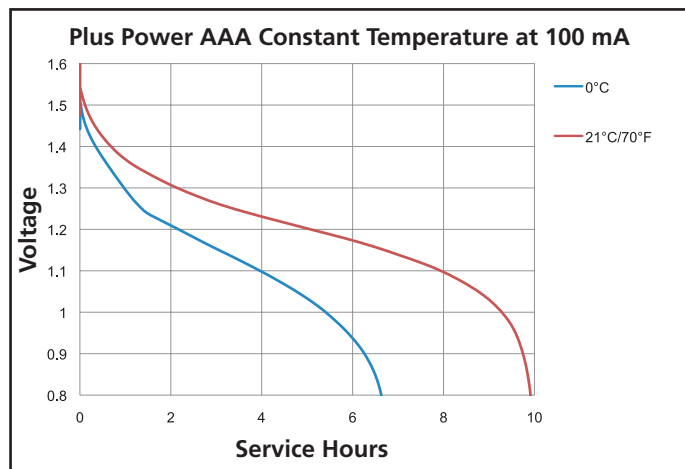
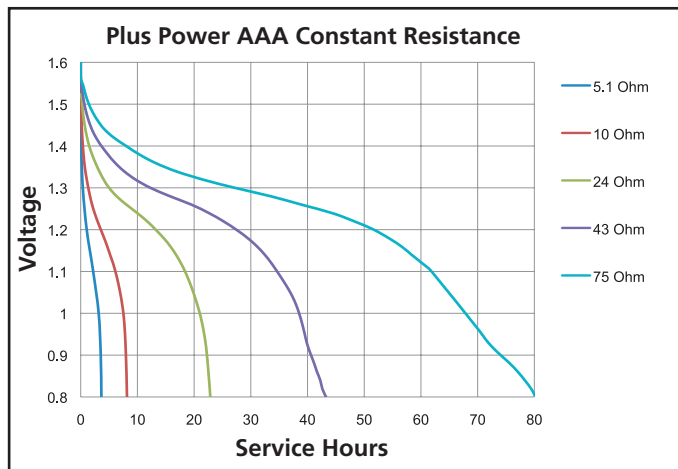
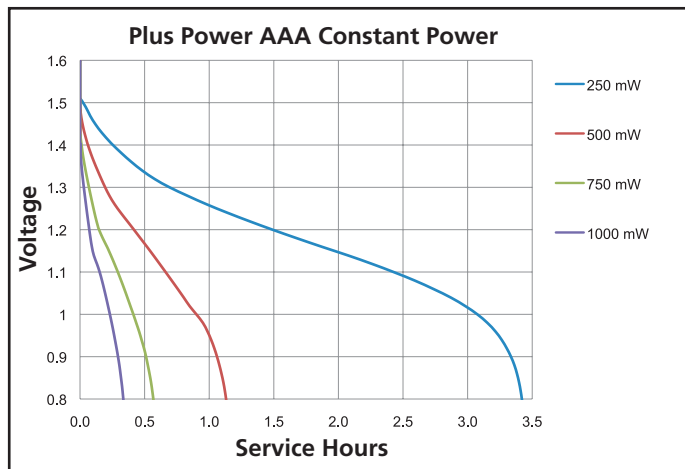

DURACELL®

BATTERIES

Berkshire Corporate Park
Bethel, CT. 06801 U.S.A.
Telephone: Toll-free 1-800-544-5454
www.duracell.com

Delivered capacity is dependent on the applied load, operating temperature and cut-off voltage. Please refer to the charts and discharge data shown for examples of the energy/service life that the battery will provide for various load conditions.

X-ON Electronics

Largest Supplier of Electrical and Electronic Components

Click to view similar products for [Battery Packs](#) category:

Click to view products by [Duracell](#) manufacturer:

Other Similar products are found below :

[2280309-1](#) [R101-B](#) [4114 210 501](#) [4120 210 501](#) [4600 726 406](#) [4610 726 406](#) [312G-U1](#) [55615703012](#) [3LR12](#) [4103 210 392](#) [4103 210 394](#)
[4106 210 392](#) [4106 210 394](#) [4223 210 501](#) [4606 726 406](#) [4607 726 406](#) [ZA13](#) [LR03/AAA/MN2400\(K4\)](#) [LR03 MAXELL S4](#) [LR1130](#)
[MAXELL B10](#) [LR14-MN1400-C K2](#) [LR1/910A](#) [LR41 MAXELL B10](#) [LR43](#) [LR43 MAXELL B10](#) [LR6 MAXELL S4](#) [11012](#) [E23A](#) [E90](#)
[625302](#) [625304](#) [637871](#) [638006](#) [6LF22/9V/MN1604\(K1\)C&B](#) [6LF22/9V/MN1604 PLUS](#) [6LR61](#) [SR626SW MAXELL](#) [SR920SW](#)
[MAXELL](#) [7K67 J](#) [55615303059](#) [GP14A S2](#) [GP15E](#) [GP1604GLF-2UE1](#) [GP 1604 ULTRA PLUS](#) [23733](#) [10 ET](#) [675 ET](#) [11A B5](#) [A544](#) [A76-](#)
[U10](#)