

# DURACELL®



## COPPERTOP

# MN1300

## Size: D (LR20)

### Alkaline-Manganese Dioxide Battery

Zn/MnO<sub>2</sub>



Nominal voltage	1.5 V
Impedance	136 m-ohm @ 1 kHz
Typical weight	139 g (4.9 oz)
Typical volume	56.4 cm <sup>3</sup> (3.4 in <sup>3</sup> )
Terminals	Flat
Storage temperature range	5°C to 30°C (41°F to 86°F)
Operating temperature range	-20°C to 54°C (-4°F to 130°F)
Designation	ANSI: 13A IEC: LR20

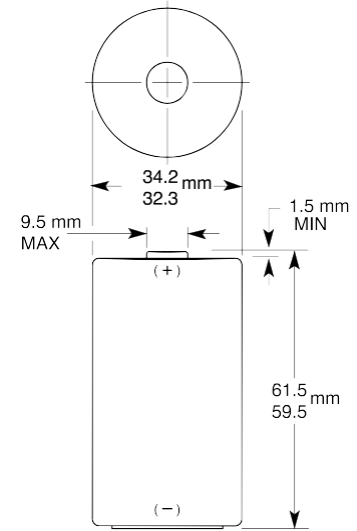

Dimensions shown are IEC standards

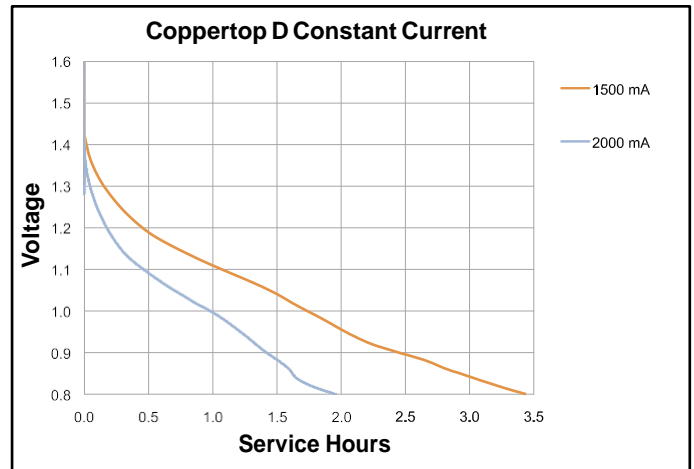
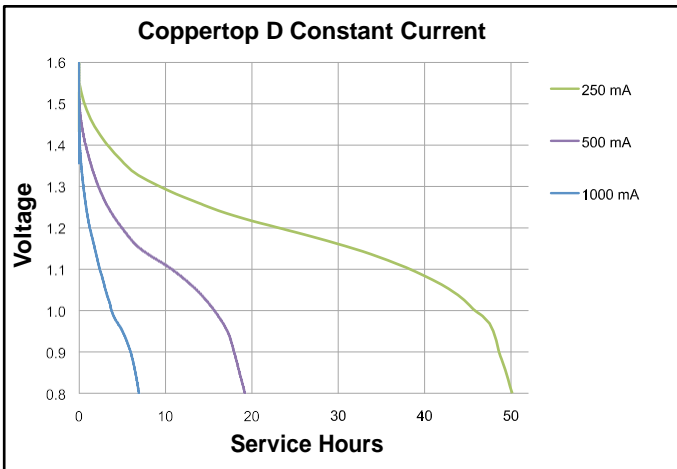

# DURACELL®

BATTERIES

Berkshire Corporate Park  
Bethel, CT. 06801 U.S.A.  
Telephone: Toll-free 1-800-544-5454  
www.duracell.com

Delivered capacity is dependent on the applied load, operating temperature and cut-off voltage. Please refer to the charts and discharge data shown for examples of the energy/service life that the battery will provide for various load conditions.

# DURACELL®



## COPPERTOP

# MN1300

## Size: D (LR20)

### Alkaline-Manganese Dioxide Battery

Zn/MnO<sub>2</sub>

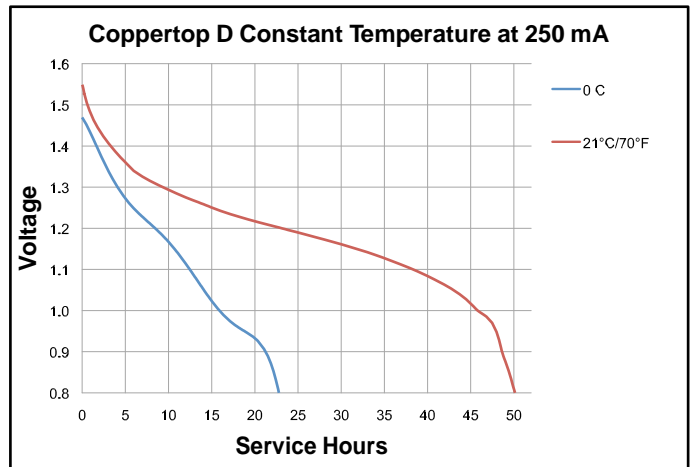
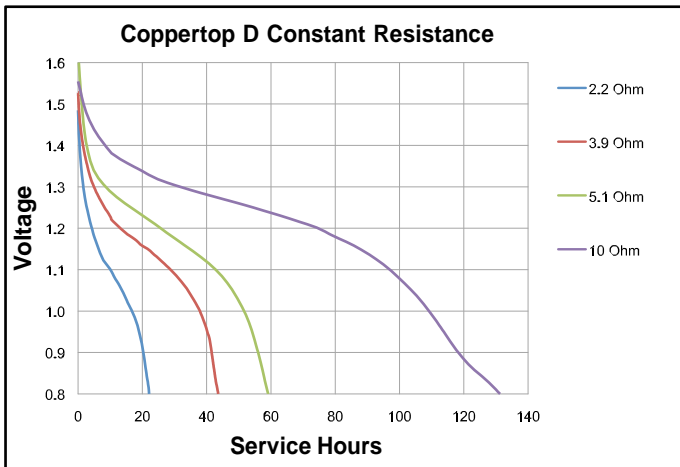
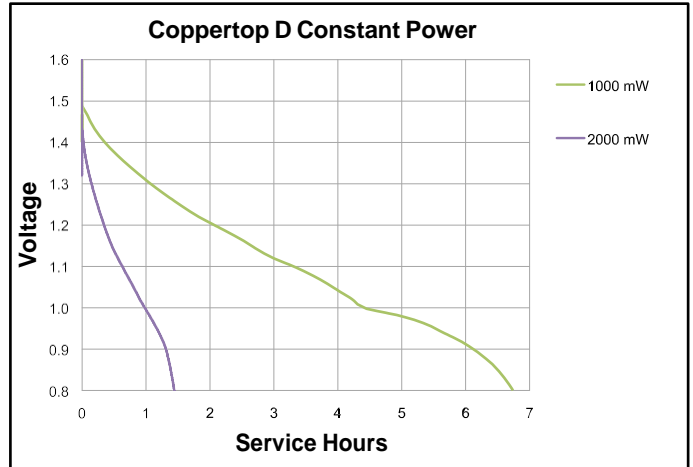
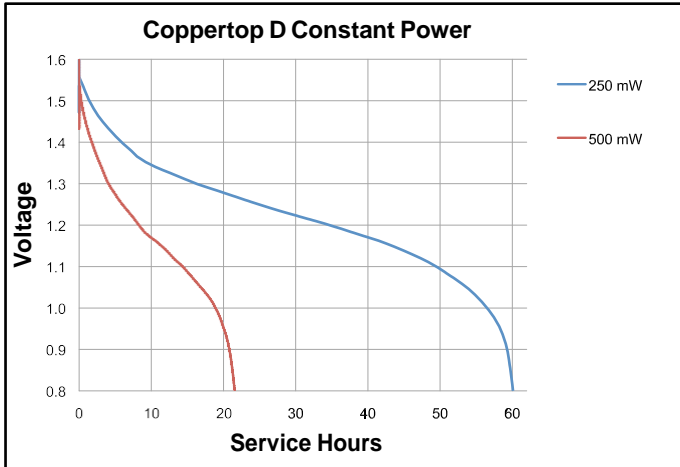

# DURACELL®

BATTERIES

Berkshire Corporate Park  
Bethel, CT. 06801 U.S.A.  
Telephone: Toll-free 1-800-544-5454  
www.duracell.com

Delivered capacity is dependent on the applied load, operating temperature and cut-off voltage. Please refer to the charts and discharge data shown for examples of the energy/service life that the battery will provide for various load conditions.

## **X-ON Electronics**

Largest Supplier of Electrical and Electronic Components

*Click to view similar products for [Duracell](#) manufacturer:*

Other Similar products are found below :

[DL1620B](#) [MS76B](#) [DA146](#) [MN2400B4](#) [15035031 M3 C 2PK](#) [5000394203822](#) [CEF27 2XAA 2XAAA](#) [DL223AB](#) [75044300](#) [PC1400](#)  
[MN2400](#) [LR43](#) [PC134A](#) [CEF14 2XAA 2XAAA](#) [ACCU 9V1](#) [DRC5908](#) [5000394002883](#) [MN1604](#) [DRN5924](#) [PC1604](#) [DRS5964](#)  
[5000394019126](#) [DRO5940](#) [DRC5907](#) [DRP5953](#) [15035025 M3 PP3](#) [DRC5904](#) [DRG5945](#) [DRC5900](#) [DRP6116](#) [5000394105522](#) [DRN5920](#)  
[ACCU D2](#) [5000394020092](#) [DRG5944](#) [DRC5909](#) [DRP5954](#) [DRP5958](#) [DRACUSB3-EU](#) [DRP5952](#) [DRF5982](#) [5000394004030](#) [BUN0127A](#)  
[DRN5926](#) [PC1500](#) [5000394018549](#) [USB5023A](#) [395](#) [LR54](#) [189 V10GA](#) [LR1130](#) [DRC5901](#)