

# Series 14

## Characteristics

The compact 22.5 mm Series 14 enables space-saving installations and is especially suited for:

- Flush design
- Raised design
- PCB (with adaptor)

The low level switching element is laid out for low current applications.

## Functions

The Series 14 incorporates the following functions:

- Indicator
- Pushbutton
- Illuminated pushbutton
- Mushroom-head pushbutton
- Keylock switch
- Selector switch
- Buzzer

## Market segments

The EAO Series 14 is especially suited for applications in the segments:

- Public transportation
- Machinery and Automation
- Construction machines and special-purpose vehicles
- Lifting and moving
- Panel building

Please refer to the EAO website to obtain detailed information regarding this series [www.products.eao.com](http://www.products.eao.com)  
Configure a product to your exact needs and request a quotation.





**Overview****Flush design**

Indicator	4
Buzzer	10
Pushbutton	11
Illuminated pushbutton	14
Mushroom-head pushbutton	28
Keylock switch	33
Selector switch	38

**Raised design**

Indicator	43
Buzzer	52
Pushbutton	53
Illuminated pushbutton	56
Mushroom-head pushbutton	70
Keylock switch	77
Selector switch	80

**Accessories** 83**Drawings** 110**Technical data** 11**Marking** 115**Application guidelines** 118**Index** 119

# 14 Flush design

## Indicator complete, IP67



Product can differ from the current configuration.

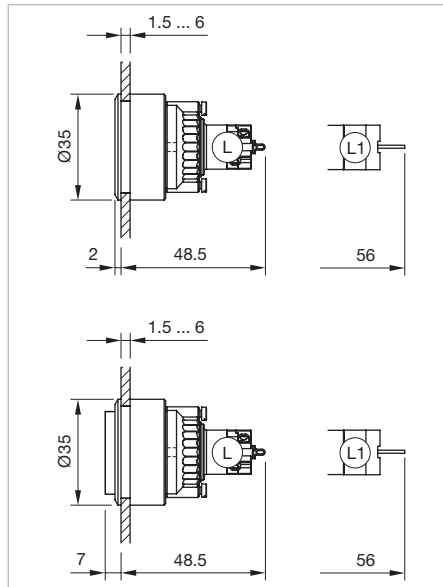

Dimensions [mm]  
 L = Solder terminal,  
 L1 = Solder/Plug-in terminal 2.8 x 0.8 mm

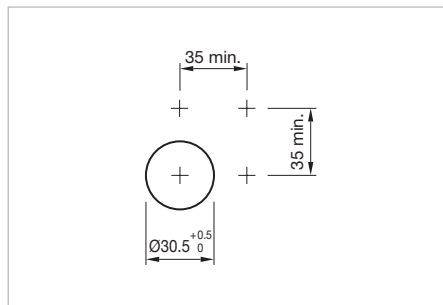





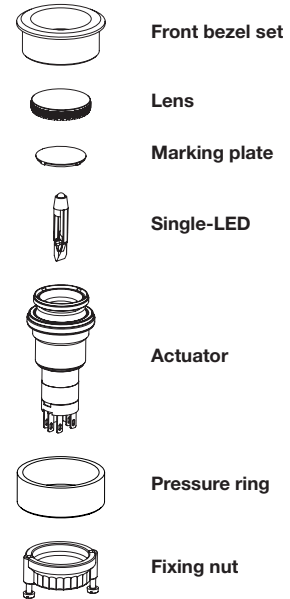







Mounting cut-outs [mm]

### Equipment consisting of (schematic overview)





















Each Part Number listed below includes all the black components shown in the 3D-drawing.

LED colour	Operating voltage	Lens profile	Lens colour	Terminal	Part No.	Wiring diagram	Weight
	<b>Indicator, Front dimension Ø 35 mm</b>						
red	24 VAC/DC	flush	red	Solder/Plug-in 2.8 x 0.8 mm	<b>K14-040.210101</b>	1	0.031 kg
	<b>Indicator, Front dimension Ø 35 mm</b>						
red	24 VAC/DC	raised	red	Solder/Plug-in 2.8 x 0.8 mm	<b>K14-040.210051</b>	1	0.031 kg
	<b>Indicator, Front dimension Ø 35 mm</b>						
yellow	24 VAC/DC	flush	yellow	Solder/Plug-in 2.8 x 0.8 mm	<b>K14-040.210071</b>	1	0.031 kg









LED colour	Operating voltage	Lens profile	Lens colour	Terminal	Part No.	Wiring diagram	Weight
	<b>Indicator, Front dimension Ø 35 mm</b>						
yellow	24 VAC/DC	raised	yellow	Solder/Plug-in 2.8 x 0.8 mm	<b>K14-040.210021</b>	1	0.031 kg
	<b>Indicator, Front dimension Ø 35 mm</b>						
green	24 VAC/DC	flush	green	Solder/Plug-in 2.8 x 0.8 mm	<b>K14-040.210081</b>	1	0.031 kg
	<b>Indicator, Front dimension Ø 35 mm</b>						
green	24 VAC/DC	raised	green	Solder/Plug-in 2.8 x 0.8 mm	<b>K14-040.210031</b>	1	0.031 kg
	<b>Indicator, Front dimension Ø 35 mm</b>						
blue	24 VAC/DC	flush	blue	Solder/Plug-in 2.8 x 0.8 mm	<b>K14-040.210061</b>	1	0.031 kg
	<b>Indicator, Front dimension Ø 35 mm</b>						
blue	24 VAC/DC	raised	blue	Solder/Plug-in 2.8 x 0.8 mm	<b>K14-040.210011</b>	1	0.031 kg
	<b>Indicator, Front dimension Ø 35 mm</b>						
clear	24 VAC/DC	flush	clear	Solder/Plug-in 2.8 x 0.8 mm	<b>K14-040.210091</b>	1	0.031 kg
	<b>Indicator, Front dimension Ø 35 mm</b>						
clear	24 VAC/DC	raised	clear	Solder/Plug-in 2.8 x 0.8 mm	<b>K14-040.210041</b>	1	0.031 kg
	<b>Indicator, Front dimension Ø 35 mm</b>						
red	28 VAC/DC	flush	red	Solder/Plug-in 2.8 x 0.8 mm	<b>K14-040.210102</b>	1	0.031 kg
	<b>Indicator, Front dimension Ø 35 mm</b>						
red	28 VAC/DC	raised	red	Solder/Plug-in 2.8 x 0.8 mm	<b>K14-040.210052</b>	1	0.031 kg
	<b>Indicator, Front dimension Ø 35 mm</b>						
yellow	28 VAC/DC	flush	yellow	Solder/Plug-in 2.8 x 0.8 mm	<b>K14-040.210072</b>	1	0.031 kg

# 14 Flush design

LED colour	Operating voltage	Lens profile	Lens colour	Terminal	Part No.	Wiring diagram	Weight
	<b>Indicator, Front dimension Ø 35 mm</b>						
yellow	28 VAC/DC	raised	yellow	Solder/Plug-in 2.8 x 0.8 mm	<b>K14-040.210022</b>	1	0.031 kg
	<b>Indicator, Front dimension Ø 35 mm</b>						
green	28 VAC/DC	flush	green	Solder/Plug-in 2.8 x 0.8 mm	<b>K14-040.210082</b>	1	0.031 kg
	<b>Indicator, Front dimension Ø 35 mm</b>						
green	28 VAC/DC	raised	green	Solder/Plug-in 2.8 x 0.8 mm	<b>K14-040.210032</b>	1	0.031 kg
	<b>Indicator, Front dimension Ø 35 mm</b>						
blue	28 VAC/DC	flush	blue	Solder/Plug-in 2.8 x 0.8 mm	<b>K14-040.210062</b>	1	0.031 kg
	<b>Indicator, Front dimension Ø 35 mm</b>						
blue	28 VAC/DC	raised	blue	Solder/Plug-in 2.8 x 0.8 mm	<b>K14-040.210012</b>	1	0.031 kg
	<b>Indicator, Front dimension Ø 35 mm</b>						
clear	28 VAC/DC	flush	clear	Solder/Plug-in 2.8 x 0.8 mm	<b>K14-040.210092</b>	1	0.031 kg
	<b>Indicator, Front dimension Ø 35 mm</b>						
clear	28 VAC/DC	raised	clear	Solder/Plug-in 2.8 x 0.8 mm	<b>K14-040.210042</b>	1	0.031 kg
	<b>Indicator, Front dimension Ø 35 mm</b>						
red	24 VAC/DC	flush	red	Soldering terminal	<b>K14-040.220101</b>	2	0.031 kg
	<b>Indicator, Front dimension Ø 35 mm</b>						
red	24 VAC/DC	raised	red	Soldering terminal	<b>K14-040.220051</b>	2	0.031 kg
	<b>Indicator, Front dimension Ø 35 mm</b>						
yellow	24 VAC/DC	flush	yellow	Soldering terminal	<b>K14-040.220071</b>	2	0.031 kg

LED colour	Operating voltage	Lens profile	Lens colour	Terminal	Part No.	Wiring diagram	Weight
	<b>Indicator, Front dimension Ø 35 mm</b>						
yellow	24 VAC/DC	raised	yellow	Soldering terminal	<b>K14-040.220021</b>	2	0.031 kg
	<b>Indicator, Front dimension Ø 35 mm</b>						
green	24 VAC/DC	flush	green	Soldering terminal	<b>K14-040.220081</b>	2	0.031 kg
	<b>Indicator, Front dimension Ø 35 mm</b>						
green	24 VAC/DC	raised	green	Soldering terminal	<b>K14-040.220031</b>	2	0.031 kg
	<b>Indicator, Front dimension Ø 35 mm</b>						
blue	24 VAC/DC	flush	blue	Soldering terminal	<b>K14-040.220061</b>	2	0.031 kg
	<b>Indicator, Front dimension Ø 35 mm</b>						
blue	24 VAC/DC	raised	blue	Soldering terminal	<b>K14-040.220011</b>	2	0.031 kg
	<b>Indicator, Front dimension Ø 35 mm</b>						
clear	24 VAC/DC	flush	clear	Soldering terminal	<b>K14-040.220091</b>	2	0.031 kg
	<b>Indicator, Front dimension Ø 35 mm</b>						
clear	24 VAC/DC	raised	clear	Soldering terminal	<b>K14-040.220041</b>	2	0.031 kg
	<b>Indicator, Front dimension Ø 35 mm</b>						
red	28 VAC/DC	flush	red	Soldering terminal	<b>K14-040.220102</b>	2	0.031 kg
	<b>Indicator, Front dimension Ø 35 mm</b>						
red	28 VAC/DC	raised	red	Soldering terminal	<b>K14-040.220052</b>	2	0.031 kg

# 14 Flush design

LED colour	Operating voltage	Lens profile	Lens colour	Terminal	Part No.	Wiring diagram	Weight
 <p><b>Indicator, Front dimension Ø 35 mm</b></p>							
yellow	28 VAC/DC	flush	yellow	Soldering terminal	<b>K14-040.220072</b>	2	0.031 kg
 <p><b>Indicator, Front dimension Ø 35 mm</b></p>							
yellow	28 VAC/DC	raised	yellow	Soldering terminal	<b>K14-040.220022</b>	2	0.031 kg
 <p><b>Indicator, Front dimension Ø 35 mm</b></p>							
green	28 VAC/DC	flush	green	Soldering terminal	<b>K14-040.220082</b>	2	0.031 kg
 <p><b>Indicator, Front dimension Ø 35 mm</b></p>							
green	28 VAC/DC	raised	green	Soldering terminal	<b>K14-040.220032</b>	2	0.031 kg
 <p><b>Indicator, Front dimension Ø 35 mm</b></p>							
blue	28 VAC/DC	flush	blue	Soldering terminal	<b>K14-040.220062</b>	2	0.031 kg
 <p><b>Indicator, Front dimension Ø 35 mm</b></p>							
blue	28 VAC/DC	raised	blue	Soldering terminal	<b>K14-040.220012</b>	2	0.031 kg
 <p><b>Indicator, Front dimension Ø 35 mm</b></p>							
clear	28 VAC/DC	flush	clear	Soldering terminal	<b>K14-040.220092</b>	2	0.031 kg
 <p><b>Indicator, Front dimension Ø 35 mm</b></p>							
clear	28 VAC/DC	raised	clear	Soldering terminal	<b>K14-040.220042</b>	2	0.031 kg

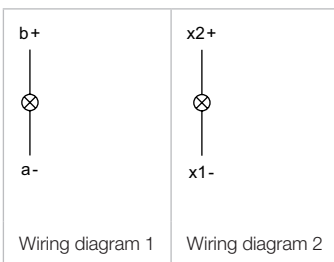



## Indicator, IP67

### Equipment consisting of (schematic overview)

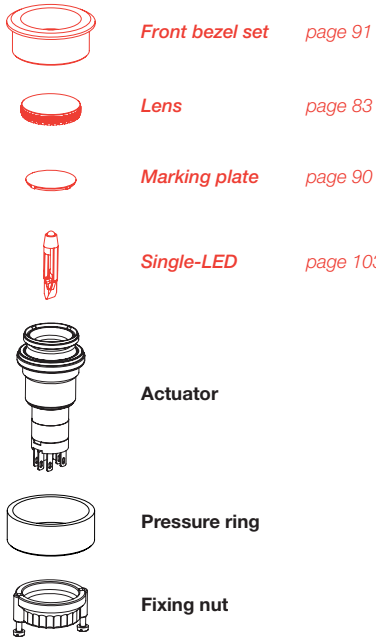

Each Part Number listed below includes all the black components shown in the 3D-drawing.

To obtain a complete unit, please select the red components from the pages shown.

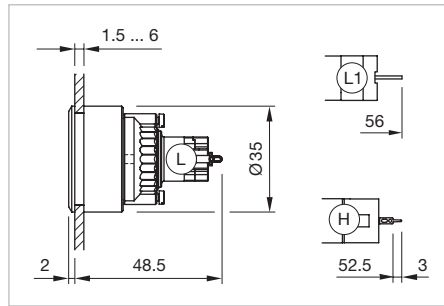

Dimensions [mm]  
 L = Solder terminal, L1 = Solder/Plug-in terminal 2.8 x 0.5 mm, H = Universal terminal 2.0 x 0.5 mm

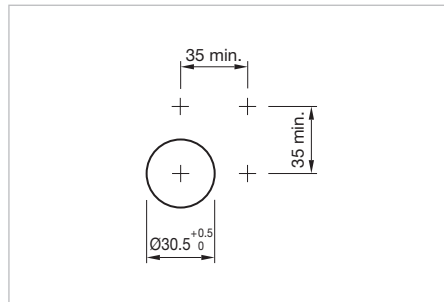



Mounting cut-outs [mm]



Product can differ from the current configuration.

### Additional Information

- For front dimension  $\varnothing$  35 mm
- For LED element fitting information see «Application guidelines, LED polarity»

Terminal	Part No.	Component layout	Wiring diagram	Weight
 <b>Indicator actuator</b>				
Solder 2.8 x 0.5 mm	<b>14-040.002</b>		1	0,050 kg
 <b>Indicator actuator</b>				
Solder	<b>14-040.005</b>		1	0,050 kg
 <b>Indicator actuator</b>				
Universal 2.0 x 0.5 mm	<b>14-041.006</b>	1	1	0,050 kg

The component layouts you will find from page 110

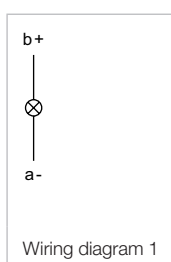

# 14 Flush design

## Buzzer, IP65



Product can differ from the current configuration.

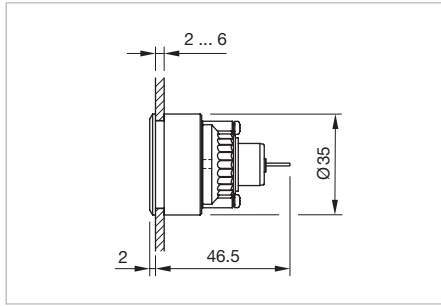

Dimensions [mm]

### Equipment consisting of (schematic overview)

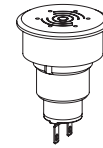

Buzzer



Pressure ring



Fixing nut

Each Part Number listed below includes all the black components shown in the 3D-drawing.

### Additional Information

- For PCB application use adaptor Part-No. 31-942
- Further information see «Technical data»
- The colour of anodized aluminium parts can vary due to technical production reasons

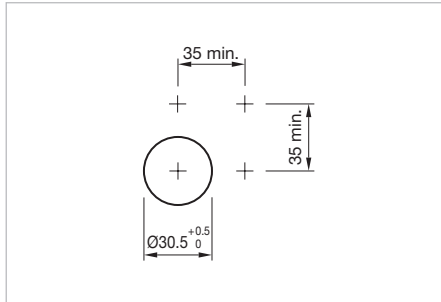

Mounting cut-outs [mm]

Operating voltage	Front cap	Terminal	Part No.	Wiring diagram	Weight
24 VDC	Aluminium black anodized	Solder 2.8 x 0.5 mm	<b>14-810.910</b>	1	0,016 kg
	Aluminium natural anodized	Solder 2.8 x 0.5 mm	<b>14-810.918</b>	1	0,016 kg



### Buzzer, Front dimension Ø 35 mm

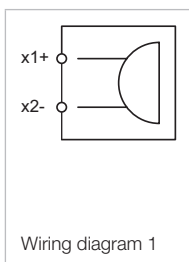

## Pushbutton complete, IP67

### Equipment consisting of (schematic overview)

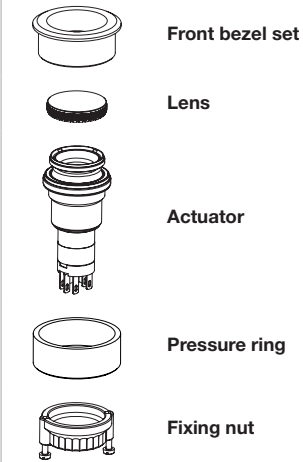

Each Part Number listed below includes all the black components shown in the 3D-drawing.

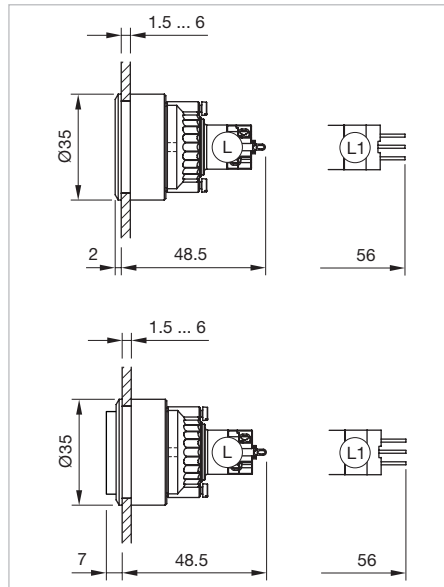



Dimensions [mm]  
 L = Solder terminal,  
 L1 = Solder/Plug-in terminal 2.8 x 0.8 mm



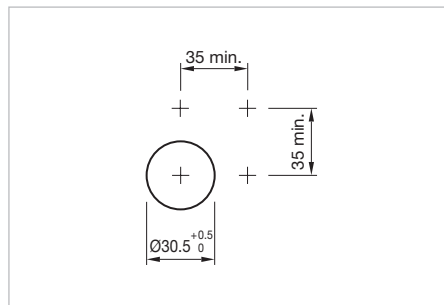







Product can differ from the current configuration.











Mounting cut-outs [mm]

Lens profile	Lens colour	Contacts	Switching action	Terminal	Part No.	Wiring diagram	Weight
	<b>Pushbutton, Front dimension Ø 35 mm</b>						
flush	red anodized	1 NC + 1 NO	Momentary	Solder/Plug-in 2.8 x 0.8 mm	<b>K14-131.211110</b>	1	0.031 kg
	<b>Pushbutton, Front dimension Ø 35 mm</b>						
flush	black anodized	1 NC + 1 NO	Momentary	Solder/Plug-in 2.8 x 0.8 mm	<b>K14-131.211120</b>	1	0.031 kg
	<b>Pushbutton, Front dimension Ø 35 mm</b>						
flush	natural anodized	1 NC + 1 NO	Momentary	Solder/Plug-in 2.8 x 0.8 mm	<b>K14-131.211130</b>	1	0.031 kg

# 14 Flush design

Lens profile	Lens colour	Contacts	Switching action	Terminal	Part No.	Wiring diagram	Weight
	<b>Pushbutton, Front dimension Ø 35 mm</b>						
flush	green anodized	1 NC + 1 NO	Momentary	Solder/Plug-in 2.8 x 0.8 mm	<b>K14-131.211140</b>	1	0.031 kg
	<b>Pushbutton, Front dimension Ø 35 mm</b>						
flush	blue anodized	1 NC + 1 NO	Momentary	Solder/Plug-in 2.8 x 0.8 mm	<b>K14-131.211150</b>	1	0.031 kg
	<b>Pushbutton, Front dimension Ø 35 mm</b>						
flush	red anodized	1 NC + 1 NO	Maintained	Solder/Plug-in 2.8 x 0.8 mm	<b>K14-271.212110</b>	2	0.031 kg
	<b>Pushbutton, Front dimension Ø 35 mm</b>						
flush	black anodized	1 NC + 1 NO	Maintained	Solder/Plug-in 2.8 x 0.8 mm	<b>K14-271.212120</b>	2	0.031 kg
	<b>Pushbutton, Front dimension Ø 35 mm</b>						
flush	natural anodized	1 NC + 1 NO	Maintained	Solder/Plug-in 2.8 x 0.8 mm	<b>K14-271.212130</b>	2	0.031 kg
	<b>Pushbutton, Front dimension Ø 35 mm</b>						
flush	green anodized	1 NC + 1 NO	Maintained	Solder/Plug-in 2.8 x 0.8 mm	<b>K14-271.212140</b>	2	0.031 kg
	<b>Pushbutton, Front dimension Ø 35 mm</b>						
flush	blue anodized	1 NC + 1 NO	Maintained	Solder/Plug-in 2.8 x 0.8 mm	<b>K14-271.212150</b>	2	0.031 kg
	<b>Pushbutton, Front dimension Ø 35 mm</b>						
flush	red anodized	1 NC + 1 NO	Momentary	Soldering terminal	<b>K14-131.221110</b>	1	0.031 kg
	<b>Pushbutton, Front dimension Ø 35 mm</b>						
flush	black anodized	1 NC + 1 NO	Momentary	Soldering terminal	<b>K14-131.221120</b>	1	0.031 kg

Lens profile	Lens colour	Contacts	Switching action	Terminal	Part No.	Wiring diagram	Weight
	<b>Pushbutton, Front dimension Ø 35 mm</b>						
flush	natural anodized	1 NC + 1 NO	Momentary	Soldering terminal	<b>K14-131.221130</b>	1	0.031 kg
	<b>Pushbutton, Front dimension Ø 35 mm</b>						
flush	green anodized	1 NC + 1 NO	Momentary	Soldering terminal	<b>K14-131.221140</b>	1	0.031 kg
	<b>Pushbutton, Front dimension Ø 35 mm</b>						
flush	blue anodized	1 NC + 1 NO	Momentary	Soldering terminal	<b>K14-131.221150</b>	1	0.031 kg
	<b>Pushbutton, Front dimension Ø 35 mm</b>						
flush	red anodized	1 NC + 1 NO	Maintained	Soldering terminal	<b>K14-271.222110</b>	2	0.031 kg
	<b>Pushbutton, Front dimension Ø 35 mm</b>						
flush	black anodized	1 NC + 1 NO	Maintained	Soldering terminal	<b>K14-271.222120</b>	2	0.031 kg
	<b>Pushbutton, Front dimension Ø 35 mm</b>						
flush	natural anodized	1 NC + 1 NO	Maintained	Soldering terminal	<b>K14-271.222130</b>	2	0.031 kg
	<b>Pushbutton, Front dimension Ø 35 mm</b>						
flush	green anodized	1 NC + 1 NO	Maintained	Soldering terminal	<b>K14-271.222140</b>	2	0.031 kg
	<b>Pushbutton, Front dimension Ø 35 mm</b>						
flush	blue anodized	1 NC + 1 NO	Maintained	Soldering terminal	<b>K14-271.222150</b>	2	0.031 kg

Contacts: NC = Normally closed, NO = Normally open

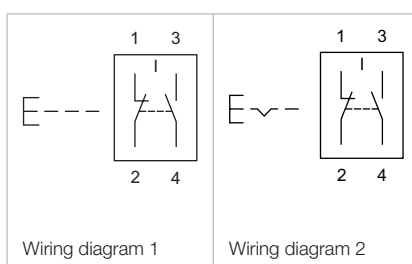

# 14 Flush design

## Illuminated pushbutton complete, IP67



Product can differ from the current configuration.

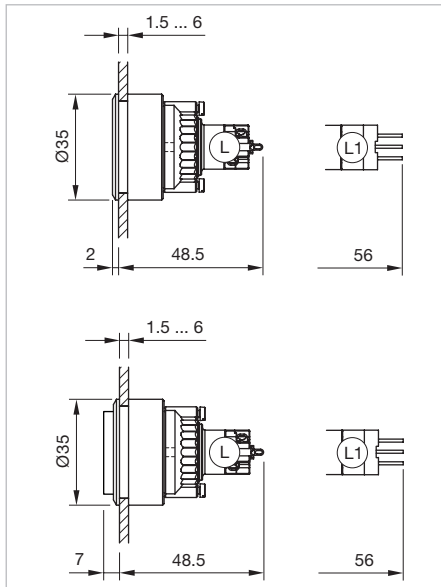

Dimensions [mm]  
L = Solder terminal,  
L1 = Solder/Plug-in terminal 2.8 x 0.8 mm

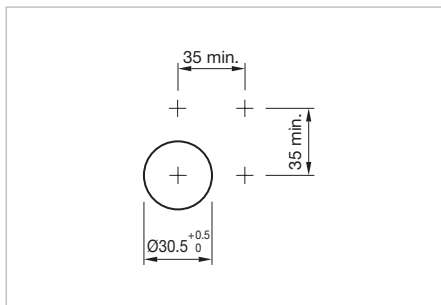





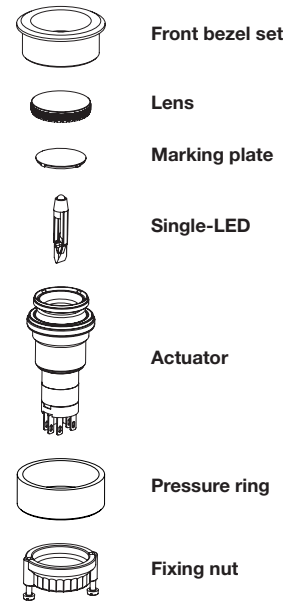







Mounting cut-outs [mm]

### Equipment consisting of (schematic overview)











Each Part Number listed below includes all the black components shown in the 3D-drawing.









LED colour	Operating voltage	Lens profile	Lens colour	Contacts	Switching action	Terminal	Part No.	Wiring diagram	Weight
	<b>Illuminated pushbutton, Front dimension Ø 35 mm</b>								
red	24 VAC/DC	flush	red	1 NC + 1 NO	Momentary	Solder/Plug-in 2.8 x 0.8 mm	<b>K14-131.211101</b>	1	0.031 kg
	<b>Illuminated pushbutton, Front dimension Ø 35 mm</b>								
red	24 VAC/DC	raised	red	1 NC + 1 NO	Momentary	Solder/Plug-in 2.8 x 0.8 mm	<b>K14-131.211051</b>	1	0.031 kg
	<b>Illuminated pushbutton, Front dimension Ø 35 mm</b>								
yellow	24 VAC/DC	flush	yellow	1 NC + 1 NO	Momentary	Solder/Plug-in 2.8 x 0.8 mm	<b>K14-131.211071</b>	1	0.031 kg

LED colour	Operating voltage	Lens profile	Lens colour	Contacts	Switching action	Terminal	Part No.	Wiring diagram	Weight
	<b>Illuminated pushbutton, Front dimension Ø 35 mm</b>								
yellow	24 VAC/DC	raised	yellow	1 NC + 1 NO	Momentary	Solder/Plug-in 2.8 x 0.8 mm	<b>K14-131.211021</b>	1	0.031 kg
	<b>Illuminated pushbutton, Front dimension Ø 35 mm</b>								
green	24 VAC/DC	flush	green	1 NC + 1 NO	Momentary	Solder/Plug-in 2.8 x 0.8 mm	<b>K14-131.211081</b>	1	0.031 kg
	<b>Illuminated pushbutton, Front dimension Ø 35 mm</b>								
green	24 VAC/DC	raised	green	1 NC + 1 NO	Momentary	Solder/Plug-in 2.8 x 0.8 mm	<b>K14-131.211031</b>	1	0.031 kg
	<b>Illuminated pushbutton, Front dimension Ø 35 mm</b>								
blue	24 VAC/DC	flush	blue	1 NC + 1 NO	Momentary	Solder/Plug-in 2.8 x 0.8 mm	<b>K14-131.211061</b>	1	0.031 kg
	<b>Illuminated pushbutton, Front dimension Ø 35 mm</b>								
blue	24 VAC/DC	raised	blue	1 NC + 1 NO	Momentary	Solder/Plug-in 2.8 x 0.8 mm	<b>K14-131.211011</b>	1	0.031 kg
	<b>Illuminated pushbutton, Front dimension Ø 35 mm</b>								
clear	24 VAC/DC	flush	clear	1 NC + 1 NO	Momentary	Solder/Plug-in 2.8 x 0.8 mm	<b>K14-131.211091</b>	1	0.031 kg
	<b>Illuminated pushbutton, Front dimension Ø 35 mm</b>								
clear	24 VAC/DC	raised	clear	1 NC + 1 NO	Momentary	Solder/Plug-in 2.8 x 0.8 mm	<b>K14-131.211041</b>	1	0.031 kg
	<b>Illuminated pushbutton, Front dimension Ø 35 mm</b>								
red	28 VAC/DC	flush	red	1 NC + 1 NO	Momentary	Solder/Plug-in 2.8 x 0.8 mm	<b>K14-131.211102</b>	1	0.031 kg
	<b>Illuminated pushbutton, Front dimension Ø 35 mm</b>								
red	28 VAC/DC	raised	red	1 NC + 1 NO	Momentary	Solder/Plug-in 2.8 x 0.8 mm	<b>K14-131.211052</b>	1	0.031 kg







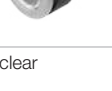

# 14 Flush design









LED colour	Operating voltage	Lens profile	Lens colour	Contacts	Switching action	Terminal	Part No.	Wiring diagram	Weight
	<b>Illuminated pushbutton, Front dimension Ø 35 mm</b>								
yellow	28 VAC/DC	flush	yellow	1 NC + 1 NO	Momentary	Solder/Plug-in 2.8 x 0.8 mm	<b>K14-131.211072</b>	1	0.031 kg
	<b>Illuminated pushbutton, Front dimension Ø 35 mm</b>								
yellow	28 VAC/DC	raised	yellow	1 NC + 1 NO	Momentary	Solder/Plug-in 2.8 x 0.8 mm	<b>K14-131.211022</b>	1	0.031 kg
	<b>Illuminated pushbutton, Front dimension Ø 35 mm</b>								
green	28 VAC/DC	flush	green	1 NC + 1 NO	Momentary	Solder/Plug-in 2.8 x 0.8 mm	<b>K14-131.211082</b>	1	0.031 kg
	<b>Illuminated pushbutton, Front dimension Ø 35 mm</b>								
green	28 VAC/DC	raised	green	1 NC + 1 NO	Momentary	Solder/Plug-in 2.8 x 0.8 mm	<b>K14-131.211032</b>	1	0.031 kg
	<b>Illuminated pushbutton, Front dimension Ø 35 mm</b>								
blue	28 VAC/DC	flush	blue	1 NC + 1 NO	Momentary	Solder/Plug-in 2.8 x 0.8 mm	<b>K14-131.211062</b>	1	0.031 kg
	<b>Illuminated pushbutton, Front dimension Ø 35 mm</b>								
blue	28 VAC/DC	raised	blue	1 NC + 1 NO	Momentary	Solder/Plug-in 2.8 x 0.8 mm	<b>K14-131.211012</b>	1	0.031 kg
	<b>Illuminated pushbutton, Front dimension Ø 35 mm</b>								
clear	28 VAC/DC	flush	clear	1 NC + 1 NO	Momentary	Solder/Plug-in 2.8 x 0.8 mm	<b>K14-131.211092</b>	1	0.031 kg
	<b>Illuminated pushbutton, Front dimension Ø 35 mm</b>								
clear	28 VAC/DC	raised	clear	1 NC + 1 NO	Momentary	Solder/Plug-in 2.8 x 0.8 mm	<b>K14-131.211042</b>	1	0.031 kg
	<b>Illuminated pushbutton, Front dimension Ø 35 mm</b>								
red	24 VAC/DC	flush	red	1 NC + 1 NO	Maintained	Solder/Plug-in 2.8 x 0.8 mm	<b>K14-271.212101</b>	2	0.031 kg











LED colour	Operating voltage	Lens profile	Lens colour	Contacts	Switching action	Terminal	Part No.	Wiring diagram	Weight
	<b>Illuminated pushbutton, Front dimension Ø 35 mm</b>								
red	24 VAC/DC	raised	red	1 NC + 1 NO	Maintained	Solder/Plug-in 2.8 x 0.8 mm	<b>K14-271.212051</b>	2	0.031 kg
	<b>Illuminated pushbutton, Front dimension Ø 35 mm</b>								
yellow	24 VAC/DC	flush	yellow	1 NC + 1 NO	Maintained	Solder/Plug-in 2.8 x 0.8 mm	<b>K14-271.212071</b>	2	0.031 kg
	<b>Illuminated pushbutton, Front dimension Ø 35 mm</b>								
yellow	24 VAC/DC	raised	yellow	1 NC + 1 NO	Maintained	Solder/Plug-in 2.8 x 0.8 mm	<b>K14-271.212021</b>	2	0.031 kg
	<b>Illuminated pushbutton, Front dimension Ø 35 mm</b>								
green	24 VAC/DC	flush	green	1 NC + 1 NO	Maintained	Solder/Plug-in 2.8 x 0.8 mm	<b>K14-271.212081</b>	2	0.031 kg
	<b>Illuminated pushbutton, Front dimension Ø 35 mm</b>								
green	24 VAC/DC	raised	green	1 NC + 1 NO	Maintained	Solder/Plug-in 2.8 x 0.8 mm	<b>K14-271.212031</b>	2	0.031 kg
	<b>Illuminated pushbutton, Front dimension Ø 35 mm</b>								
blue	24 VAC/DC	flush	blue	1 NC + 1 NO	Maintained	Solder/Plug-in 2.8 x 0.8 mm	<b>K14-271.212061</b>	2	0.031 kg
	<b>Illuminated pushbutton, Front dimension Ø 35 mm</b>								
blue	24 VAC/DC	raised	blue	1 NC + 1 NO	Maintained	Solder/Plug-in 2.8 x 0.8 mm	<b>K14-271.212011</b>	2	0.031 kg
	<b>Illuminated pushbutton, Front dimension Ø 35 mm</b>								
clear	24 VAC/DC	flush	clear	1 NC + 1 NO	Maintained	Solder/Plug-in 2.8 x 0.8 mm	<b>K14-271.212091</b>	2	0.031 kg
	<b>Illuminated pushbutton, Front dimension Ø 35 mm</b>								
clear	24 VAC/DC	raised	clear	1 NC + 1 NO	Maintained	Solder/Plug-in 2.8 x 0.8 mm	<b>K14-271.212041</b>	2	0.031 kg









# 14 Flush design

LED colour	Operating voltage	Lens profile	Lens colour	Contacts	Switching action	Terminal	Part No.	Wiring diagram	Weight
 <p><b>Illuminated pushbutton, Front dimension Ø 35 mm</b></p>									
red	28 VAC/DC	flush	red	1 NC + 1 NO	Maintained	Solder/Plug-in 2.8 x 0.8 mm	<b>K14-271.212102</b>	2	0.031 kg
 <p><b>Illuminated pushbutton, Front dimension Ø 35 mm</b></p>									
red	28 VAC/DC	raised	red	1 NC + 1 NO	Maintained	Solder/Plug-in 2.8 x 0.8 mm	<b>K14-271.212052</b>	2	0.031 kg
 <p><b>Illuminated pushbutton, Front dimension Ø 35 mm</b></p>									
yellow	28 VAC/DC	flush	yellow	1 NC + 1 NO	Maintained	Solder/Plug-in 2.8 x 0.8 mm	<b>K14-271.212072</b>	2	0.031 kg
 <p><b>Illuminated pushbutton, Front dimension Ø 35 mm</b></p>									
yellow	28 VAC/DC	raised	yellow	1 NC + 1 NO	Maintained	Solder/Plug-in 2.8 x 0.8 mm	<b>K14-271.212022</b>	2	0.031 kg
 <p><b>Illuminated pushbutton, Front dimension Ø 35 mm</b></p>									
green	28 VAC/DC	flush	green	1 NC + 1 NO	Maintained	Solder/Plug-in 2.8 x 0.8 mm	<b>K14-271.212082</b>	2	0.031 kg
 <p><b>Illuminated pushbutton, Front dimension Ø 35 mm</b></p>									
green	28 VAC/DC	raised	green	1 NC + 1 NO	Maintained	Solder/Plug-in 2.8 x 0.8 mm	<b>K14-271.212032</b>	2	0.031 kg
 <p><b>Illuminated pushbutton, Front dimension Ø 35 mm</b></p>									
blue	28 VAC/DC	flush	blue	1 NC + 1 NO	Maintained	Solder/Plug-in 2.8 x 0.8 mm	<b>K14-271.212062</b>	2	0.031 kg
 <p><b>Illuminated pushbutton, Front dimension Ø 35 mm</b></p>									
blue	28 VAC/DC	raised	blue	1 NC + 1 NO	Maintained	Solder/Plug-in 2.8 x 0.8 mm	<b>K14-271.212012</b>	2	0.031 kg
 <p><b>Illuminated pushbutton, Front dimension Ø 35 mm</b></p>									
clear	28 VAC/DC	flush	clear	1 NC + 1 NO	Maintained	Solder/Plug-in 2.8 x 0.8 mm	<b>K14-271.212092</b>	2	0.031 kg









LED colour	Operating voltage	Lens profile	Lens colour	Contacts	Switching action	Terminal	Part No.	Wiring diagram	Weight
	<b>Illuminated pushbutton, Front dimension Ø 35 mm</b>								
clear	28 VAC/DC	raised	clear	1 NC + 1 NO	Maintained	Solder/Plug-in 2.8 x 0.8 mm	<b>K14-271.212042</b>	2	0.031 kg
	<b>Illuminated pushbutton, Front dimension Ø 35 mm</b>								
red	24 VAC/DC	flush	red	1 NC + 1 NO	Momentary	Soldering terminal	<b>K14-131.221101</b>	1	0.031 kg
	<b>Illuminated pushbutton, Front dimension Ø 35 mm</b>								
red	24 VAC/DC	raised	red	1 NC + 1 NO	Momentary	Soldering terminal	<b>K14-131.221051</b>	1	0.031 kg
	<b>Illuminated pushbutton, Front dimension Ø 35 mm</b>								
yellow	24 VAC/DC	flush	yellow	1 NC + 1 NO	Momentary	Soldering terminal	<b>K14-131.221071</b>	1	0.031 kg
	<b>Illuminated pushbutton, Front dimension Ø 35 mm</b>								
yellow	24 VAC/DC	raised	yellow	1 NC + 1 NO	Momentary	Soldering terminal	<b>K14-131.221021</b>	1	0.031 kg
	<b>Illuminated pushbutton, Front dimension Ø 35 mm</b>								
green	24 VAC/DC	flush	green	1 NC + 1 NO	Momentary	Soldering terminal	<b>K14-131.221081</b>	1	0.031 kg
	<b>Illuminated pushbutton, Front dimension Ø 35 mm</b>								
green	24 VAC/DC	raised	green	1 NC + 1 NO	Momentary	Soldering terminal	<b>K14-131.221031</b>	1	0.031 kg
	<b>Illuminated pushbutton, Front dimension Ø 35 mm</b>								
blue	24 VAC/DC	flush	blue	1 NC + 1 NO	Momentary	Soldering terminal	<b>K14-131.221061</b>	1	0.031 kg
	<b>Illuminated pushbutton, Front dimension Ø 35 mm</b>								
blue	24 VAC/DC	raised	blue	1 NC + 1 NO	Momentary	Soldering terminal	<b>K14-131.221011</b>	1	0.031 kg





# 14 Flush design

LED colour	Operating voltage	Lens profile	Lens colour	Contacts	Switching action	Terminal	Part No.	Wiring diagram	Weight
	<b>Illuminated pushbutton, Front dimension Ø 35 mm</b>								
clear	24 VAC/DC	flush	clear	1 NC + 1 NO	Momentary	Soldering terminal	<b>K14-131.221091</b>	1	0.031 kg
	<b>Illuminated pushbutton, Front dimension Ø 35 mm</b>								
clear	24 VAC/DC	raised	clear	1 NC + 1 NO	Momentary	Soldering terminal	<b>K14-131.221041</b>	1	0.031 kg
	<b>Illuminated pushbutton, Front dimension Ø 35 mm</b>								
red	28 VAC/DC	flush	red	1 NC + 1 NO	Momentary	Soldering terminal	<b>K14-131.221102</b>	1	0.031 kg
	<b>Illuminated pushbutton, Front dimension Ø 35 mm</b>								
red	28 VAC/DC	raised	red	1 NC + 1 NO	Momentary	Soldering terminal	<b>K14-131.221052</b>	1	0.031 kg
	<b>Illuminated pushbutton, Front dimension Ø 35 mm</b>								
yellow	28 VAC/DC	flush	yellow	1 NC + 1 NO	Momentary	Soldering terminal	<b>K14-131.221072</b>	1	0.031 kg
	<b>Illuminated pushbutton, Front dimension Ø 35 mm</b>								
yellow	28 VAC/DC	raised	yellow	1 NC + 1 NO	Momentary	Soldering terminal	<b>K14-131.221022</b>	1	0.031 kg
	<b>Illuminated pushbutton, Front dimension Ø 35 mm</b>								
green	28 VAC/DC	flush	green	1 NC + 1 NO	Momentary	Soldering terminal	<b>K14-131.221082</b>	1	0.031 kg
	<b>Illuminated pushbutton, Front dimension Ø 35 mm</b>								
green	28 VAC/DC	raised	green	1 NC + 1 NO	Momentary	Soldering terminal	<b>K14-131.221032</b>	1	0.031 kg
	<b>Illuminated pushbutton, Front dimension Ø 35 mm</b>								
blue	28 VAC/DC	flush	blue	1 NC + 1 NO	Momentary	Soldering terminal	<b>K14-131.221062</b>	1	0.031 kg

LED colour	Operating voltage	Lens profile	Lens colour	Contacts	Switching action	Terminal	Part No.	Wiring diagram	Weight
	<b>Illuminated pushbutton, Front dimension Ø 35 mm</b>								
blue	28 VAC/DC	raised	blue	1 NC + 1 NO	Momentary	Soldering terminal	<b>K14-131.221012</b>	1	0.031 kg
	<b>Illuminated pushbutton, Front dimension Ø 35 mm</b>								
clear	28 VAC/DC	flush	clear	1 NC + 1 NO	Momentary	Soldering terminal	<b>K14-131.221092</b>	1	0.031 kg
	<b>Illuminated pushbutton, Front dimension Ø 35 mm</b>								
clear	28 VAC/DC	raised	clear	1 NC + 1 NO	Momentary	Soldering terminal	<b>K14-131.221042</b>	1	0.031 kg
	<b>Illuminated pushbutton, Front dimension Ø 35 mm</b>								
red	24 VAC/DC	flush	red	1 NC + 1 NO	Maintained	Soldering terminal	<b>K14-271.222101</b>	2	0.031 kg
	<b>Illuminated pushbutton, Front dimension Ø 35 mm</b>								
red	24 VAC/DC	raised	red	1 NC + 1 NO	Maintained	Soldering terminal	<b>K14-271.222051</b>	2	0.031 kg
	<b>Illuminated pushbutton, Front dimension Ø 35 mm</b>								
yellow	24 VAC/DC	flush	yellow	1 NC + 1 NO	Maintained	Soldering terminal	<b>K14-271.222071</b>	2	0.031 kg
	<b>Illuminated pushbutton, Front dimension Ø 35 mm</b>								
yellow	24 VAC/DC	raised	yellow	1 NC + 1 NO	Maintained	Soldering terminal	<b>K14-271.222021</b>	2	0.031 kg
	<b>Illuminated pushbutton, Front dimension Ø 35 mm</b>								
green	24 VAC/DC	flush	green	1 NC + 1 NO	Maintained	Soldering terminal	<b>K14-271.222081</b>	2	0.031 kg
	<b>Illuminated pushbutton, Front dimension Ø 35 mm</b>								
green	24 VAC/DC	raised	green	1 NC + 1 NO	Maintained	Soldering terminal	<b>K14-271.222031</b>	2	0.031 kg

# 14 Flush design

LED colour	Operating voltage	Lens profile	Lens colour	Contacts	Switching action	Terminal	Part No.	Wiring diagram	Weight
	<b>Illuminated pushbutton, Front dimension Ø 35 mm</b>								
blue	24 VAC/DC	flush	blue	1 NC + 1 NO	Maintained	Soldering terminal	<b>K14-271.222061</b>	2	0.031 kg
	<b>Illuminated pushbutton, Front dimension Ø 35 mm</b>								
blue	24 VAC/DC	raised	blue	1 NC + 1 NO	Maintained	Soldering terminal	<b>K14-271.222011</b>	2	0.031 kg
	<b>Illuminated pushbutton, Front dimension Ø 35 mm</b>								
clear	24 VAC/DC	flush	clear	1 NC + 1 NO	Maintained	Soldering terminal	<b>K14-271.222091</b>	2	0.031 kg
	<b>Illuminated pushbutton, Front dimension Ø 35 mm</b>								
clear	24 VAC/DC	raised	clear	1 NC + 1 NO	Maintained	Soldering terminal	<b>K14-271.222041</b>	2	0.031 kg
	<b>Illuminated pushbutton, Front dimension Ø 35 mm</b>								
red	28 VAC/DC	flush	red	1 NC + 1 NO	Maintained	Soldering terminal	<b>K14-271.222102</b>	2	0.031 kg
	<b>Illuminated pushbutton, Front dimension Ø 35 mm</b>								
red	28 VAC/DC	raised	red	1 NC + 1 NO	Maintained	Soldering terminal	<b>K14-271.222052</b>	2	0.031 kg
	<b>Illuminated pushbutton, Front dimension Ø 35 mm</b>								
yellow	28 VAC/DC	flush	yellow	1 NC + 1 NO	Maintained	Soldering terminal	<b>K14-271.222072</b>	2	0.031 kg
	<b>Illuminated pushbutton, Front dimension Ø 35 mm</b>								
yellow	28 VAC/DC	raised	yellow	1 NC + 1 NO	Maintained	Soldering terminal	<b>K14-271.222022</b>	2	0.031 kg
	<b>Illuminated pushbutton, Front dimension Ø 35 mm</b>								
green	28 VAC/DC	flush	green	1 NC + 1 NO	Maintained	Soldering terminal	<b>K14-271.222082</b>	2	0.031 kg

LED colour	Operating voltage	Lens profile	Lens colour	Contacts	Switching action	Terminal	Part No.	Wiring diagram	Weight
 <p><b>Illuminated pushbutton, Front dimension Ø 35 mm</b></p>									
green	28 VAC/DC	raised	green	1 NC + 1 NO	Maintained	Soldering terminal	<b>K14-271.222032</b>	2	0.031 kg
 <p><b>Illuminated pushbutton, Front dimension Ø 35 mm</b></p>									
blue	28 VAC/DC	flush	blue	1 NC + 1 NO	Maintained	Soldering terminal	<b>K14-271.222062</b>	2	0.031 kg
 <p><b>Illuminated pushbutton, Front dimension Ø 35 mm</b></p>									
blue	28 VAC/DC	raised	blue	1 NC + 1 NO	Maintained	Soldering terminal	<b>K14-271.222012</b>	2	0.031 kg
 <p><b>Illuminated pushbutton, Front dimension Ø 35 mm</b></p>									
clear	28 VAC/DC	flush	clear	1 NC + 1 NO	Maintained	Soldering terminal	<b>K14-271.222092</b>	2	0.031 kg
 <p><b>Illuminated pushbutton, Front dimension Ø 35 mm</b></p>									
clear	28 VAC/DC	raised	clear	1 NC + 1 NO	Maintained	Soldering terminal	<b>K14-271.222042</b>	2	0.031 kg

Contacts: NC = Normally closed, NO = Normally open

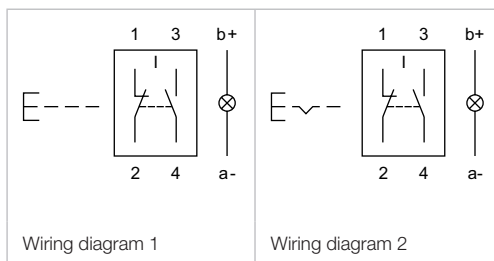

# 14 Flush design

## Illuminated pushbutton, IP67



Product can differ from the current configuration.

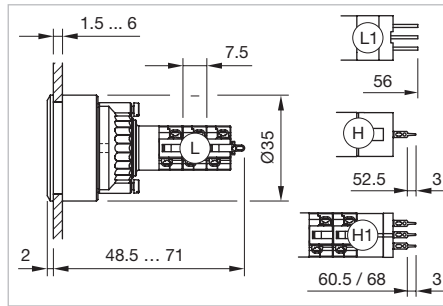

### Additional Information

- For front dimension  $\varnothing$  35 mm
- For LED element fitting information see «Application guidelines, LED polarity»

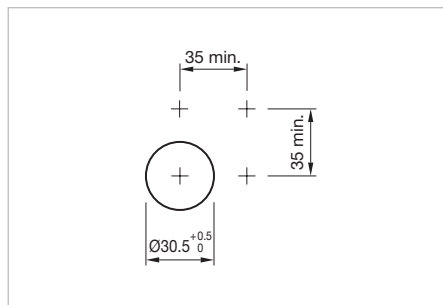



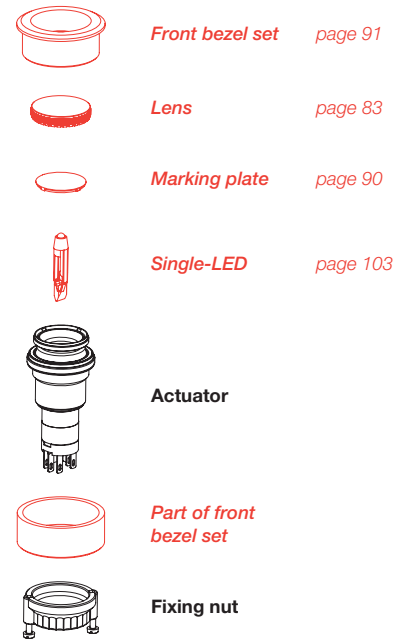

### Equipment consisting of (schematic overview)









Each Part Number listed below includes all the black components shown in the 3D-drawing.







To obtain a complete unit, please select the red components from the pages shown.

Switching system	Contacts	Switching action	Terminal	Diode 1N4007	Part No.	Component layout	Wiring diagram	Weight
 <p><b>Illuminated pushbutton actuator, Front dimension <math>\varnothing</math> 35 mm</b></p>								
Low-level element	1 NC	Momentary	Universal 2.0 x 0.5 mm	-	<b>14-436.036</b>	1	1	0,015 kg
 <p><b>Illuminated pushbutton actuator, Front dimension <math>\varnothing</math> 35 mm</b></p>								
Low-level element	1 NC	Maintained	Universal 2.0 x 0.5 mm	-	<b>14-476.036</b>	1	2	0,015 kg
 <p><b>Illuminated pushbutton actuator, Front dimension <math>\varnothing</math> 35 mm</b></p>								
Low-level element	1 NC + 1 NO	Momentary	Universal 2.0 x 0.5 mm	-	<b>14-433.036</b>	1	3	0,015 kg
 <p><b>Illuminated pushbutton actuator, Front dimension <math>\varnothing</math> 35 mm</b></p>								
Low-level element	1 NC + 1 NO	Maintained	Universal 2.0 x 0.5 mm	-	<b>14-473.036</b>	1	4	0,015 kg
	1 NO	Momentary	Universal 2.0 x 0.5 mm	-	<b>14-435.036</b>	1	5	0,015 kg



Switching system	Contacts	Switching action	Terminal	Diode 1N4007	Part No.	Component layout	Wiring diagram	Weight
 <p><b>Illuminated pushbutton actuator, Front dimension Ø 35 mm</b></p>								
Low-level element	1 NO	Maintained	Universal 2.0 x 0.5 mm	–	<b>14-475.036</b>	1	6	0,015 kg
 <p><b>Illuminated pushbutton actuator, Front dimension Ø 35 mm</b></p>								
Low-level element	2 NC	Momentary	Universal 2.0 x 0.5 mm	–	<b>14-432.036</b>	1	7	0,015 kg
		Maintained	Universal 2.0 x 0.5 mm	–	<b>14-472.036</b>	1	8	0,015 kg
	2 NO	Momentary	Universal 2.0 x 0.5 mm	–	<b>14-431.036</b>	1	9	0,015 kg
		Maintained	Universal 2.0 x 0.5 mm	–	<b>14-471.036</b>	1	10	0,015 kg
 <p><b>Illuminated pushbutton actuator, Front dimension Ø 35 mm</b></p>								
Snap-action switching element	1 NC + 1 NO	Momentary	Universal-Solder	1	<b>14-743.0292</b>	1	11	0,014 kg
Snap-action switching element	1 NC + 1 NO	Maintained	Universal-Solder	1	<b>14-747.0292</b>	1	12	0,014 kg
 <p><b>Illuminated pushbutton actuator, Front dimension Ø 35 mm</b></p>								
Snap-action switching element	1 NC + 1 NO	Momentary	Universal-Solder	2	<b>14-744.0292</b>	1	13	0,014 kg
Snap-action switching element	1 NC + 1 NO	Maintained	Universal-Solder	2	<b>14-748.0292</b>	1	14	0,014 kg
 <p><b>Illuminated pushbutton actuator, Front dimension Ø 35 mm</b></p>								
Snap-action switching element	1 NC + 1 NO	Momentary	Solder 2.8 x 0.5 mm	–	<b>14-131.022</b>		24	0,013 kg
 <p><b>Illuminated pushbutton actuator, Front dimension Ø 35 mm</b></p>								
Snap-action switching element	1 NC + 1 NO	Momentary	Solder	–	<b>14-131.0252</b>		15	0,013 kg
 <p><b>Illuminated pushbutton actuator, Front dimension Ø 35 mm</b></p>								
Snap-action switching element	1 NC + 1 NO	Maintained	Solder 2.8 x 0.5 mm	–	<b>14-271.022</b>		25	0,013 kg

# 14 Flush design

Switching system	Contacts	Switching action	Terminal	Diode 1N4007	Part No.	Component layout	Wiring diagram	Weight
 <p><b>Illuminated pushbutton actuator, Front dimension Ø 35 mm</b></p>								
Snap-action switching element	4 NC + 4 NO	Maintained	Solder	-	<b>14-274.0252</b>		23	0,019 kg
 <p><b>Illuminated pushbutton actuator, Front dimension Ø 35 mm</b></p>								
Snap-action switching element	1 NC + 1 NO	Maintained	Solder	-	<b>14-271.0252</b>		16	0,013 kg
 <p><b>Illuminated pushbutton actuator, Front dimension Ø 35 mm</b></p>								
Snap-action switching element	2 NC + 2 NO	Momentary	Universal-Solder	2	<b>14-746.0292</b>	1	17	0,016 kg
 <p><b>Illuminated pushbutton actuator, Front dimension Ø 29 mm</b></p>								
Snap-action switching element	2 NC + 2 NO	Momentary	Solder	-	<b>14-132.0252</b>		18	0,015 kg
 <p><b>Illuminated pushbutton actuator, Front dimension Ø 35 mm</b></p>								
Snap-action switching element	2 NC + 2 NO	Maintained	Solder	-	<b>14-272.0252</b>		19	0,015 kg
 <p><b>Illuminated pushbutton actuator, Front dimension Ø 35 mm</b></p>								
Snap-action switching element	3 NC + 3 NO	Momentary	Solder	-	<b>14-133.0252</b>		20	0,017 kg
	3 NC + 3 NO	Maintained	Solder	-	<b>14-273.0252</b>		21	0,017 kg
 <p><b>Illuminated pushbutton actuator, Front dimension Ø 35 mm</b></p>								
Snap-action switching element	4 NC + 4 NO	Momentary	Solder	-	<b>14-134.0252</b>		22	0,019 kg

Contacts: NC = Normally closed, NO = Normally open  
 The component layouts you will find from page 110

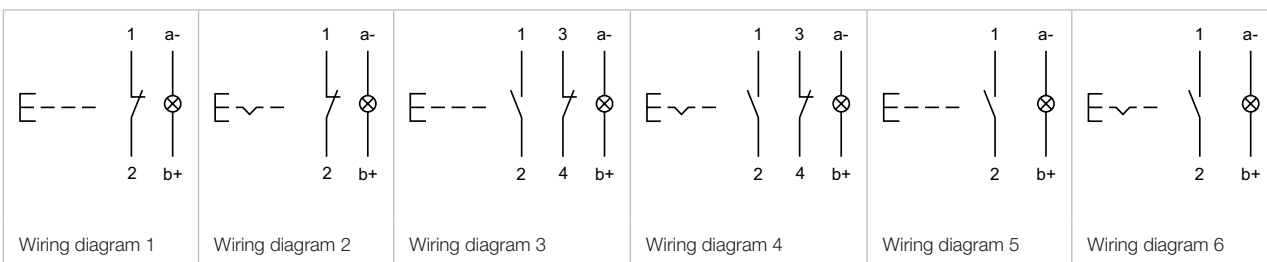

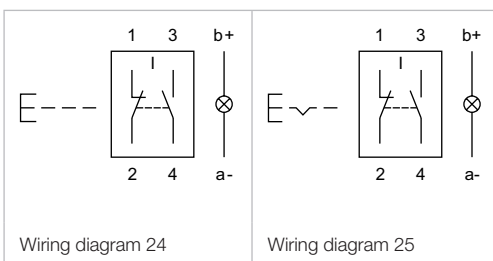
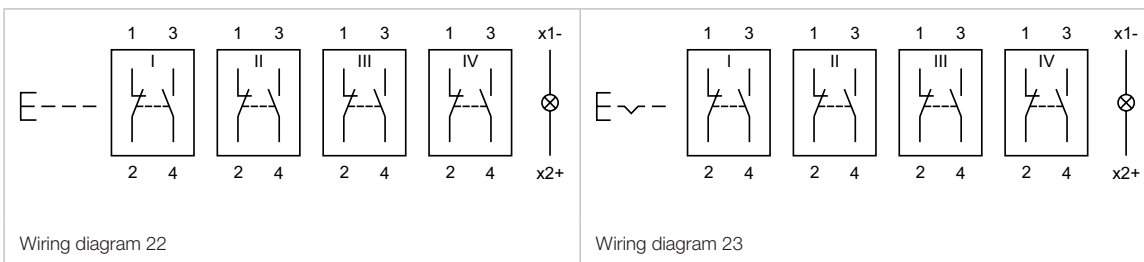
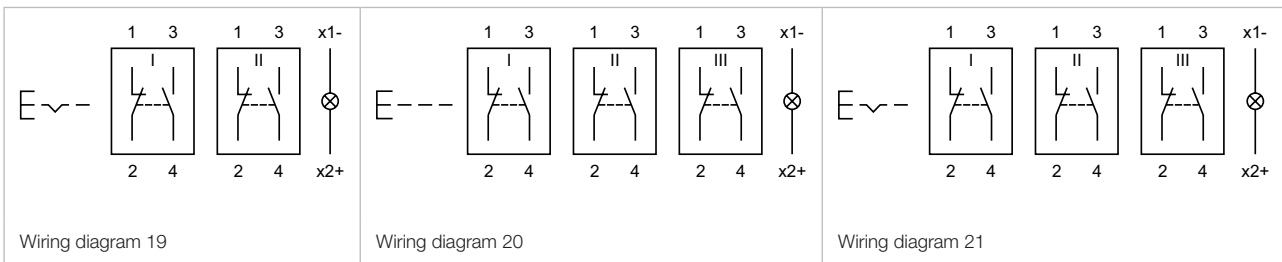
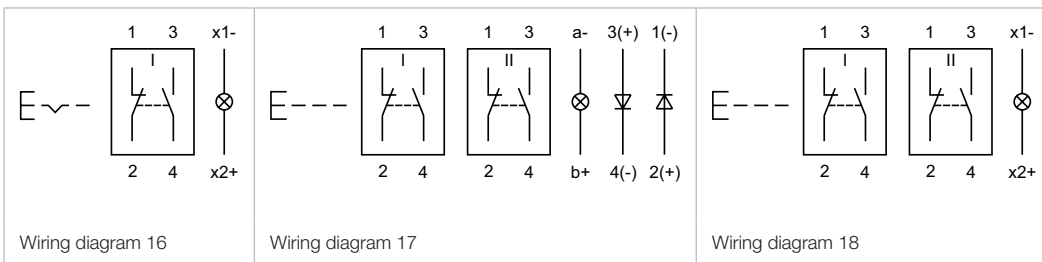
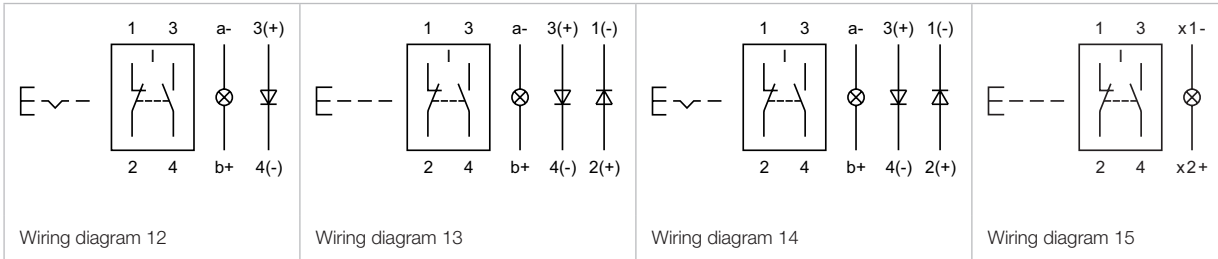
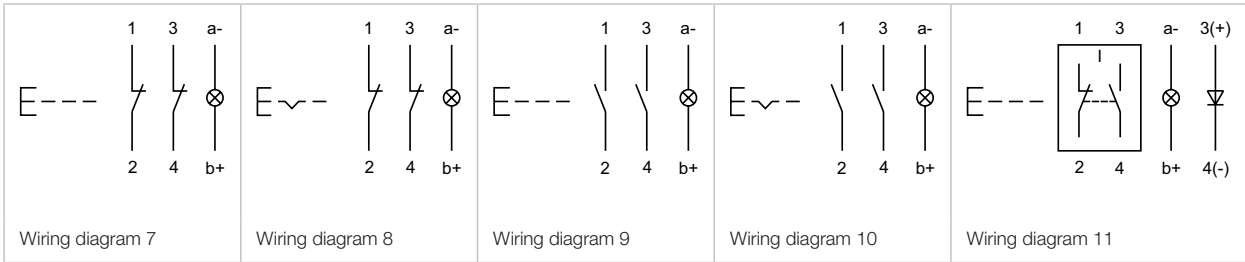

# 14 Flush design

## Mushroom-head pushbutton, IP67



Product can differ from the current configuration.

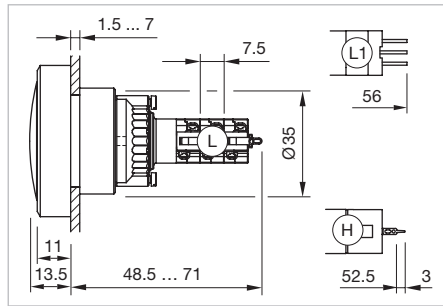

Dimensions [mm]  
 L = Solder terminal,  
 L1 = Solder/Plug-in terminal 2.8 x 0.5 mm,  
 H = Universal terminal 2.0 x 0.5 mm

### Equipment consisting of (schematic overview)

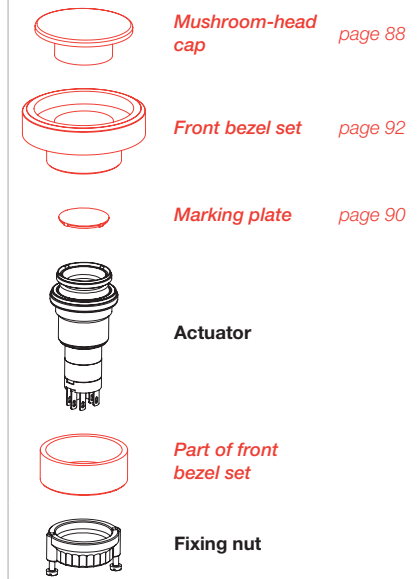

Each Part Number listed below includes all the black components shown in the 3D-drawing.

To obtain a complete unit, please select the red components from the pages shown.

### Additional Information

- For front dimension Ø 50 mm
- To obtain IP 67 use marking plate Part No. 704.609.9

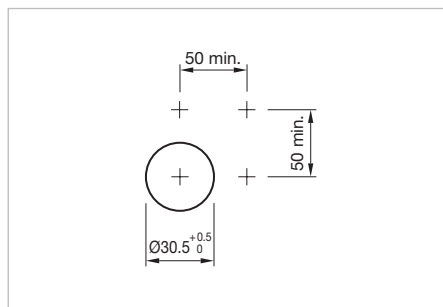

Mounting cut-outs [mm]

Switching system	Contacts	Switching action	Terminal	Part No.	Component layout	Wiring diagram	Weight
 <p><b>Mushroom-head pushbutton actuator round, 35 mm</b></p>	1 NC	Momentary	Universal 2.0 x 0.5 mm	<b>14-436.036</b>	1	1	0,015 kg
		Maintained	Universal 2.0 x 0.5 mm	<b>14-476.036</b>	1	2	0,015 kg
	1 NC + 1 NO	Momentary	Universal 2.0 x 0.5 mm	<b>14-433.036</b>	1	3	0,015 kg
		Maintained	Universal 2.0 x 0.5 mm	<b>14-473.036</b>	1	4	0,015 kg
	1 NO	Momentary	Universal 2.0 x 0.5 mm	<b>14-435.036</b>	1	5	0,015 kg
		Maintained	Universal 2.0 x 0.5 mm	<b>14-475.036</b>	1	6	0,015 kg
	2 NC	Momentary	Universal 2.0 x 0.5 mm	<b>14-432.036</b>	1	7	0,015 kg
		Maintained	Universal 2.0 x 0.5 mm	<b>14-472.036</b>	1	8	0,015 kg
	2 NO	Momentary	Universal 2.0 x 0.5 mm	<b>14-431.036</b>	1	9	0,015 kg
		Maintained	Universal 2.0 x 0.5 mm	<b>14-471.036</b>	1	10	0,015 kg
Snap-action switching element	1 NC + 1 NO	Momentary	Solder	<b>14-131.0252</b>		11	0,013 kg
		Momentary	Solder 2.8 x 0.5 mm	<b>14-131.022</b>		19	0,013 kg
		Maintained	Solder	<b>14-271.0252</b>		12	0,013 kg
		Momentary	Solder 2.8 x 0.5 mm	<b>14-271.022</b>		20	0,013 kg
	2 NC + 2 NO	Momentary	Solder	<b>14-132.0252</b>		13	0,013 kg
		Maintained	Solder	<b>14-272.0252</b>		14	0,013 kg
	3 NC + 3 NO	Momentary	Solder	<b>14-133.0252</b>		15	0,013 kg
Snap-action switching element	3 NC + 3 NO	Maintained	Solder	<b>14-273.0252</b>		16	0,013 kg
		Momentary	Solder	<b>14-134.0252</b>		17	0,013 kg
	4 NC + 4 NO	Maintained	Solder	<b>14-274.0252</b>		18	0,013 kg

Contacts: NC = Normally closed, NO = Normally open  
 The component layouts you will find from page 110

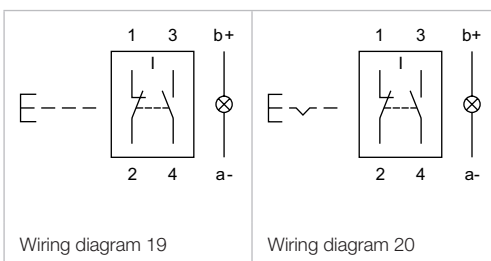
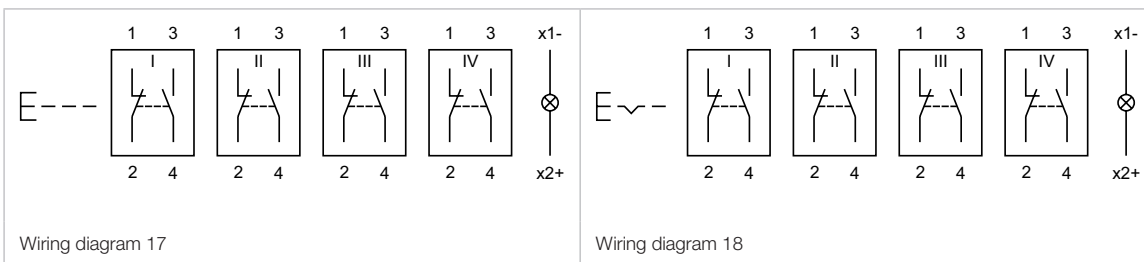
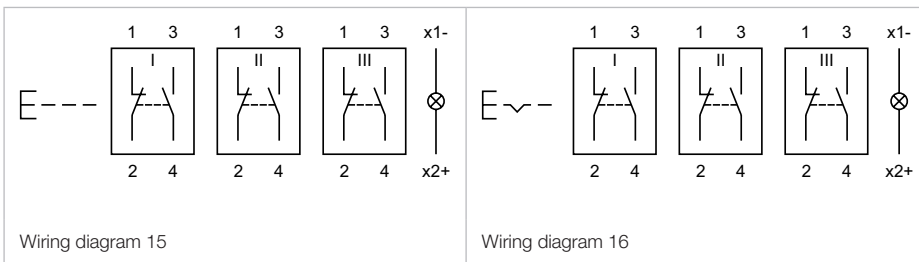
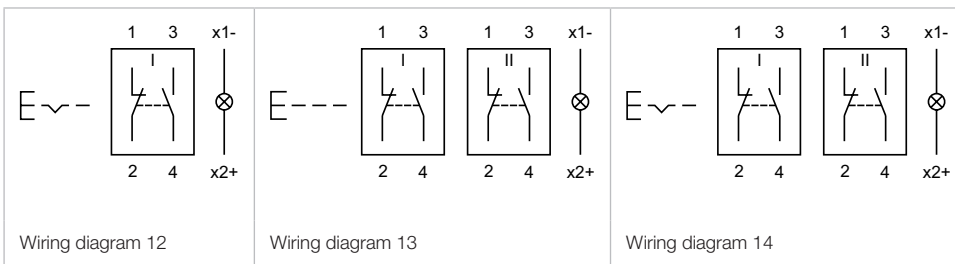
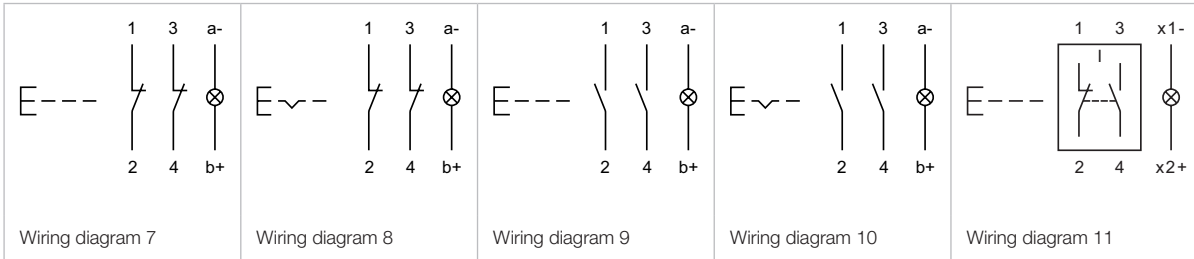
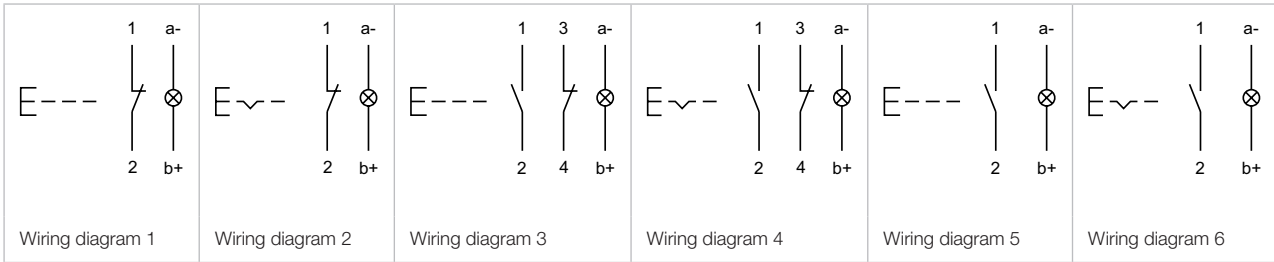

# 14 Flush design

## Illuminated mushroom head pushbutton, IP67



Product can differ from the current configuration.

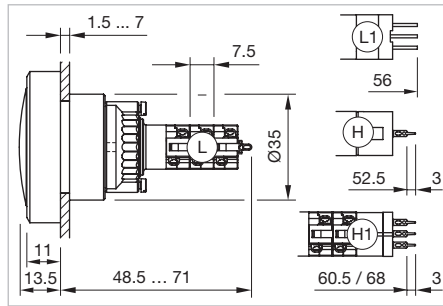

Dimensions [mm]  
 L = Solder terminal,  
 L1 = Solder/Plug-in terminal 2.8 x 0.5 mm,  
 H = Universal terminal 2.0 x 0.5 mm,  
 H1 = Universal-Solder terminal

### Additional Information

- For front dimension Ø 50 mm
- For LED element fitting information see «Application guidelines, LED polarity»
- To obtain IP 67 use marking plate Part No. 704.609.9

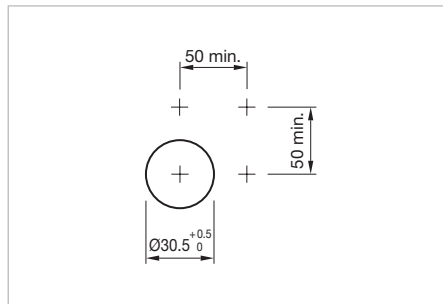

Mounting cut-outs [mm]

### Equipment consisting of (schematic overview)

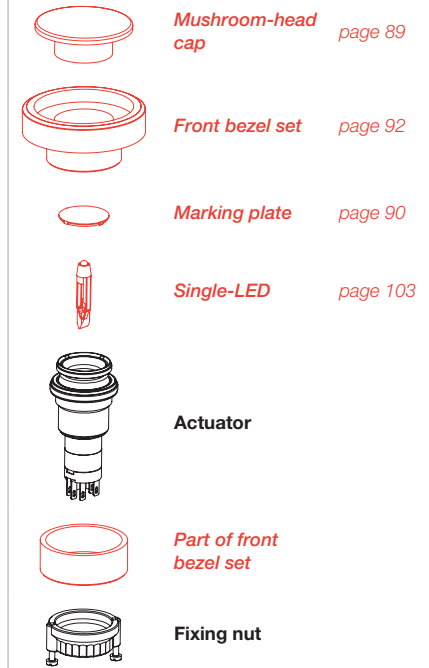

Each Part Number listed below includes all the black components shown in the 3D-drawing.

To obtain a complete unit, please select the red components from the pages shown.

Switching system	Contacts	Switching action	Terminal	Diode 1N4007	Part No.	Component layout	Wiring diagram	Weight
 <p><b>Mushroom-head pushbutton actuator round, 35 mm</b></p>								
Low-level element	1 NC	Momentary	Universal 2.0 x 0.5 mm		<b>14-436.036</b>	1	1	0,015 kg
		Maintained	Universal 2.0 x 0.5 mm		<b>14-476.036</b>	1	2	0,015 kg
	1 NC + 1 NO	Momentary	Universal 2.0 x 0.5 mm		<b>14-433.036</b>	1	3	0,015 kg
		Maintained	Universal 2.0 x 0.5 mm		<b>14-473.036</b>	1	4	0,015 kg
	1 NO	Momentary	Universal 2.0 x 0.5 mm		<b>14-435.036</b>	1	5	0,015 kg
		Maintained	Universal 2.0 x 0.5 mm		<b>14-475.036</b>	1	6	0,015 kg
	2 NC	Momentary	Universal 2.0 x 0.5 mm		<b>14-432.036</b>	1	7	0,015 kg
		Maintained	Universal 2.0 x 0.5 mm		<b>14-472.036</b>	1	8	0,015 kg
	2 NO	Momentary	Universal 2.0 x 0.5 mm		<b>14-431.036</b>	1	9	0,015 kg
		Maintained	Universal 2.0 x 0.5 mm		<b>14-471.036</b>	1	10	0,015 kg
Snap-action switching element	1 NC + 1 NO	Momentary	Universal 2.0 x 0.5 mm	1	<b>14-743.0292</b>	1	11	0,014 kg
		Maintained	Universal 2.0 x 0.5 mm	1	<b>14-747.0292</b>	1	12	0,014 kg
		Momentary	Universal 2.0 x 0.5 mm	2	<b>14-744.0292</b>	1	13	0,014 kg
		Maintained	Universal 2.0 x 0.5 mm	2	<b>14-748.0292</b>	1	14	0,014 kg
		Momentary	Solder		<b>14-131.0252</b>		15	0,013 kg
		Momentary	Solder 2.8 x 0.5 mm		<b>14-131.022</b>		24	0,013 kg
		Maintained	Solder		<b>14-271.0252</b>		16	0,013 kg
		Maintained	Solder 2.8 x 0.5 mm		<b>14-271.022</b>		25	0,013 kg

Switching system	Contacts	Switching action	Terminal	Diode 1N4007	Part No.	Component layout	Wiring diagram	Weight
Snap-action switching element	2 NC + 2 NO	Momentary	Universal 2.0 x 0.5 mm	2	<b>14-746.0292</b>	1	17	0,014 kg
		Momentary	Solder		<b>14-132.0252</b>		18	0,013 kg
		Maintained	Solder		<b>14-272.0252</b>		19	0,013 kg
	3 NC + 3 NO	Momentary	Solder		<b>14-133.0252</b>		20	0,013 kg
		Maintained	Solder		<b>14-273.0252</b>		21	0,013 kg
	4 NC + 4 NO	Momentary	Solder		<b>14-134.0252</b>		22	0,013 kg
Maintained		Solder		<b>14-274.0252</b>		23	0,013 kg	

Contacts: NC = Normally closed, NO = Normally open  
The component layouts you will find from page 110

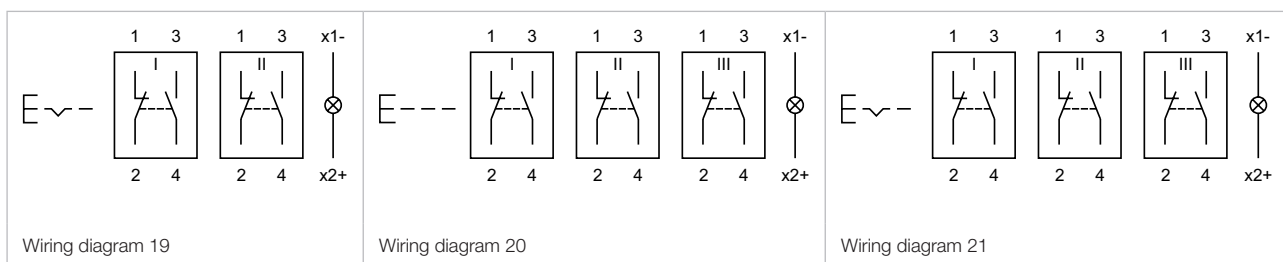
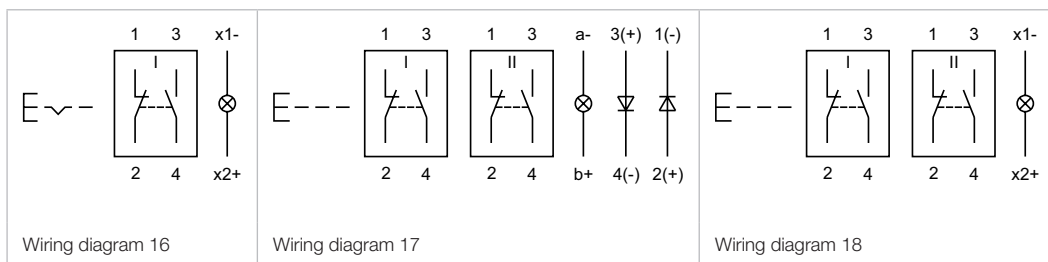
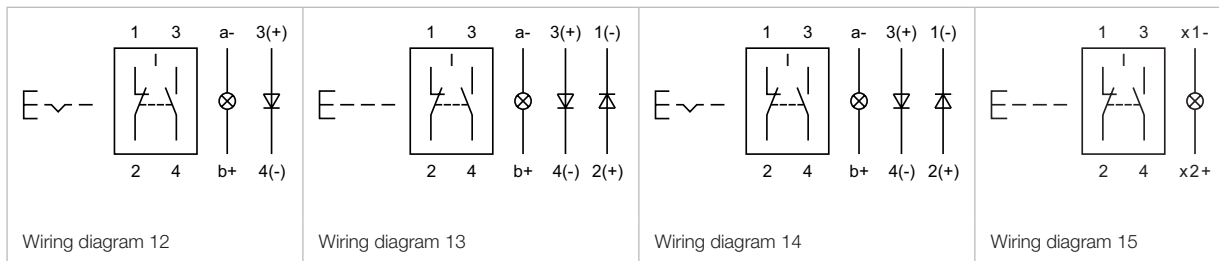
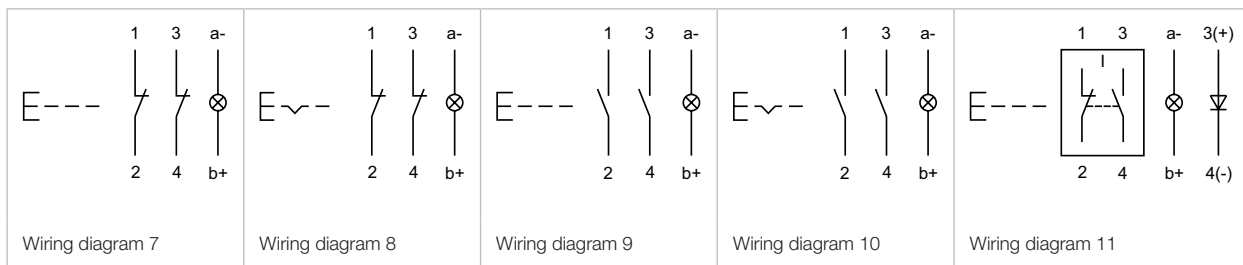
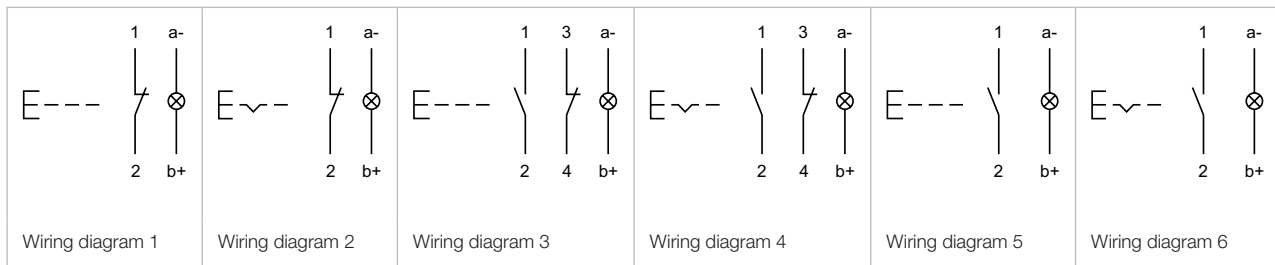

# 14 Flush design

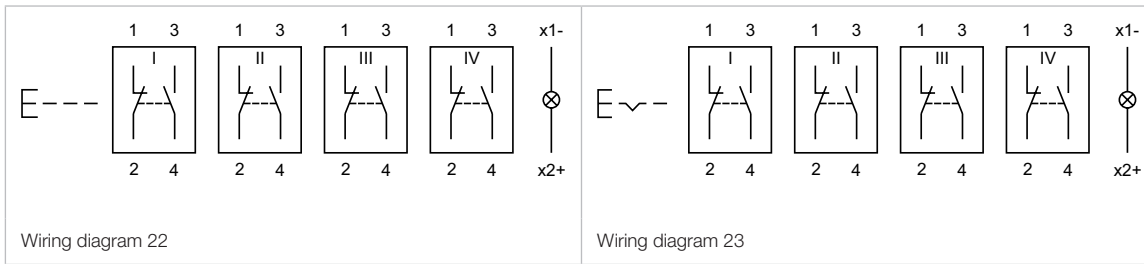

Wiring diagram 22

Wiring diagram 23

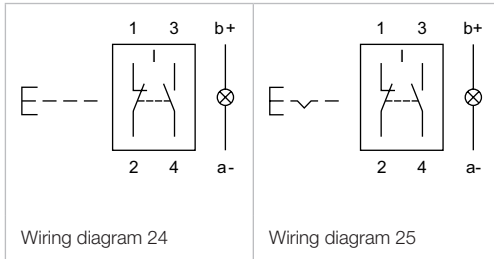

Wiring diagram 24

Wiring diagram 25



## Keylock switch complete, IP65

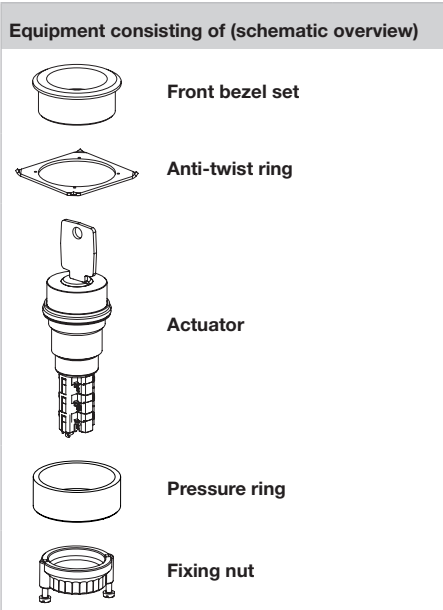

Each Part Number listed below includes all the black components shown in the 3D-drawing.

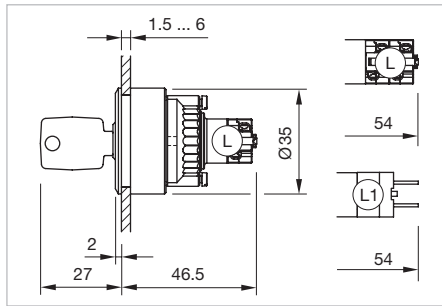

Dimensions [mm]  
 L = Solder terminal,  
 L1 = Solder/Plug-in terminal 2.8 x 0.8 mm



Product can differ from the current configuration.

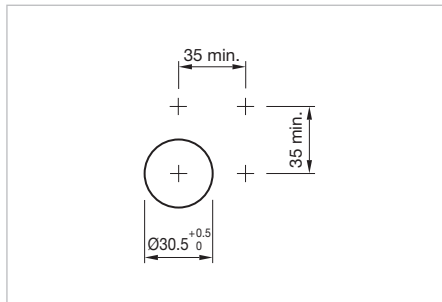



Mounting cut-outs [mm]

### Additional Information

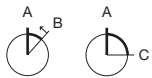

- Lock numbers 1001, lock type KABA
- Two keys are supplied with each keylock switch.
- Optional lock numbers on request



Switching positions (A = Rest, B = Momentary, C = Maintained)

Switching system	Contacts	Switching action	Switching angle	Terminal	Part No.	Wiring diagram	Weight
	<b>Keylock switch, Front dimension Ø 35 mm</b>						
Snap-action switching element	1 NC + 1 NO	Rest(a) - Maintain	90° right	Soldering terminal	<b>K14-235.22200</b>	1	0,044 kg
	<b>Keylock switch, Front dimension Ø 35 mm</b>						
Snap-action switching element	2 NC + 2 NO	Rest(a) - Maintain(a)	90° right	Soldering terminal	<b>K14-136.22200</b>	2	0,044 kg
	<b>Keylock switch, Front dimension Ø 35 mm</b>						
Snap-action switching element	1 NC + 1 NO	Rest(a) - Maintain(a)	90° right	Soldering terminal	<b>K14-135.22200</b>	1	0,044 kg
		Rest(a) - Momentary	42° right	Soldering terminal	<b>K14-141.22100</b>	3	0,044 kg

# 14 Flush design

Switching system	Contacts	Switching action	Switching angle	Terminal	Part No.	Wiring diagram	Weight
 <p><b>Keylock switch, Front dimension Ø 35 mm</b></p>							
Snap-action switching element	2 NC + 2 NO	Rest(a) - Maintain	90° right	Soldering terminal	<b>K14-236.22200</b>	2	0,044 kg
 <p><b>Keylock switch, Front dimension Ø 35 mm</b></p>							
Snap-action switching element	1 NC + 1 NO	Rest(a) - Maintain	90° right	Solder/Plug-in 2.8 x 0.8 mm	<b>K14-235.21200</b>	1	0,044 kg
Snap-action switching element	1 NC + 1 NO	Rest(a) - Maintain(a)	90° right	Solder/Plug-in 2.8 x 0.8 mm	<b>K14-135.21200</b>	1	0,044 kg

Contacts: NC = Normally closed, NO = Normally open

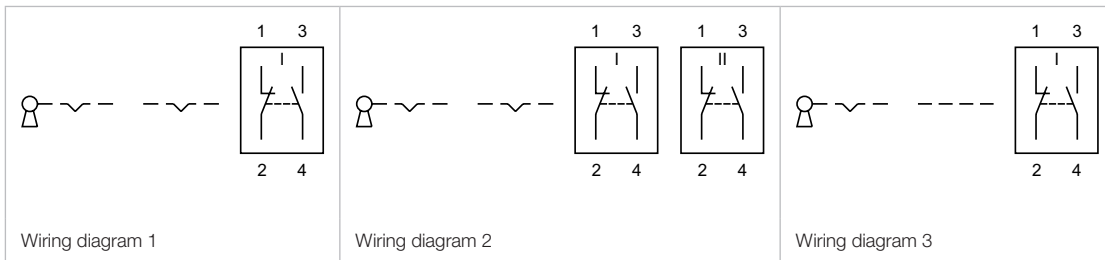

## Keylock switch 2 positions, IP65

### Equipment consisting of (schematic overview)

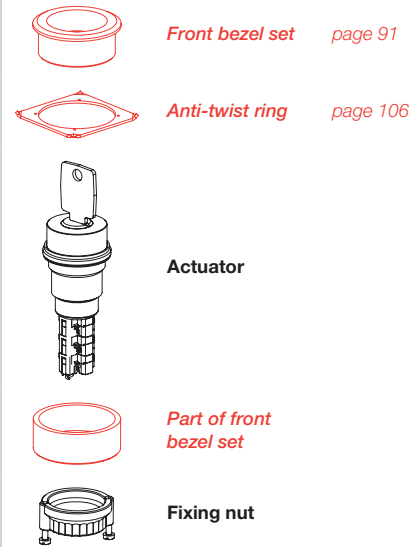

Each Part Number listed below includes all the black components shown in the 3D-drawing.

To obtain a complete unit, please select the red components from the pages shown.

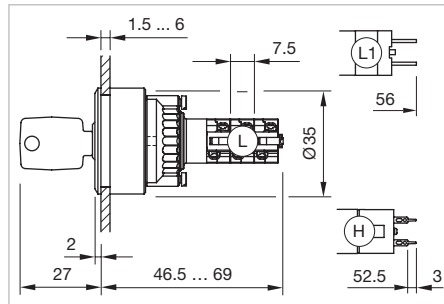

Dimensions [mm]  
 L = Solder terminal,  
 L1 = Solder/Plug-in terminal 2.8 x 0.5 mm,  
 H = Universal terminal 2.0 x 0.5 mm



Product can differ from the current configuration.

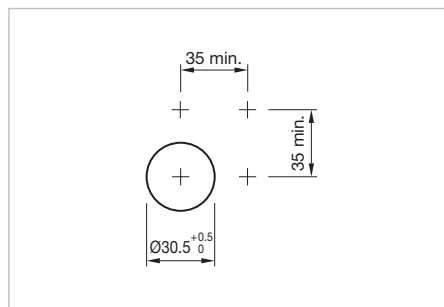



Mounting cut-outs [mm]

### Additional Information

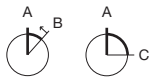





- Front plastic black
- For front dimension Ø 35 mm
- Lock numbers 1001, lock type KABA
- Two keys are supplied with each keylock switch.
- Optional lock numbers on request



Switching positions (A = Rest, B = Momentary, C = Maintained)

Switching system	Contacts	Switching action	Switching angle	Terminal	Part No.	Component layout	Wiring diagram	Weight		
 <p><b>Keylock switch actuator 2 positions, Front dimension Ø 35 mm</b></p>										
Low-level element	2 NO	Rest(a) - Momentary	42° right	Universal 2.0 x 0.5 mm	<b>14-437.036K</b>	1	1	0,030 kg		
	1 NC + 1 NO	Rest(a) - Momentary	42° right	Universal 2.0 x 0.5 mm	<b>14-438.036K</b>	1	2	0,030 kg		
		Rest(a) - Maintain(a)	90° right	Universal 2.0 x 0.5 mm	<b>14-412.036K</b>	1	3	0,030 kg		
		Rest(a) - Maintain	90° right	Universal 2.0 x 0.5 mm	<b>14-415.036K</b>	1	3	0,030 kg		
		Rest - Maintain(a)	90° right	Universal 2.0 x 0.5 mm	<b>14-418.036K</b>	1	3	0,030 kg		
	2 NO	Rest(a) - Maintain(a)	90° right	Universal 2.0 x 0.5 mm	<b>14-411.036K</b>	1	4	0,030 kg		
Rest(a) - Maintain		90° right	Universal 2.0 x 0.5 mm	<b>14-414.036K</b>	1	4	0,030 kg			
Snap-action switching element	1 NC + 1 NO	Rest(a) - Momentary	42° right	Universal 2.0 x 0.5 mm	<b>14-417.036K</b>	1	4	0,030 kg		
		 <p><b>Keylock switch actuator 2 positions, Front dimension Ø 35 mm</b></p>								
		Rest(a) - Momentary	42° right	Solder 2.8 x 0.5 mm	<b>14-141.022K</b>		5	0,029 kg		
 <p><b>Keylock switch actuator 2 positions, Front dimension Ø 35 mm</b></p>										
Snap-action switching element	1 NC + 1 NO	Rest(a) - Momentary	42° right	Solder	<b>14-141.025K2</b>		5	0,029 kg		

# 14 Flush design

Switching system	Contacts	Switching action	Switching angle	Terminal	Part No.	Component layout	Wiring diagram	Weight
 <p><b>Keylock switch actuator 2 positions, Front dimension Ø 35 mm</b></p>								
Snap-action switching element	2 NC + 2 NO	Rest(a) - Momentary	42° right	Solder	<b>14-142.025K2</b>		6	0,031 kg
 <p><b>Keylock switch actuator 2 positions, Front dimension Ø 35 mm</b></p>								
Snap-action switching element	3 NC + 3 NO	Rest(a) - Momentary	42° right	Solder	<b>14-143.025K2</b>		7	0,033 kg
 <p><b>Keylock switch actuator 2 positions, Front dimension Ø 35 mm</b></p>								
Snap-action switching element	1 NC + 1 NO	Rest(a) - Maintain(a)	90° right	Solder	<b>14-135.025K2</b>		9	0,029 kg
		Rest(a) - Maintain	90° right	Solder	<b>14-235.025K2</b>		9	0,029 kg
		Rest - Maintain(a)	90° right	Solder	<b>14-335.025K2</b>		9	0,029 kg
 <p><b>Keylock switch actuator 2 positions, Front dimension Ø 35 mm</b></p>								
Snap-action switching element	1 NC + 1 NO	Rest(a) - Maintain(a)	90° right	Solder 2.8 x 0.5 mm	<b>14-135.022K</b>		9	0,029 kg
		Rest(a) - Maintain	90° right	Solder 2.8 x 0.5 mm	<b>14-235.022K</b>		9	0,029 kg
		Rest - Maintain(a)	90° right	Solder 2.8 x 0.5 mm	<b>14-335.022K</b>		9	0,029 kg
 <p><b>Keylock switch actuator 2 positions, Front dimension Ø 35 mm</b></p>								
Snap-action switching element	2 NC + 2 NO	Rest(a) - Maintain(a)	90° right	Solder	<b>14-136.025K2</b>		10	0,031 kg
		Rest(a) - Maintain	90° right	Solder	<b>14-236.025K2</b>		10	0,031 kg
		Rest - Maintain(a)	90° right	Solder	<b>14-336.025K2</b>		10	0,031 kg
 <p><b>Keylock switch actuator 2 positions, Front dimension Ø 35 mm</b></p>								
Snap-action switching element	3 NC + 3 NO	Rest(a) - Maintain(a)	90° right	Solder	<b>14-137.025K2</b>		11	0,033 kg
		Rest(a) - Maintain	90° right	Solder	<b>14-237.025K2</b>		11	0,033 kg
		Rest - Maintain(a)	90° right	Solder	<b>14-337.025K2</b>		11	0,033 kg
 <p><b>Keylock switch actuator 2 positions, Front dimension Ø 35 mm</b></p>								
Snap-action switching element	4 NC + 4 NO	Rest(a) - Maintain(a)	90° right	Solder	<b>14-138.025K2</b>		12	0,035 kg
		Rest(a) - Maintain	90° right	Solder	<b>14-238.025K2</b>		12	0,035 kg
		Rest - Maintain(a)	90° right	Solder	<b>14-338.025K2</b>		12	0,035 kg

Contacts: NC = Normally closed, NO = Normally open  
 The component layouts you will find from page 110

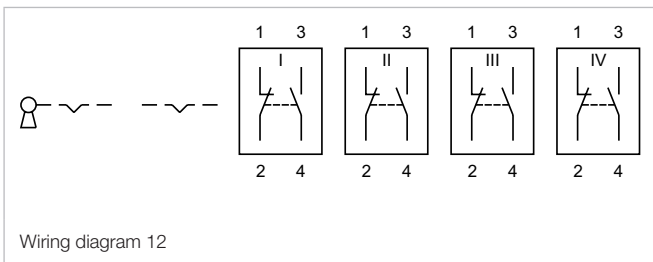
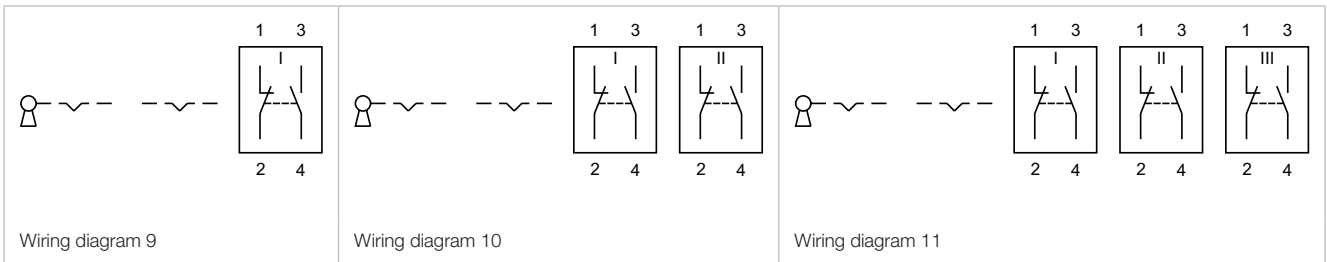
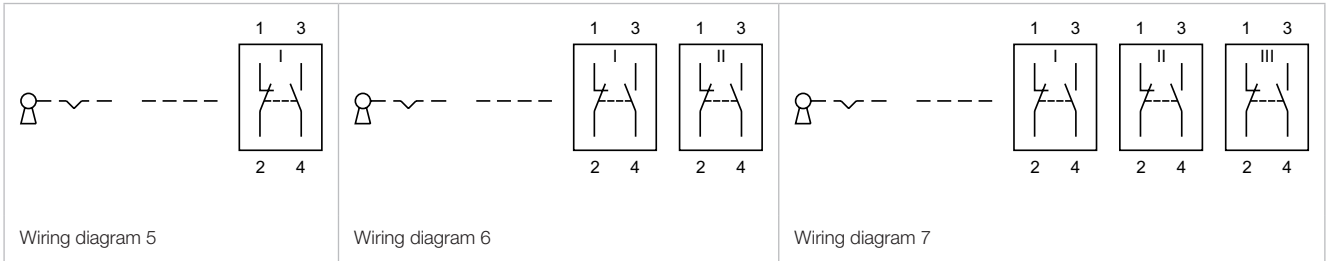
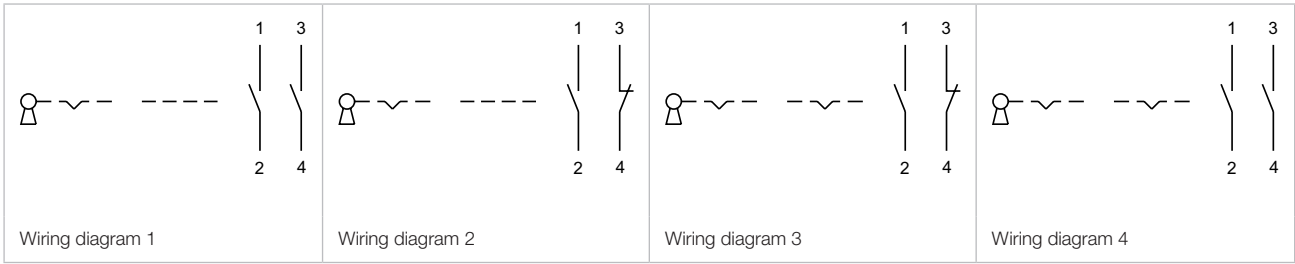

# 14 Flush design

## Selector switch 2 positions complete, IP67



Product can differ from the current configuration.

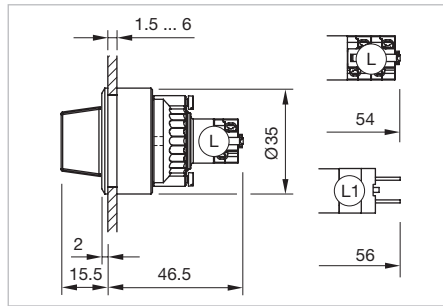

Dimensions [mm]  
 L = Solder terminal,  
 L1 = Solder/Plug-in terminal 2.8 x 0.5 mm,  
 H = Universal terminal 2.0 x 0.5 mm

### Equipment consisting of (schematic overview)

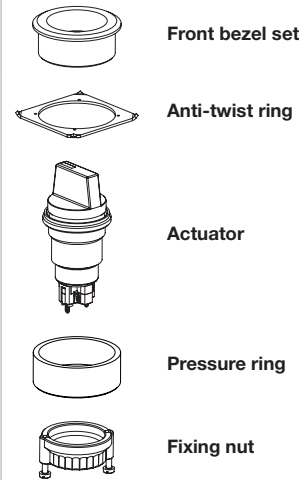

Each Part Number listed below includes all the black components shown in the 3D-drawing.

### Additional Information

- For front dimension Ø 35 mm
- non-illuminative

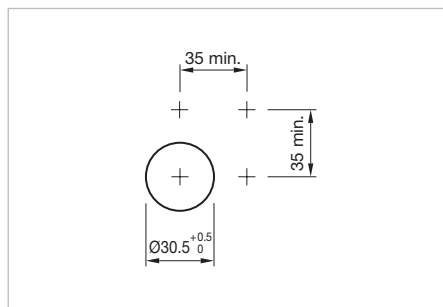

Mounting cut-outs [mm]

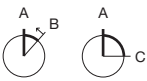

Switching positions (A = Rest, B = Momentary, C = Maintained)

Lever	Switching system	Contacts	Switching action	Switching angle	Terminal	Part No.	Wiring diagram	Weight
	<b>Selector switch actuator 2 positions, Front dimension Ø 35 mm</b>							
Plastic black short	Snap-action switching element	1 NC + 1 NO	Rest - Maintain	90° right	Solder/Plug-in 2.8 x 0.8 mm	<b>K14-506.21200</b>	1	0,039 kg
	<b>Selector switch actuator 2 positions, Front dimension Ø 35 mm</b>							
Plastic black short	Snap-action switching element	1 NC + 1 NO	Rest - Maintain	90° right	Soldering terminal	<b>K14-506.22200</b>	1	0,039 kg
	<b>Selector switch actuator 2 positions, Front dimension Ø 35 mm</b>							
Plastic black short	Snap-action switching element	2 NC + 2 NO	Rest - Maintain	90° right	Soldering terminal	<b>K14-507.22200</b>	2	0,041 kg

Contacts: NC = Normally closed, NO = Normally open

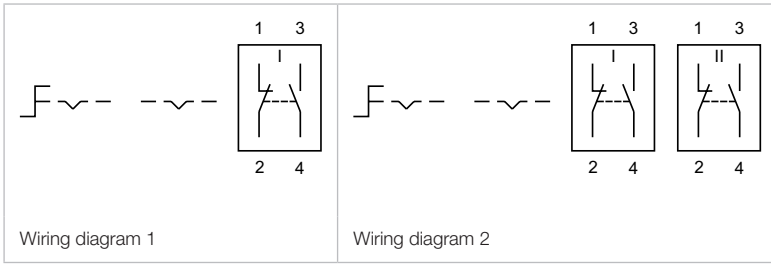

# 14 Flush design

## Selector switch 2 positions, IP67



Product can differ from the current configuration.

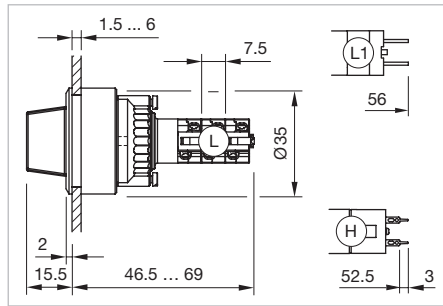

Dimensions [mm]  
 L = Solder terminal,  
 L1 = Solder/Plug-in terminal 2.8 x 0.5 mm,  
 H = Universal terminal 2.0 x 0.5 mm

### Additional Information

- For front dimension  $\varnothing 35$  mm
- non-illuminative

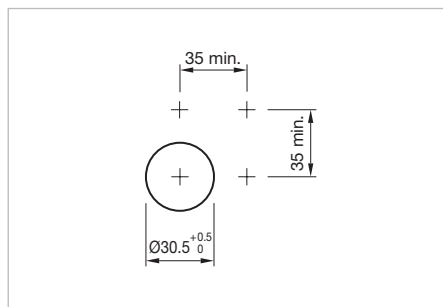

Mounting cut-outs [mm]

### Equipment consisting of (schematic overview)

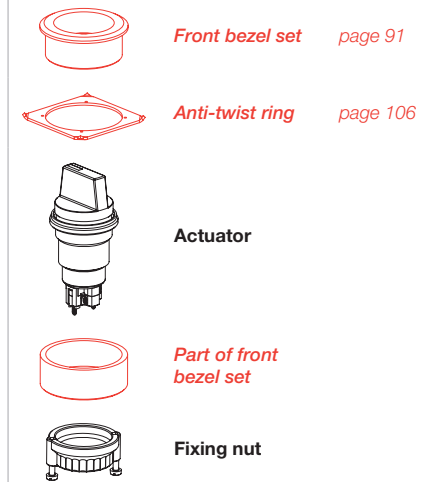



Each Part Number listed below includes all the black components shown in the 3D-drawing.

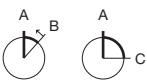





To obtain a complete unit, please select the red components from the pages shown.



Switching positions (A = Rest, B = Momentary, C = Maintained)

Lever	Switching system	Contacts	Switching action	Switching angle	Terminal	Part No.	Component layout	Wiring diagram	Weight
 <p><b>Selector switch actuator 2 positions, Front dimension <math>\varnothing 35</math> mm</b></p>									
Plastic black short	Low-level element	1 NC + 1 NO	Rest - Momentary	42° right	Universal 2.0 x 0.5 mm	<b>14-517.0360</b>	1	1	0,025 kg
Plastic black short	Low-level element	1 NC + 1 NO	Rest - Maintain	90° right	Universal 2.0 x 0.5 mm	<b>14-522.0360</b>	1	2	0,025 kg
Plastic black short	Low-level element	2 NC	Rest - Maintain	90° right	Universal 2.0 x 0.5 mm	<b>14-521.0360</b>	1	3	0,025 kg
Plastic black short	Low-level element	2 NO	Rest - Momentary	42° right	Universal 2.0 x 0.5 mm	<b>14-515.0360</b>	1	4	0,025 kg
Plastic black short	Low-level element	2 NO	Rest - Maintain	90° right	Universal 2.0 x 0.5 mm	<b>14-520.0360</b>	1	5	0,025 kg
 <p><b>Selector switch actuator 2 positions, Front dimension <math>\varnothing 35</math> mm</b></p>									
Plastic black short	Shap-action switching element	1 NC + 1 NO	Rest - Momentary	42° right	Solder 2.8 x 0.5 mm	<b>14-501.0220</b>		6	0,024 kg



Lever	Switching system	Contacts	Switching action	Switching angle	Terminal	Part No.	Component layout	Wiring diagram	Weight
	<b>Selector switch actuator 2 positions, Front dimension Ø 35 mm</b>								
Plastic black short	Snap-action switching element	1 NC + 1 NO	Rest - Momentary	42° right	Solder	<b>14-501.02502</b>		6	0,024 kg
	<b>Selector switch actuator 2 positions, Front dimension Ø 35 mm</b>								
Plastic black short	Snap-action switching element	1 NC + 1 NO	Rest - Maintain	90° right	Solder 2.8 x 0.5 mm	<b>14-506.0220</b>		7	0,024 kg
	<b>Selector switch actuator 2 positions, Front dimension Ø 35 mm</b>								
Plastic black short	Snap-action switching element	1 NC + 1 NO	Rest - Maintain	90° right	Solder	<b>14-506.02502</b>		7	0,024 kg
	<b>Selector switch actuator 2 positions, Front dimension Ø 35 mm</b>								
Plastic black short	Snap-action switching element	2 NC + 2 NO	Rest - Momentary	42° right	Solder	<b>14-502.02502</b>		8	0,026 kg
Plastic black short	Snap-action switching element	2 NC + 2 NO	Rest - Maintain	90° right	Solder	<b>14-507.02502</b>		9	0,026 kg
	<b>Selector switch actuator 2 positions, Front dimension Ø 35 mm</b>								
Plastic black short	Snap-action switching element	3 NC + 3 NO	Rest - Maintain	90° right	Solder	<b>14-508.02502</b>		11	0,028 kg
	<b>Selector switch actuator 2 positions, Front dimension Ø 35 mm</b>								
Plastic black short	Snap-action switching element	4 NC + 4 NO	Rest - Maintain	90° right	Solder	<b>14-509.02502</b>		12	0,030 kg

Contacts: NC = Normally closed, NO = Normally open  
 The component layouts you will find from page 110

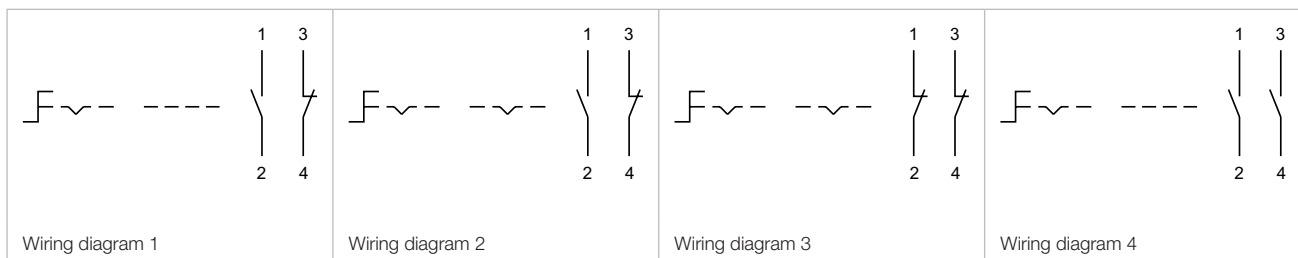

# 14 Flush design

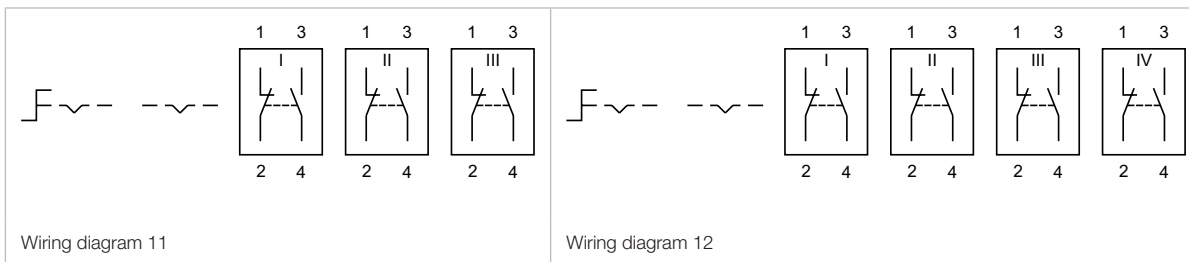
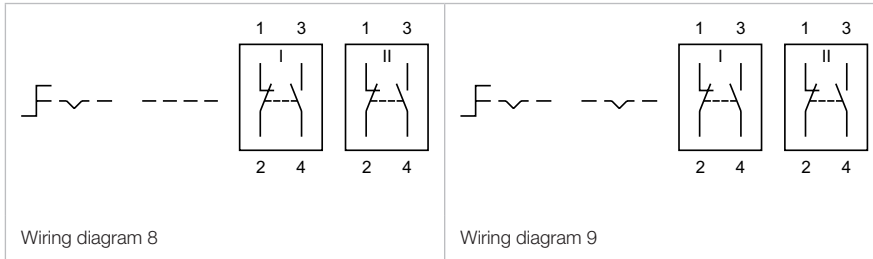
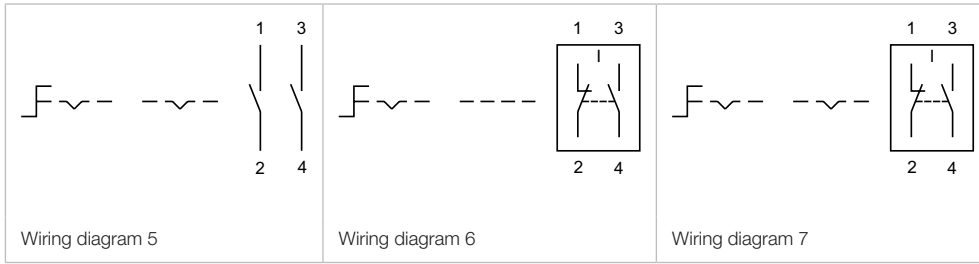

Indicator complete, IP67

Equipment consisting of (schematic overview)

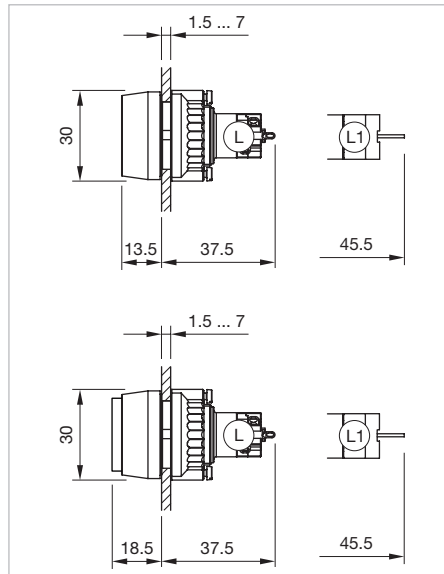
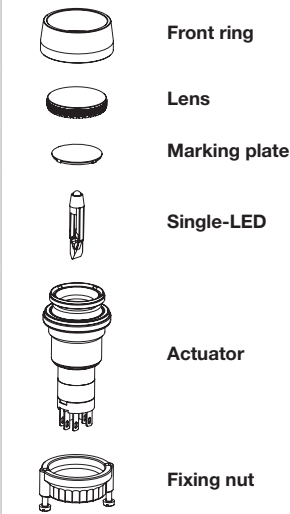



Product can differ from the current configuration.

Each Part Number listed below includes all the black components shown in the 3D-drawing.

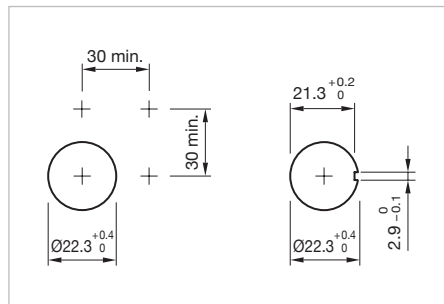







Dimensions [mm]  
L = Solder terminal,  
L1 = Solder/Plug-in terminal 2.8 x 0.8 mm











Mounting cut-outs [mm]











LED colour	Operating voltage	Lens profile	Lens colour	Terminal	Part No.	Wiring diagram	Weight
	<b>Indicator, Front dimension Ø 29 mm</b>						
red	24 VAC/DC	flush	red	Solder/Plug-in 2.8 x 0.8 mm	<b>K14-040.110101</b>	1	0.021 kg
	<b>Indicator, Front dimension Ø 29 mm</b>						
red	24 VAC/DC	raised	red	Solder/Plug-in 2.8 x 0.8 mm	<b>K14-040.110051</b>	1	0.021 kg
	<b>Indicator, Front dimension Ø 29 mm</b>						
yellow	24 VAC/DC	flush	yellow	Solder/Plug-in 2.8 x 0.8 mm	<b>K14-040.110071</b>	1	0.021 kg









# 14 Raised design

LED colour	Operating voltage	Lens profile	Lens colour	Terminal	Part No.	Wiring diagram	Weight
	<b>Indicator, Front dimension Ø 29 mm</b>						
yellow	24 VAC/DC	raised	yellow	Solder/Plug-in 2.8 x 0.8 mm	<b>K14-040.110021</b>	1	0.021 kg
	<b>Indicator, Front dimension Ø 29 mm</b>						
green	24 VAC/DC	flush	green	Solder/Plug-in 2.8 x 0.8 mm	<b>K14-040.110081</b>	1	0.021 kg
	<b>Indicator, Front dimension Ø 29 mm</b>						
green	24 VAC/DC	raised	green	Solder/Plug-in 2.8 x 0.8 mm	<b>K14-040.110031</b>	1	0.021 kg
	<b>Indicator, Front dimension Ø 29 mm</b>						
blue	24 VAC/DC	flush	blue	Solder/Plug-in 2.8 x 0.8 mm	<b>K14-040.110061</b>	1	0.021 kg
	<b>Indicator, Front dimension Ø 29 mm</b>						
blue	24 VAC/DC	raised	blue	Solder/Plug-in 2.8 x 0.8 mm	<b>K14-040.110011</b>	1	0.021 kg
	<b>Indicator, Front dimension Ø 29 mm</b>						
clear	24 VAC/DC	flush	clear	Solder/Plug-in 2.8 x 0.8 mm	<b>K14-040.110091</b>	1	0.021 kg
	<b>Indicator, Front dimension Ø 29 mm</b>						
clear	24 VAC/DC	raised	clear	Solder/Plug-in 2.8 x 0.8 mm	<b>K14-040.110041</b>	1	0.021 kg
	<b>Indicator, Front dimension Ø 29 mm</b>						
red	28 VAC/DC	flush	red	Solder/Plug-in 2.8 x 0.8 mm	<b>K14-040.110102</b>	1	0.021 kg
	<b>Indicator, Front dimension Ø 29 mm</b>						
red	28 VAC/DC	raised	red	Solder/Plug-in 2.8 x 0.8 mm	<b>K14-040.110052</b>	1	0.021 kg

LED colour	Operating voltage	Lens profile	Lens colour	Terminal	Part No.	Wiring diagram	Weight
 <p><b>Indicator, Front dimension Ø 29 mm</b></p>							
yellow	28 VAC/DC	flush	yellow	Solder/Plug-in 2.8 x 0.8 mm	<b>K14-040.110072</b>	1	0.021 kg
 <p><b>Indicator, Front dimension Ø 29 mm</b></p>							
yellow	28 VAC/DC	raised	yellow	Solder/Plug-in 2.8 x 0.8 mm	<b>K14-040.110022</b>	1	0.021 kg
 <p><b>Indicator, Front dimension Ø 29 mm</b></p>							
green	28 VAC/DC	flush	green	Solder/Plug-in 2.8 x 0.8 mm	<b>K14-040.110082</b>	1	0.021 kg
 <p><b>Indicator, Front dimension Ø 29 mm</b></p>							
green	28 VAC/DC	raised	green	Solder/Plug-in 2.8 x 0.8 mm	<b>K14-040.110032</b>	1	0.021 kg
 <p><b>Indicator, Front dimension Ø 29 mm</b></p>							
blue	28 VAC/DC	flush	blue	Solder/Plug-in 2.8 x 0.8 mm	<b>K14-040.110062</b>	1	0.021 kg
 <p><b>Indicator, Front dimension Ø 29 mm</b></p>							
blue	28 VAC/DC	raised	blue	Solder/Plug-in 2.8 x 0.8 mm	<b>K14-040.110012</b>	1	0.021 kg
 <p><b>Indicator, Front dimension Ø 29 mm</b></p>							
clear	28 VAC/DC	flush	clear	Solder/Plug-in 2.8 x 0.8 mm	<b>K14-040.110092</b>	1	0.021 kg
 <p><b>Indicator, Front dimension Ø 29 mm</b></p>							
clear	28 VAC/DC	raised	clear	Solder/Plug-in 2.8 x 0.8 mm	<b>K14-040.110042</b>	1	0.021 kg
 <p><b>Indicator, Front dimension Ø 29 mm</b></p>							
red	24 VAC/DC	flush	red	Soldering terminal	<b>K14-040.120101</b>	2	0.021 kg

# 14 Raised design

LED colour	Operating voltage	Lens profile	Lens colour	Terminal	Part No.	Wiring diagram	Weight
	<b>Indicator, Front dimension Ø 29 mm</b>						
red	24 VAC/DC	raised	red	Soldering terminal	<b>K14-040.120051</b>	2	0.021 kg
	<b>Indicator, Front dimension Ø 29 mm</b>						
yellow	24 VAC/DC	flush	yellow	Soldering terminal	<b>K14-040.120071</b>	2	0.021 kg
	<b>Indicator, Front dimension Ø 29 mm</b>						
yellow	24 VAC/DC	raised	yellow	Soldering terminal	<b>K14-040.120021</b>	2	0.021 kg
	<b>Indicator, Front dimension Ø 29 mm</b>						
green	24 VAC/DC	flush	green	Soldering terminal	<b>K14-040.120081</b>	2	0.021 kg
	<b>Indicator, Front dimension Ø 29 mm</b>						
green	24 VAC/DC	raised	green	Soldering terminal	<b>K14-040.120031</b>	2	0.021 kg
	<b>Indicator, Front dimension Ø 29 mm</b>						
blue	24 VAC/DC	flush	blue	Soldering terminal	<b>K14-040.120061</b>	2	0.021 kg
	<b>Indicator, Front dimension Ø 29 mm</b>						
blue	24 VAC/DC	raised	blue	Soldering terminal	<b>K14-040.120011</b>	2	0.021 kg
	<b>Indicator, Front dimension Ø 29 mm</b>						
clear	24 VAC/DC	flush	clear	Soldering terminal	<b>K14-040.120091</b>	2	0.021 kg
	<b>Indicator, Front dimension Ø 29 mm</b>						
clear	24 VAC/DC	raised	clear	Soldering terminal	<b>K14-040.120041</b>	2	0.021 kg
	<b>Indicator, Front dimension Ø 29 mm</b>						
red	28 VAC/DC	flush	red	Soldering terminal	<b>K14-040.120102</b>	2	0.021 kg

LED colour	Operating voltage	Lens profile	Lens colour	Terminal	Part No.	Wiring diagram	Weight
	<b>Indicator, Front dimension Ø 29 mm</b>						
red	28 VAC/DC	raised	red	Soldering terminal	<b>K14-040.120052</b>	2	0.021 kg
	<b>Indicator, Front dimension Ø 29 mm</b>						
yellow	28 VAC/DC	flush	yellow	Soldering terminal	<b>K14-040.120072</b>	2	0.021 kg
	<b>Indicator, Front dimension Ø 29 mm</b>						
yellow	28 VAC/DC	raised	yellow	Soldering terminal	<b>K14-040.120022</b>	2	0.021 kg
	<b>Indicator, Front dimension Ø 29 mm</b>						
green	28 VAC/DC	flush	green	Soldering terminal	<b>K14-040.120082</b>	2	0.021 kg
	<b>Indicator, Front dimension Ø 29 mm</b>						
green	28 VAC/DC	raised	green	Soldering terminal	<b>K14-040.120032</b>	2	0.021 kg
	<b>Indicator, Front dimension Ø 29 mm</b>						
blue	28 VAC/DC	flush	blue	Soldering terminal	<b>K14-040.120062</b>	2	0.021 kg
	<b>Indicator, Front dimension Ø 29 mm</b>						
blue	28 VAC/DC	raised	blue	Soldering terminal	<b>K14-040.120012</b>	2	0.021 kg
	<b>Indicator, Front dimension Ø 29 mm</b>						
clear	28 VAC/DC	flush	clear	Soldering terminal	<b>K14-040.120092</b>	2	0.021 kg
	<b>Indicator, Front dimension Ø 29 mm</b>						
clear	28 VAC/DC	raised	clear	Soldering terminal	<b>K14-040.120042</b>	2	0.021 kg

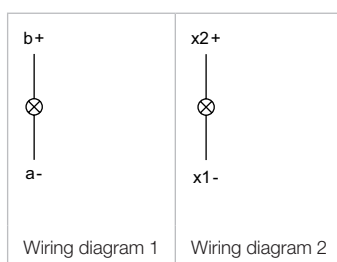

# 14 Raised design

## Indicator full face illumination, IP67



Product can differ from the current configuration.

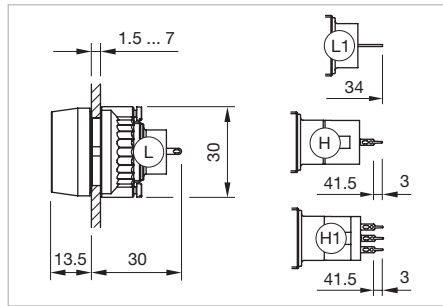

Dimensions [mm]  
 L = Solder terminal,  
 L1 = Solder/Plug-in terminal 2.8 x 0.5 mm,  
 H = Universal terminal 2.0 x 0.5 mm,  
 H1 = Universal-Solder terminal

### Equipment consisting of (schematic overview)

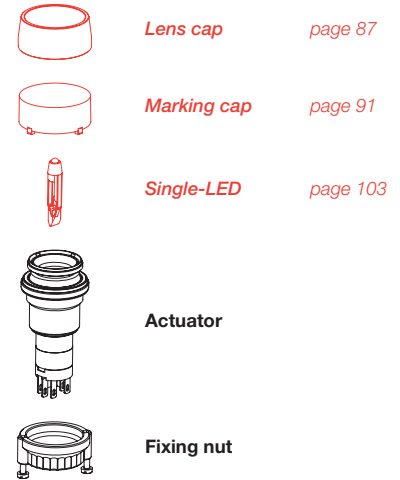

Each Part Number listed below includes all the black components shown in the 3D-drawing.

To obtain a complete unit, please select the red components from the pages shown.

### Additional Information

- For front dimension  $\varnothing$  29 mm
- For LED element fitting information see «Application guidelines, LED polarity»

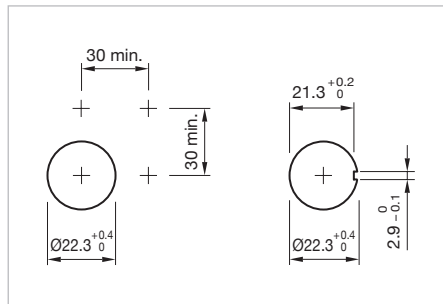

Mounting cut-outs [mm]

Diode 1N4007	Terminal	Part No.	Component layout	Wiring diagram	Weight
	<b>Indicator actuator full-face illumination</b>				
1	Universal 2.0 x 0.5 mm	14-741.006	1	1	0,011 kg
	<b>Indicator actuator full-face illumination</b>				
2	Universal 2.0 x 0.5 mm	14-742.006	1	2	0,011 kg
	<b>Indicator actuator full-face illumination</b>				
	Solder 2.8 x 0.5 mm	14-030.002		3	0,010 kg
	<b>Indicator actuator full-face illumination</b>				
	Solder	14-030.005		3	0,010 kg
	<b>Indicator actuator full-face illumination</b>				
	Universal 2.0 x 0.5 mm	14-031.006	1	3	0,011 kg

The component layouts you will find from page 110



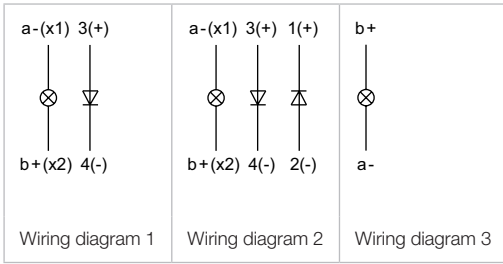

# 14 Raised design

## Indicator front illumination, IP67



Product can differ from the current configuration.

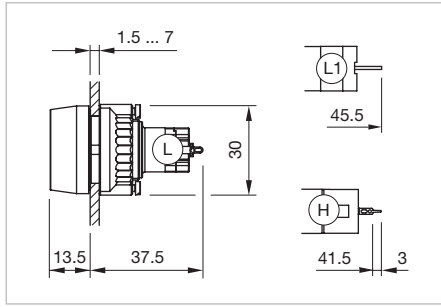

Dimensions [mm]  
 L = Solder terminal,  
 L1 = Solder/Plug-in terminal 2.8 x 0.5 mm,  
 H = Universal terminal 2.0 x 0.5 mm

### Additional Information

- For front dimension  $\varnothing 29$  mm
- For LED element fitting information see «Application guidelines, LED polarity»

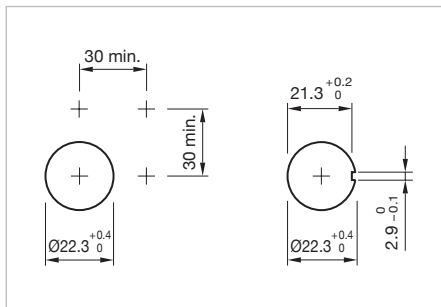

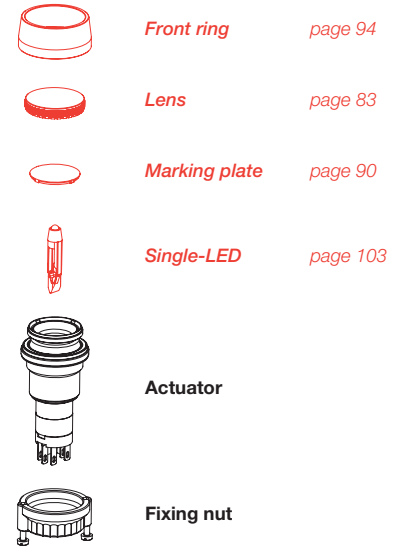

Mounting cut-outs [mm]

### Equipment consisting of (schematic overview)



Each Part Number listed below includes all the black components shown in the 3D-drawing.

*To obtain a complete unit, please select the red components from the pages shown.*

Terminal	Part No.	Component layout	Wiring diagram	Weight
 <p><b>Indicator actuator front illumination</b></p> <p>Solder 2.8 x 0.5 mm</p>	<b>14-040.002</b>	1	1	0,050 kg
 <p><b>Indicator actuator front illumination</b></p> <p>Solder</p>	<b>14-040.005</b>	1	1	0,050 kg
 <p><b>Indicator actuator front illumination</b></p> <p>Universal 2.0 x 0.5 mm</p>	<b>14-041.006</b>	1	1	0,050 kg

The component layouts you will find from page 110

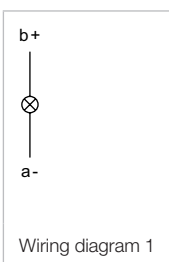

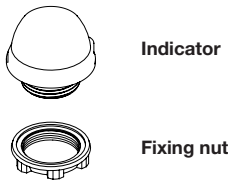

Indicator compact, IP65, IP67, IP69K

Equipment consisting of (schematic overview)

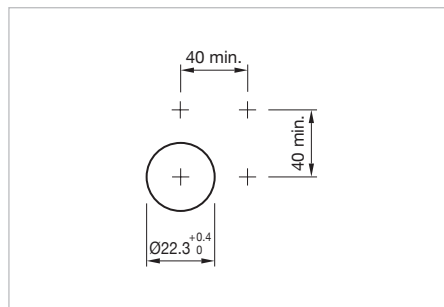
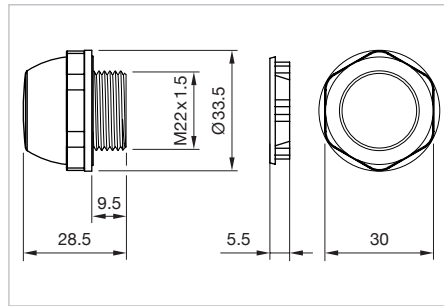

Each Part Number listed below includes all the black components shown in the 3D-drawing.



Operating voltage	Operation current	Illumination	Terminal	Part No.	Wiring diagram	Weight
 <p><b>Indicator compact, Front dimension Ø 33.5 mm</b></p>						
24 VAC/DC	50 mA	red	Push-in Terminal	<b>14-060.207</b>	1	0.012 kg
24 VAC/DC	50 mA	orange	Push-in Terminal	<b>14-060.307</b>	1	0.012 kg
24 VAC/DC	50 mA	green	Push-in Terminal	<b>14-060.507</b>	1	0.012 kg
24 VAC/DC	50 mA	blue	Push-in Terminal	<b>14-060.607</b>	1	0.012 kg
24 VAC/DC	50 mA	white	Push-in Terminal	<b>14-060.907</b>	1	0.012 kg

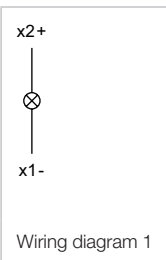

# 14 Raised design

## Buzzer, IP65



Product can differ from the current configuration.

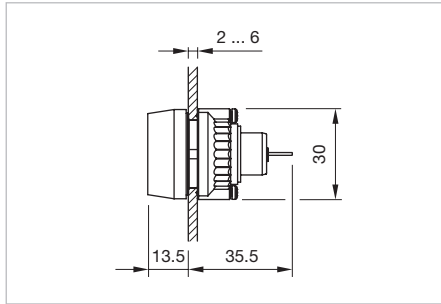

Dimensions [mm]

### Equipment consisting of (schematic overview)

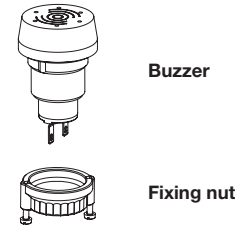



Each Part Number listed below includes all the black components shown in the 3D-drawing.

### Additional Information

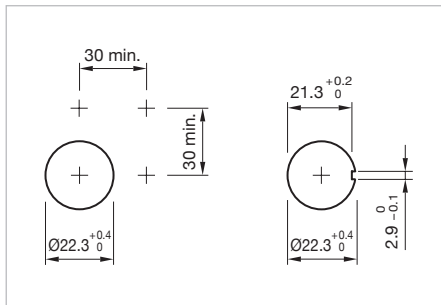
- For PCB application use adaptor Part-No. 31-942
- Further information see «Technical data»



Mounting cut-outs [mm]

Operating voltage	Front cap	Terminal	Part No.	Wiring diagram	Weight
	<b>Buzzer, Front dimension Ø 29 mm</b>				
24 VDC	Plastic black	Solder 2.8 x 0.5 mm	<b>14-810.002</b>	1	0,016 kg
	<b>Buzzer, Front dimension Ø 29 mm</b>				
24 VDC	Brass nickel-plated	Solder 2.8 x 0.5 mm	<b>14-810.902</b>	1	0,016 kg

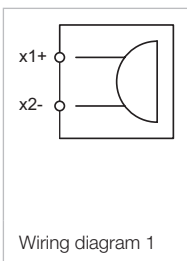

## Pushbutton complete, IP67

### Equipment consisting of (schematic overview)

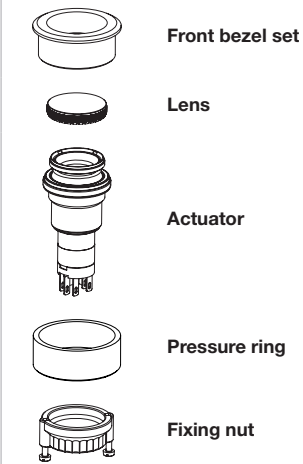

Each Part Number listed below includes all the black components shown in the 3D-drawing.

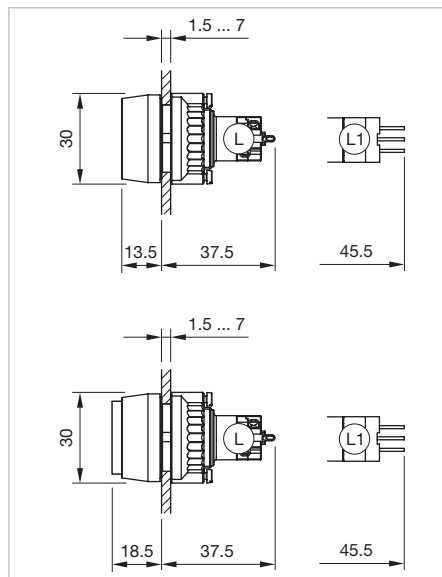



Dimensions [mm]  
 L = Solder terminal,  
 L1 = Solder/Plug-in terminal 2.8 x 0.8 mm



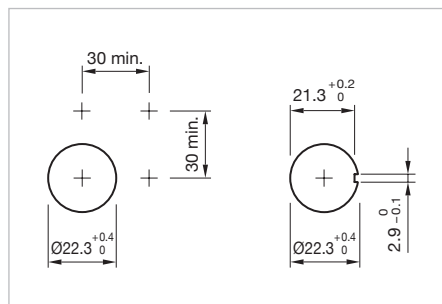







Product can differ from the current configuration.











Mounting cut-outs [mm]

Lens profile	Lens colour	Contacts	Switching action	Terminal	Part No.	Wiring diagram	Weight
	<b>Pushbutton, Front dimension Ø 29 mm</b>						
flush	red anodized	1 NC + 1 NO	Momentary	Solder/Plug-in 2.8 x 0.8 mm	<b>K14-131.111110</b>	1	0.019 kg
	<b>Pushbutton, Front dimension Ø 29 mm</b>						
flush	black anodized	1 NC + 1 NO	Momentary	Solder/Plug-in 2.8 x 0.8 mm	<b>K14-131.111120</b>	1	0.019 kg
	<b>Pushbutton, Front dimension Ø 29 mm</b>						
flush	natural anodized	1 NC + 1 NO	Momentary	Solder/Plug-in 2.8 x 0.8 mm	<b>K14-131.111130</b>	1	0.019 kg

# 14 Raised design

Lens profile	Lens colour	Contacts	Switching action	Terminal	Part No.	Wiring diagram	Weight
	<b>Pushbutton, Front dimension Ø 29 mm</b>						
flush	green anodized	1 NC + 1 NO	Momentary	Solder/Plug-in 2.8 x 0.8 mm	<b>K14-131.111140</b>	1	0.019 kg
	<b>Pushbutton, Front dimension Ø 29 mm</b>						
flush	blue anodized	1 NC + 1 NO	Momentary	Solder/Plug-in 2.8 x 0.8 mm	<b>K14-131.111150</b>	1	0.019 kg
	<b>Pushbutton, Front dimension Ø 29 mm</b>						
flush	red anodized	1 NC + 1 NO	Maintained	Solder/Plug-in 2.8 x 0.8 mm	<b>K14-271.112110</b>	2	0.019 kg
	<b>Pushbutton, Front dimension Ø 29 mm</b>						
flush	black anodized	1 NC + 1 NO	Maintained	Solder/Plug-in 2.8 x 0.8 mm	<b>K14-271.112120</b>	2	0.019 kg
	<b>Pushbutton, Front dimension Ø 29 mm</b>						
flush	natural anodized	1 NC + 1 NO	Maintained	Solder/Plug-in 2.8 x 0.8 mm	<b>K14-271.112130</b>	2	0.019 kg
	<b>Pushbutton, Front dimension Ø 29 mm</b>						
flush	green anodized	1 NC + 1 NO	Maintained	Solder/Plug-in 2.8 x 0.8 mm	<b>K14-271.112140</b>	2	0.019 kg
	<b>Pushbutton, Front dimension Ø 29 mm</b>						
flush	blue anodized	1 NC + 1 NO	Maintained	Solder/Plug-in 2.8 x 0.8 mm	<b>K14-271.112150</b>	2	0.019 kg
	<b>Pushbutton, Front dimension Ø 29 mm</b>						
flush	red anodized	1 NC + 1 NO	Momentary	Soldering terminal	<b>K14-131.121110</b>	1	0.019 kg
	<b>Pushbutton, Front dimension Ø 29 mm</b>						
flush	black anodized	1 NC + 1 NO	Momentary	Soldering terminal	<b>K14-131.121120</b>	1	0.019 kg

Lens profile	Lens colour	Contacts	Switching action	Terminal	Part No.	Wiring diagram	Weight
	<b>Pushbutton, Front dimension Ø 29 mm</b>						
flush	natural anodized	1 NC + 1 NO	Momentary	Soldering terminal	<b>K14-131.121130</b>	1	0.019 kg
	<b>Pushbutton, Front dimension Ø 29 mm</b>						
flush	green anodized	1 NC + 1 NO	Momentary	Soldering terminal	<b>K14-131.121140</b>	1	0.019 kg
	<b>Pushbutton, Front dimension Ø 29 mm</b>						
flush	blue anodized	1 NC + 1 NO	Momentary	Soldering terminal	<b>K14-131.121150</b>	1	0.019 kg
	<b>Pushbutton, Front dimension Ø 29 mm</b>						
flush	red anodized	1 NC + 1 NO	Maintained	Soldering terminal	<b>K14-271.122110</b>	2	0.019 kg
	<b>Pushbutton, Front dimension Ø 29 mm</b>						
flush	black anodized	1 NC + 1 NO	Maintained	Soldering terminal	<b>K14-271.122120</b>	2	0.019 kg
	<b>Pushbutton, Front dimension Ø 29 mm</b>						
flush	natural anodized	1 NC + 1 NO	Maintained	Soldering terminal	<b>K14-271.122130</b>	2	0.019 kg
	<b>Pushbutton, Front dimension Ø 29 mm</b>						
flush	green anodized	1 NC + 1 NO	Maintained	Soldering terminal	<b>K14-271.122140</b>	2	0.019 kg
	<b>Pushbutton, Front dimension Ø 29 mm</b>						
flush	blue anodized	1 NC + 1 NO	Maintained	Soldering terminal	<b>K14-271.122150</b>	2	0.019 kg

Contacts: NC = Normally closed, NO = Normally open

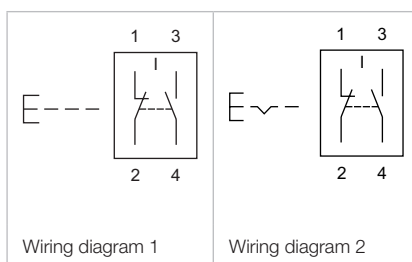

# 14 Raised design

## Illuminated pushbutton complete, IP67



Product can differ from the current configuration.

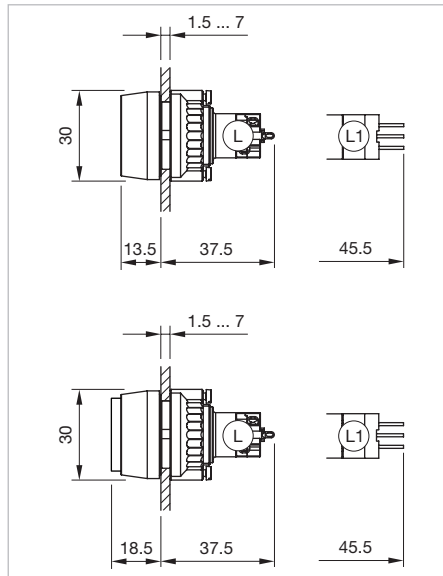

Dimensions [mm]  
L = Solder terminal,  
L1 = Solder/Plug-in terminal 2.8 x 0.5 mm

### Equipment consisting of (schematic overview)

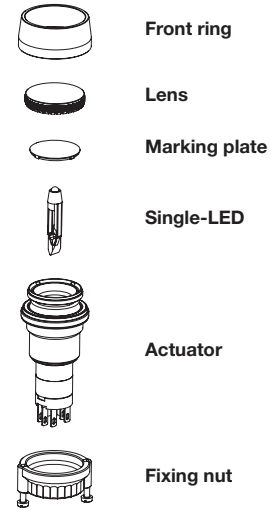



Each Part Number listed below includes all the black components shown in the 3D-drawing.

### Additional Information

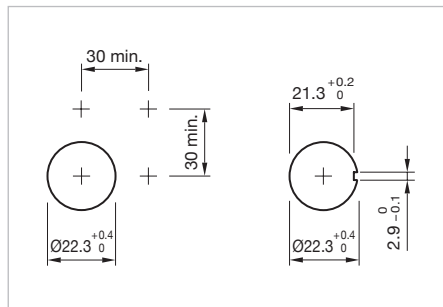







- For front dimension  $\varnothing$  29 mm
- For LED element fitting information see «Application guidelines, LED polarity»











Mounting cut-outs [mm]









LED colour	Operating voltage	Lens profile	Lens colour	Contacts	Switching action	Terminal	Part No.	Wiring diagram	Weight
	<b>Illuminated pushbutton, Front dimension <math>\varnothing</math> 29 mm</b>								
red	24 VAC/DC	flush	red	1 NC + 1 NO	Momentary	Solder/Plug-in 2.8 x 0.8 mm	<b>K14-131.111101</b>	1	0.021 kg
	<b>Illuminated pushbutton, Front dimension <math>\varnothing</math> 29 mm</b>								
red	24 VAC/DC	raised	red	1 NC + 1 NO	Momentary	Solder/Plug-in 2.8 x 0.8 mm	<b>K14-131.111051</b>	1	0.021 kg
	<b>Illuminated pushbutton, Front dimension <math>\varnothing</math> 29 mm</b>								
yellow	24 VAC/DC	flush	yellow	1 NC + 1 NO	Momentary	Solder/Plug-in 2.8 x 0.8 mm	<b>K14-131.111071</b>	1	0.021 kg











LED colour	Operating voltage	Lens profile	Lens colour	Contacts	Switching action	Terminal	Part No.	Wiring diagram	Weight
 <p><b>Illuminated pushbutton, Front dimension Ø 29 mm</b></p>									
yellow	24 VAC/DC	raised	yellow	1 NC + 1 NO	Momentary	Solder/Plug-in 2.8 x 0.8 mm	<b>K14-131.111021</b>	1	0.021 kg
 <p><b>Illuminated pushbutton, Front dimension Ø 29 mm</b></p>									
green	24 VAC/DC	flush	green	1 NC + 1 NO	Momentary	Solder/Plug-in 2.8 x 0.8 mm	<b>K14-131.111081</b>	1	0.021 kg
 <p><b>Illuminated pushbutton, Front dimension Ø 29 mm</b></p>									
green	24 VAC/DC	raised	green	1 NC + 1 NO	Momentary	Solder/Plug-in 2.8 x 0.8 mm	<b>K14-131.111031</b>	1	0.021 kg
 <p><b>Illuminated pushbutton, Front dimension Ø 29 mm</b></p>									
blue	24 VAC/DC	flush	blue	1 NC + 1 NO	Momentary	Solder/Plug-in 2.8 x 0.8 mm	<b>K14-131.111061</b>	1	0.021 kg
 <p><b>Illuminated pushbutton, Front dimension Ø 29 mm</b></p>									
blue	24 VAC/DC	raised	blue	1 NC + 1 NO	Momentary	Solder/Plug-in 2.8 x 0.8 mm	<b>K14-131.111011</b>	1	0.021 kg
 <p><b>Illuminated pushbutton, Front dimension Ø 29 mm</b></p>									
clear	24 VAC/DC	flush	clear	1 NC + 1 NO	Momentary	Solder/Plug-in 2.8 x 0.8 mm	<b>K14-131.111091</b>	1	0.021 kg
 <p><b>Illuminated pushbutton, Front dimension Ø 29 mm</b></p>									
clear	24 VAC/DC	raised	clear	1 NC + 1 NO	Momentary	Solder/Plug-in 2.8 x 0.8 mm	<b>K14-131.111041</b>	1	0.021 kg
 <p><b>Illuminated pushbutton, Front dimension Ø 29 mm</b></p>									
red	28 VAC/DC	flush	red	1 NC + 1 NO	Momentary	Solder/Plug-in 2.8 x 0.8 mm	<b>K14-131.111102</b>	1	0.021 kg
 <p><b>Illuminated pushbutton, Front dimension Ø 29 mm</b></p>									
red	28 VAC/DC	raised	red	1 NC + 1 NO	Momentary	Solder/Plug-in 2.8 x 0.8 mm	<b>K14-131.111052</b>	1	0.021 kg









# 14 Raised design

LED colour	Operating voltage	Lens profile	Lens colour	Contacts	Switching action	Terminal	Part No.	Wiring diagram	Weight
 <p><b>Illuminated pushbutton, Front dimension Ø 29 mm</b></p>									
yellow	28 VAC/DC	flush	yellow	1 NC + 1 NO	Momentary	Solder/Plug-in 2.8 x 0.8 mm	<b>K14-131.111072</b>	1	0.021 kg
 <p><b>Illuminated pushbutton, Front dimension Ø 29 mm</b></p>									
yellow	28 VAC/DC	raised	yellow	1 NC + 1 NO	Momentary	Solder/Plug-in 2.8 x 0.8 mm	<b>K14-131.111022</b>	1	0.021 kg
 <p><b>Illuminated pushbutton, Front dimension Ø 29 mm</b></p>									
green	28 VAC/DC	flush	green	1 NC + 1 NO	Momentary	Solder/Plug-in 2.8 x 0.8 mm	<b>K14-131.111082</b>	1	0.021 kg
 <p><b>Illuminated pushbutton, Front dimension Ø 29 mm</b></p>									
green	28 VAC/DC	raised	green	1 NC + 1 NO	Momentary	Solder/Plug-in 2.8 x 0.8 mm	<b>K14-131.111032</b>	1	0.021 kg
 <p><b>Illuminated pushbutton, Front dimension Ø 29 mm</b></p>									
blue	28 VAC/DC	flush	blue	1 NC + 1 NO	Momentary	Solder/Plug-in 2.8 x 0.8 mm	<b>K14-131.111062</b>	1	0.021 kg
 <p><b>Illuminated pushbutton, Front dimension Ø 29 mm</b></p>									
blue	28 VAC/DC	raised	blue	1 NC + 1 NO	Momentary	Solder/Plug-in 2.8 x 0.8 mm	<b>K14-131.111012</b>	1	0.021 kg
 <p><b>Illuminated pushbutton, Front dimension Ø 29 mm</b></p>									
clear	28 VAC/DC	flush	clear	1 NC + 1 NO	Momentary	Solder/Plug-in 2.8 x 0.8 mm	<b>K14-131.111092</b>	1	0.021 kg
 <p><b>Illuminated pushbutton, Front dimension Ø 29 mm</b></p>									
clear	28 VAC/DC	raised	clear	1 NC + 1 NO	Momentary	Solder/Plug-in 2.8 x 0.8 mm	<b>K14-131.111042</b>	1	0.021 kg
 <p><b>Illuminated pushbutton, Front dimension Ø 29 mm</b></p>									
red	24 VAC/DC	flush	red	1 NC + 1 NO	Maintained	Solder/Plug-in 2.8 x 0.8 mm	<b>K14-271.112101</b>	2	0.021 kg









LED colour	Operating voltage	Lens profile	Lens colour	Contacts	Switching action	Terminal	Part No.	Wiring diagram	Weight
 <p><b>Illuminated pushbutton, Front dimension Ø 29 mm</b></p>									
red	24 VAC/DC	raised	red	1 NC + 1 NO	Maintained	Solder/Plug-in 2.8 x 0.8 mm	<b>K14-271.112051</b>	2	0.021 kg
 <p><b>Illuminated pushbutton, Front dimension Ø 29 mm</b></p>									
yellow	24 VAC/DC	flush	yellow	1 NC + 1 NO	Maintained	Solder/Plug-in 2.8 x 0.8 mm	<b>K14-271.112071</b>	2	0.021 kg
 <p><b>Illuminated pushbutton, Front dimension Ø 29 mm</b></p>									
yellow	24 VAC/DC	raised	yellow	1 NC + 1 NO	Maintained	Solder/Plug-in 2.8 x 0.8 mm	<b>K14-271.112021</b>	2	0.021 kg
 <p><b>Illuminated pushbutton, Front dimension Ø 29 mm</b></p>									
green	24 VAC/DC	flush	green	1 NC + 1 NO	Maintained	Solder/Plug-in 2.8 x 0.8 mm	<b>K14-271.112081</b>	2	0.021 kg
 <p><b>Illuminated pushbutton, Front dimension Ø 29 mm</b></p>									
green	24 VAC/DC	raised	green	1 NC + 1 NO	Maintained	Solder/Plug-in 2.8 x 0.8 mm	<b>K14-271.112031</b>	2	0.021 kg
 <p><b>Illuminated pushbutton, Front dimension Ø 29 mm</b></p>									
blue	24 VAC/DC	flush	blue	1 NC + 1 NO	Maintained	Solder/Plug-in 2.8 x 0.8 mm	<b>K14-271.112061</b>	2	0.021 kg
 <p><b>Illuminated pushbutton, Front dimension Ø 29 mm</b></p>									
blue	24 VAC/DC	raised	blue	1 NC + 1 NO	Maintained	Solder/Plug-in 2.8 x 0.8 mm	<b>K14-271.112011</b>	2	0.021 kg
 <p><b>Illuminated pushbutton, Front dimension Ø 29 mm</b></p>									
clear	24 VAC/DC	flush	clear	1 NC + 1 NO	Maintained	Solder/Plug-in 2.8 x 0.8 mm	<b>K14-271.112091</b>	2	0.021 kg
 <p><b>Illuminated pushbutton, Front dimension Ø 29 mm</b></p>									
clear	24 VAC/DC	raised	clear	1 NC + 1 NO	Maintained	Solder/Plug-in 2.8 x 0.8 mm	<b>K14-271.112041</b>	2	0.021 kg









# 14 Raised design

LED colour	Operating voltage	Lens profile	Lens colour	Contacts	Switching action	Terminal	Part No.	Wiring diagram	Weight
	<b>Illuminated pushbutton, Front dimension Ø 29 mm</b>								
red	28 VAC/DC	flush	red	1 NC + 1 NO	Maintained	Solder/Plug-in 2.8 x 0.8 mm	<b>K14-271.112102</b>	2	0.021 kg
	<b>Illuminated pushbutton, Front dimension Ø 29 mm</b>								
red	28 VAC/DC	raised	red	1 NC + 1 NO	Maintained	Solder/Plug-in 2.8 x 0.8 mm	<b>K14-271.112052</b>	2	0.021 kg
	<b>Illuminated pushbutton, Front dimension Ø 29 mm</b>								
yellow	28 VAC/DC	flush	yellow	1 NC + 1 NO	Maintained	Solder/Plug-in 2.8 x 0.8 mm	<b>K14-271.112072</b>	2	0.021 kg
	<b>Illuminated pushbutton, Front dimension Ø 29 mm</b>								
yellow	28 VAC/DC	raised	yellow	1 NC + 1 NO	Maintained	Solder/Plug-in 2.8 x 0.8 mm	<b>K14-271.112022</b>	2	0.021 kg
	<b>Illuminated pushbutton, Front dimension Ø 29 mm</b>								
green	28 VAC/DC	flush	green	1 NC + 1 NO	Maintained	Solder/Plug-in 2.8 x 0.8 mm	<b>K14-271.112082</b>	2	0.021 kg
	<b>Illuminated pushbutton, Front dimension Ø 29 mm</b>								
green	28 VAC/DC	raised	green	1 NC + 1 NO	Maintained	Solder/Plug-in 2.8 x 0.8 mm	<b>K14-271.112032</b>	2	0.021 kg
	<b>Illuminated pushbutton, Front dimension Ø 29 mm</b>								
blue	28 VAC/DC	flush	blue	1 NC + 1 NO	Maintained	Solder/Plug-in 2.8 x 0.8 mm	<b>K14-271.112062</b>	2	0.021 kg
	<b>Illuminated pushbutton, Front dimension Ø 29 mm</b>								
blue	28 VAC/DC	raised	blue	1 NC + 1 NO	Maintained	Solder/Plug-in 2.8 x 0.8 mm	<b>K14-271.112012</b>	2	0.021 kg
	<b>Illuminated pushbutton, Front dimension Ø 29 mm</b>								
clear	28 VAC/DC	flush	clear	1 NC + 1 NO	Maintained	Solder/Plug-in 2.8 x 0.8 mm	<b>K14-271.112092</b>	2	0.021 kg









LED colour	Operating voltage	Lens profile	Lens colour	Contacts	Switching action	Terminal	Part No.	Wiring diagram	Weight
 <p><b>Illuminated pushbutton, Front dimension Ø 29 mm</b></p>									
clear	28 VAC/DC	raised	clear	1 NC + 1 NO	Maintained	Solder/Plug-in 2.8 x 0.8 mm	<b>K14-271.112042</b>	2	0.021 kg
 <p><b>Illuminated pushbutton, Front dimension Ø 29 mm</b></p>									
red	24 VAC/DC	flush	red	1 NC + 1 NO	Momentary	Soldering terminal	<b>K14-131.121101</b>	1	0.021 kg
 <p><b>Illuminated pushbutton, Front dimension Ø 29 mm</b></p>									
red	24 VAC/DC	raised	red	1 NC + 1 NO	Momentary	Soldering terminal	<b>K14-131.121051</b>	1	0.021 kg
 <p><b>Illuminated pushbutton, Front dimension Ø 29 mm</b></p>									
yellow	24 VAC/DC	flush	yellow	1 NC + 1 NO	Momentary	Soldering terminal	<b>K14-131.121071</b>	1	0.021 kg
 <p><b>Illuminated pushbutton, Front dimension Ø 29 mm</b></p>									
yellow	24 VAC/DC	raised	yellow	1 NC + 1 NO	Momentary	Soldering terminal	<b>K14-131.121021</b>	1	0.021 kg
 <p><b>Illuminated pushbutton, Front dimension Ø 29 mm</b></p>									
green	24 VAC/DC	flush	green	1 NC + 1 NO	Momentary	Soldering terminal	<b>K14-131.121081</b>	1	0.021 kg
 <p><b>Illuminated pushbutton, Front dimension Ø 29 mm</b></p>									
green	24 VAC/DC	raised	green	1 NC + 1 NO	Momentary	Soldering terminal	<b>K14-131.121031</b>	1	0.021 kg
 <p><b>Illuminated pushbutton, Front dimension Ø 29 mm</b></p>									
blue	24 VAC/DC	flush	blue	1 NC + 1 NO	Momentary	Soldering terminal	<b>K14-131.121061</b>	1	0.021 kg
 <p><b>Illuminated pushbutton, Front dimension Ø 29 mm</b></p>									
blue	24 VAC/DC	raised	blue	1 NC + 1 NO	Momentary	Soldering terminal	<b>K14-131.121011</b>	1	0.021 kg

# 14 Raised design





LED colour	Operating voltage	Lens profile	Lens colour	Contacts	Switching action	Terminal	Part No.	Wiring diagram	Weight
 <p><b>Illuminated pushbutton, Front dimension Ø 29 mm</b></p>									
clear	24 VAC/DC	flush	clear	1 NC + 1 NO	Momentary	Soldering terminal	<b>K14-131.121091</b>	1	0.021 kg
 <p><b>Illuminated pushbutton, Front dimension Ø 29 mm</b></p>									
clear	24 VAC/DC	raised	clear	1 NC + 1 NO	Momentary	Soldering terminal	<b>K14-131.121041</b>	1	0.021 kg
 <p><b>Illuminated pushbutton, Front dimension Ø 29 mm</b></p>									
red	28 VAC/DC	flush	red	1 NC + 1 NO	Momentary	Soldering terminal	<b>K14-131.121102</b>	1	0.021 kg
 <p><b>Illuminated pushbutton, Front dimension Ø 29 mm</b></p>									
red	28 VAC/DC	raised	red	1 NC + 1 NO	Momentary	Soldering terminal	<b>K14-131.121052</b>	1	0.021 kg
 <p><b>Illuminated pushbutton, Front dimension Ø 29 mm</b></p>									
yellow	28 VAC/DC	flush	yellow	1 NC + 1 NO	Momentary	Soldering terminal	<b>K14-131.121072</b>	1	0.021 kg
 <p><b>Illuminated pushbutton, Front dimension Ø 29 mm</b></p>									
yellow	28 VAC/DC	raised	yellow	1 NC + 1 NO	Momentary	Soldering terminal	<b>K14-131.121022</b>	1	0.021 kg
 <p><b>Illuminated pushbutton, Front dimension Ø 29 mm</b></p>									
green	28 VAC/DC	flush	green	1 NC + 1 NO	Momentary	Soldering terminal	<b>K14-131.121082</b>	1	0.021 kg
 <p><b>Illuminated pushbutton, Front dimension Ø 29 mm</b></p>									
green	28 VAC/DC	raised	green	1 NC + 1 NO	Momentary	Soldering terminal	<b>K14-131.121032</b>	1	0.021 kg
 <p><b>Illuminated pushbutton, Front dimension Ø 29 mm</b></p>									
blue	28 VAC/DC	flush	blue	1 NC + 1 NO	Momentary	Soldering terminal	<b>K14-131.121062</b>	1	0.021 kg

LED colour	Operating voltage	Lens profile	Lens colour	Contacts	Switching action	Terminal	Part No.	Wiring diagram	Weight
	<b>Illuminated pushbutton, Front dimension Ø 29 mm</b>								
blue	28 VAC/DC	raised	blue	1 NC + 1 NO	Momentary	Soldering terminal	<b>K14-131.121012</b>	1	0.021 kg
	<b>Illuminated pushbutton, Front dimension Ø 29 mm</b>								
clear	28 VAC/DC	flush	clear	1 NC + 1 NO	Momentary	Soldering terminal	<b>K14-131.121092</b>	1	0.021 kg
	<b>Illuminated pushbutton, Front dimension Ø 29 mm</b>								
clear	28 VAC/DC	raised	clear	1 NC + 1 NO	Momentary	Soldering terminal	<b>K14-131.121042</b>	1	0.021 kg
	<b>Illuminated pushbutton, Front dimension Ø 29 mm</b>								
red	24 VAC/DC	flush	red	1 NC + 1 NO	Maintained	Soldering terminal	<b>K14-271.122101</b>	2	0.021 kg
	<b>Illuminated pushbutton, Front dimension Ø 29 mm</b>								
red	24 VAC/DC	raised	red	1 NC + 1 NO	Maintained	Soldering terminal	<b>K14-271.122051</b>	2	0.021 kg
	<b>Illuminated pushbutton, Front dimension Ø 29 mm</b>								
yellow	24 VAC/DC	flush	yellow	1 NC + 1 NO	Maintained	Soldering terminal	<b>K14-271.122071</b>	2	0.021 kg
	<b>Illuminated pushbutton, Front dimension Ø 29 mm</b>								
yellow	24 VAC/DC	raised	yellow	1 NC + 1 NO	Maintained	Soldering terminal	<b>K14-271.122021</b>	2	0.021 kg
	<b>Illuminated pushbutton, Front dimension Ø 29 mm</b>								
green	24 VAC/DC	flush	green	1 NC + 1 NO	Maintained	Soldering terminal	<b>K14-271.122081</b>	2	0.021 kg
	<b>Illuminated pushbutton, Front dimension Ø 29 mm</b>								
green	24 VAC/DC	raised	green	1 NC + 1 NO	Maintained	Soldering terminal	<b>K14-271.122031</b>	2	0.021 kg

# 14 Raised design

LED colour	Operating voltage	Lens profile	Lens colour	Contacts	Switching action	Terminal	Part No.	Wiring diagram	Weight
 <p><b>Illuminated pushbutton, Front dimension Ø 29 mm</b></p>									
blue	24 VAC/DC	flush	blue	1 NC + 1 NO	Maintained	Soldering terminal	<b>K14-271.122061</b>	2	0.021 kg
 <p><b>Illuminated pushbutton, Front dimension Ø 29 mm</b></p>									
blue	24 VAC/DC	raised	blue	1 NC + 1 NO	Maintained	Soldering terminal	<b>K14-271.122011</b>	2	0.021 kg
 <p><b>Illuminated pushbutton, Front dimension Ø 29 mm</b></p>									
clear	24 VAC/DC	flush	clear	1 NC + 1 NO	Maintained	Soldering terminal	<b>K14-271.122091</b>	2	0.021 kg
 <p><b>Illuminated pushbutton, Front dimension Ø 29 mm</b></p>									
clear	24 VAC/DC	raised	clear	1 NC + 1 NO	Maintained	Soldering terminal	<b>K14-271.122041</b>	2	0.021 kg
 <p><b>Illuminated pushbutton, Front dimension Ø 29 mm</b></p>									
red	28 VAC/DC	flush	red	1 NC + 1 NO	Maintained	Soldering terminal	<b>K14-271.122102</b>	2	0.021 kg
 <p><b>Illuminated pushbutton, Front dimension Ø 29 mm</b></p>									
red	28 VAC/DC	raised	red	1 NC + 1 NO	Maintained	Soldering terminal	<b>K14-271.122052</b>	2	0.021 kg
 <p><b>Illuminated pushbutton, Front dimension Ø 29 mm</b></p>									
yellow	28 VAC/DC	flush	yellow	1 NC + 1 NO	Maintained	Soldering terminal	<b>K14-271.122072</b>	2	0.021 kg
 <p><b>Illuminated pushbutton, Front dimension Ø 29 mm</b></p>									
yellow	28 VAC/DC	raised	yellow	1 NC + 1 NO	Maintained	Soldering terminal	<b>K14-271.122022</b>	2	0.021 kg
 <p><b>Illuminated pushbutton, Front dimension Ø 29 mm</b></p>									
green	28 VAC/DC	flush	green	1 NC + 1 NO	Maintained	Soldering terminal	<b>K14-271.122082</b>	2	0.021 kg



LED colour	Operating voltage	Lens profile	Lens colour	Contacts	Switching action	Terminal	Part No.	Wiring diagram	Weight
 <p><b>Illuminated pushbutton, Front dimension Ø 29 mm</b></p>									
green	28 VAC/DC	raised	green	1 NC + 1 NO	Maintained	Soldering terminal	<b>K14-271.122032</b>	2	0.021 kg
 <p><b>Illuminated pushbutton, Front dimension Ø 29 mm</b></p>									
blue	28 VAC/DC	flush	blue	1 NC + 1 NO	Maintained	Soldering terminal	<b>K14-271.122062</b>	2	0.021 kg
 <p><b>Illuminated pushbutton, Front dimension Ø 29 mm</b></p>									
blue	28 VAC/DC	raised	blue	1 NC + 1 NO	Maintained	Soldering terminal	<b>K14-271.122012</b>	2	0.021 kg
 <p><b>Illuminated pushbutton, Front dimension Ø 29 mm</b></p>									
clear	28 VAC/DC	flush	clear	1 NC + 1 NO	Maintained	Soldering terminal	<b>K14-271.122092</b>	2	0.021 kg
 <p><b>Illuminated pushbutton, Front dimension Ø 29 mm</b></p>									
clear	28 VAC/DC	raised	clear	1 NC + 1 NO	Maintained	Soldering terminal	<b>K14-271.122042</b>	2	0.021 kg

Contacts: NC = Normally closed, NO = Normally open

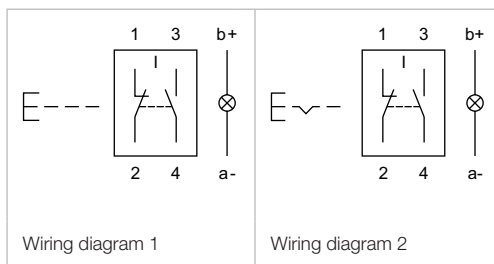

# 14 Raised design

## Illuminated pushbutton, IP67



Product can differ from the current configuration.

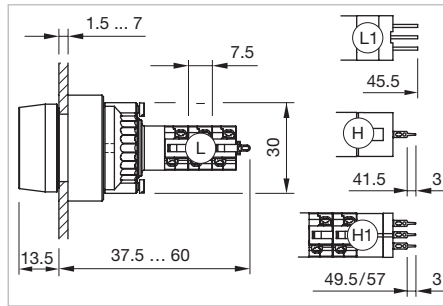

Dimensions [mm]  
 L = Solder terminal,  
 L1 = Solder/Plug-in terminal 2.8 x 0.5 mm,  
 H = Universal terminal 2.0 x 0.5 mm,  
 H1 = Universal-Solder terminal

### Additional Information

- For front dimension  $\varnothing 29$  mm
- For LED element fitting information see «Application guidelines, LED polarity»

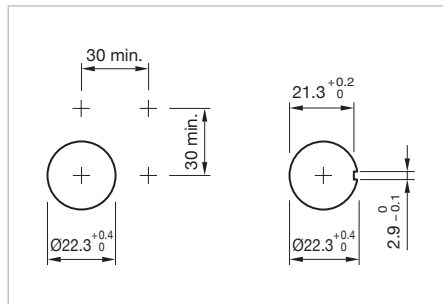



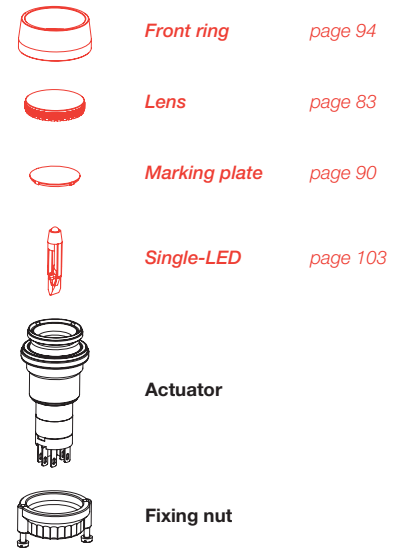

Mounting cut-outs [mm]









### Equipment consisting of (schematic overview)



Each Part Number listed below includes all the black components shown in the 3D-drawing.

To obtain a complete unit, please select the red components from the pages shown.

Switching system	Contacts	Switching action	Terminal	Diode 1N4007	Part No.	Component layout	Wiring diagram	Weight
 <p><b>Illuminated pushbutton actuator, Front dimension <math>\varnothing 29</math> mm</b></p>								
Low-level element	1 NC	Momentary	Universal 2.0 x 0.5 mm		<b>14-436.036</b>	1	1	0,015 kg
		Maintained	Universal 2.0 x 0.5 mm		<b>14-476.036</b>	1	2	0,015 kg
 <p><b>Illuminated pushbutton actuator, Front dimension <math>\varnothing 29</math> mm</b></p>								
Low-level element	1 NC + 1 NO	Momentary	Universal 2.0 x 0.5 mm		<b>14-433.036</b>	1	3	0,015 kg
		Maintained	Universal 2.0 x 0.5 mm		<b>14-473.036</b>	1	4	0,015 kg
 <p><b>Illuminated pushbutton actuator, Front dimension <math>\varnothing 29</math> mm</b></p>								
Low-level element	1 NO	Momentary	Universal 2.0 x 0.5 mm		<b>14-435.036</b>	1	5	0,015 kg
		Maintained	Universal 2.0 x 0.5 mm		<b>14-475.036</b>	1	6	0,015 kg
 <p><b>Illuminated pushbutton actuator, Front dimension <math>\varnothing 29</math> mm</b></p>								
Low-level element	2 NC	Momentary	Universal 2.0 x 0.5 mm		<b>14-432.036</b>	1	7	0,015 kg
		Maintained	Universal 2.0 x 0.5 mm		<b>14-472.036</b>	1	8	0,015 kg
	2 NO	Momentary	Universal 2.0 x 0.5 mm		<b>14-431.036</b>	1	9	0,015 kg
		Maintained	Universal 2.0 x 0.5 mm		<b>14-471.036</b>	1	10	0,015 kg

Switching system	Contacts	Switching action	Terminal	Diode 1N4007	Part No.	Component layout	Wiring diagram	Weight
 <p><b>Illuminated pushbutton actuator, Front dimension Ø 29 mm</b></p>								
Snap-action switching element	1 NC + 1 NO	Momentary	Universal-Solder	1	<b>14-743.0292</b>	1	11	0,014 kg
		Maintained	Universal-Solder	1	<b>14-747.0292</b>	1	12	0,014 kg
 <p><b>Illuminated pushbutton actuator, Front dimension Ø 29 mm</b></p>								
Snap-action switching element	1 NC + 1 NO	Momentary	Universal-Solder	2	<b>14-744.0292</b>	1	13	0,014 kg
		Maintained	Universal-Solder	2	<b>14-748.0292</b>	1	14	0,014 kg
 <p><b>Illuminated pushbutton actuator, Front dimension Ø 29 mm</b></p>								
Snap-action switching element	1 NC + 1 NO	Momentary	Solder 2.8 x 0.5 mm		<b>14-131.022</b>		24	0,013 kg
 <p><b>Illuminated pushbutton actuator, Front dimension Ø 29 mm</b></p>								
Snap-action switching element	1 NC + 1 NO	Momentary	Solder		<b>14-131.0252</b>		15	0,013 kg
 <p><b>Illuminated pushbutton actuator, Front dimension Ø 29 mm</b></p>								
Snap-action switching element	1 NC + 1 NO	Maintained	Solder 2.8 x 0.5 mm		<b>14-271.022</b>		25	0,013 kg
 <p><b>Illuminated pushbutton actuator, Front dimension Ø 29 mm</b></p>								
Snap-action switching element	1 NC + 1 NO	Maintained	Solder		<b>14-271.0252</b>		16	0,013 kg
 <p><b>Illuminated pushbutton actuator, Front dimension Ø 29 mm</b></p>								
Snap-action switching element	2 NC + 2 NO	Momentary	Universal-Solder	2	<b>14-746.0292</b>	1	17	0,016 kg
 <p><b>Illuminated pushbutton actuator, Front dimension Ø 29 mm</b></p>								
Snap-action switching element	2 NC + 2 NO	Momentary	Solder		<b>14-132.0252</b>		18	0,015 kg
		Maintained	Solder		<b>14-272.0252</b>		19	0,015 kg
 <p><b>Illuminated pushbutton actuator, Front dimension Ø 29 mm</b></p>								
Snap-action switching element	3 NC + 3 NO	Momentary	Solder		<b>14-133.0252</b>		20	0,017 kg
		Maintained	Solder		<b>14-273.0252</b>		21	0,017 kg

# 14 Raised design

Switching system	Contacts	Switching action	Terminal	Diode 1N4007	Part No.	Component layout	Wiring diagram	Weight
 <b>Illuminated pushbutton actuator, Front dimension Ø 29 mm</b>	4 NC + 4 NO	Momentary	Solder		<b>14-134.0252</b>		22	0,019 kg
		Maintained	Solder		<b>14-274.0252</b>		23	0,019 kg

Contacts: NC = Normally closed, NO = Normally open  
 The component layouts you will find from page 110

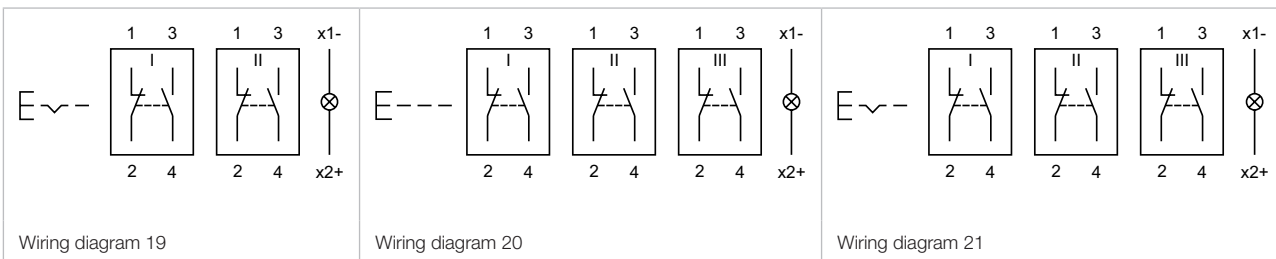
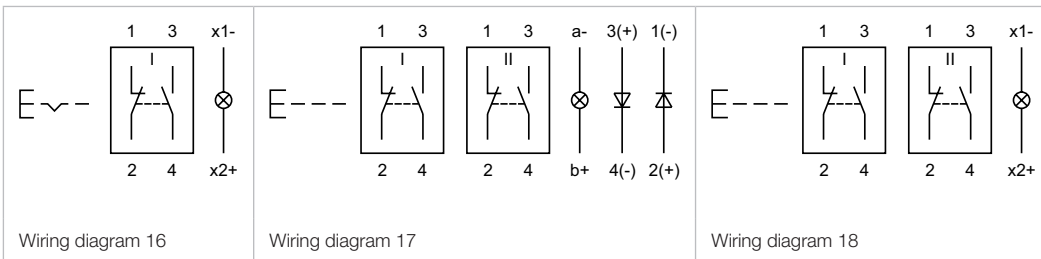
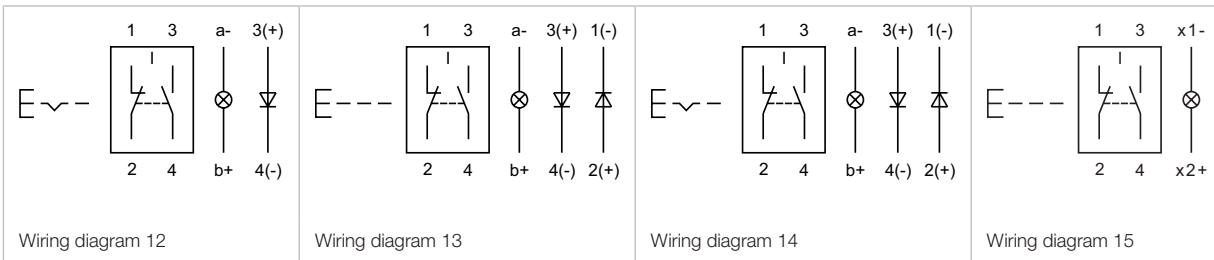
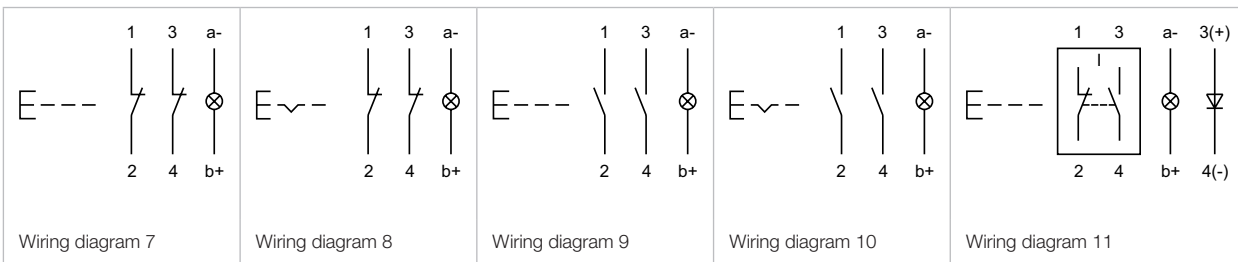
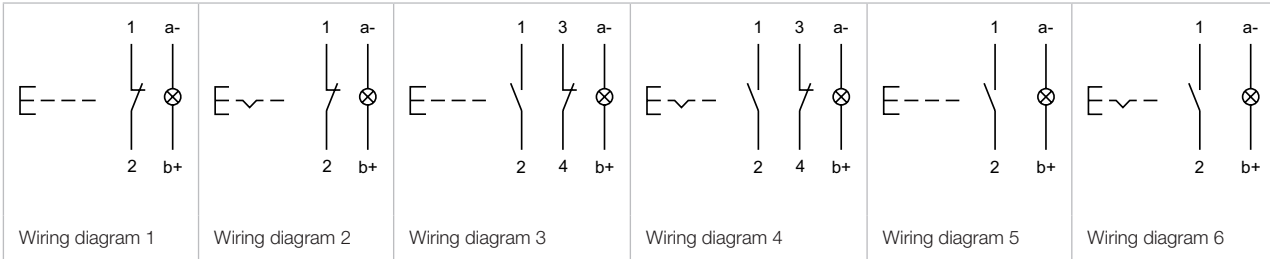

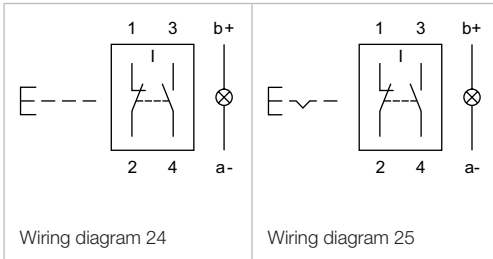
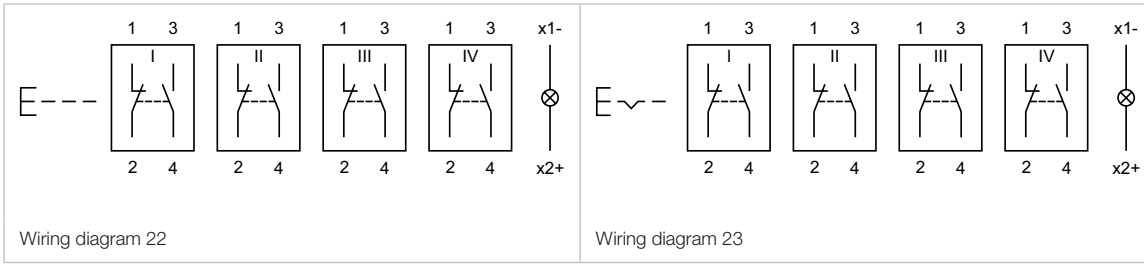

# 14 Raised design

## Mushroom-head pushbutton, IP67



Product can differ from the current configuration.

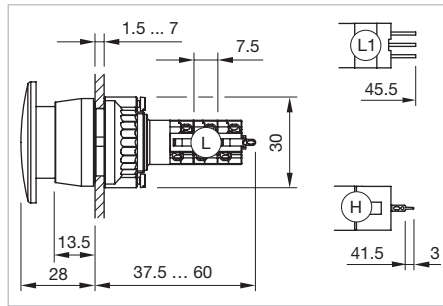

Dimensions [mm]  
 L = Solder terminal,  
 L1 = Solder/Plug-in terminal 2.8 x 0.5 mm,  
 H = Universal terminal 2.0 x 0.5 mm

### Additional Information

- For front dimension Ø 40 mm

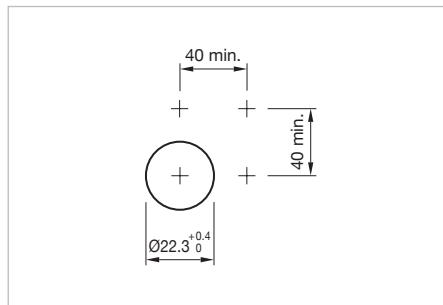



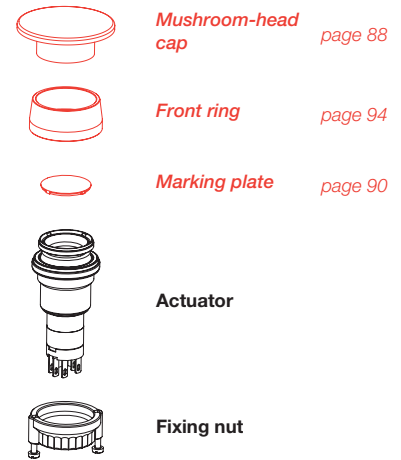

Mounting cut-outs [mm]

### Equipment consisting of (schematic overview)



Each Part Number listed below includes all the black components shown in the 3D-drawing.

To obtain a complete unit, please select the red components from the pages shown.

Switching system	Contacts	Switching action	Terminal	Part No.	Component layout	Wiring diagram	Weight
 <p><b>Mushroom-head pushbutton actuator, Front dimension Ø 29 mm</b></p>							
Low-level element	1 NC	Momentary	Universal 2.0 x 0.5 mm	<b>14-436.036</b>	1	1	0,015 kg
		Maintained	Universal 2.0 x 0.5 mm	<b>14-476.036</b>	1	2	0,015 kg
 <p><b>Mushroom-head pushbutton actuator, Front dimension Ø 29 mm</b></p>							
Low-level element	1 NC + 1 NO	Momentary	Universal 2.0 x 0.5 mm	<b>14-433.036</b>	1	3	0,015 kg
		Maintained	Universal 2.0 x 0.5 mm	<b>14-473.036</b>	1	4	0,015 kg
 <p><b>Mushroom-head pushbutton actuator, Front dimension Ø 29 mm</b></p>							
Low-level element	1 NO	Momentary	Universal 2.0 x 0.5 mm	<b>14-435.036</b>	1	5	0,015 kg
		Maintained	Universal 2.0 x 0.5 mm	<b>14-475.036</b>	1	6	0,015 kg
 <p><b>Mushroom-head pushbutton actuator, Front dimension Ø 29 mm</b></p>							
Low-level element	2 NC	Momentary	Universal 2.0 x 0.5 mm	<b>14-432.036</b>	1	7	0,015 kg
		Maintained	Universal 2.0 x 0.5 mm	<b>14-472.036</b>	1	8	0,015 kg
	2 NO	Momentary	Universal 2.0 x 0.5 mm	<b>14-431.036</b>	1	9	0,015 kg
		Maintained	Universal 2.0 x 0.5 mm	<b>14-471.036</b>	1	10	0,015 kg

Switching system	Contacts	Switching action	Terminal	Part No.	Component layout	Wiring diagram	Weight
	<b>Mushroom-head pushbutton actuator, Front dimension Ø 29 mm</b>						
Snap-action switching element	1 NC + 1 NO	Momentary	Solder 2.8 x 0.5 mm	<b>14-131.022</b>		19	0,013 kg
	<b>Mushroom-head pushbutton actuator, Front dimension Ø 29 mm</b>						
Snap-action switching element	1 NC + 1 NO	Momentary	Solder	<b>14-131.0252</b>		11	0,013 kg
	<b>Mushroom-head pushbutton actuator, Front dimension Ø 29 mm</b>						
Snap-action switching element	1 NC + 1 NO	Maintained	Solder 2.8 x 0.5 mm	<b>14-271.022</b>		20	0,013 kg
	<b>Mushroom-head pushbutton actuator, Front dimension Ø 29 mm</b>						
Snap-action switching element	1 NC + 1 NO	Maintained	Solder	<b>14-271.0252</b>		12	0,013 kg
	<b>Mushroom-head pushbutton actuator, Front dimension Ø 29 mm</b>						
Snap-action switching element	2 NC + 2 NO	Momentary	Solder	<b>14-132.0252</b>		13	0,015 kg
		Maintained	Solder	<b>14-272.0252</b>		14	0,015 kg
	<b>Mushroom-head pushbutton actuator, Front dimension Ø 29 mm</b>						
Snap-action switching element	3 NC + 3 NO	Momentary	Solder	<b>14-133.0252</b>		15	0,017 kg
		Maintained	Solder	<b>14-273.0252</b>		16	0,017 kg
	<b>Mushroom-head pushbutton actuator, Front dimension Ø 29 mm</b>						
Snap-action switching element	4 NC + 4 NO	Momentary	Solder	<b>14-134.0252</b>		17	0,019 kg
		Maintained	Solder	<b>14-274.0252</b>		18	0,019 kg

Contacts: NC = Normally closed, NO = Normally open  
 The component layouts you will find from page 110

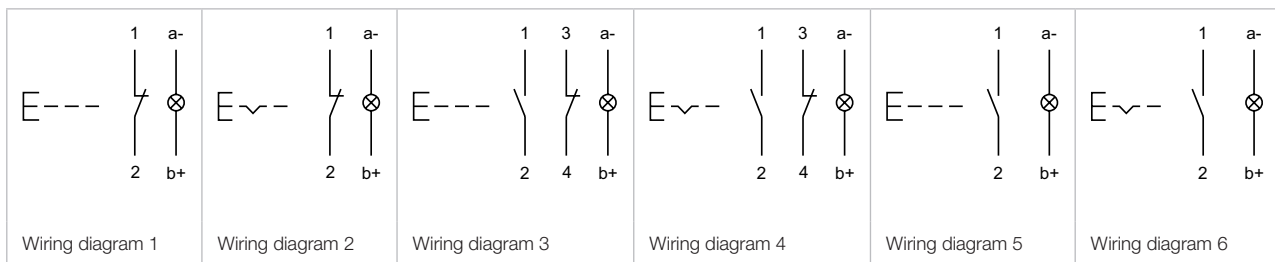



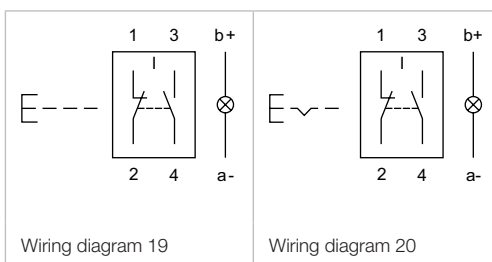
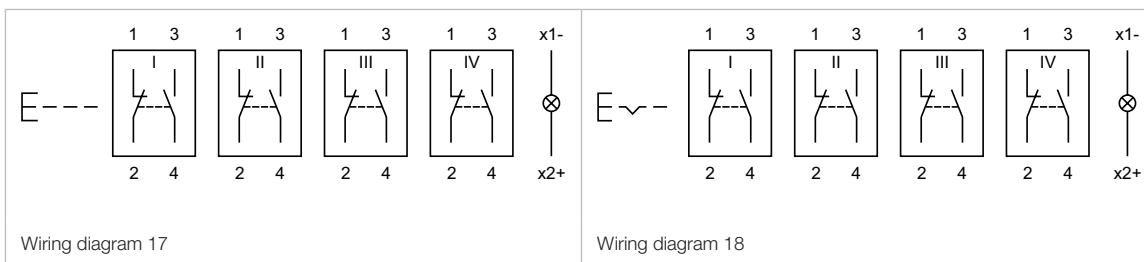
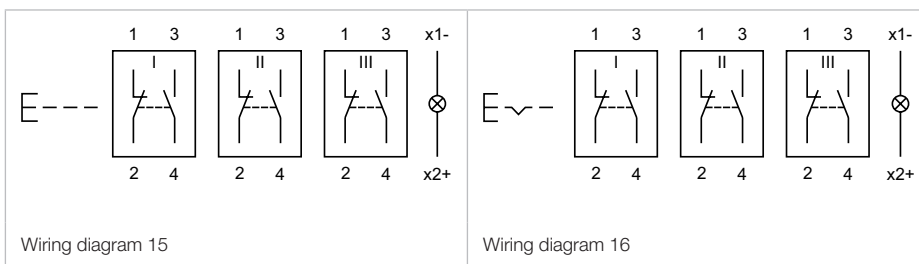
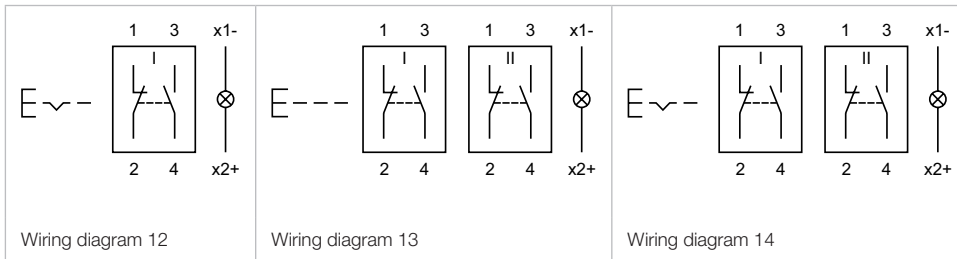
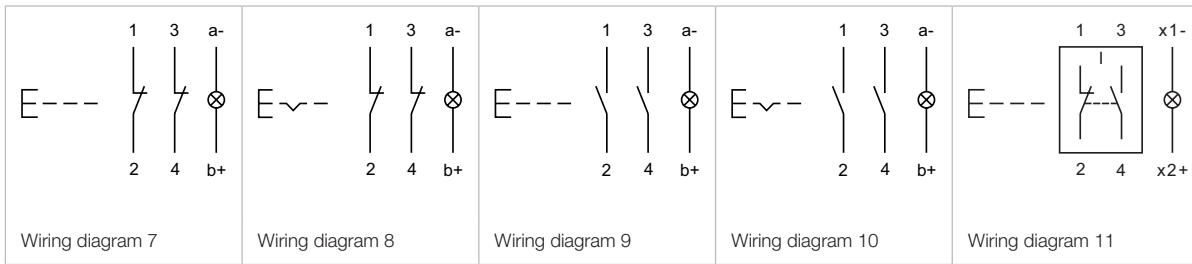



# 14 Raised design



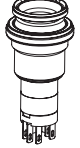

Illuminated mushroom head pushbutton, IP67

Equipment consisting of (schematic overview)

-  **Mushroom-head cap** *page 88*
-  **Front ring** *page 94*
-  **Marking plate** *page 90*
-  **Single-LED** *page 103*
-  **Actuator**
-  **Fixing nut**

Each Part Number listed below includes all the black components shown in the 3D-drawing.

To obtain a complete unit, please select the red components from the pages shown.

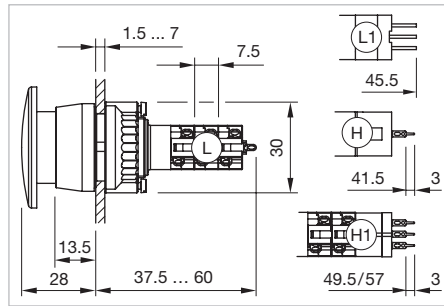

Dimensions [mm]  
 L = Solder terminal,  
 L1 = Solder/Plug-in terminal 2.8 x 0.5 mm,  
 H = Universal terminal 2.0 x 0.5 mm,  
 H1 = Universal-Solder terminal





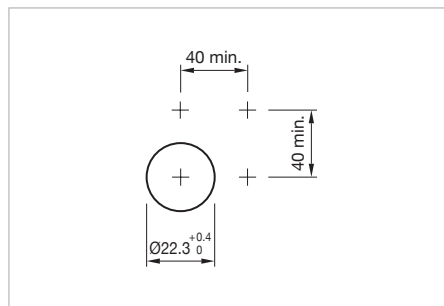

Product can differ from the current configuration.



Mounting cut-outs [mm]

Additional Information

- For front dimension Ø 29 mm
- For LED element fitting information see «Application guidelines, LED polarity»

Switching system	Contacts	Switching action	Terminal	Diode 1N4007	Part No.	Component layout	Wiring diagram	Weight
 <p><b>Mushroom-head pushbutton actuator illuminated, Front dimension Ø 29 mm</b></p>								
Low-level element	1 NC	Momentary	Universal 2.0 x 0.5 mm		<b>14-436.036</b>	1	1	0,015 kg
		Maintained	Universal 2.0 x 0.5 mm		<b>14-476.036</b>	1	2	0,015 kg
 <p><b>Mushroom-head pushbutton actuator illuminated, Front dimension Ø 29 mm</b></p>								
Low-level element	1 NC + 1 NO	Momentary	Universal 2.0 x 0.5 mm		<b>14-433.036</b>	1	3	0,015 kg
		Maintained	Universal 2.0 x 0.5 mm		<b>14-473.036</b>	1	4	0,015 kg
 <p><b>Mushroom-head pushbutton actuator illuminated, Front dimension Ø 29 mm</b></p>								
Low-level element	1 NO	Momentary	Universal 2.0 x 0.5 mm		<b>14-435.036</b>	1	5	0,015 kg
		Maintained	Universal 2.0 x 0.5 mm		<b>14-475.036</b>	1	6	0,015 kg
 <p><b>Mushroom-head pushbutton actuator illuminated, Front dimension Ø 29 mm</b></p>								
Low-level element	2 NC	Momentary	Universal 2.0 x 0.5 mm		<b>14-432.036</b>	1	7	0,015 kg
		Maintained	Universal 2.0 x 0.5 mm		<b>14-472.036</b>	1	8	0,015 kg
		Momentary	Universal 2.0 x 0.5 mm		<b>14-431.036</b>	1	9	0,015 kg
		Maintained	Universal 2.0 x 0.5 mm		<b>14-471.036</b>	1	10	0,015 kg

# 14 Raised design

Switching system	Contacts	Switching action	Terminal	Diode 1N4007	Part No.	Component layout	Wiring diagram	Weight
 <p><b>Mushroom-head pushbutton actuator illuminated, Front dimension Ø 29 mm</b></p>								
Snap-action switching element	1 NC + 1 NO	Momentary	Universal-Solder	1	<b>14-743.0292</b>	1	11	0,014 kg
		Maintained	Universal-Solder	1	<b>14-747.0292</b>	1	12	0,014 kg
 <p><b>Mushroom-head pushbutton actuator illuminated, Front dimension Ø 29 mm</b></p>								
Snap-action switching element	1 NC + 1 NO	Momentary	Universal-Solder	2	<b>14-744.0292</b>	1	13	0,014 kg
		Maintained	Universal-Solder	2	<b>14-748.0292</b>	1	14	0,014 kg
 <p><b>Mushroom-head pushbutton actuator illuminated, Front dimension Ø 29 mm</b></p>								
Snap-action switching element	1 NC + 1 NO	Momentary	Solder 2.8 x 0.5 mm		<b>14-131.022</b>		24	0,013 kg
		Maintained	Solder 2.8 x 0.5 mm		<b>14-271.022</b>		25	0,013 kg
 <p><b>Mushroom-head pushbutton actuator illuminated, Front dimension Ø 29 mm</b></p>								
Snap-action switching element	1 NC + 1 NO	Momentary	Solder		<b>14-131.0252</b>		15	0,013 kg
		Maintained	Solder		<b>14-271.0252</b>		16	0,013 kg
 <p><b>Mushroom-head pushbutton actuator illuminated, Front dimension Ø 29 mm</b></p>								
Snap-action switching element	2 NC + 2 NO	Momentary	Universal-Solder	2	<b>14-746.0292</b>	1	17	0,016 kg
 <p><b>Mushroom-head pushbutton actuator illuminated, Front dimension Ø 29 mm</b></p>								
Snap-action switching element	2 NC + 2 NO	Momentary	Solder		<b>14-132.0252</b>		18	0,015 kg
		Maintained	Solder		<b>14-272.0252</b>		19	0,015 kg
 <p><b>Mushroom-head pushbutton actuator illuminated, Front dimension Ø 29 mm</b></p>								
Snap-action switching element	3 NC + 3 NO	Momentary	Solder		<b>14-133.0252</b>		20	0,017 kg
		Maintained	Solder		<b>14-273.0252</b>		21	0,017 kg
 <p><b>Mushroom-head pushbutton actuator illuminated, Front dimension Ø 29 mm</b></p>								
Snap-action switching element	4 NC + 4 NO	Momentary	Solder		<b>14-134.0252</b>		22	0,019 kg
Snap-action switching element	4 NC + 4 NO	Maintained	Solder		<b>14-274.0252</b>		23	0,019 kg

Contacts: NC = Normally closed, NO = Normally open  
 The component layouts you will find from page 110

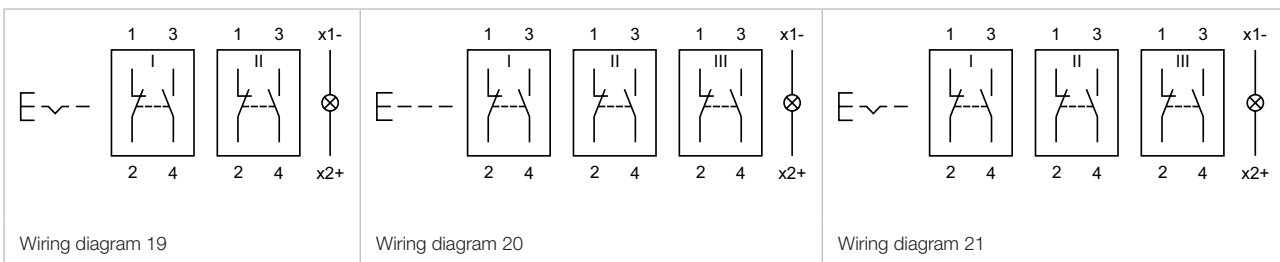
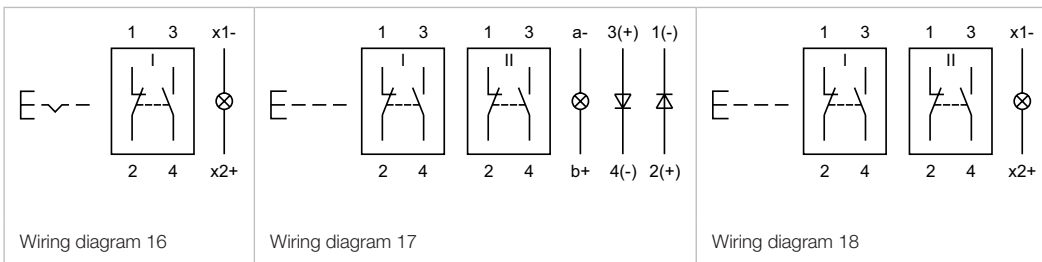
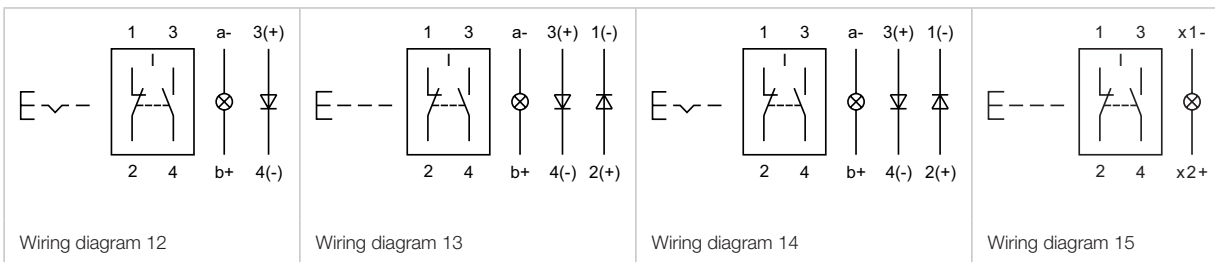
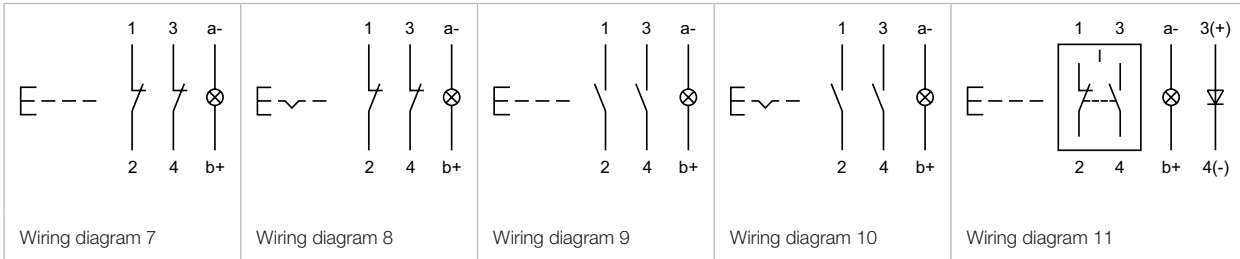
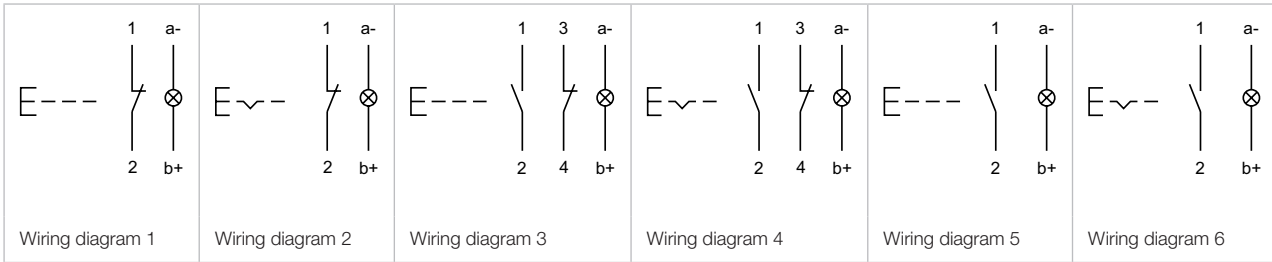

# 14 Raised design

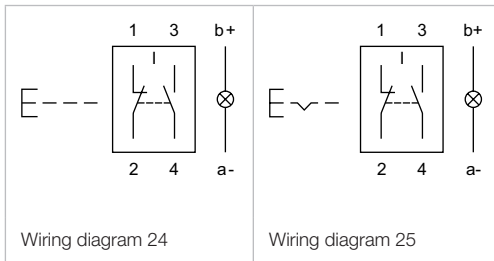
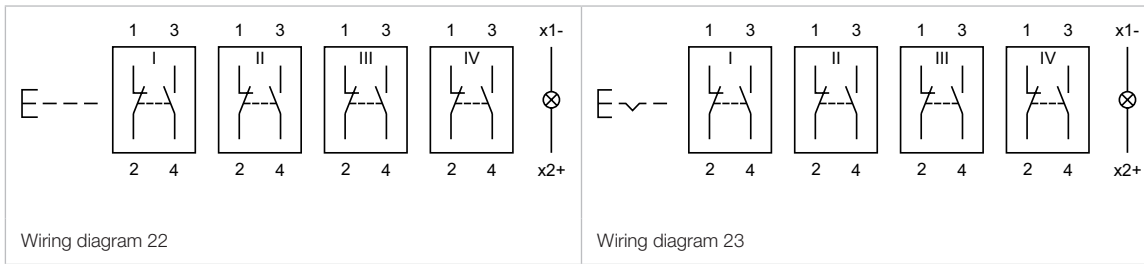

## Keylock switch 2 positions, IP65

### Equipment consisting of (schematic overview)

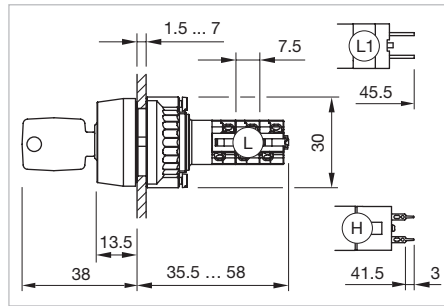
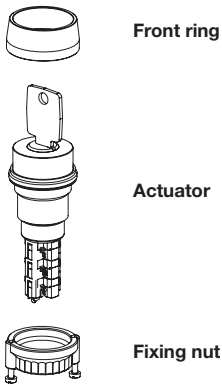

Dimensions [mm]  
 L = Solder terminal,  
 L1 = Solder/Plug-in terminal 2.8 x 0.5 mm,  
 H = Universal terminal 2.0 x 0.5 mm



Product can differ from the current configuration.

Each Part Number listed below includes all the black components shown in the 3D-drawing.

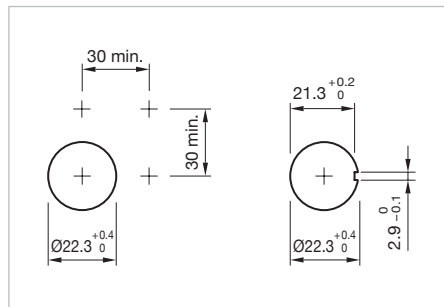

Mounting cut-outs [mm]

### Additional Information



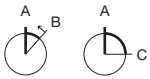



- Front plastic black
- Lock numbers 1001, lock type KABA
- Optional lock numbers on request
- Two keys are supplied with each keylock switch.
- The colour of anodized aluminium parts can vary due to technical production reasons





Switching positions (A = Rest, B = Momentary, C = Maintained)

Front bezel	Switching system	Contacts	Switching action	Switching angle	Terminal	Part No.	Component layout	Wiring diagram	Weight
 <p><b>Keylock switch actuator 2 positions, Front dimension Ø 29 mm</b></p>	Low-level element	2 NO	Rest(a) - Momentary	42° right	Universal 2.0 x 0.5 mm	<b>14-437.036K</b>	1	1	0,030 kg
		1 NC + 1 NO	Rest(a) - Momentary	42° right	Universal 2.0 x 0.5 mm	<b>14-438.036K</b>	1	2	0,030 kg
		1 NC + 1 NO	Rest(a) - Maintain(a)	90° right	Universal 2.0 x 0.5 mm	<b>14-412.036K</b>	1	3	0,030 kg
		2 NO	Rest - Maintain(a)	90° right	Universal 2.0 x 0.5 mm	<b>14-417.036K</b>	1	4	0,030 kg
		1 NC + 1 NO	Rest(a) - Maintain	90° right	Universal 2.0 x 0.5 mm	<b>14-415.036K</b>	1	3	0,030 kg
		1 NC + 1 NO	Rest - Maintain(a)	90° right	Universal 2.0 x 0.5 mm	<b>14-418.036K</b>	1	3	0,030 kg
		2 NO	Rest(a) - Maintain(a)	90° right	Universal 2.0 x 0.5 mm	<b>14-411.036K</b>	1	4	0,030 kg
		2 NO	Rest(a) - Maintain	90° right	Universal 2.0 x 0.5 mm	<b>14-414.036K</b>	1	4	0,030 kg

# 14 Raised design

Front bezel	Switching system	Contacts	Switching action	Switching angle	Terminal	Part No.	Component layout	Wiring diagram	Weight
 <p><b>Keylock switch actuator 2 positions, Front dimension Ø 29 mm</b></p>									
Aluminium natural anodized	Snap-action switching element	1 NC + 1 NO	Rest(a) - Momentary	42° right	Solder 2.8 x 0.5 mm	<b>14-141.022K</b>		5	0,029 kg
 <p><b>Keylock switch actuator 2 positions, Front dimension Ø 29 mm</b></p>									
Aluminium natural anodized	Snap-action switching element	1 NC + 1 NO	Rest(a) - Momentary	42° right	Solder	<b>14-141.025K2</b>		5	0,029 kg
 <p><b>Keylock switch actuator 2 positions, Front dimension Ø 29 mm</b></p>									
Aluminium natural anodized	Snap-action switching element	2 NC + 2 NO	Rest(a) - Momentary	42° right	Solder	<b>14-142.025K2</b>		6	0,031 kg
 <p><b>Keylock switch actuator 2 positions, Front dimension Ø 29 mm</b></p>									
Aluminium natural anodized	Snap-action switching element	3 NC + 3 NO	Rest(a) - Momentary	42° right	Solder	<b>14-143.025K2</b>		7	0,033 kg
 <p><b>Keylock switch actuator 2 positions, Front dimension Ø 29 mm</b></p>									
Aluminium natural anodized	Snap-action switching element	1 NC + 1 NO	Rest - Maintain(a)	90° right	Solder	<b>14-335.025K2</b>		9	0,029 kg
 <p><b>Keylock switch actuator 2 positions, Front dimension Ø 29 mm</b></p>									
Aluminium natural anodized	Snap-action switching element	1 NC + 1 NO	Rest(a) - Maintain(a)	90° right	Solder 2.8 x 0.5 mm	<b>14-135.022K</b>		9	0,029 kg
			Rest(a) - Maintain	90° right	Solder 2.8 x 0.5 mm	<b>14-235.022K</b>		9	0,029 kg
			Rest - Maintain(a)	90° right	Solder 2.8 x 0.5 mm	<b>14-335.022K</b>		9	0,029 kg
 <p><b>Keylock switch actuator 2 positions, Front dimension Ø 29 mm</b></p>									
Aluminium natural anodized	Snap-action switching element	2 NC + 2 NO	Rest(a) - Maintain(a)	90° right	Solder	<b>14-136.025K2</b>		10	0,031 kg
			Rest(a) - Maintain	90° right	Solder	<b>14-236.025K2</b>		10	0,031 kg
			Rest - Maintain(a)	90° right	Solder	<b>14-336.025K2</b>		10	0,031 kg
 <p><b>Keylock switch actuator 2 positions, Front dimension Ø 29 mm</b></p>									
Aluminium natural anodized	Snap-action switching element	3 NC + 3 NO	Rest(a) - Maintain(a)	90° right	Solder	<b>14-137.025K2</b>		11	0,033 kg
			Rest(a) - Maintain	90° right	Solder	<b>14-237.025K2</b>		11	0,033 kg
			Rest - Maintain(a)	90° right	Solder	<b>14-337.025K2</b>		11	0,033 kg

Front bezel	Switching system	Contacts	Switching action	Switching angle	Terminal	Part No.	Component layout	Wiring diagram	Weight
 <p><b>Keylock switch actuator 2 positions, Front dimension Ø 29 mm</b></p>									
Aluminium natural anodized	Snap-action switching element	4 NC + 4 NO	Rest(a) - Maintain(a)	90° right	Solder	<b>14-138.025K2</b>		12	0,035 kg
			Rest(a) - Maintain	90° right	Solder	<b>14-238.025K2</b>		12	0,035 kg
			Rest - Maintain(a)	90° right	Solder	<b>14-338.025K2</b>		12	0,035 kg
 <p><b>Keylock switch actuator 2 positions, Front dimension Ø 29 mm</b></p>									
Aluminium natural anodized	Snap-action switching element	1 NC + 1 NO	Rest(a) - Maintain(a)	90° right	Solder	<b>14-135.025K2</b>		9	0,029 kg
			Rest(a) - Maintain	90° right	Solder	<b>14-235.025K2</b>		9	0,029 kg

Contacts: NC = Normally closed, NO = Normally open  
 The component layouts you will find from page 110

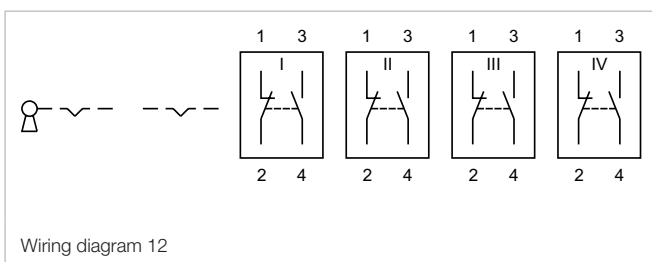
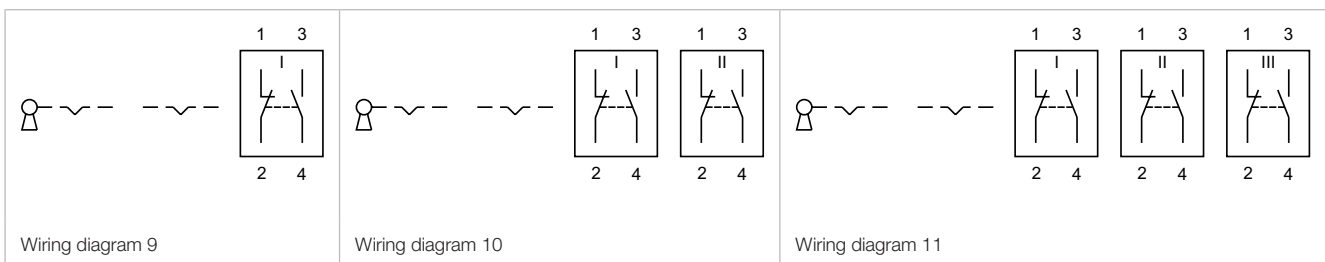
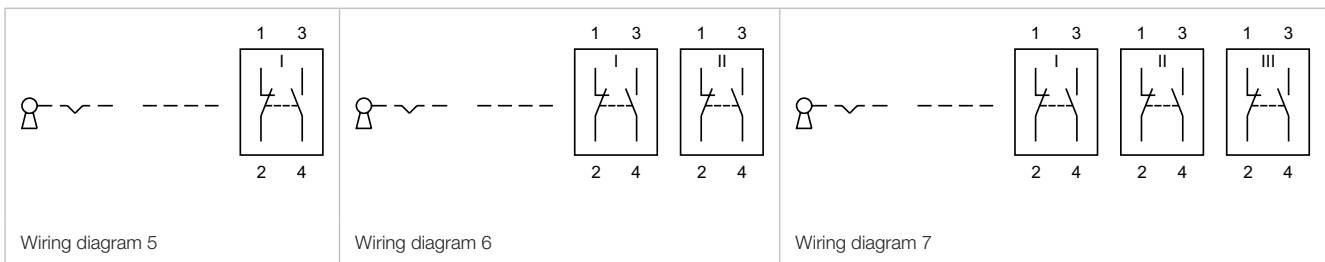
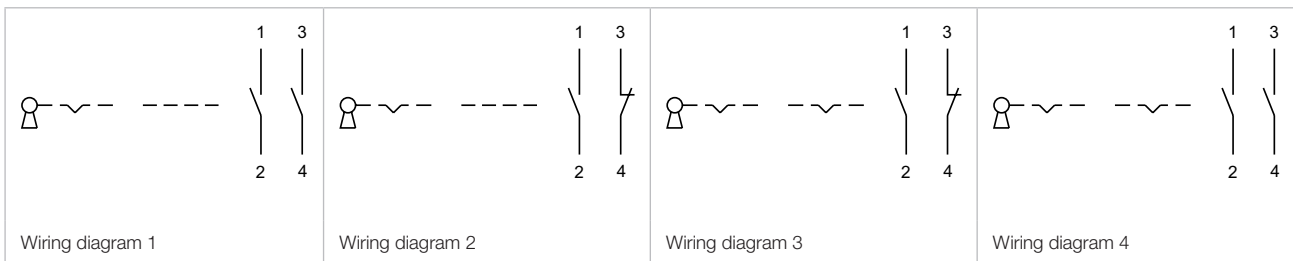

# 14 Raised design

## Selector switch 2 positions, IP67



Product can differ from the current configuration.

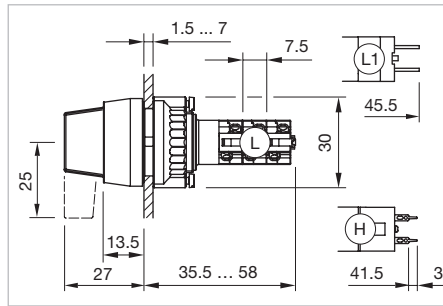

Dimensions [mm]  
 L = Solder terminal,  
 L1 = Solder/Plug-in terminal 2.8 x 0.5 mm,  
 H = Universal terminal 2.0 x 0.5 mm

### Equipment consisting of (schematic overview)

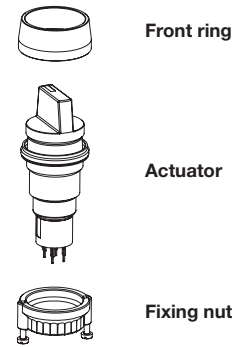

Each Part Number listed below includes all the black components shown in the 3D-drawing.

### Additional Information

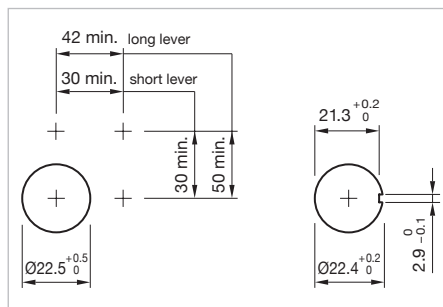

- non-illuminative
- Frontring aluminium natural anodized
- The colour of anodized aluminium parts can vary due to technical production reasons

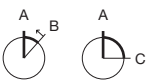

Mounting cut-outs [mm]





Switching positions (A = Rest, B = Momentary, C = Maintained)

Lever	Switching system	Contacts	Switching action	Switching angle	Terminal	Part No.	Component layout	Wiring diagram	Weight		
 <p><b>Selector switch actuator 2 positions, Front dimension Ø 29 mm</b></p>	Plastic black short	1 NC + 1 NO	Rest - Momentary	42° right	Universal 2.0 x 0.5 mm	<b>14-517.0360</b>	1	1	0,025 kg		
			Rest - Maintain	90° right	Universal 2.0 x 0.5 mm	<b>14-522.0360</b>	1	2	0,025 kg		
		 <p><b>Selector switch actuator 2 positions, Front dimension Ø 29 mm</b></p>	Snap-action switching element	2 NC	Rest - Maintain	90° right	Universal 2.0 x 0.5 mm	<b>14-521.0360</b>	1	3	0,025 kg
					Rest - Momentary	42° right	Universal 2.0 x 0.5 mm	<b>14-515.0360</b>	1	4	0,025 kg
				1 NC + 1 NO	Rest - Momentary	42° right	Universal 2.0 x 0.5 mm	<b>14-501.0220</b>		6	0,024 kg
					Rest - Maintain	90° right	Universal 2.0 x 0.5 mm	<b>14-520.0360</b>	1	5	0,025 kg



Lever	Switching system	Contacts	Switching action	Switching angle	Terminal	Part No.	Component layout	Wiring diagram	Weight
	<b>Selector switch actuator 2 positions, Front dimension Ø 29 mm</b>								
Plastic black short	Snap-action switching element	1 NC + 1 NO	Rest - Momentary	42° right	Solder	<b>14-501.02502</b>		6	0,024 kg
	<b>Selector switch actuator 2 positions, Front dimension Ø 29 mm</b>								
Plastic black short	Snap-action switching element	1 NC + 1 NO	Rest - Maintain	90° right	Solder 2.8 x 0.5 mm	<b>14-506.0220</b>		7	0,024 kg
	<b>Selector switch actuator 2 positions, Front dimension Ø 29 mm</b>								
Plastic black short	Snap-action switching element	1 NC + 1 NO	Rest - Maintain	90° right	Solder	<b>14-506.02502</b>		7	0,024 kg
	<b>Selector switch actuator 2 positions, Front dimension Ø 29 mm</b>								
Plastic black short	Snap-action switching element	2 NC + 2 NO	Rest - Momentary	42° right	Solder	<b>14-502.02502</b>		8	0,026 kg
Plastic black short	Snap-action switching element	2 NC + 2 NO	Rest - Maintain	90° right	Solder	<b>14-507.02502</b>		9	0,026 kg
	<b>Selector switch actuator 2 positions, Front dimension Ø 29 mm</b>								
Plastic black short	Snap-action switching element	3 NC + 3 NO	Rest - Maintain	90° right	Solder	<b>14-508.02502</b>		11	0,028 kg
	<b>Selector switch actuator 2 positions, Front dimension Ø 29 mm</b>								
Plastic black short	Snap-action switching element	4 NC + 4 NO	Rest - Maintain	90° right	Solder	<b>14-509.02502</b>		12	0,030 kg
	<b>Selector switch actuator 2 positions, Front dimension Ø 29 mm</b>								
Plastic black long	Low-level element	1 NC + 1 NO	Rest - Maintain	90° right	Universal 2.0 x 0.5 mm	<b>14-572.0360</b>	1	2	0,025 kg
Plastic black long	Low-level element	2 NO	Rest - Maintain	90° right	Universal 2.0 x 0.5 mm	<b>14-570.0360</b>	1	5	0,025 kg
	<b>Selector switch actuator 2 positions, Front dimension Ø 29 mm</b>								
Plastic black long	Snap-action switching element	1 NC + 1 NO	Rest - Maintain	90° right	Solder 2.8 x 0.5 mm	<b>14-556.0220</b>		7	0,024 kg

# 14 Raised design

Lever	Switching system	Contacts	Switching action	Switching angle	Terminal	Part No.	Component layout	Wiring diagram	Weight
	<b>Selector switch actuator 2 positions, Front dimension Ø 29 mm</b>								
Plastic black long	Snap-action switching element	1 NC + 1 NO	Rest - Maintain	90° right	Solder	<b>14-556.02502</b>		7	0,024 kg
	<b>Selector switch actuator 2 positions, Front dimension Ø 29 mm</b>								
Plastic black long	Snap-action switching element	2 NC + 2 NO	Rest - Maintain	90° right	Solder	<b>14-557.02502</b>		9	0,026 kg

Contacts: NC = Normally closed, NO = Normally open  
The component layouts you will find from page 110

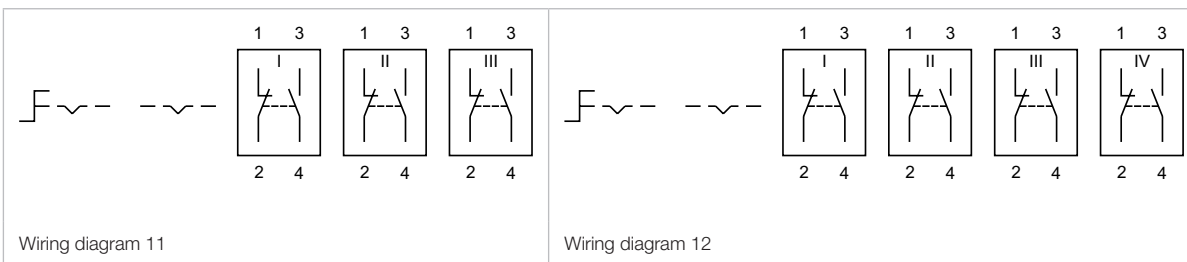
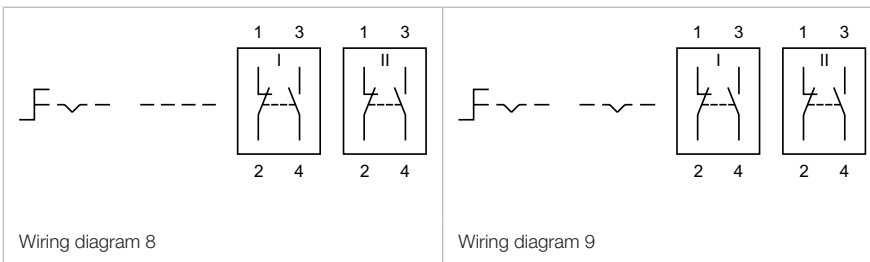
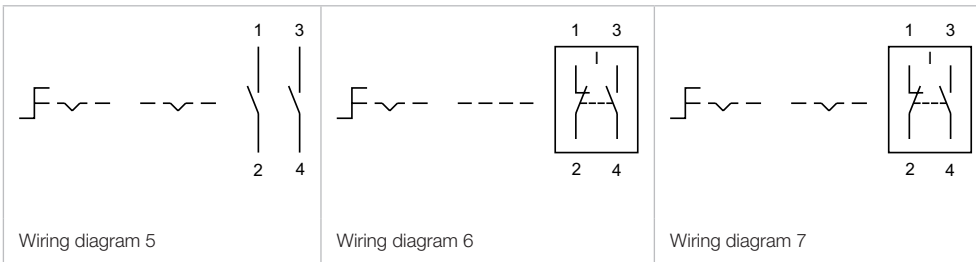
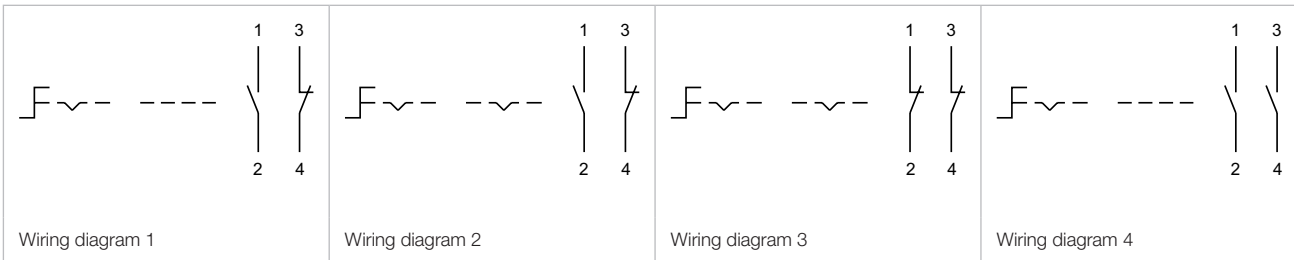









Front

Lens plastic

Additional Information

- To obtain IP 67 use marking plate Part No. 704.609.X





Dimension	Lens	Symbol	Part No.	Weight
 <b>Lens plastic</b>				
Ø 23.7 mm	Plastic black		<b>704.602.0</b>	0,001 kg
 <b>Lens plastic</b>				
Ø 23.7 mm	Plastic red		<b>704.602.2</b>	0,001 kg
 <b>Lens plastic</b>				
Ø 23.7 mm	Plastic orange		<b>704.602.3</b>	0,001 kg
 <b>Lens plastic</b>				
Ø 23.7 mm	Plastic yellow		<b>704.602.4</b>	0,001 kg
 <b>Lens plastic</b>				
Ø 23.7 mm	Plastic green		<b>704.602.5</b>	0,001 kg
 <b>Lens plastic</b>				
Ø 23.7 mm	Plastic blue		<b>704.602.6</b>	0,001 kg
 <b>Lens plastic</b>				
Ø 23.7 mm	Plastic colourless		<b>704.602.7</b>	0,001 kg
 <b>Lens plastic</b>				
Ø 23.7 mm	Plastic colourless	Ring	<b>704.602.7A01</b>	0,001 kg

# 14 Accessories

## Lens plastic encreased

### Additional Information







- To obtain IP 67 use marking plate Part No. 704.610.X

Dimension	Lens	Part No.	Weight
 <p><b>Lens plastic encreased</b></p>			
Ø 23.7 mm	Plastic red	<b>704.611.2</b>	0,002 kg
 <p><b>Lens plastic encreased</b></p>			
Ø 23.7 mm	Plastic yellow	<b>704.611.4</b>	0,002 kg
 <p><b>Lens plastic encreased</b></p>			
Ø 23.7 mm	Plastic green	<b>704.611.5</b>	0,002 kg
 <p><b>Lens plastic encreased</b></p>			
Ø 23.7 mm	Plastic blue	<b>704.611.6</b>	0,002 kg
 <p><b>Lens plastic encreased</b></p>			
Ø 23.7 mm	Plastic colourless	<b>704.611.7</b>	0,002 kg

**Lens metal with dot**

**Additional Information**

- To obtain IP 67 use marking plate Part No. 704.609.X
- The colour of anodized aluminium parts can vary due to technical production reasons







Dimension	Lens	Part No.	Weight
 <b>Lens metal with dot</b>			
Ø 23.7 mm	Aluminium black anodized	<b>704.601.01</b>	0,001 kg
 <b>Lens metal with dot</b>			
Ø 23.7 mm	Aluminium red anodized	<b>704.601.21</b>	0,001 kg
 <b>Lens metal with dot</b>			
Ø 23.7 mm	Aluminium gold anodized	<b>704.601.41</b>	0,001 kg
 <b>Lens metal with dot</b>			
Ø 23.7 mm	Aluminium olive-green anodized	<b>704.601.51</b>	0,001 kg
 <b>Lens metal with dot</b>			
Ø 23.7 mm	Aluminium blue anodized	<b>704.601.61</b>	0,001 kg
 <b>Lens metal with dot</b>			
Ø 23.7 mm	Aluminium natural anodized	<b>704.601.81</b>	0,001 kg
	Stainless steel natural anodized	<b>704.601.91</b>	0,001 kg

# 14 Accessories

## Lens metal

### Additional Information





- To obtain IP 67 use marking plate Part No. 704.609.9
- The colour of anodized aluminium parts can vary due to technical production reasons

Dimension	Lens	Part No.	Weight
 <b>Lens metal</b>			
Ø 23.7 mm	Aluminium black anodized	<b>704.601.0</b>	0,001 kg
 <b>Lens metal</b>			
Ø 23.7 mm	Aluminium red anodized	<b>704.601.2</b>	0,001 kg
 <b>Lens metal</b>			
Ø 23.7 mm	Aluminium gold anodized	<b>704.601.4</b>	0,001 kg
 <b>Lens metal</b>			
Ø 23.7 mm	Aluminium olive-green anodized	<b>704.601.5</b>	0,001 kg
 <b>Lens metal</b>			
Ø 23.7 mm	Aluminium blue anodized	<b>704.601.6</b>	0,001 kg
 <b>Lens metal</b>			
Ø 23.7 mm	Aluminium natural anodized	<b>704.601.8</b>	0,001 kg
	Stainless steel natural anodized	<b>704.601.9</b>	0,001 kg

**Lens cap, Plastic**

**Additional Information**

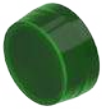
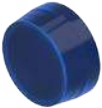
- To obtain IP 67 use marking plate Part No. 704.608.X





Dimension	Lens cap	Part No.	Weight
 <p><b>Lens cap round, 29 mm</b></p>			
Ø 29 mm	Plastic red	<b>704.603.2</b>	0,003 kg
 <p><b>Lens cap round, 29 mm</b></p>			
Ø 29 mm	Plastic yellow	<b>704.603.4</b>	0,003 kg
 <p><b>Lens cap round, 29 mm</b></p>			
Ø 29 mm	Plastic green	<b>704.603.5</b>	0,003 kg
 <p><b>Lens cap round, 29 mm</b></p>			
Ø 29 mm	Plastic blue	<b>704.603.6</b>	0,003 kg
 <p><b>Lens cap round, 29 mm</b></p>			
Ø 29 mm	Plastic colourless	<b>704.603.7</b>	0,003 kg

# 14 Accessories

## Mushroom-head cap, Plastic

### Additional Information

- To obtain IP 67 use marking plate Part No. 704.609.9





Mushroom-head cap		Part No.	Weight
	<b>Mushroom-head cap round, 40 mm</b>		
Plastic black		<b>704.604.0</b>	0,001 kg
	<b>Mushroom-head cap round, 40 mm</b>		
Plastic red		<b>704.604.2</b>	0,001 kg
	<b>Mushroom-head cap round, 40 mm</b>		
Plastic yellow		<b>704.604.4</b>	0,001 kg
	<b>Mushroom-head cap round, 40 mm</b>		
Plastic green		<b>704.604.5</b>	0,001 kg



**Mushroom-head cap illuminated, Plastic**





**Additional Information**

- To obtain IP 67 use marking plate Part No. 704.609.9

Mushroom-head cap	Part No.	Weight
 <p><b>Mushroom-head cap illuminated round, 40 mm</b></p>		
Plastic red	<b>704.614.2</b>	0,007 kg
 <p><b>Mushroom-head cap illuminated round, 40 mm</b></p>		
Plastic yellow	<b>704.614.4</b>	0,007 kg
 <p><b>Mushroom-head cap illuminated round, 40 mm</b></p>		
Plastic green	<b>704.614.5</b>	0,007 kg
 <p><b>Mushroom-head cap illuminated round, 40 mm</b></p>		
Plastic blue	<b>704.614.6</b>	0,007 kg
 <p><b>Mushroom-head cap illuminated round, 40 mm</b></p>		
Plastic colourless	<b>704.614.7</b>	0,007 kg

# 14 Accessories



## Marking plate

Marking plate illumination	Marking plate	Part No.	Weight
	<b>Marking plate for lens plastic and metal</b>		
non-illuminative	black opaque	<b>704.609.0</b>	0,001 kg
	<b>Marking plate for lens plastic and metal</b>		
illuminative	colourless transparent ripped	<b>704.609.7</b>	0,001 kg
	<b>Marking plate for lens plastic and metal</b>		
illuminative	white translucent	<b>704.609.9</b>	0,001 kg
	<b>Legend plate for lens plastic</b>		
Halo illumination	white translucent	<b>704.609.9A01</b>	0,001 kg



## Marking plate mushroom-head cap, Plastic

Marking plate illumination	Marking plate	Part No.	Weight
	<b>Marking plate for mushroom-head cap</b>		
illuminative	white translucent	<b>704.609.9</b>	0,001 kg

## Marking plate lens increased

Marking cap illumination	Marking cap	Part No.	Weight
	<b>Marking cap for lens plastic increased</b>		
LED	Plastic colourless ribbed	<b>704.610.7</b>	0,001 kg
	<b>Marking cap for lens plastic increased</b>		
LED and filament lamp	Plastic white	<b>704.610.9</b>	0,001 kg

**Marking cap for lens cap, Plastic**

Marking cap illumination	Marking cap	Part No.	Weight
	<b>Marking cap for lens cap</b>		
LED	Plastic colourless ribbed	<b>704.608.7</b>	0,002 kg
	<b>Marking cap for lens cap</b>		
LED	Plastic white	<b>704.608.9</b>	0,002 kg



**Front bezel set**

**Additional Information**

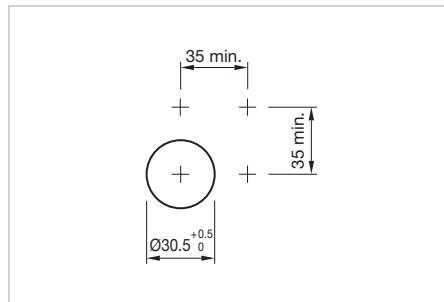
- The colour of anodized aluminium parts can vary due to technical production reasons



Mounting cut-outs [mm]

Front protection	Mounting cut-out	Front bezel	Housing	Part No.	Weight
	<b>Front bezel set, flush design round, 35 mm</b>				
IP67	Ø 30,5 mm	Aluminium black anodized	Plastic black	<b>14-955.0</b>	0,015 kg
	<b>Front bezel set, flush design round, 35 mm</b>				
IP67	Ø 30,5 mm	Aluminium natural anodized	Plastic black	<b>14-955.1</b>	0,015 kg
		Stainless-steel natural	Plastic black	<b>14-955.9</b>	0,033 kg

# 14 Accessories



## Front bezel set mushroom

### Additional Information

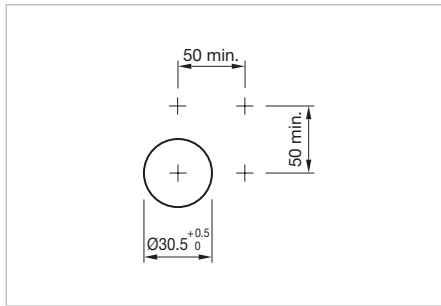
- The colour of anodized aluminium parts can vary due to technical production reasons



Mounting cut-outs [mm]

Front protection	Mounting cut-out	Front bezel	Housing	Part No.	Weight
	<b>Front bezel set for mushroom-head pushbutton, flush design round, 50 mm</b>				
IP67	Ø 30,5 mm	Aluminium natural anodized	Plastic black	<b>14-958.8</b>	0,042 kg
	<b>Front bezel set for mushroom-head pushbutton, flush design round, 50 mm</b>				
IP67	Ø 30,5 mm	Aluminium black anodized	Plastic black	<b>14-958.0</b>	0,042 kg



**Front bezel set protective membrane, IP67**

**Additional Information**

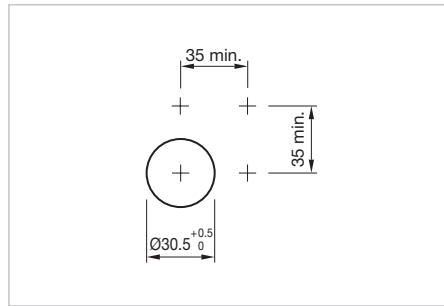
- For Illuminated pushbutton for front protection IP 67
- Front ring to be mounted with a torque of 40 Ncm onto actuator
- Before assembling remove the flat gasket of the switch
- The colour of anodized aluminium parts can vary due to technical production reasons



Mounting cut-outs [mm]





Product attribute	Mounting cut-out	Front bezel	Housing	Part No.	Weight
	<b>Front bezel set with protective membrane, flush design round, 35 mm</b>				
with transparent silicone membrane	Ø 30,5 mm	Aluminium natural anodized	Plastic black	<b>14-955.3</b>	0,015 kg
	<b>Front bezel set with protective membrane, flush design round, 35 mm</b>				
with transparent silicone membrane	Ø 30,5 mm	Aluminium black anodized	Plastic black	<b>14-955.4</b>	0,015 kg
	<b>Front bezel set with protective membrane, flush design round, 35 mm</b>				
with transparent silicone membrane, resistant to sea water	Ø 30,5 mm	Stainless-steel natural	Plastic black	<b>14-955.9E</b>	0,033 kg

# 14 Accessories

## Front ring





### Additional Information

- The colour of anodized aluminium parts can vary due to technical production reasons

Front ring	Part No.	Weight
 <p><b>Front ring round, 29 mm</b></p>		
Plastic black	<b>704.600.0</b>	0,003 kg
 <p><b>Front ring round, 29 mm</b></p>		
Aluminium natural anodized	<b>704.600.1</b>	0,005 kg
 <p><b>Front ring round, 29 mm</b></p>		
Aluminium black anodized	<b>704.600.1A</b>	0,005 kg
 <p><b>Front ring round, 29 mm</b></p>		
Plastic lightgrey	<b>704.600.6</b>	0,003 kg
 <p><b>Front ring round, 29 mm</b></p>		
Stainless-steel natural	<b>704.600.9</b>	0,006 kg

**Front ring mushroom-head pushb.****Additional Information**

- The colour of anodized aluminium parts can vary due to technical production reasons

Front ring	Part No.	Weight
 <p><b>Front ring for mushroom-head pushbutton round, 29 mm</b></p> <p>Plastic black</p>	<b>704.600.0</b>	0,003 kg
 <p><b>Front ring for mushroom-head pushbutton round, 29 mm</b></p> <p>Aluminium natural anodized</p>	<b>704.600.1</b>	0,005 kg
 <p><b>Front ring for mushroom-head pushbutton round, 29 mm</b></p> <p>Aluminium black anodized</p>	<b>704.600.1A</b>	0,005 kg
 <p><b>Front ring for mushroom-head pushbutton round, 29 mm</b></p> <p>Plastic lightgrey</p>	<b>704.600.6</b>	0,003 kg
 <p><b>Front ring for mushroom-head pushbutton round, 29 mm</b></p> <p>Stainless-steel natural</p>	<b>704.600.9</b>	0,006 kg

# 14 Accessories

## Front protective cap, IP68

### Additional Information

- For Indicator and Illuminated pushbutton for IP 68 protection

Product attribute	Material	Colour	Optics	Part No.	Weight
 <p><b>Front protective cap</b></p>					
only together with lenses Part No. 704.602.X, 704.601.X and front rings Part No. 704.600.X	Silicone	colourless	transparent	<b>704.953.0</b>	0,002 kg

## Front protective ring, IP67

### Additional Information

- For Illuminated pushbutton with front illumination for IP 67 protection
- Front protective ring to be mounted with a torque of 40 Ncm onto actuator
- The colour of anodized aluminium parts can vary due to technical production reasons

Product attribute	Material	Colour	Part No.	Weight
 <p><b>Front protective ring</b></p>				
with transparent silicone membrane (extent resistant to sea water), temperature resistance -40 °C ... +85 °C	Brass	chrome	<b>704.600.2</b>	0,005 kg
with transparent silicone membrane (extent resistant to sea water), temperature resistance -40 °C ... +85 °C	Aluminium	natural anodized	<b>704.600.3</b>	0,005 kg
with transparent Pebax membrane, temperature resistance -40 °C ... +85 °C	Aluminium	natural anodized	<b>704.600.5/A</b>	0,005 kg



**Legend frame**

**Additional Information**

- The colour of anodized aluminium parts can vary due to technical production reasons

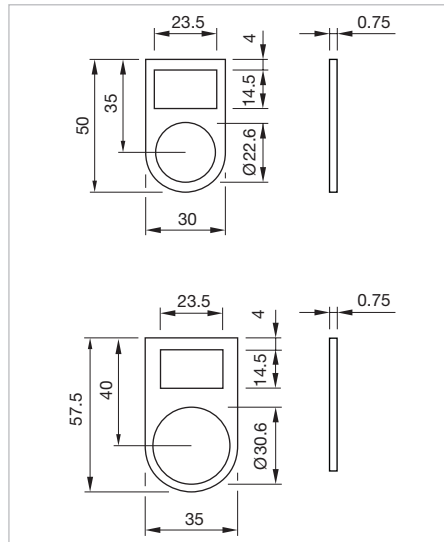



Dimensions [mm]

Product attribute	Dimension	Material	Colour	Mounting type	Part No.	Weight
	<b>Legend frame</b>					
for raised design	30 x 50 x 0.75 mm	Aluminium	black anodized	self-adhesive	<b>704.968.2</b>	0,001 kg
for flush design	35 x 57.5 x 0.75 mm	Aluminium	black anodized	self-adhesive	<b>704.968.3</b>	0,001 kg

**Legend plate**

**Additional Information**

- For legend frame Part No.704.968.2 and 704.968.3
- The colour of anodized aluminium parts can vary due to technical production reasons

Dimension	Material	Colour	Mounting type	Part No.	Weight
	<b>Legend plate for legend frame</b>				
14.5 x 23.5 mm	Aluminium	natural anodized	self-adhesive	<b>704.968.0</b>	0,001 kg
	<b>Legend plate for legend frame</b>				
14.5 x 23.5 mm	Aluminium	black anodized	self-adhesive	<b>704.968.1</b>	0,001 kg

# 14 Accessories



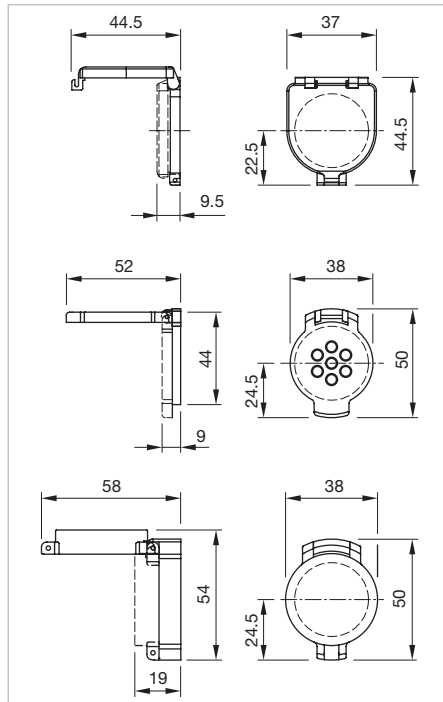

## Protective cover flush design, IP65

### Additional Information

- Hinged
- Front panel thickness reduced by 2 mm
- The Dimensions [mm] of the Mounting cut-outs [mm] are shown in the product details
- Please note that bigger minimum distances are necessary
- The colour of anodized aluminium parts can vary due to technical production reasons



Dimensions [mm]

Product attribute	Dimension	Material	Colour	Optics	Part No.	Weight
 <p><b>Protective cover round, flush design</b></p> <p>with means for sealing, for pushbutton with mounting cut-outs Ø 30.5 mm</p>	37 x 44.5 mm	Plastic	colourless	transparent	<b>704.925.7</b>	0,006 kg
 <p><b>Protective cover round, flush design</b></p> <p>not with means for sealing, with spring fitted, with window, for pushbutton with mounting cut-outs Ø 30.5 mm</p>	38 x 50 mm	Aluminium	natural anodized		<b>704.928.18</b>	0,019 kg
 <p><b>Protective cover round, flush design</b></p> <p>with means for sealing, for pushbutton and selector switch short lever with mounting cut-outs Ø 30.5 mm</p>	38 x 50 mm	Aluminium	natural anodized		<b>704.928.28</b>	0,019 kg
 <p><b>Protective cover round, flush design</b></p> <p>with means for sealing, for pushbutton and selector switch short lever with mounting cut-outs Ø 30.5 mm</p>	38 x 50 mm	Aluminium	natural anodized		<b>704.928.38</b>	0,019 kg



**Protective cover raised design, IP65**

**Additional Information**

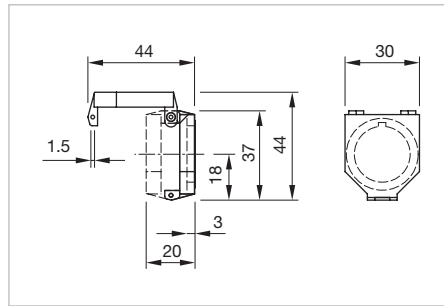
- hinged, with means for sealing
- Protection cover Part No. 704.925.2 only for selector switches in basic position A applicable
- Front panel thickness reduced by 3 mm
- The Dimensions [mm] of the Mounting cut-outs [mm] are shown in the product details
- Please note that bigger minimum distances are necessary



Dimensions [mm]

Product attribute	Mounting cut-out	Material	Optics	Part No.	Weight
 <p><b>Protection cover round, raised design</b></p>					
for pushbutton	Ø 22,3 mm	Plastic	transparent	<b>704.925.0</b>	0,007 kg
with spring fitted, for pushbutton	Ø 22,3 mm	Plastic	transparent	<b>704.925.3</b>	0,007 kg
 <p><b>Protection cover round, raised design</b></p>					
for selector switch	Ø 22,3 mm	Plastic	transparent	<b>704.925.2</b>	0,007 kg

# 14 Accessories

## Blind plug, IP65

### Additional Information

- The Dimensions [mm] of the Mounting cut-outs [mm] are shown in the product details
- Please note that bigger minimum distances are necessary

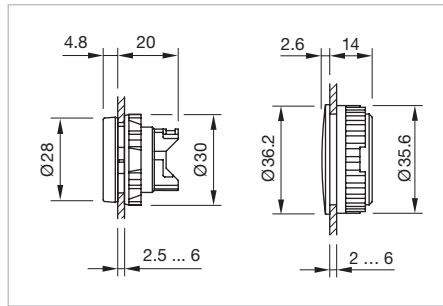

Dimensions [mm]

Dimension	Mounting cut-out	Material	Colour	Part No.	Weight
 <b>Blind plug</b>					
Ø 28 mm	Ø 22,3 mm	Plastic	black	<b>704.960.4</b>	0,004 kg
 <b>Blind plug</b>					
Ø 36 mm	Ø 30,5 mm	Plastic	black	<b>704.964.8</b>	0,007 kg

## Spare key

### Additional Information

- Standard lock KABA 1001
- Optional lock numbers on request

Product attribute	Part No.	Weight
 <b>Spare key</b>		
Standard lock KABA 1001	<b>14-987.1001</b>	0,006 kg

Rear side



PCB plug-in base

Additional Information

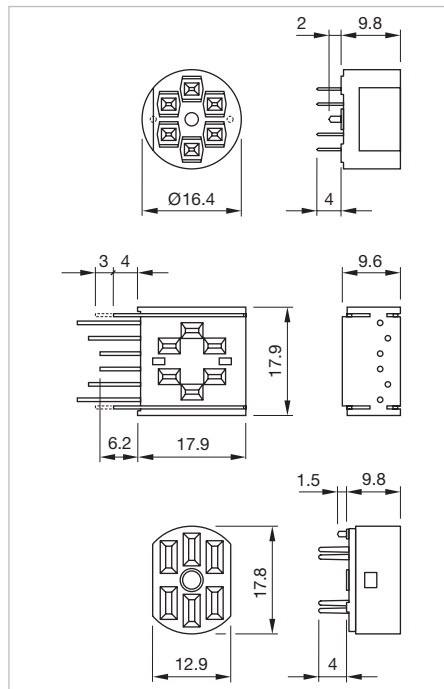
- PCB plug-in base pins right-angle: With the extendable mounting the distance between plug-in base and PCB can be varied up to 3 mm





Dimensions [mm]

Product attribute	Pins	Terminal	Part No.	Component layout	Weight
 <p><b>PCB plug-in base</b></p>					
For low level switching element	axial	PCB	<b>31-940</b>	3	0,002 kg
 <p><b>PCB plug-in base</b></p>					
For low level switching element	right-angled	PCB	<b>31-941</b>	1	0,004 kg
 <p><b>PCB plug-in base</b></p>					
For snap-action switching element 2.8 mm	axial	PCB	<b>31-942</b>	2	0,002 kg

The component layouts you will find from page 110

# 14 Accessories

## Flat receptacle

Product attribute	Part No.	Weight
 <p><b>Flat receptacle</b></p>		
2.0 x 0.5 mm plug-in terminal	<b>31-945</b>	0,001 kg
 <p><b>Flat receptacle</b></p>		
2.8 x 0.5 mm plug-in terminal	<b>31-946</b>	0,001 kg

## Insulation sleeve

Product attribute	Material	Part No.	Weight
 <p><b>Insulation sleeve</b></p>			
Cover plug-in terminals for snap-action switching element 2.8 mm	Plastic	<b>01-928</b>	0,001 kg
 <p><b>Insulation sleeve</b></p>			
for flat receptacle 2.0 mm	Plastic	<b>31-928</b>	0,001 kg
 <p><b>Insulation sleeve</b></p>			
for flat receptacle 2.8 mm	Plastic	<b>31-929</b>	0,001 kg

## Terminal cover

### Additional Information

- For snap-action switching element

Part No.	Weight
 <p><b>Terminal cover for snap-action switching element 16</b></p>	
<b>01-929</b>	0,010 kg

**Illumination**

**Single-LED, T5.5**

**Additional Information**

- For LED element fitting information see «Application guidelines, LED polarity»
- Due to high surface temperatures, the series resistor must not be soldered directly to the terminals of the equipment (use a terminal plate)
- When using AC/DC types with AC operation, slight flickering can occur
- Luminous intensity data of the LEDs on direct voltage
- Electrical and optical data are measured at 25 °C
- The specified versions are built with a protection diode (half wave rectifier) in series and the LED
- Luminosity and wave length variations caused by LED manufacturing processes may cause slight differences regarding the illumination
- For supply voltages above 48 V, it is necessary to use a voltage reduction element (external series resistor or transformer)

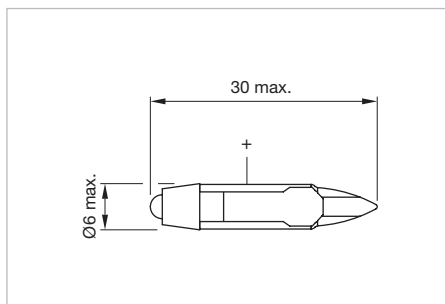

Dimensions [mm]

LED colour	Operating voltage	Operation current	Lumi. intensity	Dom. wavelength	Part No.	Weight
 <p><b>Single-LED</b></p>						
red	6 VDC +10 %	15 mA ±15 %	350 mcd	630 nm	<b>10-2106.3142</b>	0.001 kg
	12 VAC/DC +10 %	7/14 mA ±15 %	330 mcd	630 nm	<b>10-2109.1062</b>	0.001 kg
	24 VAC/DC +10 %	7/14 mA ±15 %	330 mcd	630 nm	<b>10-2112.1062</b>	0.001 kg
	28 VAC/DC +10 %	7/14 mA ±15 %	330 mcd	630 nm	<b>10-2113.1062</b>	0.001 kg
	48 VAC/DC +10 %	4/8 mA ±15 %	200 mcd	630 nm	<b>10-2119.1042</b>	0.001 kg
yellow	6 VDC +10 %	15 mA ±15 %	300 mcd	587 nm	<b>10-2106.3144</b>	0.001 kg
	12 VAC/DC +10 %	7/14 mA ±15 %	280 mcd	587 nm	<b>10-2109.1064</b>	0.001 kg
	24 VAC/DC +10 %	7/14 mA ±15 %	280 mcd	587 nm	<b>10-2112.1064</b>	0.001 kg
	28 VAC/DC +10 %	7/14 mA ±15 %	280 mcd	587 nm	<b>10-2113.1064</b>	0.001 kg
	48 VAC/DC +10 %	4/8 mA ±15 %	180 mcd	587 nm	<b>10-2119.1044</b>	0.001 kg
green	6 VDC +10 %	7 mA ±15 %	1050 mcd	525 nm	<b>10-2106.3145</b>	0.001 kg
	12 VAC/DC +10 %	4/7 mA ±15 %	1050 mcd	525 nm	<b>10-2109.1065</b>	0.001 kg
	24 VAC/DC +10 %	4/7 mA ±15 %	1050 mcd	525 nm	<b>10-2112.1065</b>	0.001 kg
	28 VAC/DC +10 %	4/7 mA ±15 %	1050 mcd	525 nm	<b>10-2113.1065</b>	0.001 kg
	48 VAC/DC +10 %	2/4 mA ±15 %	600 mcd	525 nm	<b>10-2119.1045</b>	0.001 kg
blue	6 VDC +10 %	15 mA ±15 %	680 mcd	470 nm	<b>10-2106.3146</b>	0.001 kg
	12 VAC/DC +10 %	7/14 mA ±15 %	650 mcd	470 nm	<b>10-2109.1066</b>	0.001 kg
	24 VAC/DC +10 %	7/14 mA ±15 %	650 mcd	470 nm	<b>10-2112.1066</b>	0.001 kg
	28 VAC/DC +10 %	7/14 mA ±15 %	650 mcd	470 nm	<b>10-2113.1066</b>	0.001 kg
	48 VAC/DC +10 %	4/8 mA ±15 %	400 mcd	470 nm	<b>10-2119.1046</b>	0.001 kg

# 14 Accessories

LED colour	Operating voltage	Operation current	Lumi. intensity	Dom. wavelength	Part No.	Weight
white	6 VDC +10 %	6 mA ±15 %	900 mcd	x0.31/y0.32 nm	<b>10-2106.3149</b>	0.001 kg
	12 VAC/DC +10 %	3/6 mA ±15 %	900 mcd	x0.31/y0.32 nm	<b>10-2109.1069</b>	0.001 kg
	24 VAC/DC +10 %	2.5/5 mA ±15 %	750 mcd	x0.31/y0.32 nm	<b>10-2112.1069</b>	0.001 kg
	28 VAC/DC +10 %	2.5/5 mA ±15 %	750 mcd	x0.31/y0.32 nm	<b>10-2113.1069</b>	0.001 kg
	48 VAC/DC +10 %	2/4 mA ±15 %	600 mcd	x0.31/y0.32 nm	<b>10-2119.1049</b>	0.001 kg

## Filament lamp, T5.5

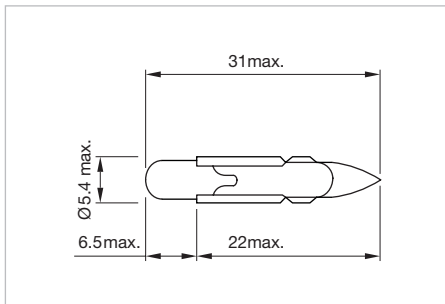

Dimensions [mm]

Operating voltage	Operation current	Part No.	Weight
 <p><b>Filament lamp</b></p>			
6 VAC/DC	200 mA	<b>10-1106.1369</b>	0,001 kg
12 VAC/DC	100 mA	<b>10-1109.1329</b>	0,001 kg
24 VAC/DC	50 mA	<b>10-1112.1279</b>	0,001 kg
28 VAC/DC	40 mA	<b>10-1113.1249</b>	0,001 kg
30 VAC/DC	40 mA	<b>10-1114.1249</b>	0,001 kg
36 VAC/DC	35 mA	<b>10-1116.1229</b>	0,001 kg
48 VAC/DC	25 mA	<b>10-1119.1199</b>	0,001 kg



**Series resistor**

**Additional Information**

- Only for filament lamp 48 VAC, 25 mA
- For lamp voltage reduction
- Keep to the country specific safety instructions
- Due to high surface temperatures, the series resistor must not be soldered directly to the terminals of the equipment (use a terminal plate)

Product attribute	Operating voltage	Resistance	Part No.	Weight
 <p><b>Series resistor</b></p>				
Wire resistance 2,7 kOhm	110 VAC	2,7 kOhm	<b>02-904.0</b>	0,003 kg
Wire resistance 3,3 kOhm	125 VAC	3,3 kOhm	<b>02-904.1</b>	0,003 kg
Wire resistance 4,7 kOhm	145 VAC	4,7 kOhm	<b>02-904.3</b>	0,003 kg
Wire resistance 10 kOhm	240 VAC	10 kOhm	<b>02-904.7</b>	0,003 kg

**Terminal plate empty**

**Additional Information**

- For fitting with series resistors

Product attribute	Dimension	Part No.	Weight
 <p><b>Terminal plate empty</b></p>			
5 spaces	62.5 x 60 x 15 mm	<b>02-912.1</b>	0,025 kg
10 spaces	125 x 60 x 15 mm	<b>02-912.2</b>	0,045 kg
15 spaces	187.6 x 60 x 15 mm	<b>02-912.3</b>	0,090 kg
20 spaces	250 x 60 x 15 mm	<b>02-912.4</b>	0,095 kg

# 14 Accessories

## Mounting

### Positioning insert

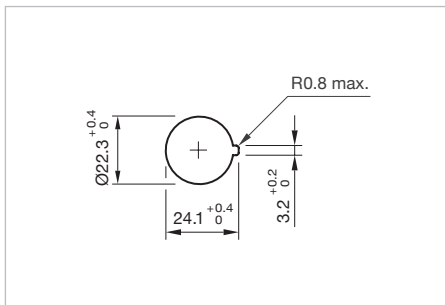

Mounting cut-outs [mm]

Part No.	Weight
 <p><b>Positioning insert</b></p>	
14-910	0,001 kg



### Anti-twist ring

Mounting cut-out	Material	Part No.	Weight
 <p><b>Anti-twist ring, flush design</b></p>			
Ø 30,5 mm	Steel sheet	704.954.0	0,002 kg

**Reducing ring**

**Additional Information**

- You need to install two reduction rings
- For mounting of Ø 22.5 mm device into Ø 30.5 mm mounting cut-out
- The colour of anodized aluminium parts can vary due to technical production reasons

Mounting cut-out	Material	Colour	Part No.	Weight
	<b>Reducing ring</b>			
Ø 22,3 / Ø 30,5 mm	Aluminium	black anodized	<b>704.960.0</b>	0,004 kg
	<b>Reducing ring</b>			
Ø 22,3 / Ø 30,5 mm	Aluminium	natural anodized	<b>704.960.8</b>	0,004 kg

**Lens plug**

**Additional Information**

- For mounting and dismantling of the round lens, flush design

Product attribute	Part No.	Weight
	<b>Lens plug for round lens, flush design</b>	
Lamp, LED and lens remover for Series 04, 14, flush design	<b>700.006.0</b>	0,003 kg

**Lamp remover**

**Additional Information**

- ▲ **Caution:** A switching process might be released when replacing the lamp

Product attribute	Part No.	Weight
	<b>Lamp remover</b>	
Lamp and LED remover for Series 04, 14	<b>02-906</b>	0,002 kg

# 14 Accessories



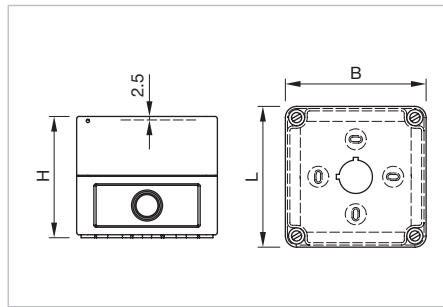

## Enclosure, IP66

### Additional Information

- Cover lead-sealable
- Openings for cable gland M16 or M20



Dimensions [mm]

Product attribute	Dimension	Material	Colour	Part No.	Weight
 <p><b>Enclosure</b></p> <p>With mounting cut-out 1 x Ø 22.5 mm, with anti-rotation device, observe the IP degree of protection for components</p>	L 94 x B 94 x H 81 mm	Plastic	grey, similar RAL 7035	<b>704.945.1</b>	0,211 kg
 <p><b>Enclosure</b></p> <p>With mounting cut-out 2 x Ø 22.5 mm, with anti-rotation device, observe the IP degree of protection for components</p>	L 130 x B 94 x H 81 mm	Plastic	grey, similar RAL 7035	<b>704.945.2</b>	0,251 kg
 <p><b>Enclosure</b></p> <p>With mounting cut-out 3 x Ø 22.5 mm, with anti-rotation device, observe the IP degree of protection for components</p>	L 180 x B 94 x H 81 mm	Plastic	grey, similar RAL 7035	<b>704.945.3</b>	0,313 kg
 <p><b>Enclosure</b></p> <p>With mounting cut-out 4 x Ø 22.5 mm, with anti-rotation device, observe the IP degree of protection for components</p>	L 180 x B 182 x H 110 mm	Plastic	grey, similar RAL 7035	<b>704.945.4</b>	0,572 kg
 <p><b>Enclosure</b></p> <p>With mounting cut-out 6 x Ø 22.5 mm, with anti-rotation device, observe the IP degree of protection for components</p>	L 180 x B 182 x H 110 mm	Plastic	grey, similar RAL 7035	<b>704.945.5</b>	0,568 kg

**Cable gland, IP68****Additional Information**

- With traction relief
- With fixing nut

Product attribute	Thread	Material	Colour	Part No.	Weight
 <p><b>Cable gland</b></p>					
Clamping range Ø 4 ... 10 mm, thread length 8 mm	M16 x 1,5	Plastic	grey, similar RAL 7035	<b>61-9481.6</b>	0,007 kg
Clamping range Ø 6 ... 12 mm, thread length 9 mm	M20 x 1,5	Plastic	grey, similar RAL 7035	<b>704.945.6</b>	0,011 kg

# 14 Drawings

## Drawings

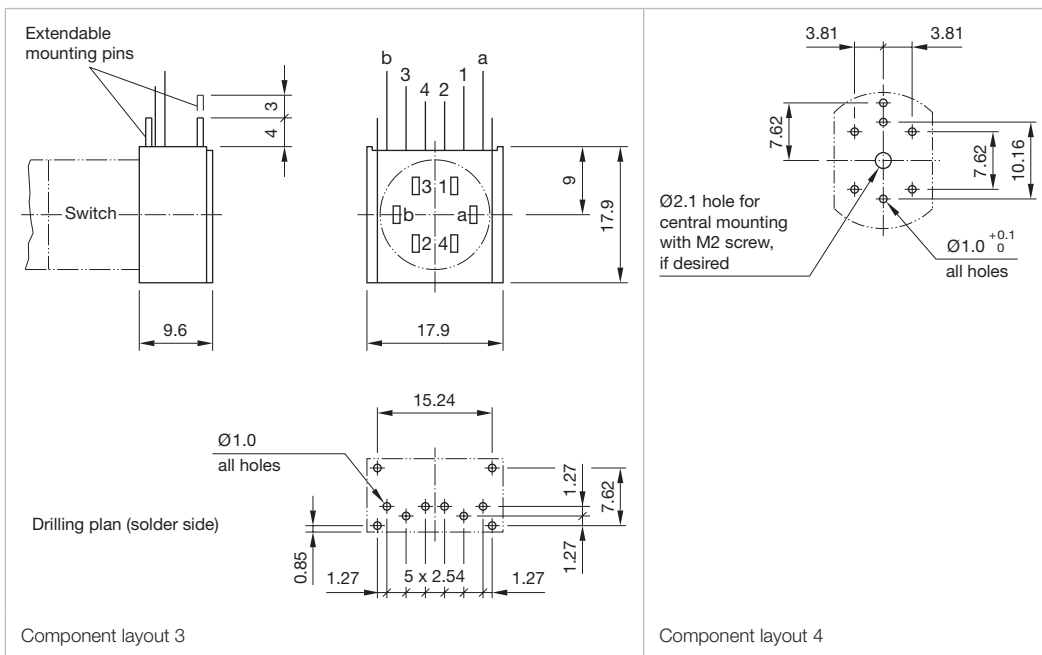
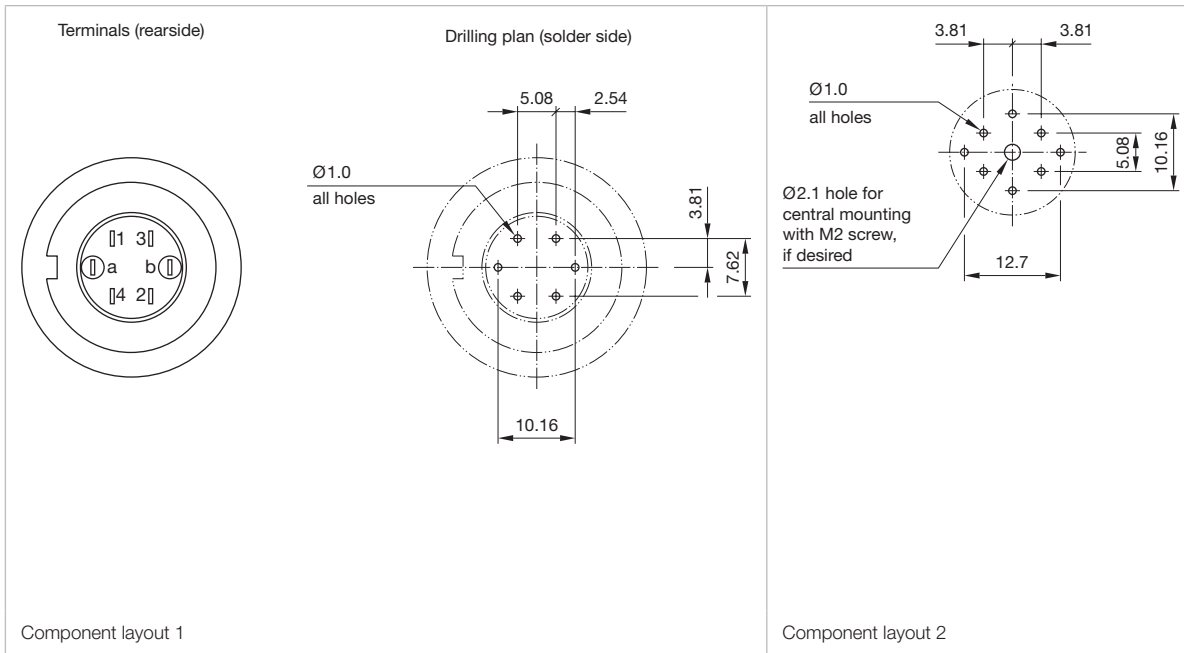

**Actuator with snap-action switching element**
**Switching system**

Self-cleaning, double-break, snap action switching system (with contact gap 2 x 0.5 mm).

1 normally closed or 1 normally open contact per element.

Snap-action switching elements with soldering terminals at the sides: up to 4 switching element can be on a pushbutton (max. 4 normally closed and 4 normally open contacts).

Snap-action switching element with axial plug-in terminals 2.8 mm stackable, only 1 switching element can be on a pushbutton.

**Material**
**Material of contact**

Gold plated silver

**Switch housing**

Plug-in-/soldering terminal

Diallylphthalate DAP, Polyamide 66, Polysulfone, heat-resistant and self-extinguishing

Soldering terminal: PA 6.6 Ultramide

**Actuator housing**

Polyamide

**Mechanical characteristics**
**Terminals**

Snap-action switching element with tinned soldering terminals at the sides:

Max. wire diameter 2 wires à 1.2 mm

max. wire cross-section of stranded cable 1 x 1 mm<sup>2</sup>

Snap-action switching element with axial plug-in terminals, which can also be used as soldering terminals: Plug-in terminal 2.8 x 0.5 mm

Soldering terminal:

Max. wire diameter 2 wires of 1 mm

Max. wire cross-section of stranded cable 2 x 0.75 mm<sup>2</sup> or 1 x 1.0 mm<sup>2</sup>

**Tightening torque**

for fixing nut max. 25 Ncm

**Actuating torque**

Measured at the key or lever of the keylock- or selector switch 2.5 Ncm ... 5.5 Ncm, depending on the number of switching elements

**Actuating force**

Maintain 5 N ... 8 N

Momentary 3 N ... 6 N

depending on the number of switching elements

**Actuating travel**

Illuminated pushbutton: 3 mm

Switch actuator 2 positions:

Momentary action 1 x ca. 42° deflection momentary action

Maintained action 1 x ca. 90° deflection maintained action

**Rebound time**

≤ 5 ms

**Mechanical lifetime**

Momentary action 2 million Cycles of operation

Maintained action 1 million Cycles of operation

**Electrical characteristics**
**Standards**

The devices comply with: EN IEC 61058-1

**Rated voltage**

250 VAC as per EN IEC 61058-1-15

**Contact resistance**

New state ≤ 50 mΩ as per DIN IEC 60512-2-4

**Electrostatic discharge (ESD)**

Keylock switch 15 kV

**Rated current**

5 A

**Conventional free air thermal current I<sub>th</sub>**

5 A

The maximum current in continuous operation and at ambient temperature not exceeding the quoted maximum values.

**Switch rating**

250 VAC, 5 A (cos φ 1)

250 VAC, 3 A (cos φ 0.3)

Switch rating DC (inductive) L:R = 30 ms

Voltage 24 VDC 60 VDC 110 VDC 220 VDC

Current 2 A 0.7 A 0.2 A 0.1 A

**Electric strength**

3000 VAC, 50 Hz, 1 min. between all terminals and earth, as per EN IEC 61058-1-15

**Isolation resistance**

> 7 MΩ between the open contacts at 500 VDC, as per EN IEC 61058-1-15 (reinforced insulation)

**Protection class**

II

**Environmental conditions**
**Storage temperature**

-40 °C ... +85 °C

**Service temperature**

-25 °C ... +55 °C

For indicators and illuminated pushbuttons mounted as a block, make sure the heat can escape freely.

# 14 Technical data

## Protection degree

as per EN IEC 60529  
Indicator front side IP 67  
Illuminated pushbutton front side IP 67  
Mushroom-head pushbutton front side IP 67  
Selector switch front side IP 67  
Keylock switch IP 65 front side

## Shock resistance

(semi-sinusoidal)  
max. 150m/s<sup>2</sup>, pulse width 11 ms, 3-axis, as per  
EN IEC 60068-2-27

## Vibration resistance

(sinusoidal)  
max. 100m/s<sup>2</sup> at 10Hz...500Hz, as per EN IEC 60068-2-6

## Climate resistance

Damp heat state as per EN IEC 60068-2-78  
Damp heat cyclic as per EN IEC 60068-2-30

## Approvals

### Approbations

CB (IEC 61058)  
CSA  
CQC  
ENEC (EN 61058)  
Germanischer Lloyd  
UL

### Declaration of conformity

CE

## Actuator with low level switching element

### Switching system

This low level switching element was designed for switching low powers in electronic circuits. The mechanism assures reliable switching of loads ranging from a few  $\mu\text{A}/\mu\text{V}$  up to 100mA/42VAC/DC.

Single-break momentary contact, as normally open or normally closed with 4 independent points of contact. 2 momentary contacts per switching element; combination of normally open and normally closed is possible.

Special features are the long life, extremely short rebound time and stable contact resistance.

### Material

#### Material of contact

Gold plated

#### Switch housing

Polysulfone, heat-resistant and self-extinguishing

#### Actuator housing

Polyamide

### Mechanical characteristics

#### Terminals

The universal terminals permit these units to be mounted on printed circuit boards (PCB). These terminals can also be used as soldering or plug-in terminals.

For these terminals we can also supply a plug-in base which, when soldered on to the board, enables the switch to be plugged in.

Soldering terminal:

Max. wire diameter 2 wires of 1 mm

Max. wire cross-section of stranded cable 2 x 0.75 mm<sup>2</sup>

Plug-in terminal: 2.0 x 0.5 mm

#### Tightening torque

for fixing nut max. 25Ncm

### Actuating torque

Measured at the key or lever of the keylock- or selector switch 2.5Ncm...5.5Ncm, depending on the number of switching elements

### Actuating force

3...4N, depending on the number of switching elements

### Actuating travel

Illuminated pushbutton: 3 mm

Switch actuator 2 positions:

Momentary action 1 x ca. 42° deflection momentary action

Maintained action 1 x ca. 90° deflection maintained action

### Rebound time

typical < 100 $\mu\text{s}$

### Mechanical lifetime

Momentary action 5 million cycles of operation

Maintained action 1 million cycles of operation

### Electrical characteristics

#### Contact resistance

New state  $\leq 50\text{m}\Omega$  as per DIN IEC 60512-2-4

#### Electrostatic discharge (ESD)

Keylock switch 15kV

#### Switch rating

10 $\mu\text{A}$ , 100 $\mu\text{V}$  to 100mA at 42VAC/VDC

#### Electric strength

3000VAC, 50Hz, 1 min. between all terminals and earth, as per EN IEC 61058-1-15

#### Protection class

II



### Environmental conditions

#### Storage temperature

-40 °C ... +85 °C

#### Service temperature

-25 °C ... +55 °C

For indicators and illuminated pushbuttons mounted as a block, make sure the heat can escape freely.

### Protection degree

as per EN IEC 60529

Indicator front side IP 67

Illuminated pushbutton front side IP 67

Mushroom-head pushbutton front side IP 67

Selector switch front side IP 67

Keylock switch IP 65 front side

### Shock resistance

(semi-sinusoidal)

max. 150 m/s<sup>2</sup>, pulse width 11 ms, 3-axis, as per EN IEC 60068-2-27

## Buzzer

### Buzzer system

#### System

Piezo disc

### Material

#### Buzzer case

Polyamide

#### Front cap

Plastic Polyamide

Metal Nickel-plated brass (sea-water proof)

### Mechanical characteristics

#### Terminals

Plug-in terminal 2.8 x 0.5 mm

#### Tightening torque

for fixing nut max. 25 Ncm

### Electrical characteristics

#### Frequency (tone)

approx. 2.8 kHz continuous tone only

#### Sound pressure

95 db (A) ±8 dB at a distance of 0.1 m

#### Operation Voltage/Current

Operation Voltage 24 VDC ±10 %

Operation Current ≤ 25 mA

### Environmental conditions

#### Storage temperature

-40 °C ... +85 °C

#### Operating temperature

-25 °C ... +55 °C

### Protection degree

as per EN IEC 60529

Buzzer front side IP 65

### Approvals

#### Approbations

CQC

EMC

### Declaration of conformity

CE

# 14 Technical data

## Indicator compact

### Material

#### Lens cap

Polyamide (PA)

#### Housing

Polyamide (PA)

### Mechanical characteristics

#### Terminals

PIT push-in terminal

Skinning 8 mm

Wire cross-section:

Wire 0.2 to 1.0 mm<sup>2</sup>

Stranded wire 0.2 to 1.0 mm<sup>2</sup> without core and sleeve

Stranded wire 0.2 to 0.75 mm<sup>2</sup> with core and sleeve

#### Tightening torque

for fixing nut min. 0.8Nm

#### Protection degree

as per EN IEC 60529

IP65, IP67, IP69K front side

IP20 rear side

#### Shock resistance

(semi-sinusoidal)

max. 300 m/s<sup>2</sup>, puls width 18 ms, as per EN IEC 60068-2-27

#### Vibration resistance

(sinusoidal)

max. 100 m/s<sup>2</sup> at 10 Hz ... 500 Hz, as per EN IEC 60068-2-6

### Electrical characteristics

#### Operation Voltage

24 VAC/DC (14...32 VAC/DC)

#### Operating current

< 50mA

#### lifetime

50 000 h

### Environmental conditions

#### Climatic conditions

Damp heat, constant

56 days, +40°C/93% relative humidity

as per EN 60068-2-78

Rapid temperature changes

5 cycles, -40°C to +85°C, as per EN 60068-2-14

#### Operating temperature

-25°C to +60°C

#### Storage temperature

-40°C to +85°C

### Approvals

#### Approbations

UL (follows)

#### Declaration of conformity

CE

*EAO reserves the right to alter specifications without further notice.*

## General notes

### 1. Engraving

In addition to the most commonly used world languages, in DIN1451-3 close spacing, other typefaces are available as Scandinavian, Slavic, Greek, Russian and Polish. The engraved marking caps and plates are filled with black or white colour. Standard height of letters is 3 mm. If the height is not specified, we will supply 3mm engraved letters.

### 2. Hot stamping

Standard legends and ISO symbols are hot stamped. For larger series it is worth considering markings by means of hot stamping. We will be pleased to advise you.

## Engraving marking cap for Indicator round, full face illumination

All dimensions in mm

Height of letters	Number of lines	Number of letters per line (target value)			Line spacing
		b1	b2	b3	
h		b1	b2	b3	d
3	3	11	10	9	4.6
4	2	8	7	-	6.6
8	1	4	-	-	-

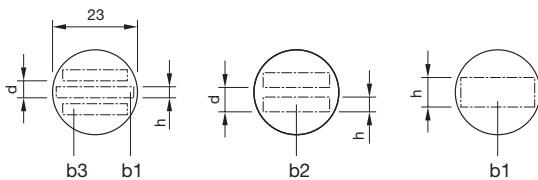

The gap between two words results in each case a letter less.

## Engraving marking cap for Indicator and illuminated Pushbutton round, front illumination

All dimensions in mm

Height of letters	Number of lines	Number of letters per line (target value)			Line spacing
		b1	b2	b3	
h		b1	b2	b3	d
3	3	9	9	7	4.6
4	2	7	6	-	6.6
8	1	3	-	-	-

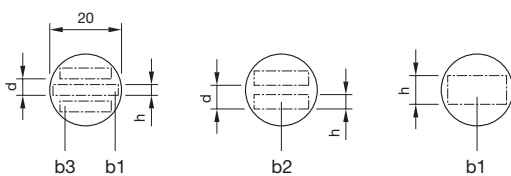

The gap between two words results in each case a letter less.

# 14 Marking

## Engraving legend plates

All dimensions in mm

Dimension	Devices mounting style	Height of letters	Number of lines	Number of letters per line (target value)	Image
		<b>h</b>			
30 x 50	round, raised	3	2	12	B1
30 x 50	round, raised	4	1	7	B1
30 x 50	round, raised	8	1	4	B1
35 x 57.5	round, flush	3	2	12	B2
35 x 57.5	round, flush	4	1	7	B2
35 x 57.5	round, flush	8	1	4	B2

B1

B2

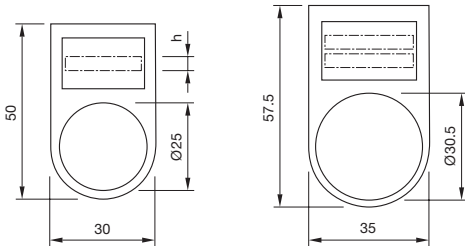

The gap between two words results in each case a letter less.



































## Standard texts for marking plates and marking caps for Indicator and Illuminated Pushbutton

Height of letters 6 mm

Part No. 704.609.912001	Part No. 704.609.912002	Part No. 704.609.912003	Part No. 704.609.912004
Part No. 704.609.912005	Part No. 704.609.912006	Part No. 704.609.912007	Part No. 704.609.912008
Part No. 704.609.912009	Part No. 704.609.912010	Part No. 704.609.912011	Part No. 704.609.912012
Part No. 704.609.912013	Part No. 704.609.912014	Part No. 704.609.912015	Part No. 704.609.912016
Part No. 704.609.912017	Part No. 704.609.912018		

## Symbols for marking plates and marking caps for Indicator and Illuminated Pushbutton

All marking plates with the printed article-numbers are available for flat lenses, marking cap only on request.

 <b>Part No. 704.609.910001</b> Direction of linear rectilinear motion (also for → ↓↑)	 <b>Part No. 704.609.910002</b> Linear motion in 2 directions (also for ↓)	 <b>Part No. 704.609.910004</b> Limited linear motion (also for ← ↑↓)	 <b>Part No. 704.609.910007</b> Direction of continuous rotation (right)
 <b>Part No. 704.609.9100071</b> Direction of continuous rotation (left)	 <b>Part No. 704.609.910008</b> Rotation in 2 directions	 <b>Part No. 704.609.910009</b> Direction of interrupted rotation (right)	 <b>Part No. 704.609.910010</b> Limited rotation (right)
 <b>Part No. 704.609.9100101</b> Limited rotation (left)	 <b>Part No. 704.609.910013</b> Direction of spindle rotation	 <b>Part No. 704.609.910026</b> Rapid traverse	 <b>Part No. 704.609.910028</b> Increase of value (speed, for instance)
 <b>Part No. 704.609.910029</b> Decrease of value (speed, for instance)	 <b>Part No. 704.609.910041</b> Electric motor	 <b>Part No. 704.609.910048</b> Pump (general symbol)	 <b>Part No. 704.609.9100631</b> Lock or tighten
 <b>Part No. 704.609.9100632</b> Lock or tighten	 <b>Part No. 704.609.9100641</b> Unlock, unclamp	 <b>Part No. 704.609.9100642</b> Unlock, unclamp	 <b>Part No. 704.609.910065</b> Brake on
 <b>Part No. 704.609.910066</b> Brake off	 <b>Part No. 704.609.910067</b> Automatic (or semi-automatic) cycle	 <b>Part No. 704.609.910068</b> Hand control	 <b>Part No. 704.609.910069</b> Start, on
 <b>Part No. 704.609.910070</b> Stop, off	 <b>Part No. 704.609.910071</b> Start and stop with same button	 <b>Part No. 704.609.910072</b> In action as long as button is operated	 <b>Part No. 704.609.910074</b> Engaging (mechanical start)
 <b>Part No. 704.609.910075</b> Disengaging (mechanical stop)	 <b>Part No. 704.609.910092</b> Danger (high voltage)!	 <b>Part No. 704.609.910093</b> Caution!	 <b>Part No. 704.609.910101</b> Coolant fluid
 <b>Part No. 704.609.910102</b> Machine lighting	 <b>Part No. 704.609.910108</b> Blast		

# 14 Application guidelines

## Suppressor circuits

When switching inductive loads such as relays, DC motors, and DC solenoids, it is always important to absorb surges (e.g. with a diode) to protect the contacts. When these inductive loads are switched off, a counter emf can severely damage switch contacts and greatly shorten lifetime.

Fig. 1 shows an inductive load with a free-wheeling diode connected in parallel. This free-wheeling diode provides a path for the inductor current to flow when the current is interrupted by the switch. Without this free-wheeling diode, the voltage across the coil will be limited only by dielectric breakdown voltages of the circuit or parasitic elements of the coil. This voltage can be kilovolts in amplitude even when nominal circuit voltages are low (e.g. 12VDC) see Fig. 2.

The free-wheeling diode should be chosen so that the reverse breakdown voltage is greater than the voltage driving the inductive load. The DC blocking voltage ( $V_R$ ) of the free-wheeling diode can be found in the datasheet of a diode. The forward current should be equal or greater than the maximum current flowing through the load.

**To get an efficient protection, the free-wheeling diode must be connected as close as possible to the inductive load!**

Switching with inductive load  
Fig. 1

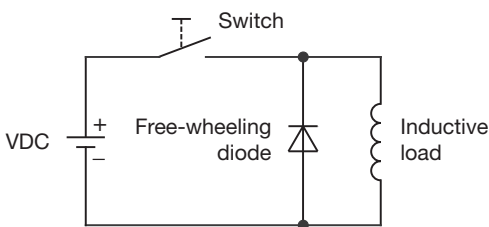

Counter EMF  
over load without free-wheeling diode  
Fig. 2

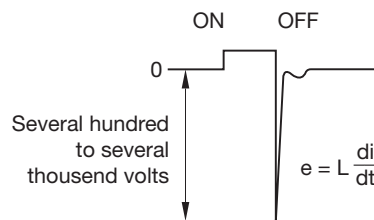

## LED polarity

When fitting the LED elements the polarity has to correspond with the respective terminals, (+) goes to +.

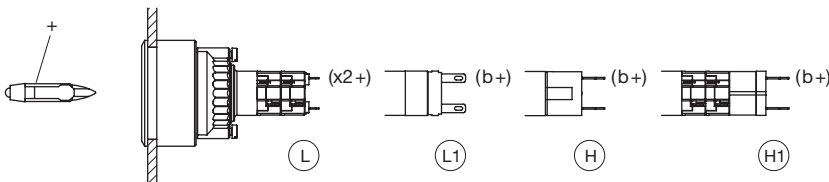

L = Solder terminal, L1 = Solder terminal 2.0 x 0.5 mm  
H = Universal terminal, H1 = Universal-Solder terminal

## Index from Part N0.

Part No.	Page	Part No.	Page	Part No.	Page	Part No.	Page	Part No.	Page	Part No.	Page
01-928	102	14-133.0252	31	14-338.025K2	79	14-501.0220	40	704.600.0	95	704.960.0	107
01-929	102	14-133.0252	67	14-411.036K	35	14-501.0220	80	704.600.1	94	704.960.4	100
02-904.0	105	14-133.0252	71	14-411.036K	77	14-501.02502	41	704.600.1	95	704.960.8	107
02-904.1	105	14-133.0252	74	14-412.036K	35	14-501.02502	81	704.600.1A	94	704.964.8	100
02-904.3	105	14-134.0252	26	14-412.036K	77	14-502.02502	41	704.600.1A	95	704.968.0	97
02-904.7	105	14-134.0252	28	14-414.036K	35	14-502.02502	81	704.600.2	96	704.968.1	97
02-906	107	14-134.0252	31	14-414.036K	77	14-506.0220	41	704.600.3	96	704.968.2	97
02-912.1	105	14-134.0252	68	14-415.036K	35	14-506.0220	81	704.600.5/A	96	704.968.3	97
02-912.2	105	14-134.0252	71	14-415.036K	77	14-506.02502	41	704.600.6	94	K14-040.110011	44
02-912.3	105	14-134.0252	75	14-417.036K	35	14-506.02502	81	704.600.6	95	K14-040.110012	45
02-912.4	105	14-135.022K	36	14-417.036K	77	14-507.02502	41	704.600.9	94	K14-040.110021	44
10-1106.1369	104	14-135.022K	78	14-418.036K	35	14-507.02502	81	704.600.9	95	K14-040.110022	45
10-1109.1329	104	14-135.025K2	36	14-418.036K	77	14-508.02502	41	704.601.0	86	K14-040.110031	44
10-1112.1279	104	14-135.025K2	79	14-431.036	25	14-508.02502	81	704.601.01	85	K14-040.110032	45
10-1113.1249	104	14-136.025K2	36	14-431.036	28	14-509.02502	41	704.601.2	86	K14-040.110041	44
10-1114.1249	104	14-136.025K2	78	14-431.036	30	14-509.02502	81	704.601.21	85	K14-040.110042	45
10-1116.1229	104	14-137.025K2	36	14-431.036	66	14-515.0360	40	704.601.4	86	K14-040.110051	43
10-1119.1199	104	14-137.025K2	78	14-431.036	70	14-515.0360	80	704.601.41	85	K14-040.110052	44
10-2106.3142	103	14-138.025K2	36	14-431.036	73	14-517.0360	40	704.601.5	86	K14-040.110061	44
10-2106.3144	103	14-138.025K2	79	14-432.036	25	14-517.0360	80	704.601.51	85	K14-040.110062	45
10-2106.3145	103	14-141.022K	35	14-432.036	28	14-520.0360	40	704.601.6	86	K14-040.110071	43
10-2106.3146	103	14-141.022K	78	14-432.036	30	14-520.0360	80	704.601.61	85	K14-040.110072	45
10-2106.3149	104	14-141.025K2	35	14-432.036	66	14-521.0360	40	704.601.8	86	K14-040.110081	44
10-2109.1062	103	14-141.025K2	78	14-432.036	70	14-521.0360	80	704.601.81	85	K14-040.110082	45
10-2109.1064	103	14-142.025K2	36	14-432.036	73	14-522.0360	40	704.601.9	86	K14-040.110091	44
10-2109.1065	103	14-142.025K2	78	14-433.036	24	14-522.0360	80	704.601.91	85	K14-040.110092	45
10-2109.1066	103	14-143.025K2	36	14-433.036	28	14-556.0220	81	704.602.0	83	K14-040.110101	43
10-2109.1069	104	14-143.025K2	78	14-433.036	30	14-556.02502	82	704.602.2	83	K14-040.110102	44
10-2112.1062	103	14-235.022K	36	14-433.036	66	14-557.02502	82	704.602.3	83	K14-040.120011	46
10-2112.1064	103	14-235.022K	78	14-433.036	70	14-570.0360	81	704.602.4	83	K14-040.120012	47
10-2112.1065	103	14-235.025K2	36	14-433.036	73	14-572.0360	81	704.602.5	83	K14-040.120021	46
10-2112.1066	103	14-235.025K2	79	14-435.036	24	14-741.006	48	704.602.6	83	K14-040.120022	47
10-2112.1069	104	14-236.025K2	36	14-435.036	28	14-742.006	48	704.602.7	83	K14-040.120031	46
10-2113.1062	103	14-236.025K2	78	14-435.036	30	14-743.0292	25	704.602.7A01	83	K14-040.120032	47
10-2113.1064	103	14-237.025K2	36	14-435.036	66	14-743.0292	30	704.603.2	87	K14-040.120041	46
10-2113.1065	103	14-237.025K2	78	14-435.036	70	14-743.0292	67	704.603.4	87	K14-040.120042	47
10-2113.1066	103	14-238.025K2	36	14-435.036	73	14-743.0292	74	704.603.5	87	K14-040.120051	46
10-2113.1069	104	14-238.025K2	79	14-436.036	24	14-744.0292	25	704.603.6	87	K14-040.120052	47
10-2119.1042	103	14-271.022	25	14-436.036	28	14-744.0292	30	704.603.7	87	K14-040.120061	46
10-2119.1044	103	14-271.022	28	14-436.036	30	14-744.0292	67	704.604.0	88	K14-040.120062	47
10-2119.1045	103	14-271.022	30	14-436.036	66	14-744.0292	74	704.604.2	88	K14-040.120071	46
10-2119.1046	103	14-271.022	67	14-436.036	70	14-746.0292	26	704.604.4	88	K14-040.120072	47
10-2119.1049	104	14-271.022	71	14-436.036	73	14-746.0292	30	704.604.5	88	K14-040.120081	46
14-030.002	48	14-271.022	74	14-437.036K	35	14-746.0292	67	704.608.7	91	K14-040.120082	47
14-030.005	48	14-271.0252	26	14-437.036K	77	14-746.0292	74	704.608.9	91	K14-040.120091	46
14-031.006	48	14-271.0252	28	14-438.036K	35	14-747.0292	25	704.609.0	90	K14-040.120092	47
14-040.002	9	14-271.0252	30	14-438.036K	77	14-747.0292	30	704.609.7	90	K14-040.120101	45
14-040.002	50	14-271.0252	67	14-471.036	25	14-747.0292	67	704.609.9	90	K14-040.120102	46
14-040.005	9	14-271.0252	71	14-471.036	28	14-747.0292	74	704.609.9	90	K14-040.1201011	5
14-040.005	50	14-271.0252	74	14-471.036	30	14-748.0292	25	704.609.9A01	90	K14-040.120102	6
14-041.006	9	14-272.0252	26	14-471.036	66	14-748.0292	30	704.610.7	90	K14-040.1201011	5
14-041.006	50	14-272.0252	28	14-471.036	70	14-748.0292	67	704.610.9	90	K14-040.120102	6
14-060.207	51	14-272.0252	31	14-471.036	73	14-748.0292	74	704.611.2	84	K14-040.120103	5
14-060.307	51	14-272.0252	67	14-472.036	25	14-810.002	52	704.611.4	84	K14-040.1201032	6
14-060.507	51	14-272.0252	71	14-472.036	28	14-810.902	52	704.611.5	84	K14-040.1201041	5
14-060.607	51	14-272.0252	74	14-472.036	30	14-810.910	10	704.611.6	84	K14-040.1201042	6
14-060.907	51	14-273.0252	26	14-472.036	66	14-810.918	10	704.611.7	84	K14-040.1201051	4
14-131.022	25	14-273.0252	28	14-472.036	70	14-910	106	704.614.2	89	K14-040.1201052	5
14-131.022	28	14-273.0252	31	14-472.036	73	14-955.0	91	704.614.4	89	K14-040.1201061	5
14-131.022	30	14-273.0252	67	14-473.036	24	14-955.1	91	704.614.5	89	K14-040.1201062	6
14-131.022	67	14-273.0252	71	14-473.036	28	14-955.3	93	704.614.6	89	K14-040.1201071	4
14-131.022	71	14-273.0252	74	14-473.036	30	14-955.4	93	704.614.7	89	K14-040.1201072	5
14-131.022	74	14-274.0252	26	14-473.036	66	14-955.9	91	704.925.0	99	K14-040.1201081	5
14-131.0252	25	14-274.0252	28	14-473.036	70	14-955.9E	93	704.925.2	99	K14-040.1201082	6
14-131.0252	28	14-274.0252	31	14-473.036	73	14-958.0	92	704.925.3	99	K14-040.1201091	5
14-131.0252	30	14-274.0252	68	14-475.036	25	14-958.8	92	704.925.7	98	K14-040.1201092	6
14-131.0252	67	14-274.0252	71	14-475.036	28	14-987.1001	100	704.928.18	98	K14-040.1201101	4
14-131.0252	71	14-274.0252	75	14-475.036	30	31-928	102	704.928.28	98	K14-040.1201102	5
14-131.0252	74	14-335.022K	36	14-475.036	66	31-929	102	704.928.38	98	K14-040.220011	7
14-132.0252	26	14-335.022K	78	14-475.036	70	31-940	101	704.945.1	108	K14-040.220012	8
14-132.0252	28	14-335.025K2	36	14-475.036	73	31-941	101	704.945.2	108	K14-040.220021	7
14-132.0252	31	14-335.025K2	78	14-476.036	24	31-942	101	704.945.3	108	K14-040.220022	8
14-132.0252	67	14-336.025K2	36	14-476.036	28	31-945	102	704.945.4	108	K14-040.220031	7
14-132.0252	71	14-336.025K2	78	14-476.036	30	31-946	102	704.945.5	108	K14-040.220032	8
14-132.0252	74	14-337.025K2	36	14-476.036	66	61-9481.6	109	704.945.6	109	K14-040.220041	7
14-133.0252	26	14-337.025K2	79	14-476.036	70	700.006.0	107	704.953.0	96	K14-040.220042	8
14-133.0252	28	14-338.025K2	36	14-476.036	73	704.600.0	94	704.954.0	106	K14-040.220051	6

# 14 Index

Part No.	Page	Part No.	Page	Part No.	Page
K14-040.220052.....	7	K14-131.211091.....	15	K14-271.122062.....	65
K14-040.220061.....	7	K14-131.211092.....	16	K14-271.122071.....	63
K14-040.220062.....	8	K14-131.211101.....	14	K14-271.122072.....	64
K14-040.220071.....	6	K14-131.211102.....	15	K14-271.122081.....	63
K14-040.220072.....	8	K14-131.211110.....	11	K14-271.122082.....	64
K14-040.220081.....	7	K14-131.211120.....	11	K14-271.122091.....	64
K14-040.220082.....	8	K14-131.211130.....	11	K14-271.122092.....	65
K14-040.220091.....	7	K14-131.211140.....	12	K14-271.122101.....	63
K14-040.220092.....	8	K14-131.211150.....	12	K14-271.122102.....	64
K14-040.220101.....	6	K14-131.221011.....	19	K14-271.122110.....	55
K14-040.220102.....	7	K14-131.221012.....	21	K14-271.122120.....	55
K14-131.111011.....	57	K14-131.221021.....	19	K14-271.122130.....	55
K14-131.111012.....	58	K14-131.221022.....	20	K14-271.122140.....	55
K14-131.111021.....	57	K14-131.221031.....	19	K14-271.122150.....	55
K14-131.111022.....	58	K14-131.221032.....	20	K14-271.212011.....	17
K14-131.111031.....	57	K14-131.221041.....	20	K14-271.212012.....	18
K14-131.111032.....	58	K14-131.221042.....	21	K14-271.212021.....	17
K14-131.111041.....	57	K14-131.221051.....	19	K14-271.212022.....	18
K14-131.111042.....	58	K14-131.221052.....	20	K14-271.212031.....	17
K14-131.111051.....	56	K14-131.221061.....	19	K14-271.212032.....	18
K14-131.111052.....	57	K14-131.221062.....	20	K14-271.212041.....	17
K14-131.111061.....	57	K14-131.221071.....	19	K14-271.212042.....	19
K14-131.111062.....	58	K14-131.221072.....	20	K14-271.212051.....	17
K14-131.111071.....	56	K14-131.221081.....	19	K14-271.212052.....	18
K14-131.111072.....	58	K14-131.221082.....	20	K14-271.212061.....	17
K14-131.111081.....	57	K14-131.221091.....	20	K14-271.212062.....	18
K14-131.111082.....	58	K14-131.221092.....	21	K14-271.212071.....	17
K14-131.111091.....	57	K14-131.221101.....	19	K14-271.212072.....	18
K14-131.111092.....	58	K14-131.221102.....	20	K14-271.212081.....	17
K14-131.111101.....	56	K14-131.221110.....	12	K14-271.212082.....	18
K14-131.111102.....	57	K14-131.221120.....	12	K14-271.212091.....	17
K14-131.111110.....	53	K14-131.221130.....	13	K14-271.212092.....	18
K14-131.111120.....	53	K14-131.221140.....	13	K14-271.212101.....	16
K14-131.111130.....	53	K14-131.221150.....	13	K14-271.212102.....	18
K14-131.111140.....	54	K14-135.21200.....	34	K14-271.212110.....	12
K14-131.111150.....	54	K14-135.22200.....	33	K14-271.212120.....	12
K14-131.121011.....	61	K14-136.22200.....	33	K14-271.212130.....	12
K14-131.121012.....	63	K14-141.22100.....	33	K14-271.212140.....	12
K14-131.121021.....	61	K14-235.21200.....	34	K14-271.212150.....	12
K14-131.121022.....	62	K14-235.22200.....	33	K14-271.222011.....	22
K14-131.121031.....	61	K14-236.22200.....	33	K14-271.222012.....	23
K14-131.121032.....	62	K14-271.112011.....	59	K14-271.222021.....	21
K14-131.121041.....	62	K14-271.112012.....	60	K14-271.222022.....	22
K14-131.121042.....	63	K14-271.112021.....	59	K14-271.222031.....	21
K14-131.121051.....	61	K14-271.112022.....	60	K14-271.222032.....	23
K14-131.121052.....	62	K14-271.112031.....	59	K14-271.222041.....	22
K14-131.121061.....	61	K14-271.112032.....	60	K14-271.222042.....	23
K14-131.121062.....	62	K14-271.112041.....	59	K14-271.222051.....	21
K14-131.121071.....	61	K14-271.112042.....	61	K14-271.222052.....	22
K14-131.121072.....	62	K14-271.112051.....	59	K14-271.222061.....	22
K14-131.121081.....	61	K14-271.112052.....	60	K14-271.222062.....	23
K14-131.121082.....	62	K14-271.112061.....	59	K14-271.222071.....	21
K14-131.121091.....	62	K14-271.112062.....	60	K14-271.222072.....	22
K14-131.121092.....	63	K14-271.112071.....	59	K14-271.222081.....	21
K14-131.121101.....	61	K14-271.112072.....	60	K14-271.222082.....	22
K14-131.121102.....	62	K14-271.112081.....	59	K14-271.222091.....	22
K14-131.121110.....	54	K14-271.112082.....	60	K14-271.222092.....	23
K14-131.121120.....	54	K14-271.112091.....	59	K14-271.222101.....	21
K14-131.121130.....	55	K14-271.112092.....	60	K14-271.222102.....	22
K14-131.121140.....	55	K14-271.112101.....	58	K14-271.222110.....	13
K14-131.121150.....	55	K14-271.112102.....	60	K14-271.222120.....	13
K14-131.211011.....	15	K14-271.112110.....	54	K14-271.222130.....	13
15 K14-131.211012.....	16	K14-271.112120.....	54	K14-271.222140.....	13
K14-131.211021.....	15	K14-271.112130.....	54	K14-271.222150.....	13
K14-131.211022.....	16	K14-271.112140.....	54	K14-506.21200.....	38
K14-131.211031.....	15	K14-271.112150.....	54	K14-506.22200.....	38
K14-131.211032.....	16	K14-271.122011.....	64	K14-507.22200.....	38
K14-131.211041.....	15	K14-271.122012.....	65		
K14-131.211042.....	16	K14-271.122021.....	63		
K14-131.211051.....	14	K14-271.122022.....	64		
K14-131.211052.....	15	K14-271.122031.....	63		
K14-131.211061.....	15	K14-271.122032.....	65		
K14-131.211062.....	16	K14-271.122041.....	64		
K14-131.211071.....	14	K14-271.122042.....	65		
K14-131.211072.....	16	K14-271.122051.....	63		
K14-131.211081.....	15	K14-271.122052.....	64		
K14-131.211082.....	16	K14-271.122061.....	64		



## X-ON Electronics

Largest Supplier of Electrical and Electronic Components

*Click to view similar products for [Industrial Panel Mount Indicators / Switch Indicators](#) category:*

*Click to view products by [EAO manufacturer](#):*

Other Similar products are found below :

[01-121.022](#) [LW1A-P1-W](#) [LW1B-A0L](#) [01-952.0](#) [01-152.025](#) [D38999/20FJ29PB L/C](#) [704-6012](#) [704-6020](#) [704-6023](#) [704-6026](#) [73.362.4028.0](#)  
[EUS-704.000.7](#) [750-1520](#) [9001OA120](#) [99-450.837](#) [99-455.837](#) [99-486.837](#) [99-901.9](#) [99-902.9](#) [99-908.0](#) [99-909.4](#) [99-909.5](#) [A0244J1](#)  
[A3DT-500Y](#) [AL6M-P7P-A](#) [AOLQW-2B0600](#) [AP1M255-A](#) [APD106LN-A](#) [APD106LN-G](#) [APN1126-G](#) [APS122DN-W](#) [ATN2100](#)  
[AYLW4L-A](#) [18-237.035](#) [C0180AANAHA](#) [HW1A-L1-GD](#) [HW1A-P2-GL](#) [HW1F-3G](#) [HW1R-2DF20-R](#) [HW1X-BM411-R](#) [HW2A-L1-GL](#)  
[HW2A-P1-GD](#) [HW4S-31L](#) [HWAZ1N-OB](#) [PA2200/1](#) [PA2SHIELD](#) [21-931.0](#) [21-931.2](#) [96-923.5](#) [1625006](#)