

Actuator

19-
051.005



<https://eao.com/p/19-051.005>

Your product:



19-051.005 Actuator

FRONT

Front dimension:	9 mm x 9 mm
Front form:	square
Front bezel colour:	Black
Front bezel material:	Plastic

MOUNTING

Design:	raised
Mounting cut-out:	Ø 8 mm
Mounting type:	Panel mounting

MECHANICAL CHARACTERISTIC

Terminal:	Plug-in terminal, 2 x 0.5 mm
Weight:	0.002 kg

AMBIENT CONDITION

Operating temperature:	- 25 °C ... + 45 °C with filament lamp, - 25 °C ... + 65 °C with LED, mounted as a block, make sure the heat can escape freely
-------------------------------	--

CERTIFICATE

REACH:	REACH compliant
RoHS:	RoHS compliant

OTHER

Short Description:

Actuator, Ø 8 mm, 9 mm x 9 mm, square, Black, Plastic, Plug-in terminal, 2 x 0.5 mm

Internal size:

7,3 mm x 7,3 mm

Housing colour:

Black

Housing material:

Plastic

Wiring diagrams:

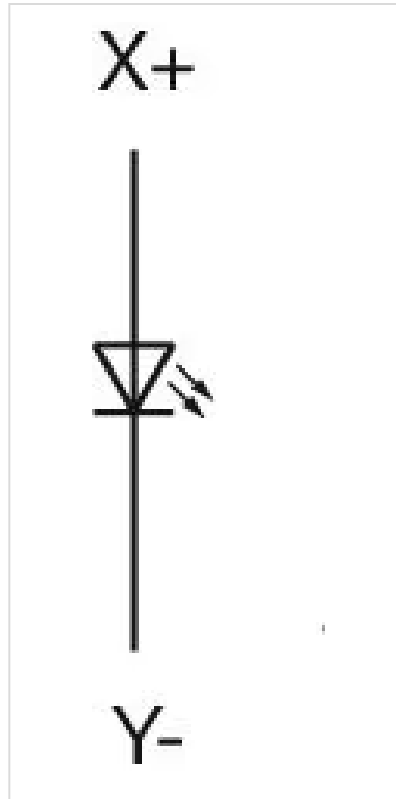

Component layouts:

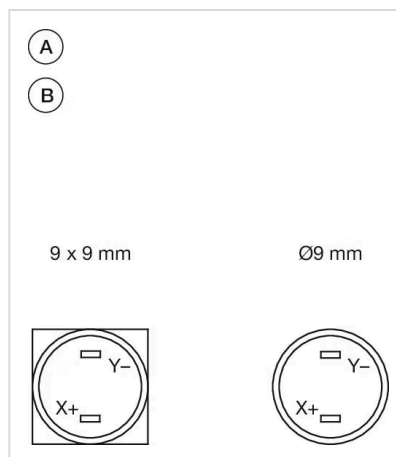

A = Terminals (rear side)
B = Indicator

Mounting cut-outs:

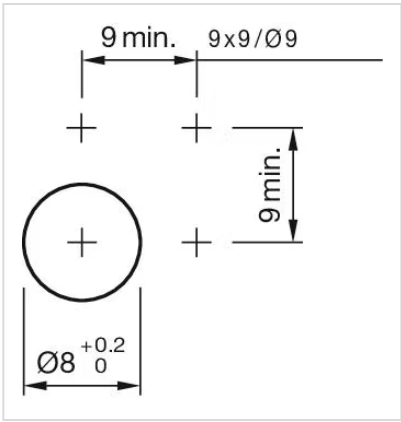

Dimension drawings:

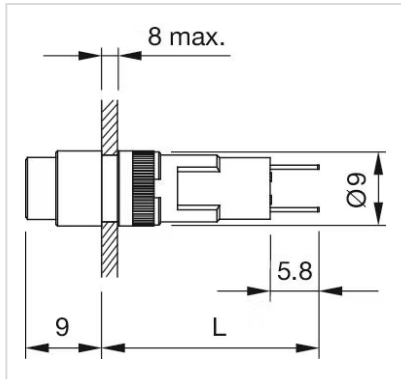

X-ON Electronics

Largest Supplier of Electrical and Electronic Components

Click to view similar products for [Pushbutton Switches](#) category:

Click to view products by [EAO](#) manufacturer:

Other Similar products are found below :

[8971K1133](#) [LW2L-M1C20M-A](#) [01-153.025](#) [M22-D-R-GB0/K11](#) [67021K512](#) [701PB580](#) [7199K101](#) [810K12910](#) [810KSV30B](#)

[MML21EA2ADK](#) [MML21KA3ABK](#) [MML23KW3AA01W](#) [8442K3](#) [8450K1](#) [860K11911T01A](#) [861901](#) [861K11911T01A07](#)

[861K13810T00A14](#) [861K13911](#) [8646AB6X718UL](#) [9533CD4+U574+U4922](#) [99-453.837](#) [A2PMA1X03EC56](#) [A3A-7310](#) [A3A-7340](#)

[12037A2ULCSA](#) [1203A2UL](#) [ABGW410-R](#) [1211390004](#) [ABN111-Y](#) [ABN400-R](#) [121382](#) [1213C3](#) [HE3B-M2](#) [1211500044](#) [121194](#)

[1212MRA](#) [1232A6NF](#) [121489](#) [1223A2ULCSA](#) [D5P-MT4](#) [13435AG](#) [13445AD29GX768](#) [AG23-L2](#) [AH165-2SGLG1TE3](#) [AH165-TGFY22](#)

[AH165-TGL5Y11E3](#) [AH165-TGLR11AA3](#) [AH165-TL5Y22E](#) [AH165-TLR11E](#)