



9

Index

Series 99

	Description	Page 529
	Product Assembly	Page 530
	Product Range	
	- pushbuttons for standard mounting	Page 531
	- accessories / spare parts	Page 537
	Technical Data	Page 541
	Technical Drawing / Dimension / Layout	Page 542
	Circuit Drawing	Page 545
	Marking	Page 546

General Notes

The series 99 contains indicators and illuminated pushbuttons with maintained and momentary action with one or two contacts which may be either normally open or normally closed or a combination of the two. The illuminated pushbuttons are equipped with the low-level switching system.

The series 99 PCB keylock switch with a spacing of 19.05 mm completes the existing range of indicators and illuminated pushbuttons. The PCB keylock switch is available with two and three positions, with maintained action, and with either one or two normally open contacts as well as with one normally open and one normally closed one.

Mounting

The illuminated pushbuttons of series 99 can be soldered to a printed circuit board. The contact layout conforms to the module of 2.54 mm (1/10"). A centering pin ensures dimensionally exact mounting in rows or blocks.

With an M 1.2 screw the pushbuttons can also be fixed to a printed circuit board. (This screw must be ordered separately.) The pushbuttons can be joined together easily with a coupling piece to form rows or blocks.

The layout of the PCB keylock switch conforms to the module of 2.54 mm (1/10").

Two centering pins ensure a dimensionally exact mounting. The contact layout corresponds to that of series 99 switches.

Rules for cleaning soldered PC boards

In many cases the boards are cleaned following mechanical soldering. In this case it is essential to prevent the cleaning fluid containing dirt, grease and flux from entering the switch.

Lenses

The lens consists of a bezel, a marking plate and a transparent lens plate, which may be either flat or concave.

Marking

For engraving, hot stamping and film inserts, see under "Markings" on page 546.

Illumination

Illumination of the different coloured lenses is by lamps bipin T 1 long-life (6-36 V) or LED bipin T 1.

Position indication

When a switch with maintained action is actuated, the lens remains in the depressed position mechanically. The state of the switch is apparent at all times from the position of the lens.

Keylock switch

standard lock (Index D)

10 different locks with standard nos. 311-320. If the lock number is not specified, we supply no. 311. Additional 125 locks, no. 321 - 445, are available on request. Master keys for locks no. 311 - 445 may be

All dimensions in mm.

We reserve the right to modify technical data.

ordered by quoting no. 31-989.300.

Two keys are supplied with each keylock switch.

Spare keys for standard DOM locks may be ordered by quoting no. 31-989 (please state the lock number).

Number structure

99-XXX.8X7

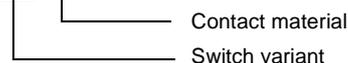

99-9XX.X

Lens

99-9XX.X

Other accessories

Example:

-Illuminated pushbutton, single, with momentary action; gold contact; soldering terminals
99-455.837

-Lens, complete, flat
99-901.9

Specimen order

Indicator single

- indicator single 99-050.807

Recommended accessories:

- lens single complete, flat 99-901.9

- LED, 1 chip, yellow 10-2602.3174C

illuminated-/pushbutton

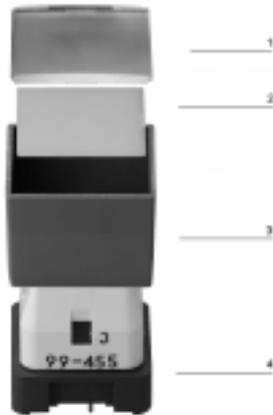

- 1 lens plate
- 2 marking plate
- 3 lens bezel
- 4 switching element

indicator single



recommended accessories:

-  lens single complete → 537
-  lens plate single → 537
-  marking plate single → 537
-  lens bezel single → 537
-  incandescent lamp → 539; LED → 540

	connection method	18.6 x 18.6 mm part no.	circuit drawing	technical drawing	mounting dimension	components layout	
indicator single	P	99-050.807	1	1	1	1	0,006

connection method: P = PCB terminal

[marking see page 546](#)

[technical drawing as of page 542](#), [mounting dimensions as of page 543](#), [components layouts as of page 544](#), [circuit drawing as of page 545](#)

indicator double



recommended accessories:

-  lens plate double → 538
-  marking plate double → 538
-  incandescent lamp → 539; LED → 540

	connection method	18.6 x 37.8 mm part no.	circuit drawing	technical drawing	mounting dimension	components layout	
indicator double	P	99-052.807	2	2	1	2	0,011

connection method: P = PCB terminal

[marking see page 546](#)

[technical drawing as of page 542](#), [mounting dimensions as of page 543](#), [components layouts as of page 544](#), [circuit drawing as of page 545](#)

indicator triple



recommended accessories:

-  lens plate triple → 538
-  marking plate triple → 538
-  incandescent lamp → 539; LED → 540

indicator triple	connection method	part no.	circuit drawing	technical drawing	mounting dimension	components layout	
indicator triple	P	99-053.807	3	3	1	3	0,017

connection method: P = PCB terminal

marking see page 546

technical drawing as of page 542, mounting dimensions as of page 543, components layouts as of page 544, circuit drawing as of page 545

illuminated/-pushbutton single



recommended accessories:

- lens single complete → 537
- lens plate single → 537
- marking plate single → 537
- lens bezel single → 537
- incandescent lamp → 539; LED → 540

illuminated/-pushbutton single	switching system	contacts	switching action	point of pressure	connection method						
						18.6 x 18.6 mm part no.	circuit drawing	technical drawing	mounting dimension	components layout	
illuminated/-pushbutton single	LL	1NC	main	with	P	99-482.837	4	1	1	1	0,008
				without	P	99-487.837	4	1	1	1	0,008
			mom	with	P	99-452.837	8	1	1	1	0,008
				without	P	99-457.837	8	1	1	1	0,008
		1NC + 1NO	main	with	P	99-483.837	6	1	1	1	0,008
				without	P	99-488.837	6	1	1	1	0,008
			mom	with	P	99-453.837	10	1	1	1	0,008
				without	P	99-458.837	10	1	1	1	0,008
		1NO	main	with	P	99-480.837	5	1	1	1	0,008
				without	P	99-485.837	5	1	1	1	0,008
			mom	with	P	99-450.837	9	1	1	1	0,008
				without	P	99-455.837	9	1	1	1	0,008
		2NO	main	with	P	99-481.837	7	1	1	1	0,008
				without	P	99-486.837	7	1	1	1	0,008
			mom	with	P	99-451.837	11	1	1	1	0,008
				without	P	99-456.837	11	1	1	1	0,008

switching system: LL = Low Level switching element

switching action: main = maintained action, mom = momentary action

connection method: P = PCB terminal

contacts: NC = normally closed, NO = normally open

marking see page 546

technical drawing as of page 542, mounting dimensions as of page 543, components layouts as of page 544, circuit drawing as of page 545

illuminated-/pushbutton double



recommended accessories:

-  lens plate double → 538
-  marking plate double → 538
-  incandescent lamp → 539; LED → 540

	switching system	contacts	switching action	connection method	18.6 x 37.8 mm part no.	circuit drawing	technical drawing	mounting dimension	components layout	
illuminated-/pushbutton double	LL	1NC + 1NO	main	P	99-418.837	12	2	1	2	0,013
			mom	P	99-408.837	14	2	1	2	0,013
		2NO	main	P	99-416.837	13	2	1	2	0,013
			mom	P	99-406.837	15	2	1	2	0,013

switching system: LL = Low Level switching element

switching action: main = maintained action, mom = momentary action

connection method: P = PCB terminal

contacts: NC = normally closed, NO = normally open

[marking see page 546](#)

[technical drawing as of page 542](#), [mounting dimensions see page 543](#), [components layouts as of page 544](#), [circuit drawing as of page 545](#)

illuminated-/pushbutton triple



recommended accessories:

-  lens plate triple → 538
-  marking plate triple → 538
-  incandescent lamp → 539; LED → 540

	switching system	contacts	switching action	connection method	18.6 x 56.9 mm part no.	circuit drawing	technical drawing	mounting dimension	components layout	
illuminated-/pushbutton triple	LL	1NC + 1NO	main	P	99-448.837	16	3	1	3	0,019
			mom	P	99-438.837	18	3	1	3	0,019
		2NO	main	P	99-446.837	17	3	1	3	0,019
			mom	P	99-436.837	19	3	1	3	0,019

switching system: LL = Low Level switching element

switching action: main = maintained action, mom = momentary action

connection method: P = PCB terminal

contacts: NC = normally closed, NO = normally open

[marking see page 546](#)

[technical drawing as of page 542](#), [mounting dimensions as of page 543](#), [components layouts as of page 544](#), [circuit drawing as of page 545](#)

keylock switch 2 positions

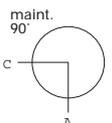

recommended accessories:

	switching system	contacts	switching action	connection method	key removable in	 18.8 x 18.8 mm part no.	circuit drawing	technical drawing	mounting dimension	components layout	
keylock switch 2 positions pos. A: basic position pos. C: maintained action standard lock 311, other lock numbers on request	LL	1NC + 1NO	main	P	A	99-213.837D	21	4	2	1	0,017
					A+C	99-253.837D	21	4	2	1	0,017
					C	99-233.837D	21	4	2	1	0,017
	1NO	main	P	A	99-210.837D	20	4	2	1	0,017	
				A+C	99-250.837D	20	4	2	1	0,017	
				C	99-230.837D	20	4	2	1	0,017	
	2NO	main	P	A	99-211.837D	22	4	2	1	0,017	
				A+C	99-251.837D	22	4	2	1	0,017	
				C	99-231.837D	22	4	2	1	0,017	

switching system: LL = Low Level switching element

switching action: main = maintained action

connection method: P = PCB terminal

contacts: NC = normally closed, NO = normally open

[description see page 529](#)

[technical drawing as of page 542](#), [mounting dimensions as of page 543](#), [components layouts as of page 544](#), [circuit drawing as of page 545](#)

keylock switch 3 positions

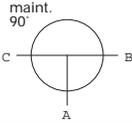

recommended accessories:

	switching system	contacts	switching action	connection method	key removable in	18.8 x 18.8 mm part no.	circuit drawing	technical drawing	mounting dimension	components layout	
 <p>keylock switch 3 positions pos. A: basic position pos. B: maintained position pos. C: maintained position standard lock 311, other lock numbers on request</p>	LL	2NO	main-0-main	P	A	99-311.837D	23	4	2	1	0,017
					A+B	99-341.837D	23	4	2	1	0,017
					A+B+C	99-371.837D	23	4	2	1	0,017
					A+C	99-351.837D	23	4	2	1	0,017
					B	99-321.837D	23	4	2	1	0,017
					B+C	99-361.837D	23	4	2	1	0,017
					C	99-331.837D	23	4	2	1	0,017

switching system: LL = Low Level switching element

connection method: P = PCB terminal

contacts: NC = normally closed, NO = normally open

switching action: main = maintained action, 0 = basic position

description see page 529

technical drawing as of page 542, mounting dimensions as of page 543, components layouts as of page 544, circuit drawing as of page 545

at front

lens single complete

for single pushbutton

	shape	lens plate	colour	∅ 18.6 x 18.6 mm part no.		
lens single complete plastic	concave	transparent	clear	99-902.9	0,002	
	flat	transparent	clear	99-901.9	0,002	

marking see page 546

lens plate single

for single pushbutton

	shape	lens plate	colour	∅ 18.6 x 18.6 mm part no.		
lens plate single plastic	concave	opaque	grey	99-924.8	0,001	
		transparent	clear	99-922.7	0,001	
		transparent matt	clear	99-928.7	0,001	
	convex	transparent	clear	99-929.7A	0,001	
	convex with recess	transparent	clear	99-928.7A	0,001	
	flat	transparent	clear	99-921.7	0,001	
		transparent matt	clear	99-927.7	0,001	

marking see page 546

marking plate single

for lens single

	marking plate	colour	∅ 18.6 x 18.6 mm part no.		
marking plate single can be engraved or hot stamped for LED	translucent	black	99-908.0	0,001	
		white	99-908.9	0,001	
	translucent	beige	99-918.A	0,001	

lens bezel single

for single pushbutton

	construction	colour	part no.		
lens bezel single	rounded	grey	99-920.82	0,001	
		with edges	beige	99-920.9B	
	black	99-920.0	0,001		
	brown	99-920.9C	0,001		
	grey	99-920.8	0,001		
	white	99-920.9A	0,001		

lens plate double

for pushbutton double

	shape	lens plate	colour	⌀ 18.6 x 37.8 mm part no.	 0,001	
lens plate double plastic	concave	transparent	clear	99-962.7	0,001	
		transparent matt	clear	99-974.7	0,001	
	flat	transparent	clear	99-961.7	0,001	
		transparent matt	white	99-961.9	0,001	
			clear	99-973.7	0,001	

marking see page 546

marking plate double

for lens double

	marking plate	colour	⌀ 18.6 x 37.8 mm part no.	 0,001	
marking plate double can be engraved or hot stamped	translucent	black	99-963.0	0,001	
		white	99-963.9	0,001	

lens plate triple

for pushbutton triple

	shape	lens plate	colour	⌀ 18.6 x 56.9 mm part no.	 0,002	
lens plate triple plastic	concave	transparent	clear	99-967.7	0,002	
		transparent matt	clear	99-979.7	0,002	
	flat	transparent	clear	99-966.7	0,002	
		transparent matt	clear	99-978.7	0,002	

marking see page 546

marking plate triple

for pushbutton triple

	marking plate	colour	⌀ 18.6 x 56.9 mm part no.	 0,001	
marking plate triple can be engraved or hot stamped	translucent	black	99-968.0	0,001	
		white	99-968.9	0,001	

colour foil single

for lens single

	colour	⌀ 18.6 x 18.6 mm part no.	 1,001	
colour foil single	blue	99-909.6	1,001	
	green	99-909.5	1,001	
	orange	99-909.3	1,001	
	red	99-909.2	1,001	
	yellow	99-909.4	1,001	

colour foil double

for lens double

	colour	18.6 x 37.8 mm part no.		
colour foil double	blue	99-964.6	0,001	
	green	99-964.5	0,001	
	red	99-964.2	0,001	
	yellow	99-964.4	0,001	

colour foil triple

for lens triple

	colour	18.6 x 56.9 mm part no.		
colour foil triple	blue	99-969.6	0,001	
	green	99-969.5	0,001	
	red	99-969.2	0,001	
	yellow	99-969.4	0,001	

blind plug

	height	colour	19 x 19 mm part no.		
blind plug	16 mm	grey	99-948.81	0,003	
	17.5 mm	grey	99-948.82	0,003	
	19 mm	grey	99-948.83	0,004	

spare key

	part no.		
spare key for standard lock 311, other lock numbers on request	31-989.311	0,006	

[description see page 529](#)

for illumination

incandescent lamp

up to pushbutton order 1, 2 or 3 pcs.

	voltage/current	part no.		
incandescent lamp base T 1 Bi-Pin	6 AC/DC/70mA	10-1606.1309 (19-903.00)	0,001	
	12 AC/DC/25 mA	10-1609.1199 (19-903.10)	0,001	
	24 AC/DC/20 mA	10-1612.1179 (19-903.30)	0,001	
	28 AC/DC/24 mA	10-1613.1189 (11-903.4)	0,001	
	36 AC/DC/20 mA	10-1616.1179 (11-903.5)	0,001	

LED

up to pushbutton order 1, 2 or 3 pcs.

	number of chips	voltage/current	colour	part no.		
LED base T 1 Bi-Pin	1 chip	2,2 VDC/20 mA	green	10-2602.3175C (19-943.05)	0,001	
			red	10-2602.3172C (19-943.02)	0,001	
			yellow	10-2602.3174C (19-943.04)	0,001	
			white	10-2603.3179C	0,001	
	4 chips	28 VDC/12 mA	green	10-4613.3105B (11-968.35)	0,001	
			orange	10-4613.3103B (11-968.33)	0,001	
			red	10-4613.3102B (11-968.32)	0,001	
			yellow	10-4613.3104B (11-968.34)	0,001	

assembling

coupling section

for mounting pushbuttons in rows or blocks

	part no.		
coupling section grey	99-910	0,001	

fixing screw

	part no.		
fixing screw M 1.2 x 5 mm (DIN)	99-990	0,001	

lamp remover

	part no.		
lamp remover	11-906	0,003	

Low Level switching element

switching system

This low-level switching system was designed for switching low powers in electronic circuits. The switching system assures reliable switching of loads.

Single-break momentary contact, as normally open or normally closed with 4 independent points of contact.

Special features are the long life, extremely short rebound time and stable contact resistance.

Contact combinations: 1 normally open contact, 2 normally open contacts, 1 normally closed/1 normally open contact, 1 normally closed contact

material

material of contacts

gold-plated

switching element

polycarbonate PC

mechanical characteristics

ambient air temperature

-25°C to +55°C

for indicators and illuminated pushbuttons mounted as a block, make sure the heat can escape freely (as per DIN IEC 68-)

mechanical life

illuminated pushbuttons	5 million operations
PCB keylock switches	50000 operations

rebound time

typ. $\leq 100 \mu\text{s}$

resistance to shock

(single impacts, semi-sinusoidal)
15 g for 11 ms as per IEC 68-2-27

storage temperature

-40°C to +85°C
(as per DIN IEC 68-)

electrical characteristics

electric strength

2500 VAC, 50 Hz, 1 min. between all terminals and earth, as per IEC 512-2-11.

insulation resistance

$10^{12} \Omega$ between contacts at 100 VDC, as per IEC 512-2, test 3a

volume resistance

starting value (initial) $\leq 50 \text{ m}\Omega$ as per IEC 512-2, test 2b

actuator

material

lens bezel

polycarbonate PC, heat-resistant

lens plate

polymethylmethacrylate PMMA, heat-resistant

mechanical characteristics

actuating force

pushbuttons with tactile point:	$2.0 \pm 0.3 \text{ N}$
pushbuttons without tactile point:	$1.3 \pm 0.4 \text{ N}$

actuating torque

4.7-6.0 Ncm (measured at the key)

ambient air temperature

-25°C to +55°C

for indicators and illuminated pushbuttons mounted as a block, make sure the heat can escape freely (as per DIN IEC 68-)

angle of rotation for print keylock switch

keylock switch with 2 positions: 90°
keylock switch with 3 positions: 2 x 90°

degree of protection

front as per IEC 529:
IP 40, PCB keylock switch, illuminated pushbutton

mechanical life

illuminated pushbuttons	5 million operations
PCB keylock switches	50000 operations

storage temperature

-40°C to +85°C

(as per DIN IEC 68-)

travel

lead distance NC contact: $1.1 \pm 0.2 \text{ mm}$;
lead distance NO contact: $2.1 \pm 0.2 \text{ mm}$;
total distance: $3.6 \pm 0.2 \text{ mm}$

electrical characteristics

electrostatic breakdown value

10 kV as per IEC 65 (Co) 28.

technical drawing

1 indicator single, illuminated-/pushbutton single page 531, 533

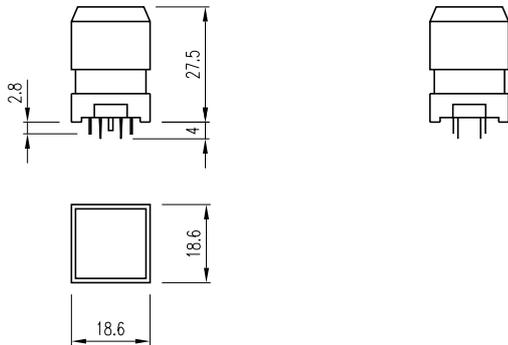

2 indicator double, illuminated-/pushbutton double page 531, 534

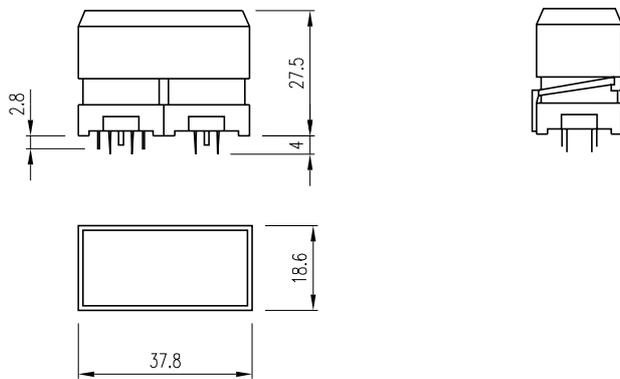

3 indicator triple, illuminated-/pushbutton triple page 532, 534

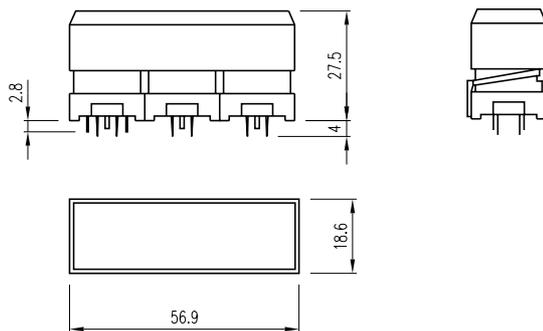

4 keylock switch 2 positions, keylock switch 3 positions
page 535, 536

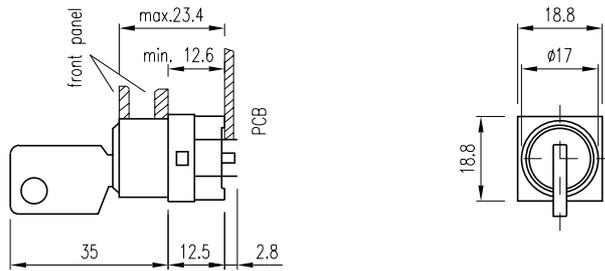

mounting dimension

1 indicator single, indicator double, indicator triple, illuminated/-pushbutton single, illuminated/-pushbutton double, illuminated/-pushbutton triple
page 531, 532, 533, 534

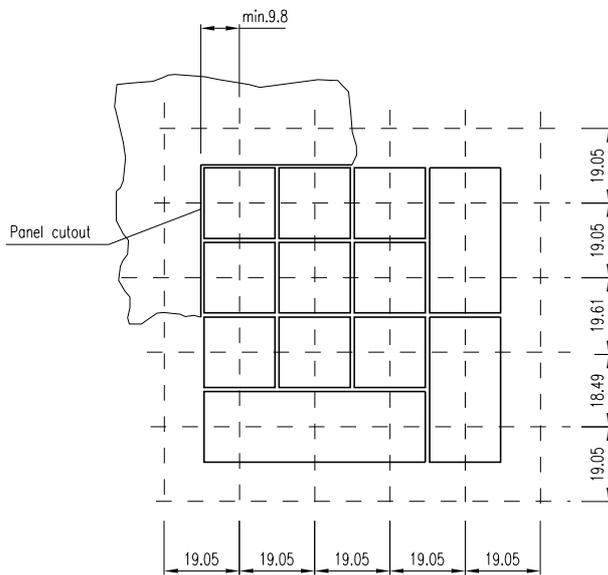

2 keylock switch 2 positions, keylock switch 3 positions
page 535, 536

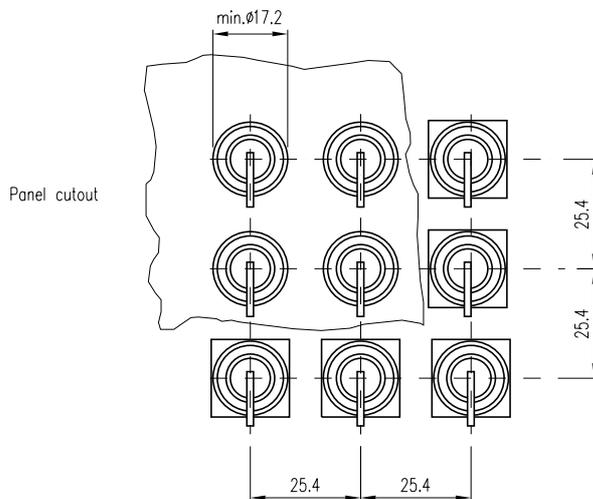

components layouts

1 indicator single, illuminated-/pushbutton single, keylock switch 2 positions, keylock switch 3 positions

page 531, 533, 535, 536

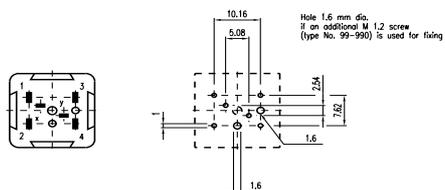

2 indicator double, illuminated-/pushbutton double

page 531, 534

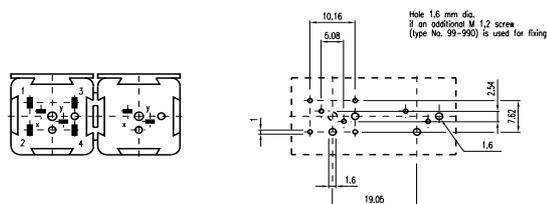

3 indicator triple, illuminated-/pushbutton triple

page 532, 534

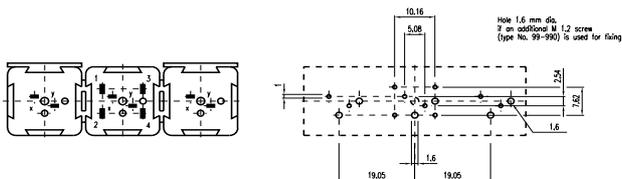

	circuit drawing
1	
2	
3	
4	
5	
6	
7	
8	
9	
10	
11	
12	
13	
14	
15	
16	
17	
18	
19	
20	

	circuit drawing
21	
22	
23	

1. Engraving

Typefaces

In addition to the most commonly used world languages (see DIN 1451) with close spacing, the following typefaces are available: Scandinavian, Slavian, Greek, Russian.

Coloured filling of engraving

Unless requested otherwise by the customer, the lettering on white and black marking plates will be in black and white.

Symbols

A list of the symbols available can be supplied on request.

2. Hot stamping

For large batches it is worth while to have the lettering produced by hot stamping.

Typefaces

For letters and figures, typefaces with 2.5 mm, 3 mm and 4 mm are available.

Symbols

A list of the symbols available can be supplied on request.

3. Film inserts

Instead of being engraved, the lenses can have a film inserted, possibly backed by a colour foil, placed between the lens plate and the marking plate.

Film dimensions

for single button: 16 x 16 mm
for double button: 16 x 34,7 mm
for triple button: 16 x 53,8 mm

Film thickness 0,2 mm

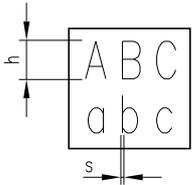
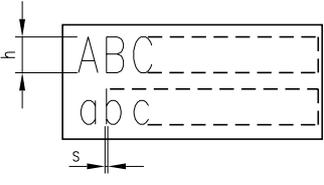
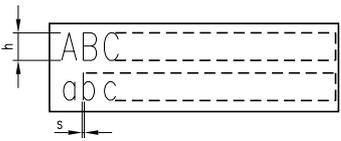
Height of letters mm	Thickness of letters mm									
		Number of lines	Number of letters per line	Number of letters per line	Number of lines	Number of letters per line	Number of letters per line	Number of lines	Number of letters per line	Number of letters per line
h	s		(caps)	(small)		(caps)	(small)		(caps)	(small)
2,5	0,4	4	7	8	4	19	20	4	30	32
3	0,4	3	6	7	3	16	18	3	25	28
4	0,5	2	4	5	2	11	13	2	18	20
5	0,5	2	3	4	2	9	10	2	14	16
6	0,6	1	3	4	1	7	8	1	12	13
8	0,6	1	2	3	1	5	6	1	9	10

X-ON Electronics

Largest Supplier of Electrical and Electronic Components

Click to view similar products for [Switch Bezels](#) / [Switch Caps](#) category:

Click to view products by [EAO manufacturer](#):

Other Similar products are found below :

[896809000](#) [LW1A-B2-R](#) [LW2A-B1-G](#) [704.604.4](#) [704.955.3](#) [F1403](#) [7527](#) [760203000](#) [760503000](#) [766601000](#) [785105000](#) [785106000](#)
[79211759](#) [MG12KB](#) [MH11](#) [MH13](#) [MHU31](#) [MJ1216](#) [MJ1226](#) [MJ33](#) [MJ612](#) [MJ626](#) [MJ627](#) [9001T8BK](#) [908-1634](#) [92-343.200](#) [92-343.400](#)
[95804.920](#) [95CAP-011](#) [95CAP-112](#) [11-932.7](#) [99-901.9](#) [99-902.9](#) [99-909.4](#) [99-909.5](#) [99-920.8](#) [A0261A](#) [11-931.2](#) [11-932.5](#) [11-936](#)
[AKTSC22B](#) [AT496H](#) [AW-RF8](#) [161006](#) [1825068-6](#) [184-1872](#) [187-1872](#) [188-1471](#) [18-920.1](#) [1DFBLK](#)