

# Single Row Terminal Blocks

## A2, LP2 & CB2

### Dimensions Inches (Millimeters)

#### A2 & LP2

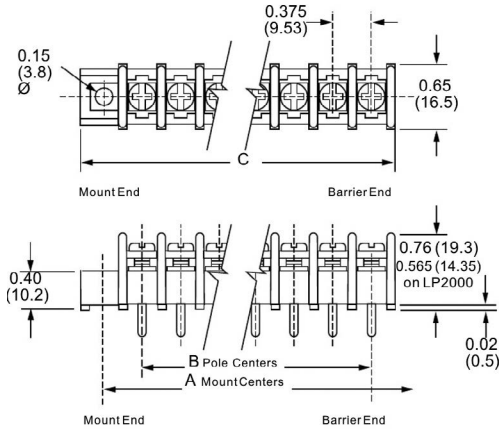

#### CB2

CB20220407

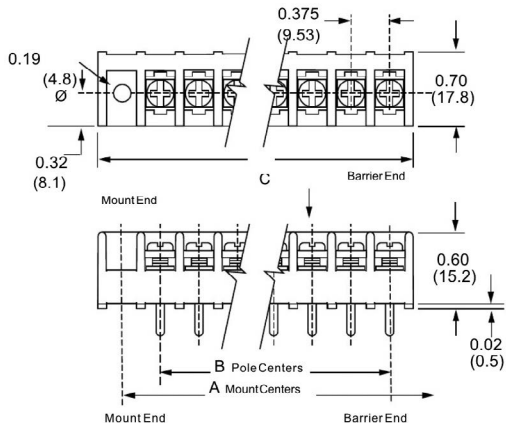

### Specifications

**Rating:** A2: 30A, 300V\* LP2: 30A, 150V\* CB2: 30A, 300V\*

**Center Spacing:** 0.375" or 3/8" (9.52mm)

**Wire Range:** #12-22 AWG Cu

**Screw Size:** #6-32 zinc-plated phillslot

**Torque Rating:** 9 lb-in.

**Base:** Standoffs standard for easy flux washing

**Distance Between Barriers:** 0.32" (8.1mm)

**Recommended PCB Hole Diameter:** 0.076" (1.93mm)

**Operating Temperature:** 105°C (221°F) max., -40°C (-40°F) min.

**Molded Material:** Black, UL Rated 94V0 Thermoplastic

**Breakdown Voltage:** 3400V (A2 & LP2); 4100V (CB2).

**Agency Information:** UL File E62622, CSA File 47235; IEC Compliance; CE Certified

\* 30A Rating achieved with a #10 copper wire crimped to a ring terminal.; 20A Rating without ring terminal.

Poles	MOUNTING ENDS ONLY		BARRIER & MOUNTING ENDS	
	A Mounting Ctrs.	C Length	B Pole Ctrs.	C Length
02	1.13	1.56	0.38	0.81
03	1.50	1.93	0.75	1.18
04	1.88	2.30	1.13	1.56
05	2.25	2.68	1.50	1.93
06	2.63	3.06	1.88	2.31
07	3.00	3.43	2.25	2.68
08	3.38	3.81	2.63	3.06
09	3.75	4.18	3.00	3.43
10	4.13	4.56	3.38	3.81
11	4.50	4.93	3.75	4.18
12	4.88	5.31	4.13	4.56
13	5.25	5.69	4.50	4.93
14	5.63	6.06	4.88	5.31
15	6.00	6.43	5.25	5.68
16	6.38	6.81	5.63	6.06
17	6.75	7.18	6.00	6.43
18	7.13	7.56	6.38	6.81
19	7.50	7.93	6.75	7.18
20	7.88	8.31	7.13	7.56
21	8.25	8.68	1.50	7.93
22	8.63	9.06	7.88	8.31
23	9.00	9.43	8.25	8.68
24	9.38	9.81	8.63	9.06
25	-	-	9.00	9.43
26	-	-	9.38	9.81



Powering Business Worldwide

### Part Numbering System

**Family**



**A2** - standard barrier

**LP2** - low profile barrier

**Terminal Style**



**01\*** - handwired

**02** - printed circuit

**03** - non feed-thru

**04** - wire wrap tail

**06** - handwired

**07** - extended pin

**08** - printed circuit

**09** - 0.250" QC short

**10** - 0.187" QC

**14** - printed circuit

**19** - 0.250" QC long

**Base/End**



**1** - std. base/  
mnt. end

**2** - std. base/  
barrier end on  
mount

**3** - insulator  
base/mnt. end

**4** - insulator  
base/barrier end

**5** - closed base/  
mount end

**6** - closed base/  
molded mount  
end

Base/End  
Note: 5 & 6  
Styles only  
available with 03  
terminals.

**Poles**

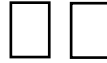

**02 to 26** Barrier end

**02 to 24** Mount end

**Screw Options**

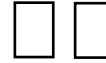

Blank-std. screws

**00** - screws shipped  
bulk

**03\*** - stainless steel

**04** - brass nickel-plated

**07** - steel SEMS\*\*\*

**09\*** - brass SEMS  
nickel-plated\*\*\*

**CA\*\*** - captive screw

**WR\*** - wire ready

**Options**

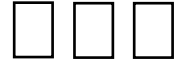

**AB\*** - angle mnt. options (pg 11)

**A1 to A9** - 0.250" QC

**B1 to B9** - 0.187" QC

**DR\*** - drilled right angle  
(pg 11)

**L1 to L6** marking options  
(pg 25)

**MP\*** mounting plates (pg 11)

**R30 to R75** - right angle  
bends (pg 11)

**S1\*** - solder lug/flat

**Covers** - (pg 26)

\* A2 only.

\*\* Not compatible with 03-stainless steel screws.

\*\*\* SEMS screws not available with hardware options

### Terminal Styles Inches (Millimeters)

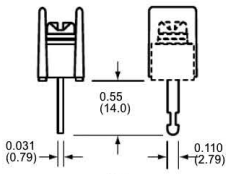

**01**

Handwired

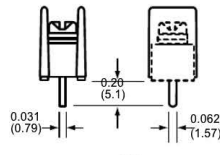

**02**

Printed Circuit



**03**

Non Feed-Thru

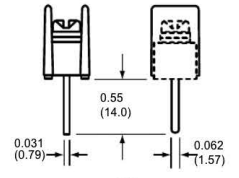

**04**

Wire Wrap Tail

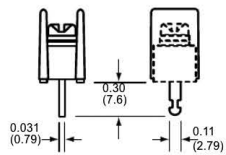

**06**

Handwired

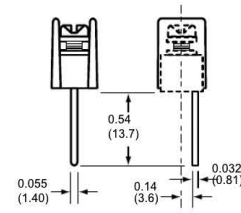

**07**

Extended Pin

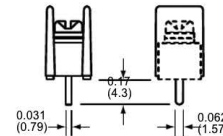

**08**

Printed Circuit

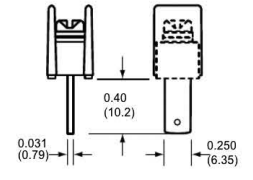

**09**

0.250" QC short

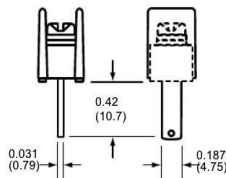

**10**

0.187" QC

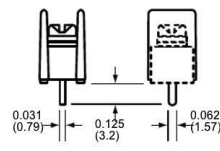

**14**

Printed Circuit

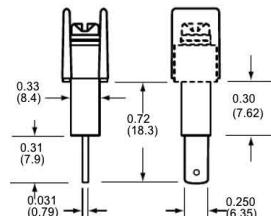

**19**

0.250" QC long

### Screw Options

(Bulk ordering part numbers are in parentheses)



**Standard**  
Zinc-plated Steel  
(F505-J)



**03**  
Stainless Steel  
(F507-J)



**04**  
Brass  
Nickel-Plated  
(F506-J)



**07**  
Steel SEMS  
(F523-J)



**09**  
Brass SEMS  
Nickel-Plated  
(F524-J)



**WR**  
Wire Ready

### Hardware Options Inches (Millimeters)

(Bulk ordering part numbers are in parentheses)

#### Solder Lugs

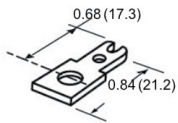

**S1**  
(2S1-J)

#### Jumpers

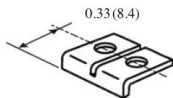

(JA2-xx-J)

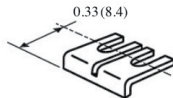

(JB2-xx-J)

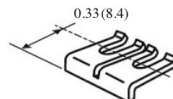

(JC2-xx-J)



†OJ2  
(OJ2-J)



†OJ4  
(OJ4-J)

#### Quick Connects

Blade Width A = 0.250" Blade Width B = 0.187"

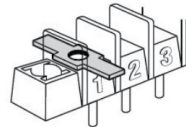

**A1 & B1**  
(2A1-J & 2B1-J)

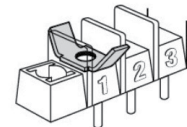

**A2 & B2**  
(2A2-J & 2B2-J)

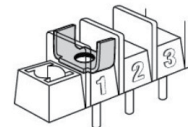

**A3 & B3**  
(2A3-J & 2B3-J)

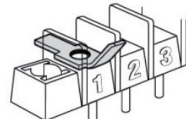

**A4 & B4**  
(2A4-J & 2B4-J)



**A5 & B5**  
(2A5-J & 2B5-J)



**A6 & B6**  
(2A6-J & 2B6-J)

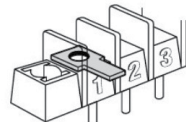

**A7 & B7**  
(2A7-J & 2B7-J)

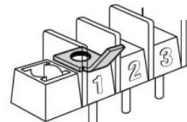

**A8 & B8**  
(2A8-J & 2B8-J)

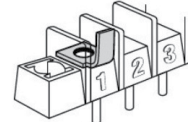

**A9 & B9**  
(2A9-J & 2B9-J)

† Contact Eaton for desired configuration.

### Base/End Options Inches (Millimeters)



**1 - Standard base/mount end**



**3 - Insulator base/mount end**

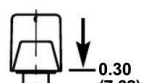

**4 - Insulator base/barrier end**



**5 - Closed base/mount end**



**6 - Closed base/molded mount end**

(not available with covers)

#### Mount End Details

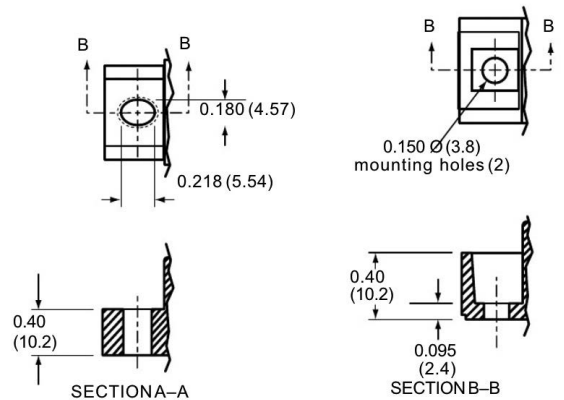

**6**  
**Molded Mount End**

**1, 3 & 5**  
**Mount End**

Note: On 1, 3 and 5 bases, Eaton may drill a terminal spacing to be a mount end. There will be no fit/form/function effect of mounting the product

## Mounting Options Inches (Millimeters)

### Right Angle Bends

Right angle terminals are offered on the A2 & LP2. Configurations are defined in these dimensions: X = pin extension beyond the block base; Z = length from block base to centerline of the terminal tip. Standard bends consist of the X and Z dimensions shown in the chart. Specify by adding the selected Bend Option Code to the terminal part number.

### 04 Terminal Bend Configurations

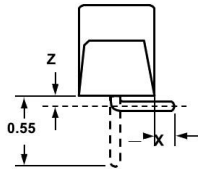

Bend Option Code	X (minimum)	Z	Available with insulator base
R35	0.01	0.23	No
R42	0.08	0.16	No
R46	0.12	0.12	No
R50	0.16	0.08	No

Dimensions in inches. To convert to millimeters, multiply by 25.4.

### Angle Brackets

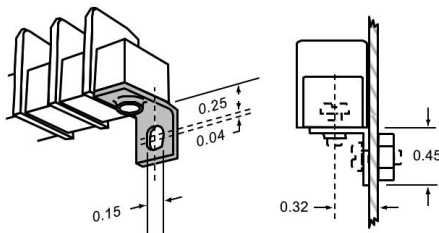

### Option AB

Angle brackets enable block to be fastened at right angles to normal mount position. Bulk part number **2AB-J**.

### Mounting Plates

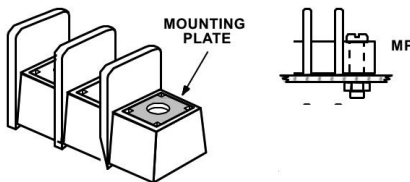

### Options MP

**MP** Metal inserts with 0.150" dia. hole accept #6 screw.  
Bulk part number **2MP-J**.

### 07 Terminal Bend Configurations

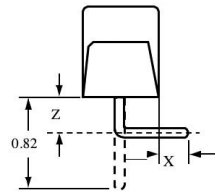

Bend Option Code	X (minimum)	Z	Available with insulator base
R35	0.01	0.50	Yes
R42	0.08	0.43	Yes
R46	0.12	0.39	Yes
R50	0.16	0.35	No
R53	0.19	0.32	No
R66	0.32	0.19	No
R75	0.41	0.10	No

Dimensions in inches. To convert to millimeters, multiply by 25.4.

### Drilled Right Angle

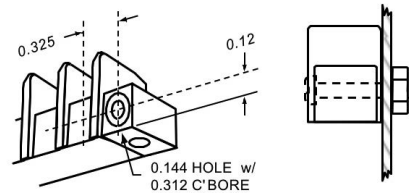

### Option DR

Counterbored holes across mount ends of block enable fastening with two screws at right angles to normal mount position.

## Part Numbering System

Family	Terminal Style	Base/End	Poles	Screw Options	Options
<div style="display: flex; gap: 10px;"> <div style="border: 1px solid black; padding: 2px 5px;">C</div> <div style="border: 1px solid black; padding: 2px 5px;">B</div> <div style="border: 1px solid black; padding: 2px 5px;">2</div> </div> <p>CB2 - closed back</p>	<div style="display: flex; gap: 10px;"> <div style="border: 1px solid black; width: 20px; height: 20px;"></div> <div style="border: 1px solid black; width: 20px; height: 20px;"></div> </div> <p>01 - handwired 02 - printed circuit 07 - extended pin 14 - printed circuit</p>	<div style="border: 1px solid black; width: 20px; height: 20px;"></div> <p>1 - mount end 2 - barrier end</p>	<div style="display: flex; gap: 10px;"> <div style="border: 1px solid black; width: 20px; height: 20px;"></div> <div style="border: 1px solid black; width: 20px; height: 20px;"></div> </div> <p>02 to 26 on barrier end 02 to 24 on mount end</p>	<div style="display: flex; gap: 10px;"> <div style="border: 1px solid black; width: 20px; height: 20px;"></div> <div style="border: 1px solid black; width: 20px; height: 20px;"></div> </div> <p>Blank-std. screws 07 - steel SEMS standard 09 - brass SEMS nickel-plated</p>	<div style="display: flex; gap: 10px;"> <div style="border: 1px solid black; width: 20px; height: 20px;"></div> <div style="border: 1px solid black; width: 20px; height: 20px;"></div> <div style="border: 1px solid black; width: 20px; height: 20px;"></div> </div> <p>AB - angle mounting brackets (pg 13) A7 to A9 - 0.250" QC B7 to B9 - 0.187" QC EB - exit back terminals EF - exit front terminals L1 to L6 marking options (pg 25) LT1 to LT6 marking options (pg 25) MP mtg. plates (pg 13) Covers - (pg 26)</p>

## Terminal Styles Inches (Millimeters)

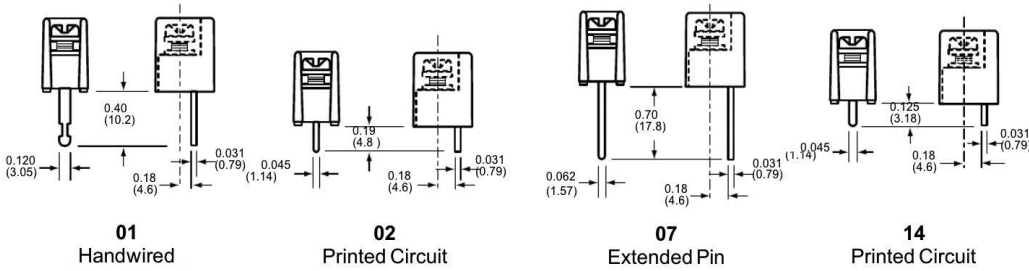

## Screw Options

(Bulk ordering part numbers are in parentheses)



07  
Steel SEMS  
zinc-plated  
(B001-7084-J)



09  
Brass SEMS  
nickel-plated  
(F524-J)

\* NOTE: Wire ready screws standard on all terminal styles.

## CB2 Terminal Exit Options Inches (Millimeters)

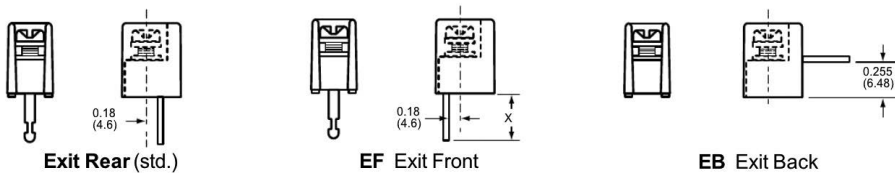

## Hardware Options Inches (Millimeters)

(Bulk ordering part numbers are in parentheses)

### Jumpers

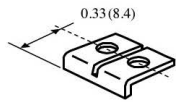

†JA  
(JA2-XX-J)

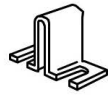

†OJ2  
(OJ2-J)

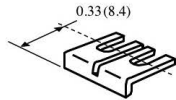

†JB  
(JB2-XX-J)



†OJ4  
(OJ4-J)

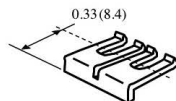

†JC  
(JC2-XX-J)

† Contact Eaton for desired configuration.

### Quick Connects

Blade Width A = 0.250". Blade Width B = 0.187".



A7 & B7  
(2A7-J & 2B7-J)



A8 & B8  
(2A8-J & 2B8-J)

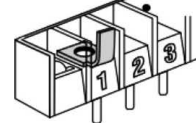

A9 & B9  
(2A9-J & 2B9-J)

## Mounting Options Inches (Millimeters)

### Right Angle Mounting Bracket

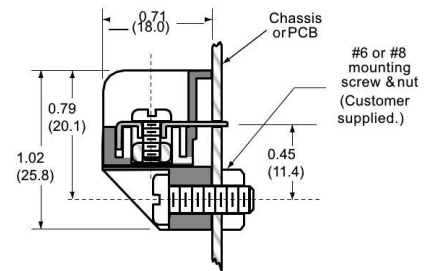
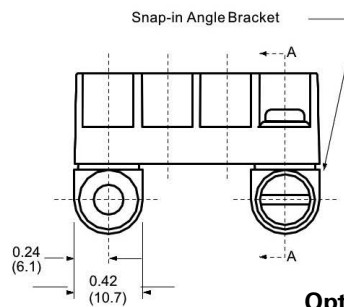
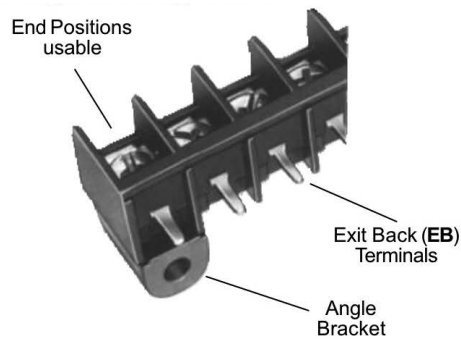

Option AB

### Mounts blocks on PC boards at a right angle.

- Protects solder joints.
- Bracket snaps securely on block (no hardware required).
- Minimum strip length (end positions are usable).
- Mount with #6-32 or #8-32 screws (not supplied).
- Available on 3 pole configurations and greater

### Mounting Plates

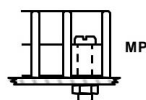
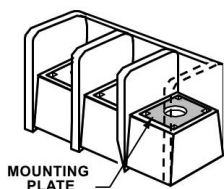

#### Option MP

MP Metal inserts with 0.150" dia. hole accept #6 screw.

Bulk part number 2MP-J.

## Contact Us

### Sales and Customer Service

#### Americas

Email: [elx.americas@eaton.com](mailto:elx.americas@eaton.com)

#### Europe, Middle East, Africa

Email: [elx.emea@eaton.com](mailto:elx.emea@eaton.com)

#### China

Email: [elx.cn@eaton.com](mailto:elx.cn@eaton.com)

#### Japan

Email: [elx.jp@eaton.com](mailto:elx.jp@eaton.com)

#### Korea

Email: [elx.kr@eaton.com](mailto:elx.kr@eaton.com)

#### South East Asia

Email: [elx.sea@eaton.com](mailto:elx.sea@eaton.com)

#### Taiwan

Email: [elx.tw@eaton.com](mailto:elx.tw@eaton.com)

### Global Technical Support

Magnetics: [InductorTech@eaton.com](mailto:InductorTech@eaton.com)

Circuit Protection: [FuseTech@eaton.com](mailto:FuseTech@eaton.com)

Supercapacitors: [CapacitorTech@eaton.com](mailto:CapacitorTech@eaton.com)

[www.eaton.com/terminalblocks](http://www.eaton.com/terminalblocks)

## Tools

### Eaton's Electronics Product Selection Tools



#### PARAMETRIC SEARCH

Drill down into the Eaton Electronics product database to find the right part for your application.



#### IC MATCHING

Find the Eaton Electronics parts called out on IC manufacturers' demo and evaluation boards.



#### CROSS REFERENCE

Find a cross to a competitor's product or to an alternate Eaton Electronics part number.



#### SUPERCAPACITOR CALCULATOR

Determine your calculated requirements and design capability.



#### TERMINAL BLOCK SELECTOR

Find the right terminal block for any application.



#### AUTOMOTIVE ELECTRONICS SOLUTIONS

Find electronics components for automotive solutions.

[tools.eatonelectronics.com](http://tools.eatonelectronics.com)

**Eaton**  
**Electronics Division**  
1000 Eaton Boulevard  
Cleveland, OH 44122  
United States  
[www.eaton.com/electronics](http://www.eaton.com/electronics)

© 2017 Eaton  
All Rights Reserved  
Printed in USA  
Publication No. 10682 — BU-MC17075  
December 2017

## X-ON Electronics

Largest Supplier of Electrical and Electronic Components

*Click to view similar products for [Barrier Terminal Blocks](#) category:*

*Click to view products by [Eaton](#) manufacturer:*

Other Similar products are found below :

[CR151D20104](#) [670A-RZ-15-KT20](#) [6C1N03](#) [6PCR-02](#) [6PCR-02-008](#) [6PCR-05-008](#) [6PCR-08-008](#) [6PCR-09-008](#) [6PCR-13-006](#) [6PCR-15-006](#) [6PCR-21-006](#) [6PCV-06-008](#) [6PCV-06-716](#) [6PCV-09-001](#) [6PCV-10-009](#) [6PCV-15-008](#) [6PCV-17-1206](#) [6PCV-20-323](#) [6PCV-30-006](#) [6STR-06-006](#) [6STR-08-006](#) [6STR-12-008](#) [6STR-13-006](#) [6STR-14-008](#) [6STR-16-008](#) [6STR-17-008](#) [6STR-21-008](#) [6STR-25-008](#) [6STR-27-008](#) [6STV-03-006](#) [6STV-03-008](#) [6STV-04-006](#) [6STV-09-006](#) [6STV-10-006](#) [6WWR-03-693](#) [6WWV-12-008](#) [6WWV-16-008](#) [71106-C](#) [71502-50](#) [71507-47-50](#) [72504-C-50](#) [72506-C](#) [72507-C-50](#) [72508-56](#) [73203](#) [75505-C-50](#) [7C1N08](#) [812-GP-3/4ST-09](#) [8-1437402-5](#) [8-1437402-7](#)