

Surge Protection

Surge Protection

xPole





SG13309



SG11309



Surge Protection

		SPD Class B			
SG13005  SPI-35/440	Impulse Current I_{imp} (10/350) μ s	Type Designation	Article No.	Units per package	
	Lightning current arresters SPI • No decoupling necessary, if arrester class C with $U_c = 460$ V are used for combination 35kA L - (PE)N SPI-35/440 263137 6 / 120 50kA N - PE SPI-50/NPE 263138 2 / 120 100kA N - PE SPI-100/NPE 263139 1 / 60				
Lightning current arrester Sets, Lightning protection classes I, II, III, IV					
SG14605  SPI-3+1	Description	Type Designation	Article No.	Units per package	
	SPD Class B, SPI TN-C-Set 3-pole SPI-35/440/3 267487 1 / 40 TN-S/TT-Set 3+1-pole SPI-3+1 267488 1 / 20				
	Lead-through terminal for SPI		SPB-D-125	248145	2 / 120
SPD Class B+C					
SG27112  SPBT12-280/1	Impulse Current I_{imp} (10/350) μ s	Type Designation	Article No.	Units per package	
	PHASE OUT TYPE Lightning current arrester - surge arrester SPBT12 12.5kA L - (PE) N SPBT12-280/1 158306 12 / 120 100 kA N-PE SPBT12-NPE100 158307 1 / 60				
Lightning current arrester - surge arrester Sets, Lightning protection classes III, IV					
SG29612  SPBT12-280/3	Description	Type Designation	Article No.	Units per package	
	SPD Class B+C, SPBT12 Without remote indication TN-S/TT-Set 1+1-pole SPBT12-280-1+NPE 158308 1 / 40 TN-S-Set 2-pole SPBT12-280/2 158309 1 / 60 TN-C-Set 3-pole SPBT12-280/3 158330 1 / 40 TN-S-Set 4-pole SPBT12-280/4 158331 1 / 30 TN-S/TT-Set 3+1-pole SPBT12-280-3+NPE 158332 1 / 20 TN-S/TT-Set 3+1-pole SPBT12-280-3+NPE/BB 158333 1				
	PHASE OUT TYPE With remote indication TN-S/TT-Set 1+1-pole SPBT12-280-1+NPE-AX 158334 1 / 30 TN-S/TT-Set 3+1-pole SPBT12-280-3+NPE-AX 158335 1				
SG10407  SPBT12-280-3+NPE-AX	Accessories				
	Auxiliary switch for SPBT12-280 Busbar	ASAUWSC-SPM ZV-KSBI...	131785	4 / 120	

Surge Protection

SG14905







SP-B+C/3

Lightning current arrester - surge arrester Sets, Lightning protection classes I, II, III, IV

Description	Type Designation	Article No.	Units per package	
SPD Class B+C, SP-B+C/				
TN-C-Set	3-pole	SP-B+C/3	267489	1
TN-S/TT-Set	3+1-pole	SP-B+C/3+1	267510	1
Accessories				
Auxiliary switch for SP-B+C	ASAUXSC-SPM	131785	8 / 80	

xPole

Surge Protection

		SPD Class C					
		Max. Cont. Op. Volt. U_c	I_n (8/20) μ s	Type Designation	Article No.	Units per package	
 <p>U1302</p> <p>SPC-E-280</p>	PHASE OUT TYPE	Surge arrester SPC-E					
		75VAC	15kA	SPC-E-75	248148	12 / 120	
		130VAC	20kA	SPC-E-130	248149	12 / 120	
		175VAC	20kA	SPC-E-175	118920	12 / 120	
		280VAC	20kA	SPC-E-280	248150	12 / 120	
		335VAC	20kA	SPC-E-335	248151	12 / 120	
		385VAC	20kA	SPC-E-385	248152	12 / 120	
		460VAC	20kA	SPC-E-460	248153	12 / 120	
		580VAC	20kA	SPC-E-580	248154	12 / 120	
		N-PE 260VAC	30kA	SPC-E-N/PE	248157	12 / 120	
 <p>SG13109</p> <p>SPC-S-20/280</p>	PHASE OUT TYPE	Plug-in surge arrester SPC-S					
		Insert 1-pole					
		Insert 75VAC	15kA	SPC-S-15/75	248158	4 / 120	
		Insert 130VAC	20kA	SPC-S-20/130	248159	4 / 120	
		Insert 175VAC	20kA	SPC-S-20/175	248160	4 / 120	
		Insert 280VAC	20kA	SPC-S-20/280	248161	4 / 120	
		Insert 335VAC	20kA	SPC-S-20/335	248162	4 / 120	
		Insert 385VAC	20kA	SPC-S-20/385	248163	4 / 120	
		Insert 460VAC	20kA	SPC-S-20/460	248164	4 / 120	
		Insert 580VAC	20kA	SPC-S-20/580	248165	4 / 120	
Insert N-PE 260VAC	30kA	SPC-S-N/PE	248166	4 / 120			
 <p>SG14802</p> <p>SPC-S-S4-3+1</p>	PHASE OUT TYPE	Base 1- to 4-pole					
		Base 1-pole		SPC-S-S1	248167	12 / 120	
		Base 1+1 2-pole		SPC-S-S2-1+1	248201	6 / 60	
		Base 2-pole		SPC-S-S2	248168	6 / 60	
		Base 3-pole		SPC-S-S3	248169	4 / 40	
		Base 4-pole		SPC-S-S4	248170	3 / 30	
 <p>U1202</p> <p>SPC-S-20/280/3</p>	PHASE OUT TYPE	Plug-in surge arrester SPC-S, 1- to 4-pole					
		Complete (2- and multi-pole surge arresters are supplied with busbar)					
		1-pole	130VAC	1x20kA	SPC-S-20/130/1	248188	12 / 120
		1-pole	175VAC	1x20kA	SPC-S-20/175/1	248189	12 / 120
		2-pole	175VAC	2x20kA	SPC-S-20/175/2	248190	1 / 60
		1-pole	280VAC	1x20kA	SPC-S-20/280/1	248172	12 / 120
		2-pole	280VAC	2x20kA	SPC-S-20/280/2	248173	1 / 60
		3-pole	280VAC	3x20kA	SPC-S-20/280/3	248174	1 / 40
		4-pole	280VAC	4x20kA	SPC-S-20/280/4	248175	1 / 30
		1-pole	335VAC	1x20kA	SPC-S-20/335/1	248176	12 / 120
2-pole	335VAC	2x20kA	SPC-S-20/335/2	248177	1 / 60		
3-pole	335VAC	3x20kA	SPC-S-20/335/3	248178	1 / 40		
4-pole	335VAC	4x20kA	SPC-S-20/335/4	248179	1 / 30		
1-pole	385VAC	1x20kA	SPC-S-20/385/1	248180	12 / 120		
2-pole	385VAC	2x20kA	SPC-S-20/385/2	248181	1 / 60		
3-pole	385VAC	3x20kA	SPC-S-20/385/3	248182	1 / 40		
4-pole	385VAC	4x20kA	SPC-S-20/385/4	248183	1 / 30		
1-pole	460VAC	1x20kA	SPC-S-20/460/1	248184	12 / 120		
2-pole	460VAC	2x20kA	SPC-S-20/460/2	248185	1 / 60		
3-pole	460VAC	3x20kA	SPC-S-20/460/3	248186	1 / 40		
4-pole	460VAC	4x20kA	SPC-S-20/460/4	248187	1 / 30		
1-pole	580VAC	1x20kA	SPC-S-20/580/1	248191	12 / 120		
1+1p	–	–	SPC-S-1+1	248192	1 / 60		
3+1p	–	–	SPC-S-3+1	248193	1 / 30		
3+1p	–	–	SPC-S-3+N/PE	115795	1 / 30		

xPole

Surge Protection

SG14902



SPCT2-280

NEW

Plug-in surge arrester SPCT2

Insert 1-pole

Insert 75VAC	20kA	SPCT2-075	167577	4/120
Insert 130VAC	20kA	SPCT2-130	167582	4/120
Insert 175VAC	20kA	SPCT2-175	167587	4/120
Insert 280VAC	20kA	SPCT2-280	167592	4/120
Insert 335VAC	20kA	SPCT2-335	167597	4/120
Insert 385VAC	20kA	SPCT2-385	167602	4/120
Insert 460VAC	20kA	SPCT2-460	167607	4/120
Insert 580VAC	20kA	SPCT2-580	167612	4/120
Insert 260VAC	30kA	SPCT2-NPE60	167617	4/120

U1202



SPCT2-280/3

NEW

Plug-in surge arrester SPCT2, 1- to 4-pole

Complete (2- and multi-pole surge arresters are supplied with busbar)

1-pole	75VAC	20kA	SPCT2-075/1	167578	12/120
1-pole	130VAC	20kA	SPCT2-130/1	167583	12/120
1-pole	175VAC	20kA	SPCT2-175/1	167588	12/120
1-pole	280VAC	20kA	SPCT2-280/1	167593	12/120
1-pole	335VAC	20kA	SPCT2-335/1	167598	12/120
1-pole	385VAC	20kA	SPCT2-385/1	167603	12/120
1-pole	460VAC	20kA	SPCT2-460/1	167608	12/120
1-pole	580VAC	20kA	SPCT2-580/1	167613	12/120
1+N	260VAC	30kA	SPCT2-NPE60/1	167618	12/120
2-pole	75VAC	2x20kA	SPCT2-075/2	167579	1/60
2-pole	130VAC	2x20kA	SPCT2-130/2	167584	1/60
2-pole	175VAC	2x20kA	SPCT2-175/2	167589	1/60
2-pole	280VAC	2x20kA	SPCT2-280/2	167594	1/60
2-pole	335VAC	2x20kA	SPCT2-335/2	167599	1/60
2-pole	385VAC	2x20kA	SPCT2-385/2	167604	1/60
2-pole	460VAC	2x20kA	SPCT2-460/2	167609	1/60
2-pole	580VAC	2x20kA	SPCT2-580/2	167614	1/60
3-pole	75VAC	3x20kA	SPCT2-075/3	167580	1/40
3-pole	130VAC	3x20kA	SPCT2-130/3	167585	1/40
3-pole	175VAC	3x20kA	SPCT2-175/3	167590	1/40
3-pole	280VAC	3x20kA	SPCT2-280/3	167595	1/40
3-pole	335VAC	3x20kA	SPCT2-335/3	167600	1/40
3-pole	385VAC	3x20kA	SPCT2-385/3	167605	1/40
3-pole	460VAC	3x20kA	SPCT2-460/3	167610	1/40
3-pole	580VAC	3x20kA	SPCT2-580/3	167615	1/40
4-pole	75VAC	4x20kA	SPCT2-075/4	167581	1/30
4-pole	130VAC	4x20kA	SPCT2-130/4	167586	1/30
4-pole	175VAC	4x20kA	SPCT2-175/4	167591	1/30
4-pole	280VAC	4x20kA	SPCT2-280/4	167596	1/30
4-pole	335VAC	4x20kA	SPCT2-335/4	167601	1/30
4-pole	385VAC	4x20kA	SPCT2-385/4	167606	1/30
4-pole	460VAC	4x20kA	SPCT2-460/4	167611	1/30
4-pole	580VAC	4x20kA	SPCT2-580/4	167616	1/30
1+N	280VAC	20kA	SPCT2-280-1+NPE	167619	1/60
1+N	335VAC	20kA	SPCT2-335-1+NPE	167621	1/60
1+N	385VAC	20kA	SPCT2-385-1+NPE	167623	1/60
1+N	460VAC	20kA	SPCT2-460-1+NPE	167625	1/60
1+N	580VAC	20kA	SPCT2-580-1+NPE	167627	1/60
3+N	280VAC	20kA	SPCT2-280-3+NPE	167620	1/30
3+N	335VAC	20kA	SPCT2-335-3+NPE	167622	1/30
3+N	385VAC	20kA	SPCT2-385-3+NPE	167624	1/30
3+N	460VAC	20kA	SPCT2-460-3+NPE	167626	1/30
3+N	580VAC	20kA	SPCT2-580-3+NPE	167628	1/30
3+N/BB	280VAC	3x20kA	SPCT2-280-3+NPE/BB	167629	1
3+N/BB	335VAC	3x20kA	SPCT2-335-3+NPE/BB	167630	1
3+N/BB	385VAC	3x20kA	SPCT2-385-3+NPE/BB	167631	1
3+N/BB	460VAC	3x20kA	SPCT2-460-3+NPE/BB	167632	1

xPole

Surge Protection

SG14805



SPC-S-3+1-SET

SG60611



SG59511



PHASE OUT TYPE

NEW

Surge arrester Set

Description	Type Designation	Article No.	Units per package
-------------	------------------	-------------	-------------------

SPD Class C, SPC

Surge arrester set	SPC-S-3+1-SET	248194	1
--------------------	---------------	--------	---

Auxiliary Switch

for SPCT2	ASAUXSC-SPM	131785	8 / 80
-----------	-------------	--------	--------

Description	Type Designation	Article No.	Units per package
-------------	------------------	-------------	-------------------

Lead-through terminal for SPB, ASLTT-63

	ASLTT-63	131784	12 / 120
--	----------	--------	----------

xPole

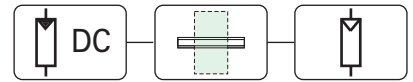

SG11009



SG11309



SPD-type T2 (Class C)

Max. Cont. Op. Volt. U_C I_n (Type Designation	Article No.	Units per package
------------------------------------	------------------	-------------	-------------------

Plug-in Surge Arrester SPPT2PA for Photovoltaic application

For earthed systems

600 V DC	SPPT2PA-600-2PE	132663	1 / 60
1000 V DC	SPPT2PA-1000-2PE	132664	1 / 60

with auxiliary switch
1000 V DC

SPPT2PA-1000-2PE-AX	132666	1 / 60
---------------------	--------	--------

For unearthed systems

600 V DC	SPPT2PA-600-2+1PE	132661	1 / 40
1000 V DC	SPPT2PA-1000-2+1PE	132662	1 / 40

with auxiliary switch
1000 V DC

SPPT2PA-1000-2+1PE-AX	132665	1 / 40
-----------------------	--------	--------

Inserts for replacement

600 V DC	①	SPPT2PA-600	132667	1
1000 V DC	①	SPPT2PA-1000	132668	1
1100 V DC	②	SPPT2PA-1100	132669	1

$V_{oc} \leq U_C$: Open circuit voltage of PV-Generator shall be equal or less than maximum continuous operating voltage of Surge Protective Device (SPD) to prevent its damage.

V_{oc} Open circuit voltage of PV-Generator.

U_C Maximum continuous operating voltage of SPD.

⚡ Attention: Even at switched off DC-Disconnecter system stays under high voltage!
Before mounting ensure de-energizing and check zero-potential.

Earthed system

SPPT2PA-600-2PE
SPPT2PA-1000-2PE(-AX)

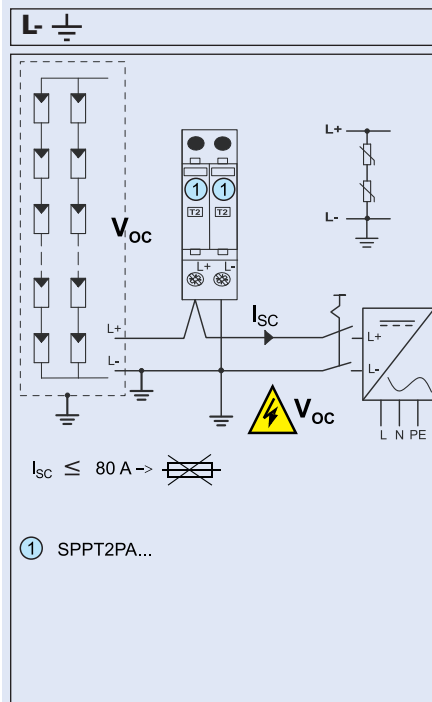

Unearthed system

SPPT2PA-600-2+1PE
SPPT2PA-1000-2+1PE(-AX)

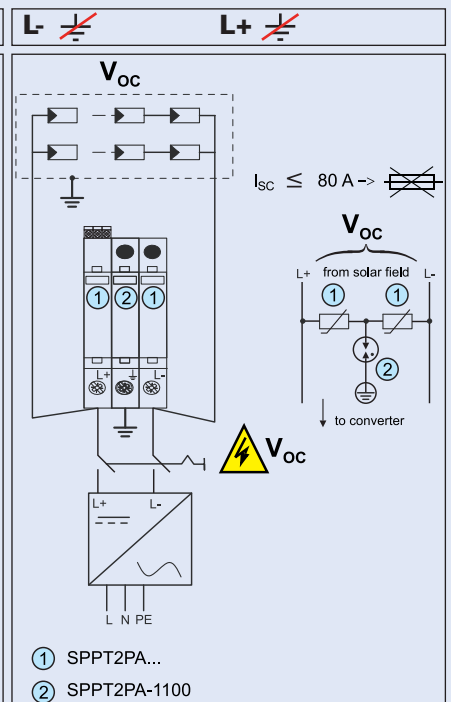

Surge Protection



Z-GV-U/9

WA_SG11202

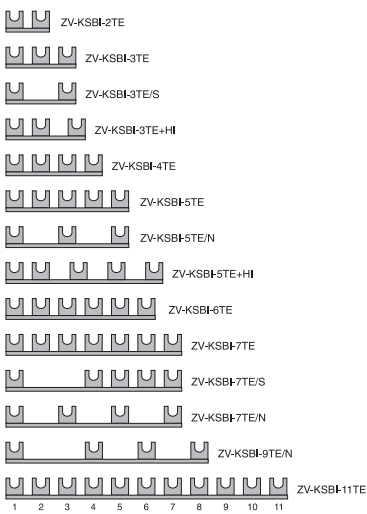
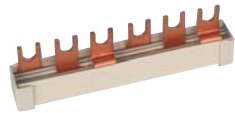

Poles	Type Designation	Article No.	Units per package
Busbars Z-GV-U/ for SPI, SP-B+C			
2	Z-GV-U/2	272588	20 / 1200
3	Z-GV-U/3	272589	20 / 1200
4	Z-GV-U/4	274080	20 / 1200
5	Z-GV-U/5	274081	20 / 1200
6	Z-GV-U/6	274082	20 / 400
8	Z-GV-U/8	274083	20 / 200
9	Z-GV-U/9	274084	20 / 200
Busbar Z-GV-16/3P-3TE/6 for SPI and SPC			
	Z-GV-16/3P-3TE/6	267511	12 / 240
Busbars ZV-KSBI for SPC			
2MU	ZV-KSBI-2TE	263961	10 / 600
3MU	ZV-KSBI-3TE	263962	10 / 600
3MU	ZV-KSBI-3TE/S	263963	10 / 600
2MU+1.5MU	ZV-KSBI-3TE+HI	112370	50 / 150
4MU	ZV-KSBI-4TE	263964	10 / 600
5MU	ZV-KSBI-5TE	263965	10 / 200
5MU	ZV-KSBI-5TE/N	263966	10 / 200
2MU+3x1.5MU	ZV-KSBI-5TE+HI	112371	50 / 150
6MU	ZV-KSBI-6TE	113118	50 / 500
7MU	ZV-KSBI-7TE	263967	50 / 500
7MU	ZV-KSBI-7TE/S	263968	10 / 100
7MU	ZV-KSBI-7TE/N	263969	10 / 100
9MU	ZV-KSBI-9TE/N	266874	50 / 500
11MU	ZV-KSBI-11TE	263970	50 / 500

xPole

Surge Protection

SPD Class D



SPD-S-1+1

PHASE OUT TYPE

Surge protective device SPD-S-1+1 for TN-, TT-systems (3-phase 4-wire)

Description	Type Designation	Article No.	Units per package
Complete device	SPD-S-1+1	248202	1 / 60
Insert N-PE	SPD-S-N/PE	248199	4 / 120
Insert L-N	SPD-S-L/N	248200	4 / 120
Base 1+1 2-pole	SPC-S-S2-1+1	248201	6 / 60
Auxiliary switch	SPC-S-HK	248203	8 / 80

N00411



Surge protective device SPD-S-280/2 for IT-, TT-systems (3-phase 3-wire)

Description	Type Designation	Article No.	Units per package
Complete device	SPD-S-280/2	269088	1 / 60
Insert	SPD-S-280	269087	4 / 120
Base	SPC-S-S2	248168	6 / 60
Auxiliary switch	SPC-S-HK	248203	8 / 80

19" Multiple Outlet Strips NWS-STL/19/7F

Description	Type Designation	Article No.	Units per package
7 outlets, DIN	NWS-STL/19/7F	255398	1
7 outlets, plus switch, DIN	NWS-STL/19/7F/S/BL	255399	1
7 outlets, UTE	NWS-STL/19/7F/UTE	290031	1

N00511



19" Surge Protection - Multiple Outlet Strips with Switch SPD-STL/19/7F-S/BL

Description	Type Designation	Article No.	Units per package
7 outlets, plus switch, DIN	SPD-STL/19/7F-S/BL	283449	1
7 outlets, UTE	SPD-STL/19/7F-S/BL/UTE	290032	1

N04011



Surge Protection Multiple Outlet Strips with High-Range Filter and Energy Absorption for full Equipment Protection SPD-STL/6F-S

Description	Type Designation	Article No.	Units per package
6 outlets, plus switch, DIN	SPD-STL/6F-S (68583)	130000	1
6 outlets, plus switch, DIN+ISDN	SPD-STL/6F-S/ISDN (68585)	147795	1
19" fixing bracket for SPD-STL/6F-S (1U)	NWS-HW/19/SPD-STL/6F-S	166364	1

Surge Protection

Earthing/Equipotential Bonding

SG07306



Description	Type Designation	Article No.	Units per package
-------------	------------------	-------------	-------------------

Equipotential Bonding Bar PAS-7x16

- For main equipotential bonding
- Earthing strip up to 30 x 3.5 / Round conductor 7 - 10 mm



7 x 2.5 - 16 mm ²	PAS-7x16	107945	10 / 50
------------------------------	----------	--------	---------

SG07206



Earthing Bar for Antenna Lines PAS-HF-6

- Earthing conductor 6 - 25 mm²



6 x HF-Cable shields	PAS-HF-6	107946	10 / 100
----------------------	----------	--------	----------

SG07406



Earth Clips EBS

- For copper and galvanized steel/stainless steel tubes
- Cross-section for connection 1 x 2.5 mm² to 2 x 16 mm²



Tube Ø 1/8" - 1 1/2"	EBS-210mm	107947	20 / 80
Tube Ø 1/8" - 4"	EBS-430mm	107948	20 / 80

xPole

Surge Protection

SPD Class B, Lightning Current Arrester SPI

- Field of application: For the protection of low voltage distribution systems against direct lightning stroke into the overhead power supply line or external lightning protection system (IEC 62305).
- Application according to IEC 60364-5-53 Clause 534
- Test class **I** in accordance with IEC 61643-1
- SPD-type **T1** in accordance with EN 61643-1
- Capsuled version: during the discharge process, the device does not issue any hot ionised gases. Therefore, there is no need for keeping a safety distance to flammable materials.

Practical Hint

Installation of lightning current arresters upstream of the meter is subject to co-ordination with the relevant power supply company. Installation of an r.m.s.ective protection cascade (SPD classes B, C, D) requires co-ordinated application of the respective protective devices. This is ensured by a defined line length between protective devices. When using lightning current arresters of type SPI in connection with surge arresters SPC with a maximum continuous operating voltage U_c of 460 V AC, no specific line length or decoupling coils are required.

Technical Data

	SPI-35/440	SPI-50/NPE	SPI-100/NPE
Electrical			
Design	capsuled	capsuled	capsuled
Responding time t_r	< 100 ns	< 100 ns	< 100 ns
Voltage protection level U_p	1.5 kV	1.5 kV	1.5 kV
Maximum continuous operating voltage U_C	440 VAC	260 VAC	260 VA
Temporary overvoltage test value U_T (200 ms) (5 s)	–	1200 VAC	1200 VAC
Rated frequency	50/60 Hz	50/60 Hz	50/60 Hz
Discharge current (8/20) μs I_{max}/I_n	35 kA	50 kA	100 kA
Impulse current I_{imp} (10/350) μs			
Peak current	35 kA	50 kA	100 kA
Charge Q	17.5 As	25 As	50 As
Specific energy	305 kJ/ Ω	625 kJ/ Ω	2500 kJ/ Ω
Insulation resistance R_{ISO}	>10 M Ω	>10 M Ω	>10 M Ω
Follow current interrupt rating I_{fi}	3kA _{r.m.s.} /260V 1.5kA _{r.m.s.} /440V	500A _{r.m.s.} /260V	100A _{r.m.s.} /260V
Short-circuit current strength at max. back-up fuse	25kA _{r.m.s.}	–	–
Maximum back-up fuse	125 AgL	–	–
Connection diagram			
Mechanical			
Frame size	45 mm	45 mm	45 mm
Device height	90 mm	90 mm	90 mm
Device width	17.5 mm	17.5 mm	35 mm
Weight	174 g	178 g	320 g
Upper and lower lift terminal capacity			
rigid	0.5 - 35 mm ²	0.5 - 35 mm ²	10 - 50 mm ²
flexible	0.5 - 25 mm ²	0.5 - 25 mm ²	16 - 35 mm ²
Tightening torque of terminal screws	4 - 4.5 Nm	4 - 4.5 Nm	6 - 8 Nm
Mounting	quick fastening on DIN rail IEC/EN 60715		
Degree of protection acc. to IEC 60529 (installed)	IP20 (IP40)		
Accessories: busbars	Z-GV-U/		
Permitted relative air humidity	< 95%		
Permitted ambient temperature	-40°C to +85°C		

Dimensions (mm)

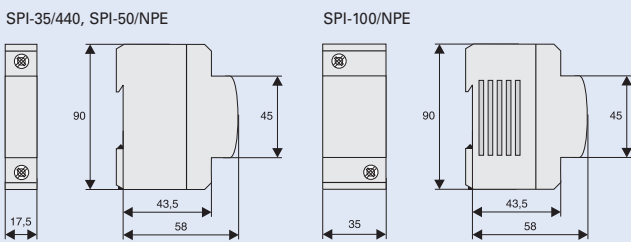

Lightning current arrester Sets, Lightning protection classes I, II, III, IV

SPI-35/440/3 SPI-3+1

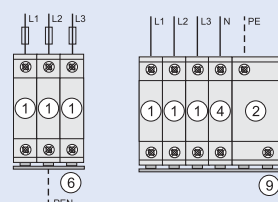

- ① ... SPI-35/440
- ② ... SPI-100/NPE
- ④ ... SPB-D-125
- ⑥ ... Z-GV-U/3
- ⑨ ... Z-GV-U/6

Application Example

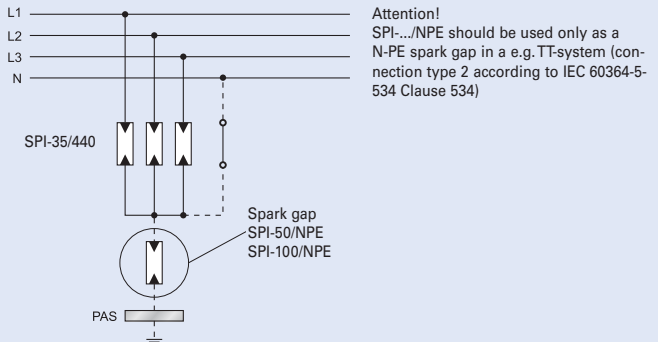

SPI-50/NPE: for protection class III, IV according to IEC 62305
 SPI-100/NPE: for protection class I, II, III, IV according to IEC 62305

Surge Protection

SPD Class B+C, Lightning Current Arrester - Surge Arresters SPBT12

- Field of application
For the protection of low voltage distribution systems against transient overvoltage caused by direct and indirect lightning stroke and switching operations.
- Application according to IEC 60364-5-53 Clause 534
- Test class **I**, **II** in accordance with IEC 61643-1
- SPD-type **T1**, **T2** in accordance with EN 61643-11
- Lightning protection classes III and IV in accordance with IEC 62305
- Busbars ZV-KSBI are available for all customary applications

Block Diagram



Technical Data

	SPBT12-280...	SPBT12-NPE100
Electrical	per pole	
Responding time (rate of voltage rise 5 kV/μs)	< 25 ns	< 100 ns
Voltage protection level U_p	< 1.5kV	< 1.5kV
Voltage protection level at 5 kA (8/20) μs	950 V	-
Maximum continuous operating voltage U_c	280 VAC	255 VAC
Temporary overvoltage test value U_T	370 VAC (5 s)	1200 VAC (200 ms)
Rated frequency	50/60 Hz	50/60 Hz
Open circuit voltage U_{oc}	10 kV	20 kV
Nominal discharge current (8/20) μs I_n	25 kA	100 kA
Maximum discharge current I_{max}	50 kA	100 kA
Impulse current I_{imp} (10/350) μs		
Peak current	12.5 kA	100 kA
Charge Q	6.25 As	50 As
Specific energy	39.1 kJ/Ω	2500 kJ/Ω
Follow current interrupt rating I_{fi}	-	100 A _{r.m.s}
Maximum back-up fuse	160 AgL/gG	-
Maximum short-circuit current	50 kA _{r.m.s}	-
Connection diagram		

Mechanical

Frame size	45 mm	45 mm
Device height	80 mm	80 mm
Device width	17.5 mm	35 mm
Weight	121 g	250 g
Permitted ambient temperature	-40°C to +70°C	-40°C to +70°C
Degree of protection (built-in)	IP40	IP40
Upper and lower lift terminal capacity	4 - 25 mm ²	4 - 35 mm ²
Upper and lower open mouthed terminals for busbar thickness up to	1.5 mm	1.5 mm
Tightening torque of terminal screws	2.4 - 3 Nm	2.4 - 3 Nm
Quick fastening on DIN rail according to	IEC/EN 60715	IEC/EN 60715
Accessories: busbars 16 mm ²	Type ZV-KSBI ...	Type ZV-KSBI ...

Dimensions (mm)

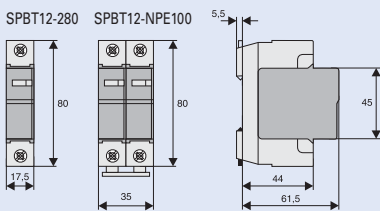

Lightning current arrester - surge arrester Sets, Lightning protection classes III, IV

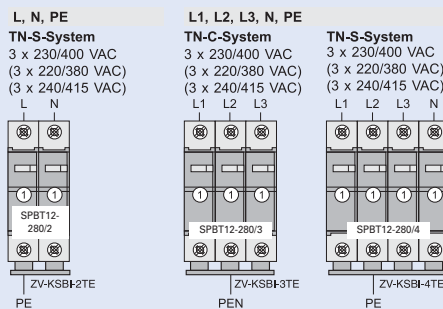

① ...SPBT12-280

Surge Protection

SPD Class B+C, Lightning Current Arrester - Surge Arresters SPBT12-280

- Field of application
For the protection of low voltage distribution systems against transient overvoltage caused by direct and indirect lightning stroke and switching operations.
- Application according to IEC 60364-5-53 Clause 534
- Test class **I**, **II** in accordance with IEC 61643-1
- SPD-type **T1**, **T2** in accordance with EN 61643-11
- Lightning protection classes III and IV in accordance with IEC 62305
- Busbars ZV-KSBI are available for all customary applications

Block Diagram



Technical Data

		SPBT12-280-1+NPE	SPBT12-280-3+NPE
Electrical		per pole	
Responding time (rate of voltage rise 5 kV/μs)	L-N / N-PE	< 25 ns / < 100 ns	< 25 ns / < 100 ns
Voltage protection level U_p	L-N / L-PE / N-PE	< 1.5kV	< 1.5kV
Maximum continuous operating voltage U_C	L-N / N-PE	280 VAC / 255 VAC	280 VAC / 255 VAC
Temporary overvoltage test value U_T (5 s) (200 ms)	L-N / L-PE	348 VAC / 370 VAC	348 VAC / 370 VAC
	N-PE	1200 VAC	1200 VAC
Rated frequency		50/60 Hz	50/60 Hz
Open circuit voltage U_{oc}		10 kV	20 kV
Nominal discharge current (8/20) μs I_n	L-N / N-PE	25 kA / 100 kA	3x25 kA / 100 kA
Maximum discharge current I_{max}	L-N / N-PE	50 kA / 100 kA	3x50 kA / 100 kA
Impulse current I_{imp} (10/350) μs			
	Peak current	L-N / N-PE	12.5 kA / 100 kA
Charge Q		50 As	50 As
Specific energy		2500 kJ/Ω	2500 kJ/Ω
Follow current interrupt rating I_{fi}	N-PE	100 A _{r.m.s}	100 A _{r.m.s}
Maximum back-up fuse		160 AgL/gG	160 AgL/gG
Maximum short-circuit current		50 kA _{r.m.s}	50 kA _{r.m.s}
Connection diagram			
Mechanical			
Frame size		45 mm	45 mm
Device height		80 mm	80 mm
Device width		52.5 mm	87.5 mm
Weight		375 g	626 g
Permitted ambient temperature		-40°C to +70°C	-40°C to +70°C
Degree of protection (built-in)		IP40	IP40
Upper and lower lift terminal capacity	L, N	4 - 25 mm ²	4 - 25 mm ²
	N, PE	4 - 35 mm ²	4 - 35 mm ²
Upper and lower open mouthed terminals for busbar thickness up to		1.5 mm	1.5 mm
Tightening torque of terminal screws		2.4 - 3 Nm	2.4 - 3 Nm
Quick fastening on DIN rail according to		IEC/EN 60715	IEC/EN 60715
Accessories: busbars 16 mm ²		Type ZV-KSBI ...	Type ZV-KSBI ...

Lightning current arrester - surge arrester Sets, Lightning protection classes III, IV

<p>L, N, PE TN-S-System 3 x 230/400 VAC (3 x 220/380 VAC) (3 x 240/415 VAC)</p> <p>SPBT12-280-1+NPE</p>	<p>L1, L2, L3, N, PE TN-S/TT-System 3 x 230/400 VAC (3 x 220/380 VAC) (3 x 240/415 VAC)</p> <p>SPBT12-280-3+NPE</p>	<p>TN-S/TT-System 3 x 230/400 VAC (3 x 220/380 VAC) (3 x 240/415 VAC)</p> <p>SPBT12-280-3+NPE/BB</p>	<p>L, N, PE TN-S-System 3 x 230/400 VAC (3 x 220/380 VAC) (3 x 240/415 VAC)</p> <p>SPBT12-280-1+NPE-AX</p>	<p>L1, L2, L3, N, PE TN-S/TT-System 3 x 230/400 VAC (3 x 220/380 VAC) (3 x 240/415 VAC)</p> <p>SPBT12-280-3+NPE-AX</p>	<p>① ...SPBT12-280 ② ...ASAUXSC-SPM ③ ...SPI-100/NPE ④ ...ASLTT-63</p>
---	---	---	--	--	--

Surge Protection

Lightning current arrester - surge arrester Sets, Lightning protection classes I, II, III, IV

SPD Class B+C, SP-B+C/

- Field of application: For the protection of low voltage distribution systems against direct lightning stroke into the overhead power supply line or external lightning protection system (IEC 62305) and against indirect lightning stroke and switching operations.
- Application according to IEC 60364-5-53 Clause 534
- Test class **I** and **II** in accordance with IEC 61643-1
- SPD-type **T1** and **T2** in accordance with EN 61643-11
- Capsuled version: during the discharge process, the device does not issue any hot ionised gases. Therefore, there is no need for keeping a safety distance to flammable materials.

Practical Hint

Installation of lightning current arresters upstream of the meter is subject to co-ordination with the relevant power supply company.
Installation of an r.m.s. active protection cascade (SPD classes B, C, D) requires co-ordinated application of the respective protective devices. This is ensured by a defined line length between protective devices. When using lightning current arresters of type SPI in connection with surge arresters SPC with a maximum continuous operating voltage U_c of 460 V AC, no specific line length or decoupling coils are required.

Technical Data

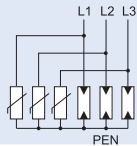
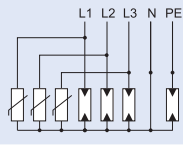
		SP-B+C/3	SP-B+C/3+1
Electrical			
Design		capsuled	capsuled
Responding time t_r		< 25 ns	< 25 ns
Voltage protection level U_p		1.5 kV	1.5 kV
Maximum continuous operating voltage U_c	L-(PE)N / N-PE	440 VAC / -	440 VAC / 260 VAC
Temporary overvoltage test value U_T	L-(PE)N N-PE	$U_T = U_c$ -	$U_T = U_c$ 1200 VAC (200 ms)
Rated frequency		50/60 Hz	50/60 Hz
Discharge current I_{max}/I_n		3x35 kA	100 kA
Impulse current I_{imp} (10/350) μ s			
Peak current		100 kA	100 kA
Charge Q		50 As	50 As
Specific energy		2500 kJ/ Ω	2500 kJ/ Ω
Follow current interrupt rating I_{fi}	L-(PE)N / N-PE		
at 260 V		3kA _{rms} / -	3kA _{rms} / 100A _{rms}
at 440 V		1,5kA _{rms} / -	1,5kA _{rms} / -
Short-circuit current strength at max. back-up fuse		25kA _{rms}	25kA _{rms}
Maximum back-up fuse		125 AgL	125 AgL
Connection diagram			
Mechanical			
Frame size		45 mm	45 mm
Device height		90 mm	90 mm
Device width		110 mm	164 mm
Weight		1100 g	1420 g
Upper and lower lift terminal capacity			
rigid	L, N, PEN / PE	0.5 - 35 mm ²	0.5 - 35 mm ² / 10 - 50 mm ²
flexible	L, N, PEN / PE	0.5 - 25 mm ²	0.5 - 25 mm ² / 16 - 35 mm ²
Tightening torque of terminal screws		4 - 4.5 Nm	4 - 4.5 Nm / 6 - 8 Nm
Mounting		quick fastening on DIN rail IEC/EN 60715	
Degree of protection acc. to IEC 60529 (installed)		IP20 (IP40)	
Accessories: busbars		Z-GV-U/	
Permitted relative air humidity		< 95%	
Permitted ambient temperature		-40°C to +70°C	

Dimensions (mm)

TN-C-System

3 x 230/400 VAC
(3 x 220/380 VAC)
(3 x 240/415 VAC)

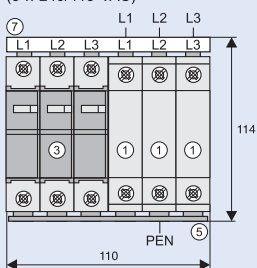

TT-, TN-S-System

3 x 230/400 VAC
(3 x 220/380 VAC)
(3 x 240/415 VAC)

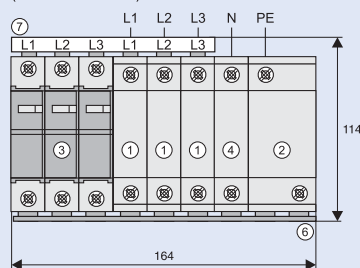

Lightning current arrester - surge arrester

- ① ...SPI-35/440
- ② ...SPI-100/NPE for protection class I, II, III, IV
- ③ ...SPC-S-20/460/3

Lead-through terminal

- ④ ...SPB-D-125

Busbar

- ⑤ ...Z-GV-U/6
- ⑥ ...Z-GV-U/9
- ⑦ ...Z-GV-16/3P-3TE/6

Surge Protection

Busbar Connection Examples according to IEC 60364-5-53 Clause 534

SPD Class B **SPI B**

<p>TN-C-System</p> <p>3 x 240/415 V AC 3 x 230/400 V AC 3 x 220/380 V AC</p>		<p>TT-System 3 x 230 VAC</p>		<p>IT-System 3 x 230 VAC</p>			
<p>SPI-35/440/3</p>		<p>SPI-35/440/3</p>		<p>SPI-35/440/3</p>			
4 wires		2 wires		4 wires		3 wires	
<p>TN-S-System</p> <p>3 x 240/415 V AC 3 x 230/400 V AC 3 x 220/380 V AC</p>		<p>TT-System</p>		<p>IT-System 3 x 230/400 VAC</p>			
<p>L1 L2 L3 N</p>		<p>L1 L2 L3 N</p>		<p>L1 L2 L3 N</p>			
SPI-3+1		SPI-3+1		SPI-3+1			
CT2		CT2		CT2			
5 wires		5 wires		3 wires			
<p>TN-S-System</p> <p>TN-S-System</p>		<p>L N</p>		<p>Lightning current arrester</p> <p>① ...SPI-35/440</p> <p>② ...SPI-100/NPE for protection class I, II, III, IV</p> <p>SPI-50/NPE for protection class III, IV</p> <p>Lead-through terminal</p> <p>④ ...SPB-D-125</p> <p>Busbar</p> <p>⑤ ...Z-GV-U/2</p> <p>⑥ ...Z-GV-U/3</p> <p>⑦ ...Z-GV-U/4</p> <p>⑧ ...Z-GV-U/4 at SPI-100/NPE</p> <p>Z-GV-U/3 at SPI-50/NPE</p> <p>⑨ ...Z-GV-U/6 (Z-GV-U/5 at SPI-50/NPE)</p>			
CT1		CT1		CT1			
5 wires		3 wires		CT1 . .Connection type 1			
				CT2 . .Connection type 2			

Surge Protection

Busbar Connection Examples according to IEC 60364-5-53 Clause 534

SPD Class B+C SPI B SPC C

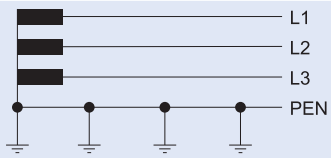
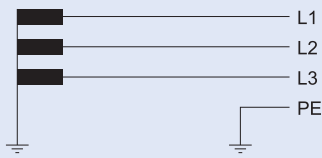
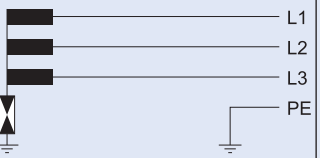
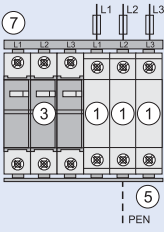
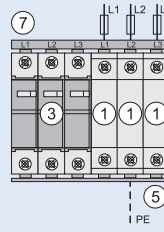
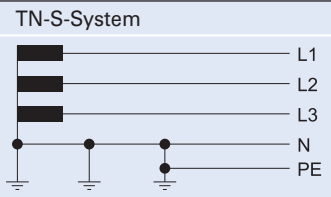
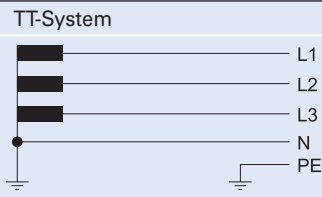
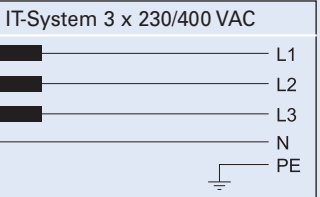
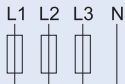
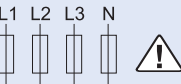
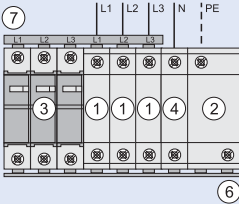
<p>TN-C-System</p> <p>3 x 240/415 V AC 3 x 230/400 V AC 3 x 220/380 V AC</p> 	<p>TT-System 3 x 230 VAC</p> 	<p>IT-System 3 x 230 VAC</p> 
<p>SP-B+C/3</p>  <p>4 wires</p>	<p>SP-B+C/3</p>  <p>4 wires</p>	
<p>TN-S-System</p> <p>3 x 240/415 V AC 3 x 230/400 V AC 3 x 220/380 V AC</p> 	<p>TT-System</p> 	<p>IT-System 3 x 230/400 VAC</p> 
		
<p>SP-B+C/3+1</p>  <p>CT2</p> <p>5 wires</p>		

Lightning current arrester

- ① ...SPI-35/440
- ② ...SPI-100/NPE for protection class I, II, III, IV
SPI-50/NPE for protection class III, IV
- ③ ...SPCT2-460/3

Lead-through terminal

- ④ ...SPB-D-125

Busbar

- ⑤ ...Z-GV-U/6
- ⑥ ...Z-GV-U/9
- ⑦ ...Z-GV-16/3P-3TE/6

CT2 . . Connection type 2

Surge Protection

Application Examples according to IEC 60364-5-53 Clause 534

Lightning current arrester

- ① ...SPI-35/440
- ⑥ ...SPI-100/NPE
- ③ ...SPI-50/NPE

Surge arrester

- ② ...SPCT2-460/3

Lead-through terminal

- ⑤ ...SPB-D-125
- ⑧ ...ASLTT-63

Busbar

- ④ ...ZV-KSBI-4TE

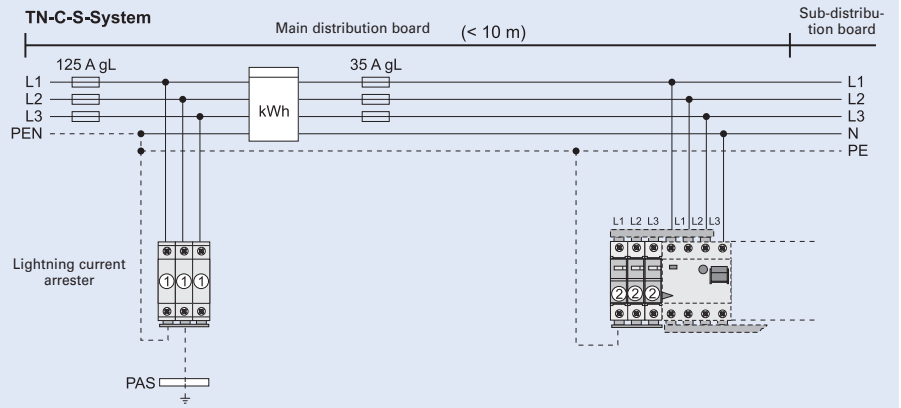

Protection Class I, II, III, IV

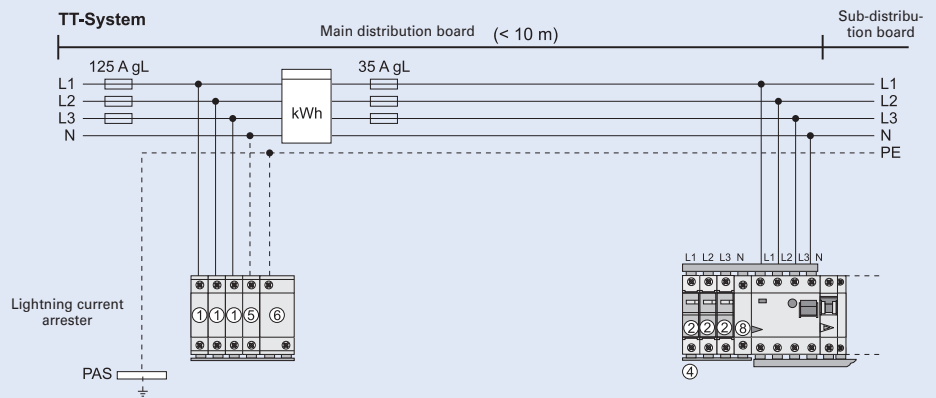

Protection Class III, IV

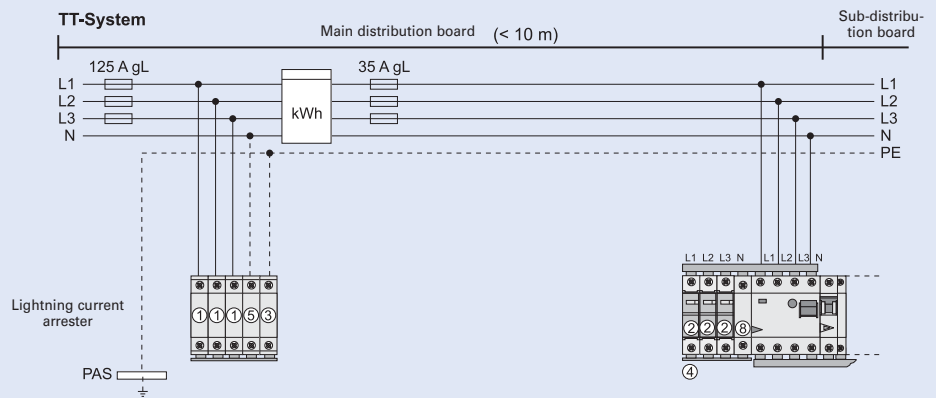

Surge Protection

SPD Class C, Surge Arresters SPC-E

- Field of application
For the protection of low voltage distribution systems against transient overvoltage caused by indirect lightning stroke and switching operations.
- Test class **II** according to IEC 61643-1+A1
- SPD-type **T2** according to EN 61643-11
- Busbars ZV-KSBI are available for all customary applications
- Suitable for busbar connection to all Xtra Combinations switchgear

Block Diagram

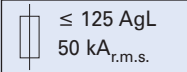
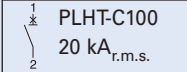
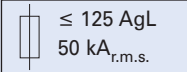
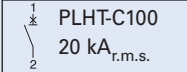

Technical Data

	SPC-E-75	-130	-175	-280	-335	-385	-460	-580
Electrical								
Responding time (rate of voltage rise 5 kV/μs)	< 25 ns	< 25 ns	< 25 ns	< 25 ns	< 25 ns	< 25 ns	< 25 ns	< 25 ns
Voltage protection level at nominal discharge current	< 550 V	< 800 V	< 1kV	< 1.4kV	< 1.6kV	< 1.8kV	< 2.2kV	< 2.6kV
Voltage protection level at 5 kA (8/20) μs	400 V	550 V	700 V	1000 V	1200 V	1350 V	1700 V	2000 V
Maximum continuous operating voltage U_c	75 VAC	130 VAC	175 VAC	280 VAC	335 VAC	385 VAC	460 VAC	580 VAC
Temporary overvoltage test value U_T (5 s)	$= U_c$	$= U_c$	$= U_c$	350 VAC	415 VAC	415 VAC	580 VAC	$= U_c$
Rated frequency	50/60 Hz	50/60 Hz	50/60 Hz	50/60 Hz	50/60 Hz	50/60 Hz	50/60 Hz	50/60 Hz
Nominal discharge current (8/20) μs I_n	15 kA	20 kA	20 kA	20 kA	20 kA	20 kA	20 kA	20 kA
Charge Q at I_n	0.43 As	0.57 As	0.57 As	0.57 As	0.57 As	0.57 As	0.57 As	0.57 As
Specific energy at I_n	3.2 kJ/Ω	5.7 kJ/Ω	5.7 kJ/Ω	5.7 kJ/Ω	5.7 kJ/Ω	5.7 kJ/Ω	5.7 kJ/Ω	5.7 kJ/Ω
Maximum discharge current I_{max}	30 kA	40 kA	40 kA	40 kA	40 kA	40 kA	40 kA	40 kA
Permissible back-up fuse								
Maximum short-circuit current								

Connection diagram

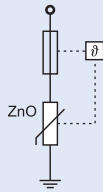

Mechanical

Frame size	45 mm
Device height	80 mm
Device width	17.5 mm
Weight	97 g
Permitted ambient temperature	-40°C to +70°C
Degree of protection (built-in)	IP40
Upper and lower lift terminal capacity	4 - 25 mm ²
Upper and lower open mouthed terminals for busbar thickness up to	1.5 mm
Tightening torque of terminal screws	2.4 - 3 Nm
Quick fastening on DIN rail according to	IEC/EN 60715
Accessories: busbars 16 mm ²	Type ZV-KSBI ...

Surge Protection

Technical Data

SPC-E-N/PE

Electrical

Responding time (rate of voltage rise 5 kV/μs)	< 100 ns
Voltage protection level at nominal discharge current	< 1.0 kV
Maximum continuous operating voltage U_c	260 VAC
Temporary overvoltage test value U_T (200 ms)	1200 VAC
Rated frequency	50/60 Hz
Nominal discharge current (8/20) μs I_n	20 kA
Charge Q at I_n	0.57 As
Specific energy at I_n	5.7 kJ/Ω
Maximum discharge current I_{max}	40 kA
Follow current interrupt rating I_{fi}	100 A _{r.m.s}
Maximum back-up fuse	–
Maximum short-circuit current	–

Connection diagram

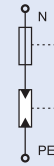

Mechanical

Frame size	45 mm
Device height	80 mm
Device width	17.5 mm
Weight	97 g
Permitted ambient temperature	-40°C to +70°C
Degree of protection (built-in)	IP40
Upper and lower lift terminal capacity	4 - 25 mm ²
Upper and lower open mouthed terminals for busbar thickness up to	1.5 mm
Tightening torque of terminal screws	2.4 - 3 Nm
Quick fastening on DIN rail according to	IEC/EN 60715
Accessories: busbars 16 mm ²	Type ZV-KSBI ...

Dimensions (mm)

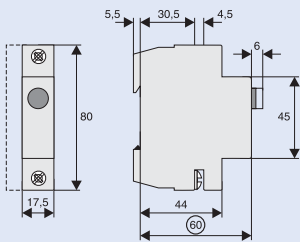

Application Examples SPC-E according to IEC 60364-5-53 Clause 534

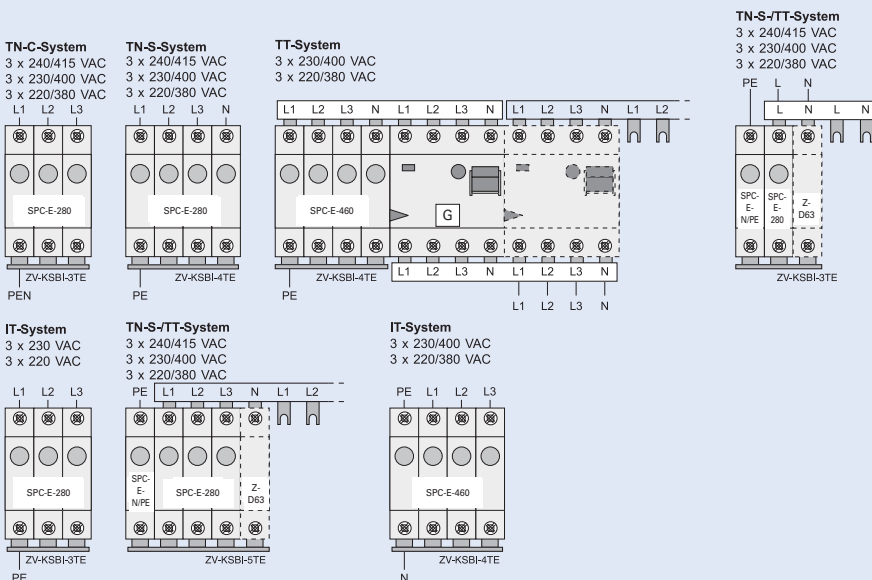

Surge Protection

SPD Class C, Plug-in Surge Arresters SPCT2

- Field of application:
For the protection of low voltage distribution systems against transient overvoltage caused by indirect lightning stroke and switching operations.
- Test class **II** according to IEC 61643-1+A1
- SPD-type **T2** according to EN 61643-11
- Auxiliary switch SPC-S-HK for remote message transmission can be mounted onto the device
- Suitable for busbar connection to all Xtra Combinations switchgear
- Busbars ZV-KSBI are available for all customary applications

Symbol



Technical Data

Inserts	SPCT2-075	SPCT2-130	SPCT2-175	SPCT2-280	SPCT2-335	SPCT2-385	SPCT2-460
---------	-----------	-----------	-----------	-----------	-----------	-----------	-----------

Electrical

Mechanical coding	x	x	x	x	x	x	x
Responding time (rate of voltage rise 5 kV/μs)	< 25 ns	< 25 ns	< 25 ns	< 25 ns	< 25 ns	< 25 ns	< 25 ns
Voltage protection level at nominal discharge current / U_{oc}	< 550 V	< 800 V	< 1.0 kV	< 1.4 kV	< 1.6 kV	< 1.8 kV	< 2.2 kV
Voltage protection level at 5 kA (8/20) μs	400 V	550 V	700 V	1000 V	1200 V	1350 V	1700 V
Maximum continuous operating voltage U_c	75 VAC	130 VAC	175 VAC	280 VAC	335 VAC	385 VAC	460 VAC
Temporary overvoltage test value U_T (5 s)	= U_c	= U_c	= U_c	350 VAC	415 VAC	415 VAC	580 VAC
Rated frequency	50/60 Hz	50/60 Hz	50/60 Hz	50/60 Hz	50/60 Hz	50/60 Hz	50/60 Hz
Open circuit voltage U_{oc}	–	–	–	10 kV	5 kV	–	–
Nominal discharge current (8/20) μs I_n	15 kA	20 kA	15 kA	20 kA	20 kA	20 kA	20 kA
Charge Q at I_n	0.43 As	0.57 As	0.57 As	0.57 As	0.57 As	0.57 As	0.57 As
Specific energy at I_n	3.2 kJ/Ω	5.7 kJ/Ω	5.7 kJ/Ω	5.7 kJ/Ω	5.7 kJ/Ω	5.7 kJ/Ω	5.7 kJ/Ω
Maximum discharge current I_{max}	30 kA	40 kA	40 kA	40 kA	40 kA	40 kA	40 kA
Follow current interrupt rating I_{fi}	–	–	–	–	–	–	–

Permissible back-up fuse

Maximum short-circuit current

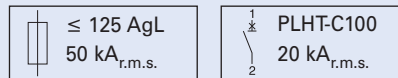

Connection diagram

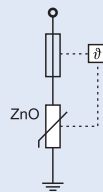

Mechanical

Frame size	45 mm
Device height	80 mm
Device width	
1-pole	17.5 mm (1MU)
1+1-pole	35 mm (2MU)
2-pole	35 mm (2MU)
3-pole	52.5 mm (3MU)
3+1-pole	70 mm (4MU)
4-pole	70 mm (4MU)
Mechanical coding	
1-pole	x
1+1-pole	yx
2-pole	xx
3-pole	xxx
3+1-pole	yxxx
4-pole	xxxx
Weight Base 1P, 1+1P, 2P, 3P, 3+1P, 4P	53/120/120/180/240/240 g
Weight Complete Devices 1P, 1+1P, 2P, 3P, 3+1P, 4P	110/201/220/330/412/440 g
Permitted ambient temperature	-40°C to +70°C
Degree of protection (built-in)	IP40
Upper and lower lift terminal capacity	4 - 25 mm ²
Upper and lower open mouthed terminals for busbar thickness up to	1.5 mm
Tightening torque of terminal screws	2.4 - 3 Nm
Quick fastening on DIN rail according to	IEC/EN 60715
Accessories: busbars 16 mm ²	Type ZV-KSBI ...

Surge Protection

Technical Data

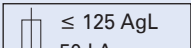
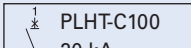
Inserts	SPCT2-580	SPCT2-NPE
Electrical		
Mechanical coding	x	y
Responding time (rate of voltage rise 5 kV/ μ s)	< 25 ns	< 100 ns
Voltage protection level at nominal discharge current / U_{oc}	< 2.6 kV	< 1.0 kV
Voltage protection level at 5 kA (8/20) μ s	2000 V	–
Maximum continuous operating voltage U_c	580 VAC	260 VAC
Temporary overvoltage test value U_T	= U_c (5 s)	1200 VAC (200 ms)
Rated frequency	50/60 Hz	50/60 Hz
Nominal discharge current (8/20) μ s I_n	20 kA	20 kA
Charge Q at I_n	0.57 As	0.57 As
Specific energy at I_n	5.7 kJ/ Ω	5.7 kJ/ Ω
Maximum discharge current I_{max}	40 kA	40 kA
Follow current interrupt rating I_{fi}	–	100 A _{r.m.s.}
Permissible back-up fuse	 ≤ 125 AgL 50 kA _{r.m.s.}	 PLHT-C100 20 kA _{r.m.s.}
Maximum short-circuit current	–	–

Connection diagram

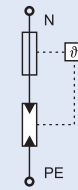
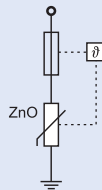

Mechanical

Frame size	45 mm
Device height	80 mm
Device width	
1-pole	17.5 mm (1MU)
1+1-pole	35 mm (2MU)
2-pole	35 mm (2MU)
3-pole	52.5 mm (3MU)
3+1-pole	70 mm (4MU)
4-pole	70 mm (4MU)
Mechanical coding	
1-pole	x
1+1-pole	yx
2-pole	xx
3-pole	xxx
3+1-pole	yxxx
4-pole	xxxx
Weight Base 1P, 1+1P, 2P, 3P, 3+1P, 4P	53/120/120/180/240/240 g
Weight Complete Devices 1P, 1+1P, 2P, 3P, 3+1P, 4P	110/201/220/330/412/440 g
Permitted ambient temperature	-40°C to +70°C
Degree of protection (built-in)	IP40
Upper and lower lift terminal capacity	4 - 25 mm ²
Upper and lower open mouthed terminals for busbar thickness up to	1.5 mm
Tightening torque of terminal screws	2.4 - 3 Nm
Quick fastening on DIN rail according to	IEC/EN 60715
Accessories: busbars 16 mm ²	Type ZV-KSBI ...

Dimensions (mm)

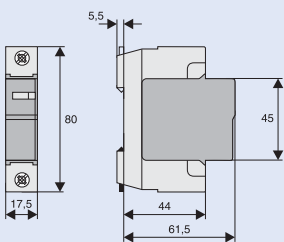

Surge Protection

SPD Class C, Plug-in Surge Arresters SPC-S

- Field of application:
For the protection of low voltage distribution systems against transient overvoltage caused by indirect lightning stroke and switching operations.
- Test class **II** according to IEC 61643-1+A1
- SPD-type **T2** according to EN 61643-11
- Auxiliary switch SPC-S-HK for remote message transmission can be mounted onto the device
- Suitable for busbar connection to all Xtra Combinations switchgear
- Busbars ZV-KSBI are available for all customary applications

Symbol



Technical Data

Inserts	SPC-S-15/75	-20/130	-20/175	-20/280	-20/335	-20/385	-20/460
Electrical							
Mechanical coding	x	x	x	x	x	x	x
Responding time (rate of voltage rise 5 kV/μs)	< 25 ns	< 25 ns	< 25 ns	< 25 ns	< 25 ns	< 25 ns	< 25 ns
Voltage protection level at nominal discharge current / U_{oc}	< 550 V	< 800 V	< 1.0 kV	< 1.4 kV	< 1.6 kV	< 1.8 kV	< 2.2 kV
Voltage protection level at 5 kA (8/20) μs	400 V	550 V	700 V	1000 V	1200 V	1350 V	1700 V
Maximum continuous operating voltage U_c	75 VAC	130 VAC	175 VAC	280 VAC	335 VAC	385 VAC	460 VAC
Temporary overvoltage test value U_T (5 s)	= U_c	= U_c	= U_c	350 VAC	415 VAC	415 VAC	580 VAC
Rated frequency	50/60 Hz	50/60 Hz	50/60 Hz	50/60 Hz	50/60 Hz	50/60 Hz	50/60 Hz
Open circuit voltage U_{oc}	–	–	–	10 kV	5 kV	–	–
Nominal discharge current (8/20) μs I_n	15 kA	20 kA	15 kA	20 kA	20 kA	20 kA	20 kA
Charge Q at I_n	0.43 As	0.57 As	0.57 As	0.57 As	0.57 As	0.57 As	0.57 As
Specific energy at I_n	3.2 kJ/Ω	5.7 kJ/Ω	5.7 kJ/Ω	5.7 kJ/Ω	5.7 kJ/Ω	5.7 kJ/Ω	5.7 kJ/Ω
Maximum discharge current I_{max}	30 kA	40 kA	40 kA	40 kA	40 kA	40 kA	40 kA
Follow current interrupt rating I_{fi}	–	–	–	–	–	–	–

Permissible back-up fuse
Maximum short-circuit current



Connection diagram

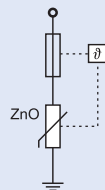

Mechanical

Frame size	45 mm
Device height	80 mm
Device width	
1-pole	17.5 mm (1MU)
1+1-pole	35 mm (2MU)
2-pole	35 mm (2MU)
3-pole	52.5 mm (3MU)
3+1-pole	70 mm (4MU)
4-pole	70 mm (4MU)
Mechanical coding	
1-pole	x
1+1-pole	yx
2-pole	xx
3-pole	xxx
3+1-pole	yxxx
4-pole	xxxx
Weight Base 1P, 1+1P, 2P, 3P, 3+1P, 4P	53/120/120/180/240/240 g
Weight Complete Devices 1P, 1+1P, 2P, 3P, 3+1P, 4P	110/201/220/330/412/440 g
Permitted ambient temperature	-40°C to +70°C
Degree of protection (built-in)	IP40
Upper and lower lift terminal capacity	4 - 25 mm ²
Upper and lower open mouthed terminals for busbar thickness up to	1.5 mm
Tightening torque of terminal screws	2.4 - 3 Nm
Quick fastening on DIN rail according to	IEC/EN 60715
Accessories: busbars 16 mm ²	Type ZV-KSBI ...

Surge Protection

Technical Data

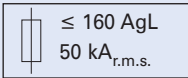
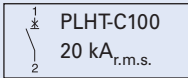
Inserts	SPC-S-20/580	-N/PE
Electrical		
Mechanical coding	x	y
Responding time (rate of voltage rise 5 kV/ μ s)	< 25 ns	< 100 ns
Voltage protection level at nominal discharge current / U_{oc}	< 2.6 kV	< 1.0 kV
Voltage protection level at 5 kA (8/20) μ s	2000 V	–
Maximum continuous operating voltage U_c	580 VAC	260 VAC
Temporary overvoltage test value U_T	= U_c (5 s)	1200 VAC (200 ms)
Rated frequency	50/60 Hz	50/60 Hz
Nominal discharge current (8/20) μ s I_n	20 kA	20 kA
Charge Q at I_n	0.57 As	0.57 As
Specific energy at I_n	5.7 kJ/ Ω	5.7 kJ/ Ω
Maximum discharge current I_{max}	40 kA	40 kA
Follow current interrupt rating I_{fi}	–	100 A _{r.m.s.}
Permissible back-up fuse	 ≤ 160 AgL 50 kA _{r.m.s.}	 PLHT-C100 20 kA _{r.m.s.}
Maximum short-circuit current	–	–

Connection diagram

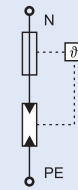
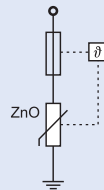

Mechanical

Frame size	45 mm
Device height	80 mm
Device width	
1-pole	17.5 mm (1MU)
1+1-pole	35 mm (2MU)
2-pole	35 mm (2MU)
3-pole	52.5 mm (3MU)
3+1-pole	70 mm (4MU)
4-pole	70 mm (4MU)
Mechanical coding	
1-pole	x
1+1-pole	yx
2-pole	xx
3-pole	xxx
3+1-pole	yxxx
4-pole	xxxx
Weight Base 1P, 1+1P, 2P, 3P, 3+1P, 4P	53/120/120/180/240/240 g
Weight Complete Devices 1P, 1+1P, 2P, 3P, 3+1P, 4P	110/201/220/330/412/440 g
Permitted ambient temperature	-40°C to +70°C
Degree of protection (built-in)	IP40
Upper and lower lift terminal capacity	4 - 25 mm ²
Upper and lower open mouthed terminals	
for busbar thickness up to	1.5 mm
Tightening torque of terminal screws	2.4 - 3 Nm
Quick fastening on DIN rail according to	IEC/EN 60715
Accessories: busbars 16 mm ²	Type ZV-KSBI ...

Dimensions (mm)

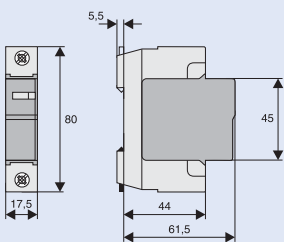



Surge Protection

SPD Class C, Surge Arresters SPCT2-1+NPE, SPCT2-3+NPE

- Field of application:
For the protection of low voltage distribution systems against transient overvoltage caused by indirect lightning stroke and switching operations.
- Test class **II** according to IEC 61643-1+A1
- SPD-type **T2** according to EN 61643-11
- Auxiliary switch SPC-S-HK for remote message transmission can be mounted onto the device
- Suitable for busbar connection to all Xtra Combinations switchgear
- Type **SPC-S-3+1**:
consists of 1 base SPC-S-S4-3+1,
1 insert SPC-S-N/PE and 3 inserts SPC-S-20/335
- Type **SPC-S-1+1**:
consists of 1 base SPC-S-S2-1+1,
1 insert SPC-S-N/PE and 1 insert SPC-S-20/335

Technical Data

		SPCT2-1+NPE	SPCT2-3+NPE
Electrical			
Mechanical coding		yx	yxxx
Responding time (rate of voltage rise 5 kV/μs)	L-N/N-PE/L-PE	< 25ns/< 100ns/< 100ns	< 25ns/< 100ns/< 100ns
Maximum continuous operating voltage U_c	L-N/N-PE	335VAC/260VAC	280VAC/260VAC
Temporary overvoltage test value U_T (5 s) (200 ms)	L-N	415 VAC	350 VAC
	N-PE	1200 VAC	1200 VAC
Rated frequency		50/60 Hz	50/60 Hz
Nominal discharge current I_n	L-N/N-PE/L-PE	20 kA (8/20)μs	20 kA (8/20)μs
Voltage protection level U_p at I_n	L-N/N-PE/L-PE	≤ 1600V/≤ 1000V/≤ 1650V	≤ 1000V/≤ 1000V/≤ 1300V
Maximum discharge current I_{max}	L-N/N-PE/L-PE	40 kA (8/20)μs	40 kA (8/20)μs
Follow current interrupt rating I_{fi}	N-PE	100 A _{r.m.s.}	100 A _{r.m.s.}
Permissible back-up fuse		 ≤ 125 AgL	 PLHT-C100
Maximum short-circuit current		50 kA _{r.m.s.}	20 kA _{r.m.s.}

Connection diagram

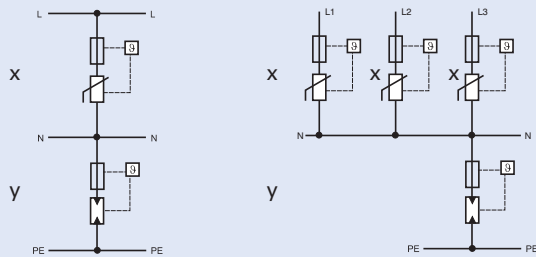

Mechanical

Mechanical coding of base	yx	yxxx
Frame size	45 mm	45 mm
Device height	80 mm	80 mm
Device width	35 mm	70 mm
Weight	201 g	412 g
Upper and lower lift terminal capacity	1 - 25 mm ²	1 - 25 mm ²
Open-mouthed terminals at both sides for busbar thickness up to	1.5 mm	1.5 mm
Tightening torque of terminal screws	2.4 - 3 Nm	2.4 - 3 Nm
Permitted ambient temperature	-40°C to +70°C	-40°C to +70°C
Mounting	quick fastening on DIN rail IEC/EN 60715	
Degree of protection (built-in)	IP40	IP40

Dimensions (mm)

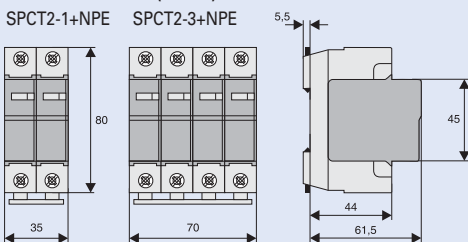

Application Examples

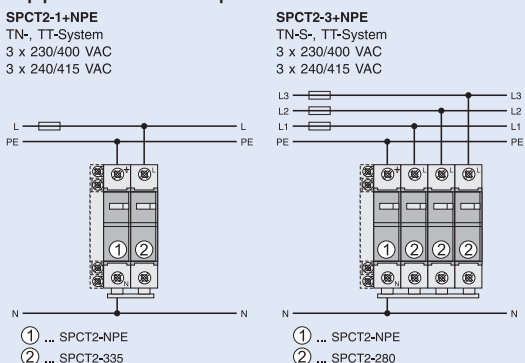

Surge Protection

Application Examples SPCT2 according to IEC 60364-5-53 Clause 534

TN-C-System

3 x 240/415 VAC
3 x 230/400 VAC
3 x 220/380 VAC

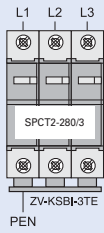

TN-S-System

3 x 240/415 VAC
3 x 230/400 VAC
3 x 220/380 VAC

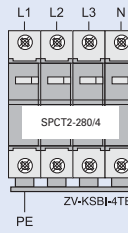

TT-System

3 x 230/400 VAC
3 x 220/380 VAC

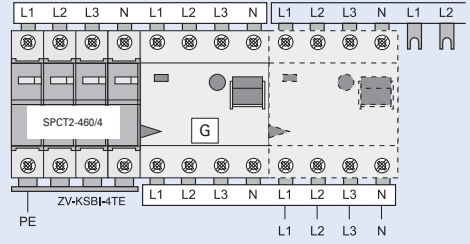

TN-S/TT-System

3 x 240/415 VAC
3 x 230/400 VAC
3 x 220/380 VAC

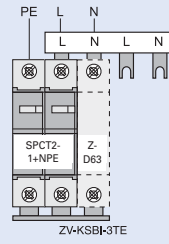

IT-System

3 x 230 VAC
3 x 220 VAC

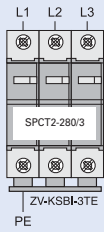

IT-System

3 x 230/400 VAC
3 x 220/380 VAC

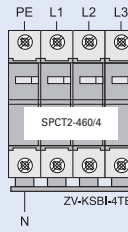

Surge Protection

Surge arrester Sets

SPD Class C, SPCT2

Surge Arrester Set SPCT2-335-3+NPE/BB

- The 3+1 circuit offers a universal solution for surge protection in low voltage distribution systems
- Suitable for TT- and TN-S systems according to IEC 60364-5-53 Clause 534
- Remote message transmission is possible by mounting auxiliary switch AS AUXSC-SPM
- Busbar connected, minimum installation work required

Content

SPCT2-335-3+NPE/BB

- 1 unit SPC-S-3+1 surge arrester
- 1 unit ASLTT-63 lead-through terminal
- busbar included

Surge Protection

Auxiliary Switch for (Lightning Current Arrester-)Surge Arrester AS AUXSC-SPM

- Field of application:
For mounting onto surge protective devices for external defect message transmission
- Design basically in accordance with IEC 60947-5-1
- Can be mounted subsequently
- Suitable for SPBT12-280/1, SPCT2

Connection diagram

AS AUXSC-SPM



Technical Data

Electrical

Rated insulation voltage	250 V
Rated frequency	50/60 Hz
Switching contact	1 NC + 1 NO
Minimum voltage per contact	24 VAC
Rated operational current AC12	2A/250VAC
Maximum back-up fuse	2 A gL
Overvoltage category	IV
Pollution degree	2

Mechanical

Frame size	45 mm
Device height	80 mm
Device width	8.8 mm
Weight	41 g
Mounting	screw-mounting
Degree of protection, built-in	IP40
Finger and hand touch safe acc. to	BGV A3, ÖVE-EN 6
Upper and lower terminals	lift terminals
Terminal capacity	2 x 2.5 mm ²
Tightening torque of terminal screws	0.8 - 1 Nm

Dimensions (mm)

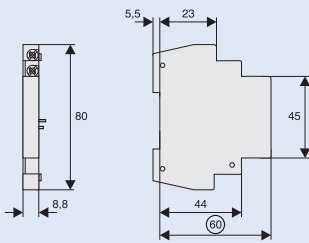

Application Examples

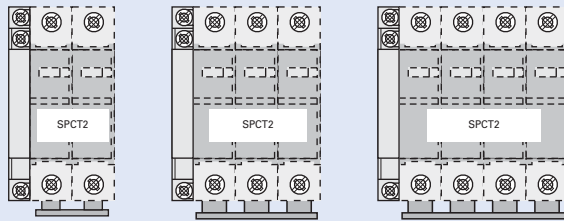

Surge Protection

Lead-Through Terminal for Surge Protective Devices, Class B, SPB-D-125

- The lead-through terminal permits orderly wiring of SPDs of class B. It serves as lead-through terminal in circuits requiring vertical connections from the upper to the lower SPD connection level.

Connection diagram



Technical Data

Electrical

Design basically in accordance with	IEC 61643-1: 1998-02, DIN VDE 0675 Part 6: 1989-11, IEC 61024-1: 1990-03, IEC 60947-7-1: 1989-10, DIN VDE 0110-1: 1997-04
Rated voltage U_C	500 V AC/DC
Rated current I_N	125 A / 30°C
Impulse current (10/350) μ s	
Peak current	100 kA
Charge Q	50 As
Specific energy	2,5 MJ/ Ω
Overvoltage category	III

Mechanical

Frame size	45 mm
Device height	90 mm
Device width	17.5 mm
Mounting	quick fastening on DIN rail IEC/EN 60715
Degree of protection, built-in	IP40
Upper and lower terminals	lift and open-mouthed terminals
Terminal capacity	
rigid	0.5 - 35 mm ²
flexible	0.5 - 25 mm ²
Tightening torque of terminal screws	4-4.5 Nm
Permitted relative air humidity	< 95%
Pollution degree	2
Resistance to climatic conditions	F / DIN 40040
Creepage a. clearance distances acc. to	IEC 60664-1, DIN VDE 0110-1:1997-04
Temperature range	-40 to +85°C

Dimensions (mm)

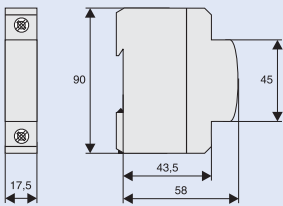

Connection type 2 according to IEC 60364-5-53 Clause 534

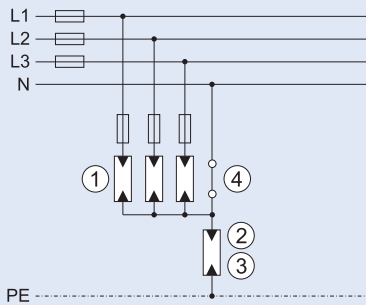

TT-System, TN-S-System, IT-System with Neutral

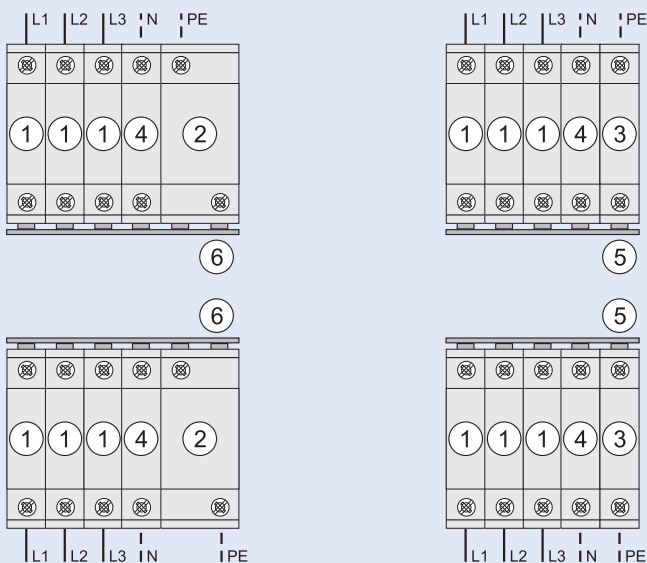

Lightning current arrester

- ① ... SPI-35/440
- ② ... SPI-100/NPE
- ③ ... SPI-50/NPE

Lead-through terminal

- ④ ... SPB-D-125

Busbar

- ⑤ ... Z-GV-U/5
- ⑥ ... Z-GV-U/6

Surge Protection

Lead-Through Terminal for Surge Protective Devices, ASLTT-63

- The lead-through terminal permits orderly wiring of SPDs. It serves as lead-through terminal in circuits requiring vertical connections from the upper to the lower SPD connection level.
- 1-pole
- Suitable for standard busbar connection to all Xtra Combination switchgear

Connection diagram



Technical Data

Electrical

Rated voltage	500V AC/DC
Rated current	63 A
Rated frequency	50/60 Hz

Mechanical

Frame size	45 mm
Device height	80 mm
Device width	17.5 mm
Mounting	quick fastening on DIN rail IEC/EN 60715
Degree of protection, built-in	IP40
Finger and hand touch safe acc. to	BGV A3, ÖVE-EN 6
Upper and lower terminals	lift and open-mouthed terminals
Terminal capacity	1 - 25 mm ²
Busbar thickness	0.8 - 2 mm
Tightening torque of terminal screws	2.4 - 3 Nm

Dimensions (mm)

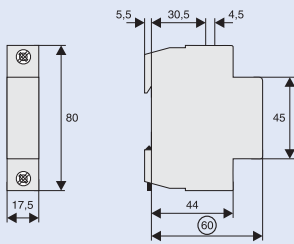

Application Example / Connection type 2 acc. to IEC 60364-5-53 Clause 534

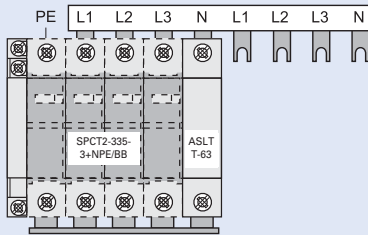

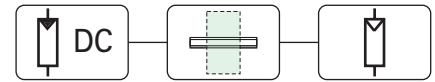

SPD-type T2 (Class C), Plug-in Surge Arresters SPPT2PA-...-2PE

- Field of application:
For the protection of photovoltaic systems against transient overvoltage caused by indirect lightning stroke and switching operations.
- Test class **II** according to IEC 61643-1
- SPD-type **T2** according to EN 61643-11
- Types SPPT2PA-...-AX for remote message transmission of defective inserts

Connection diagrams

SPPT2PA-...-2PE

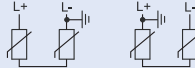

Technical Data

	SPPT2PA-600-2PE	SPPT2PA-1000-2PE(-AX)
Electrical		
Responding time	≤ 25 ns	≤ 25 ns
Maximum continuous operating voltage U_C	600 V DC	1000 V DC
Rated frequency	DC	DC
Nominal discharge current I_n	15 kA (8/20) μ s	15 kA (8/20) μ s
Voltage protection level U_p	≤ 3 kV	≤ 5 kV
Residual voltage at 5 kA (8/20) μ s	≤ 2.5 kV	≤ 4 kV
Maximum discharge current I_{max}	30 kA (8/20) μ s	30 kA (8/20) μ s
Permissible back-up fuse	-	-
Maximum short-circuit current I_{sc}	80 A	80 A
Residual current I_{PE}	≤ 20 μ A	≤ 20 μ A
Mechanical		
Frame size	45 mm	45 mm
Device height	90 mm	90 mm (99 mm)
Device width	35.6 mm	35.6 mm
Weight	247 g	247 g (249 g)
Upper and lower lift terminal capacity fine- / solid strand	4-25/4-35 mm ² /AWG11-2	4-25/4-35 mm ² /AWG11-2
Tightening torque of terminal screws	4.5 Nm	4.5 Nm
Permitted ambient temperature	-40°C up to +80°C	-40°C up to +80°C
Mounting	quick fastening on DIN rail IEC/EN 60715	
Degree of protection	IP20	IP20
Polution degree	2	2

Auxiliary switch

Electrical	
Rated insulation voltage	250 V
Rated frequency	50/60 Hz
Switching contact	1 CO
Minimum voltage per contact	5 V AC/DC
Rated operational current	1.5 A / 250 V AC 1.5 A / 30 V DC
Min. admissible power	5 mA / 5 V

Mechanical	
Terminal capacity fine- / solid strand	1.5/1.5 mm ² /AWG28-16
Tightening torque of terminal screws	0.25 Nm

Dimensions (mm)

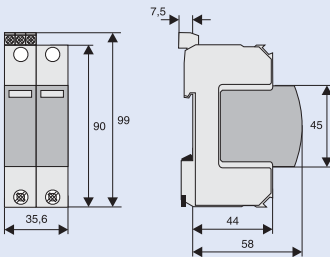

Application hints according to EN 50539-12

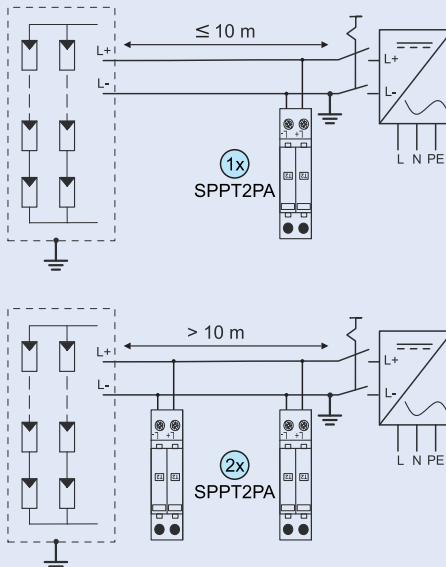

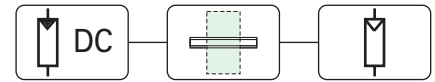

SPD-type T2 (Class C), Plug-in Surge Arresters SPPT2PA-...-2+1PE

- Field of application:
For the protection of photovoltaic systems against transient overvoltage caused by indirect lightning stroke and switching operations.
- Test class **II** according to IEC 61643-1
- SPD-type **T2** according to EN 61643-11
- Galvanic separation in unearthed systems by means of a spark gap
- Types SPPT2PA-...-AX for remote message transmission of defective inserts

Connection diagrams

SPPT2PA-...-2+1PE

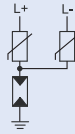

Technical Data

		SPPT2PA-600-2+1PE	SPPT2PA-1000-2+1PE(-AX)
Electrical			
Responding time	L+ -> L- / L- -> PE	≤ 25 ns / ≤ 100 ns	≤ 25 ns / ≤ 100 ns
Maximum continuous operating voltage U_C		600 V DC	1000 V DC
Rated frequency		DC	DC
Nominal discharge current I_n		15 kA (8/20) μ s	15 kA (8/20) μ s
Voltage protection level U_p	L+ -> L- / L- -> PE	≤ 3 kV / ≤ 3 kV	≤ 5 kV / ≤ 3 kV
Residual voltage at 5 kA (8/20) μ s	L+ -> L- / L- -> PE	≤ 2.5 kV / ≤ 2 kV	≤ 4 kV / ≤ 2 kV
Maximum discharge current I_{max}		30 kA (8/20) μ s	30 kA (8/20) μ s
Permissible back-up fuse		-	-
Maximum short-circuit current I_{sc}		80 A	80 A
Residual current I_{PE}		≤ 20 μ A	≤ 20 μ A
Mechanical			
Frame size		45 mm	45 mm
Device height		90 mm	90 mm (99 mm)
Device width		53.4 mm	53.4 mm
Weight		318 g	318 g (323 g)
Upper and lower lift terminal capacity fine- / solid strand		4-25/4-35 mm ² /AWG11-2	4-25/4-35 mm ² /AWG11-2
Tightening torque of terminal screws		4.5 Nm	4.5 Nm
Permitted ambient temperature		-40°C up to +80°C	-40°C up to +80°C
Mounting		quick fastening on DIN rail IEC/EN 60715	
Degree of protection		IP20	IP20
Polution degree		2	2

Auxiliary switch

Electrical		Mechanical	
Rated insulation voltage	250 V	Terminal capacity fine- / solid strand	1.5/1.5 mm ² /AWG28-16
Rated frequency	50/60 Hz	Tightening torque of terminal screws	0.25 Nm
Switching contact	1 CO		
Minimum voltage per contact	5 V AC/DC		
Rated operational current	1.5 A / 250 V AC		
	1.5 A / 30 V DC		
Min. admissible power	5 mA / 5 V		

Dimensions (mm)

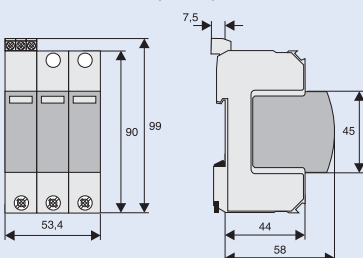

Application hints according to EN 50539-12

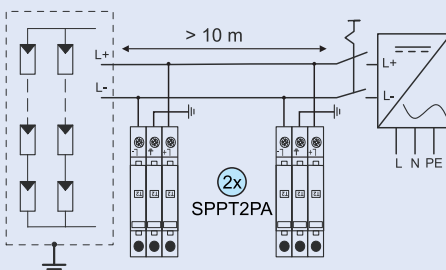
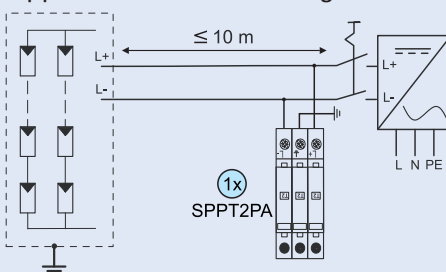

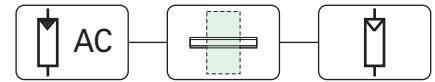

Auxiliary Switch for Surge Arresters ASAXSC-SPM

- Field of application:
For mounting onto surge protective devices for external defect message transmission
- Design basically in accordance with IEC 60947-5-1
- Can be mounted subsequently
- Suitable for SPMT2PA

Connection diagram

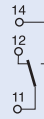

Technical Data

Electrical

Rated insulation voltage	250 V
Rated frequency	50/60 Hz
Switching contact	1 CO
Minimum voltage per contact	24 VAC
Rated operational current AC12	2A/250VAC
Maximum back-up fuse	2 A gL
Overvoltage category	IV
Pollution degree	2

Mechanical

Frame size	45 mm
Device height	80 mm
Device width	8.8 mm
Weight	41 g
Mounting	screw-mounting
Degree of protection, built-in	IP40
Finger and hand touch safe acc. to	BGV A3, ÖVE-EN 6
Upper and lower terminals	lift terminals
Terminal capacity	2 x 2.5 mm ²
Tightening torque of terminal screws	0.8 - 1 Nm

Dimensions (mm)

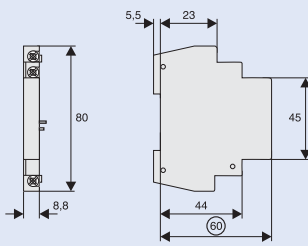

Application Examples

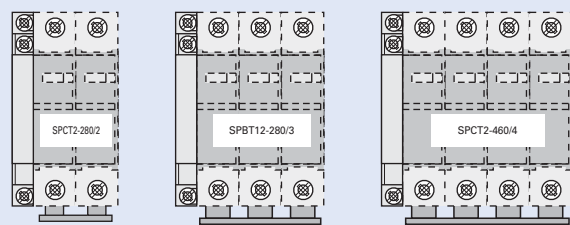

Lead-Through Terminal for Surge Protective Devices, SPD-type 2 (Class C), ASLTT-63

- The lead-through terminal permits orderly wiring of SPDs types 2 (class C). It serves as lead-through terminal in circuits requiring vertical connections from the upper to the lower SPD connection level.
- 1-pole
- Suitable for standard busbar connection to EATON switchgear

Connection diagram

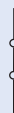

Technical Data

Electrical

Rated voltage	690V AC/DC
Rated current	63 A
Rated frequency	50/60 Hz

Mechanical

Frame size	45 mm
Device height	80 mm
Device width	17.5 mm
Mounting	quick fastening on DIN rail IEC/EN 60715
Degree of protection, built-in	IP40
Finger and hand touch safe acc. to	BGV A3, ÖVE-EN 6
Upper and lower terminals	lift and open-mouthed terminals
Terminal capacity	1 - 25 mm ²
Busbar thickness	0.8 - 2 mm
Tightening torque of terminal screws	2.4 - 3 Nm

Dimensions (mm)

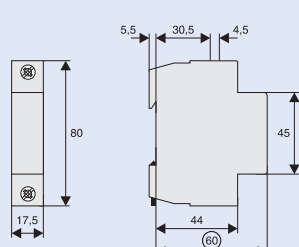

Application Example / Connection type 2 acc. to IEC 60364-5-53 Clause 534

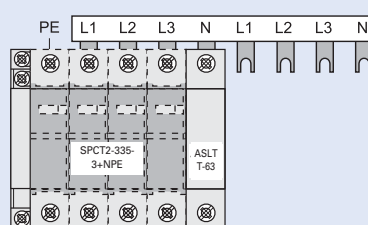

Surge Protection

Busbars Z-GV-U/

- Busbars Z-GV-U/ permit to implement customary SPD combinations
- Suitable for SPI-..., SPB-D-125
- The rated cross-section of Z-GV-U/ is 16 mm²
- The busbars must be cut to length in some cases

Technical Data

Electrical

Rated voltage	230/400 V, 50/60 Hz
Rated current	63 A

Mechanical

Busbar cross section	16 mm ² Cu
----------------------	-----------------------

Models



Z-GV-U/2



Z-GV-U/3



Z-GV-U/4



Z-GV-U/5



Z-GV-U/6



Z-GV-U/8



Z-GV-U/9

Busbars ZV-KSBI

- Busbars ZV-KSBI permit to implement customary SPD combinations
- Suitable for SPB-..., SPC-..., Z-D63
- The rated cross-section of ZV-KSBI is 16 mm²
- The busbars must be cut to length in some cases

Technical Data

Electrical

Rated voltage	230/400 V, 50/60 Hz
Rated current	63 A

Mechanical

Busbar cross section	16 mm ² Cu
----------------------	-----------------------

Models

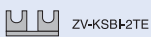

ZV-KSBI-2TE



ZV-KSBI-3TE



ZV-KSBI-3TE/S



ZV-KSBI-3TE+HI



ZV-KSBI-4TE



ZV-KSBI-5TE



ZV-KSBI-5TE/N



ZV-KSBI-5TE+HI



ZV-KSBI-6TE



ZV-KSBI-7TE



ZV-KSBI-7TE/S



ZV-KSBI-7TE/N



ZV-KSBI-9TE/N



ZV-KSBI-11TE

Marking Label SPI-BZS-L/N/PE

- Can be affixed to SPI-..., SPB-D-125
- Size 7 x 17mm
- Colour: white

Surge Protection

SPD Class D, Surge Protective Device SPD-S-1+1, SPD-S-280/2

- Field of application:
For fine protection of user equipment against transient overvoltage
- For mounting on DIN rails in distribution boxes for electrical installation
- No decoupling from upstream surge protection in the low voltage distribution system required
- Test class III according to IEC 61643-1+A1
- SPD-type 13 according to EN 61643-11
- Suitable for high back-up fuse 63 A gL / C 63
- Auxiliary switch SPC-S-HK for remote message transmission can be mounted onto the device

Technical Data

	SPD-S-1+1		SPD-S-280/2	
Electrical				
Mechanical coding		yx		xx
Responding time (rate of voltage rise 5 kV/μs)	L-N/N-PE/L-PE	< 25ns/< 100ns/< 100ns	L1-L2(N)/L2(N)-PE/L1-PE	< 25ns
Maximum continuous operating voltage U_c	L-N/N-PE	335VAC/260VAC	L1-L2(N)/L2(N)-PE	280VAC
Temporary overvoltage test value U_T (5 s)	L-N/L-PE	350VAC/416VAC	L-N/L-PE	350VAC/416VAC
	N-PE	1200VAC	N-PE	1200VAC
Rated frequency		50/60 Hz		50/60 Hz
Open circuit voltage U_{OC}	L-N/N-PE/L-PE	5kV	L1-L2(N)/L2(N)-PE/L1-PE	10kV
Voltage protection level U_p at U_{OC}	L-N/N-PE/L-PE	$\leq 1000V/\leq 900V/\leq 1000V$	L1-L2(N)/L2(N)-PE	$\leq 950V$
Nominal discharge current I_n	L-N/N-PE/L-PE	2,5kA (8/20)μs	L1-L2(N)/L2(N)-PE	5kA (8/20)μs
Voltage protection level U_p at I_n	L-N/N-PE/L-PE	$\leq 1000V/\leq 700V/\leq 1000V$	L1-L2(N)/L2(N)-PE	$\leq 950V$
Maximum discharge current I_{max}	L-N/N-PE/L-PE	10kA (8/20)μs	L1-L2(N)/L2(N)-PE/L1-PE	10kA (8/20)μs
Follow current interrupt rating I_{fi}	N-PE	100 A _{r.m.s.}		-

Permissible back-up fuse
Maximum short-circuit current



Connection diagram

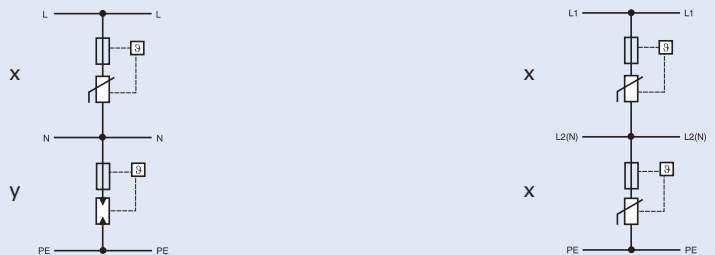

Mechanical

Mechanical coding of base	yx	xx
Frame size	45 mm	45 mm
Device height	80 mm	80 mm
Device width	35 mm	35 mm
Weight	220 g	220 g
Upper and lower lift terminal capacity	1 - 25 mm ²	1 - 25 mm ²
Open-mouthed terminals at both sides for busbar thickness up to	1.5 mm	1.5 mm
Tightening torque of terminal screws	2.4 - 3 Nm	2.4 - 3 Nm
Permitted ambient temperature	-40°C to +70°C	-40°C to +70°C
Mounting	quick fastening on DIN rail IEC/EN 60715	
Degree of protection (built-in)	IP40	IP40

Dimensions (mm)

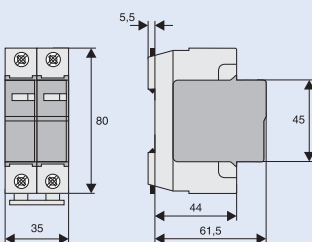

Application Examples

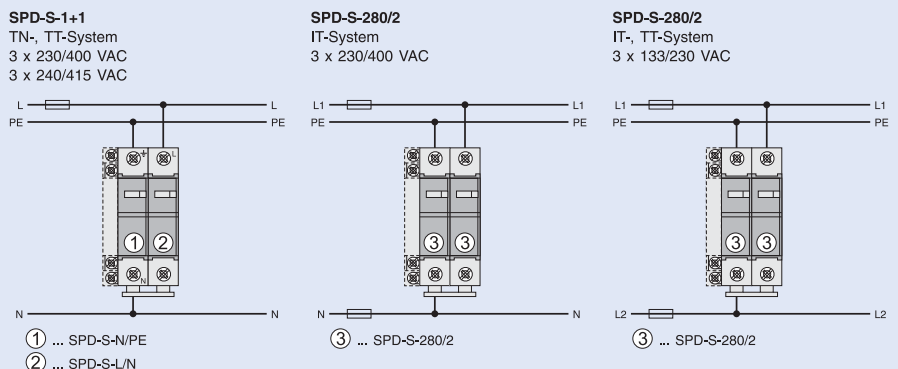

Surge Protection

19" Outlet Strips NWS-STL/19/7F

- Installation onto 19" rails
- Installation height: 1U
- Diagonally arranged socket outlets with earthing contact according to DIN 49440 or NF-C61314 (UTE), 16A / 250VAC
- Connection cable of 2.5 m H05VV-F 3G1,5 mm² with an angled connector
- Max. power consumption: 3680 W
- Degree of protection: IP20
- Temperature range: -5°C to +40°C
- Dimensions: 482,6x44x44,45mm (WxDxH)
- Material: Enclosure made of aluminium, front cover made of plastic similar to RAL 7035
- Weight: approx. 0.9 kg
- Scope of delivery: 1 Outlet strip incl. 19" fixing bracket, different fixing material

19" Outlet Strips with Surge Protection SPD-STL/19/7F-S/BL

- Can be mounted on 19" rails
- Installation height: 1U
- Diagonally arranged socket outlets with earthing contact according to DIN 49440 or NF-C61314 (UTE), 16A / 250VAC
- Connection cable of 2.5 m H05VV-F 3G1,5 mm² with an angled connector
- On/Off switch, 2-pole, lit
- Max. power consumption: 3680 W
- Degree of protection: IP20
- Temperature range: -5°C up to +40°C
- Surge protection tested according to IEC 61643-1 (Class: SPDType 3)
- Response time: < 25 ns
- Dimensions: 482,6x44x44,45mm (WxDxH)
- Material: Enclosure made of aluminium, front cover made of plastic similar to RAL 7035
- Weight: approx. 0.9 kg
- Scope of delivery: 1 Outlet strip incl. 19" fixing bracket, different fixing material

Surge Protection Outlet Strips with High-Grade Filter and Energy Absorption for full Equipment Protection SPD-STL/6F-S

- Suitable for wall-mounting in indoor areas
- A 19" fixing bracket is available as an option for mounting the strip in a cabinet
- Diagonally arranged socket outlets with earthing contact according to DIN 49440, 10A / 250VAC
- Connection cable of 1.0 m H05VV-F 3G1,0 mm² with an angled connector
- On/Off switch with MCB that can be reset
- Max. power consumption: 2500 W
- Degree of protection: IP20
- Temperature range: -15°C to +70°C
- Surge protection tested according to IEC 61643-1 (Class: SPDType 3)
- Response time: < 1 ns
- Dimensions: 390x42x52mm (WxDxH)
- Material: Enclosure made of plastic similar to RAL 7021
- Weight: approx. 0.4 kg
- Scope of delivery: 1 Multiple outlet strip

19" Fixing Bracket for SPD-STL/6F-S

- Fixing bracket for mounting surge protection outlet strips SPD-STL/6F-S on a 19" frame
- Mounting on 19" rails
- Installation height: 1U
- Material: Steel sheet, powder-coated RAL 7035
- Weight: approx. 0.4 kg
- Scope of delivery: 1 Fixing bracket, different fixing material

Surge Protection

Earthing/Equipotential Bonding

Equipotential Bonding Bar PAS-7x16

Dimensions (mm)

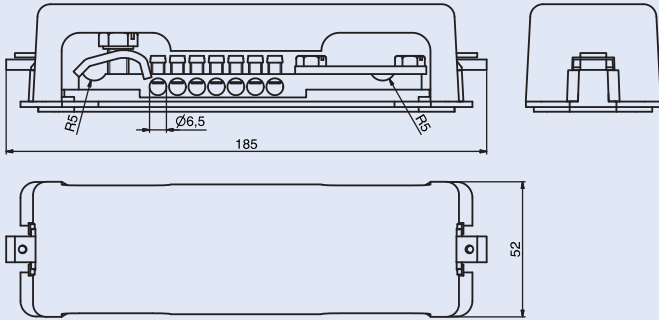

Earthing Bar for Antenna Lines PAS-HF-6

Dimensions (mm)

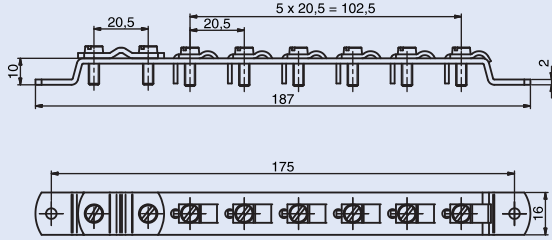

Earth Clip EBS

Dimensions (mm)

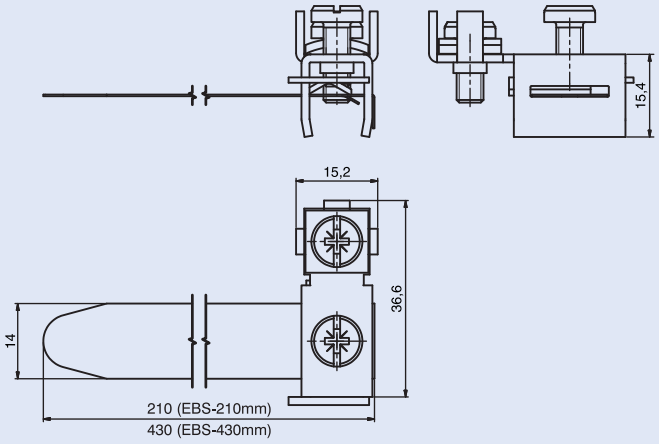

X-ON Electronics

Largest Supplier of Electrical and Electronic Components

Click to view similar products for [Gas Discharge Tubes - GDTs / Gas Plasma Arrestors](#) category:

Click to view products by [Eaton](#) manufacturer:

Other Similar products are found below :

[PMT1023004](#) [PMT1025001](#) [RF3161-000](#) [PMT1035004](#) [PMT1040004](#) [PMT809006](#) [CG2250](#) [CG2800](#) [CG31.5L](#) [GT-SMD181240012-TR](#)
[WPGT-2N145B6L](#) [WPGT-2N230B6L](#) [WPGT-2N470B6L](#) [WPGT-2R470B6L](#) [WPGT-2RM230A6L](#) [WPGT-2RM350A6L](#) [WPGT-](#)
[2RM70A6L](#) [WPGT-2RM90A6L](#) [WPGT-2S145](#) [WPGT-2S350](#) [WPGT-2S470](#) [WPGT-3R350CF](#) [WPGT-3R350G1](#) [WPGT-3R90G1](#) [WPGT-](#)
[3R75G1](#) [WPGT-3R470G1](#) [WPGT-3R250C](#) [WPGT-3R230G1](#) [WPGT-2S230](#) [WPGT-2RM470A6L](#) [WPGT-2RM145A6L](#) [WPGT-2R3000B8L](#)
[WPGT-2R2700B8L](#) [WPGT-2R1000B8L](#) [WPGT-2N90B6L](#) [WPGT-2N70B6L](#) [WPGT-2N350B6L](#) [WPGT-2N230B6L1](#) [CG90](#) [CG2230](#)
[CG2145](#) [CG21000](#) [GT-SMD181215012-TR](#) [B88069X6940B152](#) [V20-1+NPE-280](#) [V20-3+NPE+FS-280](#) [SD09-V24 9](#) [C50-0-255](#)
[SG24PA300](#) [A9L40500](#)