

# 1AXXXX

## PCB Fuse-clips for ATC/ATM Blade, 5 mm, 1/4" & 13/32" diameter fuses

### For 1/4" Diameter Fuses

#### End Stops

1A1119 Family  
Angled-In leads

Dimensions - in (mm)

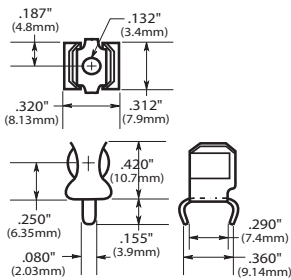

Catalog Number <sup>1,3</sup>	Clip Material <sup>2</sup>	Finish
1A1119-04-R	High Performance Cu	Bright Tin
1A1119-05	High Performance Cu	Silver
1A1119-10-R	Cartridge Brass	Bright Tin

RoHS

#### Without Endstops

1A1120 Family  
Angled-In Leads

Dimensions - in (mm)

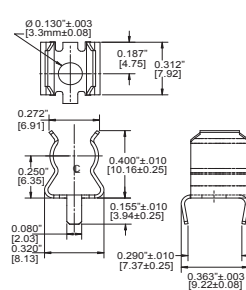

Catalog Number <sup>1,3</sup>	Clip Material <sup>2</sup>	Finish
1A1120-05	High Performance Cu	Silver
1A1120-06-R	High Performance Cu	Bright Tin
1A1120-09-R	Cartridge Brass	Bright Tin

RoHS

#### 1A1907 Family

##### Straight Leads

Dimensions - in (mm)

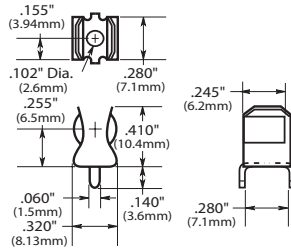

Catalog Number <sup>1,3</sup>	Clip Material <sup>2</sup>	Finish
1A1907-02-R	Cartridge Brass	Bright Dipped
1A1907-03-R	High Performance Cu	Bright Tin
1A1907-05	High Performance Cu	Silver
1A1907-06-R	Cartridge Brass	Bright Tin

UL recognized file number: E14853



RoHS

#### 1A3398 Family

##### Straight Leads

Dimensions - in (mm)

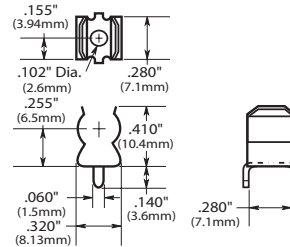

Catalog Number <sup>1,3</sup>	Clip Material <sup>2</sup>	Finish
1A3398-07-R	Cartridge Brass	Bright Tin

RoHS

#### 1A4534 Family

##### Angled Out Leads

Dimensions - in (mm)

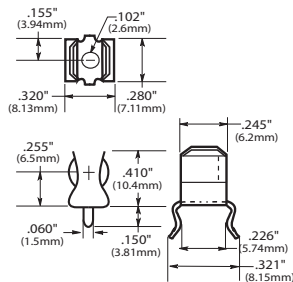

Catalog Number <sup>1,3</sup>	Clip Material <sup>2</sup>	Finish
1A4534-01-R	High Performance Cu	Bright Tin
1A4534-06-R	Cartridge Brass	Bright Tin

RoHS

#### 1A4533 Family

##### Angled Out Leads

Dimensions - in (mm)

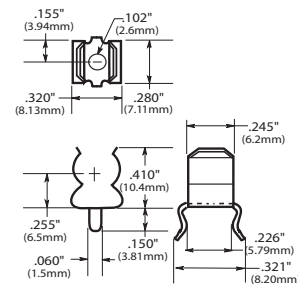

Catalog Number <sup>1,3</sup>	Clip Material <sup>2</sup>	Finish
1A4533-01-R	High Performance Cu	Bright Tin
1A4533-06-R	Cartridge Brass	Bright Tin

RoHS

Notes:

1. All part numbers shown are RoHS compliant
2. High performance Cu recommended for nominal current above 15 A
3. Add -BK prefix to part number for bulk packaging



Powering Business Worldwide

**For 5mm Diameter Fuses**

1A5601 Family

Dimensions - in (mm)

Catalog Number <sup>1,3</sup>	Clip Material <sup>2</sup>	Finish	Nominal current maximum
1A5601	Cartridge Brass	Bright Tin	7 A
1A5601-01	Spring Brass	Bright Tin	10 A



1A3399 and 1A5018 Family  
With Straight Leads

Dimensions - in (mm)

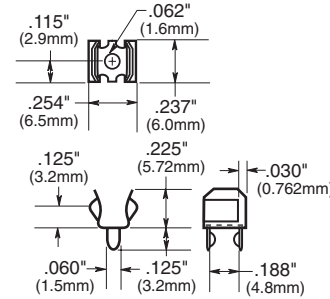

Catalog Number <sup>1,2</sup>	Clip Material	Finish
1A3399-10-R	Spring Bronze	Bright Tin
1A3399-01	Beryllium Cu	Silver
1A3399-04-R	Beryllium Cu	Bright Tin

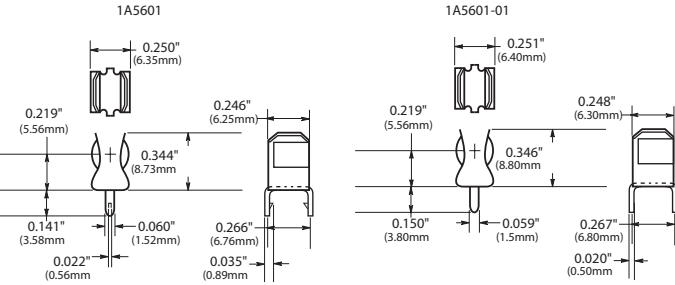

1A5602 Family (<= 7 A nominal current)

Dimensions - in (mm)

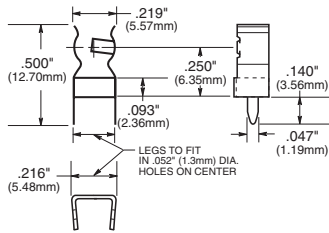

Catalog Number <sup>1,3</sup>	Clip Material <sup>2</sup>	Finish
1A5602	Cartridge Brass	Bright Tin

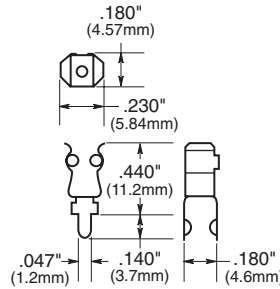

High Profile

Catalog Number <sup>1,2</sup>	Clip Material	Finish
1A5018-10-R	Spring Bronze	Bright Tin
1A5018-07	Spring Bronze	Silver

Notes:

1. All part numbers shown are RoHS compliant
2. Add -BK prefix to part number for bulk

**For 13/32" Diameter Fuses**

1A3400 Family

With End Stops & Straight Leads

Dimensions - in (mm)

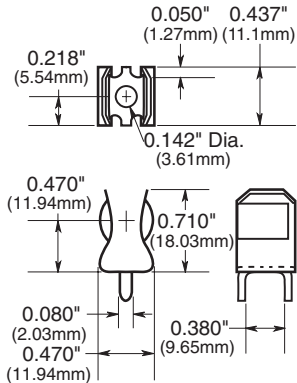

1A3400-09 & 1A3400-10

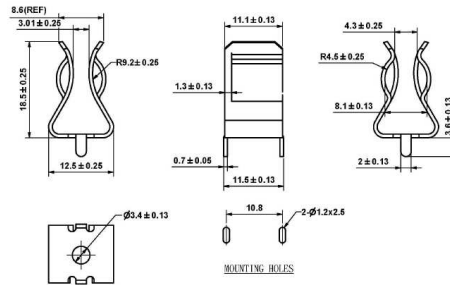

1A3400-12

Specifications:

Catalog Number <sup>1,2</sup>	Clip Material	Finish	Recommended maximum nominal rating
1A3400-09-R	Cu Clad Steel	Bright Tin	20 A
1A3400-10	Cu Clad Steel	Silver	30 A
1A3400-12-R	Cartridge Brass	Bright Tin	15 A

UL recognized file number: E14853

Notes:

1. All part numbers shown are RoHS compliant
2. Add -BK prefix to part number for bulk packaging

PCB Fuse-clips for ATC/ATM Blade, 5 mm, 1/4" & 13/32" diameter fuses



ATM Fuses 1A5778 Family  
Dimensions - mm (in)



MATERIAL: BRASS, NICKEL PLATED, .30/.012 THICK

1A5779 Family



SPECIFICATIONS

FUSECLIPS	BRASS, NICKEL PLATED
BASE MATERIAL	GLASS FILLED NYLON, UL RATED 94V-0
CURRENT RATING	15 AMPS
VOLTAGE RATING	500V AC
TEMPERATURE RATING	-50°C TO 145°C -58°F TO 292°F

ATC Fuses (0 to 20 Amps)  
1A5600 Family  
Dimensions - in (mm)

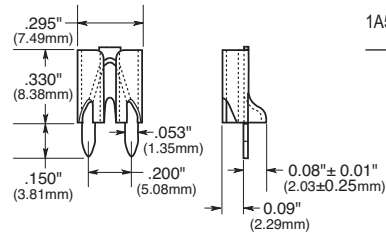

Catalog Number	Clip Material	Finish
1A5600	Cartridge Brass	Matte Tin

1A5780 Family  
Dimensions - mm (in)

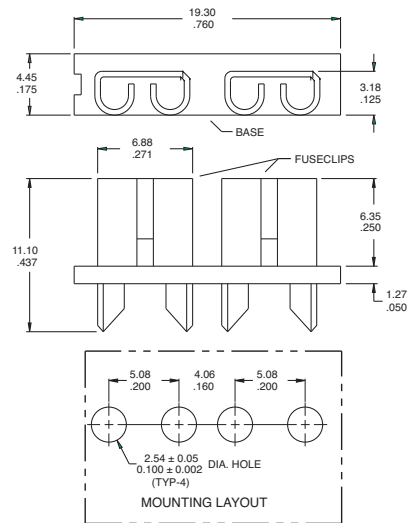

SPECIFICATIONS

FUSECLIPS	BRASS, NICKEL PLATED
BASE MATERIAL	GLASS FILLED NYLON, UL RATED 94V-0
CURRENT RATING	15 AMPS
VOLTAGE RATING	500V AC
TEMPERATURE RATING	-50°C TO 145°C -58°F TO 292°F

PCB Fuse-clips for ATC/ATM Blade, 5 mm, 1/4" & 13/32" diameter fuses

Fuseclip Catalog Numbers

Recommended Pad Layout Dimensions - in (mm)

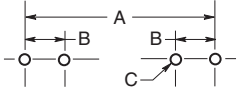

Dimensions

Catalog Number	A						ATC	ATM	B Tabs	C (4 holes)	Board Thickness
	7/8"	1"	1 1/4"	1 3/8"	1 1/2"	20mm					
1A5778-	—	—	—	—	—	—	—	0.464" (11.79)	0.144" (3.66)	0.065±0.002" (1.65±0.05)	0.062" (1.57)
1A5779-	—	—	—	—	—	—	—	0.464" (11.79)	0.144" (3.66)	0.065±0.002" (1.65±0.05)	0.062" (1.57)
1A5780-	—	—	—	—	—	—	0.560 (14.22)	—	0.200" (5.08)	0.100±0.002" (2.54±0.05)	0.062" (1.57)
1A3398-	1.00"	1.125"	1.375"	—	—	—	—	0.295"-0.305"	0.067"-0.070"	0.093"	0.093"
1A1907-	(25.40)	(28.58)	(34.920)	—	—	—	—	(7.49-7.75)	(1.70-1.78)	(2.36)	(2.36)
1A1119-	1.00"	1.125"	1.375"	—	—	—	—	0.295"-0.305"	0.093"±0.002"	0.062" to 0.125"	(1.57to3.18)
	(25.40)	(28.58)	(34.92)	—	—	—	—	(7.49-7.75)	(2.36±0.05)		
1A1120-	1.00"	1.125"	1.375"	—	—	—	—	0.295"-0.305"	0.093"±0.002"	0.062" to 0.125"	(1.57 to 3.18)
	(25.40)	(28.58)	(34.920)	—	—	—	—	(7.49-7.75)	(2.36±0.05)		
1A3399-	—	—	—	—	—	0.875" (22.23)	—	—	0.200" (5.08)	0.067"-0.070" (1.70-1.78)	0.093" (2.36)
1A3400-	—	—	—	1.50" (38.10)	1.625" (41.28)	—	—	—	0.405" (10.29)	0.091"-0.095" (2.31-2.41)	0.125" (3.18)
1A4533-	1.00"	1.125"	1.375"	—	—	—	—	—	0.300" (7.62)	0.067"-0.070" (1.70-1.78)	0.062" (1.57)
	(25.40)	(28.58)	(34.920)	—	—	—	—	—	(7.62)	(1.70-1.78)	(1.57)
1A4534-	1.00"	1.125"	1.375"	—	—	—	—	—	0.300" (7.62)	0.067"-0.070" (1.70-1.78)	0.062" (1.57)
	(25.40)	(28.58)	(34.920)	—	—	—	—	—	(7.62)	(1.70-1.78)	(1.57)
1A5018-	—	—	—	—	—	0.820"±0.015" (20.80±0.38)	—	—	0.180" (4.6)	0.053"-0.002" (1.35-0.05)	0.093" (2.36)
1A5600-	—	—	—	—	—	—	—	—	0.200" (5.08)	0.062"±0.003" (1.57±0.077)	0.125"max. (3.18)
1A5601-	—	—	—	—	—	0.820"±0.015" (20.80±0.38)	—	—	0.266" (6.76)	0.067"±0.003" (1.70±0.074)	0.062" (1.57)
1A5602-	—	—	—	—	—	—	—	—	0.220" (5.588)	—	0.125"max. (3.175)

Life Support Policy: Eaton does not authorize the use of any of its products for use in life support devices or systems without the express written approval of an officer of the Company. Life support systems are devices which support or sustain life, and whose failure to perform, when properly used in accordance with instructions for use provided in the labeling, can be reasonably expected to result in significant injury to the user.

It is the responsibility of the end user to verify suitability of the fuse clip in the end application. Application testing is strongly recommended.

Eaton reserves the right, without notice, to change design or construction of any products and to discontinue or limit distribution of any products. Eaton also reserves the right to change or update, without notice, any technical information contained in this bulletin.

**Eaton**  
**Electronics Division**  
1000 Eaton Boulevard  
Cleveland, OH 44122  
United States  
Eaton.com/electronics

© 2019 Eaton  
All Rights Reserved  
Printed in USA  
Publication No. 2131 BU-SB14048  
November 2019

Eaton is a registered trademark.

All other trademarks are property of their respective owners.

Follow us on social media to get the latest product and support information.



## X-ON Electronics

Largest Supplier of Electrical and Electronic Components

*Click to view similar products for [Gate Drivers](#) category:*

*Click to view products by [Eaton](#) manufacturer:*

Other Similar products are found below :

[00028](#) [00053P0231](#) [8967380000](#) [56956](#) [CR7E-30DB-3.96E\(72\)](#) [57.404.7355.5](#) [LT4936](#) [57.904.0755.0](#) [5801-0903](#) [5803-0901](#) [5811-0902](#)  
[5813-0901](#) [58410](#) [00576P0030](#) [00581P0070](#) [5882900001](#) [00103P0020](#) [00600P0005](#) [00-9050-LRPP](#) [00-9090-RDPP](#) [5951900000](#) [01-](#)  
[1003W-10/32-15](#) [LTI LA6E-1S-WH-RC-FN12VXCR1](#) [0131700000](#) [00-2240](#) [LTP70N06](#) [LVP640](#) [0158-624-00](#) [5J0-1000LG-SIL](#) [020017-13](#)  
[LY1D-2-5S-AC120](#) [LY2-0-US-AC120](#) [LY2-US-AC240](#) [LY3-UA-DC24](#) [00-5150](#) [00576P0020](#) [00600P0010](#) [LZNQ2M-US-DC5](#) [LZNQ2-](#)  
[US-DC12](#) [LZP40N10](#) [00-8196-RDPP](#) [00-8274-RDPP](#) [00-8275-RDNP](#) [00-8609-RDPP](#) [00-8722-RDPP](#) [00-8728-WHPP](#) [00-8869-RDPP](#) [00-](#)  
[9051-RDPP](#) [00-9091-LRPP](#) [00-9291-RDPP](#)