

**10250T Pushbuttons**



**RMQ-Titan M22 Series**



**RMQ Compact C22 Series**



<b>1.1</b>	<b>Toggle Switches—E10</b>	
	Product Description .....	<b>V7-T1-2</b>
	Product Selection .....	<b>V7-T1-4</b>
<b>1.2</b>	<b>Environmentally Sealed Toggle Switches—E10E</b>	
	Product Description .....	<b>V7-T1-8</b>
	Product Selection .....	<b>V7-T1-9</b>
<b>1.3</b>	<b>Pushbutton Control Stations—Assembled</b>	
	Product Description .....	<b>V7-T1-14</b>
	Product Selection .....	<b>V7-T1-16</b>
<b>1.4</b>	<b>16.2 mm Pushbuttons—RMQ-16</b>	
	Product Selection Guide .....	<b>V7-T1-31</b>
	Product Selection .....	<b>V7-T1-32</b>
<b>1.5</b>	<b>22.5 mm RMQ-Titan Modular Pushbuttons—M22</b>	
	Product Selection Guide .....	<b>V7-T1-48</b>
	Product Selection .....	<b>V7-T1-53</b>
<b>1.6</b>	<b>22.5 mm RMQ Compact Pushbuttons—C22</b>	
	Product Selection Guide .....	<b>V7-T1-139</b>
	Product Selection .....	<b>V7-T1-141</b>
<b>1.7</b>	<b>30.5 mm Square Multifunction Watertight/Oiltight—E30</b>	
	Product Description .....	<b>V7-T1-174</b>
	Product Selection .....	<b>V7-T1-176</b>
<b>1.8</b>	<b>30.5 mm Heavy-Duty Watertight/Oiltight—10250T</b>	
	Product Description .....	<b>V7-T1-192</b>
	Product Selection .....	<b>V7-T1-196</b>
<b>1.9</b>	<b>30.5 mm Corrosion Resistant Watertight/Oiltight—E34</b>	
	Product Description .....	<b>V7-T1-264</b>
	Product Selection .....	<b>V7-T1-270</b>
<b>1.10</b>	<b>30.5 mm Watertight/Oiltight—HT800</b>	
	Product Description .....	<b>V7-T1-306</b>
	Product Selection .....	<b>V7-T1-308</b>
<b>1.11</b>	<b>30.5 mm Class I Division 2 Hazardous Locations—10250T/E34</b>	
	Product Description .....	<b>V7-T1-331</b>
	Product Selection .....	<b>V7-T1-334</b>

## Volume 7—Logic Control, Operator Interface and Connectivity Solutions, CA08100008E

Tab 1—Pushbuttons and Indicating Lights

Revision date	Section	Change page(s)	Description
04/12/2017	1.5	All pages	Content edits to entire section
04/12/2017	1.6	All pages	Content edits to entire section



*Powering Business Worldwide*



## Product Description

The E10 switches from Eaton's Electrical Sector are intended for general purpose light industrial use. Designed for retrofit and OEM applications.

## Features

### General Purpose Toggles

- Various circuit functions include maintained and momentary
- Poles include from single-pole single-throw to four-pole double-throw
- Spade, screw, and solder terminations available
- Numerous ratings
- Short 11/32 in and tall 15/32 in bat lever available
- Standard 15/32–32 thd.
- Hardware furnished assembled

## Contents

### Description

	<i>Page</i>
Toggle Switches—E10	
Standards and Certifications . . . . .	<b>V7-T1-3</b>
Catalog Number Selection . . . . .	<b>V7-T1-3</b>
Product Selection	
Toggle Switches . . . . .	<b>V7-T1-4</b>
Hesitation Switches . . . . .	<b>V7-T1-5</b>
Pushbuttons . . . . .	<b>V7-T1-5</b>
Accessories . . . . .	<b>V7-T1-5</b>
Technical Data and Specifications . . . . .	<b>V7-T1-6</b>
Circuit Diagrams . . . . .	<b>V7-T1-6</b>
Dimensions . . . . .	<b>V7-T1-7</b>

### Heavy-Duty Hesitation Switches

- One-hole panel mount
- Three position switch offers unique positive center stop feature to assure lever cannot be thrown from one side through the center OFF position without stopping
  - Design feature is a major acceptance for motor reversing and speed control applications
- Prevents motor damage resulting from high current generation by counter EMF of the armature at the time of reversing
- Known as anti-plugging, hesitation, positive stop or positive off switch

### Non-Illuminated AC Rated Pushbuttons

- One-hole panel mount
- Medium-duty
- Spade and screw terminations available
- Various bushing lengths and button extensions
- Numerous ampere ratings with horsepower ratings

### Standards and Certifications

- UL Recognized
- CSA—File No. LR40068



### Catalog Number Selection

Catalog Number Selection is for illustrative purposes only and not to be used to create new catalog numbers.

#### Toggle Switches—E10 Series

Not to be used for ordering purposes

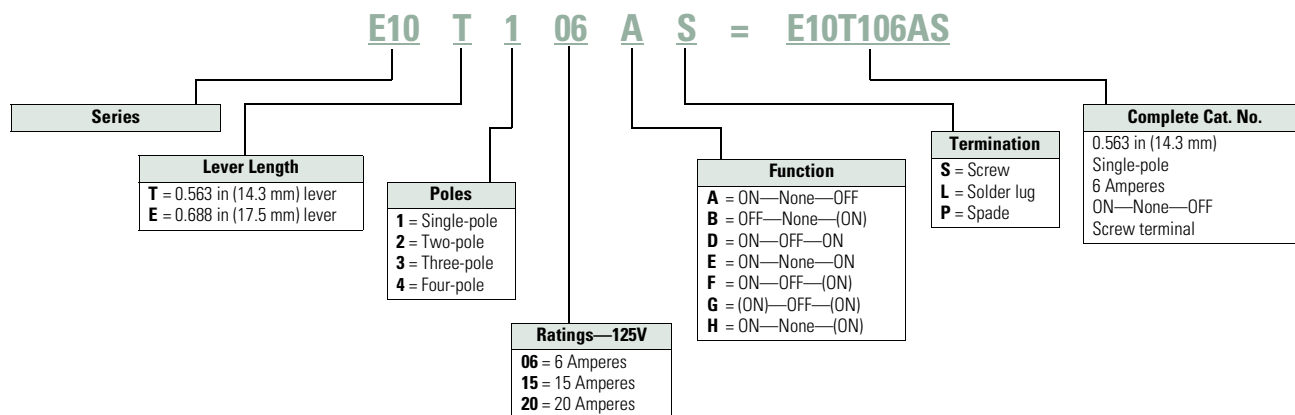







## Product Selection

### Toggle Switches

#### E10 Series—AC Rated—Minimum Order Quantity 10 Pieces

	Nominal AC Ratings			Poles and Throw ①	Function—Circuit with Lever In			Screw Terminal Catalog Number	0.250 in (6.4 mm) Spade Terminal Catalog Number	Solder Lug Catalog Number
	Amperes 125V	hp 250V	hp 50V		UP Position	CENTER Position	DOWN Position—Keyway			
<b>Single-Pole</b>										
	<b>Single-Pole</b>									
	6	3	—	1 P.S.T.	ON	None	OFF	E10T106AS	E10T106AP	E10T106AL
	15	10	3/4					E10T115AS	E10T115AP	E10T115AL
	20	10	3/4					E10E120AS	E10E120AP	E10E120AL
	6	3	—	1 P.D.T.	ON	OFF	ON	E10T106DS	E10T106DP	—
	15	10	3/4					E10T115DS	E10T115DP	E10T115DL
	20	10	3/4					E10E120DS	—	—
	6	3	—	1 P.D.T.	ON	None	ON	E10T106ES	—	—
	15	10	3/4					E10T115ES	E10T115EP	E10T115EL
	20	10	3/4					E10E120ES	—	—
	—	10	1/2	1 P.S.T.	OFF	None	(ON)	E10T115BS	E10T115BP	—
				1 P.D.T.	ON	OFF	(ON)	E10T115FS	E10T115FP	—
				1 P.D.T.	ON	None	(ON)	E10T115HS	E10T115HP	—
			1 P.D.T.	(ON)	OFF	(ON)	E10T115GS	E10T115GP	—	
<b>Two-Pole</b>										
	<b>Two-Pole</b>									
	6	3	—	2 P.S.T.	ON	None	OFF	E10T206AS	E10T206AP	—
	15	10	3/4					E10T215AS	E10T215AP	E10T215AL
	20	10	3/4					E10E220AS	E10E220AP	E10E220AL
	6	3	—	2 P.D.T.	ON	OFF	ON	E10T206DS	E10T206DP	—
	15	10	3/4					E10T215DS	E10T215DP	E10T215DL
	20	10	3/4					E10E220DS	E10E220DP	—
	6	3	—	2 P.D.T.	ON	None	ON	E10T206ES	—	—
	15	10	3/4					E10T215ES	E10T215EP	E10T215EL
	20	10	3/4					E10E220ES	—	—
	15	10	1/2	2 P.S.T.	OFF	None	(ON)	E10T215BS	—	—
				2 P.D.T.	ON	None	(ON)	E10T215HS	E10T215HP	—
				2 P.D.T.	(ON)	OFF	(ON)	E10T215GS	E10T215GP	—
<b>Three-Pole</b>										
	<b>Three-Pole</b>									
	15	10	3/4	3 P.S.T.	ON	None	OFF	E10E315AS	E10E315AP	—
				3 P.D.T.	ON	OFF	ON	E10E315DS	E10E315DP	E10E315DL
			3 P.D.T.	ON	None	ON	E10E315ES	E10E315EP	E10E315EL	
<b>Four-Pole</b>										
	<b>Four-Pole</b>									
	15	10	3/4	4 P.S.T.	ON	None	OFF	E10E415AS	—	E10E415AL
				4 P.D.T.	ON	OFF	ON	E10E415DS	—	E10E415DL
			4 P.D.T.	ON	None	ON	E10E415ES	—	E10E415EL	

**Note**

① See Circuit Diagrams on Page V7-T1-6.

Hesitation Switches

Heavy-Duty Hesitation Switch



E10 Series—Special Purpose—Minimum Order Quantity 10 Pieces

Nominal Ratings				Function—Circuit with Lever In...					Poles and Throw ①	Screw Terminal Catalog Number
Amperes		hp		Operation	UP Position	CENTER Position	DOWN Position—Keyway			
28 Vdc	125 Vac	250 Vac	250 Vac							
15	15	10	3/4	Maintained	ON	OFF	ON	2 P.D.T.	E10E215SS	
								3 P.D.T.	E10E315SS	
								4 P.D.T.	E10E415SS	

Pushbuttons

One-Hole Mounted Medium-Duty, Mom. Contact



E10 Series—Minimum Order Quantity 10 Pieces

Nominal Ratings					Poles and Throw ①	Contacts	Bushing Length in (mm) Dim. "A"	Button Extension in (mm) Dim. "B"	Typical Maximum Operating Force	Screw Terminal Catalog Number	Spade Terminal 0.250 in (6.4 mm) Catalog Number
Amperes		hp									
125 Vac NO	250 Vac NC	125–250V NO	250V NC								
6	—	3	—	—	1 P.S.T.	NO	0.69 (17.5) 0.34 (8.6)	0.53 (13.5) 0.25 (6.4)	0.9 lbs	E10P106RS E10P106JS	E10P106RP —
15	—	10	—	1/3	1 P.S.T.	NO	0.69 (17.5) 0.34 (8.6)	0.53 (13.5) 0.25 (6.4)	0.9 lbs	E10P115RS E10P115JS	E10P115RP —
15	10	10	5	1/4 ②	1 P.D.T.	NO, NC	0.69 (17.5)	0.53 (13.5)	1.0 lbs	E10P115LS	—

Accessories

Toggle Switches Accessories—Minimum Order Quantity 100 Pieces

Description	Material/Notes	Catalog Number
Hexagon locknut	Zinc-chromate treated steel	E10TA101
Knurled face nut	Zinc-chromate treated steel	E10TA102
Internal tooth lockwasher	Cadmium plated steel	E10TA103
Terminal screws	#6-32 x 3/16 in binding head	E10TA201
Spade terminal adapter—0.250 in (6.4 mm)	Assembles to screw terminals	E10TA202
ON-OFF indicating plate—vertical orientation	Burnished nickel finish steel	E10TA301
OFF-ON indicating plate—horizontal orientation	Burnished nickel finish steel	E10TA302

E10TA104

Flip-up guard for toggle switches	E10TA104
-----------------------------------	----------



E10TA105

Fixed shroud for toggle switches	E10TA105
----------------------------------	----------



Notes

Interlock mechanism prevents operation of lever through the center position until pressure is momentarily relieved. Designed for control and protection of reversing motors.

① See Circuit Diagrams on Page V7-T1-6.

② Rated 1/4 hp at 125V, 1/2 hp at 250V.

## Technical Data and Specifications

### Toggle Switches

Description	Specification
AC ratings	6–20A, 125 Vac 3–10A, 250 Vac Max. 3/4 hp at 250 Vac
DC ratings	6–20A, 28 Vdc
Electrical life	6,000 cycles make/break at switch ampere rating
Operation	Slow make/slow break mechanism with butt action for AC and low voltage DC applications Maintained and momentary contacts
Poles/throws	1 through 4, single and double throw
Mounting	One hole with threaded 0.468 in-32 bushing and 0.068 x 0.035 in (1.7 x 0.9 mm) deep keyway that serves as anti-rotational feature
Lever lengths	0.563 in (14.3 mm) or 0.688 in (17.5 mm), bright nickel plated
Terminals	Screw, 0.250 in (6.4 mm) spade and solder lug

### Hesitation Switches

Description	Specification
Operation	Slow make/slow break mechanism with butt action for AC and low voltage DC applications; maintained contacts; ideal for reversing motor applications; interlock mechanism prevents operation of lever through center position until manual pressure is momentarily relieved
AC ratings	15A, 125 Vac 10A, 250 Vac Max. 3/4 hp at 250 Vac
DC ratings	15A, 28 Vdc
Poles/throws	2, 3 and 4, double throw only
Mounting	Single-pole with threaded 0.468 in-32 bushing and 0.068 x 0.049 in (1.7 x 1.2 mm) deep keyway
Lever length	0.687 in (17.4 mm), stainless steel
Terminals	Screw

### Pushbutton Actuators

Description	Specification
AC ratings	6–15A, 125 Vac (NO) 3–10A, 250 Vac (NO) Max. 1/3 hp at 125/250 Vac
Operation	Slow make/slow break mechanism Normally open contacts
Poles/throws	Single, single and double throw
Mounting	One hole with 0.468 in-32 threaded bushing and 0.068 x 0.035 in (1.7 x 0.9 mm) deep keyway Two bushing heights: 11/16 in (17.5 mm) and 11/32 in (8.7 mm)
Button extensions	17/32 in (13.5 mm) and 1/4 in (6.4 mm), bright nickel plated
Terminals	Screw

## Circuit Diagrams

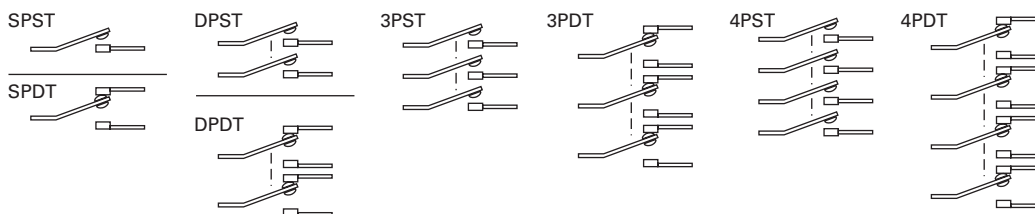

### Dimensions

Approximate Dimensions in Inches (mm)

#### Toggle Switch Dimensions

No. of Poles	Operation	Bushing Length A	Lever Length B	Screw Terminals			Spade Terminals			Solder Lug		
				C	D	E	C <sup>Ⓢ</sup>	D	E	C	D	E
1	Momentary and maintained	0.47 (11.9)	0.56 (14.2)	1.00 (25.4)	1.17 (29.7)	0.63 (16.0)	1.13 (28.7)	1.13 (28.7)	0.63 (16.0)	1.00 (25.4)	1.13 (28.7)	0.63 (16.0)
2	Maintained	0.47 (11.9)	0.56 (14.2)	1.06 (26.9)	1.31 (33.3)	0.75 (19.1)	1.19 (30.2)	1.31 (33.3)	0.75 (19.1)	1.06 (26.9)	1.31 (33.3)	0.75 (19.1)
	Momentary	0.47 (11.9)	0.56 (14.2)	1.25 (31.8)	1.31 (33.3)	0.75 (19.1)	1.31 (33.3)	1.31 (33.3)	0.75 (19.1)	1.25 (31.8)	1.31 (33.3)	0.75 (19.1)
3	Maintained	0.47 (11.9)	0.69 (17.5)	1.27 (32.3)	1.34 (34.0)	1.44 (36.6)	1.37 (34.8)	1.34 (34.0)	1.44 (36.6)	1.23 (31.2)	1.34 (34.0)	1.44 (36.6)
4	Maintained	0.47 (11.9)	0.69 (17.5)	1.20 (30.5)	1.30 (33.0)	1.40 (35.6)	1.30 (33.0)	1.34 (34.0)	1.40 (35.6)	1.23 (31.2)	1.34 (34.0)	1.44 (36.6)

#### Toggle Switch

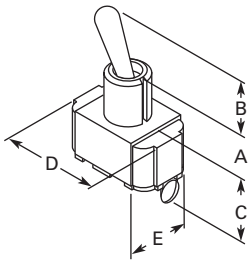

#### Hesitation Switch

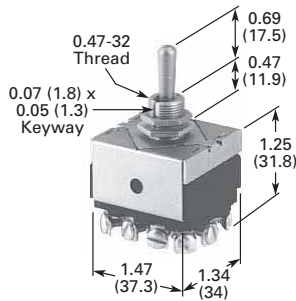

#### Pushbutton Actuator

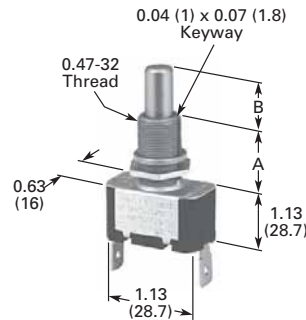

### Accessories

#### E10TA101 Hexagon Locknut

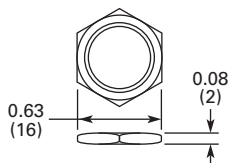

#### E10TA102 Knurled Face Nut

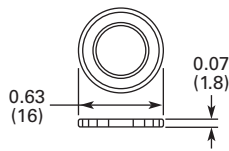

#### E10TA301 ON-OFF Indicating Plate—Vertical Orientation

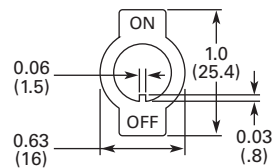

#### E10TA302 ON-OFF Indicating Plate—Horizontal Orientation



#### Note

Ⓢ Spade terminal adapters are used on 6 ampere and momentary screw terminal switches, adding 0.42 in (10.7 mm) to dimension C.



### Product Description

Designed for general purpose and OEM applications, this line of toggle switches provides a high IP68 rating for demanding environments.

### Features

#### Molded-In Screw Terminal

- Completely sealed against dust, moisture and other contaminants
- One-hole mounted bushing for easy installation
- Multi-circuits offered
- Two- and three-position with maintained and momentary action
- Molded-in terminal inserts and terminals numbers
- Single- and two-pole circuitry

#### Econoswitch

- Environmentally sealed
- Single- and two-pole circuitry
- One-hole mounting for easy installation
- Multi-circuits
- Two- and three-position with maintained and momentary action
- Three types of termination offered as standard

### Contents

#### Description

Environmentally Sealed Toggle Switches—E10E

Product Selection

Molded-In Screw Terminal . . . . . **V7-T1-9**

Econoswitch . . . . . **V7-T1-9**

Switch Guard . . . . . **V7-T1-9**

Technical Data and Specifications . . . . . **V7-T1-10**

Dimensions . . . . . **V7-T1-11**

**Page**

### Standards and Certifications

- UL—File number E15346; Guide card number is WOYR2
- CSA—LR40068, class number 6241



#### UL and CSA Nominal Ratings

Catalog Number	125 Vac	250 Vac
<b>Amperes</b>		
<b>E10E118xx</b>	18	9
<b>E10E218xx</b>	18	9
<b>Single-Phase hp</b>		
<b>E10E118xx</b>	1/4	1/2
<b>E10E218xx</b>	1/2	1
<b>Three-Phase hp</b>		
<b>E10E118xx</b>	—	—
<b>E10E218xx</b>	—	—

#### Switch Guard

- For use with two-position switch
- Cover closure transfers switch toggle lever to OFF position
- One-hole mounted mounting style
- Cover is molded out of red thermoset molding material
- Guard cover is spring-loaded to either close or lock in open position
- Prevents accidental operation at switches

#### Options





**Note:** Contact your local Eaton Sales Representative for more information.

- Non-UL Recognized devices
  - Alternate toggle levers
  - Locking toggle levers
  - Rocker buttons
- Special mounting hardware
- Mounting hardware furnished assembled
- Terminal screws furnished assembled
- Special circuits
- Panel seal, part number 32-341
- Spade terminal adapters available

### Product Selection





#### Molded-In Screw Terminal

##### E10E Series—Molded-In Screw Terminal

	Nominal AC Ratings					Circuit with Lever Position			Catalog Number
	Amperes		Single-Phase hp		Three-Phase hp	Up	Center	Down (Keyway)	
	125V	250V	125V	250V	125/250V				
<b>Single-Pole</b>	<b>Single-Pole</b>								
	18	9	1/4	1/2	—	ON	OFF	ON	<b>E10E118DM</b>
						ON	NONE	OFF	<b>E10E118AM</b>
						ON	NONE	ON	<b>E10E118EM</b>
<b>Two-Pole</b>	<b>Two-Pole</b>								
	18	9	1/2	1	—	ON	OFF	ON	<b>E10E218DM</b>
						ON	NONE	OFF	<b>E10E218AM</b>
						ON	NONE	ON	<b>E10E218EM</b>

#### Econoswitch

##### E10E Series—Econoswitch

	Current Ratings—Amperes							Circuit with Lever Position			Screw Terminal Catalog Number	Solder Lug Terminal Catalog Number	Spade Terminal Catalog Number
	Type of Operation	28 Vdc			115 Vac, 60 or 400 Hz			Up	Center	Down (Keyway)			
		Lamp Load	Resistive Load	Inductive Load	Lamp Load	Resistive Load	Inductive Load						
<b>Single-Pole</b>	<b>Single-Pole</b>												
	Maintained	5	20	15	3	15	10	ON	OFF	ON	<b>E10E118DS</b>	<b>E10E118DL</b>	<b>E10E118DP</b>
	Maintained	5	20	15	3	15	10	ON	NONE	OFF	<b>E10E118AS</b>	<b>E10E118AL</b>	<b>E10E118AP</b>
	Maintained	5	20	15	3	15	10	ON	NONE	ON	<b>E10E118ES</b>	<b>E10E118EL</b>	<b>E10E118EP</b>
	Momentary	4	15	10	2	15	7	ON <sup>Ⓢ</sup>	OFF	ON <sup>Ⓢ</sup>	<b>E10E118GS</b>	<b>E10E118GL</b>	<b>E10E118GP</b>
	Momentary	4	15	10	2	15	7	OFF	NONE	ON <sup>Ⓢ</sup>	<b>E10E118BS</b>	<b>E10E118BL</b>	<b>E10E118BP</b>
<b>Two-Pole</b>	<b>Two-Pole</b>												
	Maintained	7	20	15	4	15	15	ON	OFF	ON	<b>E10E218DS</b>	<b>E10E218DL</b>	<b>E10E218DP</b>
	Maintained	7	20	15	4	15	15	ON	NONE	OFF	<b>E10E218AS</b>	<b>E10E218AL</b>	<b>E10E218AP</b>
	Maintained	7	20	15	4	15	15	ON	NONE	ON	<b>E10E218ES</b>	<b>E10E218EL</b>	<b>E10E218EP</b>
	Momentary	5	18	10	2	11	8	ON <sup>Ⓢ</sup>	OFF	ON <sup>Ⓢ</sup>	—	<b>E10E218GL</b>	<b>E10E218GP</b>
	Momentary	5	18	10	2	11	8	OFF	NONE	ON <sup>Ⓢ</sup>	<b>E10E218BS</b>	<b>E10E218BL</b>	<b>E10E218BP</b>

#### Switch Guard

##### Switch Guard

##### E10E Series—Switch Guard



	Catalog Number
Switch Guard	<b>E10TA104</b>

**Note**

Ⓢ Momentary contact.

## Technical Data and Specifications

### E10E Series—Molded-In Screw Terminal

Description	Specification
Watertight seal	Per MIL-STD-108E and designed to meet IP68
Thermoset molding materials	Meet flame retardant requirements
Temperature range	–50° to 150°F (–46° to 66°C)
Life	20,000 operations at rated load; 40,000 operations mechanical life; 6,000 operations at hp ratings per UL and CSA requirements
Bushings	15/32 in-32 thread

### E10E Series—Econoswitch

Description	Specification
Watertight seal	Per MIL-STD-108E and designed to meet IP68
Type of terminal	Screws—6-32 UNC-22A Solder lug—0.125 in (3.17 mm) dia. hole Spade—0.250 in (6.35 mm) x 0.032 in (0.81 mm) thick
Life	50,000 operations at rated load; 100,000 operations mechanical life
Temperature range	–50° to 150°F (–46° to 66°C)

**Dimensions**

Approximate Dimensions in Inches (mm)

**Single-Pole Molded-In Screw Terminal E10E Series**

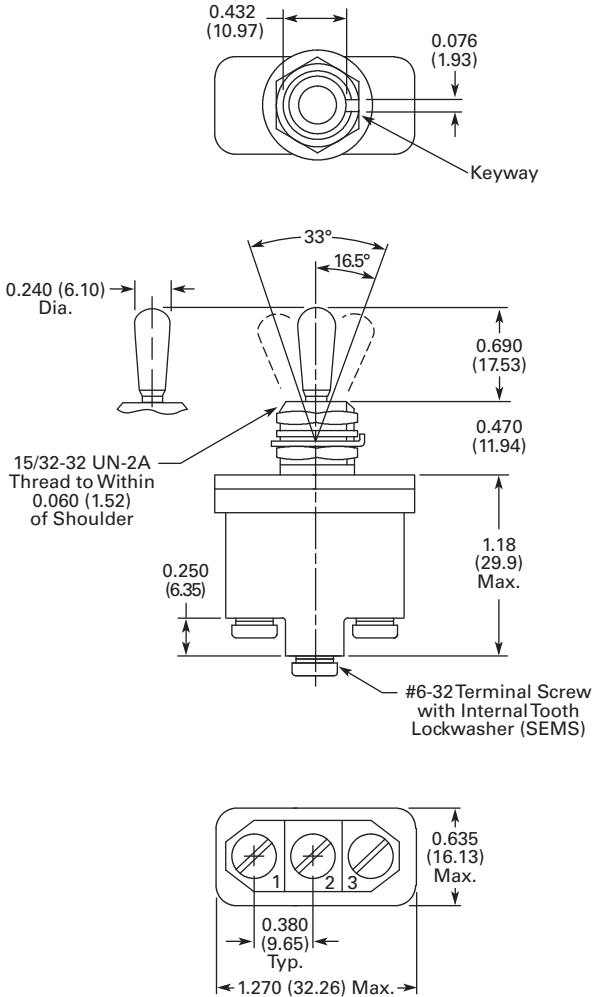

**Two-Pole Molded-In Screw Terminal E10E Series**

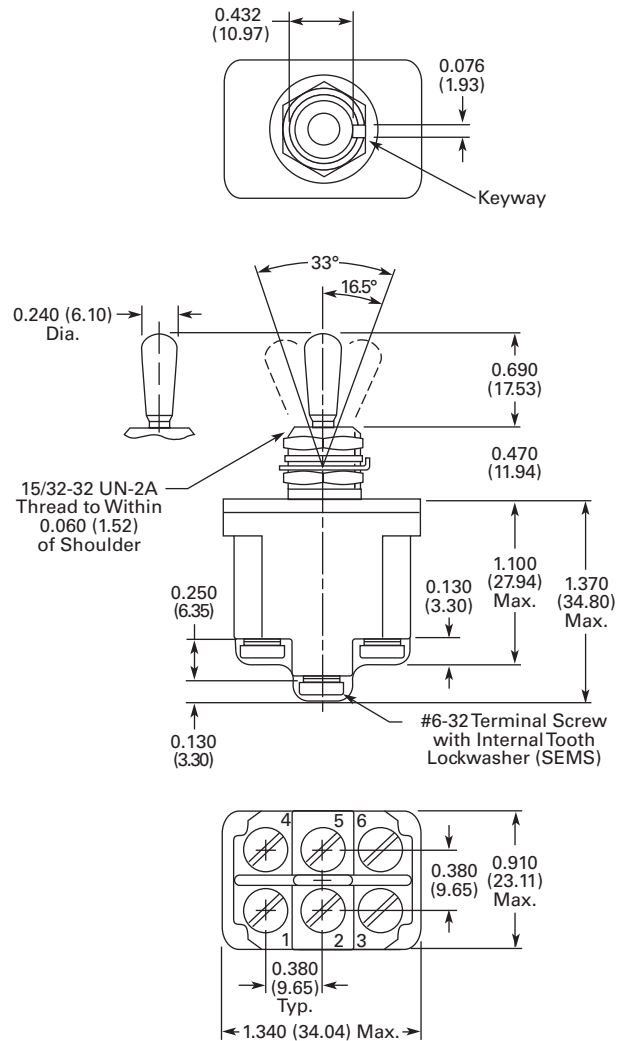

**Toggle Switch Panel Cutout**

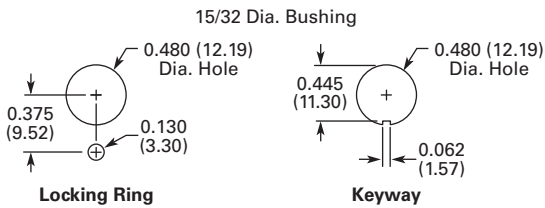



# 1.2

## Pushbuttons and Indicating Lights

### Environmentally Sealed Toggle Switches—E10E

1

Approximate Dimensions in Inches (mm)

#### Single-Pole Econoswitch E10E Series

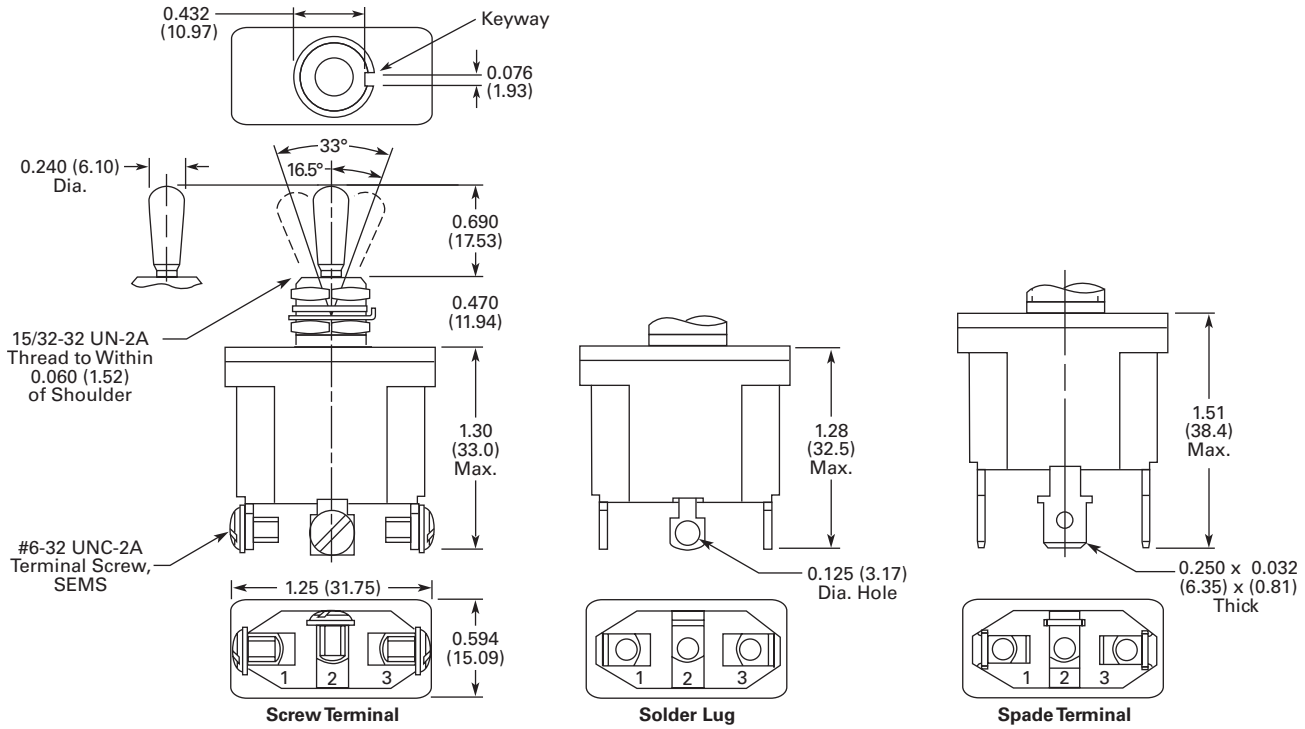

#### Two-Pole Econoswitch E10E Series

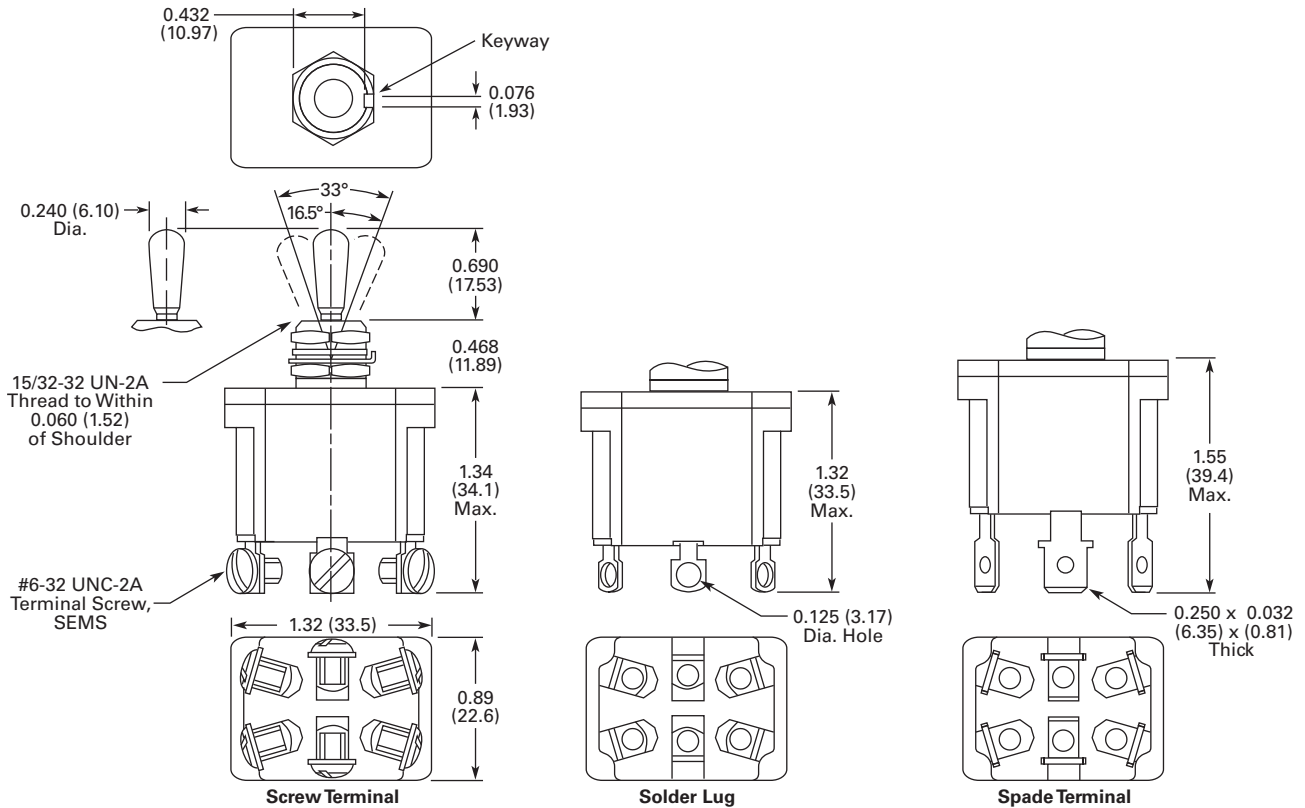

Approximate Dimensions in Inches (mm)

**Switch Guard**

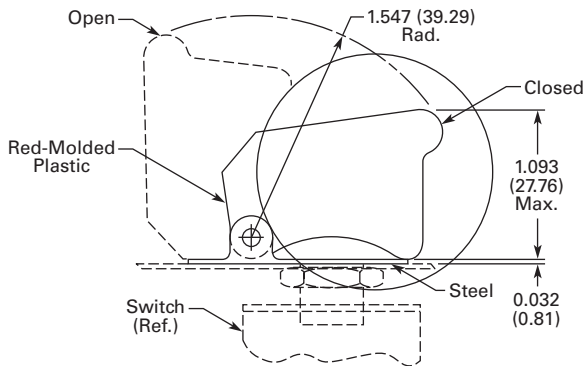
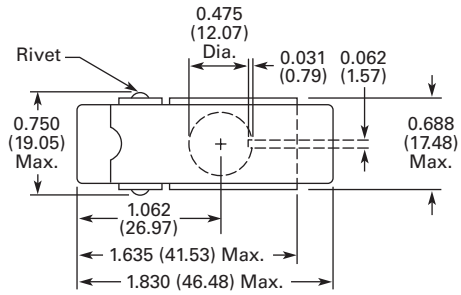
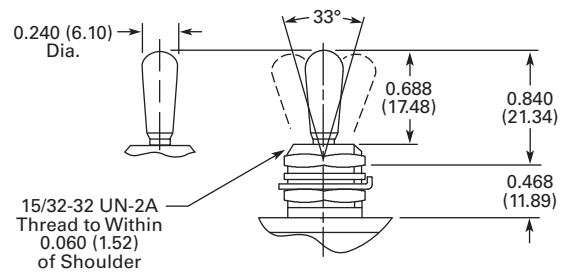

## Pushbutton Control Stations



## Contents

**Description****Page**

Pushbutton Control Stations—Assembled	
Features . . . . .	<b>V7-T1-15</b>
Product Selection	
M22 Assembled Control Stations . . . . .	<b>V7-T1-16</b>
Commercial Control Stations . . . . .	<b>V7-T1-17</b>
General Purpose Control Stations . . . . .	<b>V7-T1-18</b>
Special Purpose Control Stations . . . . .	<b>V7-T1-19</b>
10250H Series Heavy-Duty Control Stations . . . . .	<b>V7-T1-20</b>
10250T Series Heavy-Duty 30.5 mm Control Stations . . . . .	<b>V7-T1-21</b>
Class I Division 2 10250T Series Heavy-Duty 30.5 mm Control Stations . . . . .	<b>V7-T1-22</b>
Class I Division 2 E34 Series Corrosion Resistant 30.5 mm Control Stations . . . . .	<b>V7-T1-23</b>
Accessories . . . . .	<b>V7-T1-23</b>
Custom Assembled Stations	
Specification Form . . . . .	<b>V7-T1-24</b>
Renewal Parts . . . . .	<b>V7-T1-26</b>
Technical Data and Specifications . . . . .	<b>V7-T1-28</b>
Dimensions . . . . .	<b>V7-T1-28</b>

**Product Description****M22 Assembled Control Stations**

- M22 series operators
- Available in horizontal and vertical configurations
- Impact resistant polycarbonate enclosures
- Optional yellow covers
- Base mounting contact blocks and light units for quick wiring and vibration resistance

**Commercial Control Stations**

- 10250T series operators
- Full front label
- Specific function labels on front of enclosure

**General Purpose Control Stations**

- Construction grade
- General purpose wall mount
- Popular with contractors
- UL (NEMA) Type 1

**Special Purpose Control Stations**

- Standard grade
- Polyester enclosure
- UL (NEMA) Type 3, 3R, 4, 4X, 13

**10250H Series Heavy-Duty Control Stations**

- 10250H Series operators
- Dark brown polyester enclosure
- Protective rubber gaskets provide NEMA 3S rating on pushbuttons
- Top and bottom 3/4 in NPT conduit entrances
- Includes alternate legend plates and spare mounting screws

**10250T Series Heavy-Duty 30.5 mm Control Stations**

- 10250T Series operators
- ASA 61 gray die-cast zinc enclosures
- Surface or flush mounting
- Single 3/4 in NPT conduit entrance on one and two element stations
- Single 1 in NPT conduit entrance on three element stations

**Class I Division 2 10250T Series Heavy-Duty 30.5 mm Control Stations**

- 10250T Series operators
- Factory sealed contact blocks
- Die-cast, polyester or stainless steel enclosures
- Approved for NEC Class I Division 2, Groups B, C and D or Class I Zone 2 Group IIB plus Hydrogen type hazardous locations

**Class I Division 2 E34 Series Corrosion Resistant 30.5 mm Control Stations**

- E34 Series operators
- Factory sealed contact blocks
- Die-cast, polyester or stainless steel enclosures
- Approved for NEC Class I Division 2 Groups B, C and D or Class I Zone 2 Group IIB plus Hydrogen type hazardous locations

**Features****M22 Assembled Control Stations**

- IP66, UL (NEMA) Type 4X, 13
- Impact resistant polycarbonate enclosures
- Optional yellow cover
- 25% smaller depth than most competitor enclosures
- Base mounting contact blocks and light units for faster wiring and vibration resistance

**Commercial Control Stations**

- ASA 61 gray die-cast zinc enclosures
- Pre-assembled and labeled for functions such as “Fuel Shut-Off”
- Great for commercial applications

**General Purpose Control Stations**

- Construction grade
- General purpose wall mount
- Popular with contractors
- UL (NEMA) Type 1

**Special Purpose Control Stations**

- Standard grade
- Polyester enclosure
- UL (NEMA) Type 3, 3R, 4, 4X, 13

**10250H Series Heavy-Duty Control Stations**

- Industrial grade
- Extra heavy-duty
- Polyester enclosure
- Booted buttons
- Outdoor installation
- UL (NEMA) Type 3, 3R, 3S, 4, 4X, 12, 13

**10250T Series Heavy-Duty 30.5 mm Control Stations**

- 30.5 mm operators
- Industrial grade
- Zinc die cast enclosure
- Popular with industrial end users
- UL (NEMA) Type 4, 4X, 12, 13

**Class I Division 2 Control Stations**

- Available with 10250T or E34 30.5 mm operators
- Zinc die cast, polyester or stainless steel enclosures
- Factory-sealed contact blocks
- Popular with industrial end users
- UL (NEMA) Type 4, 4X, 12, 13
- NEC Class I Division 2 Groups B, C and D

## Product Selection

### M22 Assembled Control Stations



#### One Element Control Stations

Orientation	Description	Color	①	Inscription	Enclosure Cover Color	Catalog Number
Horizontal	40 mm mushroom head push-pull emergency stop operator	Red	NC	—	Yellow	<b>M22-C1-M1H</b>
Horizontal	40 mm illuminated mushroom head push-pull emergency stop operator, 85–264 Vac	Red	NO-NC	—	Yellow	<b>M22-C1-M2H</b>
Horizontal	40 mm mushroom head twist-to-release emergency stop operator	Red	NC	—	Yellow	<b>M22-C1-M3H</b>
Horizontal	40 mm mushroom head key-release emergency stop operator	Red	NC	—	Yellow	<b>M22-C1-M4H</b>
Horizontal	Flush pushbutton	Green	NO	①	Gray	<b>M22-C1-M5H</b>
Horizontal	Flush pushbutton	Green	NO	START	Gray	<b>M22-C1-M6H</b>
Horizontal	Extended pushbutton	Red	NC	Ⓞ	Gray	<b>M22-C1-M7H</b>
Horizontal	Extended pushbutton	Red	NC	STOP	Gray	<b>M22-C1-M8H</b>
Horizontal	Key-operated selector switch, two-position maintained	—	NO	OFF-ON	Gray	<b>M22-C1-M9H</b>
Horizontal	Knob type selector switch, three-position maintained	—	2NO	HAND 0 AUTO	Gray	<b>M22-C1-M10H</b>
Horizontal	Double pushbutton	Green	NO	START	Gray	<b>M22-C1-M11H</b>
		Red	NC	STOP		

#### Two Element Control Stations

Orientation	Element 1 Description	Color	①	Inscription	Element 2 Description	Color	①	Inscription	Enclosure Cover Color	Catalog Number
Horizontal	Extended pushbutton	Red	NC	Ⓞ	Flush pushbutton	Green	NO	①	Gray	<b>M22-C2-M1H</b>
Vertical	Flush pushbutton	Green	NO	START	Extended pushbutton	Red	NC	STOP	Gray	<b>M22-C2-M2V</b>
Vertical	Flush pushbutton	Black	NO	FORWARD	Flush pushbutton	Black	NO	REVERSE	Gray	<b>M22-C2-M3V</b>

#### Three Element Control Stations

Orientation	Element 1 Description	Color	①	Inscription	Element 2 Description	Color	①	Inscription	Element 3 Description	Color	①	Inscription	Enclosure Cover Color	Catalog Number
Horizontal	Extended pushbutton	Red	NC	Ⓞ	Indicating light	White	85–264 Vac	—	Flush pushbutton	Green	NO	①	Gray	<b>M22-C3-M1H</b>
Vertical	Indicating light	White	85–264 Vac	—	Flush pushbutton	Green	NO	START	Extended pushbutton	Red	NC	STOP	Gray	<b>M22-C3-M2V</b>
Horizontal	Flush pushbutton	Green	NO	①	Extended pushbutton	Red	NC	Ⓞ	Flush pushbutton	Green	NO	②	Gray	<b>M22-C3-M3H</b>
Vertical	Flush pushbutton	Black	NO	OPEN	Extended pushbutton	Red	NC	STOP	Flush pushbutton	Black	NO	CLOSE	Gray	<b>M22-C3-M4V</b>
Vertical	Flush pushbutton	Black	NO	FORWARD	Flush pushbutton	Red	NC	STOP	Flush pushbutton	Black	NO	REVERSE	Gray	<b>M22-C3-M5V</b>
Vertical	Flush pushbutton	Black	NO	UP	Flush pushbutton	Red	NC	STOP	Flush pushbutton	Black	NO	DOWN	Gray	<b>M22-C3-M6V</b>

#### Notes

For assembled control stations not found in this selection, please contact the Eaton Technical Resource Center at 1-877-ETN CARE (386-2273) or TRC@eaton.com.

① Contact block configuration.

**Commercial Control Stations**



**Key Specifications**

- 30.5 mm (10250T series) operators
- ASA 61 gray die-cast zinc enclosures
- Industrial grade
- UL® Type 4, 4X, 12, 13
- Single 3/4 in NPT conduit entrance
- Dimensions—in (mm)
  - Enclosure: 3.88 W x 4.00 H x 3.00 D (98.6 x 101.6 x 76.3)
  - Operator: 1.63 D (to enclosure) x 1.50 diameter (41.4 x 38.1)

**What is included?**

Eaton’s pre-assembled, enclosed emergency stop pushbutton stations include an operator, an enclosure, contact blocks and a variety of unique labels. Each label has white lettering on a red background indicating the function and red lettering on a white background indicating the operator type.

**Available Catalog Numbers**

Catalog Number <sup>①</sup>	Operator	Enclosure Color	Label
10250T5B62-S101	Push-Pull	Gray	EMERGENCY STOP
10250T5B62-S102	Push-Pull	Gray	EMERGENCY SHUT-OFF
10250T5B62-S103	Push-Pull	Gray	EMERGENCY GENERATOR STOP
10250T5B62-S104	Push-Pull	Gray	EMERGENCY HVAC SHUT-DOWN
10250T5B62-S105	Push-Pull	Gray	EMERGENCY ELECTRICAL DISCONNECT
10250T5B62-S106	Push-Pull	Gray	EMERGENCY BOILER SHUT-DOWN
10250T5B62-S107	Push-Pull	Gray	EMERGENCY CHILLER STOP
10250T5B62-S108	Push-Pull	Gray	EMERGENCY FUEL SHUT-OFF
10250T5B62-S109	Push-Pull	Gray	EMERGENCY REFRIGERATION STOP
10250T5B62-S110	Push-Pull	Gray	EMERGENCY POWER OFF
10250T5B62-S111	Push-Pull	Gray	EMERGENCY GAS SHUT-OFF
10250T5B62-S112	Push-Pull	Gray	EMERGENCY VENTILATION SHUT-DOWN
10250T5B62-S113	Push-Pull	Gray	GENERATOR

**Additional Contact Blocks**

(Sold Separately)

Catalog Number	Circuit Configuration
10250T51	1NC
10250T53	1NO
10250T1	NO-NC
10250T3	2NC
10250T2	2NO























**Note**

① Includes 1NO-1NC contact block.

#### 1

#### General Purpose Control Stations

##### Type N Control Stations—UL (NEMA) Type 1

	Contact Symbol	Button Type/Color	Legends	Catalog Number
<b>Single Button Station for Padlock Attachment</b> <sup>①</sup> 	<b>One Element Enclosure Type</b>			
		Flush/green	START	<b>10250H5100</b>
		Flush/red	STOP	<b>10250H5101</b>
		Extended/red	STOP	<b>10250H5104</b>
		Palm operated/black	None	<b>10250H89</b> <sup>②</sup>
<b>Selector Switch</b> 		Three-position selector switch/black knob	RUN/OFF/AUTO	<b>10250H289</b> <sup>②</sup>
<b>Two Button Station</b> 	<b>Two Element Enclosure Type</b>			
		Flush/red	START/STOP	<b>10250H5200</b>
		Flush/green extended/red	START/STOP	<b>10250H5207</b>
		Flush/black (all)	RAISE/LOWER	<b>10250H5201</b>
			FOR/REV	<b>10250H5202</b>
			OPEN/CLOSE	<b>10250H5203</b>
			UP/DOWN	<b>10250H5204</b>
HIGH/LOW			<b>10250H5205</b>	
FAST/SLOW	<b>10250H5208</b>			
<b>Three Button Station</b> 	<b>Three Element Enclosure Type</b>			
		Flush/black (all)	FOR/REV/STOP	<b>10250H5300</b>
			UP/DOWN/STOP	<b>10250H5301</b>
			RAISE/LOWER/STOP	<b>10250H5302</b>
			OPEN/CLOSE/STOP	<b>10250H5303</b>
	FAST/SLOW/STOP		<b>10250H5304</b>	
<b>Three Button Station with Indicating Light</b> 		110/220V neon indicating light	START/STOP	
		Clear—flush/green; flush/red		<b>10250H5310</b>
		Red—flush/green; flush/red		<b>10250ED853</b>
		Amber—flush/green; flush/red		<b>10250ED853-2</b>

#### Notes

- ① Padlock attachment (10250H5110) must be purchased separately.
- ② Round button.

### Type N Control Stations—Open Type Construction (No Cover)

Contact Symbol	Button Type/Color	Legends	Catalog Number
<b>Selector Switch</b>			
<b>One Element Enclosure Type</b>			
	Three-position selector switch/black knob	RUN/OFF/AUTO	<b>10250H2538</b>
<b>Two Button Station</b>			
<b>Two Element Enclosure Type</b>			
	Flush/green	START/STOP	<b>10250H2747</b>
	Flush/black (all) mech. interlocked	None <sup>①</sup>	<b>10250H2544</b>

### Special Purpose Control Stations

#### Special Purpose Control Stations—UL (NEMA) Type 3, 3R, 4, 4X, 13

Contact Symbol	Feature	Legends	Catalog Number
<b>10250H_</b>			
<b>One Element Pushbutton Type</b>			
	Flush	START	<b>10250H2738</b>
		STOP	<b>10250H658</b>
	With lock hasp	STOP	<b>10250H665</b>
<b>10250H_</b>			
<b>Two Element Pushbutton Type</b>			
	Flush	START/STOP	<b>10250H364</b>
	With lock hasp	START/STOP	<b>10250H671</b>
	Buttons interlocked	FAST/SLOW	<b>10250ED664</b>
		FOR/REV	<b>10250H2740</b>
		UP/DOWN	<b>10250H2741</b>
		OPEN/CLOSE	<b>10250H2742</b>



**Note**

<sup>①</sup> No legend on buttons. Specify any standard legend.







#### 10250H Series Heavy-Duty Control Stations

##### Type H Control Stations—UL (NEMA) Type 3, 3S, 4, 4X, 12, 13

Element Type	Feature	Circuit	Assembled Legend Plate	Unassembled Alternate Legend Plate	Catalog Number	
<b>10250H_ One Element</b>						
	Pushbuttons	Without padlock hasp	1NO-1NC	JOG	START STOP RUN	<b>10250H1881</b>
		With padlock hasp	1NC	STOP	—	<b>10250H4239</b>
Knob selector switch	Two-position	1NO-1NC	OFF/ON	—	<b>10250H4526</b>	
	Three-position	1NO-1NC	MAN/OFF/AUTO	—	<b>10250H4527</b>	
<b>10250H_ Two Element</b>						
	Pushbuttons	Standard	1NO-2NC	START/STOP	—	<b>10250H1884</b>
			2NO-2NC	RAISE/LOWER	FORWARD REVERSE OPEN CLOSE	<b>10250H1885</b>
		Standard and standard with padlock hasp	1NO-2NC	START/STOP	—	<b>10250H4240</b>
<b>10250H_ Three Element</b>						
	Pushbuttons	Standard	2NO-3NC	FOR/REV/STOP	START    OPEN	<b>10250H1890</b>
		Two standard and standard with padlock hasp			JOG    CLOSE RAISE    FAST LOWER    SLOW	<b>10250H4241</b>
Indicating light and pushbuttons	120V	Light-red lens and two plain	1NO-2NC	MOTOR RUNNING START/STOP	—	<b>10250H1913</b>

### 10250T Series Heavy-Duty 30.5 mm Control Stations

#### Complete Assembled Stations—UL (NEMA) Type 4, 4X, 12, 13

Element Type <sup>①</sup>	Features	Contact Block(s)	Legend	Surface Mounting Catalog Number	Flush Mounting <sup>②</sup> Catalog Number	
<b>Break Glass Station</b>						
	Break glass station <sup>③</sup>	Gray enclosure	NC (logic level)	EMERG. OFF	<b>10250TGS</b>	—
		Red enclosure			<b>10250TGR</b>	—
<b>One Element</b>						
	Pushbutton	Standard	NO-NC	START	<b>10250T3516</b>	<b>10250T3573</b>
			NC	STOP	<b>10250T3518</b>	<b>10250T3575</b>
			NO-NC	None	<b>10250T3540</b>	<b>10250T3597</b>
		Mushroom head	NO-NC	START	<b>10250T3517</b>	<b>10250T3574</b>
		NC	STOP	<b>10250T3519</b>	<b>10250T3576</b>	
		With lock hasp <sup>④</sup>	NC	STOP	<b>10250T3520</b>	<b>10250T3577</b>
	Selector switch	Two-position black knob	NO-NC	OFF/ON	<b>10250T3523</b>	<b>10250T3580</b>
		Three-position black knob	2NO	MAN/OFF/AUTO	<b>10250T3524</b>	<b>10250T3581</b>
Push-pull three-position	Momentary red button	2NC	START/STOP	<b>10250T3545</b>	<b>10250T3602</b>	
<b>Two Element</b>						
	Pushbuttons	Standard	1NO-2NC	START/STOP	<b>10250T3525</b>	<b>10250T3582</b>
			2NO-2NC	RAISE/LOWER	<b>10250T3672</b>	<b>10250T3673</b>
			2NO-2NC	None	<b>10250T3541</b>	<b>10250T3598</b>
		With lock hasp <sup>④</sup>	1NO-2NC	START/STOP	<b>10250T3542</b>	<b>10250T3599</b>
		Standard and mushroom head	1NO-2NC	START/STOP	<b>10250T3526</b>	<b>10250T3583</b>
		Standard with maintained contact <sup>⑤</sup>	NO-NC Plus NC	START/STOP	<b>10250T3528</b>	<b>10250T3585</b>
<b>Three Element</b>						
	Pushbuttons	Standard	2NO-3NC	FOR, REV, STOP	<b>10250T3532</b>	<b>10250T3589</b>
			2NO-3NC	UP, DOWN, STOP	<b>10250T3615</b>	—
			2NO-3NC	OPEN, CLOSE, STOP	<b>10250T3614</b>	—
			2NO-3NC	None, None, STOP	<b>10250T3543</b>	<b>10250T3600</b>
		Two standard and with lock hasp	2NO-3NC	None, None, STOP	<b>10250T3544</b>	<b>10250T3601</b>
	Indicating light (transformer type) and pushbuttons	Red lens — 120V	1NO-2NC	MOTOR RUN, START/STOP	<b>10250T3536</b>	<b>10250T3593</b>
		Red lens — 240V			<b>10250T3537</b>	<b>10250T3594</b>
Red lens — 480V				<b>10250T3538</b>	<b>10250T3595</b>	
	Red lens — 600V			<b>10250T3539</b>	<b>10250T3596</b>	

#### Break Glass Operator <sup>⑥</sup>



#### Break Glass Kit















Description	Catalog Number
Operator with hammer and five glass discs	<b>10250TBG</b>
Glass discs only (5)	<b>10250TGL</b>

#### Notes

- ① Stop buttons are red—all others are black.
- ② NEMA 4–13, if properly mounted on a flat surface. Consists of front plate, legend, operator and contact blocks.
- ③ Break glass stations will not function with Normally Open contact blocks.
- ④ Lock is 10250TA2.
- ⑤ Uses deep cover instead of shallow cover. Switch component is 10250TA67—mechanically interlocked operators.
- ⑥ Shown assembled to contact block (contact block supplied separately).

#### Class I Division 2 10250T Series Heavy-Duty 30.5 mm Control Stations

#### Complete Assembled Stations— UL (NEMA) Type 4, 4X, 12, 13; NEC Class I Division 2, Groups B, C and D

Contact Symbol	Button Type/Color	Legend Marking	Die Cast Enclosure Catalog Number	Polyester Molded Enclosure Catalog Number	Stainless Steel Enclosure Catalog Number
<b>10250T7007</b>					
<b>Single Pushbutton</b>					
	Flush/green	START	10250T7003	10250T7003P	10250T7003S
	Extended/red	STOP	10250T7005	10250T7005P	10250T7005S
	Alum. jumbo mushroom/red	EMER. STOP (engraved button)	10250T7007	10250T7007P	10250T7007S
	Flush/black	No legend	10250T7009	10250T7009P	10250T7009S
<b>10250T7023P</b>					
<b>Two Pushbuttons</b>					
	Flush/green	START	10250T7023	10250T7023P	10250T7023S
	Extended/red	STOP			
Each Button	Flush/black	No legend	10250T7025	10250T7025P	10250T7025S
	Flush/black	No legend			
<b>10250T7033S</b>					
<b>Single Pilot Light—Two Pushbuttons</b>					
	120 Vac red	No legend	10250T7033	10250T7033P	10250T7033S
	Flush/green	START			
	Extended/red	STOP			
Each Button	120 Vac red	No legend	10250T7035	10250T7035P	10250T7035S
	Flush/black				
	Flush/black				
<b>Three-Position Selector Switch</b>					
	Maintained knob/black	HAND/OFF/AUTO	10250T7011	10250T7011P	10250T7011S
	Maintained knob/black	No legend	10250T7013	10250T7013P	10250T7013S
<b>Single Pushbutton Maintained</b>					
	Push-pull with jumbo mushroom/red	EMER. STOP (engraved button)	10250T7019	10250T7019P	10250T7019S
Pull Push    					

### Class I Division 2 E34 Series Corrosion Resistant 30.5 mm Control Stations

E34EX\_



#### Complete Assembled Stations— UL (NEMA) Type 4, 4X, 12, 13; NEC Class I Division 2, Groups B, C and D

Contact Symbol	Button Type/Color	Legend Marking	Die Cast Enclosure Catalog Number	Polyester Molded Enclosure Catalog Number	Stainless Steel Enclosure Catalog Number
<b>Single Pushbutton</b>					
1NO	Flush/green	START	E34EX7003	E34EX7003P	E34EX7003S
1NC	Extended/red	STOP	E34EX7005	E34EX7005P	E34EX7005S
	Alum. jumbo mushroom/red	EMER. STOP (engraved button)	E34EX7007	E34EX7007P	E34EX7007S
	Flush/black	No legend	E34EX7009	E34EX7009P	E34EX7009S
<b>Two Pushbuttons</b>					
1NO	Flush/green	START	E34EX7023	E34EX7023P	E34EX7023S
1NC	Extended/red	STOP			
Each Button	Flush/black	No legend	E34EX7025	E34EX7025P	E34EX7025S
	Flush/black	No legend			
<b>Three-Position Selector Switch</b>					
2NO	Maintained knob/black	HAND/OFF/AUTO	E34EX7011	E34EX7011P	E34EX7011S
2NC	Maintained knob/black	No legend	E34EX7013	E34EX7013P	E34EX7013S
<b>Single Pushbutton Maintained</b>					
Pull Push O X 1NO X O 1NC	Push-pull with jumbo mushroom/red	EMER. STOP (engraved button)	E34EX7019	E34EX7019P	E34EX7019S

## Accessories

Padlock Attachment



#### Type N Control Stations

Description	Catalog Number
Padlock attachment—For field assembly on square button type (except extended button types)	10250H5110

**Note**

Use NEMA 4X 10250T operators where exposed to ultraviolet light, see [Page V7-T1-22](#).

#### 1 Custom Assembled Stations Specification Form

##### Ordering Instructions

###### Step 1

Copy this ordering guide from catalog.

###### Step 2

Specify 10250T or E34 pushbutton lines in the corresponding box on the following page.

10250T	<b>Pages</b> V7-T1-192 to V7-T1-263
E34	<b>Pages</b> V7-T1-264 to V7-T1-305
10250T and E34 Class I Div. 2	<b>Pages</b> V7-T1-331 to V7-T1-371

###### Step 3

Check back of panel dimensions—specify single or double depth enclosure in the corresponding box on the following page.

###### Step 4

Specify enclosure catalog number and price in the corresponding box on the following page. Enclosures can be found on **Pages V7-T1-116, V7-T1-243** and **V7-T1-293**. For pricing, reference the most recent PAD or VISTA-line.

###### Step 5

Specify catalog numbers for desired operator, legend plate, light unit, accessory and contact block(s) for each location in the enclosure in the corresponding box on the following page. (See position locations on this page.)

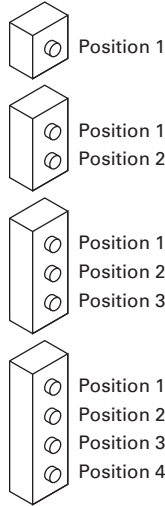

##### Position Locations

###### Step 6

For non-standard legends, specify legend desired, letter size and location on the layout sketches on the following page. For limitations see **Page V7-T1-242**. For pricing, use the blank legend catalog number and "STAMP" Suffix (Ex.: **10250TS36STAMP**) and reference the most recent PAD or VISTA-line.

Example: 10250TS36

Special Legend for Position # \_\_\_\_\_

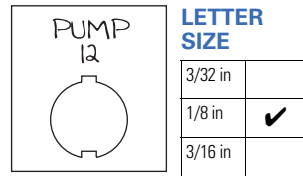

###### Step 7

Fax Sheet 2 of this form to Eaton's TRC, Technical Resource Center, at 828-651-0549 to the attention of—**Custom Stations Order** or email to TRC@eaton.com.

Within a few days you will receive a confirmation fax with the custom station part number and price.

###### Step 8

Place your order over the VISTA System.

##### For Selector and Roto-Push Operators

###### 10250T or E34

For single contact blocks or 1NO-1NC contact blocks, the mounting position of contacts must be specified. For example: If a 1NO-1NC contact block is required, specify if NO is to be mounted in Top A position or Bottom B position.



To — **Eaton's TRC, Custom Station Order**  
**(828) 651-0549 FAX, or email to TRC@eaton.com**

From — Customer Name \_\_\_\_\_  
 Customer Contact \_\_\_\_\_  
 Phone Number \_\_\_\_\_  
 Fax Number \_\_\_\_\_  
 Email Address \_\_\_\_\_

FACTORY USE ONLY	
Part Number	
Product Code	
Suffix	
Date	
Engineer	

**Step 2)**

**10250T**    **STD**    **Class I Division 2**  
**E34**    **STD**    **Class I Division 2**

**Step 3)**

Single Depth Enclosure	✓
Double Depth Enclosure	

**Step 4)**

Enclosure Catalog Number	Price

**Step 5)**

Position	Operator	Price U.S. \$	Light Unit	Price U.S. \$	Contact Block	Price U.S. \$	A/L	B/R	Contact Block	Price U.S. \$	A/L	B/R	Total Price
1													
2													
3													
4													

Position	Legend Plate	Price U.S. \$	Lens or Caps	Price U.S. \$	Accessory	Price U.S. \$	Total Price
1							
2							
3							
4							

<b>Total:</b>

**10% Adder  
for Assembled Stations**

**Step 6) Non-standard Legends**

Special Legend for Position # \_\_\_\_\_

Special Legend for Position # \_\_\_\_\_

Special Legend for Position # \_\_\_\_\_

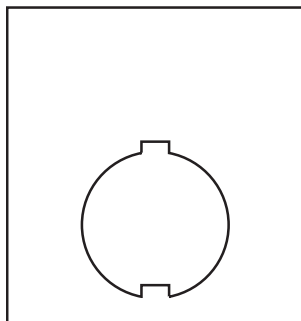

**LETTER SIZE** ✓

3/32 inch (2.4 mm)	
1/8 inch (3.2 mm)	
3/16 inch (4.8 mm)	

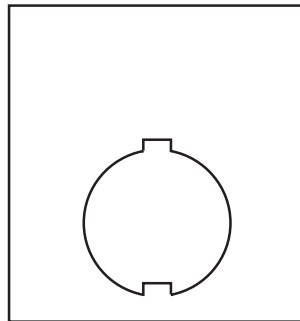

**LETTER SIZE** ✓

3/32 inch (2.4 mm)	
1/8 inch (3.2 mm)	
3/16 inch (4.8 mm)	

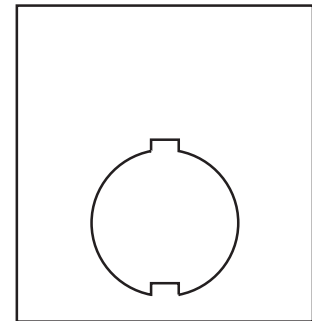

**LETTER SIZE** ✓

3/32 inch (2.4 mm)	
1/8 inch (3.2 mm)	
3/16 inch (4.8 mm)	

#### 1

### Renewal Parts

#### Type N Renewal Parts

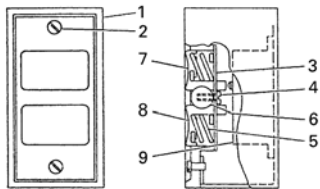

One and Two Element Station

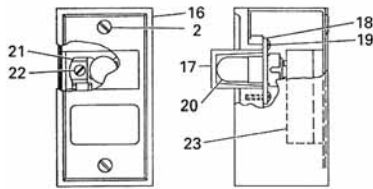

One Element Indicating Light

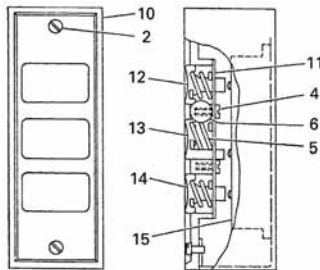

Three Element Station

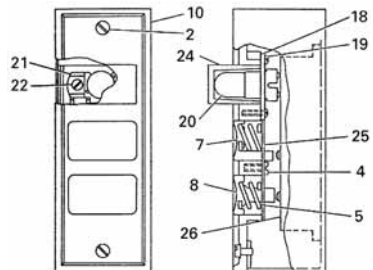

Two Element Station with Indicating Light



Open Type Two Element

#### Assembled Stations—Type N

Item No.	Description	No. Req.	Part Number
<b>Type N—Square Buttons</b>			
1	Cover	1	
	Two element		49-3524
	One element—top button		49-3524-2
	One element—bottom button		49-3524-3
2	Cover screw	2	11-2168
3	Pushbutton support bracket	1	79-6649
4	Pushbutton support bracket screw	1	11-2090
5	Pushbutton spring	2	69-2571
6	Disc (when used—two element assembly)	2	16-1960
7	Pushbutton—top position	1	
	START/green		53-1169-3
	RAISE/black		53-1169-66
	FORWARD/black		53-1169-7
	OPEN/black		53-1169-9
	UP/blank		53-1169-11
	Blank/green		53-1169
8	Pushbutton—bottom position	1	
	STOP/red		53-1202-2
	Extended STOP/red		53-1202-5
	REVERSE/black		53-1169-8
	CLOSE/black		53-1169-10
	DOWN/black		53-1169-12
	LOWER/black		53-1169-6
	Blank/red		53-1202

Item No.	Description	No. Req.	Part Number
<b>Type N—Square Buttons, continued</b>			
9	Pushbutton element	1	
	1NO-1NC		86-2588
	2NO		86-2588-2
	1NO		86-2588-3
	1NC		86-2588-4
10	Cover	1	49-3464
11	Pushbutton support bracket	1	79-6650
12	Pushbutton—top position	1	
	FORWARD/black		53-1170-7
	UP/black		53-1170-4
	RAISE/black		53-1170-5
	OPEN/black		53-1170-9
	FAST/black		53-1170-6
13	Pushbutton middle position	1	
	REVERSE/black		53-1169-15
	DOWN/black		53-1169-18
	LOWER/black		53-1169-16
	CLOSE/black		53-1169-17
	SLOW/black		53-1169-13
14	Pushbutton—bottom position	1	
	STOP/red		53-1201-2
15	Pushbutton element	1	
	2NO-3NC		86-2593
16	Cover	1	49-3524-4

### Assembled Stations—Type N, continued

Item No.	Description	No. Req.	Part Number
<b>Type N—Square Buttons, continued</b>			
17	Lens	1	
	Clear		28-494
	Red		28-887-2
	Amber		28-887-3
18	Shield	1	73-1337
19	Shield screws	4	11-2012
20	Lamp (neon NE48)	1	28-494
21	Lamp receptacle	1	28-902
22	Lamp receptacle screw	1	911-330F1
23	Pilot light terminal base	1	86-2586
24	Lens	1	
	Clear		28-887
	Red		28-887-2
	Amber		28-887-3
25	Pushbutton support bracket	1	79-6650-2
26	Pushbutton element	1	
	1NO-1NC		86-2594

Item No.	Description	No. Req.	Part Number
<b>Type N—Round Buttons</b>			
Similar to 27	Pushbutton assembly and element for:		
	10250H289	1	10250H2538
	10250H364	1	86-353
	10250H685	1	86-353-8
	10250H665	1	86-353-8
	10250H671	1	86-353
	10250H2738	1	86-353-3
	10250H2740	1	86-356
	10250H2741	1	86-356
	10250H2742	1	86-356

### Type H Renewal Parts

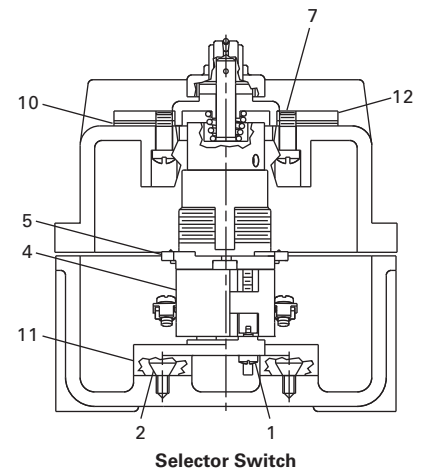
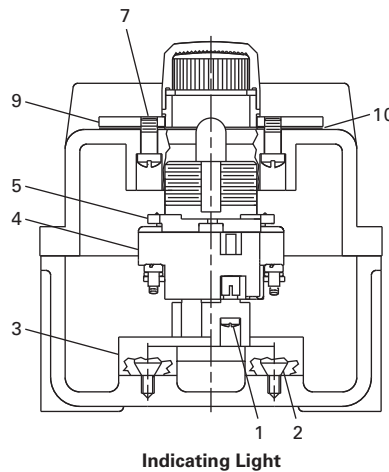
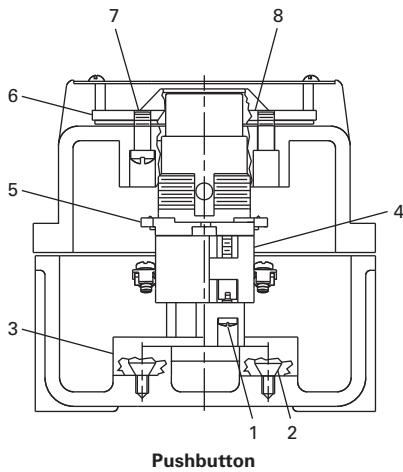

### Assembled Stations—Type H

Item No.	Description	No. Req.	Part Number
<b>Type H—Assembled Stations</b>			
1	Screw	2	11-4654
2	Screw	2	11-5719
3	Base	1	17-16560
4	Contact blocks	See Page V7-T1-245	
5	10250T operator	See Pages V7-T1-198 to V7-T1-235	
6	Mounting plate	1	17-19524

Item No.	Description	No. Req.	Part Number
<b>Type H—Assembled Stations</b>			
7	Screw	4	11-953
8	Diaphragm	1	32-253-2
9	Mounting plate	1	17-19522
10	Gasket	1	32-254
11	Base	1	17-16561
12	Mounting plate	1	17-19523



## Technical Data and Specifications

### Ratings

#### Maximum Ampere Ratings for Type N Control Stations

Description	Volts AC				Volts DC		
	110	220	440	550	120	240	600
Make and emergency interrupt capacity	30	15	7.5	6	1.0	0.5	0.1
Normal load break	3	1.5	0.75	0.6	1.0	0.5	0.1
Continuous current	10	10	10	10	10	10	10

#### Maximum Ampere Ratings for Type H Control Stations

Description	Volts AC 50/60 Hz				Volts DC	
	120	240	480	600	125	250
Make and emergency interrupt capacity	60	30	15	12	1.1	0.55
Normal load break	6	3	1.5	1.2	1.1	0.55
Continuous amperes	10	10	10	10	10	10
Voltamperes —						
Make and emergency interrupt capacity	7200	7200	7200	7200	138	138
Normal load break	720	720	720	720	138	138

### Dimensions

Approximate Dimensions in Inches (mm)

#### Type N Control Stations

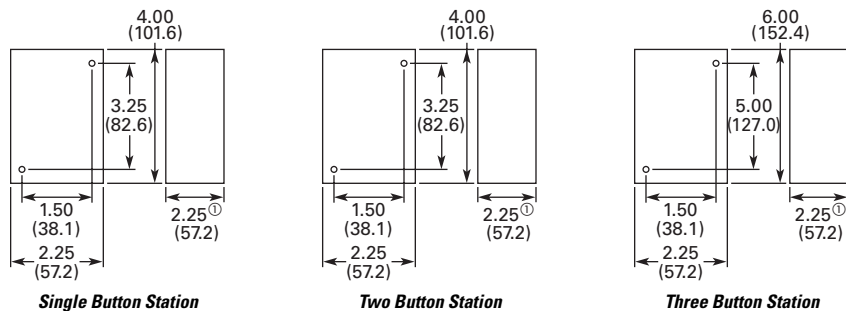

#### Special Purpose Control Stations

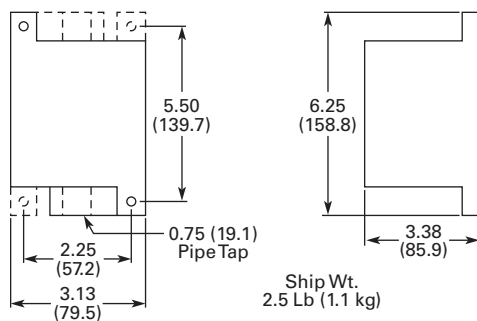

#### Note

⊙ 2.38 (60.5) for neon indicating light.

Approximate Dimensions in Inches (mm)

### Type H Control Stations

#### NEMA Type 3, 3R, 3S, 4, 4X, 13

No. of Elements	Dimensions		
	Wide	High	Deep
1 and 2	4.50 (114.3)	8.25 (209.6)	4.50 (114.3)
3	4.50 (114.3)	10.75 (273.1)	4.25 (108.0)

### 10250T and E34

#### Approximate Enclosure Dimensions

Number of Elements	Surface Mounting Dimensions in In (mm)			Mounting D	Mounting E	Conduit Entrance
	Wide A	High B	Deep C			
<b>Cast</b>						
1	3.88 (98.6)	4.00 (101.6)	3.00 (76.3)	2.69 (68.3)	3.25 (82.6)	3/4
2	3.88 (98.6)	5.88 (149.4)	3.00 (76.3)	2.69 (68.3)	5.13 (130.3)	3/4
3	3.88 (98.6)	7.75 (196.9)	3.00 (76.3)	2.69 (68.3)	7.00 (177.8)	1
4	33.88 (98.6)	9.63 (244.6)	3.00 (76.3)	2.69 (68.3)	8.88 (225.6)	1
<b>Polyester</b>						
1	3.81 (96.8)	6.63 (168.4)	3.38 (85.9)	2.94 (74.7)	4.88 (124.0)	①
2	3.81 (96.8)	6.63 (168.4)	3.38 (85.9)	2.94 (74.7)	4.88 (124.0)	①
3	3.81 (96.8)	8.88 (225.6)	3.38 (85.9)	2.94 (74.7)	7.13 (181.1)	①
4	3.81 (96.8)	6.63 (168.4)	3.38 (85.9)	2.94 (74.7)	4.88 (124.0)	①
<b>Stainless Steel</b>						
1	3.00 (76.2)	3.50 (88.9)	3.00 (76.2)	1.50 (38.1)	4.25 (108.0)	①
2	3.50 (88.9)	6.75 (171.5)	3.00 (76.2)	1.50 (38.1)	7.50 (190.5)	①
3	3.50 (88.9)	9.00 (228.6)	3.00 (76.2)	1.50 (38.1)	9.00 (228.6)	①
4	3.50 (88.9)	11.25 (285.8)	3.00 (76.2)	1.50 (38.1)	12.00 (304.8)	①

#### Note

① No conduit entrance holes provided. Drill as required.

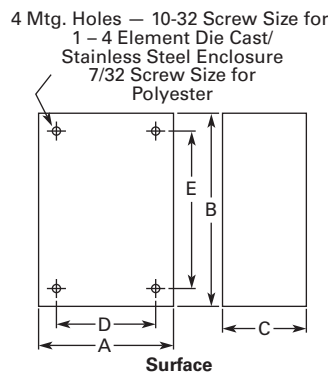



### Contents

<i><b>Description</b></i>	<i><b>Page</b></i>
16.2 mm Pushbuttons—RMQ-16	
Product Selection Guide . . . . .	<b>V7-T1-31</b>
Pushbuttons—Non-Illuminated and Illuminated . . . . .	<b>V7-T1-32</b>
Indicating Lights . . . . .	<b>V7-T1-34</b>
Emergency Stops . . . . .	<b>V7-T1-35</b>
Selector Switches—Non-Illuminated, Illuminated and Keyed . . . . .	<b>V7-T1-36</b>
Accessories . . . . .	<b>V7-T1-40</b>
Technical Data and Specifications . . . . .	<b>V7-T1-43</b>
Dimensions . . . . .	<b>V7-T1-45</b>

### Product Overview

#### Product Description

The RMQ-16 pushbutton line offers a wide array of functional and attractively designed illuminated and non-illuminated pushbuttons, selector switches, emergency stops and indicating lights. The illuminated line is offered with either incandescent or LED. RMQ-16 devices are designed with two front-of-panel operator sizes. The 18 x 18 mm or 25 x 25 mm square operators can help the user achieve over three times the information density compared with 22 mm ranges.

#### Features

- *Wide product breadth:* RMQ-16 offers illuminated and non-illuminated pushbuttons, keyed, non-keyed, and illuminated selector switches, emergency stops, and a large variety of accessories
- *Custom laser etching:* Hundreds of standard markings available in addition to infinite possible custom images with laser etching
- *High durability:* Pushbuttons and selector switches rated for 3 million mechanical operations
- *High information density:* Square operators (18 mm or 25 mm) allow for side-by-side mounting and achieve over three times the information density of typical 22 mm installations

#### Standards and Certifications

- UL Listed
- CSA Certified
- IEC/EN 60947-5 VDE-0660
- IP65



**Product Selection Guide**

**Pushbuttons**

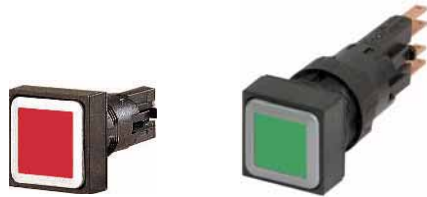

<b>Description</b>	Non-Illuminated	Illuminated
<b>Product Selection</b>	<b>Page V7-T1-32</b>	<b>Page V7-T1-33</b>

**Indicating Lights**



<b>Description</b>	Flush	Extended
<b>Product Selection</b>	<b>Page V7-T1-34</b>	<b>Page V7-T1-34</b>

**Emergency Stops**



<b>Description</b>	Non-Illuminated	Illuminated
<b>Product Selection</b>	<b>Page V7-T1-35</b>	<b>Page V7-T1-35</b>

**Selector Switches**



<b>Description</b>	Non-Illuminated	Illuminated	Keyed
<b>Product Selection</b>	<b>Page V7-T1-36</b>	<b>Page V7-T1-37</b>	<b>Page V7-T1-38</b>

#### 1 Pushbuttons—Non-Illuminated and Illuminated

##### Catalog Number Selection

Catalog Number Selection is for illustrative purposes only and not to be used to create new catalog numbers.

##### Pushbuttons—Non-Illuminated and Illuminated

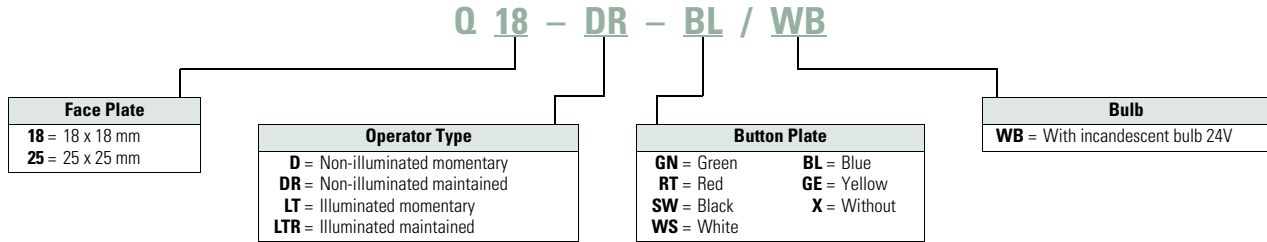

##### Product Selection

###### Non-Illuminated Pushbuttons

- Momentary or maintained
- Customizable laser etched pushbutton operators
- 18 mm or 25 mm square operator
- 3 million mechanical operations
- IEC/EN 60947-5
- IP65

###### Q18-D-GN



##### Non-Illuminated Pushbuttons

Type	Button Color	Catalog Number	
		18 x 18 mm	25 x 25 mm
Momentary	Green	<b>Q18D-GN</b>	<b>Q25D-GN</b>
	Red	<b>Q18D-RT</b>	<b>Q25D-RT</b>
	Black	<b>Q18D-SW</b>	<b>Q25D-SW</b>
	White	<b>Q18D-WS</b>	<b>Q25D-WS</b>
	Blue	<b>Q18D-BL</b>	<b>Q25D-BL</b>
	Yellow	<b>Q18D-GE</b>	<b>Q25D-GE</b>
	Without	<b>Q18D-X</b> ①	<b>Q25D-X</b> ①
Maintained	Green	<b>Q18DR-GN</b>	<b>Q25DR-GN</b>
	Red	<b>Q18DR-RT</b>	<b>Q25DR-RT</b>
	Black	<b>Q18DR-SW</b>	<b>Q25DR-SW</b>
	White	<b>Q18DR-WS</b>	<b>Q25DR-WS</b>
	Blue	<b>Q18DR-BL</b>	<b>Q25DR-BL</b>
	Yellow	<b>Q18DR-GE</b>	<b>Q25DR-GE</b>
	Without	<b>Q18DR-X</b> ①	<b>Q25DR-X</b> ①

###### Note

① To order separate button plates, see **Page V7-T1-42**.

**Illuminated Pushbuttons**

- Momentary or maintained
- LED or incandescent
- 18 mm or 25 mm square operator
- 3 million mechanical operations
- IEC/EN 60947-5
- IP65

**Q18-LT-GE**



**Illuminated Pushbuttons Without Bulb** ①

Type	Button Color	Catalog Number ②	
		18 x 18 mm	25 x 25 mm
Momentary	Green	<b>Q18LT-GN</b>	<b>Q25LT-GN</b>
	Red	<b>Q18LT-RT</b>	<b>Q25LT-RT</b>
	Black	<b>Q18LT-SW</b>	<b>Q25LT-SW</b>
	White	<b>Q18LT-WS</b>	<b>Q25LT-WS</b>
	Blue	<b>Q18LT-BL</b>	<b>Q25LT-BL</b>
	Yellow	<b>Q18LT-GE</b>	<b>Q25LT-GE</b>
Maintained	Green	<b>Q18LTR-GN</b>	<b>Q25LTR-GN</b>
	Red	<b>Q18LTR-RT</b>	<b>Q25LTR-RT</b>
	Black	<b>Q18LTR-SW</b>	<b>Q25LTR-SW</b>
	White	<b>Q18LTR-WS</b>	<b>Q25LTR-WS</b>
	Blue	<b>Q18LTR-BL</b>	<b>Q25LTR-BL</b>
	Yellow	<b>Q18LTR-GE</b>	<b>Q25LTR-GE</b>

**Notes**

- ① To order with incandescent 24V bulb, insert a **/WB** at the end of the catalog number. Example, Q18LT-GN/**WB**.
- ② For a complete selection of incandescent 24V bulbs and LEDs, see **Page V7-T1-40**.

#### 1

### Indicating Lights

#### Catalog Number Selection

Catalog Number Selection is for illustrative purposes only and not to be used to create new catalog numbers.

#### Indicating Lights—Flush and Extended

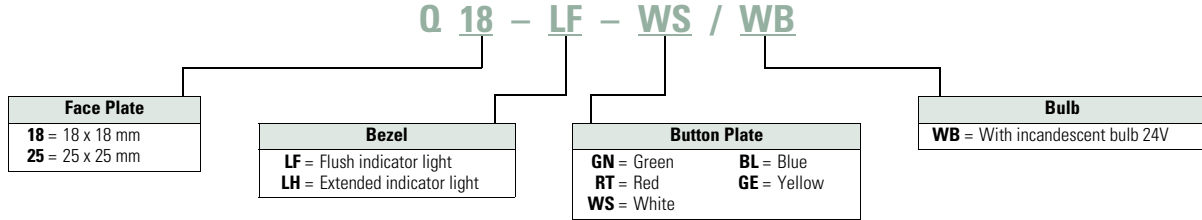



#### Product Selection

##### Indicating Lights

- LED or incandescent
- Flush and extended lenses
- 18 mm or 25 mm square operator
- 3 million mechanical operations
- IEC/EN 60947-5
- IP65

#### Indicating Lights Without Bulb ①

	Type	Button Color	Catalog Number ②	
			18 x 18 mm	25 x 25 mm
<b>Q18-LF-GE</b> 	Flush	Green	<b>Q18LF-GN</b>	<b>Q25LF-GN</b>
		Red	<b>Q18LF-RT</b>	<b>Q25LF-RT</b>
		White	<b>Q18LF-WS</b>	<b>Q25LF-WS</b>
		Blue	<b>Q18LF-BL</b>	<b>Q25LF-BL</b>
		Yellow	<b>Q18LF-GE</b>	<b>Q25LF-GE</b>
<b>Q18-LH-BL</b> 	Extended	Green	<b>Q18LH-GN</b>	<b>Q25LH-GN</b>
		Red	<b>Q18LH-RT</b>	<b>Q25LH-RT</b>
		White	<b>Q18LH-WS</b>	<b>Q25LH-WS</b>
		Blue	<b>Q18LH-BL</b>	<b>Q25LH-BL</b>
		Yellow	<b>Q18LH-GE</b>	<b>Q25LH-GE</b>

#### Notes

- ① To order with incandescent 24V bulb, insert a /WB at the end of the catalog number. Example, Q18-LF-GN/WB.  
 ② For a complete selection of incandescent 24V bulbs and LEDs, see **Page V7-T1-40**.

**Emergency Stops**

**Catalog Number Selection**

Catalog Number Selection is for illustrative purposes only and not to be used to create new catalog numbers.

**Emergency Stops—Non-Illuminated and Illuminated**

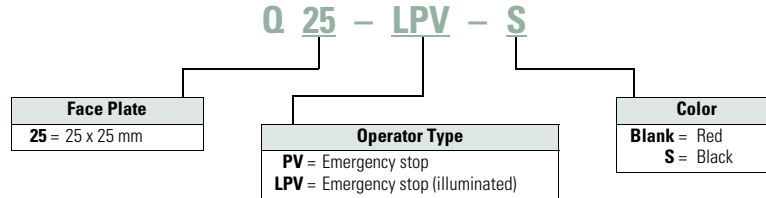

**Product Selection**

**Emergency Stops**

- Push/pull operation
- Illuminated or non-illuminated
- Emergency stop (red) or Machine stop (black) available
- Suitable for use in safety applications
- IEC/EN 60947-5
- IP65

**Q25PV**



**Emergency Stops—Non-Illuminated**

Button Color	Catalog Number
Red	<b>Q25PV</b>
Black	<b>Q25PV-S</b>

**Q25LPV**



**Emergency Stops—Illuminated** <sup>①</sup>

Button Color	Catalog Number
Red	<b>Q25LPV</b>
Black	<b>Q25LPV-S</b>

**Note**  
<sup>①</sup> Includes built-in multiple LED 24 Vdc.



#### 1

### Selector Switches—Non-Illuminated, Illuminated and Keyed

#### Catalog Number Selection

Catalog Number Selection is for illustrative purposes only and not to be used to create new catalog numbers.

#### Selector Switches—Non-Illuminated

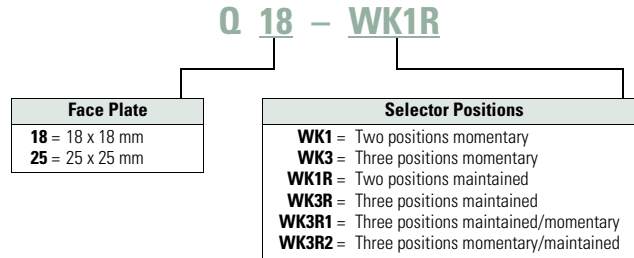

#### Product Selection

##### Non-Illuminated Selector Switches

- Momentary or maintained
- 18 mm or 25 mm square operator
- VS Anti-rotation feature
- 3 million mechanical operations
- IP65

**Q18WK1**



#### Selector Switches—Non-Illuminated

Function	Position	Switch Position	Catalog Number	
			18 x 18 mm	25 x 25 mm
Momentary	2		<b>Q18WK1</b>	<b>Q25WK1</b>
Maintained			<b>Q18WK1R</b>	<b>Q25WK1R</b>
Momentary	3		<b>Q18WK3</b>	<b>Q25WK3</b>
Maintained			<b>Q18WK3R</b>	<b>Q25WK3R</b>
Maintained/momentary			<b>Q18WK3R1</b>	<b>Q25WK3R1</b>
Momentary/maintained			<b>Q18WK3R2</b>	<b>Q25WK3R2</b>

**Catalog Number Selection**

Catalog Number Selection is for illustrative purposes only and not to be used to create new catalog numbers.

**Selector Switches—Illuminated**

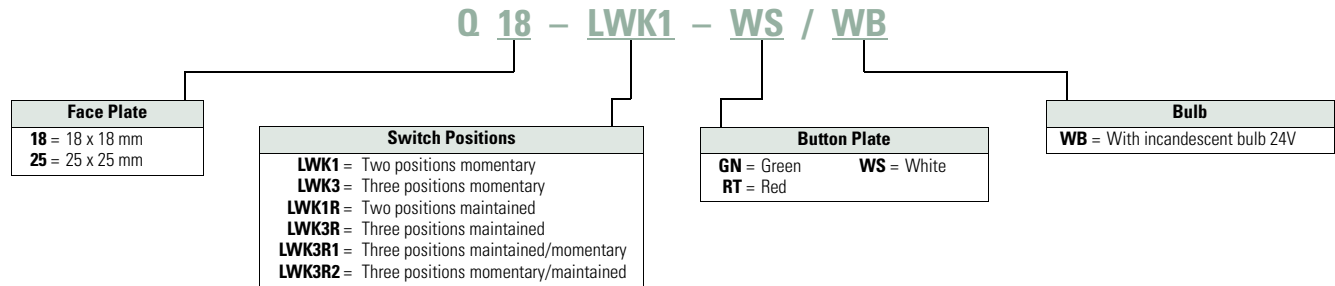

**Product Selection**

**Illuminated Selector Switches**

- LED or incandescent
- Momentary or maintained
- 18 mm or 25 mm square operator
- VS Anti-rotation feature
- 3 million mechanical operations
- IP65

Q18LWK1-GN



**Selector Switches—Illuminated without Bulb ①**

Function	Position	Button Color	Switch Position	Catalog Number ②	
				18 x 18 mm	25 x 25 mm
Momentary	2	Green		<b>Q18LWK1-GN</b>	<b>Q25LWK1-GN</b>
		Red		<b>Q18LWK1-RT</b>	<b>Q25LWK1-RT</b>
		White		<b>Q18LWK1-WS</b>	<b>Q25LWK1-WS</b>
Maintained		Green		<b>Q18LWK1R-GN</b>	<b>Q25LWK1R-GN</b>
		Red		<b>Q18LWK1R-RT</b>	<b>Q25LWK1R-RT</b>
		White		<b>Q18LWK1R-WS</b>	<b>Q25LWK1R-WS</b>
Momentary	3	Green		<b>Q18LWK3-GN</b>	<b>Q25LWK3-GN</b>
		Red		<b>Q18LWK3-RT</b>	<b>Q25LWK3-RT</b>
		White		<b>Q18LWK3-WS</b>	<b>Q25LWK3-WS</b>
Maintained		Green		<b>Q18LWK3R-GN</b>	<b>Q25LWK3R-GN</b>
		Red		<b>Q18LWK3R-RT</b>	<b>Q25LWK3R-RT</b>
		White		<b>Q18LWK3R-WS</b>	<b>Q25LWK3R-WS</b>
Maintained/ momentary		Green		<b>Q18LWK3R1-GN</b>	<b>Q25LWK3R1-GN</b>
		Red		<b>Q18LWK3R1-RT</b>	<b>Q25LWK3R1-RT</b>
		White		<b>Q18LWK3R1-WS</b>	<b>Q25LWK3R1-WS</b>
Momentary/ maintained		Green		<b>Q18LWK3R2-GN</b>	<b>Q25LWK3R2-GN</b>
		Red		<b>Q18LWK3R2-RT</b>	<b>Q25LWK3R2-RT</b>
		White		<b>Q18LWK3R2-WS</b>	<b>Q25LWK3R2-WS</b>

**Notes**

- ① To order with incandescent 24V bulb, insert a /WB at the end of the catalog number. Example, Q18LWK1-GN/WB.
- ② For a complete selection of incandescent 24V bulbs and LEDs, see Page V7-T1-40.

# 1.4

## Pushbuttons and Indicating Lights

### 16.2 mm Pushbuttons—RMQ-16

1

#### Catalog Number Selection

Catalog Number Selection is for illustrative purposes only and not to be used to create new catalog numbers.

#### Keyed Selector Switches—Two- and Three-Position

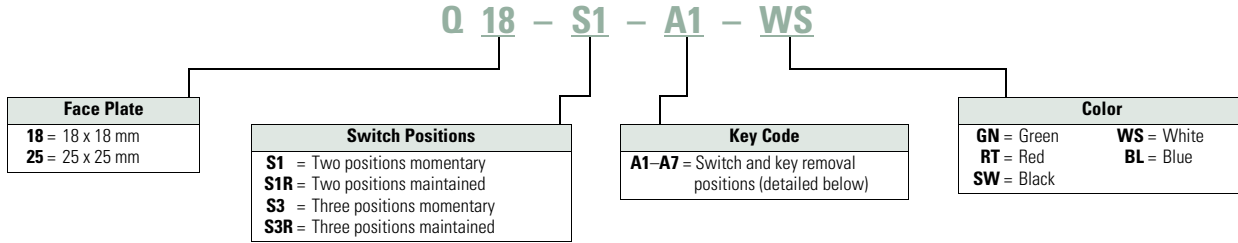

#### Product Selection

##### Keyed Selector Switches

- 5 color options
- Momentary or maintained
- 18 mm or 25 mm square operator
- VS Anti-rotation feature
- 3 million mechanical operations
- IP65

Q18S1



#### Keyed Selector Switches—Two-Position

Function	Button Color	Switch Position	Key Removal Position ①	Catalog Number	
				18 x 18 mm	25 x 25 mm
Momentary	Black		0	<b>Q18S1</b>	<b>Q25S1</b>
Maintained	Black		0	<b>Q18S1R</b>	<b>Q25S1R</b>
Maintained	Black		0	<b>Q18S1R-A1</b>	<b>Q25S1R-A1</b>

#### Keyed Selector Switches—Three-Position

Function	Button Color	Switch Position	Key Removal Position ①	Catalog Number	
				18 x 18 mm	25 x 25 mm
Momentary	Black		0	<b>Q18S3</b>	<b>Q25S3</b>
Maintained			0, II	<b>Q18S3R</b>	<b>Q25S3R</b>
Maintained			0	<b>Q18S3R-A1</b>	<b>Q25S3R-A1</b>
			I, 0	<b>Q18S3R-A2</b>	<b>Q25S3R-A2</b>
			0, II	<b>Q18S3R-A3</b>	<b>Q25S3R-A3</b>
Maintained/momentary			I, 0	<b>Q18S3R-A4</b>	<b>Q25S3R-A4</b>
			0	<b>Q18S3R-A5</b>	<b>Q25S3R-A5</b>
Momentary/maintained			0, II	<b>Q18S3R-A6</b>	<b>Q25S3R-A6</b>
			0	<b>Q18S3R-A7</b>	<b>Q25S3R-A7</b>

##### Note

- ① I = Key is removed at the left.
- 0 = Key is removed at the center.
- II = Key is removed at the right.

**Q18S1-BL**

**Keyed Selector Switches, Multicolor—Two-Position**



Function	Button Color	Switch Position	Key Removal Position ①	Catalog Number	
				18 x 18 mm	25 x 25 mm
Momentary	Green		0	<b>Q18S1-GN</b>	<b>Q25S1-GN</b>
	Red			<b>Q18S1-RT</b>	<b>Q25S1-RT</b>
	White			<b>Q18S1-WS</b>	<b>Q25S1-WS</b>
	Blue			<b>Q18S1-BL</b>	<b>Q25S1-BL</b>
Maintained	Green		0	<b>Q18S1R-GN</b>	<b>Q25S1R-GN</b>
	Red			<b>Q18S1R-RT</b>	<b>Q25S1R-RT</b>
	White			<b>Q18S1R-WS</b>	<b>Q25S1R-WS</b>
	Blue			<b>Q18S1R-BL</b>	<b>Q25S1R-BL</b>

**Q18S3-RT**

**Keyed Selector Switches, Multicolor—Three-Position**



Function	Button Color	Switch Position	Key Removal Position ①	Catalog Number	
				18 x 18 mm	25 x 25 mm
Momentary	Green		0	<b>Q18S3-GN</b>	<b>Q25S3-GN</b>
	Red			<b>Q18S3-RT</b>	<b>Q25S3-RT</b>
	White			<b>Q18S3-WS</b>	<b>Q25S3-WS</b>
	Blue			<b>Q18S3-BL</b>	<b>Q25S3-BL</b>
Maintained	Green		0, II	<b>Q18S3R-GN</b>	<b>Q25S3R-GN</b>
	Red			<b>Q18S3R-RT</b>	<b>Q25S3R-RT</b>
	White			<b>Q18S3R-WS</b>	<b>Q25S3R-WS</b>
	Blue			<b>Q18S3R-BL</b>	<b>Q25S3R-BL</b>

**Note**

- ① I = Key is removed at the left.
- 0 = Key is removed at the center.
- II = Key is removed at the right.

## Accessories

### E10



### Contact Elements

Feature	Catalog Number
Normally open (N/O)	E10

### E01



Normally closed (N/C)	E01
-----------------------	-----

### SRA10



### Screw Adapter

Feature	Catalog Number
Normally open (N/O)	SRA10
Normally closed (N/C)	SRA01
Lamp sockets	SRAL

### WBGL6



### Incandescent 24V Bulbs

Voltage	Current	Color	Catalog Number
6V	1W	White	WBGL6
12V			WBGL12
24–28V			WBGL24

### WBLED-GN6



### LEDs (AC/DC)

Voltage	Current	Color	Catalog Number
<b>Multiple Chip LED</b>			
6V	45 mA	Green	WBLED-GN6
12V	24 mA		WBLED-GN12
6V	45 mA	Red	WBLED-RT6
12V	24 mA		WBLED-RT12
6V	45 mA	Yellow	WBLED-GE6
12V	24 mA		WBLED-GE12
<b>Single Chip LED</b> ①			
18–30V	7–12.5 mA	Green	LEDWB-G
		Red	LEDWB-R
		White	LEDWB-W
		Blue	LEDWB-B
		Yellow	LEDWB-Y

### ISH2,8



### Insulated Ferrule

Description	Catalog Number
Insulated ferrule	ISH2,8

### R16-MS



### Combination Box Spanner

Description	Catalog Number
Mounting ring tool	16-MS

### VS



### Anti-Rotation Tab

Description	Catalog Number
Guard ring	VS

### E8-SW



### Housing

Description	Color	Catalog Number
Surface mount enclosure	White	I8
Flush mount panel	White	E8
	Black	E8-SW

### Q18BS



### Blanking Plug

Size	Catalog Number
18 x 18 mm	Q18BS
25 x 25 mm	Q25BS

### Q25AGR



### Cover Plate

Size	Color	Catalog Number
25 x 38 mm	Black	Q25AS
	Gray	Q25AGR

### Note

① Positive pole to X1. Integral suppressor circuit up to 1000V.

**Q2SQ25**

**Insert Plate**



Size		Catalog Number
10 x 22 mm	BLANK	<b>Q2SQ25</b>

**Q25TS-X**

**Legend Plate**



Size	Color	Catalog Number
25 x 38 mm	Black	<b>Q25TS-X</b>
	Gray	<b>Q25TGR-X</b>

**Q25TS\_**

**Legend Plate—Complete**



Size	Etching	Catalog Number
25 x 38	START	<b>Q25TS-111</b>
	STOP	<b>Q25TS-110</b>
	FAULT	<b>Q25TS-250</b>
	HAND 0 AUTO	<b>Q25TS-197</b>
	MAN 0 AUTO	<b>Q25TS-397</b>
	0	<b>Q25TS-10</b>
	I	<b>Q25TS-11</b>
	0 I	<b>Q25TS-90</b>
	I 0 II	<b>Q25TS-93</b>

**SQT11**

**Emergency Stop Labels**



Type	Feature	Catalog Number
Square	4 Languages	<b>SQT11</b>
	Blank	<b>SQT-GE</b>

**SRT11**



Circle	4 Languages	<b>SRT11</b>
	Blank	<b>SRT-GE</b>

**Extra Keys**

**ES16**



**Codes for Extra Keys**

Color	Catalog Number
Green	<b>ES16-GN</b>
Red	<b>ES16-RT</b>
Black	<b>ES16</b>
White	<b>ES16-WS</b>
Blue	<b>ES16-BL</b>

**Button Plates**



**Button Plates**

Type	Color	Etching	Catalog Number
18 x 18 mm	Black	—	<b>01TQ18</b>
		CUSTOM	<b>01TQ18-ETCH</b>
			<b>21TQ18</b>
			<b>19TQ18</b>
	White	—	<b>02TQ18</b>
		CUSTOM	<b>02TQ18-ETCH</b>
			<b>20TQ18</b>
	Green	—	<b>03TQ18</b>
		CUSTOM	<b>03TQ18-ETCH</b>
			<b>11TQ18</b>
	Red	—	<b>04TQ18</b>
		CUSTOM	<b>04TQ18-ETCH</b>
			<b>10TQ18</b>
	Yellow	—	<b>05TQ18</b>
		CUSTOM	<b>05TQ18-ETCH</b>
	Blue	—	<b>06TQ18</b>
CUSTOM		<b>06TQ18-ETCH</b>	

Type	Color	Etching	Catalog Number
25 x 25 mm	Black	—	<b>01TQ25</b>
		CUSTOM	<b>01TQ25-ETCH</b>
			<b>21TQ25</b>
			<b>19TQ25</b>
	White	—	<b>02TQ25</b>
		"STOP"	<b>112TQ25</b>
		"ON"	<b>221TQ25</b>
	White	—	<b>02TQ25</b>
		CUSTOM	<b>02TQ25-ETCH</b>
	Green		<b>20TQ25</b>
		—	<b>03TQ25</b>
		CUSTOM	<b>03TQ25-ETCH</b>
	Green	—	<b>03TQ25</b>
		CUSTOM	<b>03TQ25-ETCH</b>
		"START"	<b>111TQ25</b>
	Green		<b>11TQ25</b>
—		<b>11TQ25</b>	
Red	—	<b>04TQ25</b>	
	CUSTOM	<b>04TQ25-ETCH</b>	
	"STOP"	<b>110TQ25</b>	
Red		<b>10TQ25</b>	
	"OFF"	<b>217TQ25</b>	
Yellow	—	<b>05TQ25</b>	
	CUSTOM	<b>05TQ25-ETCH</b>	
Blue	—	<b>06TQ25</b>	
	CUSTOM	<b>06TQ25-ETCH</b>	

**Instructions for Ordering Laser Incriptions**

1. Identify part number to be inscribed.
2. Pick symbol from library and identify suffix code associated with the symbol.
3. Order part number already listed in the catalog with -ETCH suffix.
4. When placing an order by fax or Vistaline on the web, reference order item number and indicate appropriate symbol code or desired text.

**Example**

To order a 25 mm green flush button plate with the inscription AUTO HAND:

Order Catalog Number **03TQ25-ETCH**.

AUTO HAND inscription is found on **Page V7-T1-133** in the M22 Symbols Library, suffix code is **X91**.

In the order notes, reference item number and suffix **X91**.

**Note:** For a complete list of available symbols, see **Pages V7-T1-130 to V7-T1-136**, M22 Symbols Library.

## Technical Data and Specifications

## RMQ-16

Description	Unit	Specification Contact Elements	Illuminated Pushbutton Operators (Maintained)	Illuminated Selector Switches	Indicating Lights
<b>General Technical Data</b>					
Standards					UL, CSA, IEC/EN 60 947, VDE 0660, CE
Lifespan, mechanical (operations)	x 10 <sup>5</sup>	100	30 (3)	3	—
Maximum operating frequency	Ops/h	3600	3600 (1800)	1800	—
Operating force	N	3	4	—	—
Operating torque	Nm		—	≤ 0.2	—
Degree of protection to IEC/EN 60 529		IP20 with ISH2,8	IP65	IP65	IP65
Climatic proofing			Damp heat, constant, to IEC 60 068-2-3/Damp heat, cyclical, to IEC 60 068-2-30		
Ambient temperature					
Open	°C	–25 to 60	–25 to 60	–25 to 60	–25 to 60
Enclosed	°C	–25 to 40	–25 to 40	–25 to 40	–25 to 40
Mounting position		As required	As required	As required	As required
Mechanical shock resistance to IEC 60 068-2-27 (half-sinusoidal shock, duration 11 ms)	g	40	40	40	40
Terminal capacity (min./max.)	mm <sup>2</sup>	0.5/1.0	0.5/1.0	0.5/1.0	0.5/1.0
Blade terminal			2.8 mm x 0.8 mm to DIN 46 244		
Ferrule			2.8 mm x 0.8 mm to DIN 46 247 and IEC 60 760		
Dimensions		See Page V7-T1-45	See Page V7-T1-45	See Page V7-T1-45	See Page V7-T1-45
<b>Contacts</b>					
Rated impulse withstand voltage $U_{imp}$	V	4000	800	800	800
Rated insulation voltage $U_i$	V	250	250	250	250
Overvoltage category/pollution degree		III/3	III/3	III/3	III/3
Rated operational voltage $U_e$ (max.)	V	250	24	24	24
Rated operational current $I_e$ (max.)	A	4	—	—	—
Control circuit reliability at 24 Vdc/5 mA (Fault probability Hr)			<10 <sup>-7</sup> , <1 fault in 10 <sup>7</sup> operations		
5 Vdc/1 mA (Fault probability Hr)			<5 x 10 <sup>-6</sup> , < fault in 5 x 10 <sup>6</sup> operations		
Use of insulated ferrule ISH 2.8					
From $U_e$		>24 Vac/dc recommended	>24 Vac/dc recommended	>24 Vac/dc recommended	>24 Vac/dc recommended
From $U_e$			>50 Vac or 120 Vdc is mandatory, even on unused blade terminals		
Maximum short-circuit protective device					
Fuseless	Type	FAZ-B6	—	—	—
Fuse	A gG/gL	10	—	—	—
<b>Switching Capacity</b>					
Rated operational current $I_e$					
AC-15					
24V	A	4	—	—	—
48V	A	4	—	—	—
110V	A	4	—	—	—
230V	A	4	—	—	—
DC-13					
24V	A	3	—	—	—
42V	A	1.0	—	—	—
60V	A	0.8	—	—	—
110V	A	0.5	—	—	—
220V	A	0.2	—	—	—
UL/CSA Data			UL listed File No. E 29 184, Guide No. NKCR/CSA certified File No. 46 552 Class No. 321103		
Blade terminal		0.110 x 0.032 in	0.110 x 0.032 in	0.110 x 0.032 in	0.110 x 0.032 in
Fast-on connector			0.110 x 0.032 in AMP #60 197-1, 62 050-1 or equivalent		
Rated voltage maximum AC	Vac	300	24	24	24
Contact rating code AC	E10/E01	C300/Q300	—	—	—
Thermal continuous test current	A	2.5	—	—	—
Rated voltage maximum DC	Vdc	300	—	—	—
Contact rating code DC	E10/E01	C300/R300	—	—	—
Thermal continuous test current	A	2.5	—	—	—



# 1.4

## Pushbuttons and Indicating Lights

### 16.2 mm Pushbuttons—RMQ-16

1

#### RMQ-16, continued

Description	Unit	Specification			Emergency Stop Operators	Emergency Stop Operators (Illuminated) ①
		Pushbutton Operators (Maintained)	Selector Switches	Key-Released Operators		
<b>General Technical Data</b>						
Standards					UL, CSA, IEC/EN 60 947, VDE 0660, CE	
Lifespan, mechanical (operations)	x 10 <sup>5</sup>	30 (3)	3	3	0.5	0.5
Maximum operating frequency	Ops/h	3600 (1800)	1800	1800	600	600
Operating force	N	4	—	—	25	25
Operating torque	Nm	—	≤ 0.2	≤ 0.4	—	—
Degree of protection to IEC/EN 60 529		IP65	IP65	IP65	IP65	IP65
Climatic proofing					Damp heat, constant, to IEC 60 068-2-3 Damp heat, cyclical, to IEC 60 068-2-30	
Ambient temperature						
Open	°C	–25 to 60	–25 to 60	–25 to 60	–25 to 60	–25 to 60
Enclosed	°C	–25 to 40	–25 to 40	–25 to 40	–25 to 40	–25 to 40
Mounting position		As required	As required	As required	As required	As required
Mechanical shock resistance to IEC 60 068-2-27 (half-sinusoidal shock, duration 11 ms)	g	40	40	40	40	40
Terminal capacity (min./max.)	mm <sup>2</sup>	—	—	—	—	0.5/1.0
Blade terminal		—	—	—	—	2.8 x 0.8 mm
Ferrule		—	—	—	—	2.8 x 0.8 mm
Dimensions		See Page V7-T1-45	See Page V7-T1-45	See Page V7-T1-45	See Page V7-T1-45	See Page V7-T1-45

#### Lifespan, Electrical AC-15 to IEC/EN 60 947-5-1 at 230V

$I_e$  = Rated operational current

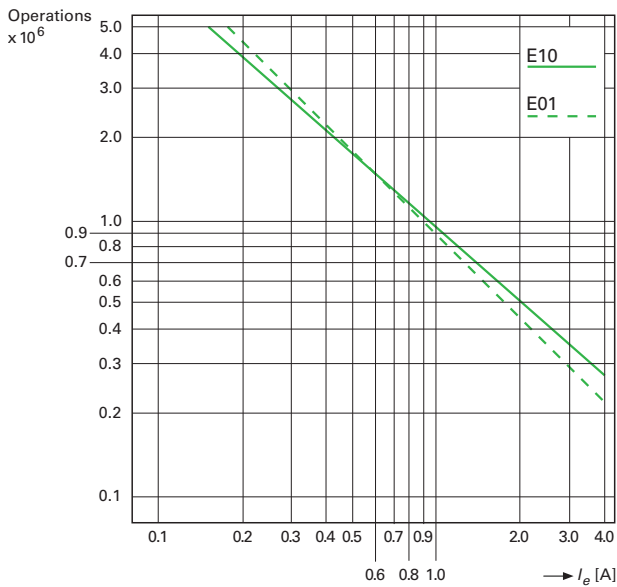

#### Note

① See illuminated selector switches on Page V7-T1-37 for contact values.

**Dimensions**

Approximate Dimensions in mm [in]

**Actuating and Indicator Elements**

**Square Style**

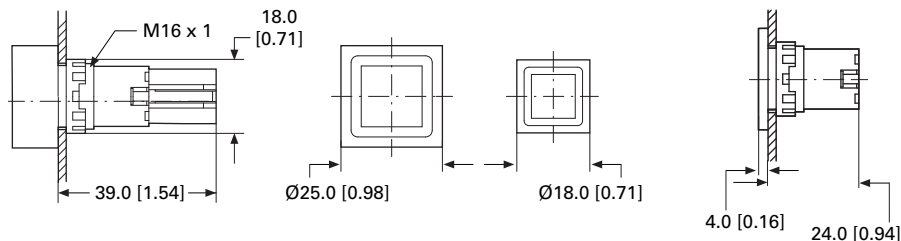

**Q...D-\_, Q...DR- \_**

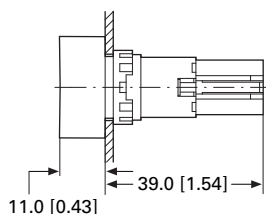

**Q...S\_**

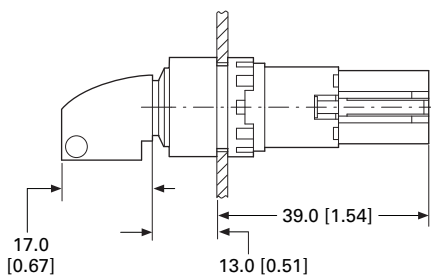

**Q...WK\_**

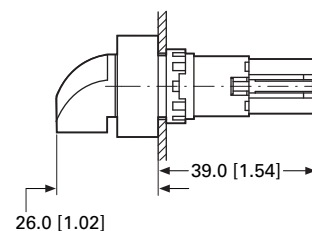

**Q...LT-\_, Q...LTR-\_, Q...LF- \_**

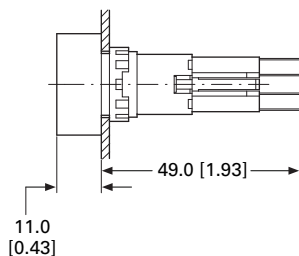

**Q...LH- \_**

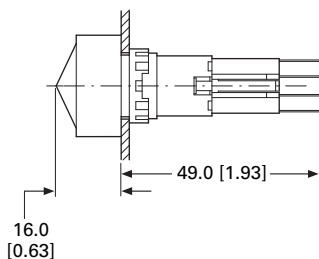

**Q...LWK\_**

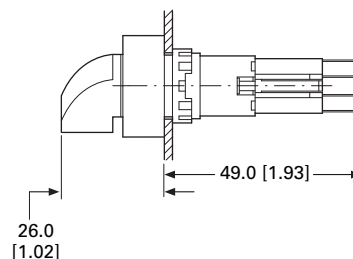

**Q25PV\_ , Q25LPV\_**

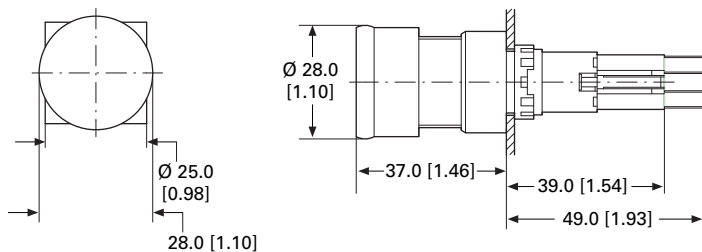

# 1.4

## Pushbuttons and Indicating Lights

### 16.2 mm Pushbuttons—RMQ-16

1

Approximate Dimensions in mm [in]

#### Front Fixing

**Q18, Q25, E89, SRA, VS, M16**

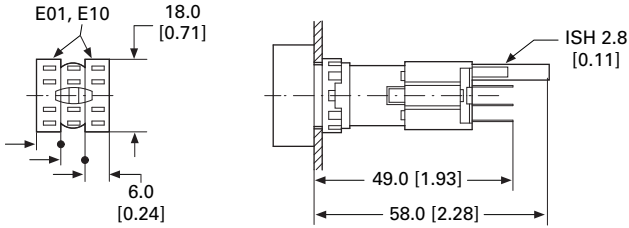

#### Drilling Dimensions

##### Drilling

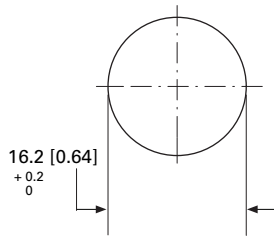

#### Grid Dimension to IEC/EN 60947

##### Q25

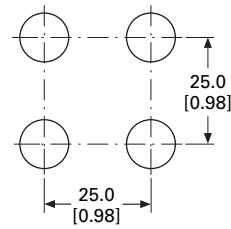

#### Minimum Grid Spacing Dimension

##### Q18

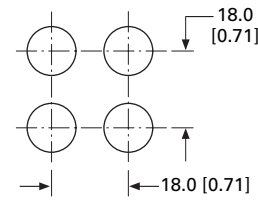

#### Mounting Distance

##### Mounting

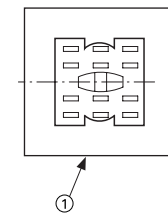

#### RMQ Screw Adapter

##### SRA\_

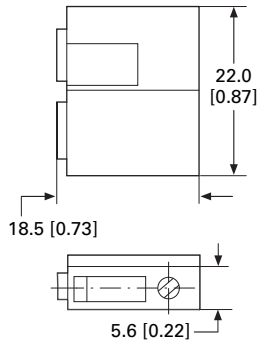

#### Anti-Rotation Feature

##### VS

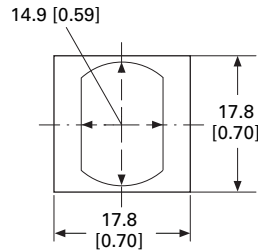

#### RMQ-16 Label Mount

##### Q25TS\_

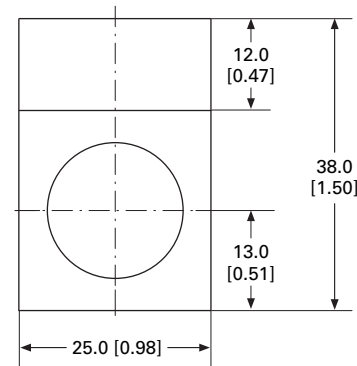

#### Blanking Plates

##### Q25AS

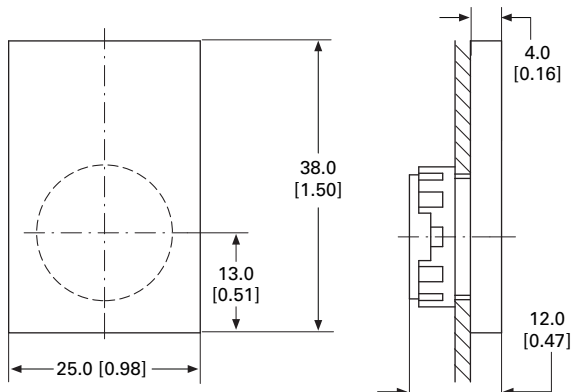

#### Note

① Exposed conductive part (metal).

22.5 mm RMQ-Titan Modular Pushbuttons—M22



### Contents

#### Description

	Page
22.5 mm RMQ-Titan Modular Pushbuttons—M22	
Product Selection Guide . . . . .	V7-T1-48
Accessories . . . . .	V7-T1-111
Coding Adapter Guide . . . . .	V7-T1-118
Technical Data and Specifications . . . . .	V7-T1-119
Dimensions . . . . .	V7-T1-123
Symbols Library. . . . .	V7-T1-129



### Product Description

Eaton's M22 industrial heavy-duty pushbutton line offers a wide array of functional, attractive and ergonomically designed illuminated and non-illuminated pushbuttons, selector switches, push-pulls, alternate action and twist-to-release operators. The complete illuminated line is only offered in LED light units to ensure high-quality brightness and up to 100,000 hours of LED illumination. M22 operators are available with either a silver or black nylon colored or chrome metal bezel. The space-saving modular construction of the M22 line makes on-the-job assembly fast and simplifies the stocking of both components and complete devices.

#### NEW

Eaton has expanded M22 pilot devices with a metal bezel option. The new M22M pushbutton is an elegant chrome metal bezel that is attractive, durable and rugged for heavy-duty environments. M22M devices are configurable and complement components within the M22 line.

### Highly Modular and Versatile Line

- Field convertible functions (pushbuttons and selector switches), maintained to momentary
- Customizable laser engraving capabilities

### LED Indicators

- 100,000 hours of life in high-vibration environments
- Lenses specifically designed for LED illumination
- Multi-color LED in the flat contact family allows versatility in design and reduces installation costs and footprint

### Rugged Design

- Most pushbutton operators and contact blocks exceed 5 million mechanical operations
- All components have IP66 rating, and some carry IP67 and IP69K for washdown environment; see **Page V7-T1-119** for further technical data

### Innovative Technologies

- ASi communicating devices
- Palm switches

### Standards and Certifications

All operators and components are IEC/EN 60947 VDE 0660.

All operators carry an IP66 rating with some rated for washdown environment with IP67 and IP69K.

All pushbuttons, emergency-stops, indicating lights, potentiometers and selector switches carry NEMA 4X, 13.

Marine classification societies: Bureau Veritas (BV), Germanischer Lloyd (GL), and Lloyd's Register of Shipping (LR) approved.



# 1.5

## Pushbuttons and Indicating Lights

### 22.5mm 22.5 mm RMQ-Titan Modular Pushbuttons—M22

1

#### Features

- Field convertible pushbuttons and mushroom operators from maintained to momentary status
- Field convertible selector switches from momentary to maintained operation and vice versa
- LED offering only for all illuminated operators
- Laser engraved pushbuttons, lenses and enclosures
- Heavy-duty construction with a minimum of IP66 and UL NEMA® type 4X / 13 on front of panel operators. Many operators even carry IP67 and IP69K, for the toughest applications
- Silver, black or chrome metal bezel now available
- Snap-lock contact blocks and light units for front or base mounting
- Notched hole mounting with anti-rotation tab and central nut mounting on each operator
- Over 5 million mechanical operations and 1.6 million electrical (reference specification sheet)
- Direct opening action normally closed contacts
- Unique and innovative offerings, such as four-way pushbuttons and USB/ RJ45 bulkhead interfaces
- Screw or spring-cage terminals

#### Benefits

- Modular construction makes assembly fast and simplifies stocking of components and complete devices
- Field convertibility of operator status for pushbuttons and selector switches helps distributors and customers reduce inventory and increase functionality
- LED offering only for improved brightness quality and up to 100,000 hours of operation
- Plastic construction is corrosion resistant. Operators are designed for rugged environments, ideal for washdown applications (reference each operator's IP ratings and IEC/EN 60529 for ingress protection definition)
- Anti-rotation tab saves installation time and prevents operator rotation
- High mechanical and electrical life allows for use in tough and challenging applications
- Laser inscription capabilities allow for high-quality, wear-resistant markings
- All normally closed (NC) contacts are direct opening action, i.e., NC contacts are physically forced open by direct linkage with the pushbutton operator in the unlikely event of contact weld
- Some M22 operators are capable of communication via ASi protocol
- M22 offers USB and RJ45 connections

#### Product Selection Guide

##### Pushbuttons



<b>Description</b>	Non-illuminated, flush		Non-illuminated, extended		Illuminated, flush		Illuminated, extended	
<b>Operator</b>	Momentary	Maintained	Momentary	Maintained	Momentary	Maintained	Momentary	Maintained
<b>Product Selection</b>	<b>Pages V7-T1-53 to V7-T1-55</b>	<b>Pages V7-T1-56, V7-T1-57</b>	<b>Pages V7-T1-58, V7-T1-59</b>	<b>Pages V7-T1-60, V7-T1-61</b>	<b>Pages V7-T1-63 to V7-T1-65</b>	<b>Pages V7-T1-66, V7-T1-67</b>	<b>Pages V7-T1-68, V7-T1-69</b>	<b>Pages V7-T1-70, V7-T1-71</b>

##### Indicating Lights



<b>Description</b>	Flat	Conical
<b>Product Selection</b>	<b>Pages V7-T1-72, V7-T1-73</b>	<b>Pages V7-T1-72, V7-T1-73</b>

### Emergency Stops



<b>Description</b>	Non-illuminated	Illuminated	Key release	Mechanical indication
<b>Product Selection</b>	<b>Page V7-T1-75</b>	<b>Page V7-T1-75</b>	<b>Page V7-T1-76</b>	<b>Page V7-T1-76</b>

### Selector Switches



<b>Description</b>	Non-illuminated knob type	Non-illuminated rotary type	Illuminated	Key-operated
<b>Product Selection</b>	<b>Pages V7-T1-80, V7-T1-81</b>	<b>Pages V7-T1-82, V7-T1-83</b>	<b>Pages V7-T1-85 to V7-T1-87</b>	<b>Pages V7-T1-88 to V7-T1-91</b>

### Mushroom Head Pushbuttons



<b>Description</b>	Non-illuminated	Non-illuminated
<b>Operator</b>	Momentary	Maintained
<b>Product Selection</b>	<b>Pages V7-T1-94, V7-T1-95</b>	<b>Pages V7-T1-96, V7-T1-97</b>

### Double Pushbuttons



<b>Description</b>	Extended pushbuttons and center light	Flush top and center light, extended bottom	Flush pushbuttons and center light
<b>Operator</b>	Momentary	Momentary	—
<b>Product Selection</b>	<b>Page V7-T1-99</b>	<b>Page V7-T1-100</b>	<b>Page V7-T1-100</b>

#### Four-Way Pushbuttons



<b>Description</b>	Non-interlocked	Interlocked
<b>Operator</b>	Momentary	Maintained
<b>Product Selection</b>	<a href="#">Page V7-T1-103</a>	<a href="#">Page V7-T1-103</a>

#### Joysticks



<b>Description</b>	Joysticks
<b>Product Selection</b>	<a href="#">Page V7-T1-104</a>

#### Potentiometers



<b>Description</b>	Potentiometers
<b>Product Selection</b>	<a href="#">Page V7-T1-106</a>

#### Acoustic Devices



<b>Description</b>	Acoustic devices
<b>Product Selection</b>	<a href="#">Page V7-T1-106</a>

#### Through-the-Door Operators



<b>Description</b>	Through-the-door operators
<b>Product Selection</b>	<a href="#">Page V7-T1-107</a>

#### Bulkhead Interfaces



<b>Description</b>	Bulkhead interfaces
<b>Product Selection</b>	<a href="#">Page V7-T1-107</a>

#### ASi Adapter Modules



<b>Description</b>	ASi adapter modules
<b>Product Selection</b>	<a href="#">Page V7-T1-108</a>

#### Palm Switches



<b>Description</b>	Palm switches
<b>Product Selection</b>	<a href="#">Page V7-T1-109</a>

#### Assembled Control Stations



<b>Description</b>	Assembled control stations
<b>Product Selection</b>	<a href="#">Page V7-T1-16</a>

M22\_



### Point-of-Purchase Units

Color	Type	Contact Configuration <sup>①</sup>	Catalog Number
Black	Flush momentary	NO/NC	<b>M22-D-S-K11-P</b>
Red	Extended momentary	NO/NC	<b>M22-DH-R-K11-P</b>
Green	Flush momentary	NO/NC	<b>M22-D-G-K11-P</b>
Red	Ext. illuminated (12–30V) momentary	NO/NC	<b>M22-DLH-R-K11-R-P</b>
Red	Ext. illuminated (85–264V) momentary	NO/NC	<b>M22-DLH-R-K11-230R-P</b>
White	Flush illuminated (12–30V) maintained	NO/NC	<b>M22-DRL-W-K11-W-P</b>
White	Flush illuminated (85–264V) maintained	NO/NC	<b>M22-DRL-W-K11-230W-P</b>
Red	Indicating light (12–30V)	—	<b>M22-L-R-R-P</b>
Green	Indicating light (12–30V)	—	<b>M22-L-G-G-P</b>
Red	Indicating light (85–264V)	—	<b>M22-L-R-230R-P</b>
Green	Indicating light (85–264 Vac)	—	<b>M22-L-G-230G-P</b>
Red	Twist-to-release E-stop	1NO/2NC	<b>M22-PVT-K12-P</b>
Red	Illuminated (12–30V) push-pull E-stop	1NO/2NC	<b>M22-PVL-K12-R-P</b>
Red	Illuminated (85–264V) push-pull E-stop	1NO/2NC	<b>M22-PVL-K12-230R-P</b>
—	Two-position maintained V selector switch	NO/NC	<b>M22-WKV-K11-P</b>
—	Three-position momentary selector switch	NO/NC	<b>M22-WK3-K22-P</b>

**Note**

<sup>①</sup> All NC contact blocks are positively driven contact. ⊖



**Pushbuttons—Non-Illuminated and Illuminated**



**Contents**

**Description**

**Page**

Pushbuttons—Non-Illuminated and Illuminated	
Non-Illuminated, Flush, Momentary	<b>V7-T1-53</b>
Non-Illuminated, Flush, Maintained	<b>V7-T1-56</b>
Non-Illuminated, Extended, Momentary	<b>V7-T1-58</b>
Non-Illuminated, Extended, Maintained	<b>V7-T1-60</b>
Illuminated, Flush, Momentary	<b>V7-T1-63</b>
Illuminated, Flush, Maintained	<b>V7-T1-66</b>
Illuminated, Extended, Momentary	<b>V7-T1-68</b>
Illuminated, Extended, Maintained	<b>V7-T1-70</b>

**Pushbuttons—Non-Illuminated and Illuminated**

**Product Description**

Eaton’s M22 pushbutton line is a complete, modular and versatile offering. From field-convertible maintained operators to customizable laser engraved buttons, the M22 pushbutton line provides endless opportunity for flexibility and reduced inventory. Each operator type provides options for ordering as complete or component parts allowing for a perfect fit for each application. All of this flexibility comes in a very rugged design.

**Features**

- Field convertible from maintained to momentary (available on maintained pushbuttons only)
- Customizable laser engraving on all buttons
- LED offering only for improved brightness quality and up to 100,000 hours of operation
- More than five million mechanical operations on momentary and 1 million on maintained pushbuttons
- Modular construction makes assembly fast and simplifies stocking of components and complete devices
- Capable of communicating via ASi protocol with ASi adapter modules

**Protection Type**

- IP67, IP69K
- NEMA 4X, 13

**Catalog Number Selection**

Catalog Number Selection is for illustrative purposes only and not to be used to create new catalog numbers.

**Non-Illuminated Pushbuttons**

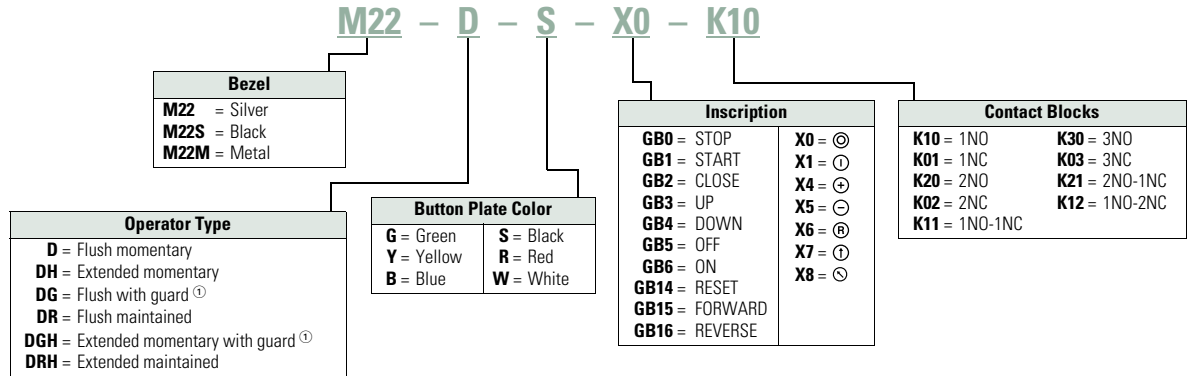

**Product Selection**

**Non-Illuminated Pushbuttons, Flush, Momentary**

M22-D-G-K10



M22S-D-G-K10



M22M-D-G-K10



**Complete Devices**

Button Color	Contact Block Configuration ①	Silver Bezel Catalog Number	Black Bezel Catalog Number	Metal Bezel Catalog Number
Black	NO	M22-D-S-K10	M22S-D-S-K10	M22M-D-S-K10
	NC	M22-D-S-K01	M22S-D-S-K01	M22M-D-S-K01
	2NO	M22-D-S-K20	M22S-D-S-K20	M22M-D-S-K20
	2NC	M22-D-S-K02	M22S-D-S-K02	M22M-D-S-K02
	1NO-1NC	M22-D-S-K11	M22S-D-S-K11	M22M-D-S-K11
Red	NO	M22-D-R-K10	M22S-D-R-K10	M22M-D-R-K10
	NC	M22-D-R-K01	M22S-D-R-K01	M22M-D-R-K01
	2NO	M22-D-R-K20	M22S-D-R-K20	M22M-D-R-K20
	2NC	M22-D-R-K02	M22S-D-R-K02	M22M-D-R-K02
	1NO-1NC	M22-D-R-K11	M22S-D-R-K11	M22M-D-R-K11
Green	NO	M22-D-G-K10	M22S-D-G-K10	M22M-D-G-K10
	NC	M22-D-G-K01	M22S-D-G-K01	M22M-D-G-K01
	2NO	M22-D-G-K20	M22S-D-G-K20	M22M-D-G-K20
	2NC	M22-D-G-K02	M22S-D-G-K02	M22M-D-G-K02
	1NO-1NC	M22-D-G-K11	M22S-D-G-K11	M22M-D-G-K11

**Note**

① All NC contact blocks are positively driven contact. ⊖

#### 1

#### Non-Illuminated Pushbuttons, Flush, Momentary

##### M22-D-G



##### Operators Only <sup>①</sup>

Button Color	Inscription	Silver Bezel Catalog Number	Black Bezel Catalog Number	Metal Bezel Catalog Number
Black	—	M22-D-S	M22S-D-S	M22M-D-S
Red	—	M22-D-R	M22S-D-R	M22M-D-R
Green	STOP	M22-D-R-GB0	M22S-D-R-GB0	—
	⊙	M22-D-R-X0	M22S-D-R-X0	M22M-D-R-X0
	—	M22-D-G	M22S-D-G	M22M-D-G
White	START	M22-D-G-GB1	M22S-D-G-GB1	M22M-D-G-GB1
	①	M22-D-G-X1	M22S-D-G-X1	M22M-D-G-X1
	—	M22-D-W	M22S-D-W	M22M-D-W
Blue	—	M22-D-B	M22S-D-B	M22M-D-B
Yellow	—	M22-D-Y	M22S-D-Y	M22M-D-Y
—	—	M22-D-X-SRSG <sup>②</sup>	M22S-D-X-SRSG <sup>②</sup>	M22M-D-X-SRSG <sup>②</sup>
—	—	M22-D-X-SWRGYB <sup>③</sup>	M22S-D-X-SWRGYB <sup>③</sup>	M22M-D-X-SWRGYB <sup>③</sup>

##### M22S-D-G



##### M22M-D-G



##### M22-DG-G



##### Silver Guarded

Button Color	Inscription	Silver Bezel Catalog Number
Black	—	M22-DG-S
Red	—	M22-DG-R
Green	—	M22-DG-G
White	—	M22-DG-W
Blue	—	M22-DG-B
Yellow	—	M22-DG-Y
—	—	M22-DG-X-SRSG <sup>②</sup>
—	—	M22-DG-X-SWRGYB <sup>③</sup>

##### Notes

- <sup>①</sup> Includes contact block mounting adapter.
- <sup>②</sup> Buttonless operator comes with three color buttons (black, red, green).
- <sup>③</sup> Buttonless operator comes with all six color buttons (black, white, red, green, yellow, blue).

### Non-Illuminated Pushbuttons, Flush, Momentary

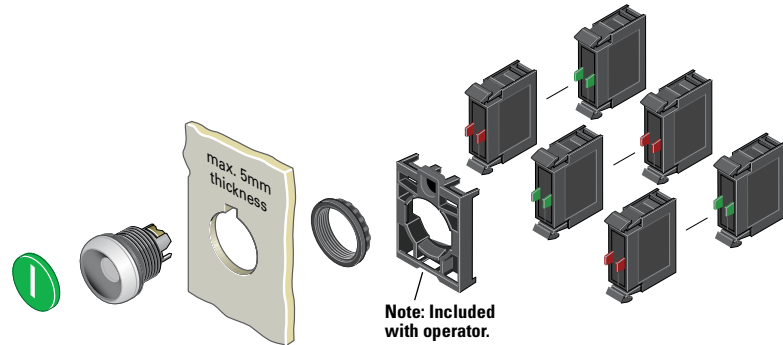

### Components

#### M22-XD-G



#### Button Plates <sup>①</sup>

Color	Inscription	Catalog Number
Black	—	M22-XD-S <sup>②</sup>
	Custom	M22-XD-S-ETCH <sup>③</sup>
	STOP	M22-XD-S-GB0
	START	M22-XD-S-GB1
	CLOSE	M22-XD-S-GB2
	UP	M22-XD-S-GB3
	DOWN	M22-XD-S-GB4
	OFF	M22-XD-S-GB5
	ON	M22-XD-S-GB6
	TEST	M22-XD-S-GB9
	FORWARD	M22-XD-S-GB15
	REVERSE	M22-XD-S-GB16
	RAISE	M22-XD-S-GB17
	LOWER	M22-XD-S-GB18
	⊙	M22-XD-S-X0
	⓪	M22-XD-S-X1
	Ⓛ	M22-XD-S-X2
	+	M22-XD-S-X4
	−	M22-XD-S-X5
Ⓛ	M22-XD-S-X7	
Red	—	M22-XD-R <sup>②</sup>
	Custom	M22-XD-R-ETCH <sup>③</sup>
	STOP	M22-XD-R-GB0
	OFF	M22-XD-R-GB5
Green	—	M22-XD-G <sup>②</sup>
	Custom	M22-XD-G-ETCH <sup>③</sup>
	START	M22-XD-G-GB1
	ON	M22-XD-G-GB6
Blue	—	M22-XD-B <sup>②</sup>
	Custom	M22-XD-B-ETCH <sup>③</sup>
	RESET	M22-XD-B-GB14
	Ⓡ	M22-XD-B-X6
White	—	M22-XD-W <sup>②</sup>
	Custom	M22-XD-W-ETCH <sup>③</sup>
	START	M22-XD-W-GB1
Yellow	—	M22-XD-Y <sup>②</sup>
	Custom	M22-XD-Y-ETCH <sup>③</sup>
Black, red, green	—	M22-XD-SRG
Black, white, red, green, yellow, blue	—	M22-XD-SWRGYB

#### Buttonless Operator



Silver Bezel  
Catalog Number <sup>④</sup>

M22-D-X



Black Bezel  
Catalog Number <sup>④</sup>

M22S-D-X



Metal Bezel  
Catalog Number <sup>④</sup>

M22M-D-X

#### Silver Guarded



Silver Bezel  
Catalog Number <sup>④</sup>

M22-DG-X

#### M22-K10



#### M22-FK01



#### Contact Blocks <sup>①</sup>

Terminal Type	Contact Configuration <sup>⑤</sup>	Catalog Number
Screw	NO	M22-K10
	NO, early-make	M22-K10P
	NC	M22-K01
	NC, late-break	M22-K01D
Spring-cage	NO	M22-CK10
	NC	M22-CK01
	NC, late-break	M22-CK01D
	2NO	M22-CK20
	2NC	M22-CK02
	NO-NC	M22-CK11
	NC	M22-FK01 <sup>⑥</sup>
	NO	M22-FK10 <sup>⑥</sup>

#### Notes

- <sup>①</sup> For complete listing of available button plates and contact blocks, see Accessories, Pages V7-T1-111 to V7-T1-116.
- <sup>②</sup> Minimum order quantity of (10).
- <sup>③</sup> When ordering, specify inscription per catalog number suffix from the Symbols Library (see Pages V7-T1-129 to V7-T1-136) into the Order Notes. For example, M22-XD-S-ETCH; Order Notes: Mark with symbol X91, Line item #\_.
- <sup>④</sup> Includes contact block mounting adapter.
- <sup>⑤</sup> All NC contact blocks are positively driven contact. ⊖
- <sup>⑥</sup> Additional contacts may not be stacked behind M22-F type contact blocks, M22-F can be stacked behind standard M22 contacts only.

#### 1

#### Non-Illuminated Pushbuttons, Flush, Maintained <sup>①</sup>

M22-DR-S



M22S-DR-S



M22M-DR-S



#### Operators Only <sup>②</sup>

Button Color	Silver Bezel Catalog Number	Black Bezel Catalog Number	Metal Bezel Catalog Number
Black	M22-DR-S	M22S-DR-S	M22M-DR-S
Red	M22-DR-R	M22S-DR-R	M22M-DR-R
Green	M22-DR-G	M22S-DR-G	M22M-DR-G
White	M22-DR-W	M22S-DR-W	M22M-DR-W
Blue	M22-DR-B	M22S-DR-B	M22M-DR-B
Yellow	M22-DR-Y	M22S-DR-Y	M22M-DR-Y
③	M22-DR-X-SRG	M22S-DR-X-SRG	M22M-DR-X-SRG
④	M22-DR-X-SWRGYB	M22S-DR-X-SWRGYB	M22M-DR-X-SWRGYB

#### Notes

- ① Maintained pushbuttons can be converted in the field to momentary operation by switching the locking ring, which is accessible through the side of the operator body.
- ② Includes contact block mounting adapter.
- ③ Buttonless operator comes with three color buttons (black, red, green).
- ④ Buttonless operator comes with all six color buttons (black, white, red, green, yellow, blue).

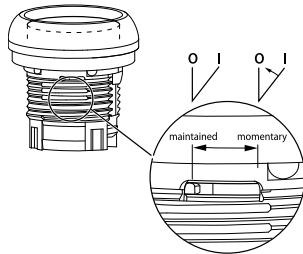

**Note:** This pilot device features a selectable function switch that enables the device to be set to either maintained or momentary operation.

### Non-Illuminated Pushbuttons, Flush, Maintained <sup>①</sup>

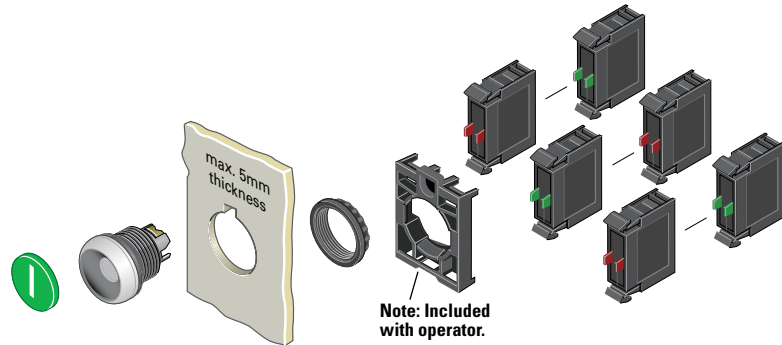

### Components

#### M22-XD-S



#### Button Plates <sup>②</sup>

Color	Inscription	Catalog Number
Black	—	M22-XD-S <sup>③</sup>
	Custom	M22-XD-S-ETCH <sup>④</sup>
	STOP	M22-XD-S-GB0
	START	M22-XD-S-GB1
	CLOSE	M22-XD-S-GB2
	UP	M22-XD-S-GB3
	DOWN	M22-XD-S-GB4
	OFF	M22-XD-S-GB5
	ON	M22-XD-S-GB6
	TEST	M22-XD-S-GB9
	FORWARD	M22-XD-S-GB15
	REVERSE	M22-XD-S-GB16
	RAISE	M22-XD-S-GB17
	LOWER	M22-XD-S-GB18
	⊙	M22-XD-S-X0
	⓪	M22-XD-S-X1
	Ⓛ	M22-XD-S-X2
	⊕	M22-XD-S-X4
⊖	M22-XD-S-X5	
Ⓛ	M22-XD-S-X7	
Red	—	M22-XD-R <sup>③</sup>
	Custom	M22-XD-R-ETCH <sup>④</sup>
	STOP	M22-XD-R-GB0
	OFF	M22-XD-R-GB5
	⊙	M22-XD-R-X0
	⊕	M22-XD-R-X1
Green	—	M22-XD-G <sup>③</sup>
	Custom	M22-XD-G-ETCH <sup>④</sup>
	START	M22-XD-G-GB1
	ON	M22-XD-G-GB6
	⓪	M22-XD-G-X1
Blue	—	M22-XD-B <sup>③</sup>
	Custom	M22-XD-B-ETCH <sup>④</sup>
	RESET	M22-XD-B-GB14
White	Ⓡ	M22-XD-B-X6
	—	M22-XD-W <sup>③</sup>
	Custom	M22-XD-W-ETCH <sup>④</sup>
Yellow	START	M22-XD-W-GB1
	⓪	M22-XD-W-X1
	—	M22-XD-Y <sup>③</sup>
	Custom	M22-XD-Y-ETCH <sup>④</sup>
Black, red, green	—	M22-XD-SRG
Black, white, red, green, yellow, blue	—	M22-XD-SWRGYB

#### Buttonless Operator



Silver Bezel  
Catalog Number <sup>⑤</sup>

M22-DR-X



Black Bezel  
Catalog Number <sup>⑤</sup>

M22S-DR-X



Metal Bezel  
Catalog Number <sup>⑤</sup>

M22M-DR-X

#### M22-K10



#### M22-FK01



#### Contact Blocks <sup>②</sup>

Terminal Type	Contact Configuration <sup>⑥</sup>	Catalog Number
Screw	NO	M22-K10
	NO, early-make	M22-K10P
	NC	M22-K01
	NC, late-break	M22-K01D
Spring-cage	NO	M22-CK10
	NC	M22-CK01
	NC, late-break	M22-CK01D
	2NO	M22-CK20
	2NC	M22-CK02
	NO-NC	M22-CK11
NC	M22-FK01 <sup>⑦</sup>	
NO	M22-FK10 <sup>⑦</sup>	

#### Notes

- ① Maintained pushbuttons can be converted in the field to momentary operation by switching the locking ring, which is accessible through the side of the operator body.
- ② For complete listing of available button plates and contact blocks, see Accessories, Pages V7-T1-111 to V7-T1-116.
- ③ Minimum order quantity of (10).
- ④ When ordering, specify inscription per catalog number suffix from the Symbols Library (see Pages V7-T1-129 to V7-T1-136) into the Order Notes. For example, M22-XD-S-ETCH; Order Notes: Mark with symbol X91, Line item #\_.
- ⑤ Includes contact block mounting adapter.
- ⑥ All NC contact blocks are positively driven contact. ⊖
- ⑦ Additional contacts may not be stacked behind M22-F type contact blocks, M22-F can be stacked behind standard M22 contacts only.

## 1 Non-Illuminated Pushbuttons, Extended, Momentary

M22-DH-R-K10



M22S-DH-R-K10



M22M-DH-R-K10



## Complete Devices

Button Color	Contact Block Configuration <sup>①</sup>	Silver Bezel Catalog Number	Black Bezel Catalog Number	Metal Bezel Catalog Number
Red	NO	M22-DH-R-K10	M22S-DH-R-K10	M22M-DH-R-K10
	NC	M22-DH-R-K01	M22S-DH-R-K01	M22M-DH-R-K01
	2NO	M22-DH-R-K20	M22S-DH-R-K20	M22M-DH-R-K20
	2NC	M22-DH-R-K02	M22S-DH-R-K02	M22M-DH-R-K02
	1NO-1NC	M22-DH-R-K11	M22S-DH-R-K11	M22M-DH-R-K11

M22-DGH-R-K10



## Silver Guarded

Button Color	Contact Block Configuration <sup>①</sup>	Silver Bezel Catalog Number
Red	NO	M22-DGH-R-K10
	NC	M22-DGH-R-K01
	2NO	M22-DGH-R-K20
	2NC	M22-DGH-R-K02
	1NO-1NC	M22-DGH-R-K11

M22-DH-R



M22S-DH-R



M22M-DH-R

Operators Only <sup>②</sup>

Button Color	Inscription	Silver Bezel Catalog Number	Black Bezel Catalog Number	Metal Bezel Catalog Number
Black	—	M22-DH-S	M22S-DH-S	M22M-DH-S
Red	—	M22-DH-R	M22S-DH-R	M22M-DH-R
	STOP	M22-DH-R-GB0	M22S-DH-R-GB0	M22M-DH-R-GB0
	⊙	M22-DH-R-X0	M22S-DH-R-X0	M22M-DH-R-X0
	—	M22-DH-G	M22S-DH-G	M22M-DH-G
Green	—	M22-DH-G	M22S-DH-G	M22M-DH-G
White	—	M22-DH-W	M22S-DH-W	M22M-DH-W
Blue	—	M22-DH-B	M22S-DH-B	M22M-DH-B
Yellow	—	M22-DH-Y	M22S-DH-Y	M22M-DH-Y
	③	M22-DH-X-SRG	M22S-DH-X-SRG	M22M-DH-X-SRG
	④	M22-DH-X-SWRGB	M22S-DH-X-SWRGB	M22M-DH-X-SWRGB

M22-DGH-R-K10



## Silver Guarded

Button Color	Inscription	Silver Bezel Catalog Number
Black	—	M22-DGH-S
Red	—	M22-DGH-R
	STOP	M22-DGH-R-GB0
	⊙	M22-DGH-R-X0
	—	M22-DGH-G
Green	—	M22-DGH-G
White	—	M22-DGH-W
Blue	—	M22-DGH-B
Yellow	—	M22-DGH-Y

## Notes

- ① All NC contact blocks are positively driven contact. ⊖
- ② Includes contact block mounting adapter.
- ③ Buttonless operator comes with three color buttons (black, red, green).
- ④ Buttonless operator comes with all six color buttons (black, white, red, green, yellow, blue).

### Non-Illuminated Pushbuttons, Extended, Momentary

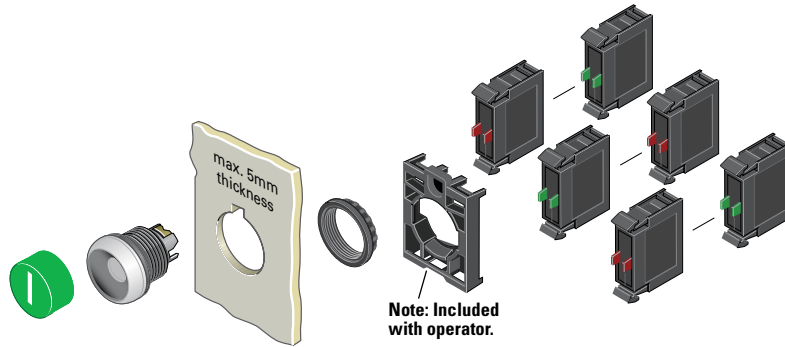

### Components

#### M22-XDH-R



#### Button Plates <sup>①</sup>

Color	Inscription	Catalog Number
Black	—	M22-XDH-S <sup>②</sup>
	Custom	M22-XDH-S-ETCH <sup>③</sup>
	STOP	M22-XDH-S-GB0
	START	M22-XDH-S-GB1
	CLOSE	M22-XDH-S-GB2
	UP	M22-XDH-S-GB3
	DOWN	M22-XDH-S-GB4
	OFF	M22-XDH-S-GB5
	ON	M22-XDH-S-GB6
	TEST	M22-XDH-S-GB9
	FORWARD	M22-XDH-S-GB15
	REVERSE	M22-XDH-S-GB16
	RAISE	M22-XDH-S-GB17
	LOWER	M22-XDH-S-GB18
	⊙	M22-XDH-S-X0
	⓪	M22-XDH-S-X1
	Ⓛ	M22-XDH-S-X2
	+	M22-XDH-S-X4
	−	M22-XDH-S-X5
Ⓛ	M22-XDH-S-X7	
Red	—	M22-XDH-R <sup>②</sup>
	Custom	M22-XDH-R-ETCH <sup>③</sup>
	STOP	M22-XDH-R-GB0
	OFF	M22-XDH-R-GB5
Green	—	M22-XDH-G <sup>②</sup>
	Custom	M22-XDH-G-ETCH <sup>③</sup>
	START	M22-XDH-G-GB1
Blue	ON	M22-XDH-G-GB6
	⓪	M22-XDH-G-X1
	—	M22-XDH-B <sup>②</sup>
	Custom	M22-XDH-B-ETCH <sup>③</sup>
White	RESET	M22-XDH-B-GB14
	Ⓡ	M22-XDH-B-X6
	—	M22-XDH-W <sup>②</sup>
Yellow	Custom	M22-XDH-W-ETCH <sup>③</sup>
	START	M22-XDH-W-GB1
	⓪	M22-XDH-W-X1
Black, red, green	—	M22-XDH-Y <sup>②</sup>
	Custom	M22-XDH-Y-ETCH <sup>③</sup>
Black, white, red, green, yellow, blue	—	M22-XDH-SRG
	—	M22-XDH-SWRGYB

#### Buttonless Operator



#### Silver Guarded



#### M22-K10



#### M22-FK01



#### Contact Blocks <sup>①</sup>

Terminal Type	Contact Configuration <sup>⑤</sup>	Catalog Number
Screw	NO	M22-K10
	NO, early-make	M22-K10P
	NC	M22-K01
	NC, late-break	M22-K01D
Spring-cage	NO	M22-CK10
	NC	M22-CK01
	NC, late-break	M22-CK01D
	2NO	M22-CK20
	2NC	M22-CK02
	NO-NC	M22-CK11
	NC	M22-FK01 <sup>⑥</sup>
	NO	M22-FK10 <sup>⑥</sup>

#### Notes

- ① For complete listing of available button plates and contact blocks, see Accessories, Pages V7-T1-111 to V7-T1-116.
- ② Minimum order quantity of (10).
- ③ When ordering, specify inscription per catalog number suffix from the Symbols Library (see Pages V7-T1-129 to V7-T1-136) into the Order Notes. For example, M22-XDH-S-ETCH; Order Notes: Mark with symbol X91, Line item #...
- ④ Includes contact block mounting adapter.
- ⑤ All NC contact blocks are positively driven contact. ⊖
- ⑥ Additional contacts may not be stacked behind M22-F type contact blocks, M22-F can be stacked behind standard M22 contacts only.



#### 1 Non-Illuminated Pushbuttons, Extended, Maintained <sup>①</sup>

##### Operators Only <sup>②</sup>

M22-DRH-W



M22S-DRH-W



M22M-DRH-W



Button Color	Silver Bezel Catalog Number	Black Bezel Catalog Number	Metal Bezel Catalog Number
Black	M22-DRH-S	M22S-DRH-S	M22M-DRH-S
Red	M22-DRH-R	M22S-DRH-R	M22M-DRH-R
Green	M22-DRH-G	M22S-DRH-G	M22M-DRH-G
White	M22-DRH-W	M22S-DRH-W	M22M-DRH-W
Blue	M22-DRH-B	M22S-DRH-B	M22M-DRH-B
Yellow	M22-DRH-Y	M22S-DRH-Y	M22M-DRH-Y
<sup>③</sup>	M22-DRH-X-SRG	M22S-DRH-X-SRG	M22M-DRH-X-SRG
<sup>④</sup>	M22-DRH-X-SWRGYB	M22S-DRH-X-SWRGYB	M22M-DRH-X-SWRGYB

##### Notes

- <sup>①</sup> Maintained pushbuttons can be converted in the field to momentary operation by switching the locking ring, which is accessible through the side of the operator body.
- <sup>②</sup> Includes contact block mounting adapter.
- <sup>③</sup> Buttonless operator comes with three color buttons (black, red, green).
- <sup>④</sup> Buttonless operator comes with all six color buttons (black, white, red, green, yellow, blue).

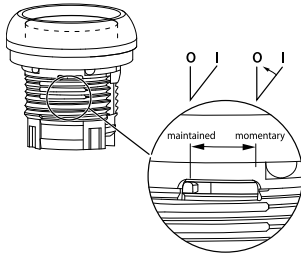

**Note:** This pilot device features a selectable function switch that enables the device to be set to either maintained or momentary operation.

### Non-Illuminated Pushbuttons, Extended, Maintained <sup>①</sup>

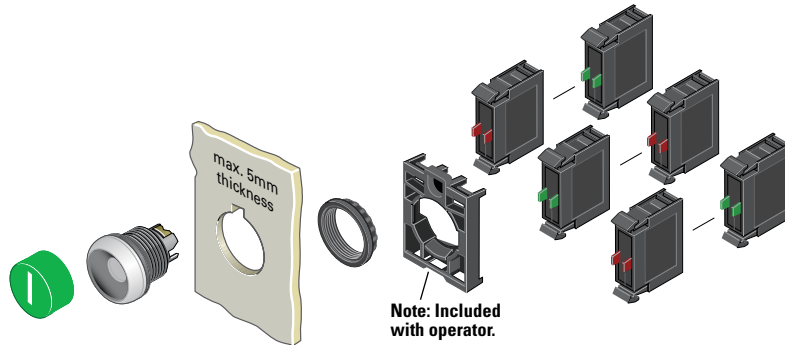

### Components

#### M22-XDH-W



#### Button Plates <sup>②</sup>

Color	Inscription	Catalog Number
Black	—	M22-XDH-S <sup>③</sup>
	Custom	M22-XDH-S-ETCH <sup>④</sup>
	STOP	M22-XDH-S-GB0
	START	M22-XDH-S-GB1
	CLOSE	M22-XDH-S-GB2
	UP	M22-XDH-S-GB3
	DOWN	M22-XDH-S-GB4
	OFF	M22-XDH-S-GB5
	ON	M22-XDH-S-GB6
	TEST	M22-XDH-S-GB9
	FORWARD	M22-XDH-S-GB15
	REVERSE	M22-XDH-S-GB16
	RAISE	M22-XDH-S-GB17
	LOWER	M22-XDH-S-GB18
	⊙	M22-XDH-S-X0
	⓪	M22-XDH-S-X1
	Ⓛ	M22-XDH-S-X2
+	M22-XDH-S-X4	
−	M22-XDH-S-X5	
Ⓜ	M22-XDH-S-X7	
Red	—	M22-XDH-R <sup>③</sup>
	Custom	M22-XDH-R-ETCH <sup>④</sup>
	STOP	M22-XDH-R-GB0
	OFF	M22-XDH-R-GB5
	⊙	M22-XDH-R-X0
	Green	—
Custom	M22-XDH-G-ETCH <sup>④</sup>	
START	M22-XDH-G-GB1	
ON	M22-XDH-G-GB6	
⓪	M22-XDH-G-X1	
Blue	—	M22-XDH-B <sup>③</sup>
	Custom	M22-XDH-B-ETCH <sup>④</sup>
	RESET	M22-XDH-B-GB14
Ⓜ	M22-XDH-B-X6	
White	—	M22-XDH-W <sup>③</sup>
	Custom	M22-XDH-W-ETCH <sup>④</sup>
	START	M22-XDH-W-GB1
	⓪	M22-XDH-W-X1
Yellow	—	M22-XDH-Y <sup>③</sup>
	Custom	M22-XDH-Y-ETCH <sup>④</sup>
Black, red, green	—	M22-XDH-SRG
Black, white, red, green, yellow, blue	—	M22-XDH-SWRGYB

#### Buttonless Operator



Silver Bezel  
Catalog Number <sup>⑤</sup>

M22-DR-X



Black Bezel  
Catalog Number <sup>⑤</sup>

M22S-DR-X



Metal Bezel  
Catalog Number <sup>⑤</sup>

M22M-DR-X

#### M22-K10



#### M22-FK01



#### Contact Blocks <sup>②</sup>

Terminal Type	Contact Configuration <sup>⑥</sup>	Catalog Number
Screw	NO	M22-K10
	NO, early-make	M22-K10P
	NC	M22-K01
	NC, late-break	M22-K01D
Spring-cage	NO	M22-CK10
	NC	M22-CK01
	NC, late-break	M22-CK01D
	2NO	M22-CK20
	2NC	M22-CK02
	NO-NC	M22-CK11
	NC	M22-FK01 <sup>⑦</sup>
	NO	M22-FK10 <sup>⑦</sup>

#### Notes

- ① Maintained pushbuttons can be converted in the field to momentary operation by switching the locking ring, which is accessible through the side of the operator body.
- ② For complete listing of available button plates and contact blocks, see Accessories, Pages V7-T1-111 to V7-T1-116.
- ③ Minimum order quantity of (10).
- ④ When ordering, specify inscription per catalog number suffix from the Symbols Library (see Pages V7-T1-129 to V7-T1-136) into the Order Notes. For example, M22-XDH-S-ETCH; Order Notes: Mark with symbol X91, Line item #\_.
- ⑤ Includes contact block mounting adapter.
- ⑥ All NC contact blocks are positively driven contact. ⊖
- ⑦ Additional contacts may not be stacked behind M22-F type contact blocks, M22-F can be stacked behind standard M22 contacts only.

#### 1

### Catalog Number Selection

Catalog Number Selection is for illustrative purposes only and not to be used to create new catalog numbers.

#### Illuminated Pushbuttons

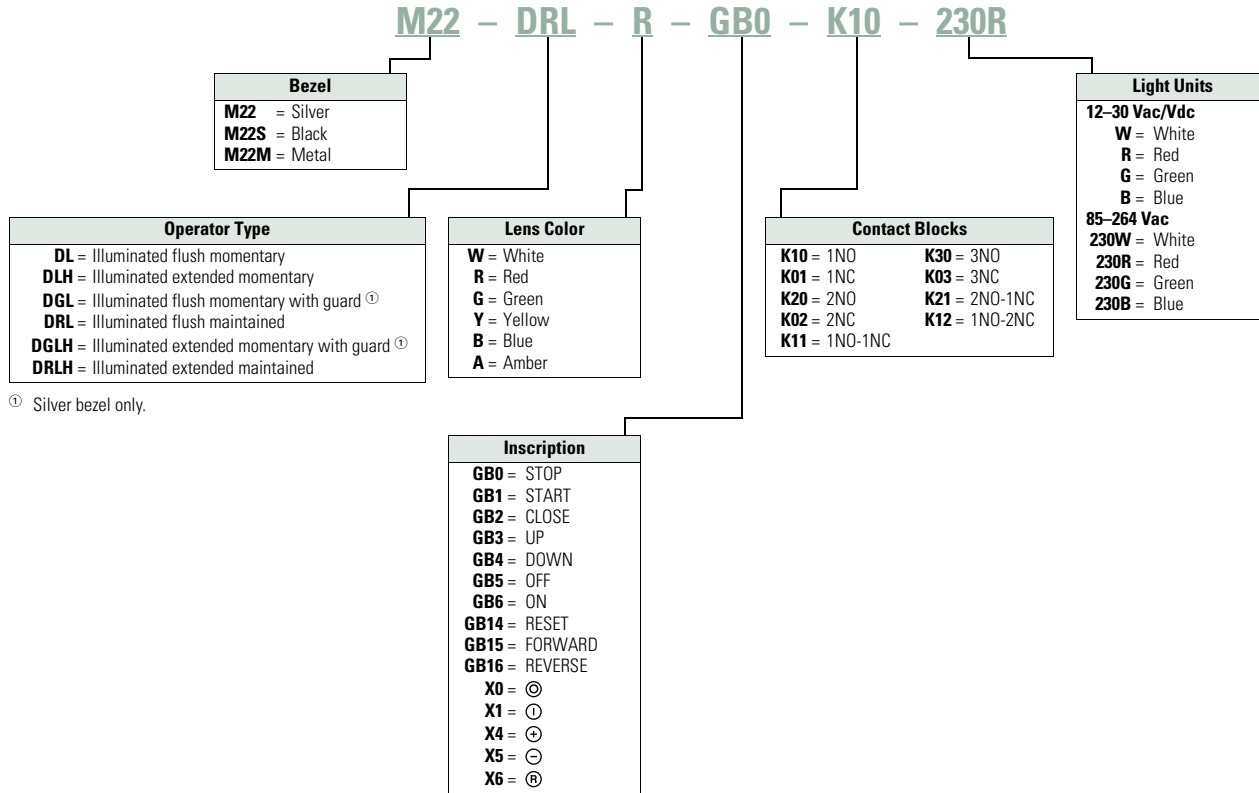

**Product Selection**

**Illuminated Pushbuttons, Flush, Momentary**

**M22-DL-G-K01-G**



**Complete Devices**

Button Color	Contact Block Configuration <sup>①</sup>	Light Unit Voltage	Silver Bezel Catalog Number	Black Bezel Catalog Number	Metal Bezel Catalog Number
Red	NC	12–30 Vac/Vdc	M22-DL-R-K01-R	M22S-DL-R-K01-R	M22M-DL-R-K01-R
	NC	85–264 Vac	M22-DL-R-K01-230R	M22S-DL-R-K01-230R	M22M-DL-R-K01-230R
	2NC	12–30 Vac/Vdc	M22-DL-R-K02-R	M22S-DL-R-K02-R	M22M-DL-R-K02-R
	2NC	85–264 Vac	M22-DL-R-K02-230R	M22S-DL-R-K02-230R	M22M-DL-R-K02-230R
Green	1NO/1NC	12–30 Vac/Vdc	M22-DL-R-K11-R	M22S-DL-R-K11-R	M22M-DL-R-K11-R
	1NO/1NC	85–264 Vac	M22-DL-R-K11-230R	M22S-DL-R-K11-230R	M22M-DL-R-K11-230R
	NO	12–30 Vac/Vdc	M22-DL-G-K10-G	M22S-DL-G-K10-G	M22M-DL-G-K10-G
	NO	85–264 Vac	M22-DL-G-K10-230G	M22S-DL-G-K10-230G	M22M-DL-G-K10-230G
M22M-DL-G-K01-G	2NO	12–30 Vac/Vdc	M22-DL-G-K20-G	M22S-DL-G-K20-G	M22M-DL-G-K20-G
	2NO	85–264 Vac	M22-DL-G-K20-230G	M22S-DL-G-K20-230G	M22M-DL-G-K20-230G
	1NO/1NC	12–30 Vac/Vdc	M22-DL-G-K11-G	M22S-DL-G-K11-G	M22M-DL-G-K11-G
	1NO/1NC	85–264 Vac	M22-DL-G-K11-230G	M22S-DL-G-K11-230G	M22M-DL-G-K11-230G
White	NO	12–30 Vac/Vdc	M22-DL-W-K10-W	M22S-DL-W-K10-W	—
	NO	85–264 Vac	M22-DL-W-K10-230W	M22S-DL-W-K10-230W	M22M-DL-W-K10-230W
	2NO	12–30 Vac/Vdc	M22-DL-W-K20-W	M22S-DL-W-K20-W	—
	2NO	85–264 Vac	M22-DL-W-K20-230W	M22S-DL-W-K20-230W	M22M-DL-W-K20-230W
	1NO/1NC	12–30 Vac/Vdc	M22-DL-W-K11-W	M22S-DL-W-K11-W	—
	1NO/1NC	85–264 Vac	M22-DL-W-K11-230W	M22S-DL-W-K11-230W	M22M-DL-W-K11-230W

**Note**

<sup>①</sup> All NC contact blocks are positively driven contact. ⊖

1

#### Illuminated Pushbuttons, Flush, Momentary

M22-DL-G



M22S-DL-G



M22M-DL-G



M22-DGL-G



#### Operators Only <sup>Ⓢ</sup>

Button Color	Silver Bezel Catalog Number	Black Bezel Catalog Number	Metal Bezel Catalog Number
Red	<b>M22-DL-R</b>	<b>M22S-DL-R</b>	<b>M22M-DL-R</b>
Green	<b>M22-DL-G</b>	<b>M22S-DL-G</b>	<b>M22M-DL-G</b>
White	<b>M22-DL-W</b>	<b>M22S-DL-W</b>	<b>M22M-DL-W</b>
Blue	<b>M22-DL-B</b>	<b>M22S-DL-B</b>	<b>M22M-DL-B</b>
Yellow	<b>M22-DL-Y</b>	<b>M22S-DL-Y</b>	<b>M22M-DL-Y</b>
Amber	<b>M22-DL-A</b>	<b>M22S-DL-A</b>	<b>M22M-DL-A</b>

#### Silver Guarded

Button Color	Silver Bezel Catalog Number
Red	<b>M22-DGL-R</b>
Green	<b>M22-DGL-G</b>
White	<b>M22-DGL-W</b>
Blue	<b>M22-DGL-B</b>
Yellow	<b>M22-DGL-Y</b>

**Note**

<sup>Ⓢ</sup> Includes contact block mounting adapter.

### Illuminated Pushbuttons, Flush, Momentary

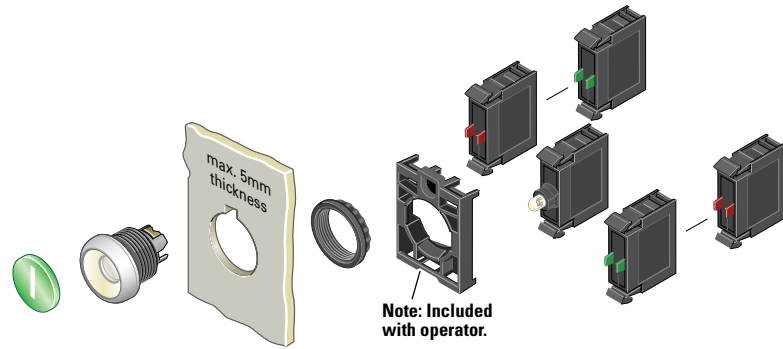

### Components

#### M22-XDL-G



#### Button Lenses <sup>①</sup>

Color	Inscription	Catalog Number
Red	—	M22-XDL-R <sup>②</sup>
	Custom	M22-XDL-R-ETCH <sup>③</sup>
	STOP	M22-XDL-R-GB0
	OFF	M22-XDL-R-GB5
	Ⓞ	M22-XDL-R-X0
Green	—	M22-XDL-G <sup>②</sup>
	Custom	M22-XDL-G-ETCH <sup>③</sup>
	START	M22-XDL-G-GB1
	ON	M22-XDL-G-GB6
	Ⓛ	M22-XDL-G-X1
Blue	—	M22-XDL-B <sup>②</sup>
	Custom	M22-XDL-B-ETCH <sup>③</sup>
	RESET	M22-XDL-B-GB14
White	Ⓜ	M22-XDL-B-X6
	—	M22-XDL-W <sup>②</sup>
Yellow	Custom	M22-XDL-W-ETCH <sup>③</sup>
	—	M22-XDL-Y <sup>②</sup>
Amber	Custom	M22-XDL-Y-ETCH <sup>③</sup>
	—	M22-XDL-A
	Custom	M22-XDL-A-ETCH

#### M22-DL-X



#### Buttonless Operator

Silver Bezel Catalog Number <sup>④</sup>	Black Bezel Catalog Number <sup>④</sup>	Metal Bezel Catalog Number <sup>④</sup>
M22-DL-X	M22S-DL-X	M22M-DL-X

#### M22S-DL-X



#### M22M-DL-X



#### M22-DGL-X



#### Silver Guarded

Silver Bezel Catalog Number <sup>④</sup>
M22-DGL-X

#### M22-LED-W



#### Light Units <sup>①</sup>

Terminal Type	LED Color	Light Unit Voltage	Catalog Number
Screw	White	12–30 Vac/Vdc	M22-LED-W
	Red		M22-LED-R
	Green		M22-LED-G
	Blue		M22-LED-B
Screw	White	85–264 Vac	M22-LED230-W
	Red		M22-LED230-R
	Green		M22-LED230-G
Spring-cage	Blue		M22-LED230-B
	White	12–30 Vac/Vdc	M22-FLED-W
	Red		M22-FLED-R
	Green		M22-FLED-G
	Blue		M22-FLED-B
	Red/Green/Yellow	24 Vdc	M22-FLED-RG <sup>⑤</sup>
	Red, Green, Blue, Yellow, White, Violet, Turquoise		M22-FLED-RGB <sup>⑤</sup>

#### M22-FLED-



#### M22-K10



#### Contact Blocks <sup>①</sup>

Terminal Type	Contact Configuration <sup>⑥</sup>	Catalog Number
Screw	NO	M22-K10
	NO, early-make	M22-K10P
	NC	M22-K01
	NC, late-break	M22-K01D
Spring-cage	NO	M22-CK10
	NC	M22-CK01
	NC, late-break	M22-CK01D
	2NO	M22-CK20
	2NC	M22-CK02
	NO-NC	M22-CK11
	NC	M22-FK01 <sup>⑦</sup>
	NO	M22-FK10 <sup>⑦</sup>

#### M22-FK01



#### Notes

- For complete listing of available button lenses, light units and contact blocks, see Accessories, **Pages V7-T1-111 to V7-T1-116**.
- Minimum order quantity of (10).
- When ordering, specify inscription per catalog number suffix from the Symbols Library (see **Pages V7-T1-129 to V7-T1-136**) into the Order Notes. For example, M22-XDL-R-ETCH; Order Notes: Mark with symbol X91, Line item #\_.
- Includes contact block mounting adapter.
- Please see color input key on **Page V7-T1-114**.
- All NC contact blocks are positively driven contact. Ⓞ
- Additional contacts may not be stacked behind M22-F type contact blocks, M22-F can be stacked behind standard M22 contacts only.

#### 1

#### Illuminated Pushbuttons, Flush, Maintained <sup>①</sup>

##### M22-DRL-W-K10-W



##### M22S-DRL-W-K10-W



##### M22M-DRL-W-K10-W



#### Complete Devices

Button Color	Contact Block Configuration <sup>②</sup>	Light Unit Voltage	Silver Bezel Catalog Number	Black Bezel Catalog Number	Metal Bezel Catalog Number
White	NO	12–30 Vac/Vdc	M22-DRL-W-K10-W	M22S-DRL-W-K10-W	M22M-DRL-W-K10-W
	NO	85–264 Vac	M22-DRL-W-K10-230W	M22S-DRL-W-K10-230W	M22M-DRL-W-K10-230W
	NC	12–30 Vac/Vdc	M22-DRL-W-K01-W	M22S-DRL-W-K01-W	M22M-DRL-W-K01-W
	NC	85–264 Vac	M22-DRL-W-K01-230W	M22S-DRL-W-K01-230W	M22M-DRL-W-K01-230W
	2NO	12–30 Vac/Vdc	M22-DRL-W-K20-W	M22S-DRL-W-K20-W	M22M-DRL-W-K20-W
	2NO	85–264 Vac	M22-DRL-W-K20-230W	M22S-DRL-W-K20-230W	M22M-DRL-W-K20-230W
	2NC	12–30 Vac/Vdc	M22-DRL-W-K02-W	M22S-DRL-W-K02-W	M22M-DRL-W-K02-W
	2NC	85–264 Vac	M22-DRL-W-K02-230W	M22S-DRL-W-K02-230W	M22M-DRL-W-K02-230W
	1NO/1NC	12–30 Vac/Vdc	M22-DRL-W-K11-W	M22S-DRL-W-K11-W	M22M-DRL-W-K11-W
	1NO/1NC	85–264 Vac	M22-DRL-W-K11-230W	M22S-DRL-W-K11-230W	M22M-DRL-W-K11-230W

##### M22-DRL-W



##### M22S-DRL-W



##### M22M-DRL-W



#### Operators Only <sup>③</sup>

Button Color	Silver Bezel Catalog Number	Black Bezel Catalog Number	Metal Bezel Catalog Number
Red	M22-DRL-R	M22S-DRL-R	M22M-DRL-R
Green	M22-DRL-G	M22S-DRL-G	M22M-DRL-G
White	M22-DRL-W	M22S-DRL-W	M22M-DRL-W
Blue	M22-DRL-B	M22S-DRL-B	M22M-DRL-B
Yellow	M22-DRL-Y	M22S-DRL-Y	M22M-DRL-Y
Amber	M22-DRL-A	M22S-DRL-A	M22M-DRL-A

#### Notes

- ① Maintained pushbuttons can be converted in the field to momentary operation by switching the locking ring, which is accessible through the side of the operator body.
- ② All NC contact blocks are positively driven contact.
- ③ Includes contact block mounting adapter.

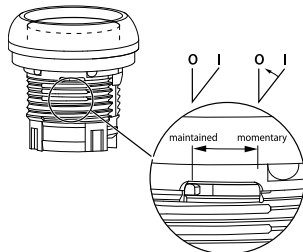

**Note:** This pilot device features a selectable function switch that enables the device to be set to either maintained or momentary operation.

### Illuminated Pushbuttons, Flush, Maintained <sup>①</sup>

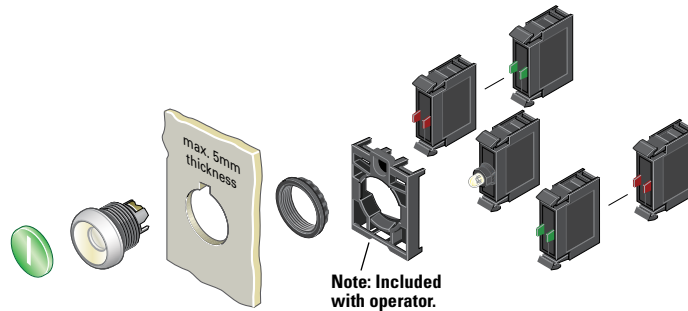

### Components

#### M22-XDL-W



#### Button Lenses <sup>②</sup>

Color	Inscription	Catalog Number
Red	—	<b>M22-XDL-R</b> <sup>③</sup>
	Custom	<b>M22-XDL-R-ETCH</b> <sup>④</sup>
	STOP	<b>M22-XDL-R-GB0</b>
	OFF	<b>M22-XDL-R-GB5</b>
	Ⓞ	<b>M22-XDL-R-X0</b>
Green	—	<b>M22-XDL-G</b> <sup>③</sup>
	Custom	<b>M22-XDL-G-ETCH</b> <sup>④</sup>
	START	<b>M22-XDL-G-GB1</b>
	ON	<b>M22-XDL-G-GB6</b>
	Ⓛ	<b>M22-XDL-G-X1</b>
Blue	—	<b>M22-XDL-B</b> <sup>③</sup>
	Custom	<b>M22-XDL-B-ETCH</b> <sup>④</sup>
	RESET	<b>M22-XDL-B-GB14</b>
	Ⓡ	<b>M22-XDL-B-X6</b>
	White	—
Yellow	Custom	<b>M22-XDL-W-ETCH</b> <sup>④</sup>
	Custom	<b>M22-XDL-Y</b> <sup>③</sup>
Amber	—	<b>M22-XDL-A</b>
	Custom	<b>M22-XDL-A-ETCH</b>

#### M22-DRL-X



#### Buttonless Operator

Silver Bezel Catalog Number <sup>⑤</sup>	Black Bezel Catalog Number <sup>⑤</sup>	Metal Bezel Catalog Number <sup>⑤</sup>
<b>M22-DRL-X</b>	<b>M22S-DRL-X</b>	<b>M22M-DRL-X</b>

#### M22S-DRL-X



#### M22M-DRL-X



#### M22-LED-W



#### Light Units <sup>②</sup>

Terminal Type	LED Color	Light Unit Voltage	Catalog Number
Screw	White	12–30 Vac/Vdc	<b>M22-LED-W</b>
	Red		<b>M22-LED-R</b>
	Green		<b>M22-LED-G</b>
	Blue		<b>M22-LED-B</b>
Screw	White	85–264 Vac	<b>M22-LED230-W</b>
	Red		<b>M22-LED230-R</b>
	Green		<b>M22-LED230-G</b>
Spring-cage	Blue	12–30 Vac/Vdc	<b>M22-LED230-B</b>
	White		<b>M22-FLED-W</b>
	Red	<b>M22-FLED-R</b>	
	Green	<b>M22-FLED-G</b>	
	Blue	<b>M22-FLED-B</b>	
	Red/Green/Yellow	24 Vdc	<b>M22-FLED-RG</b> <sup>⑥</sup>
	Red, Green, Blue, Yellow, White, Violet, Turquoise	<b>M22-FLED-RGB</b> <sup>⑥</sup>	

#### M22-FLED-



#### M22-K10



#### Contact Blocks <sup>②</sup>

Terminal Type	Contact Configuration <sup>⑦</sup>	Catalog Number
Screw	NO	<b>M22-K10</b>
	NO, early-make	<b>M22-K10P</b>
	NC	<b>M22-K01</b>
	NC, late-break	<b>M22-K01D</b>
Spring-cage	NO	<b>M22-CK10</b>
	NC	<b>M22-CK01</b>
	NC, late-break	<b>M22-CK01D</b>
	2NO	<b>M22-CK20</b>
	2NC	<b>M22-CK02</b>
	NO-NC	<b>M22-CK11</b>
	NC	<b>M22-FK01</b> <sup>⑧</sup>
	NO	<b>M22-FK10</b> <sup>⑧</sup>

#### M22-FK01



#### Notes

- ① Maintained pushbuttons can be converted in the field to momentary operation by switching the locking ring, which is accessible through the side of the operator body.
- ② For complete listing of available button lenses, light units and contact blocks, see Accessories, **Pages V7-T1-111 to V7-T1-116**.
- ③ Minimum order quantity of (10).
- ④ When ordering, specify inscription per catalog number suffix from the Symbols Library (see **Pages V7-T1-129 to V7-T1-136**) into the Order Notes. For example, M22-XDL-R-ETCH; Order Notes: Mark with symbol X91, Line item #\_.
- ⑤ Includes contact block mounting adapter.
- ⑥ Please see color input key on **Page V7-T1-114**.
- ⑦ All NC contact blocks are positively driven contact. Ⓞ
- ⑧ Additional contacts may not be stacked behind M22-F type contact blocks, M22-F can be stacked behind standard M22 contacts only.



1

## Illuminated Pushbuttons, Extended, Momentary

M22-DLH-R-K11-R



M22S-DLH-R-K11-R



## Complete Devices

Button Color	Contact Block Configuration <sup>①</sup>	Light Unit Voltage	Silver Bezel Catalog Number	Black Bezel Catalog Number	Metal Bezel Catalog Number
Red	1NO/1NC	12–30 Vac/Vdc	M22-DLH-R-K11-R	M22S-DLH-R-K11-R	M22M-DLH-R-K11-R
	1NO/1NC	85–264 Vac	M22-DLH-R-K11-230R	M22S-DLH-R-K11-230R	M22M-DLH-R-K11-230R
Green	2NO	12–30 Vac/Vdc	M22-DLH-G-K20-G	M22S-DLH-G-K20-G	M22M-DLH-G-K20-G
	2NO	85–264 Vac	M22-DLH-G-K20-230G	M22S-DLH-G-K20-230G	M22M-DLH-G-K20-230G
White	2NO	12–30 Vac/Vdc	M22-DLH-W-K20-W	M22S-DLH-W-K20-W	M22M-DLH-W-K20-W
	2NO	85–264 Vac	M22-DLH-W-K20-230W	M22S-DLH-W-K20-230W	M22M-DLH-W-K20-230W

## Complete Press-to-Test Units

Button Color	Light Unit Voltage	Silver Bezel Catalog Number	Black Bezel Catalog Number
Red	12–30 Vac/Vdc	M22-T-R-R	M22S-T-R-R
Blue		M22-T-B-B	M22S-T-B-B
Yellow		M22-T-Y-W	M22S-T-Y-W
Green		M22-T-G-G	M22S-T-G-G
White		M22-T-W-W	M22S-T-W-W
Red	85–264 Vac	M22-T-R-230R	M22S-T-R-230R
Blue		M22-T-R-230B	M22S-T-B-230B
Yellow		M22-T-Y-230W	M22S-T-Y-230W
Green		M22-T-G-230G	M22S-T-G-230G
White		M22-T-W-230W	M22S-T-W-230W

Operators Only <sup>②</sup>

M22-DLH-R



M22S-DLH-R



M22M-DLH-R



Button Color	Silver Bezel Catalog Number	Black Bezel Catalog Number	Metal Bezel Catalog Number
Red	M22-DLH-R	M22S-DLH-R	M22M-DLH-R
Green	M22-DLH-G	M22S-DLH-G	M22M-DLH-G
White	M22-DLH-W	M22S-DLH-W	M22M-DLH-W
Blue	M22-DLH-B	M22S-DLH-B	M22M-DLH-B
Yellow	M22-DLH-Y	M22S-DLH-Y	M22M-DLH-Y
Amber	M22-DLH-A	M22S-DLH-A	M22M-DLH-A

M22-DGLH-R



## Silver Guarded

Button Color	Silver Bezel Catalog Number
Red	M22-DGLH-R
Green	M22-DGLH-G
White	M22-DGLH-W
Blue	M22-DGLH-B
Yellow	M22-DGLH-Y

## Notes

- ① All NC contact blocks are positively driven contact. ⊖
- ② Includes contact block mounting adapter.

### Illuminated Pushbuttons, Extended, Momentary

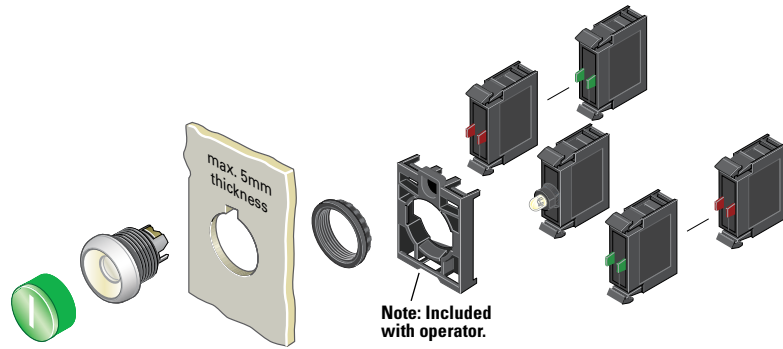

#### Components

##### M22-XDH-R



#### Button Lenses <sup>①</sup>

Color	Inscription	Catalog Number
Red	—	M22-XDLH-R <sup>②</sup>
	Custom	M22-XDLH-R-ETCH <sup>③</sup>
	STOP	M22-XDLH-R-GB0
	OFF	M22-XDLH-R-GB5
	Ⓞ	M22-XDLH-R-X0
Green	—	M22-XDLH-G <sup>②</sup>
	Custom	M22-XDLH-G-ETCH <sup>③</sup>
	START	M22-XDLH-G-GB1
	ON	M22-XDLH-G-GB6
	Ⓛ	M22-XDLH-G-X1
Blue	—	M22-XDLH-B <sup>②</sup>
	Custom	M22-XDLH-B-ETCH <sup>③</sup>
	RESET	M22-XDLH-B-GB14
	Ⓜ	M22-XDLH-B-X6
White	—	M22-XDLH-W <sup>②</sup>
Yellow	Custom	M22-XDLH-W-ETCH <sup>③</sup>
	—	M22-XDLH-Y <sup>②</sup>
Amber	Custom	M22-XDLH-Y-ETCH <sup>③</sup>
	—	M22-XDLH-A
	Custom	M22-XDLH-A-ETCH

##### M22-DL-X



#### Buttonless Operator

Silver Bezel Catalog Number <sup>④</sup>	Black Bezel Catalog Number <sup>④</sup>	Metal Bezel Catalog Number <sup>④</sup>
M22-DL-X	M22S-DL-X	M22M-DL-X

##### M22S-DL-X



##### M22M-DL-X



##### M22-DGL-X



#### Silver Guarded

Silver Bezel Catalog Number <sup>④</sup>
M22-DGL-X

##### M22-LED-W



#### Light Units <sup>①</sup>

Terminal Type	LED Color	Light Unit Voltage	Catalog Number
Screw	White	12–30 Vac/Vdc	M22-LED-W
	Red		M22-LED-R
	Green		M22-LED-G
	Blue		M22-LED-B
Screw	White	85–264 Vac	M22-LED230-W
	Red		M22-LED230-R
	Green		M22-LED230-G
Spring-cage	White	12–30 Vac/Vdc	M22-FLED-W
	Red		M22-FLED-R
	Green	M22-FLED-G	
	Blue	M22-FLED-B	
	Red/Green/Yellow	24 Vdc	M22-FLED-RG <sup>⑤</sup>
	Red, Green, Blue, Yellow, White, Violet, Turquoise		M22-FLED-RGB <sup>⑤</sup>

##### M22-FLED-



##### M22-K10



#### Contact Blocks <sup>①</sup>

Terminal Type	Contact Configuration <sup>⑤</sup>	Catalog Number
Screw	NO	M22-K10
	NO, early-make	M22-K10P
	NC	M22-K01
	NC, late-break	M22-K01D
Spring-cage	NO	M22-CK10
	NC	M22-CK01
	NC, late-break	M22-CK01D
	2NO	M22-CK20
	2NC	M22-CK02
	NO-NC	M22-CK11
	NC	M22-FK01 <sup>⑦</sup>
NO	M22-FK10 <sup>⑦</sup>	

##### M22-FK01



#### Notes

- For complete listing of available button lenses, light units and contact blocks, see Accessories, **Pages V7-T1-111 to V7-T1-116**.
- Minimum order quantity of (10).
- When ordering, specify inscription per catalog number suffix from the Symbols Library (see **Pages V7-T1-129 to V7-T1-136**) into the Order Notes. For example, M22-XDH-S-ETCH; Order Notes: Mark with symbol X91, Line item # \_.
- Includes contact block mounting adapter.
- Please see color input key on **Page V7-T1-114**.
- All NC contact blocks are positively driven contact. ⊖
- Additional contacts may not be stacked behind M22-F type contact blocks, M22-F can be stacked behind standard M22 contacts only.

#### 1

#### Illuminated Pushbuttons, Extended, Maintained <sup>①</sup>

M22-DRLH-W



M22S-DRLH-W



M22M-DRLH-W



#### Operators Only <sup>②</sup>

Button Color	Silver Bezel Catalog Number	Black Bezel Catalog Number	Metal Bezel Catalog Number
Red	M22-DRLH-R	M22S-DRLH-R	M22M-DRLH-R
Green	M22-DRLH-G	M22S-DRLH-G	M22M-DRLH-G
White	M22-DRLH-W	M22S-DRLH-W	M22M-DRLH-W
Blue	M22-DRLH-B	M22S-DRLH-B	M22M-DRLH-B
Yellow	M22-DRLH-Y	M22S-DRLH-Y	M22M-DRLH-Y
Amber	M22-DRLH-A	M22S-DRLH-A	M22M-DRLH-A

#### Notes

- ① Maintained pushbuttons can be converted in the field to momentary operation by switching the locking ring, which is accessible through the side of the operator body.
- ② Includes contact block mounting adapter.

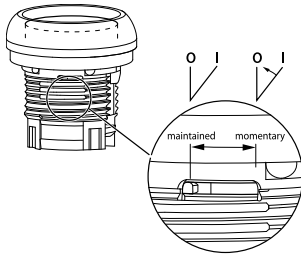

**Note:** This pilot device features a selectable function switch that enables the device to be set to either maintained or momentary operation.

### Illuminated Pushbuttons, Extended, Maintained <sup>①</sup>

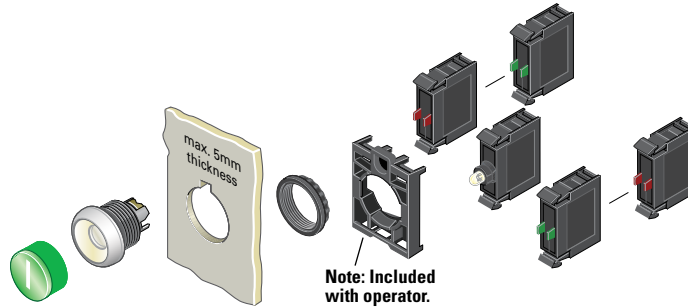

#### Components

##### M22-XDLH-W



#### Button Lenses <sup>②</sup>

Color	Inscription	Catalog Number
Red	—	<b>M22-XDLH-R</b> <sup>③</sup>
	Custom	<b>M22-XDLH-R-ETCH</b> <sup>④</sup>
	STOP	<b>M22-XDLH-R-GB0</b>
	OFF	<b>M22-XDLH-R-GB5</b>
	⊙	<b>M22-XDLH-R-X0</b>
Green	—	<b>M22-XDLH-G</b> <sup>③</sup>
	Custom	<b>M22-XDLH-G-ETCH</b> <sup>④</sup>
	START	<b>M22-XDLH-G-GB1</b>
	ON	<b>M22-XDLH-G-GB6</b>
	⓪	<b>M22-XDLH-G-X1</b>
Blue	—	<b>M22-XDLH-B</b> <sup>③</sup>
	Custom	<b>M22-XDLH-B-ETCH</b> <sup>④</sup>
	RESET	<b>M22-XDLH-B-GB14</b>
	Ⓜ	<b>M22-XDLH-B-X6</b>
White	—	<b>M22-XDLH-W</b> <sup>③</sup>
Yellow	Custom	<b>M22-XDLH-W-ETCH</b> <sup>④</sup>
	—	<b>M22-XDLH-Y</b> <sup>③</sup>
Amber	—	<b>M22-XDLH-A</b>
	Custom	<b>M22-XDLH-A-ETCH</b>

#### Buttonless Operator

Silver Bezel Catalog Number <sup>⑤</sup>	Black Bezel Catalog Number <sup>⑤</sup>	Metal Bezel Catalog Number <sup>⑤</sup>
<b>M22-DRL-X</b>	<b>M22S-DRL-X</b>	<b>M22M-DRL-X</b>

##### M22-DRL-X



##### M22S-DRL-X



##### M22M-DRL-X



##### M22-LED-W



##### M22-FLED-\_\_



#### Light Units <sup>②</sup>

Terminal Type	LED Color	Light Unit Voltage	Catalog Number
Screw	White	12–30 Vac/Vdc	<b>M22-LED-W</b>
	Red		<b>M22-LED-R</b>
	Green		<b>M22-LED-G</b>
	Blue		<b>M22-LED-B</b>
Screw	White	85–264 Vac	<b>M22-LED230-W</b>
	Red		<b>M22-LED230-R</b>
	Green		<b>M22-LED230-G</b>
Spring-cage	White	12–30 Vac/Vdc	<b>M22-FLED-W</b>
	Red		<b>M22-FLED-R</b>
	Green	<b>M22-FLED-G</b>	
	Blue	<b>M22-FLED-B</b>	
	Red/Green/Yellow	24 Vdc	<b>M22-FLED-RG</b> <sup>⑥</sup>
	Red, Green, Blue, Yellow, White, Violet, Turquoise		<b>M22-FLED-RGB</b> <sup>⑥</sup>

##### M22-K10



##### M22-FK01



#### Contact Blocks <sup>②</sup>

Terminal Type	Contact Configuration <sup>⑦</sup>	Catalog Number
Screw	NO	<b>M22-K10</b>
	NO, early-make	<b>M22-K10P</b>
	NC	<b>M22-K01</b>
	NC, late-break	<b>M22-K01D</b>
Spring-cage	NO	<b>M22-CK10</b>
	NC	<b>M22-CK01</b>
	NC, late-break	<b>M22-CK01D</b>
	2NO	<b>M22-CK20</b>
	2NC	<b>M22-CK02</b>
	NO-NC	<b>M22-CK11</b>
	NC	<b>M22-FK01</b> <sup>⑧</sup>
	NO	<b>M22-FK10</b> <sup>⑧</sup>

#### Notes

- ① Maintained pushbuttons can be converted in the field to momentary operation by switching the locking ring, which is accessible through the side of the operator body.
- ② For complete listing of available button lenses, light units and contact blocks, see Accessories, **Pages V7-T1-111 to V7-T1-116**.
- ③ Minimum order quantity of (10).
- ④ When ordering, specify inscription per catalog number suffix from the Symbols Library (see **Pages V7-T1-129 to V7-T1-136**) into the Order Notes. For example, M22-XDLH-S-ETCH; Order Notes: Mark with symbol X91, Line item #\_.
- ⑤ Includes contact block mounting adapter.
- ⑥ Please see color input key on **Page V7-T1-114**.
- ⑦ All NC contact blocks are positively driven contact. ⊖
- ⑧ Additional contacts may not be stacked behind M22-F type contact blocks, M22-F can be stacked behind standard M22 contacts only.

#### 1

### Indicating Lights

#### Product Description

Eaton's M22 indicating lights use the combination of a durable, bright LED unit and modern lenses designed specifically for this type of LED to create a bright and visible indicating light.

As with the pushbuttons, the indicating light lenses can be laser engraved. Indicating lights can be ordered as complete devices, including lens and LED unit, or as modular components.

#### Features

- Customizable laser engraving on all lenses
- LED offering only for improved brightness quality and up to 100,000 hours of operation
- Lenses designed specifically for LED illumination
- Modular construction makes assembly fast and simplifies stocking of components and complete devices
- Capable of communicating via ASi protocol with ASi adapter modules

#### Protection Type

- IP67, IP69K
- NEMA 4X, 13

### Catalog Number Selection

Catalog Number Selection is for illustrative purposes only and not to be used to create new catalog numbers.

#### Indicating Lights

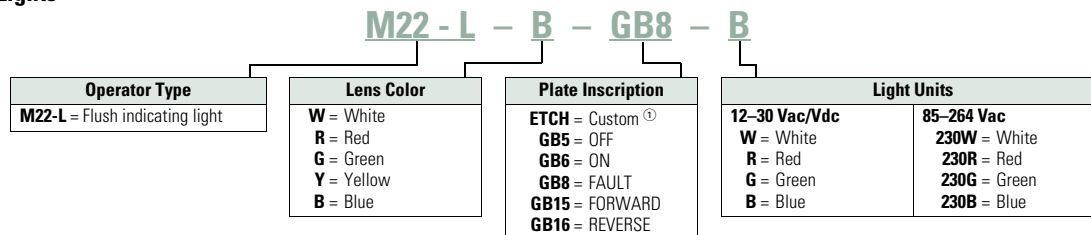

**Note:** Light unit should match color of lens. Use white light unit with yellow lens.

<sup>①</sup> When ordering, specify inscription per catalog number suffix from the Symbols Library (see **Pages V7-T1-129 to V7-T1-136**) into the Order Notes. For example, M22-L-B-ETCH; Order Notes: Mark with symbol X91, Line item #\_.

### Product Selection

#### Indicating Lights, Flush

##### M22-L-R-R



#### Complete Devices

Lens Color	Light Color	Light Unit Voltage	Catalog Number
White	White	12–30 Vac/Vdc	<b>M22-L-W-W</b>
Red	Red		<b>M22-L-R-R</b>
Green	Green		<b>M22-L-G-G</b>
Yellow	White		<b>M22-L-Y-W</b>
Blue	Blue		<b>M22-L-B-B</b>
Amber	White		<b>M22-L-A-W</b>
White	White	85–264 Vac	<b>M22-L-W-230W</b>
Red	Red		<b>M22-L-R-230R</b>
Green	Green		<b>M22-L-G-230G</b>
Yellow	White		<b>M22-L-Y-230W</b>
Blue	Blue		<b>M22-L-B-230B</b>
Amber	White		<b>M22-L-A-230W</b>

#### Operators Only <sup>①</sup>

##### M22-L-R



Lens Color	Catalog Number
<b>Flat</b>	
White	<b>M22-L-W</b>
Red	<b>M22-L-R</b>
Green	<b>M22-L-G</b>
Yellow	<b>M22-L-Y</b>
Blue	<b>M22-L-B</b>
Amber	<b>M22-L-A</b>

##### M22-LH-R



Lens Color	Catalog Number
<b>Conical</b>	
White	<b>M22-LH-W</b>
Red	<b>M22-LH-R</b>
Green	<b>M22-LH-G</b>
Yellow	<b>M22-LH-Y</b>
Blue	<b>M22-LH-B</b>
Amber	<b>M22-LH-A</b>

#### Note

<sup>①</sup> Includes contact block mounting adapter.

### Indicating Lights, Flush

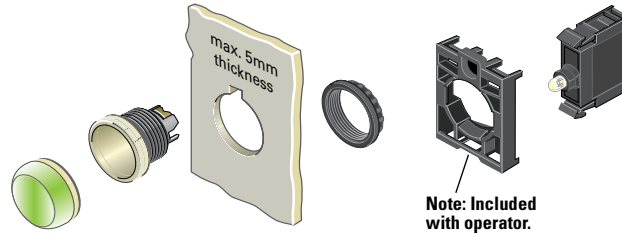

### Components

#### M22-XL-R



#### Lenses ①

Color	Inscription	Catalog Number
<b>Flat</b>		
Red	—	<b>M22-XL-R</b> ②
	Custom	<b>M22-XL-R-ETCH</b> ③
	OFF	<b>M22-XL-R-GB5</b>
Green	—	<b>M22-XL-G</b> ②
	Custom	<b>M22-XL-G-ETCH</b> ③
	ON	<b>M22-XL-G-GB6</b>
	REVERSE	<b>M22-XL-G-GB16</b>
Blue	—	<b>M22-XL-B</b> ②
	Custom	<b>M22-XL-B-ETCH</b> ③
	FAULT	<b>M22-XL-B-GB8</b>
	—	<b>M22-XL-W</b> ②
White	—	<b>M22-XL-W</b> ②
	Custom	<b>M22-XL-W-ETCH</b> ③
	OFF	<b>M22-XL-W-GB5</b>
	ON	<b>M22-XL-W-GB6</b>
	FAULT	<b>M22-XL-W-GB8</b>
Yellow	—	<b>M22-XL-Y</b> ②
	Custom	<b>M22-XL-Y-ETCH</b> ③
	—	<b>M22-XL-A</b> ②
Amber	—	<b>M22-XL-A</b> ②
	Custom	<b>M22-XL-A-ETCH</b> ③
<b>Conical</b>		
Red	—	<b>M22-XLH-R</b>
Green	—	<b>M22-XLH-G</b>
Blue	—	<b>M22-XLH-B</b>
White	—	<b>M22-XLH-W</b>
Yellow	—	<b>M22-XLH-Y</b>
Amber	—	<b>M22-XLH-A</b>

#### M22-LED-W



#### M22-FLED-\_\_



#### Light Units ③④

Terminal Type	LED Color	Light Unit Voltage	Catalog Number
Screw	White	12–30	<b>M22-LED-W</b>
	Red	Vac/Vdc	<b>M22-LED-R</b>
	Green		<b>M22-LED-G</b>
	Blue		<b>M22-LED-B</b>
Screw	White	85–264	<b>M22-LED230-W</b>
	Red	Vac	<b>M22-LED230-R</b>
	Green		<b>M22-LED230-G</b>
	Blue		<b>M22-LED230-B</b>
Spring-cage	White	12–30	<b>M22-FLED-W</b>
	Red	Vac/Vdc	<b>M22-FLED-R</b>
	Green		<b>M22-FLED-G</b>
	Blue		<b>M22-FLED-B</b>
	Red/Green/Yellow	24 Vdc	<b>M22-FLED-RG</b> ⑤
	Red, Green, Blue, Yellow, White, Violet, Turquoise		<b>M22-FLED-RGB</b> ⑤

#### Notes

- ① For complete listing of available lenses and light units, see Accessories, **Pages V7-T1-111 to V7-T1-116**.
- ② Minimum order quantity of (10).
- ③ When ordering, specify inscription per catalog number suffix from the Symbols Library (see **Pages V7-T1-129 to V7-T1-136**) into the Order Notes. For example, M22-XL-R-ETCH; Order Notes: Mark with symbol X91, Line item #\_.
- ④ Select the same color LED element as lens color; for yellow and amber lenses, choose a white LED.
- ⑤ Please see color input key on **Page V7-T1-114**.

#### M22-L-X



#### Lensless Indicating Light

#### Catalog Number

**M22-L-X**

#### 1

### Emergency Stops

#### Product Description

Eaton's M22 emergency stops are a durable and reliable solution to a variety of e-stop applications. With standard push-pull, as well as twist-to-release and key-release, illuminated options and red or black operators, the M22 e-stop is a robust solution. As with all operators, they can be ordered as a ready to install complete device or as modular components for the perfect fit.

#### Features

- Push-pull and twist to release options available as well as illuminated and keyed release
- LED offering only for improved brightness quality and up to 100,000 hours of operation
- More than 100,000 mechanical operations
- Capable of communicating via ASi protocol with ASi adapter modules
- Suitable for use in safety applications up to Category-4 or Sil-3

#### Protection Type

- IP67, IP69K (IP66 key-release)
- NEMA 4X, 13

### Catalog Number Selection

Catalog Number Selection is for illustrative purposes only and not to be used to create new catalog numbers.

#### Emergency Stops

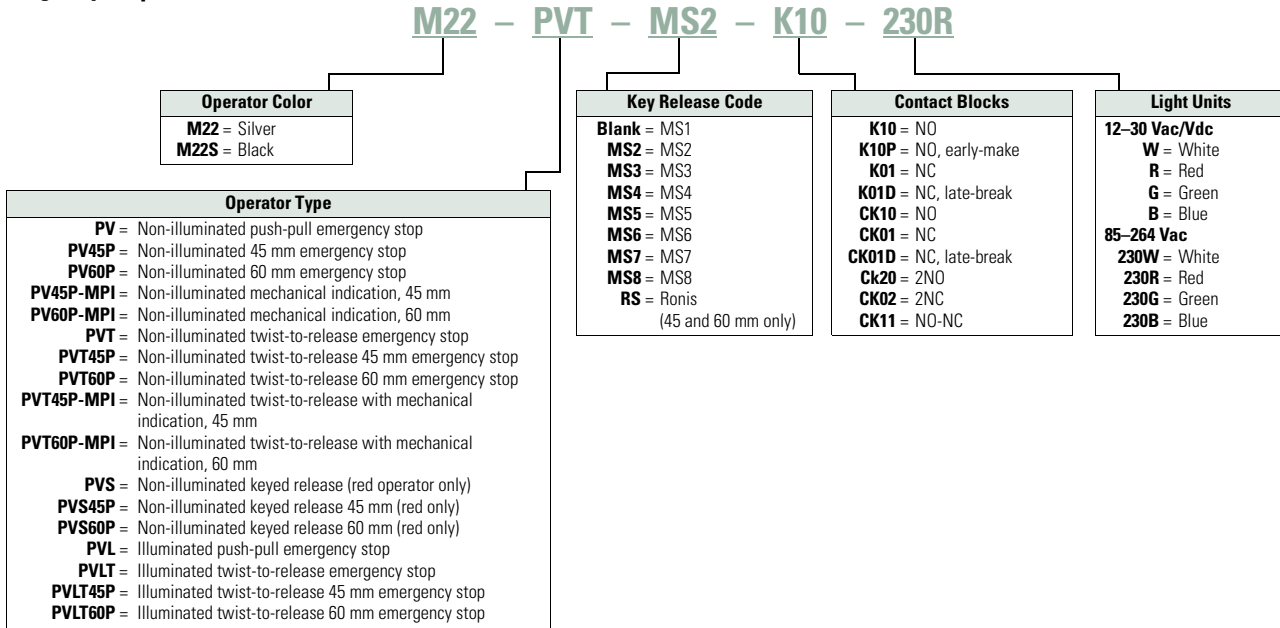

### Product Selection

#### Non-Illuminated and Illuminated Emergency Stops

##### Complete Devices

Type	Button Color	LED Color	Contact Block Configuration <sup>①</sup>	Light Unit Voltage	Catalog Number		
<b>M22-PV-K01</b>							
	<b>Non-Illuminated</b>						
	Push-pull	Red	—	NC	—	<b>M22-PV-K01</b>	
				2NC		<b>M22-PV-K02</b>	
				1NO-2NC		<b>M22-PV-K12</b>	
	Twist-to-release	Red	—	NC	—	<b>M22-PVT-K01</b>	
				2NC		<b>M22-PVT-K02</b>	
				1NO-2NC		<b>M22-PVT-K12</b>	
	Key release	Red	—	NC	—	<b>M22-PVS-K01</b>	
				2NC		<b>M22-PVS-K02</b>	
1NO-2NC				<b>M22-PVS-K12</b>			
<b>M22-PVL-K01-R</b>							
	<b>Illuminated</b>						
	Push-pull	Red	Red	NC	12–30 Vac/Vdc	<b>M22-PVL-K01-R</b>	
				2NC		<b>M22-PVL-K02-R</b>	
				1NO-2NC		<b>M22-PVL-K12-R</b>	
				NC		85–264 Vac	<b>M22-PVL-K01-230R</b>
				2NC			<b>M22-PVL-K02-230R</b>
				1NO-2NC			<b>M22-PVL-K12-230R</b>
	Twist-to-release	Red	Red	NC	12–30 Vac/Vdc	<b>M22-PVLT-K01-R</b>	
				2NC		<b>M22-PVLT-K02-R</b>	
				1NO-2NC		<b>M22-PVLT-K12-R</b>	
				NC		85–264 Vac	<b>M22-PVLT-K01-230R</b>
				2NC			<b>M22-PVLT-K02-230R</b>
1NO-2NC				<b>M22-PVLT-K12-230R</b>			

**Note**

<sup>①</sup> All NC contact blocks are positively driven contact. ⊖



#### Non-Illuminated and Illuminated Emergency Stops

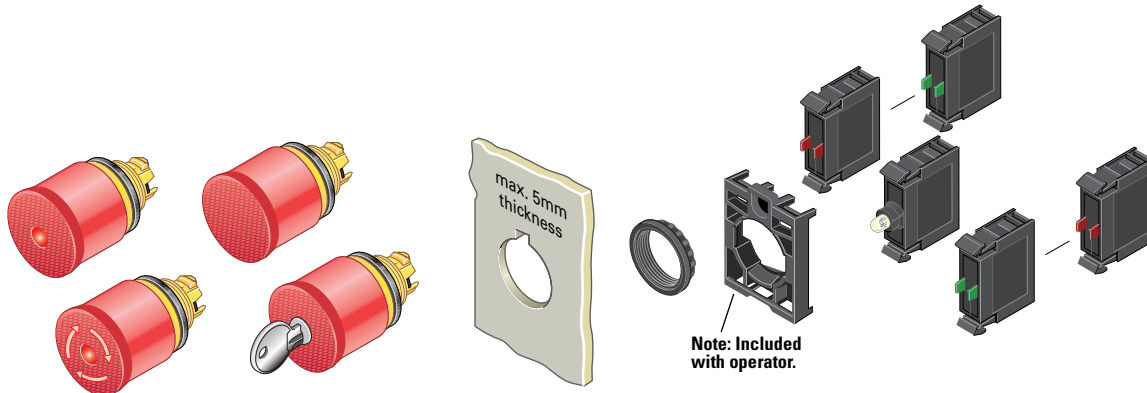

#### Components

##### M22-PVL



#### Push-Pull Emergency Stops

Illumination/Indication	Actuator Size	Catalog Number
None	35 mm	<b>M22-PV</b>
	45 mm	<b>M22-PV45P</b>
	60 mm	<b>M22-PV60P</b>
LED illumination	35 mm	<b>M22-PVL</b>
	45 mm	<b>M22-PVL45P</b>
	60 mm	<b>M22-PVL60P</b>
Mechanical indication	45 mm	<b>M22-PV45P-MPI</b>
	60 mm	<b>M22-PV60P-MPI</b>

##### M22-PVS60P-MS1



#### Key Release Emergency Stops ②

Actuator Size	Key Code	Catalog Number	
35 mm	MS1	<b>M22-PVS</b> ③	
	MS2	<b>M22-PVS-MS2</b>	
	MS3	<b>M22-PVS-MS3</b>	
	MS4	<b>M22-PVS-MS4</b>	
	MS5	<b>M22-PVS-MS5</b>	
	MS6	<b>M22-PVS-MS6</b>	
	MS7	<b>M22-PVS-MS7</b>	
	MS8	<b>M22-PVS-MS8</b>	
45 mm	MS1	<b>M22-PVS45P</b>	
	MS2	<b>M22-PVS45P-MS2</b>	
	MS3	<b>M22-PVS45P-MS3</b>	
	MS4	<b>M22-PVS45P-MS4</b>	
	MS5	<b>M22-PVS45P-MS5</b>	
	MS6	<b>M22-PVS45P-MS6</b>	
	MS7	<b>M22-PVS45P-MS7</b>	
	MS8	<b>M22-PVS45P-MS8</b>	
	Ronis	<b>M22-PVS45P-RS</b>	
	60 mm	MS1	<b>M22-PVS60P</b>
		MS2	<b>M22-PVS60P-MS2</b>
		MS3	<b>M22-PVS60P-MS3</b>
		MS4	<b>M22-PVS60P-MS4</b>
		MS5	<b>M22-PVS60P-MS5</b>
		MS6	<b>M22-PVS60P-MS6</b>
		MS7	<b>M22-PVS60P-MS7</b>
MS8		<b>M22-PVS60P-MS8</b>	
Ronis	<b>M22-PVS60P-RS</b>		

##### M22-PVT45P-MPI



#### Twist-to-Release Emergency Stops

Illumination/Indication	Actuator Size	Catalog Number
None	35 mm	<b>M22-PVT</b>
	45 mm	<b>M22-PVT45P</b>
	60 mm	<b>M22-PVT60P</b>
LED illumination	35 mm	<b>M22-PVLT</b>
	45 mm	<b>M22-PVLT45P</b>
	60 mm	<b>M22-PVLT60P</b>
Mechanical indication	45 mm	<b>M22-PVT45P-MPI</b>
	60 mm	<b>M22-PVT60P-MPI</b>

##### M22S-PVLT



#### Machine Stop Operators (Black) ①





Illumination	Type	Actuator Size	Catalog Number
Non-illuminated	Push-pull	35 mm	<b>M22S-PV</b>
	Twist-to-release	35 mm	<b>M22S-PVT</b>
LED illumination	Push-pull	35 mm	<b>M22S-PVL</b>
	Twist-to-release	35 mm	<b>M22S-PVLT</b>

#### Notes



- ① Includes contact block mounting adapter.
- ② Key included. For identical locks and keys, use the same key code. One key is included with actuator; additional keys are available as accessories.
- ③ Includes Key Code MS1.

Maximum number of contacts: four M22-(C)K01, ...10, or two M22-(C)K02, ...20, ...11. Refer to IL or technical data sheet for more information.

### Contact Blocks <sup>①</sup>

	Terminal Type	Mounting Location <sup>②</sup>	Contact Configuration <sup>③</sup>	Catalog Number	
<b>M22-K10</b> 	Screw	Front	NO	<b>M22-K10</b>	
			NO, early-make	<b>M22-K10P</b>	
			NC	<b>M22-K01</b>	
			NC, late-break	<b>M22-K01D</b>	
			NC <sup>④</sup>	<b>M22-K01PV6</b>	
			SMCB, NC	<b>M22-K01SMC10</b>	
			SMCB, 2NC	<b>M22-K02SMC10</b>	
			Base	SMCB, NC	<b>M22-KC01SMC10</b>
			SMCB, 2NC	<b>M22-KC02SMC10</b>	
			<b>M22-K01SMC10</b> 	Self-monitoring (1NC and 1NO in series)	Front
2NC	<b>M22-K02SMC10</b>				
Base	1NC	<b>M22-KC01SMC10</b>			
	2NC	<b>M22-KC02SMC10</b>			
<b>FK01SMC10</b> 	Self-monitoring spring-cage		NC	<b>M22-FK01SMC10</b>	
			3NC	<b>M22-AFK03SMC10</b>	
<b>M22-FK01</b> 	Spring-cage	Front	NO	<b>M22-CK10</b>	
			NC	<b>M22-CK01</b>	
			NC, late-break	<b>M22-CK01D</b>	
			2NO	<b>M22-CK20</b>	
			2NC	<b>M22-CK02</b>	
			NO-NC	<b>M22-CK11</b>	
			NC	<b>M22-FK01</b> <sup>⑤</sup>	
NO	<b>M22-FK10</b> <sup>⑤</sup>				

### Light Units <sup>①</sup>

	Terminal Type	LED Color	Light Unit Voltage	Catalog Number
<b>M22-LED-W</b> 	Screw	White	12–30 Vac/Vdc	<b>M22-LED-W</b>
		Red	12–30 Vac/Vdc	<b>M22-LED-R</b>
	Screw	White	85–264 Vac	<b>M22-LED230-W</b>
		Red	85–264 Vac	<b>M22-LED230-R</b>
<b>M22-FLED-</b> 	Screw	White	207–264 Vac	<b>M22-LED230H-W</b>
		Red	207–264 Vac	<b>M22-LED230H-R</b>
	Spring-cage	White	12–30 Vac/Vdc	<b>M22-FLED-W</b>
		Red	12–30 Vac/Vdc	<b>M22-FLED-R</b>





### M22-ES-MS1



### Extra Keys <sup>⑥</sup>

For Key Code	Catalog Number
MS1	<b>M22-ES-MS1</b>
MS2	<b>M22-ES-MS2</b>
MS3	<b>M22-ES-MS3</b>
MS4	<b>M22-ES-MS4</b>
MS5	<b>M22-ES-MS5</b>
MS6	<b>M22-ES-MS6</b>
MS7	<b>M22-ES-MS7</b>
MS8	<b>M22-ES-MS8</b>

### Accessories

Description	Voltage	Catalog Number
<b>M22-XGPV</b> 	—	<b>M22-XGPV</b>
<b>M22G-XGPV</b> 	—	<b>M22G-XGPV</b>
<b>M22-MGTA</b> 	—	<b>M22-MGTA</b>
<b>M22-PL-PV</b> 	—	<b>M22-PL-PV</b>
<b>M22-XPV60-Y-120</b> 	24 Vac/Vdc	<b>M22-XPV60-Y-24</b>
	120 Vac	<b>M22-XPV60-Y-120</b>
	230 Vac	<b>M22-XPV60-Y-230</b>

### Notes

- For complete listing of available contact blocks, see Accessories, Pages V7-T1-111 to V7-T1-116.
- Self-monitoring contact blocks (SMCB type) cannot be used with illuminated emergency stops.
- All NC contact blocks are positively driven contact.  $\ominus$
- Allows up to six contact blocks to be utilized, For use only with only M22-PV\_.
- Additional contacts may not be stacked behind M22-F type contact blocks, M22-F can be stacked behind standard M22 contacts only.
- For use with key release operators only. One key included with operator.

Maximum number of contacts: four M22-(C)K01, ..., 10, or two M22-(C)K02, ..., 20, ..., 11. Refer to IL or technical data sheet for more information.

## Selector Switches



## Selector Switches

### Product Description

Eaton's M22 selector switch line offers an almost endless variety of options in maintained/momentary, key-removal and illuminated devices. The coding adapters used for maintained/momentary and key removal positions make the M22 stand out from competitive devices. By simply adding or removing a coding adapter from inside the operator, the end-user can change the function of the button. Operator options include standard knob, rotary head, illuminated and keyed versions. As with all operators, they can be ordered as a ready to install complete device or as modular components to meet application specific requirements.

### Features

- Adding or removing coding adapters allows for field convertibility of maintained/momentary and key removal positions
- LED offering only for improved brightness quality and up to 100,000 hours of operation
- More than 100,000 mechanical operations
- Coding adapter options make assembly fast and simplify stocking of different configurations of selector switches
- Capable of communicating via ASi protocol with ASi adapter modules

### Protection Type

- IP66
- NEMA 4X, 13

## Contents

### Description

	<i>Page</i>
Selector Switches	
Non-Illuminated Switches . . . . .	<b>V7-T1-79</b>
Illuminated Switches . . . . .	<b>V7-T1-84</b>
Key Operated . . . . .	<b>V7-T1-88</b>

### Catalog Number Selection

Catalog Number Selection is for illustrative purposes only and not to be used to create new catalog numbers.

### Non-Illuminated Selector Switches

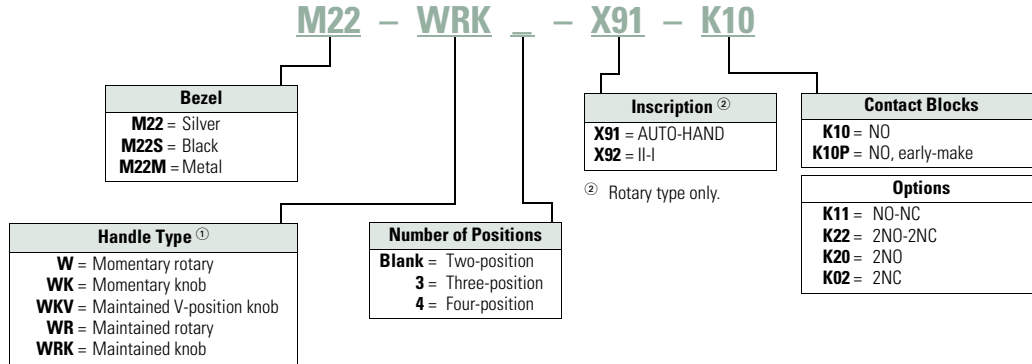

<sup>①</sup> All momentary selector switches can be converted in the field to maintained operation with the removal of a color-coded adapter.

# 1

## Product Selection

### Non-Illuminated Selector Switches



M22-WKV-K10



M22M-WKV-K10

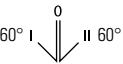

#### Complete Devices, Knob Type ①

Type	Switching Position	Contact Block Configuration ②	Silver Bezel Catalog Number	Black Bezel Catalog Number	Metal Bezel Catalog Number
Two-position	Maintained 	NO	M22-WRK-K10	M22S-WRK-K10	M22M-WRK-K10
		1NO-1NC	M22-WRK-K11	M22S-WRK-K11	M22M-WRK-K11
		2NO-2NC	M22-WRK-K22	M22S-WRK-K22	M22M-WRK-K22
Two-position	Maintained V 	NO	M22-WKV-K10	M22S-WKV-K10	M22M-WKV-K10
		1NO-1NC	M22-WKV-K11	M22S-WKV-K11	M22M-WKV-K11
		2NO-2NC	M22-WKV-K22	M22S-WKV-K22	M22M-WKV-K22
Three-position	Maintained 	2NO	M22-WRK3-K20	M22S-WRK3-K20	M22M-WRK3-K20
		2NO-2NC	M22-WRK3-K22	M22S-WRK3-K22	M22M-WRK3-K22

#### Notes

- ① Includes contact block mounting adapter.
- ② All NC contact blocks are positively driven contact. ⊖

### Non-Illuminated Selector Switches

#### Components





M22-WK



M22M-WK

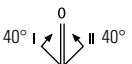
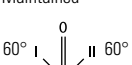
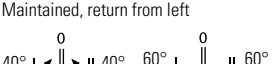
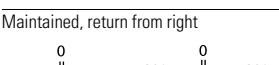
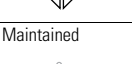

#### Operators Only, Knob Type ①

Type	Switching Position	Silver Bezel Catalog Number	Black Bezel Catalog Number	Metal Bezel Catalog Number
Two-position	Momentary ② 	<b>M22-WK</b>	<b>M22S-WK</b>	<b>M22M-WK</b>
	Maintained 	<b>M22-WRK</b>	<b>M22S-WRK</b>	<b>M22M-WRK</b>
	Maintained V 	<b>M22-WKV</b>	<b>M22S-WKV</b>	<b>M22M-WKV</b>
Three-position	Momentary ② 	<b>M22-WK3</b>	<b>M22S-WK3</b>	<b>M22M-WK3</b>
	Maintained 	<b>M22-WRK3</b>	<b>M22S-WRK3</b>	<b>M22M-WRK3</b>
	Maintained, return from left 	<b>M22-WRK3-2</b>	<b>M22S-WRK3-2</b>	<b>M22M-WRK3-2</b>
	Maintained, return from right 	<b>M22-WRK3-1</b>	<b>M22S-WRK3-1</b>	<b>M22M-WRK3-1</b>
	Maintained 	<b>M22-WRK4</b>	<b>M22S-WRK4</b>	<b>M22M-WRK4</b>
	Maintained 	<b>M22-WRK4</b>	<b>M22S-WRK4</b>	<b>M22M-WRK4</b>

#### Notes

- ① Includes contact block mounting adapter.
- ② Momentary selector switches can be converted in the field to maintained operation with the removal of a color coded adapter. See **Page V7-T1-118**.

# 1

## Non-Illuminated Selector Switches

### Components

M22S-WR3-X94

#### Operators Only, Rotary Type ①



Type	Switching Position	Inscription	Silver Bezel Catalog Number	Black Bezel Catalog Number	Metal Bezel Catalog Number
Two-position	Momentary ②	I-O	M22-W	M22S-W	M22M-W
	Maintained	I-O	M22-WR	M22S-WR	M22M-WR
		Custom	M22-WR-ETCH ③	M22S-WR-ETCH ③	M22M-WR-ETCH ③
		AUTO-HAND	M22-WR-X91	M22S-WR-X91	M22M-WR-X91
		II-I	M22-WR-X92	M22S-WR-X92	M22M-WR-X92
Three-position	Momentary ②	I-O-II	M22-W3	M22S-W3	M22M-W3
	Maintained	I-O-II	M22-WR3	M22S-WR3	M22M-WR3
		Custom	M22-WR3-ETCH ③	M22S-WR3-ETCH ③	M22M-WR3-ETCH ③
		AUTO-O-MAN	M22-WR3-X94	M22S-WR3-X94	M22M-WR3-X94
		0-1-0-2-0-3-0-4	M22-WR4	M22S-WR4	M22M-WR4
Four-position	Maintained	0-1-0-2-0-3-0-4	M22-WR4	M22S-WR4	M22M-WR4

#### Notes

- ① Includes contact block mounting adapter.
- ② Momentary selector switches can be converted in the field to maintained operation with the removal of a color coded adapter. See **Page V7-T1-118**.
- ③ When ordering, specify inscription per catalog number suffix from the Symbols Library (see **Pages V7-T1-129 to V7-T1-136**) into the Order Notes. For example, M22-WR3-ETCH; Order Notes: Mark with symbol X88, Line item #\_.

### Non-Illuminated Selector Switches

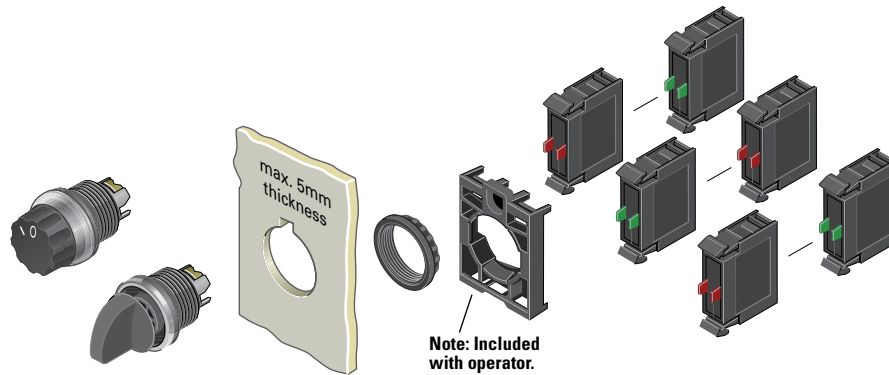

### Components

#### M22-K10







#### M22-FK01



#### Contact Blocks <sup>①</sup>

Terminal Type	Contact Configuration <sup>②</sup>	Catalog Number
Screw	NO	M22-K10
	NO, early-make	M22-K10P
	NC	M22-K01
	NC, late-break	M22-K01D
Spring-cage	NO	M22-CK10
	NC	M22-CK01
	NC, late-break	M22-CK01D
	2NO	M22-CK20
	2NC	M22-CK02
	NO-NC	M22-CK11
	NC	M22-FK01 <sup>③</sup>
	NO	M22-FK10 <sup>③</sup>

#### Accessories

	Description	Catalog Number
M22-XW 	Plunger bridge <sup>④</sup>	M22-XW
M22-XWS 	Key cover	M22-XWS
M22-XC-R 	Key withdraw adapter <sup>⑤</sup>	M22-XC-R
M22-XC-Y 	Coding adapter	M22-XC-Y
M22-XGWK 	Guard ring	M22-XGWK

#### Notes

- ① For complete listing of available contact blocks, see Accessories, Pages V7-T1-111 to V7-T1-116.
- ② All NC contact blocks are positively driven contact. ⊖
- ③ Additional contacts may not be stacked behind M22-F type contact blocks, M22-F can be stacked behind standard M22 contacts only.
- ④ Plunger needed to actuate center-mounted contact blocks. Used for non-illuminated three-position selector switches only.
- ⑤ Enables a keyed selector switch to be set to user-selected key withdraw position.



#### 1

### Catalog Number Selection

Catalog Number Selection is for illustrative purposes only and not to be used to create new catalog numbers.

#### Illuminated Selector Switches

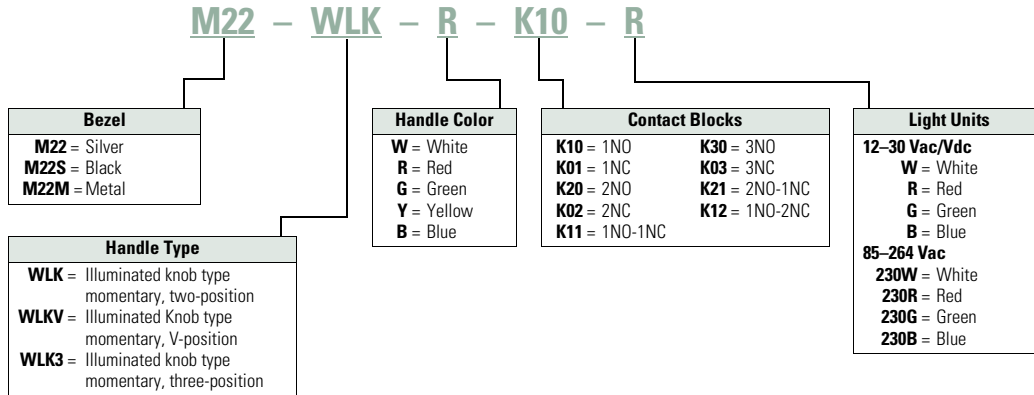

**Product Selection**



**Illuminated Selector Switches**

**Components**

M22-WLK-W

**Operators Only, Knob Type** <sup>①</sup>



Type	Switching Position	Button Color	Silver Bezel Catalog Number	Black Bezel Catalog Number	Metal Bezel Catalog Number
Two-position	Momentary <sup>②</sup> 	White	M22-WLK-W	M22S-WLK-W	M22M-WLK-W
		Red	M22-WLK-R	M22S-WLK-R	M22M-WLK-R
		Green	M22-WLK-G	M22S-WLK-G	M22M-WLK-G
		Yellow	M22-WLK-Y	M22S-WLK-Y	M22M-WLK-Y
		Blue	M22-WLK-B	M22S-WLK-B	M22M-WLK-B
	Maintained 	White	M22-WRLK-W	M22S-WRLK-W	M22M-WRLK-W
		Red	M22-WRLK-R	M22S-WRLK-R	M22M-WRLK-R
		Green	M22-WRLK-G	M22S-WRLK-G	M22M-WRLK-G
		Yellow	M22-WRLK-Y	M22S-WRLK-Y	M22M-WRLK-Y
		Blue	M22-WRLK-B	M22S-WRLK-B	M22M-WRLK-B
	Maintained V 	White	M22-WLKV-W	M22S-WLKV-W	M22M-WLKV-W
		Red	M22-WLKV-R	M22S-WLKV-R	M22M-WLKV-R
		Green	M22-WLKV-G	M22S-WLKV-G	M22M-WLKV-G
		Yellow	M22-WLKV-Y	M22S-WLKV-Y	M22M-WLKV-Y
		Blue	M22-WLKV-B	M22S-WLKV-B	M22M-WLKV-B

**Notes**

- ① Includes contact block mounting adapter.
- ② Momentary selector switches can be converted in the field to maintained operation with the removal of a color coded adapter. See **Page V7-T1-118**.

# 1



## Illuminated Selector Switches

### Components

M22-WLK3-W

#### Operators Only, Knob Type <sup>①</sup>

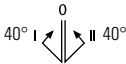
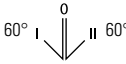

Type	Switching Position	Button Color	Silver Bezel Catalog Number	Black Bezel Catalog Number	Metal Bezel Catalog Number
Three-position	Momentary <sup>②</sup> 	White	M22-WLK3-W	M22S-WLK3-W	M22M-WLK3-W
		Red	M22-WLK3-R	M22S-WLK3-R	M22M-WLK3-R
		Green	M22-WLK3-G	M22S-WLK3-G	M22M-WLK3-G
		Yellow	M22-WLK3-Y	M22S-WLK3-Y	M22M-WLK3-Y
		Blue	M22-WLK3-B	M22S-WLK3-B	M22M-WLK3-B
	Maintained 	White	M22-WRLK3-W	M22S-WRLK3-W	M22M-WRLK3-W
		Red	M22-WRLK3-R	M22S-WRLK3-R	M22M-WRLK3-R
		Green	M22-WRLK3-G	M22S-WRLK3-G	M22M-WRLK3-G
		Yellow	M22-WRLK3-Y	M22S-WRLK3-Y	M22M-WRLK3-Y
		Blue	M22-WRLK3-B	M22S-WRLK3-B	M22M-WRLK3-B
	Maintained, return from right 	White	M22-WRLK3-1-W	M22S-WRLK3-1-W	M22M-WRLK3-1-W
		Red	M22-WRLK3-1-R	M22S-WRLK3-1-R	M22M-WRLK3-1-R
Green		M22-WRLK3-1-G	M22S-WRLK3-1-G	M22M-WRLK3-1-G	
Yellow		M22-WRLK3-1-Y	M22S-WRLK3-1-Y	M22M-WRLK3-1-Y	
Blue		M22-WRLK3-1-B	M22S-WRLK3-1-B	M22M-WRLK3-1-B	
Maintained, return from left 	White	M22-WRLK3-2-W	M22S-WRLK3-2-W	M22M-WRLK3-2-W	
	Red	M22-WRLK3-2-R	M22S-WRLK3-2-R	M22M-WRLK3-2-R	
	Green	M22-WRLK3-2-G	M22S-WRLK3-2-G	M22M-WRLK3-2-G	
	Yellow	M22-WRLK3-2-Y	M22S-WRLK3-2-Y	M22M-WRLK3-2-Y	
	Blue	M22-WRLK3-2-B	M22S-WRLK3-2-B	M22M-WRLK3-2-B	

#### Notes

<sup>①</sup> Includes contact block mounting adapter.

<sup>②</sup> Momentary selector switches can be converted in the field to maintained operation with the removal of a color coded adapter. See [Page V7-T1-118](#).

### Illuminated Selector Switches

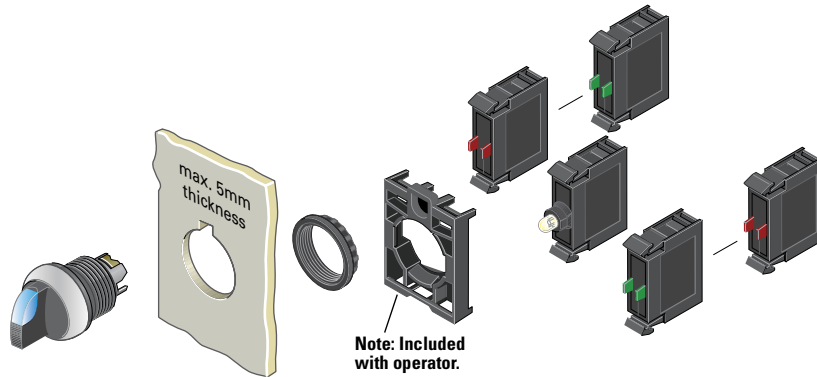

#### M22-LED-W



#### M22-FLED-\_-



#### Light Units ①

Terminal Type	LED Color ②	Light Unit Voltage	Catalog Number
Screw	White	12–30 Vac/Vdc	<b>M22-LED-W</b>
	Red		<b>M22-LED-R</b>
	Green		<b>M22-LED-G</b>
	Blue		<b>M22-LED-B</b>
Screw	White	85–264 Vac	<b>M22-LED230-W</b>
	Red		<b>M22-LED230-R</b>
	Green		<b>M22-LED230-G</b>
	Blue		<b>M22-LED230-B</b>
Spring-cage	White	12–30 Vac/Vdc	<b>M22-FLED-W</b>
	Red		<b>M22-FLED-R</b>
	Green		<b>M22-FLED-G</b>
	Blue	<b>M22-FLED-B</b>	
	Red/Green/ Yellow	24 Vdc	<b>M22-FLED-RG ③</b>
	Red, Green, Blue, Yellow, White, Violet, Turquoise		<b>M22-FLED-RGB ③</b>

#### Accessories

	Description	Catalog Number
<b>M22-XW</b>	Plunger bridge ⑥	<b>M22-XW</b>
<b>M22-XWS</b>	Key cover	<b>M22-XWS</b>
<b>M22-XC-R</b>	Key withdraw adapter ⑦	<b>M22-XC-R</b>
<b>M22-XC-Y</b>	Coding adapter	<b>M22-XC-Y</b>
<b>M22-XGWK</b>	Guard ring	<b>M22-XGWK</b>

#### M22-K10



#### M22-FK01



#### Contact Blocks ①

Terminal Type	Contact Configuration ④	Catalog Number
Screw	NO	<b>M22-K10</b>
	NO, early-make	<b>M22-K10P</b>
	NC	<b>M22-K01</b>
	NC, late-break	<b>M22-K01D</b>
Spring-cage	NO	<b>M22-CK10</b>
	NC	<b>M22-CK01</b>
	NC, late-break	<b>M22-CK01D</b>
	2NO	<b>M22-CK20</b>
	2NC	<b>M22-CK02</b>
	NO-NC	<b>M22-CK11</b>
	NC	<b>M22-FK01 ⑤</b>
	NO	<b>M22-FK10 ⑤</b>

#### Notes

- ① For complete listing of available light units and contact blocks, see Accessories, Pages V7-T1-111 to V7-T1-116.
- ② Select the same color LED element as lens color; for yellow lens, choose a white LED. Select a white lens if utilizing multi-color LED, M22-FLED-RG or M22-FLED-RGB.
- ③ Please see color input key on Page V7-T1-114.
- ④ All NC contact blocks are positively driven contact. ⊖
- ⑤ Additional contacts may not be stacked behind M22-F type contact blocks, M22-F can be stacked behind standard M22 contacts only.
- ⑥ Plunger needed to actuate center-mounted contact blocks. Used for non-illuminated three-position selector switches only.
- ⑦ Enables a keyed selector switch to be set to user-selected key withdraw position.

# 1

## Catalog Number Selection

Catalog Number Selection is for illustrative purposes only and not to be used to create new catalog numbers.

### Key-Operated Selector Switches

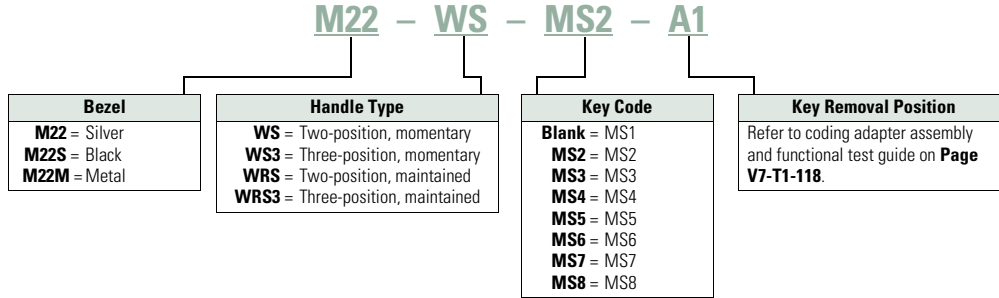

## Product Selection

### Key-Operated Selector Switches <sup>①②</sup>

#### Components

#### M22-WS



#### Operators Only <sup>③</sup>

Type	Switching Position	Key Removal Position	Key Code	Silver Bezel Catalog Number	Black Bezel Catalog Number	Metal Bezel Catalog Number
Two-position	Momentary <sup>④</sup> 40°	Return from right, key removable left	MS1	<b>M22-WS</b>	<b>M22S-WS</b>	<b>M22M-WS</b>
			MS2	<b>M22-WS-MS2</b>	<b>M22S-WS-MS2</b>	<b>M22M-WS-MS2</b>
			MS3	<b>M22-WS-MS3</b>	<b>M22S-WS-MS3</b>	<b>M22M-WS-MS3</b>
			MS4	<b>M22-WS-MS4</b>	<b>M22S-WS-MS4</b>	<b>M22M-WS-MS4</b>
			MS5	<b>M22-WS-MS5</b>	<b>M22S-WS-MS5</b>	<b>M22M-WS-MS5</b>
			MS6	<b>M22-WS-MS6</b>	<b>M22S-WS-MS6</b>	<b>M22M-WS-MS6</b>
			MS7	<b>M22-WS-MS7</b>	<b>M22S-WS-MS7</b>	<b>M22M-WS-MS7</b>
			MS8	<b>M22-WS-MS8</b>	<b>M22S-WS-MS8</b>	<b>M22M-WS-MS8</b>
			Two-position	Maintained 40°	Key removable left	MS1
MS2	<b>M22-WRS-MS2-A1</b>	<b>M22S-WRS-MS2-A1</b>				<b>M22M-WRS-MS2-A1</b>
MS3	<b>M22-WRS-MS3-A1</b>	<b>M22S-WRS-MS3-A1</b>				<b>M22M-WRS-MS3-A1</b>
MS4	<b>M22-WRS-MS4-A1</b>	<b>M22S-WRS-MS4-A1</b>				<b>M22M-WRS-MS4-A1</b>
MS5	<b>M22-WRS-MS5-A1</b>	<b>M22S-WRS-MS5-A1</b>				<b>M22M-WRS-MS5-A1</b>
MS6	<b>M22-WRS-MS6-A1</b>	<b>M22S-WRS-MS6-A1</b>				<b>M22M-WRS-MS6-A1</b>
MS7	<b>M22-WRS-MS7-A1</b>	<b>M22S-WRS-MS7-A1</b>				<b>M22M-WRS-MS7-A1</b>
MS8	<b>M22-WRS-MS8-A1</b>	<b>M22S-WRS-MS8-A1</b>				<b>M22M-WRS-MS8-A1</b>
Key removable left/right	MS1	<b>M22-WRS</b>			<b>M22S-WRS</b>	<b>M22M-WRS</b>
	MS2	<b>M22-WRS-MS2</b>			<b>M22S-WRS-MS2</b>	<b>M22M-WRS-MS2</b>
	MS3	<b>M22-WRS-MS3</b>			<b>M22S-WRS-MS3</b>	<b>M22M-WRS-MS3</b>
	MS4	<b>M22-WRS-MS4</b>			<b>M22S-WRS-MS4</b>	<b>M22M-WRS-MS4</b>
	MS5	<b>M22-WRS-MS5</b>			<b>M22S-WRS-MS5</b>	<b>M22M-WRS-MS5</b>
	MS6	<b>M22-WRS-MS6</b>			<b>M22S-WRS-MS6</b>	<b>M22M-WRS-MS6</b>
	MS7	<b>M22-WRS-MS7</b>			<b>M22S-WRS-MS7</b>	<b>M22M-WRS-MS7</b>
	MS8	<b>M22-WRS-MS8</b>			<b>M22S-WRS-MS8</b>	<b>M22M-WRS-MS8</b>

#### Notes

- ① Includes one key.
- ② Key removal positions can be modified in the field using coding adapters; see chart on **Page V7-T1-118**.
- ③ Includes contact block mounting adapter.
- ④ Momentary selector switches can be converted in the field to maintained operation with the removal of a color coded adapter. See **Page V7-T1-118**.

Key-Operated Selector Switches ①②

Components

M22-WS3-X93

Operators Only, continued ③



M22M-WS3-X93

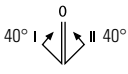
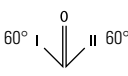

Type	Switching Position	Key Removal Position	Key Code	Silver Bezel Catalog Number	Black Bezel Catalog Number	Metal Bezel Catalog Number
Three-position	Momentary ④ 	Return from left/right, key removable center	MS1	M22-WS3	M22S-WS3	M22M-WS3
			MS2	M22-WS3-MS2	M22S-WS3-MS2	M22M-WS3-MS2
			MS3	M22-WS3-MS3	M22S-WS3-MS3	M22M-WS3-MS3
			MS4	M22-WS3-MS4	M22S-WS3-MS4	M22M-WS3-MS4
			MS5	M22-WS3-MS5	M22S-WS3-MS5	M22M-WS3-MS5
			MS6	M22-WS3-MS6	M22S-WS3-MS6	M22M-WS3-MS6
			MS7	M22-WS3-MS7	M22S-WS3-MS7	M22M-WS3-MS7
			MS8	M22-WS3-MS8	M22S-WS3-MS8	M22M-WS3-MS8
			Three-position	Maintained 	Key removable left/center/right	MS1
MS2	M22-WRS3-MS2-A1	M22S-WRS3-MS2-A1				M22M-WRS3-MS2-A1
MS3	M22-WRS3-MS3-A1	M22S-WRS3-MS3-A1				M22M-WRS3-MS3-A1
MS4	M22-WRS3-MS4-A1	M22S-WRS3-MS4-A1				M22M-WRS3-MS4-A1
MS5	M22-WRS3-MS5-A1	M22S-WRS3-MS5-A1				M22M-WRS3-MS5-A1
MS6	M22-WRS3-MS6-A1	M22S-WRS3-MS6-A1				M22M-WRS3-MS6-A1
MS7	M22-WRS3-MS7-A1	M22S-WRS3-MS7-A1				M22M-WRS3-MS7-A1
MS8	M22-WRS3-MS8-A1	M22S-WRS3-MS8-A1				M22M-WRS3-MS8-A1
Key removable center/left	MS1	M22-WRS3-A2			M22S-WRS3-A2	M22M-WRS3-A2
	MS2	M22-WRS3-MS2-A2			M22S-WRS3-MS2-A2	M22M-WRS3-MS2-A2
	MS3	M22-WRS3-MS3-A2			M22S-WRS3-MS3-A2	M22M-WRS3-MS3-A2
	MS4	M22-WRS3-MS4-A2			M22S-WRS3-MS4-A2	M22M-WRS3-MS4-A2
	MS5	M22-WRS3-MS5-A2			M22S-WRS3-MS5-A2	M22M-WRS3-MS5-A2
	MS6	M22-WRS3-MS6-A2			M22S-WRS3-MS6-A2	M22M-WRS3-MS6-A2
	MS7	M22-WRS3-MS7-A2			M22S-WRS3-MS7-A2	M22M-WRS3-MS7-A2
	MS8	M22-WRS3-MS8-A2			M22S-WRS3-MS8-A2	M22M-WRS3-MS8-A2
Key removable center/right	MS1	M22-WRS3-A3			M22S-WRS3-A3	M22M-WRS3-A3
	MS2	M22-WRS3-MS2-A3			M22S-WRS3-MS2-A3	M22M-WRS3-MS2-A3
	MS3	M22-WRS3-MS3-A3			M22S-WRS3-MS3-A3	M22M-WRS3-MS3-A3
	MS4	M22-WRS3-MS4-A3			M22S-WRS3-MS4-A3	M22M-WRS3-MS4-A3
	MS5	M22-WRS3-MS5-A3			M22S-WRS3-MS5-A3	M22M-WRS3-MS5-A3
	MS6	M22-WRS3-MS6-A3			M22S-WRS3-MS6-A3	M22M-WRS3-MS6-A3
	MS7	M22-WRS3-MS7-A3			M22S-WRS3-MS7-A3	M22M-WRS3-MS7-A3
	MS8	M22-WRS3-MS8-A3			M22S-WRS3-MS8-A3	M22M-WRS3-MS8-A3
Key removable left/right	MS1	M22-WRS3			M22S-WRS3	M22M-WRS3
	MS2	M22-WRS3-MS2			M22S-WRS3-MS2	M22M-WRS3-MS2
	MS3	M22-WRS3-MS3			M22S-WRS3-MS3	M22M-WRS3-MS3
	MS4	M22-WRS3-MS4			M22S-WRS3-MS4	M22M-WRS3-MS4
	MS5	M22-WRS3-MS5			M22S-WRS3-MS5	M22M-WRS3-MS5
	MS6	M22-WRS3-MS6			M22S-WRS3-MS6	M22M-WRS3-MS6
	MS7	M22-WRS3-MS7			M22S-WRS3-MS7	M22M-WRS3-MS7
	MS8	M22-WRS3-MS8			M22S-WRS3-MS8	M22M-WRS3-MS8

Notes

- ① Includes one key.
- ② Key removal positions can be modified in the field using coding adapters; see chart on Page V7-T1-118.
- ③ Includes contact block mounting adapter.
- ④ Momentary selector switches can be converted in the field to maintained operation with the removal of a color coded adapter. See Page V7-T1-118.

## Key-Operated Selector Switches <sup>①②</sup>

### Components

M22-WS3-X93



M22M-WS3-X93



### Operators Only, continued <sup>③</sup>

Type	Switching Position	Key Removal Position	Key Code	Silver Bezel Catalog Number	Black Bezel Catalog Number	Metal Bezel Catalog Number
Three-position Maintained		Return from left, key removable center	MS1	M22-WRS3-A7	M22S-WRS3-A7	M22M-WRS3-A7
			MS2	M22-WRS3-MS2-A7	M22S-WRS3-MS2-A7	M22M-WRS3-MS2-A7
			MS3	M22-WRS3-MS3-A7	M22S-WRS3-MS3-A7	M22M-WRS3-MS3-A7
			MS4	M22-WRS3-MS4-A7	M22S-WRS3-MS4-A7	M22M-WRS3-MS4-A7
			MS5	M22-WRS3-MS5-A7	M22S-WRS3-MS5-A7	M22M-WRS3-MS5-A7
			MS6	M22-WRS3-MS6-A7	M22S-WRS3-MS6-A7	M22M-WRS3-MS6-A7
			MS7	M22-WRS3-MS7-A7	M22S-WRS3-MS7-A7	M22M-WRS3-MS7-A7
			MS8	M22-WRS3-MS8-A7	M22S-WRS3-MS8-A7	M22M-WRS3-MS8-A7
		Return from left, key removable center/right	MS1	M22-WRS3-A6	M22S-WRS3-A6	M22M-WRS3-A6
			MS2	M22-WRS3-MS2-A6	M22S-WRS3-MS2-A6	M22M-WRS3-MS2-A6
			MS3	M22-WRS3-MS3-A6	M22S-WRS3-MS3-A6	M22M-WRS3-MS3-A6
			MS4	M22-WRS3-MS4-A6	M22S-WRS3-MS4-A6	M22M-WRS3-MS4-A6
			MS5	M22-WRS3-MS5-A6	M22S-WRS3-MS5-A6	M22M-WRS3-MS5-A6
			MS6	M22-WRS3-MS6-A6	M22S-WRS3-MS6-A6	M22M-WRS3-MS6-A6
			MS7	M22-WRS3-MS7-A6	M22S-WRS3-MS7-A6	M22M-WRS3-MS7-A6
			MS8	M22-WRS3-MS8-A6	M22S-WRS3-MS8-A6	M22M-WRS3-MS8-A6
Three-position Maintained		Return from right, key removable left/ center	MS1	M22-WRS3-A4	M22S-WRS3-A4	M22M-WRS3-A4
			MS2	M22-WRS3-MS2-A4	M22S-WRS3-MS2-A4	M22M-WRS3-MS2-A4
			MS3	M22-WRS3-MS3-A4	M22S-WRS3-MS3-A4	M22M-WRS3-MS3-A4
			MS4	M22-WRS3-MS4-A4	M22S-WRS3-MS4-A4	M22M-WRS3-MS4-A4
			MS5	M22-WRS3-MS5-A4	M22S-WRS3-MS5-A4	M22M-WRS3-MS5-A4
			MS6	M22-WRS3-MS6-A4	M22S-WRS3-MS6-A4	M22M-WRS3-MS6-A4
			MS7	M22-WRS3-MS7-A4	M22S-WRS3-MS7-A4	M22M-WRS3-MS7-A4
			MS8	M22-WRS3-MS8-A4	M22S-WRS3-MS8-A4	M22M-WRS3-MS8-A4
		Return from right, key removable center	MS1	M22-WRS3-A5	M22S-WRS3-A5	M22M-WRS3-A5
			MS2	M22-WRS3-MS2-A5	M22S-WRS3-MS2-A5	M22M-WRS3-MS2-A5
			MS3	M22-WRS3-MS3-A5	M22S-WRS3-MS3-A5	M22M-WRS3-MS3-A5
			MS4	M22-WRS3-MS4-A5	M22S-WRS3-MS4-A5	M22M-WRS3-MS4-A5
			MS5	M22-WRS3-MS5-A5	M22S-WRS3-MS5-A5	M22M-WRS3-MS5-A5
			MS6	M22-WRS3-MS6-A5	M22S-WRS3-MS6-A5	M22M-WRS3-MS6-A5
			MS7	M22-WRS3-MS7-A5	M22S-WRS3-MS7-A5	M22M-WRS3-MS7-A5
			MS8	M22-WRS3-MS8-A5	M22S-WRS3-MS8-A5	M22M-WRS3-MS8-A5

#### Notes

- ① Includes one key.
- ② Key removal positions can be modified in the field using coding adapters; see chart on [Page V7-T1-118](#).
- ③ Includes contact block mounting adapter.

### Key-Operated Selector Switches

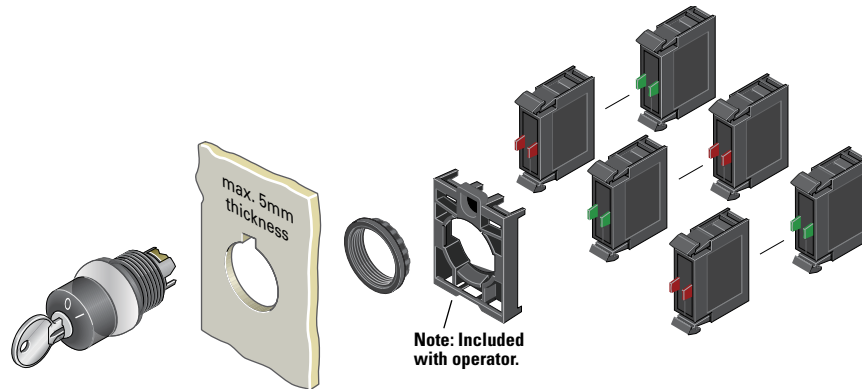

### Components

#### M22-K10



#### M22-FK01



#### M22-ES-MS1



### Contact Blocks <sup>①</sup>

Terminal Type	Contact Configuration <sup>②</sup>	Catalog Number
Screw	NO	<b>M22-K10</b>
	NO, early-make	<b>M22-K10P</b>
	NC	<b>M22-K01</b>
	NC, late-break	<b>M22-K01D</b>
Spring-cage	NO	<b>M22-CK10</b>
	NC	<b>M22-CK01</b>
	NC, late-break	<b>M22-CK01D</b>
	2NO	<b>M22-CK20</b>
	2NC	<b>M22-CK02</b>
	NO-NC	<b>M22-CK11</b>
	NC	<b>M22-FK01 <sup>③</sup></b>
	NO	<b>M22-FK10 <sup>③</sup></b>

### Extra Keys

Key Code	Catalog Number
MS1	<b>M22-ES-MS1</b>
MS2	<b>M22-ES-MS2</b>
MS3	<b>M22-ES-MS3</b>
MS4	<b>M22-ES-MS4</b>
MS5	<b>M22-ES-MS5</b>
MS6	<b>M22-ES-MS6</b>
MS7	<b>M22-ES-MS7</b>
MS8	<b>M22-ES-MS8</b>

### Accessories

	Description	Catalog Number
<b>M22-XW</b> 	Plunger bridge <sup>④</sup>	<b>M22-XW</b>
<b>M22-XWS</b> 	Key cover	<b>M22-XWS</b>
<b>M22-XC-R</b> 	Key withdraw adapter <sup>⑤</sup>	<b>M22-XC-R</b>
<b>M22-XC-Y</b> 	Coding adapter	<b>M22-XC-Y</b>
<b>M22-XGWK</b> 	Guard ring	<b>M22-XGWK</b>

#### Notes

- ① For complete listing of available contact blocks, see Accessories, **Pages V7-T1-111 to V7-T1-116.**
- ② All NC contact blocks are positively driven contact. ⊖
- ③ Additional contacts may not be stacked behind M22-F type contact blocks, M22-F can be stacked behind standard M22 contacts only.
- ④ Plunger needed to actuate center-mounted contact blocks. Used for non-illuminated three-position selector switches only.
- ⑤ Enables a keyed selector switch to be set to user-selected key withdraw position.



## 1

**Mushroom Head Pushbuttons****Product Description**

Eaton's M22 mushroom head operators are a durable and unique way to include standard pushbutton functionality. Like the standard pushbutton line, the maintained pushbuttons are field convertible to momentary. They also offer laser engraving and a robust five million mechanical operations on the standard momentary operator. As with all operators, they can be ordered as a ready to install complete device or as modular components.

**Features**

- Field convertible from maintained to momentary (available on maintained pushbuttons only)
- Customizable laser engraving on all buttons
- More than five million mechanical operations on momentary and one million on maintained pushbuttons
- Modular construction makes assembly fast and simplifies stocking of components and complete devices
- Capable of communicating via ASi protocol with ASi adapter modules

**Protection Type**

- IP67, IP69K
- NEMA 4X, 13

**Catalog Number Selection**

Catalog Number Selection is for illustrative purposes only and not to be used to create new catalog numbers.

**Mushroom Head Pushbuttons**

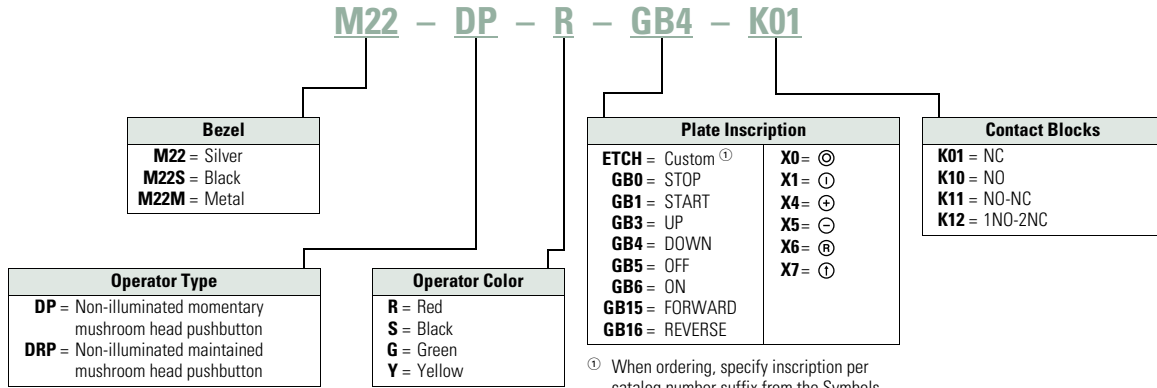

① When ordering, specify inscription per catalog number suffix from the Symbols Library (see **Pages V7-T1-129 to V7-T1-136**) into the Order Notes. For example, M22-DP-R-ETCH; Order Notes: Mark with symbol X91, Line item #\_.

## 1

## Product Selection

Mushroom Head Pushbuttons, Momentary <sup>①</sup>

M22-DP-R-K01



M22S-DP-R-K01



M22M-DP-R-K01



## Complete Devices

Button Color	Contact Block Configuration <sup>②</sup>	Silver Bezel Catalog Number	Black Bezel Catalog Number	Metal Bezel Catalog Number
Red	NC	M22-DP-R-K01	M22S-DP-R-K01	M22M-DP-R-K01
	2NC	M22-DP-R-K02	M22S-DP-R-K02	M22M-DP-R-K02
	1NO-2NC	M22-DP-R-K12	M22S-DP-R-K12	M22M-DP-R-K12
	1NO-1NC	M22-DP-R-K11	M22S-DP-R-K11	M22M-DP-R-K11

M22-DP-G



M22S-DP-G



M22M-DP-G

Operators Only <sup>②</sup>

Button Color	Silver Bezel Catalog Number	Black Bezel Catalog Number	Metal Bezel Catalog Number
Black	M22-DP-S	M22S-DP-S	M22M-DP-S
Red	M22-DP-R	M22S-DP-R	M22M-DP-R
Green	M22-DP-G	M22S-DP-G	M22M-DP-G
Yellow	M22-DP-Y	M22S-DP-Y	M22M-DP-Y

## Notes

<sup>①</sup> 35 mm diameter mushroom head button.

<sup>②</sup> Includes contact block mounting adapter. 

### Non-Illuminated Mushroom Head Pushbuttons, Momentary ①

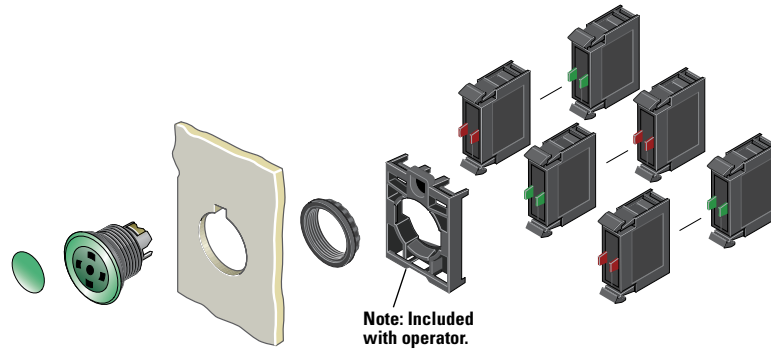

### Components

#### M22-XDP-G



#### Mushroom Head Plates

Color	Inscription	Catalog Number
Black	—	M22-XDP-S ②
	Custom	M22-XDP-S-ETCH ③
	STOP	M22-XDP-S-GB0
	START	M22-XDP-S-GB1
	FORWARD	M22-XDP-S-GB15
	REVERSE	M22-XDP-S-GB16
	UP	M22-XDP-S-GB3
	DOWN	M22-XDP-S-GB4
	OFF	M22-XDP-S-GB5
	ON	M22-XDP-S-GB6
	⊙	M22-XDP-S-X0
	①	M22-XDP-S-X1
	+	M22-XDP-S-X4
	−	M22-XDP-S-X5
①	M22-XDP-S-X7	
Red	—	M22-XDP-R ②
	Custom	M22-XDP-R-ETCH ③
	STOP	M22-XDP-R-GB0
	OFF	M22-XDP-R-GB5
Green	—	M22-XDP-G ②
	Custom	M22-XDP-G-ETCH ③
	START	M22-XDP-G-GB1
	ON	M22-XDP-G-GB6
	⊙	M22-XDP-G-X0
White	—	M22-XDP-W ②
	Custom	M22-XDP-W-ETCH ③
Yellow	—	M22-XDP-Y ②
	Custom	M22-XDP-Y-ETCH ③

#### M22-DP-G-X



#### Insertless Mushroom Head Operators

Bezel	Color	Catalog Number
Silver	Black	M22-DP-S-X
	Red	M22-DP-R-X
	Green	M22-DP-G-X
	Yellow	M22-DP-Y-X
Black	Black	M22S-DP-S-X
	Red	M22S-DP-R-X
	Green	M22S-DP-G-X
	Yellow	M22S-DP-Y-X
Metal	Black	M22M-DP-S-X
	Red	M22M-DP-R-X
	Green	M22M-DP-G-X
	Yellow	M22M-DP-Y-X

#### M22-K10



#### Contact Blocks ④

Terminal Type	Contact Configuration ⑤	Catalog Number
Screw	NO	M22-K10
	NO, early-make	M22-K10P
	NC	M22-K01
	NC, late-break	M22-K01D
Spring-cage	NO	M22-CK10
	NC	M22-CK01
	NC, late-break	M22-CK01D
	2NO	M22-CK20
	2NC	M22-CK02
	NO-NC	M22-CK11
	NC	M22-FK01 ⑥
	NO	M22-FK10 ⑥

#### M22-FK01



#### Notes

- ① 35 mm diameter mushroom head button.
- ② Minimum order quantity of (10).
- ③ When ordering, specify inscription per catalog number suffix from the Symbols Library (see **Pages V7-T1-129 to V7-T1-136**) into the Order Notes. For example, M22-XDP-S-ETCH; Order Notes: Mark with symbol X91, Line item #\_.
- ④ For complete listing of available contact blocks, see Accessories, **Pages V7-T1-111 to V7-T1-116**.
- ⑤ All NC contact blocks are positively driven contact. ⊖
- ⑥ Additional contacts may not be stacked behind M22-F type contact blocks, M22-F can be stacked behind standard M22 contacts only.

#### 1

### Product Selection

#### Non-Illuminated Mushroom Head Pushbuttons, Maintained <sup>①②</sup>

M22-DRP-R-K01



M22S-DRP-R-K01



M22M-DRP-R-K01



#### Complete Devices

Button Color	Contact Block Configuration <sup>③</sup>	Silver Bezel Catalog Number	Black Bezel Catalog Number	Metal Bezel Catalog Number
Red	NC	M22-DRP-R-K01	M22S-DRP-R-K01	M22M-DRP-R-K01
	2NC	M22-DRP-R-K02	M22S-DRP-R-K02	M22M-DRP-R-K02
	1NO-2NC	M22-DRP-R-K12	M22S-DRP-R-K12	M22M-DRP-R-K12
	1NO-1NC	M22-DRP-R-K11	M22S-DRP-R-K11	M22M-DRP-R-K11

M22-DRP-G



M22S-DRP-G



M22M-DRP-G



#### Operators Only

Button Color	Silver Bezel Catalog Number	Black Bezel Catalog Number	Metal Bezel Catalog Number
Black	M22-DRP-S	M22S-DRP-S	M22M-DRP-S
Red	M22-DRP-R	M22S-DRP-R	M22M-DRP-R
Green	M22-DRP-G	M22S-DRP-G	M22M-DRP-G
Yellow	M22-DRP-Y	M22S-DRP-Y	M22M-DRP-Y

#### Notes

- ① 35 mm diameter mushroom head button.
- ② Maintained pushbuttons can be converted in the field to momentary operation by switching the locking ring, which is accessible through the side of the operator body.
- ③ All NC contact blocks are positively driven contact. ⊖

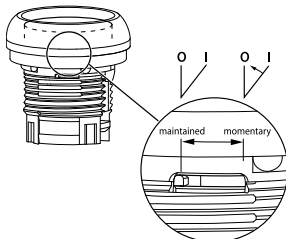

**Note:** This pilot device features a selectable function switch that enables the device to be set to either maintained or momentary operation.

### Non-Illuminated Mushroom Head Pushbuttons, Maintained <sup>①②</sup>

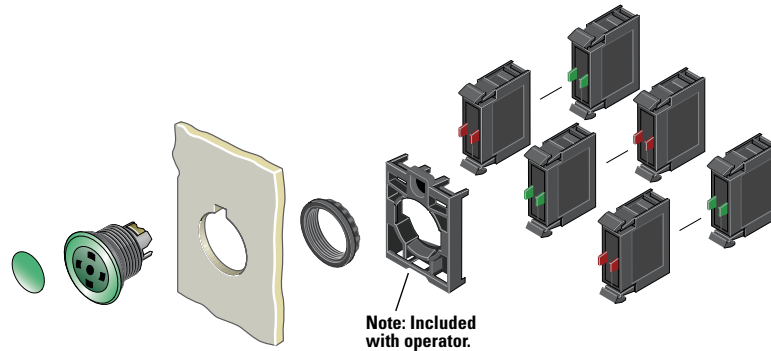

### Components

#### M22-XDP-G



#### Mushroom Head Plates <sup>③</sup>

Color	Inscription	Catalog Number
Black	—	M22-XDP-S <sup>④</sup>
	Custom	M22-XDP-S-ETCH <sup>⑤</sup>
	STOP	M22-XDP-S-GB0
	START	M22-XDP-S-GB1
	FORWARD	M22-XDP-S-GB15
	REVERSE	M22-XDP-S-GB16
	UP	M22-XDP-S-GB3
	DOWN	M22-XDP-S-GB4
	OFF	M22-XDP-S-GB5
	ON	M22-XDP-S-GB6
	⊙	M22-XDP-S-X0
	Ⓛ	M22-XDP-S-X1
	+	M22-XDP-S-X4
	−	M22-XDP-S-X5
	Ⓛ	M22-XDP-S-X7
Red	—	M22-XDP-R <sup>④</sup>
	Custom	M22-XDP-R-ETCH <sup>⑤</sup>
	STOP	M22-XDP-R-GB0
	OFF	M22-XDP-R-GB5
	⊙	M22-XDP-R-X0
Green	—	M22-XDP-G <sup>④</sup>
	Custom	M22-XDP-G-ETCH <sup>⑤</sup>
	START	M22-XDP-G-GB1
	ON	M22-XDP-G-GB6
	⊙	M22-XDP-G-X0
White	—	M22-XDP-W <sup>④</sup>
	Custom	M22-XDP-W-ETCH <sup>⑤</sup>
	—	M22-XDP-Y <sup>④</sup>
Yellow	—	M22-XDP-Y <sup>④</sup>
	Custom	M22-XDP-Y-ETCH <sup>⑤</sup>

#### M22-DRP-G-X



#### Insertless Mushroom Head Operators

Bezel	Color	Catalog Number
Silver	Black	M22-DRP-S-X
	Red	M22-DRP-R-X
	Green	M22-DRP-G-X
	Yellow	M22-DRP-Y-X
Black	Black	M22S-DRP-S-X
	Red	M22S-DRP-R-X
	Green	M22S-DRP-G-X
	Yellow	M22S-DRP-Y-X
Metal	Black	M22M-DRP-S-X
	Red	M22M-DRP-R-X
	Green	M22M-DRP-G-X
	Yellow	M22M-DRP-Y-X

#### M22-K10



#### Contact Blocks <sup>③</sup>

Terminal Type	Contact Configuration <sup>⑥</sup>	Catalog Number
Screw	NO	M22-K10
	NO, early-make	M22-K10P
	NC	M22-K01
	NC, late-break	M22-K01D
Spring-cage	NO	M22-CK10
	NC	M22-CK01
	NC, late-break	M22-CK01D
	2NO	M22-CK20
	2NC	M22-CK02
	NO-NC	M22-CK11
	NC	M22-FK01 <sup>⑦</sup>
	NO	M22-FK10 <sup>⑦</sup>

#### M22-FK01



#### Notes

- ① 35 mm diameter mushroom head button.
- ② Maintained pushbuttons can be converted in the field to momentary operation by switching the locking ring, which is accessible through the side of the operator body.
- ③ For complete listing of available button plates and contact blocks, see Accessories, Pages V7-T1-111 to V7-T1-116.
- ④ Minimum order quantity of (10).
- ⑤ When ordering, specify inscription per catalog number suffix from the Symbols Library (see Pages V7-T1-129 to V7-T1-136) into the Order Notes. For example, M22-XDP-S-ETCH; Order Notes: Mark with symbol X91, Line item #\_.
- ⑥ All NC contact blocks are positively driven contact. ⊖
- ⑦ Additional contacts may not be stacked behind M22-F type contact blocks, M22-F can be stacked behind standard M22 contacts only.

#### 1

### Double Pushbuttons

#### Product Description

Eaton's M22 double pushbutton line is perfect for applications such as motor and pump starting, as well as anytime space is limited. In addition to the two buttons that fit in one 22 mm hole is the integrated white indicating light between them. These three operators allow for multiple functions to occur in a single space. Green/red, black/white and black/black color options along with laser engraving allow for further custom applications.

#### Features

- Flush and extended, as well as color options allow for the perfect combination button
- Integrated indicating light adds even more functionality in one standard 22 mm hole
- Customizable laser engraving on all buttons
- LED offering only for improved brightness quality and up to 100,000 hours of operation
- More than 200,000 mechanical operations
- Capable of communicating via ASi protocol with ASi adapter modules

#### Protection Type

- IP66
- NEMA 4X, 13

### Catalog Number Selection

Catalog Number Selection is for illustrative purposes only and not to be used to create new catalog numbers.

#### Double Pushbuttons

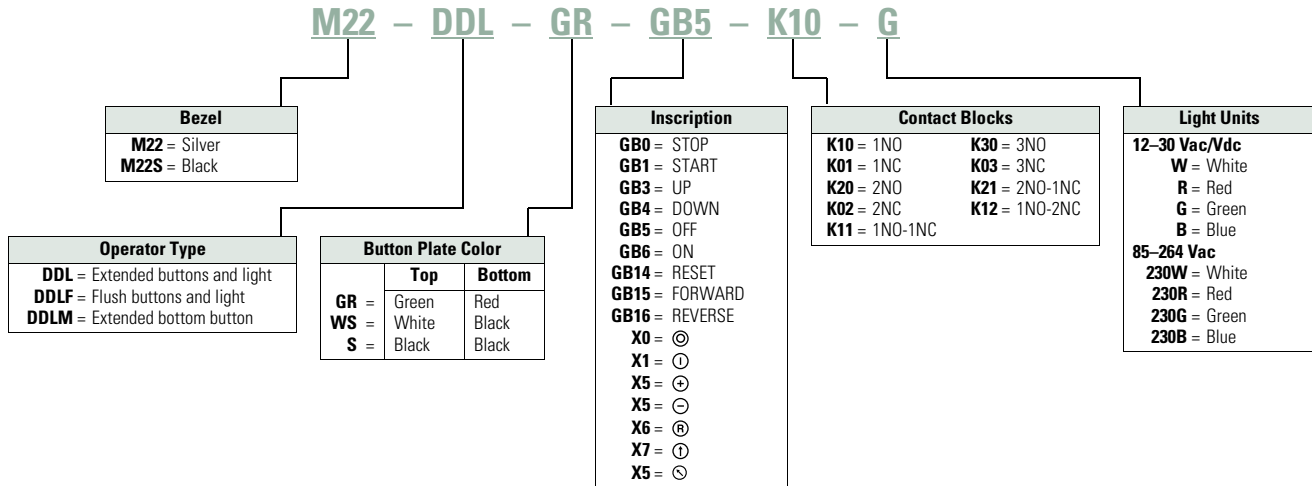



**Product Selection**

**Components**

**Double Pushbuttons, Extended Pushbuttons and Center Light, Momentary**

**Operators Only** <sup>①</sup>

	Bezel	Color Top	Bottom	Inscription Top	Bottom	Catalog Number
 <p><b>M22-DDL-GR-GB1-GB0</b></p>	Silver	Green	Red	—	—	<b>M22-DDL-GR</b>
				Custom	Custom	<b>M22-DDL-GR-ETCH</b> <sup>②</sup>
				⓪	Ⓢ	<b>M22-DDL-GR-X1-X0</b>
				START	STOP	<b>M22-DDL-GR-GB1-GB0</b>
				—	—	<b>M22-DDL-WS</b>
				Custom	Custom	<b>M22-DDL-WS-ETCH</b> <sup>②</sup>
		White	Black	—	—	<b>M22-DDL-WS-X1-X0</b>
				⓪	Ⓢ	<b>M22-DDL-WS-GB1-GB0</b>
				START	STOP	<b>M22-DDL-WS-GB1-GB0</b>
				—	—	<b>M22-DDL-S</b>
				Custom	Custom	<b>M22-DDL-S-ETCH</b> <sup>②</sup>
				—	—	<b>M22-DDL-S-X4-X5</b>
 <p><b>M22S-DDL-GR-X1-X0</b></p>	Black	Green	Red	—	—	<b>M22S-DDL-GR</b>
				Custom	Custom	<b>M22S-DDL-GR-ETCH</b> <sup>②</sup>
				⓪	Ⓢ	<b>M22S-DDL-GR-X1-X0</b>
				START	STOP	<b>M22S-DDL-GR-GB1-GB0</b>
				—	—	<b>M22S-DDL-WS</b>
				Custom	Custom	<b>M22S-DDL-WS-ETCH</b> <sup>②</sup>
		White	Black	—	—	<b>M22S-DDL-WS-X1-X0</b>
				⓪	Ⓢ	<b>M22S-DDL-WS-GB1-GB0</b>
				START	STOP	<b>M22S-DDL-WS-GB1-GB0</b>
				—	—	<b>M22S-DDL-S</b>
				Custom	Custom	<b>M22S-DDL-S-ETCH</b> <sup>②</sup>
				+	—	<b>M22S-DDL-S-X4-X5</b>
Black	Black	—	—	<b>M22S-DDL-S-X7-X7</b>		
		⓪	Ⓢ	<b>M22S-DDL-S-X7-X7</b>		



**Notes**

- ① Includes contact block mounting adapter.
- ② When ordering, specify inscription per catalog number suffix from the Symbols Library (see **Pages V7-T1-129 to V7-T1-136**) into the Order Notes. For example, M22-DDL-S-ETCH; Order Notes: Mark with symbol X91, Line item #\_.





## Double Pushbuttons, Flush Top Pushbuttons and Center Light, Momentary

Operators Only <sup>①</sup>

	Bezel	Color Top	Bottom	Inscription Top	Bottom	Catalog Number
<b>M22-DDLF-GR</b> 	Silver	Green	Red	—	—	<b>M22-DDLF-GR</b>
				Custom	Custom	<b>M22-DDLF-GR-ETCH</b> <sup>②</sup>
		White	Black	—	—	<b>M22-DDLF-WS</b>
				Custom	Custom	<b>M22-DDLF-WS-ETCH</b> <sup>②</sup>
		Green	Red	①	⊙	<b>M22-DDLF-GR-X1-X0</b>
White	Black	①	⊙	<b>M22-DDLF-WS-X1-X0</b>		
<b>M22S-DDLF-GR-X1-X0</b> 	Black	Green	Red	—	—	<b>M22S-DDLF-GR</b>
				Custom	Custom	<b>M22S-DDLF-GR-ETCH</b> <sup>②</sup>
		White	Black	—	—	<b>M22S-DDLF-WS</b>
				Custom	Custom	<b>M22S-DDLF-WS-ETCH</b> <sup>②</sup>
		Green	Red	①	⊙	<b>M22S-DDLF-GR-X1-X0</b>
White	Black	①	⊙	<b>M22S-DDLF-WS-X1-X0</b>		

## Double Pushbuttons, Flush Top Pushbutton and Center Light, Extended Bottom Pushbutton, Momentary

Operators Only <sup>①</sup>

	Bezel	Color Top	Bottom	Inscription Top	Bottom	Catalog Number
<b>M22-DDLM-GR</b> 	Silver	Green	Red	—	—	<b>M22-DDLM-GR</b>
				Custom	Custom	<b>M22-DDLM-GR-ETCH</b> <sup>②</sup>
		White	Black	—	—	<b>M22-DDLM-WS</b>
				Custom	Custom	<b>M22-DDLM-WS-ETCH</b> <sup>②</sup>
		Green	Red	①	⊙	<b>M22-DDLM-GR-X1-X0</b>
White	Black	①	⊙	<b>M22-DDLM-WS-X1-X0</b>		
<b>M22S-DDLM-GR-X1-X0</b> 	Black	Green	Red	—	—	<b>M22S-DDLM-GR</b>
				Custom	Custom	<b>M22S-DDLM-GR-ETCH</b> <sup>②</sup>
		White	Black	—	—	<b>M22S-DDLM-WS</b>
				Custom	Custom	<b>M22S-DDLM-WS-ETCH</b> <sup>②</sup>
		Green	Red	①	⊙	<b>M22S-DDLM-GR-X1-X0</b>
White	Black	①	⊙	<b>M22S-DDLM-WS-X1-X0</b>		

**Notes**

<sup>①</sup> Includes contact block mounting adapter.

<sup>②</sup> When ordering, specify inscription per catalog number suffix from the Symbols Library (see **Pages V7-T1-129 to V7-T1-136**) into the Order Notes. For example, M22-DDLM-GR-ETCH; Order Notes: Mark with symbol X91, Line item #\_.

### Double Pushbuttons

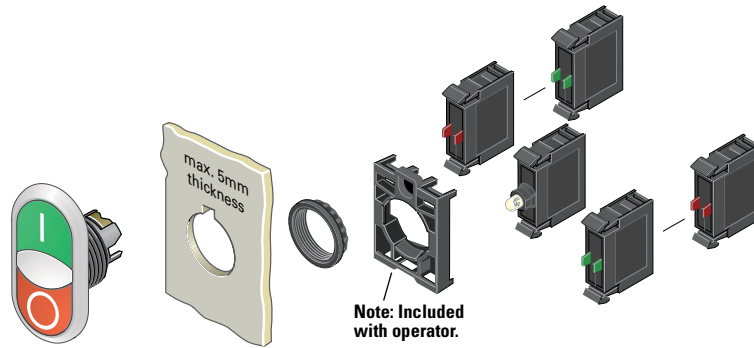

#### M22-LED-W



#### Light Units <sup>①</sup>

Terminal Type	LED Color	Light Unit Voltage	Catalog Number
Screw	White	12–30	<b>M22-LED-W</b>
	Red	Vac/Vdc	<b>M22-LED-R</b>
	Green		<b>M22-LED-G</b>
	Blue		<b>M22-LED-B</b>
Screw	White	85–264	<b>M22-LED230-W</b>
	Red	Vac	<b>M22-LED230-R</b>
	Green		<b>M22-LED230-G</b>
	Blue		<b>M22-LED230-B</b>
Spring-cage	White	12–30	<b>M22-FLED-W</b>
	Red	Vac/Vdc	<b>M22-FLED-R</b>
	Green		<b>M22-FLED-G</b>
	Blue		<b>M22-FLED-B</b>
	Red/Green/ Yellow	24 Vdc	<b>M22-FLED-RG <sup>②</sup></b>
	Red, Green, Blue, Yellow, White, Violet, Turquoise		<b>M22-FLED-RGB <sup>②</sup></b>

#### M22-FLED-



#### M22-K10



#### Contact Blocks <sup>①</sup>

Terminal Type	Contact Configuration <sup>③</sup>	Catalog Number
Screw	NO	<b>M22-K10</b>
	NO, early-make	<b>M22-K10P</b>
	NC	<b>M22-K01</b>
	NC, late-break	<b>M22-K01D</b>
Spring-cage	NO	<b>M22-CK10</b>
	NC	<b>M22-CK01</b>
	NC, late-break	<b>M22-CK01D</b>
	2NO	<b>M22-CK20</b>
	2NC	<b>M22-CK02</b>
	NO-NC	<b>M22-CK11</b>
	NC	<b>M22-FK01 <sup>④</sup></b>
	NO	<b>M22-FK10 <sup>④</sup></b>

#### M22-FK01



#### Notes

- <sup>①</sup> For complete listing of available light units and contact blocks, see Accessories, **Pages V7-T1-111 to V7-T1-116.**
- <sup>②</sup> Please see color input key on **Page V7-T1-114.**
- <sup>③</sup> All NC contact blocks are positively driven contact. ⊖
- <sup>④</sup> Additional contacts may not be stacked behind M22-F type contact blocks, M22-F can be stacked behind standard M22 contacts only.

#### 1

### Four-Way Pushbuttons

#### Product Description

Eaton's M22 four-way pushbutton is a truly unique offering. A four-way pushbutton offers four different buttons mounted in a single 22 mm hole. This is ideal not only for an application with limited space, but also directional applications (when ordered with the four arrow engraving option). Another unique option is the interlocked version, which prevents two opposite buttons from being actuated at the same time.

#### Features

- Four buttons in one operator allows for increased functionality in limited space
- Optional interlocking option, which prevents two buttons from being actuated at the same time
- Customizable laser engraving on all buttons for directional or other applications
- Capable of communicating via ASi protocol with ASi adapter modules

#### Protection Type

- IP66

### Catalog Number Selection

Catalog Number Selection is for illustrative purposes only and not to be used to create new catalog numbers.

#### Four-Way Pushbuttons

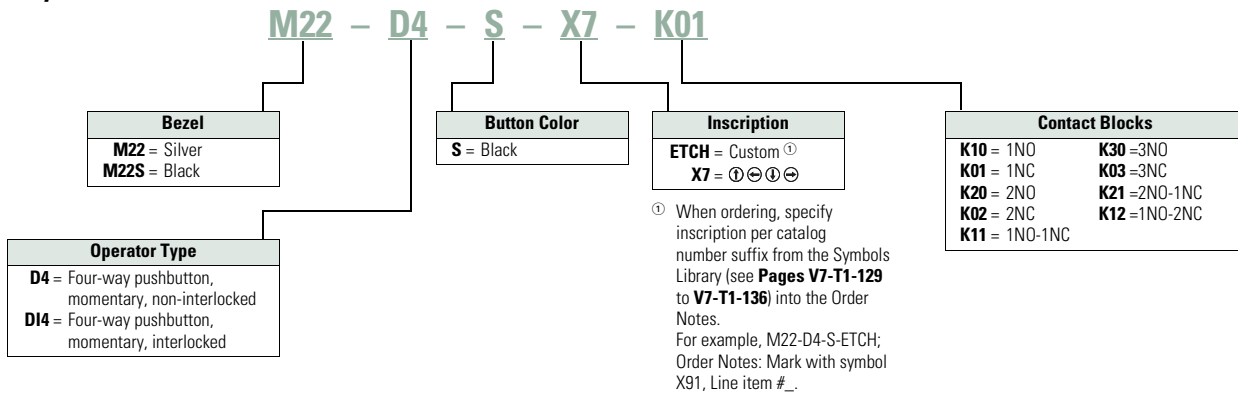

### Product Selection

#### Four-Way Pushbuttons, Momentary

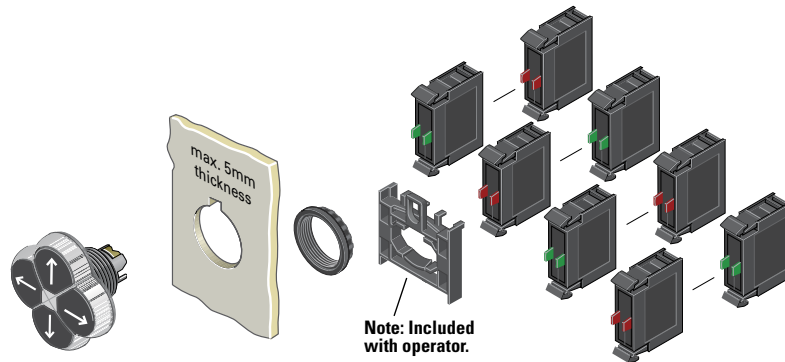

### Components

#### M22-D4-S-X7



#### Operators Only <sup>①</sup>

Type	Bezel	Color	Inscription	Catalog Number
Non-interlocked	Silver	Black	—	<b>M22-D4-S</b>
			Custom	<b>M22-D4-S-ETCH</b> <sup>③</sup>
			Directional arrows	<b>M22-D4-S-X7</b>
	Black	Black	—	<b>M22S-D4-S</b>
			Custom	<b>M22S-D4-S-ETCH</b> <sup>③</sup>
			Directional arrows	<b>M22S-D4-S-X7</b>
Interlocked	Silver	Black	—	<b>M22-DI4-S</b>
			Custom	<b>M22-DI4-S-ETCH</b> <sup>③</sup>
			Directional arrows	<b>M22-DI4-S-X7</b>
	Black	Black	—	<b>M22S-DI4-S</b>
			Custom	<b>M22S-DI4-S-ETCH</b> <sup>③</sup>
			Directional arrows	<b>M22S-DI4-S-X7</b>

#### M22-K10



#### Contact Blocks <sup>①②</sup>

Terminal Type	Contact Configuration <sup>④</sup>	Catalog Number
Screw	NO	<b>M22-K10</b>
	NO, early-make	<b>M22-K10P</b>
	NC	<b>M22-K01</b>
	NC, late-break	<b>M22-K01D</b>
Spring-cage	NO	<b>M22-CK10</b>
	NC	<b>M22-CK01</b>
	NC, late-break	<b>M22-CK01D</b>
	2NO	<b>M22-CK20</b>
	2NC	<b>M22-CK02</b>
	NO-NC	<b>M22-CK11</b>
	NC	<b>M22-FK01</b> <sup>⑤</sup>
NO	<b>M22-FK10</b> <sup>⑤</sup>	

#### M22-FK01



#### Notes

- ① Includes contact block mounting adapter.
- ② For complete listing of available contact blocks, see Accessories, **Pages V7-T1-111 to V7-T1-116**.
- ③ When ordering, specify inscription per catalog number suffix from the Symbols Library (see **Pages V7-T1-129 to V7-T1-136**) into the Order Notes.  
For example, M22-D4-S-ETCH; Order Notes: Mark with symbol X91, Line item #\_.
- ④ All NC contact blocks are positively driven contact.
- ⑤ Additional contacts may not be stacked behind M22-F type contact blocks, M22-F can be stacked behind standard M22 contacts only.

# 1

## Joysticks

### Product Description

Eaton's M22 joystick line comes in a wide variety of options. From vertical and horizontal two-position switches to the maintained four-position, these operators fit a variety of applications. An additional option, two switch points, allows for eight isolated circuits to be actuated individually on a single operator.

### Features

- Available in four-position and two-position
- Two switch point option allows for two contacts in each direction (up to eight total contacts in one operator)
- Capable of communicating via ASi protocol with ASi adapter modules

### Protection Type

- IP66

## Product Selection

### Joysticks

#### Components

M22-WJ2H



M22M-WJ2H



#### Operators <sup>①</sup>

Number of Directions	Switching Position	Silver Bezel Catalog Number	Black Bezel Catalog Number	Metal Bezel Catalog Number
Two-position horizontal	Momentary	M22-WJ2H	M22S-WJ2H	M22M-WJ2H
Two switch points		M22-WJ2H-2P	M22S-WJ2H-2P	M22M-WJ2H-2P
Two-position horizontal	Maintained	M22-WRJ2H	M22S-WRJ2H	M22M-WRJ2H
Two-position vertical	Momentary	M22-WJ2V	M22S-WJ2V	M22M-WJ2V
Two switch points		M22-WJ2V-2P	M22S-WJ2V-2P	M22M-WJ2V-2P
Two-position vertical	Maintained	M22-WRJ2V	M22S-WRJ2V	M22M-WRJ2V
Four-position	Momentary	M22-WJ4	M22S-WJ4	M22M-WJ4
Two switch points		M22-WJ4-2P	M22S-WJ4-2P	M22M-WJ4-2P
Four-position	Maintained	M22-WRJ4	M22S-WRJ4	M22M-WRJ4

#### Note

<sup>①</sup> Includes contact block mounting adapter.

### Joysticks

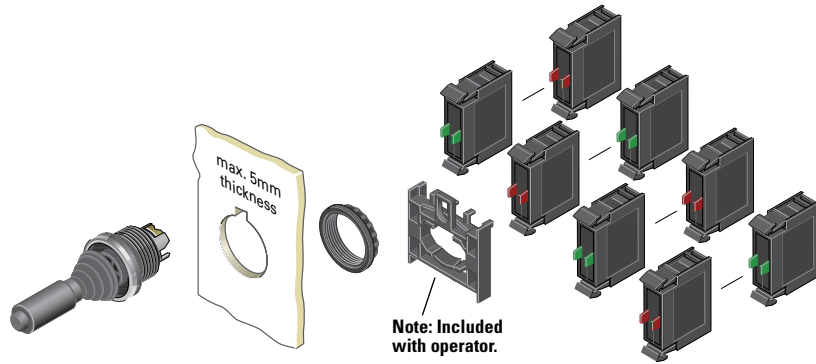

#### M22-K10



#### M22-FK01



#### Contact Blocks <sup>①②</sup>

Terminal Type	Contact Configuration <sup>③</sup>	Catalog Number
Screw	NO	<b>M22-K10</b>
	NO, early-make	<b>M22-K10P</b>
	NC	<b>M22-K01</b>
	NC, late-break	<b>M22-K01D</b>
Spring-cage	NO	<b>M22-CK10</b>
	NC	<b>M22-CK01</b>
	NC, late-break	<b>M22-CK01D</b>
	2NO	<b>M22-CK20</b>
	2NC	<b>M22-CK02</b>
	NO-NC	<b>M22-CK11</b>
	NC	<b>M22-FK01</b> <sup>④</sup>
	NO	<b>M22-FK10</b> <sup>④</sup>

#### Joystick with Double Contact

The joystick allows the control of up to four directions of movement on machines. Different variants of the joystick have two/four-positions and other variants have two settings for each position. This allows, for example, two-speed settings for each direction. For this application, a standard normally open contact and an early-make contact are fitted in series. Momentary contact and latching contact versions are available.

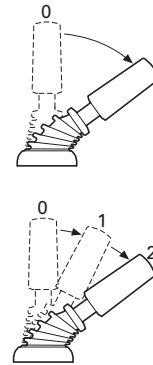

#### Notes

- ① Includes contact block mounting adapter.
- ② For complete listing of available contact blocks, see Accessories, Pages V7-T1-111 to V7-T1-116.
- ③ All NC contact blocks are positively driven contact. ⊖
- ④ Additional contacts may not be stacked behind M22-F type contact blocks, M22-F can be stacked behind standard M22 contacts only.

### Potentiometers

#### Product Description

Eaton's M22 potentiometers allow for a ready to use operator in a conveniently sized package. M22 potentiometers include the resistive element, instead of just a knob, and a built in legend surrounding the knob. The slim design, with integrated contacts and the range of resistances available, allows for a quick install.

#### Features

- Scale markings on the knob allows the operator to be used without an additional legend plate
- Oversized knob option available
- Slim design allows for space saving and simple wiring and installation

#### Protection Type

- IP66
- NEMA 4X, 13

### Product Selection

#### Potentiometers

##### M22-R10K



##### M22M-R10K



#### Complete Devices

Bezel	Resistance Rk	Catalog Number
Silver	1	M22-R1K
	4.7	M22-R4K7
	10	M22-R10K
	47	M22-R47K
	100	M22-R100K
Black	470	M22-R470K
	1	M22S-R1K
	4.7	M22S-R4K7
	10	M22S-R10K
	47	M22S-R47K
Metal	100	M22S-R100K
	470	M22S-R470K
	1	M22M-R1K
	4.7	M22M-R4K7
	10	M22M-R10K
Oversized Knob	47	M22M-R47K
	100	M22M-R100K
	470	M22M-R470K
	1	M22-R1K-RH
	4.7	M22-R4K7-RH
Silver	10	M22-R10K-RH
	47	M22-R47K-RH
	100	M22-R100K-RH
	470	M22-R470K-RH
	1	M22S-R1K-RH
Black	4.7	M22S-R4K7-RH
	10	M22S-R10K-RH
	47	M22S-R47K-RH
	100	M22S-R100K-RH
	470	M22S-R470K-RH
Metal	1	M22M-R1K-RH
	4.7	M22M-R4K7-RH
	10	M22M-R10K-RH
	47	M22M-R47K-RH
	100	M22M-R100K-RH
470	M22M-R470K-RH	

### Acoustic Devices

#### Product Description

Eaton's M22 acoustic devices are a simple and aesthetic way to add a buzzer or indicator to any application. Fitting in the same 22 mm hole, these devices can be ordered in continuous or pulsed tone and with or without the IP40 enclosure.

#### Features

- Continuous or pulsed tone available
- 83 dB / 10 cm decibel rating
- Slim design allows for space saving and simple wiring and installation

#### Protection Type

- IP40
- NEMA 12

### Product Selection

#### Acoustic Devices

##### M22-AMC-XAM



#### Complete Devices

Description	Decibel Rating	Catalog Number
Indicator with buzzer, black continuous tone, 18–30 Vac/Vdc	83 dB/10 cm	M22-AMC-XAM
Indicator with buzzer, black pulsed tone, 18–30 Vac/Vdc	83 dB/10 cm	M22-AMC-XAMP

##### M22-XAM



#### Buzzers

Description	Decibel Rating	Catalog Number
Indicator without buzzer, black	83 dB/10 cm	M22-AMC
Buzzer only, continuous tone, 18–30 Vac/Vdc	83 dB/10 cm	M22-XAM
Buzzer only, pulsed tone, 18–30 Vac/Vdc	83 dB/10 cm	M22-XAMP

### Through-the-Door Operators

#### Product Description

Eaton’s M22 through-the-door operators use the same familiar flush pushbutton look with the addition of a cut-to-length rod that allows for a simple reset operator.

#### Features

- Customizable laser engraving on all buttons
- More than five million mechanical operations
- Pushrod can be cut to length

#### Protection Type

- IP67, IP69K
- NEMA 4X, 13

### Product Selection

#### Through-the-Door Operators <sup>①</sup>

M22-DZ-B-X6



#### Complete Devices

Color	Inscription	Catalog Number
Blue	—	M22-DZ-B
	RESET	M22-DZ-B-GB14
	Ⓡ	M22-DZ-B-X6
Red	—	M22-DZ-R
	Ⓢ	M22-DZ-R-X0
	STOP	M22-DZ-R-GB0

M22-DZ-X



#### Buttonless Operator

Bezel	Catalog Number
Silver	M22-DZ-X
Metal	M22M-DZ-X

M22-XD-B



#### Button Plates <sup>②</sup>

Color	Inscription	Catalog Number
Blue	—	M22-XD-B <sup>③</sup>
	RESET	M22-XD-B-GB14
	Ⓡ	M22-XD-B-X6
Red	—	M22-XD-R <sup>③</sup>
	Ⓢ	M22-XD-R-X0
	STOP	M22-XD-R-GB0

### Bulkhead Interfaces

#### Product Description

Eaton’s M22 bulkhead interfaces are another unique offering in the M22 line. This device allows for a secure connection to any USB or RJ45 connected device within an enclosure or panel. With an IP65 rating when closed, these devices are not only convenient, but robust and reliable.

#### Features

- Convenient and safe way to make a data connection to inside of the panel without opening the panel door

#### Protection Type

- IP65 when closed, IP20 when connected

### Product Selection

#### Bulkhead Interfaces

M22-USB-SA



#### USB Socket <sup>④⑤</sup>

Used for USB connection plug IP65 when closed, IP20 when connected.

Bezel	Catalog Number
Silver	M22-USB-SA

M22-RJ45-SA



#### RJ45 Socket <sup>⑥</sup>

Used for RJ45 Ethernet connection IP65 when closed, IP20 when connected.

Bezel	Catalog Number
Silver	M22-RJ45-SA

#### Notes

- ① The pushrod is 3.24 in long and can be cut to length.
- ② Any combination of plate color and inscription is available.
- ③ Minimum order quantity of (10).
- ④ USB interface is complete with 2-ft-long USB cable.
- ⑤ USB interface is UL Listed, CSA approved and USB 3.0.
- ⑥ RJ45 interface is an eight-wire connector.



## 1

**ASi Adapter Modules****Product Description**

Eaton's M22 ASi adapter modules add functionality to every operator in the M22 line. These devices can be connected to any operator that uses contact blocks or LED units. The simple snap-on design allows for a quick integration of an entire application of operators to a communicating network.

**Features**

- Allows compatible operators to communicate on an ASi network
- Not only can the status of a contact block be read, but LEDs can be illuminated by an ASi adapter
- ASi adapters simply clip on to the back of the contact blocks and LEDs
- Insulation displacement connectors allow for installation of adapters without any tools
- Two integrated LEDs indicate status of communications

**Protection Type**

- IP20

**Product Selection****ASi Adapter Modules****M22-ASi****Complete Devices**

Description	Catalog Number
ASi adapter module	<b>M22-ASi</b>
ASi adapter module for base mounting	<b>M22-ASi-C</b>
ASi adapter module for E-stop	<b>M22-ASi-S</b>
ASi adapter module for E-stop base mounting	<b>M22-ASi-CS</b>

**Palm Switches**

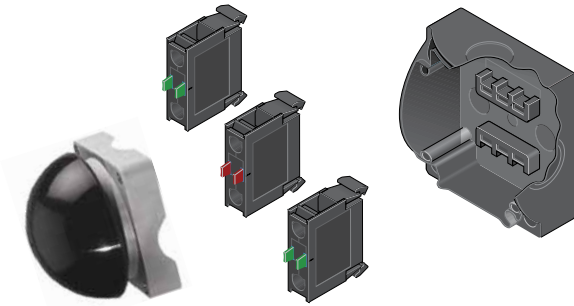

**Product Description**

Eaton’s M22 palm switches are an oversized button that mount directly to an enclosure base. This allows for a standalone button that can be mounted anywhere. The enclosure uses base-mounted contact blocks, which allows for quick wiring and mounting. The palm switches come in momentary or maintained versions. As with other M22 operators, the palm switches are available as complete devices, including the enclosure and contact blocks or as modular components.

**Features**

- Oversized operator in black, red and yellow color options
- Button integrated directly into an enclosure
- Base mounting contact blocks allow for simple wiring and installation
- More than one million mechanical operations on momentary and 100,000 on maintained operators

**Protection Type**

- IP67, IP69K
- NEMA 4X, 13

**Catalog Number Selection**

Catalog Number Selection is for illustrative purposes only and not to be used to create new catalog numbers.

**Palm Switches, Type 4X/13 Enclosure**

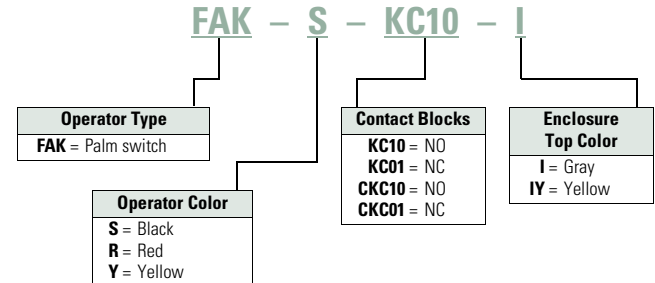

**Product Selection**

**Complete Devices**

**Operator, Base and Contact Blocks ①**

Button Color	Contact Block Configuration ②	Catalog Number
<b>FAK-S-KC11-I</b>		
<b>Momentary</b>		
Black	1NO-1NC	<b>FAK-S-KC11-I</b>
Red	1NO-1NC	<b>FAK-R-KC11-I</b>
Yellow	1NO-1NC	<b>FAK-Y-KC11-I</b>
<b>FAK-R-V-KC01-IY</b>		
<b>Maintained</b>		
Red	NC	<b>FAK-R-V-KC01-IY</b>
	2NC	<b>FAK-R-V-KC02-IY</b>
	1NO-2NC	<b>FAK-R-V-KC12-IY</b>
	1NO-1NC	<b>FAK-R-V-KC11-IY</b>

**Notes**

① For complete listing of available contact blocks, see Accessories, Pages V7-T1-111 to V7-T1-116.

② All NC contact blocks are positively driven contact. ⊖

## Components

## FAK-S



## Operators Only

Type	Button Color	Catalog Number
Momentary	Black	<b>FAK-S</b>
	Red	<b>FAK-R</b>
	Yellow	<b>FAK-Y</b>
Maintained	Red	<b>FAK-R-V-Y</b>

## FAK-IU



## Palm Switch Enclosure Base

## Catalog Number

FAK-IU

## M22-K10

Contact Blocks <sup>①</sup>

Terminal Type	Contact Configuration <sup>②</sup>	Catalog Number
Screw	NO	<b>M22-KC10</b>
	NC	<b>M22-KC01</b>
Spring-cage	NO	<b>M22-CKC10</b>
	NC	<b>M22-CKC01</b>
	NC	<b>M22-FK01 <sup>③</sup></b>
	NO	<b>M22-FK10 <sup>③</sup></b>

## M22-FK01



## Notes

<sup>①</sup> For complete listing of available contact blocks, see Accessories, **Pages V7-T1-111 to V7-T1-116.**

<sup>②</sup> All NC contact blocks are positively driven contact. 

<sup>③</sup> Additional contacts may not be stacked behind M22-F type contact blocks, M22-F can be stacked behind standard M22 contacts only.

Accessories

Button Plates

M22-XD-S



M22-XDH-R



M22-XDP-G



Color	Inscription	Catalog Number Flush Pushbutton	Catalog Number Extended Pushbutton	Catalog Number Mushroom Head Button
Black	—	M22-XD-S	M22-XDH-S	M22-XDP-S
White	—	M22-XD-W	M22-XDH-W	M22-XDP-W
Red	—	M22-XD-R	M22-XDH-R	M22-XDP-R
Green	—	M22-XD-G	M22-XDH-G	M22-XDP-G
Yellow	—	M22-XD-Y	M22-XDH-Y	M22-XDP-Y
Blue	—	M22-XD-B	M22-XDH-B	—
Black, white, red, green, yellow, blue	—	M22-XD-SWRGYB	M22-XDH-SWRGYB	—
Black, red, green	—	M22-XD-SRG	M22-XDH-SRG	—
Black	Custom	M22-XD-S-ETCH	M22-XDH-S-ETCH	M22-XDP-S-ETCH
White	Custom	M22-XD-W-ETCH	M22-XDH-W-ETCH	M22-XDP-W-ETCH
Red	Custom	M22-XD-R-ETCH	M22-XDH-R-ETCH	M22-XDP-R-ETCH
Green	Custom	M22-XD-G-ETCH	M22-XDH-G-ETCH	M22-XDP-G-ETCH
Yellow	Custom	M22-XD-Y-ETCH	M22-XDH-Y-ETCH	M22-XDP-Y-ETCH
Blue	Custom	M22-XD-B-ETCH	M22-XDH-B-ETCH	—
Black	STOP	M22-XD-S-GB0	M22-XDH-S-GB0	M22-XDP-S-GB0
Red	STOP	M22-XD-R-GB0	M22-XDH-R-GB0	M22-XDP-R-GB0
Black	START	M22-XD-S-GB1	M22-XDH-S-GB1	M22-XDP-S-GB1
White	START	M22-XD-W-GB1	M22-XDH-W-GB1	—
Green	START	M22-XD-G-GB1	M22-XDH-G-GB1	M22-XDP-G-GB1
Black	CLOSE	M22-XD-S-GB2	M22-XDH-S-GB2	—
Black	UP	M22-XD-S-GB3	M22-XDH-S-GB3	M22-XDP-S-GB3
Black	DOWN	M22-XD-S-GB4	M22-XDH-S-GB4	M22-XDP-S-GB4
Black	OFF	M22-XD-S-GB5	M22-XDH-S-GB5	M22-XDP-S-GB5
Red	OFF	M22-XD-R-GB5	M22-XDH-R-GB5	M22-XDP-R-GB5
Black	ON	M22-XD-S-GB6	M22-XDH-S-GB6	M22-XDP-S-GB6
Green	ON	M22-XD-G-GB6	M22-XDH-G-GB6	M22-XDP-G-GB6
Black	TEST	M22-XD-S-GB9	M22-XDH-S-GB9	—
Blue	RESET	M22-XD-B-GB14	M22-XDH-B-GB14	—
Black	FORWARD	M22-XD-S-GB15	M22-XDH-S-GB15	M22-XDP-S-GB15
Black	REVERSE	M22-XD-S-GB16	M22-XDH-S-GB16	M22-XDP-S-GB16
Black	RAISE	M22-XD-S-GB17	M22-XDH-S-GB17	—
Black	LOWER	M22-XD-S-GB18	M22-XDH-S-GB18	—
Black	⊙	M22-XD-S-X0	M22-XDH-S-X0	M22-XDP-S-X0
Red	⊙	M22-XD-R-X0	M22-XDH-R-X0	M22-XDP-R-X0
Green	⊙	—	—	M22-XDP-G-X0
Black	⓪	M22-XD-S-X1	M22-XDH-S-X1	M22-XDP-S-X1
White	⓪	M22-XD-W-X1	M22-XDH-W-X1	—
Green	⓪	M22-XD-G-X1	M22-XDH-G-X1	M22-XDP-G-X1
Black	⓪	M22-XD-S-X2	M22-XDH-S-X2	—
Green	⓪	M22-XD-G-X2	M22-XDH-G-X2	—
Black	+	M22-XD-S-X4	M22-XDH-S-X4	M22-XDP-S-X4
Black	−	M22-XD-S-X5	M22-XDH-S-X5	M22-XDP-S-X5
Blue	Ⓜ	M22-XD-B-X6	M22-XDH-B-X6	—
Black	⓪	M22-XD-S-X7	M22-XDH-S-X7	M22-XDP-S-X7
Black	⓪	M22-XD-S-X8	M22-XDH-S-X8	—
Black	See ① below	M22-XD-S-X9	M22-XDH-S-X9	—
Black	See ① below	M22-XD-S-X10	M22-XDH-S-X10	—
Black	See ① below	M22-XD-S-X11	M22-XDH-S-X11	—
Black	See ① below	M22-XD-S-X12	M22-XDH-S-X12	—
Black	See ① below	M22-XD-S-X13	M22-XDH-S-X13	—
Black	See ① below	M22-XD-S-X14	M22-XDH-S-X14	—
Black	See ① below	M22-XD-S-X15	M22-XDH-S-X15	—
Black	See ① below	M22-XD-S-X16	M22-XDH-S-X16	—
Black	See ① below	M22-XD-S-X17	M22-XDH-S-X17	—

Note

① Refer to the Symbols Library, (see Pages V7-T1-129 to V7-T1-136), for symbol image.

1

#### M22-XDLH-W



#### M22-XDL-G



### Button Lenses

Color	Inscription	Catalog Number Flush	Catalog Number Extended	Color	Inscription	Catalog Number Flush	Catalog Number Extended
White	—	M22-XDL-W	M22-XDLH-W	Blue	Custom	M22-XDL-B-ETCH	M22-XDLH-B-ETCH
Red	—	M22-XDL-R	M22-XDLH-R	Red	STOP	M22-XDL-R-GB0	M22-XDLH-R-GB0
Green	—	M22-XDL-G	M22-XDLH-G	Green	START	M22-XDL-G-GB1	M22-XDLH-G-GB1
Yellow	—	M22-XDL-Y	M22-XDLH-Y	Red	OFF	M22-XDL-R-GB5	M22-XDLH-R-GB5
Blue	—	M22-XDL-B	M22-XDLH-B	Green	ON	M22-XDL-G-GB6	M22-XDLH-G-GB6
White	Custom	M22-XDL-W-ETCH	M22-XDLH-W-ETCH	Blue	RESET	M22-XDL-B-GB14	M22-XDLH-B-GB14
Red	Custom	M22-XDL-R-ETCH	M22-XDLH-R-ETCH	Red	Ⓢ	M22-XDL-R-X0	M22-XDLH-R-X0
Green	Custom	M22-XDL-G-ETCH	M22-XDLH-G-ETCH	Green	Ⓛ	M22-XDL-G-X1	M22-XDLH-G-X1
Yellow	Custom	M22-XDL-Y-ETCH	M22-XDLH-Y-ETCH	Blue	Ⓜ	M22-XDL-B-X6	M22-XDLH-B-X6

### Mounting Adapters

Description	Catalog Number
-------------	----------------

#### M22-A



Contact block mounting adapter

M22-A

#### M22-A4



Contact block mounting adapter, four-position (for use with four-way pushbuttons, joysticks and four-position selector switches only).

M22-A4

#### M22-LS



Allows mounting of M22 pushbuttons to LS-Titan limit switch bodies (for the full LS-Titan catalog section, see PG08301004E).

M22-LS

### Contact Blocks

Mounting Location	Terminal Type	Contact Configuration <sup>①</sup>	Package Qty.	Catalog Number		
Front	Screw	NO	1	M22-K10		
		NO	25	M22-K10-B25		
		NO	100	M22-K10-B100		
		NO, early-make	1	M22-K10P		
		NC	1	M22-K01		
		NC	25	M22-K01-B25		
		NC	100	M22-K01-B100		
		NC, late-break	1	M22-K01D		
		SMCB, NC	1	M22-K01SMC10		
		SMCB, 2NC	1	M22-K02SMC10		
		Base		NO	1	M22-KC10
				NO	25	M22-KC10-B25
				NO	100	M22-KC10-B100
				NC	1	M22-KC01
NC	25			M22-KC01-B25		
NC	100			M22-KC01-B100		
SMCB, NC	1			M22-KC01SMC10		
SMCB, 2NC	1			M22-KC02SMC10		
Front	Spring-cage			NO	1	M22-CK10
				NC	1	M22-CK01
		NC, late-break	1	M22-CK01D		
		2NO <sup>②</sup>	1	M22-CK20		
		2NC <sup>②</sup>	1	M22-CK02		
		NO-NC <sup>②</sup>	1	M22-CK11		
		NC	20	M22-FK01 <sup>③</sup>		
		NO	20	M22-FK10 <sup>③</sup>		
		Base		NO	1	M22-CKC10
				NC	1	M22-CKC01

#### Notes

<sup>①</sup> All NC contact blocks are positively driven contact. Ⓢ

<sup>②</sup> Not stackable.

<sup>③</sup> Additional contacts may not be stacked behind M22-F type contact blocks, M22-F can be stacked behind standard M22 contacts only.

M22-LED-W



M22-FLED- \_



### Light Units

Terminal Type	Mounting Location	LED Color	Light Unit Voltage	Catalog Number		
Screw	Front	White	12–30 Vac/Vdc	M22-LED-W		
		Red		M22-LED-R		
		Green		M22-LED-G		
		Blue		M22-LED-B		
		White	85–264 Vac	M22-LED230-W		
		Red		M22-LED230-R		
		Green		M22-LED230-G		
		Blue		M22-LED230-B		
		White	207–264 Vac	M22-LED230H-W		
		Red		M22-LED230H-R		
		Green		M22-LED230H-G		
		Blue		M22-LED230H-B		
		Base	White	12–30 Vac/Vdc	M22-LEDC-W	
					Red	M22-LEDC-R
					Green	M22-LEDC-G
					Blue	M22-LEDC-B
	White		85–264 Vac	M22-LEDC230-W		
				Red	M22-LEDC230-R	
				Green	M22-LEDC230-G	
				Blue	M22-LEDC230-B	
White	207–264 Vac		M22-LEDC230H-W			
			Red	M22-LEDC230H-R		
			Green	M22-LEDC230H-G		
			Blue	M22-LEDC230H-B		
Spring-cage	Front		White	12–30 Vac/Vdc	M22-CLED-W	
			Red		M22-CLED-R	
		Green	M22-CLED-G			
		Blue	M22-CLED-B			
		White	85–264 Vac	M22-CLED230-W		
		Red		M22-CLED230-R		
		Green		M22-CLED230-G		
		Blue		M22-CLED230-B		
		Base	White	12–30 Vac/Vdc	M22-CLEDC-W	
					Red	M22-CLEDC-R
					Green	M22-CLEDC-G
					Blue	M22-CLEDC-B
	White		85–264 Vac	M22-CLEDC230-W		
				Red	M22-CLEDC230-R	
	Front	White	12–30 Vac/Vdc	M22-FLED-W		
				Red	M22-FLED-R	
				Green	M22-FLED-G	
				Blue	M22-FLED-B	
		Red/Green/Yellow	24 Vdc	M22-FLED-RG ①		
		Red, Green, Blue, Yellow, White, Violet, Turquoise		M22-FLED-RGB ①		

M22-XLED60



### LED Resistor and Test Elements

Terminal Type	Mounting Location	Element Type	Voltage	Catalog Number
Screw	Front	Resistor ②③	42–60 Vac/Vdc	M22-XLED60
			220 Vdc	M22-XLED220
		Test	12–240 Vac/Vdc	M22-XLED-T
			85–264 Vac	M22-XLED230-T



**Notes**

- ① Please see color input key on **Page V7-T1-114**.
- ② Resistor units to be used with 12–30V light units.
- ③ Refer to **IL04716002E** for use of resistor elements in series for higher DC voltage.

## Multi-Color LED Input Guide

Catalog Number		Terminal Color			
		X1 +R	X2 +G	X3 +B	X4 GND
<b>M22-FLED-RG</b>	Red	■	—	—	■
	Green	—	■	—	■
	Yellow	■	■	—	■
<b>M22-FLED-RGB</b>	Red	■	—	—	■
	Green	—	■	—	■
	Yellow	■	■	—	■
	White	■	■	■	■
	Blue	—	—	■	■
	Violet	■	—	■	■
	Turquoise	—	■	■	■

Legend Plate Holders and Inserts, Pushbuttons and Double Pushbuttons <sup>①</sup>

	Description	Inscription	Catalog Number
<b>M22S-ST-X</b> 	Legend plate holder, without legend plate insert, for pushbuttons	—	<b>M22S-ST-X</b>
	Legend plate holder, without legend plate insert, for double pushbuttons	—	<b>M22S-STDD-X</b>
<b>M22-XST-GB0</b> 	Legend plate insert	—	<b>M22-XST</b>
		Custom	<b>M22-XST-ETCH</b> <sup>②</sup>
		STOP	<b>M22-XST-GB0</b>
		START	<b>M22-XST-GB1</b>
		OFF	<b>M22-XST-GB5</b>
		ON	<b>M22-XST-GB6</b>
		RUN	<b>M22-XST-GB7</b>
		FAULT	<b>M22-XST-GB8</b>
		OFF ON	<b>M22-XST-GB10</b>
		MAN. AUTO	<b>M22-XST-GB11</b>
		MAN. O AUTO	<b>M22-XST-GB12</b>
		HAND AUTO	<b>M22-XST-D11</b>
		HAND O AUTO	<b>M22-XST-D12</b>
		1	<b>M22-XST-X52</b>
		2	<b>M22-XST-X53</b>
	O I	<b>M22-XST-X88</b>	
	O - I	<b>M22-XST-X89</b>	
	I O II	<b>M22-XST-X93</b>	

**Notes**

<sup>①</sup> Legend plates are IP66 and NEMA 4X/13.

<sup>②</sup> When ordering, specify inscription per catalog number suffix from the Symbols Library (see **Pages V7-T1-129 to V7-T1-136**) into the Order Notes.







For example, M22-XD-S-ETCH; Order Notes: Mark with symbol X91, Line item # \_\_.

**Example**

To order a legend plate for a pushbutton with non-standard markings (FORWARD):

1. Select legend plate holder—M22S-ST-X.
2. Select legend plate insert—M22-XST-ETCH.
3. Select FORWARD from the Symbols Library, **Pages V7-T1-129 to V7-T1-136**, identified by GB15 suffix.
4. Indicate on the order form in the order notes—suffix GB15, line item # \_\_.

### Legend Plates, Complete ①

	Description	Inscription	Catalog Number	
<b>M22S-ST-GB0</b> 	For use with pushbuttons and indicating lights	Legend plate holder with insert	<b>M22S-ST-GB0</b>	
			STOP	<b>M22S-ST-GB1</b>
			START	<b>M22S-ST-GB5</b>
			OFF	<b>M22S-ST-GB6</b>
			ON	<b>M22S-ST-GB7</b>
			RUN	<b>M22S-ST-GB8</b>
			FAULT	<b>M22S-ST-GB8</b>
			1	<b>M22S-ST-X52</b>
			2	<b>M22S-ST-X53</b>
		<b>M22S-ST-GB10</b> 	Selector switches	—
	OFF ON			<b>M22S-ST-GB11</b>
	MAN. AUTO			<b>M22S-ST-GB12</b>
	MAN. 0 AUTO			<b>M22S-ST-D11</b>
	HAND AUTO			<b>M22S-ST-D12</b>
	HAND 0 AUTO			<b>M22S-ST-X88</b>
	0 I			<b>M22S-ST-X89</b>
	0 - I			<b>M22S-ST-X93</b>
	I 0 II			<b>M22S-ST-X93</b>
<b>M22-XZK</b> 	Emergency-stop operators			Rectangular yellow legend plate
			—	<b>M22-XZK-ETCH</b> ②
			EMERGENCY-STOP	<b>M22-XZK-GB99</b>
<b>M22-XYK</b> 	Emergency-stop operators	Square yellow legend plate	<b>M22-XYK</b>	
			—	<b>M22-XYK-ETCH</b> ②
			EMERGENCY-STOP four-language	<b>M22-XYK1</b>
			EMERGENCY-STOP (top and bottom)	<b>M22-XYK5</b>
			—	<b>M22-XAK</b>
<b>M22-XAK</b> 	Emergency-stop operators	Round yellow legend plate, 90 mm	<b>M22-XAK</b>	
			—	<b>M22-XAK-ETCH</b> ②
			Custom	<b>M22-XAK1</b>
			EMERGENCY-STOP four-language	<b>M22-XAK1</b>
			EMERGENCY-STOP (top and bottom)	<b>M22-XAK5</b>
<b>M22-XBK1</b> 	Emergency-stop operators	Round yellow legend plate, 60 mm	<b>M22-XBK</b>	
			—	<b>M22-XBK-ETCH</b> ②
			Custom	<b>M22-XBK1</b>
			EMERGENCY-STOP four-language	<b>M22-XBK1</b>
			EMERGENCY-STOP (top and bottom)	<b>M22-XBK5</b>
<b>M22-XCK1</b> 	Four-way pushbutton, joystick and four-position selector switches	Silver square legend plate	<b>M22-XCK</b>	
			—	<b>M22-XCK-ETCH</b> ②
			Custom	<b>M22-XCK1</b>
			Four directional arrows	<b>M22-XCK2</b>
			0-1-0-2-0-3-0-4	<b>M22-XCK2</b>
	Two directional arrows	<b>M22-XCK3</b>		

#### Notes

- ① Legend plates are IP66 and NEMA 4X/13.
- ② When ordering, specify inscription per catalog number suffix from the Symbols Library (see **Pages V7-T1-129 to V7-T1-136**) into the Order Notes. For example, M22-XD-S-ETCH; Order Notes: Mark with symbol X91, Line item #\_.



#### Surface Mounting Enclosures ①

Description	Catalog Number
<b>M22-IY1-PG</b> Yellow top, black base for emergency-stop operators	<b>M22-IY1-PG</b>
<b>M22-IY-PG</b> One-element enclosure	<b>M22-I1-PG</b>
Two-element enclosure	<b>M22-I2-PG</b>
Three-element enclosure	<b>M22-I3-PG</b>
Four-element enclosure	<b>M22-I4-PG</b>
Six-element enclosure	<b>M22-I6-PG</b>
M20 connecting screw	<b>M22-XI</b>
M20 cord grip	<b>V-M20</b>

#### Flush Mounting Plates, Aluminum

Finish	Rating	Catalog Number
<b>One Hole</b>		
Yellow paint for emergency-stop operators	—	<b>M22-EY1</b>
Gray anodized	IP65	<b>M22-E1</b>
<b>Two Holes</b>		
Gray anodized	IP65	<b>M22-E2</b>
<b>Three Holes</b>		
Gray anodized	IP65	<b>M22-E3</b>
<b>Four Holes</b>		
Gray anodized	IP65	<b>M22-E4</b>
<b>Five Holes</b>		
Gray anodized	IP65	<b>M22-E5</b>
<b>Six Holes</b>		
Anodized	IP40	<b>M22-E6</b>

#### Shrouds, Plastic

Description	Rating	Catalog Number
<b>M22-H1</b> One-element	IP55	<b>M22-H1</b>
Two-element	IP55	<b>M22-H2</b>
Three-element	IP55	<b>M22-H3</b>
Four-element	IP40	<b>M22-H4</b>
Five-element	IP40	<b>M22-H5</b>
Six-element	IP40	<b>M22-H6</b>
Mounting plate	—	<b>M22-XE5</b>
Plaster keys for flush mounting	—	<b>M22-UPE</b>





#### Selector Switch Accessories

Description	Catalog Number
<b>M22-XW</b> Plunger bridge ②	<b>M22-XW</b>
<b>M22-XWS</b> Key cover	<b>M22-XWS</b>
<b>M22-XC-R</b> Key withdraw adapter ③	<b>M22-XC-R</b>
<b>M22-XC-Y</b> Coding adapter	<b>M22-XC-Y</b>
<b>M22-XGWK</b> Guard ring	<b>M22-XGWK</b>

#### Notes

- ① Requires use of base mounted contact blocks.
- ② Plunger needed to actuate center-mounted contact blocks. Used for non-illuminated three-position selector switches only.
- ③ Enables a keyed selector switch to be set to user-selected key withdraw position.

### Emergency Stop Operator Accessories

	Description	Voltage	Catalog Number
	Yellow guard ring	—	<b>M22-XGPV</b>
	Gray guard ring	—	<b>M22G-XGPV</b>
	Rectangular guard	—	<b>M22-MGTA</b>
	Sealing shroud	—	<b>M22-PL-PV</b>
	Illuminated ring	24 Vac/Vdc	<b>M22-XPV60-Y-24</b>
		120 Vac	<b>M22-XPV60-Y-120</b>
		230 Vac	<b>M22-XPV60-Y-230</b>

### Blanking Plugs

M22-B	Color	Catalog Number
	Gray	<b>M22-B</b>
	Black	<b>M22S-B</b>

### Notching Tool

 Punching tool used to produce the cutout for the anti-rotation tab as defined in IEC/EN 60947-5-1.

Description	Unit	Article Number	Catalog Number
St 37 sheet steel: Max. 3 mm thickness	1	028144	<b>M22-NT</b>
Stainless steel: Max. 1.5 mm thickness			

### Mounting Accessories

	Description	Catalog Number
	Telescopic clip with top-hat rail	<b>M22-TC</b>
	Telescopic clip	<b>M22-TA</b>
	Telescopic clip extension	<b>M22-TCV</b>
	DIN rail mounting adapter	<b>M22-IVS</b>
	Mounting ring	<b>M22-GR</b>
	Mounting ring tool	<b>M22-MS</b>
	Adapter ring set for 30 mm holes	<b>M22S-R30</b>
		<b>M22-R30</b>

### Protective Diaphragm

M22-T-D and M22-T-DD	For Use with ...	Catalog Number
	Flush pushbuttons and indicating lights	<b>M22-T-D</b>
	Double pushbuttons	<b>M22-T-DD</b>

### Dust Covers

M22-ADC4	Description	Catalog Number
	Contact block dust cover	<b>M22-XKDP</b>
	Operator dust cover, max three contact blocks	<b>M22-ADC</b>
	Operator dust cover, max four contact blocks	<b>M22-ADC4</b>

### Kits

Description	Catalog Number
Includes one each: M22-XW, M22-XC-R, M22-XC-Y, M22S-B, M22-A, M22-XD-SWRGYB	<b>M22-KT1</b>

## Coding Adapter Guide Selector Switches

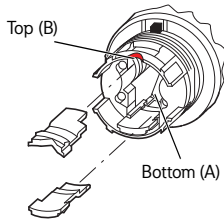

### Two-Position Selector Switch

Top (B)	Bottom (A)	Catalog Number	Function
		M22(S)-W(L)(K)	Momentary
		M22(S)-WR(L)(K)	Maintained

### Three-Position Selector Switch

Top (B)	Bottom (A)	Catalog Number	Function Left	Right
		M22(S)-W(L)(K)3	Momentary	Momentary
		M22(S)-WR(L)(K)3	Maintained	Maintained
		M22(S)-WR(L)(K)3-1	Maintained	Momentary
		M22(S)-WR(L)(K)3-2	Momentary	Maintained

### Two-Position Key-Operated Selector Switch

Top (B)	Bottom (A)	Catalog Number	Center Key Withdraw	Right Function	Key Withdraw
		M22(S)-WS	Yes	Momentary	No
		M22(S)-WRS	Yes	Maintained	Yes
		M22(S)-WRS-A1	Yes	Maintained	No

### Three-Position Key-Operated Selector Switch

Top (B)	Bottom (A)	Catalog Number	Left Function	Key Withdraw	Center Key Withdraw	Right Function	Key Withdraw
		M22(S)-WS3	Momentary	No	Yes	Momentary	No
		M22(S)-WRS3	Maintained	Yes	Yes	Maintained	Yes
		M22(S)-WRS3-A1	Maintained	No	Yes	Maintained	No
		M22(S)-WRS3-A2	Maintained	Yes	Yes	Maintained	No
		M22(S)-WRS3-A3	Maintained	No	Yes	Maintained	Yes
		M22(S)-WRS3-A4	Maintained	Yes	Yes	Momentary	No
		M22(S)-WRS3-A5	Maintained	No	Yes	Momentary	No
		M22(S)-WRS3-A6	Momentary	No	Yes	Maintained	Yes
		M22(S)-WRS3-A7	Momentary	No	Yes	Maintained	No

## Technical Data and Specifications

### Pushbuttons, Indicating Lights, Selector Switches and Emergency-Stop Operators

Description		Momentary Pushbuttons	Maintained Pushbuttons	Indicating Lights, Buzzers and Potentiometers	Emergency-Stop Operators	Selector Switches	Key-Operated Operators	Double Pushbuttons
<b>General</b>								
Standards		IEC/EN 60947 VDE 0660 UL #E29184	IEC/EN 60947 VDE 0660 UL #E29184	IEC/EN 60947 VDE 0660 UL #E29184	IEC/EN 60947 VDE 0660 UL #340491	IEC/EN 60947 VDE 0660 UL #E29184	IEC/EN 60947 VDE 0660 UL #E29184	IEC/EN 60947 VDE 0660 UL #E29184
Lifespan, mechanical	Operations	x 10 <sup>6</sup>	>5	>1	—	>0.1	>0.1	>0.2
Operating frequency	Operations/h		≥3600	≥1800	—	≥600	≥2000	≥3600
Actuating force	n		≥5	≥5	—	≥50	—	≥5
Operating torque (screw terminals)	Nm		—	—	—	≥0.3	≥0.5	—
<b>Protection Type</b>								
IP		IP67, IP69K	IP67, IP69K	Indicating lights: IP67, 69K Buzzers: IP40 Potentiometers: IP66	IP67, IP69K	IP66	IP66	IP66
UL type		4X, 13	4X, 13	Indicating lights: 4X/13 Buzzers: 12 Potentiometers: 4X/13	4X, 13	4X, 13	4X, 13	4X, 13
Climatic proofing		Damp heat, constant, according to IEC 60068-2-78 Damp heat, cyclical to IEC 60068-2-30						
Ambient temperature, operating		°F (°C)	–13 to 158 (–25 to 70)	–13 to 158 (–25 to 70)	–13 to 158 (–25 to 70)	–13 to 158 (–25 to 70)	–13 to 158 (–25 to 70)	–13 to 158 (–25 to 70)
Mounting position			As required	As required	As required	As required	As required	As required
Mechanical shock resistance to IEC 60068-2-27 shock duration 11 ms, half-sinusoidal		g	>30	>30	>30	>50	>30	>30
<b>Terminal Capacities</b>								
Solid		AWG	—	—	20-16	—	—	—
		mm <sup>2</sup>	—	—	0.5–1.5	—	—	—
Stranded		AWG	—	—	20-16	—	—	—
		mm <sup>2</sup>	—	—	0.5–1.5	—	—	—
<b>Contacts</b>								
Rated impulse withstand voltage		U <sub>imp</sub>	Vac	—	4000	—	—	—
Rated insulation voltage		U <sub>i</sub>	V	—	2500	—	—	—
Overvoltage category/pollution degree			—	—	III/3	—	—	—

## Contact Blocks and Light Units

Description			Contact Blocks	LED Light Units
<b>General</b>				
Standards			IEC/EN 60947 VDE 0660 UL #E29184	IEC/EN 60947 VDE 0660 UL #E29184
Lifespan, mechanical	Operations	$\times 10^6$	>5	—
Operating frequency	Operations/h		$\geq 3600$	—
Actuating force	n		$\geq 5$	—
Operating torque (screw terminals)	Nm		$\leq 0.8$	—
<b>Protection Type</b>				
IP			IP20	IP20
UL type			—	—
Climatic proofing			Damp heat, constant, according to IEC 60068-2-78 Damp heat, cyclical to IEC 60068-2-30	
Ambient temperature, operating		°F (°C)	–13 to 158 (–25 to 70)	–13 to 158 (–25 to 70)
Mounting position			As required	As required
Mechanical shock resistance to IEC 60068-2-27 shock duration 11 ms, half-sinusoidal		g	>30	>30
<b>Terminal Capacities</b>				
Solid		AWG	18–14	18–14
		mm <sup>2</sup>	0.75–2.5	0.75–2.5
Stranded		AWG	20–14	20–14
		mm <sup>2</sup>	0.5–2.5	0.5–2.5
<b>Contacts</b>				
Rated impulse withstand voltage	$U_{imp}$	Vac	6000	6000
Rated insulation voltage	$U_i$	V	500	500
Overvoltage category/ pollution degree			III/3	III/3
NEMA contact ratings			A600, Q300	—
Current draw			—	5–15 mA
<b>Control Circuit Reliability</b>				
at 24 Vdc/5 mA	$H_f$	Fault probability	$<10^{-7}$ , <1 fault in $10^7$ operations	—
at 5 Vdc/1 mA	$H_f$	Fault probability	$<5 \times 10^{-6}$ , <1 fault in $5 \times 10^6$ operations	—
<b>Max. Short-Circuit Protective Device</b>				
Fuse	gG/gL	A	10	—
<b>Switching Capacity</b>				
<b>Rated Operational Current</b>				
AC-15				
115V	$I_e$	A	6	—
230V	$I_e$	A	6	—
400V	$I_e$	A	4	—
500V	$I_e$	A	2	—
DC-13				
24V	$I_e$	A	3	—
42V	$I_e$	A	1.7	—
60V	$I_e$	A	1.2	—
110V	$I_e$	A	0.6	—
220V	$I_e$	A	0.3	—
<b>Lifespan, Electrical</b>				
AC-15				
230V/0.5A	Operations	$\times 10^6$	1.6	—
230V/1.0A	Operations	$\times 10^6$	1	—
230V/3.0A	Operations	$\times 10^6$	0.7	—
DV-13				
12V/2.8A	Operations	$\times 10^6$	1.2	—

**Contact Element Note:** >200 Vac/60 Hz: –25/55°C

**Palm Switches**

Description		Momentary	Maintained	FAK-R-V-KC11-I
<b>General</b>				
Standards		IEC/EN 60947 VDE 0660	IEC/EN 60947 VDE 0660	IEC/EN 60947 VDE 0660
Lifespan, mechanical	Operations x 10 <sup>6</sup>	>1	>0.1	>0.1
Operating frequency	Operations/h	≥3600	≥600	≥600
Actuating force	n	20–40	40–60	15–25
Operating torque	Nm	—	—	—
Degree of protection, IEC/EN 60529	IP	IP67, IP69K	IP67, IP69K	IP65
	UL Type	4X, 13	4X, 13	4X, 13
Climatic proofing		Damp heat, constant, to IEC 60068-2-78 Damp heat, cyclic, to IEC 60068-2-30		
Ambient temperature, operating	°F (°C)	–73 to 104 (–25 to 40)	–73 to 104 (–25 to 40)	–73 to 104 (–25 to 40)
Mounting position		As required		
Mechanical shock resistance to IEC 60068-2-27 shock duration 11 ms, half-sinusoidal	g	>15	>15	>15

**ASi Adapter Modules**

Description		M22-ASI	M22-ASI-C
<b>General</b>			
Standards		IEC/EN 60947, DIN EN 50295	IEC/EN 60947, DIN EN 50295
Radio interference suppression		EN 55011, EN 55022	EN 55011, EN 55022
Limit value class		—	—
Protection type		IP20	IP00
Climatic proofing		Damp heat, constant, to IEC 60068-2-78, cyclical, to IEC 60068-2-30	
Ambient temperature, operating	°F (°C)	–13 to 131 (–25 to 55)	–13 to 131 (–25 to 55)
Shock resistance shock duration 11 ms	g	>30	>30
Vibration to IEC 60068-2-27 (amplitude 1 mm)	Hz	—	—
Dimensions	mm	—	—
Weight	kg	—	—
Mounting		Front mounting	Front mounting
Mounting position		As required	As required
<b>Power Supply</b>			
Rated voltage to AS-interface specification	Vdc	26.5–31.6	26.5–31.6
Connection technique		Yellow plug-in terminal as insulation piercing terminal	Two cables onboard
Power supply		Completely from the AS-interface cable	
Addressing		Via connection to AS-interface cable	
Total power consumption of the AS-interface	mA	≥40	≥40
AS-interface		—	—
Rated operational current at full load	mA	—	—
Rated operational current when idle (no I, O set)	mA	—	—
Status LEDs		POWER AS-interface cable: green LED on the rear side of the element ERROR AS-interface, AS-interface master failure: red LED on the rear side of the element	POWER AS-interface cable: green LED on the board ERROR AS-interface, AS-interface master failure: red LED on the board

## ASI-S Adapter Modules

Description		M22-ASI-S	M22-ASI-CS
<b>Inputs</b>			
Inputs, protected against short-circuit	Number	Two (normally 22V/5 mA)	Two (normally 22V/5 mA)
Voltage range	Vdc	—	—
Rated current per input	mA	—	—
High signal level	V	—	—
Low signal	mA	—	—
Length of connecting cables	cm	—	—
<b>Outputs</b>			
Outputs, protected against short-circuit	Number	One (normally 19V/8 mA)	One (normally 19V/8 mA)
Voltage range	Vdc	—	—
<b>Max. Current Carrying Capacity</b>			
All outputs		—	—
∑ three external outputs		—	—
Length of connecting cables	cm	—	—
Profile		S-3.A.E	S-3.A.E
Specification		2.1	2.1
Addresses	Number	62	62
<b>Emergency-Stop Circuits</b>			
Connection of the AS-interface line		Yellow plug terminal with insulation piercing	Two cables on the circuit board
Power supply		Complete from AS-interface, cable 26.5–31.6 Vdc	Complete from AS-interface, cable 26.5–31.6 Vdc
Fixing		Front mounted	Base mounted
Addressing		Via AS-interface cable	Via AS-interface cable
Max. total current	A	45 mA	45 mA
Ambient temperature, operating	°F (°C)	–13 to 131 (–25 to 55)	–13 to 131 (–25 to 55)
Shock resistance		30g/11 ms as per IEC 60068-2-27	30g/11 ms as per IEC 60068-2-27
Protection type		IP20	IP00
Climatic proofing		Damp heat, constant, to IEC 60068-2-78, cyclical, to IEC 60068-2-30	Damp heat, constant, to IEC 60068-2-78, cyclical, to IEC 60068-2-30
Mounting position		As required	As required
Standards		EN 50178 EN 50 295	EN 50178 EN 50 295
Inputs		Two-channel input (22V/5 mA) (moduled by code sequence) (two break contact sets M22-K01)	Two-channel input (22V/5 mA) (moduled by code sequence) (two break contact sets M22-K01)
Outputs		One output, typically 19V/8 mA, short-circuit proof	One output, typically 19V/8 mA, short-circuit proof
<b>Status Displays</b>			
Power, AS-interface cable		Green LED on the back	Green LED on the back
AS-interface error, AS-interface master failure		Red LED on the back	Red LED on the back
Profile		S-7.B.E	S-7.B.E

**Dimensions**

Approximate Dimensions in Inches (mm)

**Operators and Indicating Lights**

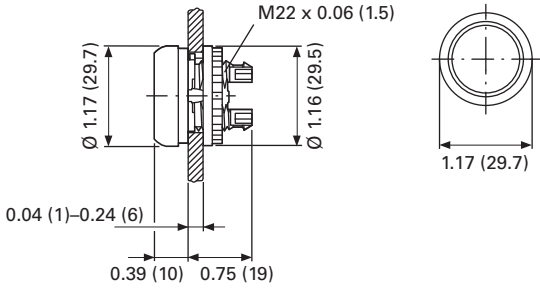

**Pushbuttons**

**M22...-D-**

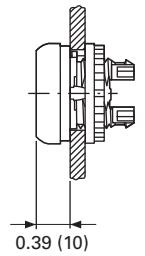

**M22...-DH-**

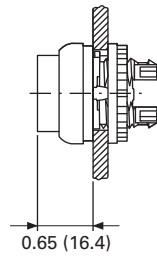

**Selector Switches Operators**

**M22...-W-**

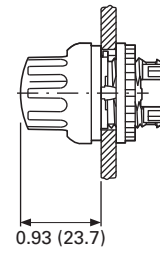

**M22...-WL-**

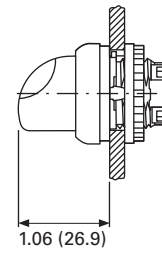

**M22-DG(L)-**

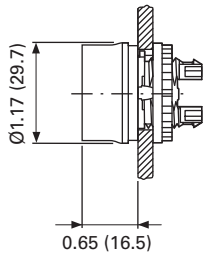

**M22...-DD-**

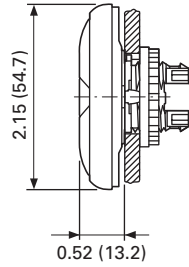

**Key-Operated Selector Switches**

**M22...-W(R)S-**

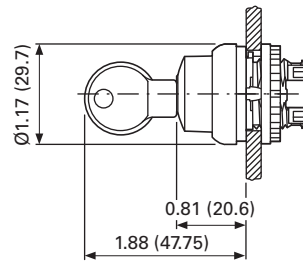

**M22-D, Base Mounted**

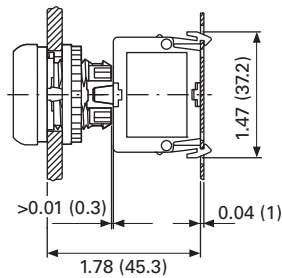

**Indicating Light**

**M22-L**

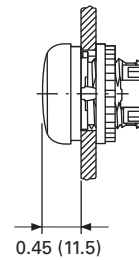



# 1.5

## Pushbuttons and Indicating Lights

### 22.5 mm RMQ-Titan Modular Pushbuttons—M22

1

Approximate Dimensions in Inches (mm)

#### Illuminated Pushbuttons

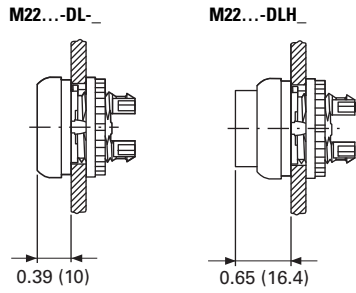

#### Mushroom Head Pushbutton

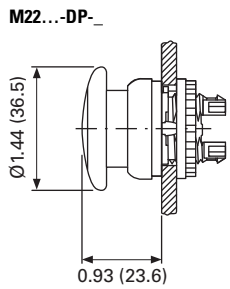

#### Emergency-Stop Operators

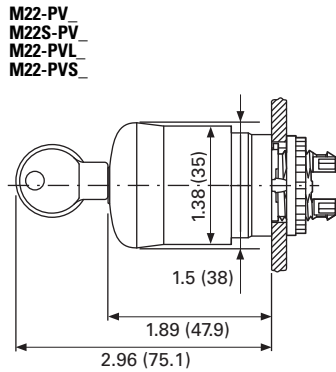

#### Potentiometer

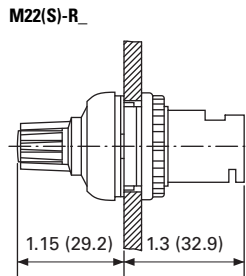

#### Contact Block Mounting Adapter

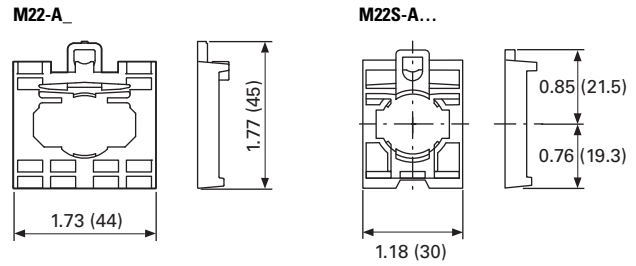

#### Front Mounted Centering Adapter

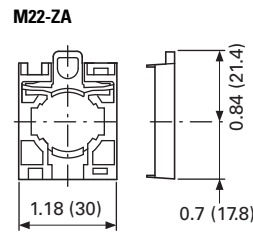

#### Front Mounted Indicating Light

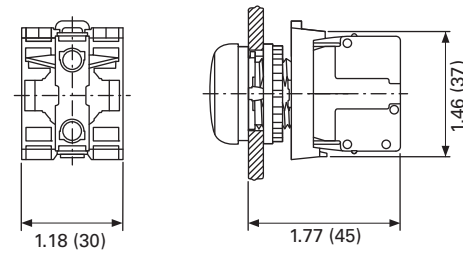

#### Pushbutton, Complete Devices

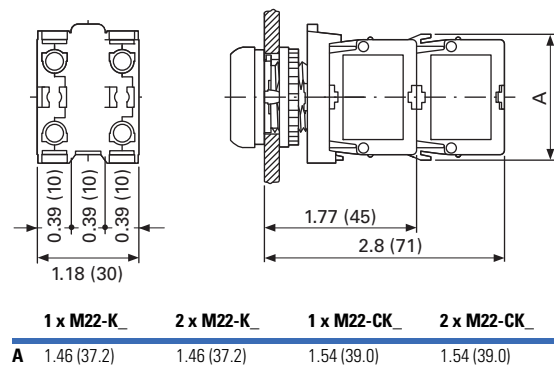

Approximate Dimensions in Inches (mm)

### DIN-Rail Mounting Adapter

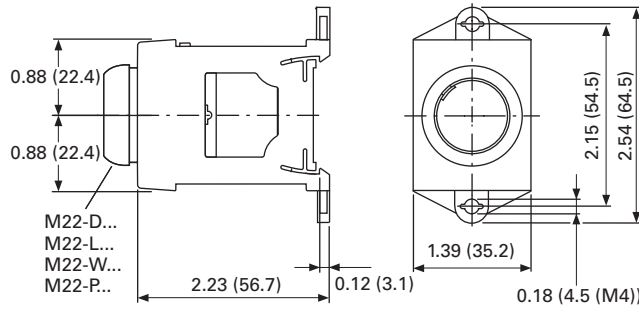

### Pushbuttons and Indicating Lights with M22-TC Telescopic Clip and M22-TVC Extension

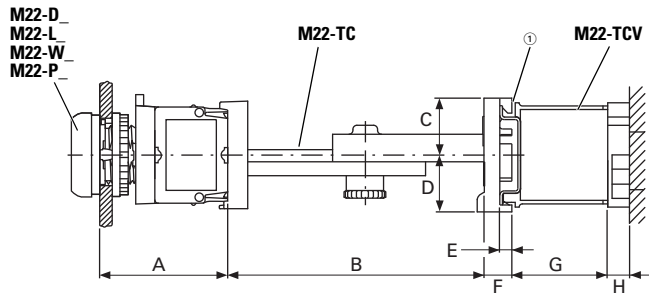

A	B	C	D	E	F	G	H
1.77 (45)	2.36–3.94 (60–100)	0.79 (20)	0.79 (20)	0.18 (4.5)	0.39 (10)	154 (39)	0.39 (10)

① Top-hat rail to IEC/EN 60715.

### Palm Switches

FAK\_

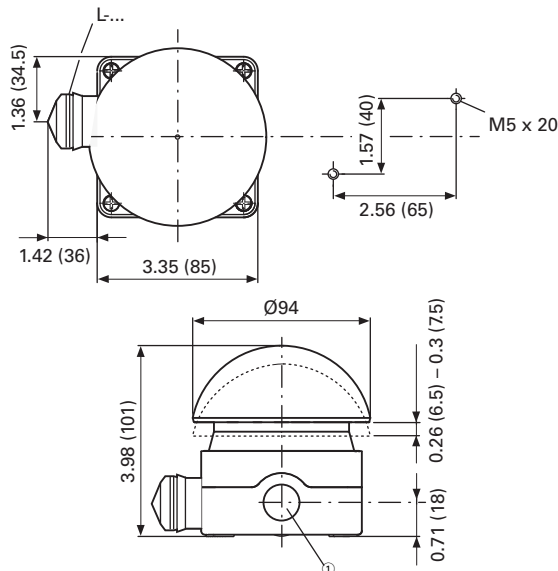

① 3 x M20 lateral, 1 x M16 in bottom.

### Front Mounted Mounting Plate

M22-E\_

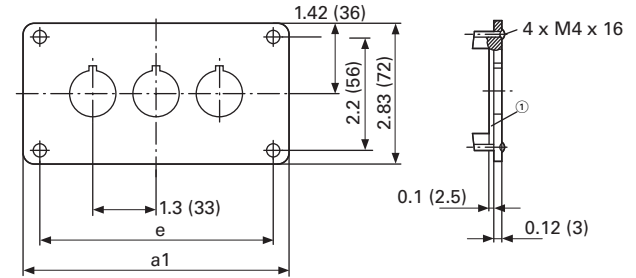

Catalog Number	a1	e
M22-E(Y) ①	2.83 (72)	2.21 (56)
M22-E2	4.13 (105)	3.50 (89)
M22-E3	5.43 (138)	4.80 (122)

Catalog Number	a1	e
M22-E4	6.73 (171)	6.10 (155)
M22-E5	8.03 (204)	7.40 (188)
M22-E6	9.33 (237)	8.70 (221)

### Base Mounted Surface Mounting Enclosure

M22-I\_

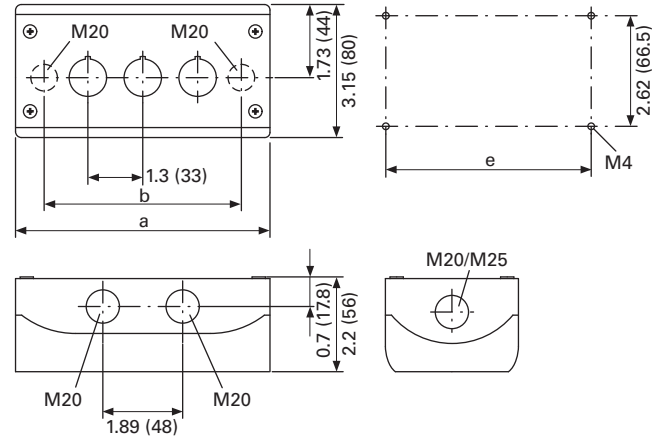

Catalog Number	Mounting Locations	a	b	e	Cable Entries
M22-I(Y)1	1	2.83 (72.0)	1.68 (42.6)	2.30 (58.5)	2 x M16 3 x M20 2 x M25
M22-I2	2	4.72 (120.0)	3.37 (85.6)	4.19 (106.5)	2 x M20 3 x M20 2 x M25
M22-I3	3	6.02 (153.0)	4.67 (118.6)	5.49 (139.5)	2 x M20 2 x M25 4 x M20
M22-I4	4	7.32 (186.0)	5.97 (151.6)	6.79 (172.5)	2 x M20 2 x M25 4 x M20
M22-I6	6	9.92 (252.0)	8.57 (217.6)	9.39 (238.5)	2 x M20 2 x M25 4 x M20

# 1.5

## Pushbuttons and Indicating Lights

### 22.5 mm RMQ-Titan Modular Pushbuttons—M22

1

Approximate Dimensions in Inches (mm)

#### Covers

##### M22-H\_

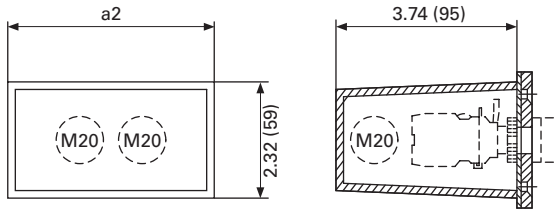

Catalog Number	a2	Cable Entry	Style
M22-H1	1.65 (42)	3 x M20	One-piece
M22-H2	2.95 (75)	4 x M20	
M22-H3	4.25 (108)	4 x M20	
M22-H4	5.55 (141)	4 x M20	Split
M22-H5	6.85 (174)	5 x M20	
M22-HE6	8.15 (207)	6 x M20	

#### Connecting Screw

##### M22-XI

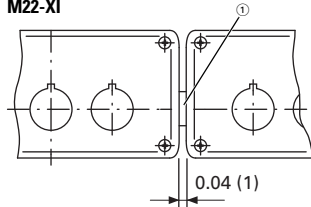

① Gasket.

#### Shroud with Plaster Keys

##### M22-UPE

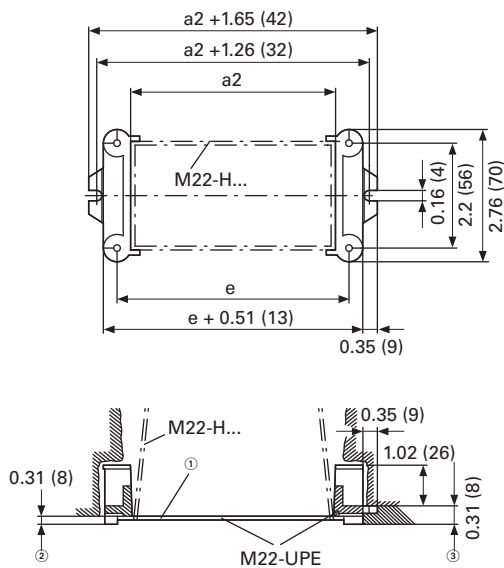

- ② Box for closing off when plastering.
- ③ Plaster thickness less than 8 mm.
- ④ Plaster thickness more than 8 mm.

#### Legend Plates

##### M22S-ST\_

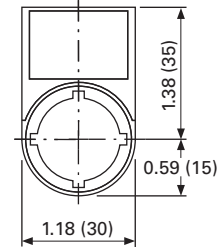

##### M22S-STDD-X

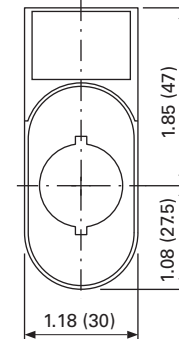

#### Mounting Hole with Lug Slot

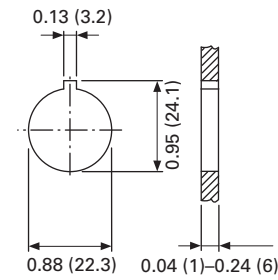

Approximate Dimensions in Inches (mm)

### Grid Dimension to IEC/EN 60947

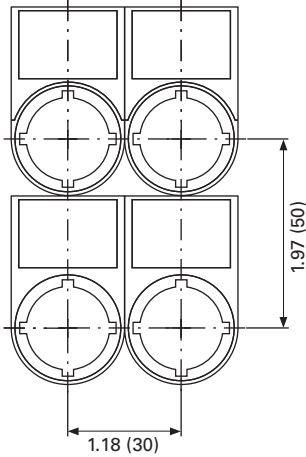

### Grid Dimension for Various Combinations

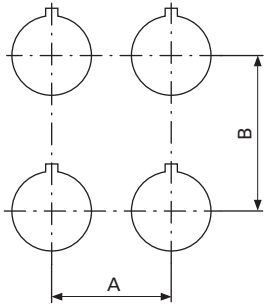

### Pushbutton Diaphragm

Pushbutton diaphragm cannot be combined with label mount.

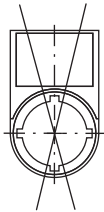

Catalog Number	A ≥	B ≥
<b>M22(S)-_ (IEC/EN 60947)</b>	1.18 (30.0)	1.97 (50.0)
<b>RMQ-Titan min.</b>	1.18 (30.0)	1.58 (40.0)
<b>M22-D_ + M22-T-D</b>	1.30 (33.0)	1.58 (40.0)
<b>M22-D(R)P_</b>	1.50 (38.0)	1.58 (40.0)
<b>M22-PV_</b>	1.50 (38.0)	1.58 (40.0)
<b>M22-PV(L) + M22-PL-PV</b>	1.89 (48.0)	2.20 (56.0)
<b>M22-PV(L)(S_) + M22-D_</b>	1.30 (33.0)	1.58 (40.0)
<b>M22-DDL_</b>	1.18 (30.0)	2.17 (55.0)
<b>M22-DDL_ + M22-T-DD</b>	1.30 (33.0)	2.28 (58.0)
<b>M22-ST_</b>	1.18 (30.0)	1.97 (50.0)
<b>M22-STDD_</b>	1.18 (30.0)	2.95 (75.0)
<b>M22-CK_</b>	1.18 (30.0)	1.77 (45.0)
<b>M22-CLED_</b>	1.18 (30.0)	1.77 (45.0)
<b>M22-XAK_</b>	3.54 (90.0)	3.54 (90.0)
<b>M22-XZK_</b>	1.30 (33.0)	2.04 (52.0)
<b>M22-XBK_</b>	2.36 (60.0)	2.36 (60.0)
<b>M22-XYK_</b>	1.97 (50.0)	1.97 (50.0)
<b>M22-D4</b>	2.17 (55.0)	2.17 (55.0)
<b>M22-WR...4</b>	1.97 (50.0)	1.97 (50.0)
<b>M22-W...J4</b>	1.97 (50.0)	1.97 (50.0)

### Grid Dimension for M22-DD\_

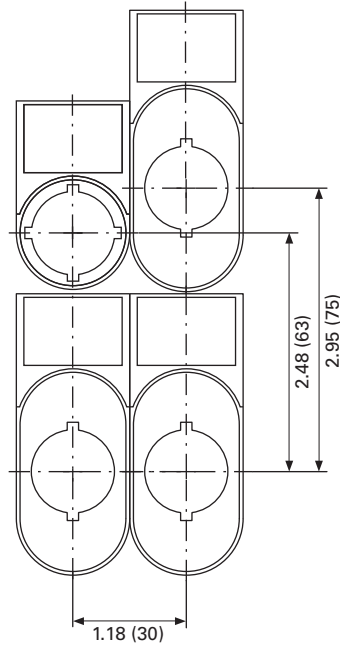

### Grid Dimension for M22-DDL\_

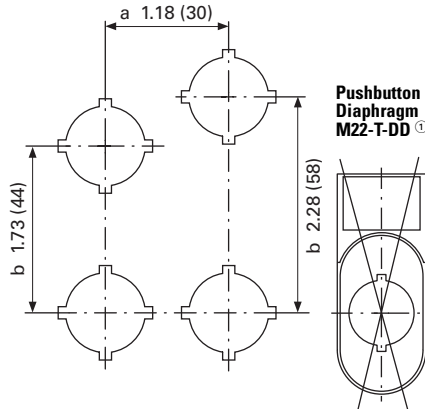

① Pushbutton diaphragm cannot be combined with label mount.

### Emergency Stop Sealing Cover

#### M22-PL-PV

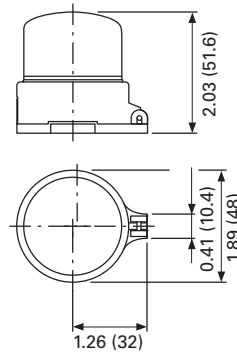

# 1.5

## Pushbuttons and Indicating Lights

### 22.5 mm RMQ-Titan Modular Pushbuttons—M22

1

Approximate Dimensions in Inches (mm)

#### Blanking Plugs

M22...B-<sub>-</sub>

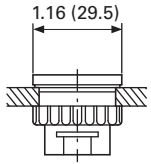

#### Pushbutton Diaphragm

M22-T-D

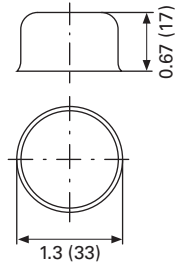

M22-T-D

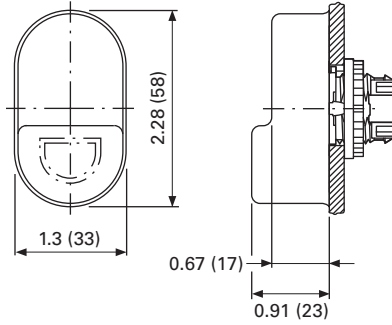

#### Guard Ring

M22-XGWK

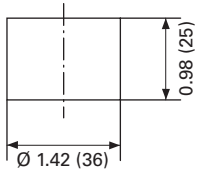

M22-XGPV

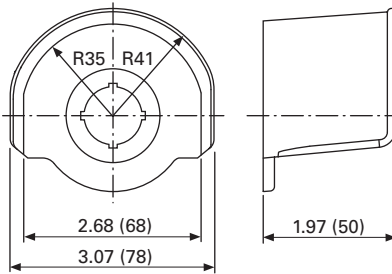

#### Key Cover

M22-XWS

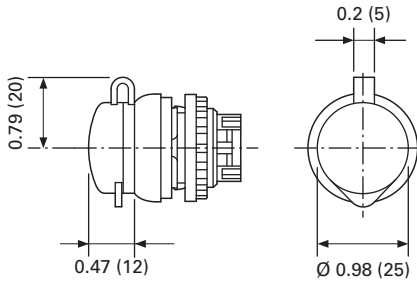

#### Emergency Stop Legend Plate

M22-XAK-<sub>-</sub>

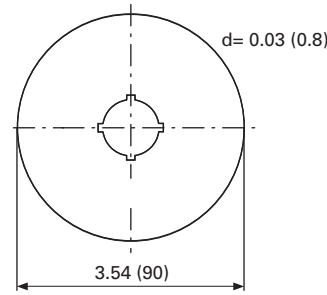

M22-X(Y)ZK-<sub>-</sub>

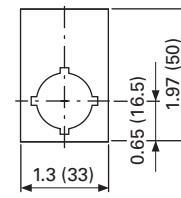

M22-XBK-<sub>-</sub>

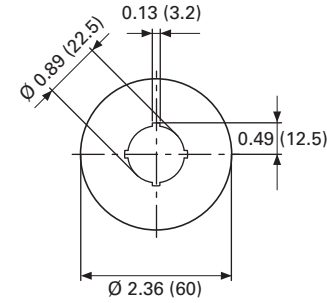

M22-XYK-<sub>-</sub>

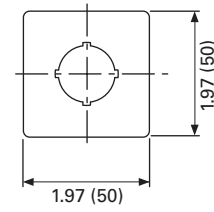

#### Joystick

M22...W...J-<sub>-</sub>

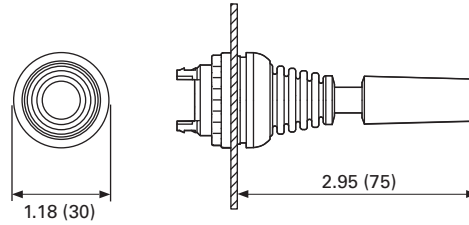

#### Four-Way Pushbutton

M22...D...4-<sub>-</sub>

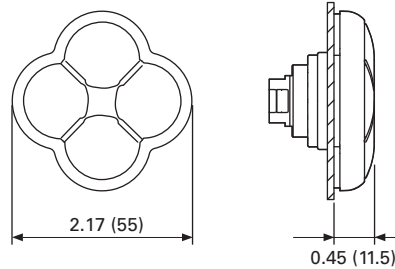

## Symbols Library

### Instructions for Ordering Laser Inscriptions

1. Identify part number to be inscribed.
2. Pick symbol from library and identify suffix code associated with the symbol.
3. Order part number already listed in the catalog with -ETCH suffix.
4. When placing an order by fax or Vistaline on the Web, reference order item number and indicate appropriate suffix code.

### Example

To order a green flush button plate with the inscription AUTO HAND:

Order Catalog Number: M22-XD-G-ETCH (see **Page V7-T1-55**).

AUTO HAND inscription is found on **Page V7-T1-133** in the Symbols Library, suffix code is X91.

In the order notes, reference item number and suffix X91.

Letter height 3 mm: max. three lines, max. 12 characters per line.

Letter height 5 mm: max. two lines, max. eight characters per line.

**Note:** For symbols or text not found in the Symbols Library, please contact the Eaton Technical Resource Center at 1-877-ETN CARE (386-2273) or TRC@eaton.com.

**Letter Height Specifications:** ≤ five characters; letter height = 0.197 in (5 mm). > five characters; letter height = 0.118 in (3 mm).

**Text—English**

Inscription	Catalog Number Suffix
STOP	GB0
START	GB1
CLOSE	GB2
UP	GB3
DOWN	GB4
OFF	GB5
ON	GB6
RUN	GB7
FAULT	GB8
TEST	GB9
OFF ON	GB10
MAN. AUTO	GB11
MAN. 0 AUTO	GB12
RESET	GB14
FORWARD	GB15
REVERSE	GB16
RAISE	GB17

**Text—German**

Inscription	Catalog Number Suffix
LOWER	GB18
LEFT	GB19
RIGHT	GB20
BRAKE	GB21
HIGH	GB22
LOW	GB23
FAST	GB24
SLOW	GB25
FASTER	GB26
SLOWER	GB27
OPEN	GB32
PROG	GB62
CALL	GB63
OCCUPIED	GB64
BYPASS 0 1	GB65
BYPASS UP	GB66
EMERGENCY-STOP	GB99

Inscription	Catalog Number Suffix
Halt	D0
Start	D1
Zu	D2
Auf	D3
Ab	D4
Aus	D5
En	D6
Betrieb	D7
Störung	D8
Prüfung	D9
Aus Ein	D10
HAND AUTO	D11
HAND 0 AUTO	D12
Antrieb	D13
Entsperren	D14
Vorwärts	D15
Rückwärts	D16
Heben	D17
Senken	D18
Links	D19
Rechts	D20
Bremsen	D21
Hoch	D22
Niedrig	D23
Schnell	D24

Inscription	Catalog Number Suffix
Langsam	D25
HAND	D28
AUTO	D29
Einrichten	D30
Tippen	D31
Öffnen	D32
Steuerspannung	D33
Start Automatik	D34
Lampentest	D35
Phasenkontrolle	D36
Alarm	D37
Alarm - Reset	D38
Sammelstörung	D39
Quittieren	D40
Quittierung	D41
Steuerung Ein	D42
Steuerung Aus	D43
Störung quittieren	D44
FÜHLER int. ext.	D72
HEIZUNG 1 2	D73
AUS- BLASEN	D74
SOLLWERT int. ext.	D75
Not-Aus	D99
Not - Aus quittieren	D100

**Text Size: 3 mm**—Max. eight characters in first line; 10 characters in second line; eight characters in third line.



**Text Size: 5 mm**—Max. five characters per line.



**Letter Height Specifications:** ≤ five characters; letter height = 0.197 in (5 mm). > five characters; letter height = 0.118 in (3 mm).

**Text—French**

Inscription	Catalog Number Suffix
ARRÊT	F0
MARCHE	F1
FERMÉ	F2
MONTÉE	F3
DESCENTE	F4
ARRÊT	F5
MARCHE	F6
EN SERVICE	F7
PANNE	F8
ESSAI	F9
ARRÊT MARCHÉ	F10
MAN. AUTO	F11
MAN. 0 AUTO	F12
REARM.	F14
AVANT	F15
ARRIÈRE	F16
MONTER	F17
DESCENDRE	F18
GAUCHE	F19
DROITE	F20
DEFAULT	F67
SOUS TENSION	F68
ARRÊT D'URGENCE	F99

**Text—Swedish**

Inscription	Catalog Number Suffix
STOPP	S0
START	S1
STÄNG	S2
UPP	S3
NED	S4
FRÅN	S5
TILL	S6
KÖR	S7
FEL	S8
PROV	S9
FRÅN TILL	S10
MAN. AUTO	S11
MAN. 0 AUTO	S12
ÅTERSTÄLLNING	S14
FRAM	S15
BACK	S16
ÖKA	S17
MINSKA	S18
VÄNSTER	S19
HÖGER	S20
BROMS	S21
HÖG	S22
LÅG	S23
ÖPPNA	S32
IN	S45
UT	S46
NÖDSTOPP	S99

**Symbols**

Inscription	Catalog Number Suffix	Inscription	Catalog Number Suffix
	X0		X13
	X1		X14
	X2		X15
	X3		X16
	X4		X17
	X5		X18
	X6		X19
	X7		X20
	X8		X21
	X9		X22
	X10		X23
	X11		X24
	X12		X25

**Text Size: 3 mm**—Max. eight characters in first line; 10 characters in second line; eight characters in third line.



**Text Size: 5 mm**—Max. five characters per line.

















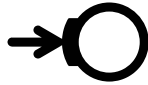





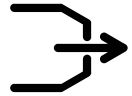



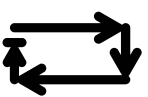

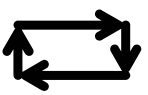













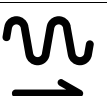

# 1.5

## Pushbuttons and Indicating Lights

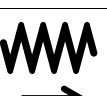
### 22.5 mm RMQ-Titan Modular Pushbuttons—M22

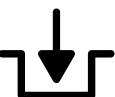
1

Inscription	Catalog Number Suffix	Inscription	Catalog Number Suffix	Inscription	Catalog Number Suffix	Inscription	Catalog Number Suffix
	X26		X40	3	X54		X68
	X27		X41	4	X55		X69
	X28		X42	5	X56		X70
	X29		X43	6	X57		X71
	X30		X44	7	X58		X72
	X31		X45	8	X59		X73
	X32		X46	9	X60		X74
	X33		X47		X61		X75
	X34		X48		X62		X76
	X35		X49		X63		X77
	X36		X50		X64		X78
	X37	0	X51		X65		X79
	X38	1	X52		X66		X80
	X39	2	X53		X67		X81

Text Size: 3 mm—Max. eight characters in first line; 10 characters in second line; eight characters in third line.



Text Size: 5 mm—Max. five characters per line.



Inscription	Catalog Number Suffix	Inscription	Catalog Number Suffix	Inscription	Catalog Number Suffix	Inscription	Catalog Number Suffix
	X82		X104		X118		X132
	X83		X105		X119		X133
	X88		X106		X120		X134
	X89		X107		X121		X135
	X90		X108		X122		X136
	X91		X109		X123		X137
	X92		X110		X124		X138
	X93		X111		X125		X139
	X94		X112		X126		X140
	X95		X113		X127		X141
	X100		X114		X128		X142
	X101		X115		X129		X143
	X102		X116		X130		X144
	X103		X117		X131		X145

**Text Size: 3 mm**—Max. eight characters in first line; 10 characters in second line; eight characters in third line.



**Text Size: 5 mm**—Max. five characters per line.













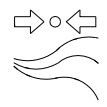



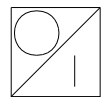
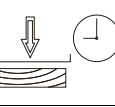

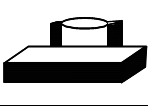
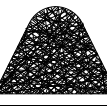
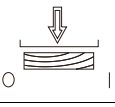

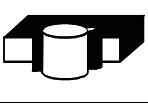
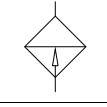

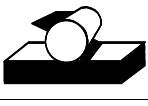
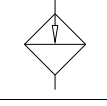
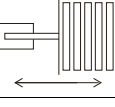

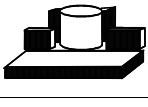
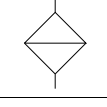
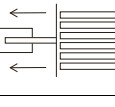

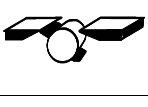
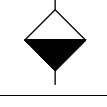
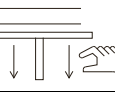

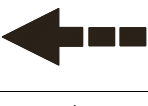
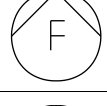
# 1.5

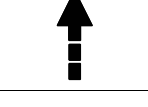
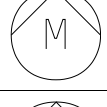
## Pushbuttons and Indicating Lights

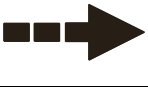
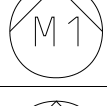
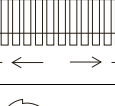
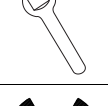
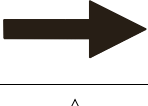
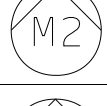
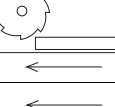
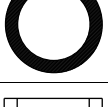
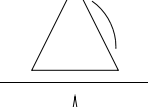
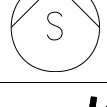
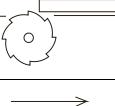
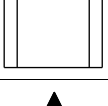
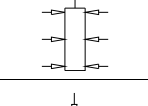
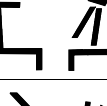
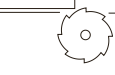
### 22.5 mm RMQ-Titan Modular Pushbuttons—M22

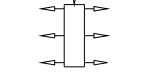
1











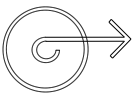



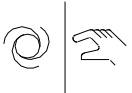

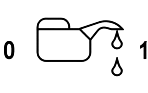
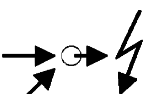









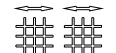
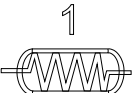









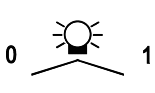





Inscription	Catalog Number Suffix	Inscription	Catalog Number Suffix	Inscription	Catalog Number Suffix	Inscription	Catalog Number Suffix
	X146		X160		X174		X188
	X147		X161		X175		X189
	X148		X162		X176		X190
	X149		X163		X177		X191
	X150		X164		X178		X192
	X151		X165		X179		X193
	X152		X166		X180		X194
	X153		X167		X181		X195
	X154		X168		X182		X196
	X155		X169		X183		X197
	X156		X170		X184		X198
	X157		X171		X185		X199
	X158		X172		X186		X200
	X159		X173		X187		X201

**Text Size: 3 mm**—Max. eight characters in first line; 10 characters in second line; eight characters in third line.



**Text Size: 5 mm**—Max. five characters per line.



Inscription	Catalog Number Suffix	Inscription	Catalog Number Suffix	Inscription	Catalog Number Suffix	Inscription	Catalog Number Suffix
	X202		X216		X230		X244
	X203		X217		X231		X245
L 1	X204		X218		X232		X246
L 2	X205		X219		X233		X247
L 3	X206		X220		X234		X248
↑ A	X207		X221		X235		X249
↓ A	X208		X222		X236		X250
↓ B	X209		X223		X237		X251
↑ B	X210		X224		X238		X252
I	X211		X225		X239		X253
II	X212		X226		X240		X254
III	X213		X227		X241		X255
	X214		X228		X242		X256
	X215		X229		X243		X257

Text Size: 3 mm—Max. eight characters in first line; 10 characters in second line; eight characters in third line.



Text Size: 5 mm—Max. five characters per line.















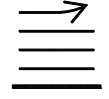



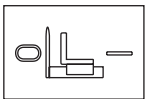





# 1.5

## Pushbuttons and Indicating Lights

### 22.5 mm RMQ-Titan Modular Pushbuttons—M22

1

Inscription	Catalog Number Suffix	Inscription	Catalog Number Suffix	Inscription	Catalog Number Suffix	Inscription	Catalog Number Suffix
	X258		X265	CHEM II	X272		X279
	X259		X266	CHEM III	X273		X280
	X260		X267		X274	OUT OF SERVICE	X281
	X261		X268		X275		X282
	X262		X269	CONTI → CUT	X276		X283
	X263		X270		X277		X284
	X264	CHEM I	X271		X278		X285

Text Size: 3 mm—Max. eight characters in first line; 10 characters in second line; eight characters in third line.



Text Size: 5 mm—Max. five characters per line.



22.5 mm RMQ Compact Pushbuttons—C22



### Contents

<i>Description</i>	<i>Page</i>
22.5 mm RMQ Compact Pushbuttons—C22	
Product Selection Guide . . . . .	<b>V7-T1-139</b>
Pushbuttons—Non-Illuminated and Illuminated . . . . .	<b>V7-T1-140</b>
Indicating Lights . . . . .	<b>V7-T1-153</b>
Emergency Stops . . . . .	<b>V7-T1-156</b>
Selector Switches . . . . .	<b>V7-T1-159</b>
Technical Data and Specifications . . . . .	<b>V7-T1-166</b>
Dimensions . . . . .	<b>V7-T1-168</b>

## Product Overview

### Product Description

Eaton's C22 compact pushbutton line offers an industry leading array of functional, attractive, and ergonomically designed "all-in-one" illuminated and non-illuminated pushbuttons, selector switches, emergency stops and indicating lights. The complete illuminated line is only offered in LED light units to ensure high-quality brightness and up to 100,000 hours of LED illumination. C22 operators are available with either a silver or black bezel and share the exact same front of the panel look and feel as Eaton's M22 line. The C22's compact, "all-in-one" design with the contact block(s) and operators integral provides the user with a simple solution.

The 2017 product extension C22 with pigtail has more than doubled the portfolio. The C22 with pigtail now allows customers the ability to directly mount the product without the need for pushbutton enclosures. With three different connection methods and multiple lengths, the C22 with pigtail can be used for a wide range of applications.

### Wide Product Breadth

- In addition to the standard compact offering of indicating lights and pushbuttons, Eaton's C22 offers keyed and non-keyed operators and emergency stops
- Hundreds of styles with standard laser etch markings with the ability to use custom M22 laser etched buttons in conjunction with C22 buttonless operators
- Pigtail lengths vary from 0.2 to 3.5 m and allow three connection options—M8, M12 and flying lead

### LED Indicators

- 100,000 hours of life in high-vibration environments
- Lenses specifically designed for LED illumination

### Rugged Design

- Pushbuttons (momentary) rated for 5 million mechanical operations and selector switches (non-keyed) rated for 1 million mechanical operations
- All components have IP65 rating, and some carry IP67 and IP69K for wash-down environment, which also means oil tight
- C22 with pigtail has an IP65 rear rating, eliminating the need for an enclosure in dust and water jet applications

### Standards and Certifications

All operators are IEC/EN 60947 VDE 0660, UL Listed, and CSA Certified.

All operators carry an IP65, IP66, IP67 or IP69K rating.

All products carry ratings of NEMA 1, 3R, 4X, 12 and 13



# 1.6

## Pushbuttons and Indicating Lights

### 22.5 mm RMQ Compact Pushbuttons—C22

1

#### Features

- Field convertible maintained pushbuttons from maintained to momentary
- Field convertible selector switches from momentary to maintained operation and vice versa
- LED offering only for all illuminated operators
- Laser engraved pushbuttons and lenses
- Heavy-duty construction with a minimum of IP65 and UL NEMA® Type 4X/13 on front of panel operators. Many operators even carry IP67 and IP69K, for the toughest applications
- Silver or black colored nylon bezels
- Notched hole mounting with anti-rotation tab and central nut mounting on each operator
- Pushbuttons (momentary) rated for 5 million mechanical operations and selector switches (non-keyed) rated for 1 million mechanical operations
- Unique compact offerings, including keyed and non-keyed operators and emergency stops

#### Benefits

- Compact, “all-in-one” operator and contact block design simplifies product selection, inventory, and installation
- Field convertibility of pushbuttons and selector switches helps distributors and customers reduce inventory and increase functionality
- LED offering only for improved brightness quality and up to 100,000 hours of operation
- Plastic construction is corrosion resistant
- Eliminate enclosure, on machine installations
- Operators are designed for rugged environments, ideal for wash-down applications (reference each operator’s IP ratings for ingress protection definition)
- Anti-rotation tab saves installation time and prevents operator rotation
- High mechanical and electrical life allows for use in tough and challenging applications
- Laser inscription capabilities allow for high quality, wear-resistant markings
- By having a compact design emergency stop, the C22 design eliminates the need for self-monitoring contact blocks
- M12/M8 connections allow connection directly into communications systems such as SmartWire-DT or AS6

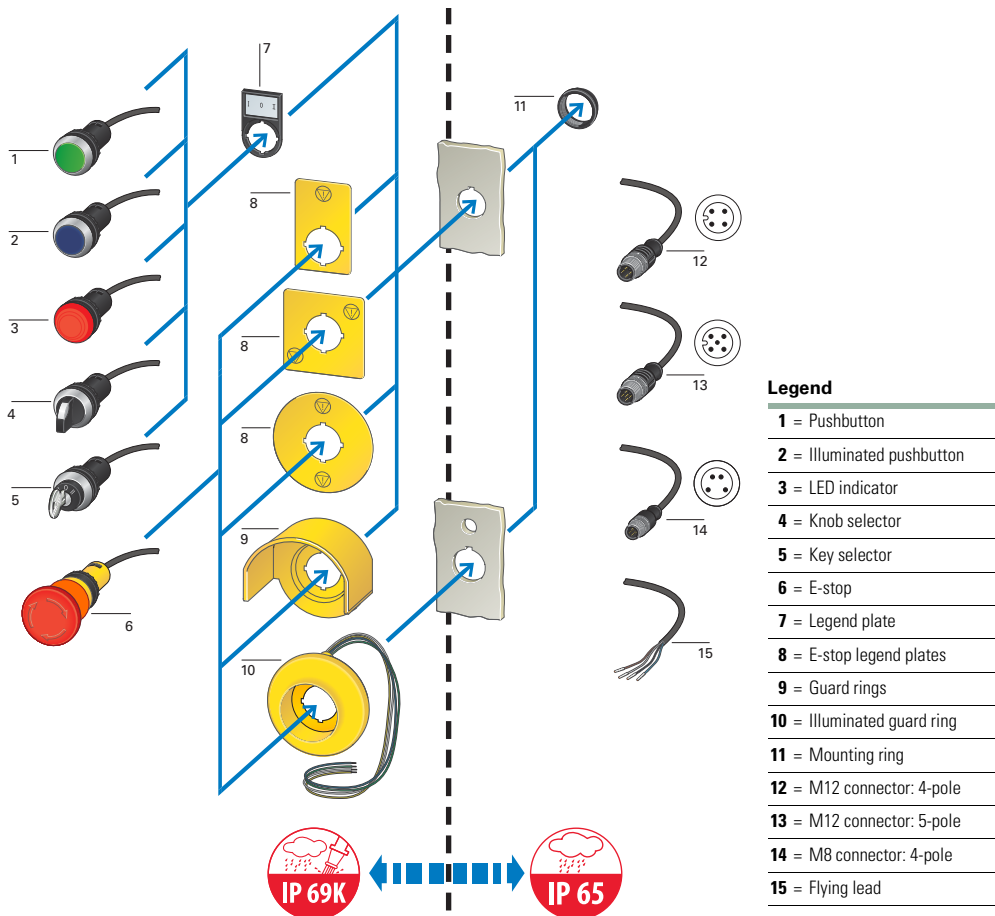

#### Legend

- |    |                          |
|----|--------------------------|
| 1  | = Pushbutton             |
| 2  | = Illuminated pushbutton |
| 3  | = LED indicator          |
| 4  | = Knob selector          |
| 5  | = Key selector           |
| 6  | = E-stop                 |
| 7  | = Legend plate           |
| 8  | = E-stop legend plates   |
| 9  | = Guard rings            |
| 10 | = Illuminated guard ring |
| 11 | = Mounting ring          |
| 12 | = M12 connector: 4-pole  |
| 13 | = M12 connector: 5-pole  |
| 14 | = M8 connector: 4-pole   |
| 15 | = Flying lead            |

**Product Selection Guide**

**Pushbuttons**



<b>Description</b>	Non-illuminated, flush		Non-illuminated, flush, pigtail (M8/M12/flying lead)		Illuminated, flush		Illuminated, flush, pigtail (M8/M12/flying lead)	
<b>Operator</b>	Momentary	Maintained	Momentary	Maintained	Momentary	Maintained	Momentary	Maintained
<b>Product Selection</b>	<a href="#">Page V7-T1-141</a>	<a href="#">Page V7-T1-143</a>	<a href="#">Page V7-T1-142</a>	<a href="#">Page V7-T1-144</a>	<a href="#">Page V7-T1-147</a>	<a href="#">Page V7-T1-149</a>	<a href="#">Page V7-T1-148</a>	<a href="#">Page V7-T1-150</a>

**Extended Pushbuttons**



<b>Description</b>	Non-illuminated, extended		Illuminated, extended	
<b>Operator</b>	Momentary	Maintained	Momentary	Maintained
<b>Product Selection</b>	<a href="#">Page V7-T1-145</a>	<a href="#">Page V7-T1-146</a>	<a href="#">Page V7-T1-151</a>	<a href="#">Page V7-T1-152</a>

**Indicating Lights**



<b>Description</b>	Indicating lights	Indicating lights with pigtail (M8/M12/flying lead)
<b>Product Selection</b>	<a href="#">Page V7-T1-154</a>	<a href="#">Page V7-T1-155</a>

**Emergency Stops**



<b>Description</b>	Twist release	Keyed-release	Twist release with or without indicator and flying lead/M12	Push-Pull with Pigtail (flying lead/M12)
<b>Product Selection</b>	<a href="#">Page V7-T1-157</a>	<a href="#">Page V7-T1-157</a>	<a href="#">Page V7-T1-158</a>	<a href="#">Page V7-T1-158</a>

**Selector Switches**



<b>Description</b>	Non-illuminated, knob type	Key-operated	Non-illuminated, knob type, with pigtail	Key-operated with pigtail
<b>Product Selection</b>	<a href="#">Page V7-T1-160</a>	<a href="#">Page V7-T1-162</a>	<a href="#">Page V7-T1-161</a>	<a href="#">Page V7-T1-164</a>



**Pushbuttons—Non-Illuminated and Illuminated**



**Contents**

<i>Description</i>	<i>Page</i>
Pushbuttons—Non-Illuminated and Illuminated	
Non-Illuminated Pushbuttons, Flush, Momentary	<b>V7-T1-141</b>
Non-Illuminated Pushbuttons, Flush, Momentary, with Pigtail	<b>V7-T1-142</b>
Non-Illuminated Pushbuttons, Flush, Maintained	<b>V7-T1-143</b>
Non-Illuminated Pushbuttons, Flush, Maintained, with Pigtail	<b>V7-T1-144</b>
Non-Illuminated Pushbuttons, Extended, Momentary	<b>V7-T1-145</b>
Non-Illuminated Pushbuttons, Extended, Maintained	<b>V7-T1-146</b>
Illuminated, Flush, Momentary	<b>V7-T1-147</b>
Illuminated Pushbuttons, Flush, Momentary, with Pigtail	<b>V7-T1-148</b>
Illuminated Pushbuttons, Flush, Maintained	<b>V7-T1-149</b>
Illuminated Pushbuttons, Flush, Maintained, with Pigtail	<b>V7-T1-150</b>
Illuminated Pushbuttons, Extended, Momentary	<b>V7-T1-151</b>
Illuminated Pushbuttons, Extended, Maintained	<b>V7-T1-152</b>
Indicating Lights	<b>V7-T1-153</b>
Emergency Stops	<b>V7-T1-156</b>
Selector Switches	<b>V7-T1-159</b>
Technical Data and Specifications	<b>V7-T1-166</b>
Dimensions	<b>V7-T1-168</b>

**Pushbuttons—Non-Illuminated and Illuminated**

**Product Description**

Eaton’s C22 Compact Pushbuttons are a complete line of monoblock type pushbuttons with the contact blocks, mounting adapter, and operator all-in-one. The C22 pushbuttons offer the same look and feel as their modular counterpart, the M22. They also carry many of the same rugged ratings and options, such as laser etching, field convertibility, and LED technology. They also feature IP65 rear ratings when purchased with pigtail, M8/M12/flying lead.

**Note:** For additional accessories, please see **Pages V7-T1-111 to V7-T1-117**, 22.5 mm Modular Pushbuttons—M22 Accessories.

**Features**

- Field convertible maintained pushbuttons from maintained to momentary
- LED offering only for improved brightness quality and up to 100,000 hours of operation
- Laser engraved pushbuttons and lenses
- Pushbuttons (momentary) rated for 5 million mechanical operations
- Pigtail option allows direct machine mounting

**Protection Type**

- IP67/IP69K
- NEMA 4X, 13
- IP65 rear (pigtail devices)

**Catalog Number Selection**

Catalog Number Selection is for illustrative purposes only and not to be used to create new catalog numbers.

**Non-Illuminated Pushbuttons**

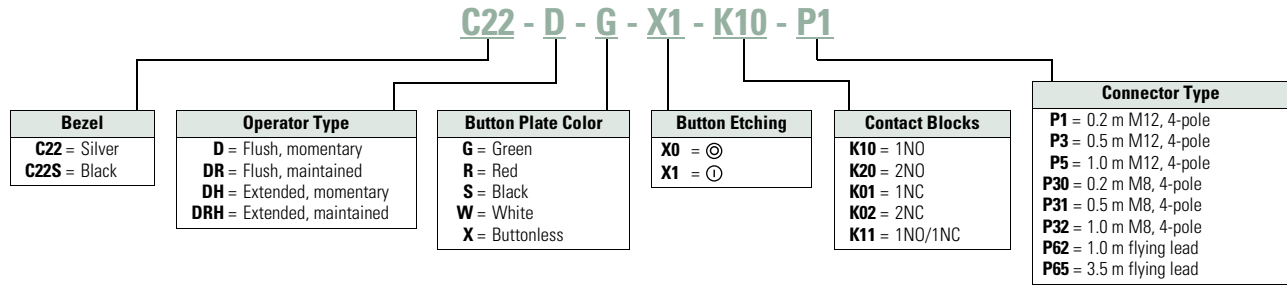

**Product Selection**

**Non-Illuminated Pushbuttons, Flush, Momentary**

C22(S)-D-\_\_



**Non-Illuminated Pushbuttons, Flush, Momentary**

Button Color	Button Etching	Contact Block Configuration	Silver Bezel Catalog Number	Black Bezel Catalog Number	
Green	—	1NO	C22-D-G-K10	C22S-D-G-K10	
	—	2NO	C22-D-G-K20	C22S-D-G-K20	
	—	1NO/1NC	C22-D-G-K11	C22S-D-G-K11	
	X1	1NO	C22-D-G-X1-K10	C22S-D-G-X1-K10	
	X1	2NO	C22-D-G-X1-K20	C22S-D-G-X1-K20	
	X1	1NO/1NC	C22-D-G-X1-K11	C22S-D-G-X1-K11	
	Red	—	1NC	C22-D-R-K01	C22S-D-R-K01
		—	2NC	C22-D-R-K02	C22S-D-R-K02
		—	1NO/1NC	C22-D-R-K11	C22S-D-R-K11
X0		1NC	C22-D-R-X0-K01	C22S-D-R-X0-K01	
X0		2NC	C22-D-R-X0-K02	C22S-D-R-X0-K02	
X0		1NO/1NC	C22-D-R-X0-K11	C22S-D-R-X0-K11	
Black	—	1NC	C22-D-S-K01	C22S-D-S-K01	
	—	2NC	C22-D-S-K02	C22S-D-S-K02	
	—	1NO/1NC	C22-D-S-K11	C22S-D-S-K11	
	X0	1NC	C22-D-S-X0-K01	C22S-D-S-X0-K01	
	X0	2NC	C22-D-S-X0-K02	C22S-D-S-X0-K02	
	X0	1NO/1NC	C22-D-S-X0-K11	C22S-D-S-X0-K11	
White	—	1NO	C22-D-W-K10	C22S-D-W-K10	
	—	2NO	C22-D-W-K20	C22S-D-W-K20	
	—	1NO/1NC	C22-D-W-K11	C22S-D-W-K11	
	X1	1NO	C22-D-W-X1-K10	C22S-D-W-X1-K10	
	X1	2NO	C22-D-W-X1-K20	C22S-D-W-X1-K20	
	X1	1NO/1NC	C22-D-W-X1-K11	C22S-D-W-X1-K11	
Buttonless	—	1NO	C22-D-X-K10	C22S-D-X-K10	
	—	2NO	C22-D-X-K20	C22S-D-X-K20	
	—	1NC	C22-D-X-K01	C22S-D-X-K01	
	—	2NC	C22-D-X-K02	C22S-D-X-K02	
	—	1NO/1NC	C22-D-X-K11	C22S-D-X-K11	

# 1.6

## Pushbuttons and Indicating Lights

### 22.5 mm RMQ Compact Pushbuttons—C22

#### 1 Non-Illuminated Pushbuttons, Flush, Momentary, with Pigtail

C22-D-    



#### Non-Illuminated Pushbuttons, Flush, Momentary, with Pigtail

Button Color	Contacts	Connector Length	Connector Type	Silver Bezel Catalog Number
Green	1NO	0.2	M8	C22-D-G-K10-P30
	1NO	0.2	M12	C22-D-G-K10-P1
	1NO	0.5	M8	C22-D-G-K10-P31
	1NO	0.5	M12	C22-D-G-K10-P3
	1NO	1	M8	C22-D-G-K10-P32
	1NO	1	M12	C22-D-G-K10-P5
	1NO	1	Flying lead	C22-D-G-K10-P62
	1NO	3.5	Flying lead	C22-D-G-K10-P65
Red	1NC	0.2	M8	C22-D-R-K01-P30
	1NC	0.2	M12	C22-D-R-K01-P1
	1NC	0.5	M8	C22-D-R-K01-P31
	1NC	0.5	M12	C22-D-R-K01-P3
	1NC	1	M8	C22-D-R-K01-P32
	1NC	1	M12	C22-D-R-K01-P5
	1NC	1	Flying lead	C22-D-R-K01-P62
	1NC	3.5	Flying lead	C22-D-R-K01-P65
Black	1NC	0.2	M8	C22-D-S-K01-P30
	1NC	0.2	M12	C22-D-S-K01-P1
	1NC	0.5	M8	C22-D-S-K01-P31
	1NC	0.5	M12	C22-D-S-K01-P3
	1NC	1	M8	C22-D-S-K01-P32
	1NC	1	M12	C22-D-S-K01-P5
	1NC	1	Flying lead	C22-D-S-K01-P62
	1NC	3.5	Flying lead	C22-D-S-K01-P65
White	1NO	0.2	M8	C22-D-W-K10-P30
	1NO	0.2	M12	C22-D-W-K10-P1
	1NO	0.5	M8	C22-D-W-K10-P31
	1NO	0.5	M12	C22-D-W-K10-P3
	1NO	1	M8	C22-D-W-K10-P32
	1NO	1	M12	C22-D-W-K10-P5
	1NO	1	Flying lead	C22-D-W-K10-P62
	1NO	3.5	Flying lead	C22-D-W-K10-P65
Buttonless	1NO	0.2	M8	C22-D-X-K10-P30
	1NO	0.2	M12	C22-D-X-K10-P1
	1NO	0.5	M8	C22-D-X-K10-P31
	1NO	0.5	M12	C22-D-X-K10-P3
	1NO	1	M8	C22-D-X-K10-P32
	1NO	1	M12	C22-D-X-K10-P5
	1NO	1	Flying lead	C22-D-X-K10-P62
	1NO	3.5	Flying lead	C22-D-X-K10-P65
	2NO	1	Flying lead	C22-D-X-K20-P62
	2NO	3.5	Flying lead	C22-D-X-K20-P65
	1NC/1NO	1	Flying lead	C22-D-X-K11-P62
	1NC/1NO	3.5	Flying lead	C22-D-X-K11-P65
	1NC	0.2	M8	C22-D-X-K01-P30
	1NC	0.2	M12	C22-D-X-K01-P1
	1NC	0.5	M8	C22-D-X-K01-P31
	1NC	0.5	M12	C22-D-X-K01-P3
	1NC	1	M8	C22-D-X-K01-P32
	1NC	1	M12	C22-D-X-K01-P5
	1NC	1	Flying lead	C22-D-X-K01-P62
	1NC	3.5	Flying lead	C22-D-X-K01-P65
	2NC	1	Flying lead	C22-D-X-K02-P62
	2NC	3.5	Flying lead	C22-D-X-K02-P65

### Non-Illuminated Pushbuttons, Flush, Maintained

C22(S)-DR-



### Non-Illuminated Pushbuttons, Flush, Maintained

Button Color	Button Etching	Contact Block Configuration	Silver Bezel Catalog Number	Black Bezel Catalog Number
Green	—	1NO	C22-DR-G-K10	C22S-DR-G-K10
	—	2NO	C22-DR-G-K20	C22S-DR-G-K20
	—	1NO/1NC	C22-DR-G-K11	C22S-DR-G-K11
	X1	1NO	C22-DR-G-X1-K10	C22S-DR-G-X1-K10
	X1	2NO	C22-DR-G-X1-K20	C22S-DR-G-X1-K20
	X1	1NO/1NC	C22-DR-G-X1-K11	C22S-DR-G-X1-K11
Red	—	1NC	C22-DR-R-K01	C22S-DR-R-K01
	—	2NC	C22-DR-R-K02	C22S-DR-R-K02
	—	1NO/1NC	C22-DR-R-K11	C22S-DR-R-K11
	X0	1NC	C22-DR-R-X0-K01	C22S-DR-R-X0-K01
	X0	2NC	C22-DR-R-X0-K02	C22S-DR-R-X0-K02
	X0	1NO/1NC	C22-DR-R-X0-K11	C22S-DR-R-X0-K11
Black	—	1NC	C22-DR-S-K01	C22S-DR-S-K01
	—	2NC	C22-DR-S-K02	C22S-DR-S-K02
	—	1NO/1NC	C22-DR-S-K11	C22S-DR-S-K11
	X0	1NC	C22-DR-S-X0-K01	C22S-DR-S-X0-K01
	X0	2NC	C22-DR-S-X0-K02	C22S-DR-S-X0-K02
	X0	1NO/1NC	C22-DR-S-X0-K11	C22S-DR-S-X0-K11
White	—	1NO	C22-DR-W-K10	C22S-DR-W-K10
	—	2NO	C22-DR-W-K20	C22S-DR-W-K20
	—	1NO/1NC	C22-DR-W-K11	C22S-DR-W-K11
	X1	1NO	C22-DR-W-X1-K10	C22S-DR-W-X1-K10
	X1	2NO	C22-DR-W-X1-K20	C22S-DR-W-X1-K20
	X1	1NO/1NC	C22-DR-W-X1-K11	C22S-DR-W-X1-K11
Buttonless	—	1NO	C22-DR-X-K10	C22S-DR-X-K10
	—	2NO	C22-DR-X-K20	C22S-DR-X-K20
	—	1NC	C22-DR-X-K01	C22S-DR-X-K01
	—	2NC	C22-DR-X-K02	C22S-DR-X-K02
	—	1NO/1NC	C22-DR-X-K11	C22S-DR-X-K11

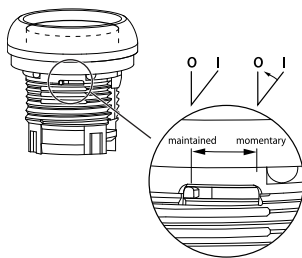

**Note:** Maintained pushbuttons can be converted in the field to momentary operation by switching the locking ring, which is accessible through the side of the operator body.

# 1.6

## Pushbuttons and Indicating Lights

### 22.5 mm RMQ Compact Pushbuttons—C22

#### 1 Non-Illuminated Pushbuttons, Flush, Maintained, with Pigtail

C22-DR-\_\_



#### Non-Illuminated Pushbuttons, Flush, Maintained, with Pigtail

Button Color	Contacts	Connector Length	Connector Type	Silver Bezel Catalog Number
Green	1NO	0.2	M8	C22-DR-G-K10-P30
	1NO	0.2	M12	C22-DR-G-K10-P1
	1NO	0.5	M8	C22-DR-G-K10-P31
	1NO	0.5	M12	C22-DR-G-K10-P3
	1NO	1	M8	C22-DR-G-K10-P32
	1NO	1	M12	C22-DR-G-K10-P5
	1NO	1	Flying lead	C22-DR-G-K10-P62
	1NO	3.5	Flying lead	C22-DR-G-K10-P65
Red	1NC	0.2	M8	C22-DR-R-K01-P30
	1NC	0.2	M12	C22-DR-R-K01-P1
	1NC	0.5	M8	C22-DR-R-K01-P31
	1NC	0.5	M12	C22-DR-R-K01-P3
	1NC	1	M8	C22-DR-R-K01-P32
	1NC	1	M12	C22-DR-R-K01-P5
	1NC	1	Flying lead	C22-DR-R-K01-P62
	1NC	3.5	Flying lead	C22-DR-R-K01-P65
Black	1NC	0.2	M8	C22-DR-S-K01-P30
	1NC	0.2	M12	C22-DR-S-K01-P1
	1NC	0.5	M8	C22-DR-S-K01-P31
	1NC	0.5	M12	C22-DR-S-K01-P3
	1NC	1	M8	C22-DR-S-K01-P32
	1NC	1	M12	C22-DR-S-K01-P5
	1NC	1	Flying lead	C22-DR-S-K01-P62
	1NC	3.5	Flying lead	C22-DR-S-K01-P65
White	1NO	0.2	M8	C22-DR-W-K10-P30
	1NO	0.2	M12	C22-DR-W-K10-P1
	1NO	0.5	M8	C22-DR-W-K10-P31
	1NO	0.5	M12	C22-DR-W-K10-P3
	1NO	1	M8	C22-DR-W-K10-P32
	1NO	1	M12	C22-DR-W-K10-P5
	1NO	1	Flying lead	C22-DR-W-K10-P62
	1NO	3.5	Flying lead	C22-DR-W-K10-P65
Buttonless	1NO	0.2	M8	C22-DR-X-K10-P30
	1NO	0.2	M12	C22-DR-X-K10-P1
	1NO	0.5	M8	C22-DR-X-K10-P31
	1NO	0.5	M12	C22-DR-X-K10-P3
	1NO	1	M8	C22-DR-X-K10-P32
	1NO	1	M12	C22-DR-X-K10-P5
	1NO	1	Flying lead	C22-DR-X-K10-P62
	1NO	3.5	Flying lead	C22-DR-X-K10-P65
	2NO	1	Flying lead	C22-DR-X-K20-P62
	2NO	3.5	Flying lead	C22-DR-X-K20-P65
	1NC/1NO	1	Flying lead	C22-DR-X-K11-P62
	1NC/1NO	3.5	Flying lead	C22-DR-X-K11-P65
	1NC	0.2	M8	C22-DR-X-K01-P30
	1NC	0.2	M12	C22-DR-X-K01-P1
	1NC	0.5	M8	C22-DR-X-K01-P31
	1NC	0.5	M12	C22-DR-X-K01-P3
	1NC	1	M8	C22-DR-X-K01-P32
	1NC	1	M12	C22-DR-X-K01-P5
	1NC	1	Flying lead	C22-DR-X-K01-P62
	1NC	3.5	Flying lead	C22-DR-X-K01-P65
	2NC	1	Flying lead	C22-DR-X-K02-P62
	2NC	3.5	Flying lead	C22-DR-X-K02-P65

**Non-Illuminated Pushbuttons, Extended, Momentary**

C22(S)-DH-



**Non-Illuminated Pushbuttons, Extended, Momentary**

Button Color	Button Etching	Contact Block Configuration	Silver Bezel Catalog Number	Black Bezel Catalog Number
Green	—	1NO	C22-DH-G-K10	C22S-DH-G-K10
	—	2NO	C22-DH-G-K20	C22S-DH-G-K20
	—	1NO/1NC	C22-DH-G-K11	C22S-DH-G-K11
	X1	1NO	C22-DH-G-X1-K10	C22S-DH-G-X1-K10
	X1	2NO	C22-DH-G-X1-K20	C22S-DH-G-X1-K20
	X1	1NO/1NC	C22-DH-G-X1-K11	C22S-DH-G-X1-K11
Red	—	1NC	C22-DH-R-K01	C22S-DH-R-K01
	—	2NC	C22-DH-R-K02	C22S-DH-R-K02
	—	1NO/1NC	C22-DH-R-K11	C22S-DH-R-K11
	X0	1NC	C22-DH-R-X0-K01	C22S-DH-R-X0-K01
	X0	2NC	C22-DH-R-X0-K02	C22S-DH-R-X0-K02
	X0	1NO/1NC	C22-DH-R-X0-K11	C22S-DH-R-X0-K11
Black	—	1NC	C22-DH-S-K01	C22S-DH-S-K01
	—	2NC	C22-DH-S-K02	C22S-DH-S-K02
	—	1NO/1NC	C22-DH-S-K11	C22S-DH-S-K11
	X0	1NC	C22-DH-S-X0-K01	C22S-DH-S-X0-K01
	X0	2NC	C22-DH-S-X0-K02	C22S-DH-S-X0-K02
	X0	1NO/1NC	C22-DH-S-X0-K11	C22S-DH-S-X0-K11
White	—	1NO	C22-DH-W-K10	C22S-DH-W-K10
	—	2NO	C22-DH-W-K20	C22S-DH-W-K20
	—	1NO/1NC	C22-DH-W-K11	C22S-DH-W-K11
	X1	1NO	C22-DH-W-X1-K10	C22S-DH-W-X1-K10
	X1	2NO	C22-DH-W-X1-K20	C22S-DH-W-X1-K20
	X1	1NO/1NC	C22-DH-W-X1-K11	C22S-DH-W-X1-K11

# 1.6

## Pushbuttons and Indicating Lights

### 22.5 mm RMQ Compact Pushbuttons—C22

#### 1 Non-Illuminated Pushbuttons, Extended, Maintained

C22(S)-DRH\_



#### Non-Illuminated Pushbuttons, Extended, Maintained

Button Color	Button Etching	Contact Block Configuration	Silver Bezel Catalog Number	Black Bezel Catalog Number
Green	—	1NO	C22-DRH-G-K10	C22S-DRH-G-K10
	—	2NO	C22-DRH-G-K20	C22S-DRH-G-K20
	—	1NO/1NC	C22-DRH-G-K11	C22S-DRH-G-K11
	X1	1NO	C22-DRH-G-X1-K10	C22S-DRH-G-X1-K10
	X1	2NO	C22-DRH-G-X1-K20	C22S-DRH-G-X1-K20
	X1	1NO/1NC	C22-DRH-G-X1-K11	C22S-DRH-G-X1-K11
Red	—	1NC	C22-DRH-R-K01	C22S-DRH-R-K01
	—	2NC	C22-DRH-R-K02	C22S-DRH-R-K02
	—	1NO/1NC	C22-DRH-R-K11	C22S-DRH-R-K11
	X0	1NC	C22-DRH-R-X0-K01	C22S-DRH-R-X0-K01
	X0	2NC	C22-DRH-R-X0-K02	C22S-DRH-R-X0-K02
	X0	1NO/1NC	C22-DRH-R-X0-K11	C22S-DRH-R-X0-K11
Black	—	1NC	C22-DRH-S-K01	C22S-DRH-S-K01
	—	2NC	C22-DRH-S-K02	C22S-DRH-S-K02
	—	1NO/1NC	C22-DRH-S-K11	C22S-DRH-S-K11
	X0	1NC	C22-DRH-S-X0-K01	C22S-DRH-S-X0-K01
	X0	2NC	C22-DRH-S-X0-K02	C22S-DRH-S-X0-K02
	X0	1NO/1NC	C22-DRH-S-X0-K11	C22S-DRH-S-X0-K11
White	—	1NO	C22-DRH-W-K10	C22S-DRH-W-K10
	—	2NO	C22-DRH-W-K20	C22S-DRH-W-K20
	—	1NO/1NC	C22-DRH-W-K11	C22S-DRH-W-K11
	X1	1NO	C22-DRH-W-X1-K10	C22S-DRH-W-X1-K10
	X1	2NO	C22-DRH-W-X1-K20	C22S-DRH-W-X1-K20
	X1	1NO/1NC	C22-DRH-W-X1-K11	C22S-DRH-W-X1-K11

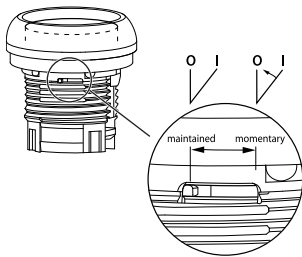

**Note:** Maintained pushbuttons can be converted in the field to momentary operation by switching the locking ring, which is accessible through the side of the operator body.

**Catalog Number Selection**

Catalog Number Selection is for illustrative purposes only and not to be used to create new catalog numbers.

**Illuminated Pushbuttons**

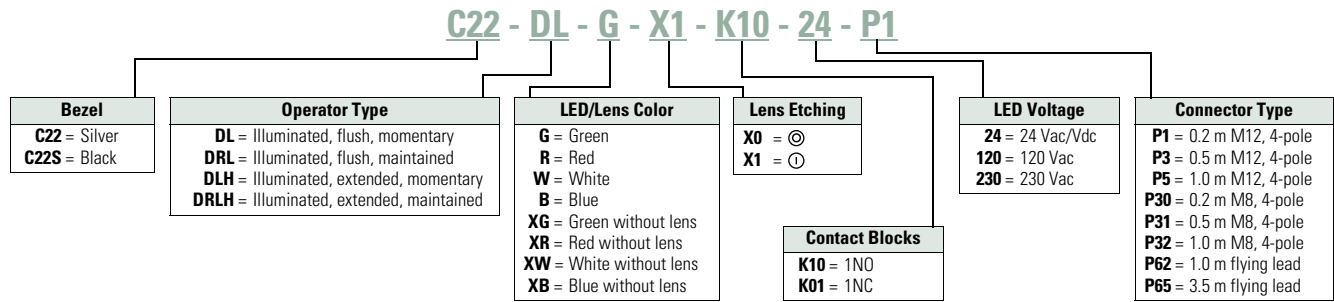

**Product Selection**

**Illuminated, Flush, Momentary**

**C22(S)-DL-\_  
Illuminated Pushbuttons, Flush, Momentary**



LED Color	Button Color	Voltage	Button Etching	Contact Block Configuration	Silver Bezel Catalog Number	Black Bezel Catalog Number
Green	Green	24 Vac/Vdc	—	1NO	C22-DL-G-K10-24	C22S-DL-G-K10-24
		120 Vac	—	1NO	C22-DL-G-K10-120	C22S-DL-G-K10-120
		230 Vac	—	1NO	C22-DL-G-K10-230	C22S-DL-G-K10-230
		24 Vac/Vdc	X1	1NO	C22-DL-G-X1-K10-24	C22S-DL-G-X1-K10-24
		120 Vac	X1	1NO	C22-DL-G-X1-K10-120	C22S-DL-G-X1-K10-120
		230 Vac	X1	1NO	C22-DL-G-X1-K10-230	C22S-DL-G-X1-K10-230
	Buttonless	24 Vac/Vdc	—	1NO	C22-DL-XG-K10-24	C22S-DL-XG-K10-24
		120 Vac	—	1NO	C22-DL-XG-K10-120	C22S-DL-XG-K10-120
		230 Vac	—	1NO	C22-DL-XG-K10-230	C22S-DL-XG-K10-230
		24 Vac/Vdc	X0	1NC	C22-DL-R-X0-K01-24	C22S-DL-R-K01-24
		120 Vac	X0	1NC	C22-DL-R-X0-K01-120	C22S-DL-R-K01-120
		230 Vac	X0	1NC	C22-DL-R-X0-K01-230	C22S-DL-R-K01-230
Red	Red	24 Vac/Vdc	—	1NC	C22-DL-R-K01-24	C22S-DL-R-K01-24
		120 Vac	—	1NC	C22-DL-R-K01-120	C22S-DL-R-K01-120
		230 Vac	—	1NC	C22-DL-R-K01-230	C22S-DL-R-K01-230
		24 Vac/Vdc	X0	1NC	C22-DL-R-X0-K01-24	C22S-DL-R-X0-K01-24
		120 Vac	X0	1NC	C22-DL-R-X0-K01-120	C22S-DL-R-X0-K01-120
		230 Vac	X0	1NC	C22-DL-R-X0-K01-230	C22S-DL-R-X0-K01-230
	Buttonless	24 Vac/Vdc	—	1NC	C22-DL-XR-K01-24	C22S-DL-XR-K01-24
		120 Vac	—	1NC	C22-DL-XR-K01-120	C22S-DL-XR-K01-120
		230 Vac	—	1NC	C22-DL-XR-K01-230	C22S-DL-XR-K01-230
		24 Vac/Vdc	X1	1NO	C22-DL-W-X1-K10-24	C22S-DL-W-X1-K10-24
		120 Vac	X1	1NO	C22-DL-W-X1-K10-120	C22S-DL-W-X1-K10-120
		230 Vac	X1	1NO	C22-DL-W-X1-K10-230	C22S-DL-W-X1-K10-230
White	White	24 Vac/Vdc	—	1NO	C22-DL-W-K10-24	C22S-DL-W-K10-24
		120 Vac	—	1NO	C22-DL-W-K10-120	C22S-DL-W-K10-120
		230 Vac	—	1NO	C22-DL-W-K10-230	C22S-DL-W-K10-230
		24 Vac/Vdc	X1	1NO	C22-DL-W-X1-K10-24	C22S-DL-W-X1-K10-24
		120 Vac	X1	1NO	C22-DL-W-X1-K10-120	C22S-DL-W-X1-K10-120
		230 Vac	X1	1NO	C22-DL-W-X1-K10-230	C22S-DL-W-X1-K10-230
	Buttonless	24 Vac/Vdc	—	1NO	C22-DL-XW-K10-24	C22S-DL-XW-K10-24
		120 Vac	—	1NO	C22-DL-XW-K10-120	C22S-DL-XW-K10-120
		230 Vac	—	1NO	C22-DL-XW-K10-230	C22S-DL-XW-K10-230
		24 Vac/Vdc	—	1NO	C22-DL-B-K10-24	C22S-DL-B-K10-24
		120 Vac	—	1NO	C22-DL-B-K10-120	C22S-DL-B-K10-120
		230 Vac	—	1NO	C22-DL-B-K10-230	C22S-DL-B-K10-230
Blue	Blue	24 Vac/Vdc	—	1NO	C22-DL-B-K10-24	C22S-DL-B-K10-24
		120 Vac	—	1NO	C22-DL-B-K10-120	C22S-DL-B-K10-120
		230 Vac	—	1NO	C22-DL-B-K10-230	C22S-DL-B-K10-230
		24 Vac/Vdc	—	1NO	C22-DL-XB-K10-24	C22S-DL-XB-K10-24
		120 Vac	—	1NO	C22-DL-XB-K10-120	C22S-DL-XB-K10-120
		230 Vac	—	1NO	C22-DL-XB-K10-230	C22S-DL-XB-K10-230



# 1.6

## Pushbuttons and Indicating Lights

### 22.5 mm RMQ Compact Pushbuttons—C22

#### 1 Illuminated Pushbuttons, Flush, Momentary, with Pigtail

C22-DL-\_\_



#### Illuminated Pushbuttons, Flush, Momentary, with Pigtail

Button Color	Contacts	Connector Length	Connector Type	Silver Bezel Catalog Number
Green	1NO	0.2	M8	C22-DL-G-K10-24-P30
	1NO	0.2	M12	C22-DL-G-K10-24-P1
	1NO	0.5	M8	C22-DL-G-K10-24-P31
	1NO	0.5	M12	C22-DL-G-K10-24-P3
	1NO	1	M8	C22-DL-G-K10-24-P32
	1NO	1	M12	C22-DL-G-K10-24-P5
	1NO	1	Flying lead	C22-DL-G-K10-24-P62
	1NO	3.5	Flying lead	C22-DL-G-K10-24-P65
Red	1NC	0.2	M8	C22-DL-R-K01-24-P30
	1NC	0.2	M12	C22-DL-R-K01-24-P1
	1NC	0.5	M8	C22-DL-R-K01-24-P31
	1NC	0.5	M12	C22-DL-R-K01-24-P3
	1NC	1	M8	C22-DL-R-K01-24-P32
	1NC	1	M12	C22-DL-R-K01-24-P5
	1NC	1	Flying lead	C22-DL-R-K01-24-P62
	1NC	3.5	Flying lead	C22-DL-R-K01-24-P65
Blue	1NO	0.2	M8	C22-DL-B-K10-24-P30
	1NO	0.2	M12	C22-DL-B-K10-24-P1
	1NO	0.5	M8	C22-DL-B-K10-24-P31
	1NO	0.5	M12	C22-DL-B-K10-24-P3
	1NO	1	M8	C22-DL-B-K10-24-P32
	1NO	1	M12	C22-DL-B-K10-24-P5
	1NO	1	Flying lead	C22-DL-B-K10-24-P62
	1NO	3.5	Flying lead	C22-DL-B-K10-24-P65
White	1NO	0.2	M8	C22-DL-W-K10-24-P30
	1NO	0.2	M12	C22-DL-W-K10-24-P1
	1NO	0.5	M8	C22-DL-W-K10-24-P31
	1NO	0.5	M12	C22-DL-W-K10-24-P3
	1NO	1	M8	C22-DL-W-K10-24-P32
	1NO	1	M12	C22-DL-W-K10-24-P5
	1NO	1	Flying lead	C22-DL-W-K10-24-P62
	1NO	3.5	Flying lead	C22-DL-W-K10-24-P65

**Illuminated Pushbuttons, Flush, Maintained**

C22(S)-DRL\_

**Illuminated Pushbuttons, Flush, Maintained**



LED Color	Button Color	Voltage	Contact Block Configuration	Silver Bezel Catalog Number	Black Bezel Catalog Number		
Green	Green	24 Vac/Vdc	1NO	C22-DRL-G-K10-24	C22S-DRL-G-K10-24		
		120 Vac	1NO	C22-DRL-G-K10-120	C22S-DRL-G-K10-120		
		230 Vac	1NO	C22-DRL-G-K10-230	C22S-DRL-G-K10-230		
	Buttonless	24 Vac/Vdc	1NO	C22-DRL-XG-K10-24	C22S-DRL-XG-K10-24		
			120 Vac	1NO	C22-DRL-XG-K10-120	C22S-DRL-XG-K10-120	
			230 Vac	1NO	C22-DRL-XG-K10-230	C22S-DRL-XG-K10-230	
		Red	24 Vac/Vdc	1NC	C22-DRL-R-K01-24	C22S-DRL-R-K01-24	
				120 Vac	1NC	C22-DRL-R-K01-120	C22S-DRL-R-K01-120
				230 Vac	1NC	C22-DRL-R-K01-230	C22S-DRL-R-K01-230
Buttonless	24 Vac/Vdc	1NC	C22-DRL-XR-K01-24	C22S-DRL-XR-K01-24			
		120 Vac	1NC	C22-DRL-XR-K01-120	C22S-DRL-XR-K01-120		
		230 Vac	1NC	C22-DRL-XR-K01-230	C22S-DRL-XR-K01-230		
	White	White	24 Vac/Vdc	1NO	C22-DRL-W-K10-24	C22S-DRL-W-K10-24	
			120 Vac	1NO	C22-DRL-W-K10-120	C22S-DRL-W-K10-120	
			230 Vac	1NO	C22-DRL-W-K10-230	C22S-DRL-W-K10-230	
Buttonless		24 Vac/Vdc	1NO	C22-DRL-XW-K10-24	C22S-DRL-XW-K10-24		
			120 Vac	1NO	C22-DRL-XW-K10-120	C22S-DRL-XW-K10-120	
			230 Vac	1NO	C22-DRL-XW-K10-230	C22S-DRL-XW-K10-230	
		Blue	Blue	24 Vac/Vdc	1NO	C22-DRL-B-K10-24	C22S-DRL-B-K10-24
				120 Vac	1NO	C22-DRL-B-K10-120	C22S-DRL-B-K10-120
				230 Vac	1NO	C22-DRL-B-K10-230	C22S-DRL-B-K10-230
Buttonless	24 Vac/Vdc		1NO	C22-DRL-XB-K10-24	C22S-DRL-XB-K10-24		
			120 Vac	1NO	C22-DRL-XB-K10-120	C22S-DRL-XB-K10-120	
			230 Vac	1NO	C22-DRL-XB-K10-230	C22S-DRL-XB-K10-230	

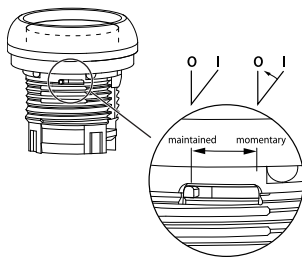

**Note:** Maintained pushbuttons can be converted in the field to momentary operation by switching the locking ring, which is accessible through the side of the operator body.

# 1.6

## Pushbuttons and Indicating Lights

### 22.5 mm RMQ Compact Pushbuttons—C22

#### 1 Illuminated Pushbuttons, Flush, Maintained, with Pigtail

C22\_DRL-G\_



#### Illuminated Pushbuttons, Flush, Maintained, with Pigtail

Button Color	Contacts	Connector Length	Connector Type	Silver Bezel Catalog Number
Green	1NO	0.2	M8	C22-DRL-G-K10-24-P30
	1NO	0.2	M12	C22-DRL-G-K10-24-P1
	1NO	0.5	M8	C22-DRL-G-K10-24-P31
	1NO	0.5	M12	C22-DRL-G-K10-24-P3
	1NO	1	M8	C22-DRL-G-K10-24-P32
	1NO	1	M12	C22-DRL-G-K10-24-P5
	1NO	1	Flying lead	C22-DRL-G-K10-24-P62
	1NO	3.5	Flying lead	C22-DRL-G-K10-24-P65
Red	1NC	0.2	M8	C22-DRL-R-K01-24-P30
	1NC	0.2	M12	C22-DRL-R-K01-24-P1
	1NC	0.5	M8	C22-DRL-R-K01-24-P31
	1NC	0.5	M12	C22-DRL-R-K01-24-P3
	1NC	1	M8	C22-DRL-R-K01-24-P32
	1NC	1	M12	C22-DRL-R-K01-24-P5
	1NC	1	Flying lead	C22-DRL-R-K01-24-P62
	1NC	3.5	Flying lead	C22-DRL-R-K01-24-P65
Blue	1NO	0.2	M8	C22-DRL-B-K10-24-P30
	1NO	0.2	M12	C22-DRL-B-K10-24-P1
	1NO	0.5	M8	C22-DRL-B-K10-24-P31
	1NO	0.5	M12	C22-DRL-B-K10-24-P3
	1NO	1	M8	C22-DRL-B-K10-24-P32
	1NO	1	M12	C22-DRL-B-K10-24-P5
	1NO	1	Flying lead	C22-DRL-B-K10-24-P62
	1NO	3.5	Flying lead	C22-DRL-B-K10-24-P65
White	1NO	0.2	M8	C22-DRL-W-K10-24-P30
	1NO	0.2	M12	C22-DRL-W-K10-24-P1
	1NO	0.5	M8	C22-DRL-W-K10-24-P31
	1NO	0.5	M12	C22-DRL-W-K10-24-P3
	1NO	1	M8	C22-DRL-W-K10-24-P32
	1NO	1	M12	C22-DRL-W-K10-24-P5
	1NO	1	Flying lead	C22-DRL-W-K10-24-P62
	1NO	3.5	Flying lead	C22-DRL-W-K10-24-P65

**Illuminated Pushbuttons, Extended, Momentary**

C22(S)-DLH\_

**Illuminated Pushbuttons, Extended, Momentary**



LED Color	Button Color	Voltage	Button Etching	Contact Block Configuration	Silver Bezel Catalog Number	Black Bezel Catalog Number
Green	Green	24 Vac/Vdc	—	1NO	C22-DLH-G-K10-24	C22S-DLH-G-K10-24
		120 Vac	—	1NO	C22-DLH-G-K10-120	C22S-DLH-G-K10-120
		230 Vac	—	1NO	C22-DLH-G-K10-230	C22S-DLH-G-K10-230
		24 Vac/Vdc	X1	1NO	C22-DLH-G-X1-K10-24	C22S-DLH-G-X1-K10-24
		120 Vac	X1	1NO	C22-DLH-G-X1-K10-120	C22S-DLH-G-X1-K10-12
		230 Vac	X1	1NO	C22-DLH-G-X1-K10-230	C22S-DLH-G-X1-K10-23
		24 Vac/Vdc	—	1NC	C22-DLH-R-K01-24	C22S-DLH-R-K01-24
		120 Vac	—	1NC	C22-DLH-R-K01-120	C22S-DLH-R-K01-120
		230 Vac	—	1NC	C22-DLH-R-K01-230	C22S-DLH-R-K01-230
Red	Red	24 Vac/Vdc	X0	1NC	C22-DLH-R-X0-K01-24	C22S-DLH-R-X0-K01-24
		120 Vac	X0	1NC	C22-DLH-R-X0-K01-120	C22S-DLH-R-X0-K01-12
		230 Vac	X0	1NC	C22-DLH-R-X0-K01-230	C22S-DLH-R-X0-K01-23
		24 Vac/Vdc	—	1NO	C22-DLH-W-K10-24	C22S-DLH-W-K10-24
		120 Vac	—	1NO	C22-DLH-W-K10-120	C22S-DLH-W-K10-120
		230 Vac	—	1NO	C22-DLH-W-K10-230	C22S-DLH-W-K10-230
White	White	24 Vac/Vdc	X1	1NO	C22-DLH-W-X1-K10-24	C22S-DLH-W-X1-K10-24
		120 Vac	X1	1NO	C22-DLH-W-X1-K10-120	C22S-DLH-W-X1-K10-12
		230 Vac	X1	1NO	C22-DLH-W-X1-K10-230	C22S-DLH-W-X1-K10-23
		24 Vac/Vdc	—	1NO	C22-DLH-B-K10-24	C22S-DLH-B-K10-24
		120 Vac	—	1NO	C22-DLH-B-K10-120	C22S-DLH-B-K10-120
		230 Vac	—	1NO	C22-DLH-B-K10-230	C22S-DLH-B-K10-230
Blue	Blue	24 Vac/Vdc	—	1NO	C22-DLH-B-K10-24	C22S-DLH-B-K10-24
		120 Vac	—	1NO	C22-DLH-B-K10-120	C22S-DLH-B-K10-120
		230 Vac	—	1NO	C22-DLH-B-K10-230	C22S-DLH-B-K10-230

#### Illuminated Pushbuttons, Extended, Maintained

C22(S)-DRLH-

#### Illuminated Pushbuttons, Flush Extended, Maintained



LED Color	Button Color	Voltage	Button Etching	Contact Block Configuration	Silver Bezel Catalog Number	Black Bezel Catalog Number
Green	Green	24 Vac/Vdc	—	1NO	C22-DRLH-G-K10-24	C22S-DRLH-G-K10-24
		120 Vac	—	1NO	C22-DRLH-G-K10-120	C22S-DRLH-G-K10-120
		230 Vac	—	1NO	C22-DRLH-G-K10-230	C22S-DRLH-G-K10-230
		24 Vac/Vdc	X1	1NO	C22-DRLH-G-X1-K10-24	C22S-DRLH-G-X1-K10-24
		120 Vac	X1	1NO	C22-DRLH-G-X1-K10-120	C22S-DRLH-G-X1-K10-120
		230 Vac	X1	1NO	C22-DRLH-G-X1-K10-230	C22S-DRLH-G-X1-K10-230
Red	Red	24 Vac/Vdc	—	1NC	C22-DRLH-R-K01-24	C22S-DRLH-R-K01-24
		120 Vac	—	1NC	C22-DRLH-R-K01-120	C22S-DRLH-R-K01-120
		230 Vac	—	1NC	C22-DRLH-R-K01-230	C22S-DRLH-R-K01-230
		24 Vac/Vdc	X0	1NC	C22-DRLH-R-X0-K01-24	C22S-DRLH-R-X0-K01-24
		120 Vac	X0	1NC	C22-DRLH-R-X0-K01-120	C22S-DRLH-R-X0-K01-120
		230 Vac	X0	1NC	C22-DRLH-R-X0-K01-230	C22S-DRLH-R-X0-K01-230
White	White	24 Vac/Vdc	—	1NO	C22-DRLH-W-K10-24	C22S-DRLH-W-K10-24
		120 Vac	—	1NO	C22-DRLH-W-K10-120	C22S-DRLH-W-K10-120
		230 Vac	—	1NO	C22-DRLH-W-K10-230	C22S-DRLH-W-K10-230
		24 Vac/Vdc	X1	1NO	C22-DRLH-W-X1-K10-24	C22S-DRLH-W-X1-K10-24
		120 Vac	X1	1NO	C22-DRLH-W-X1-K10-120	C22S-DRLH-W-X1-K10-120
		230 Vac	X1	1NO	C22-DRLH-W-X1-K10-230	C22S-DRLH-W-X1-K10-230
Blue	Blue	24 Vac/Vdc	—	1NO	C22-DRLH-B-K10-24	C22S-DRLH-B-K10-24
		120 Vac	—	1NO	C22-DRLH-B-K10-120	C22S-DRLH-B-K10-120
		230 Vac	—	1NO	C22-DRLH-B-K10-230	C22S-DRLH-B-K10-230

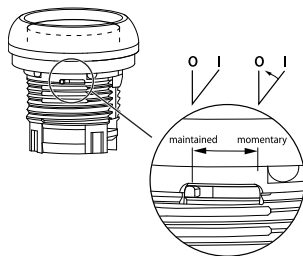

**Note:** Maintained pushbuttons can be converted in the field to momentary operation by switching the locking ring, which is accessible through the side of the operator body.

### Indicating Lights



### Contents

<i><b>Description</b></i>	<i><b>Page</b></i>
Pushbuttons—Non-Illuminated and Illuminated .....	<b>V7-T1-140</b>
Indicating Lights	
Catalog Number Selection .....	<b>V7-T1-154</b>
Product Selection .....	<b>V7-T1-154</b>
Emergency Stops .....	<b>V7-T1-156</b>
Selector Switches .....	<b>V7-T1-159</b>
Technical Data and Specifications .....	<b>V7-T1-166</b>
Dimensions .....	<b>V7-T1-168</b>

## Indicating Lights

### Product Description

C22 indicating lights use a combination of a durable, bright LED unit and modern lenses designed specifically for this type of LED to create a bright and visible indicating light. As with the pushbuttons, the indicating light lenses can be laser etched, simply order without lens and order M22/C22 custom etched lenses to attach.

Indicating lights with pigtail have options for M12, M8, or flying lead connectors, providing high degree of protection options.

**Note:** For additional accessories, please see **Pages V7-T1-111 to V7-T1-117**, 22.5 mm Modular Pushbuttons—M22 Accessories.

### Features

- LED offering only for improved brightness quality and up to 100,000 hours of operation
- Lenses specifically designed for LED illumination
- Lenses capable of being laser etched for custom solutions that last
- Units with pigtail allow for direct machine mounting with high degree of protection backside

### Protection Type

- IP67/IP69K
- NEMA 4X, 13
- IP65 rear rating with pigtail

# 1.6

## Pushbuttons and Indicating Lights

### 22.5 mm RMQ Compact Pushbuttons—C22

1

#### Catalog Number Selection

Catalog Number Selection is for illustrative purposes only and not to be used to create new catalog numbers.

#### Indicating Lights

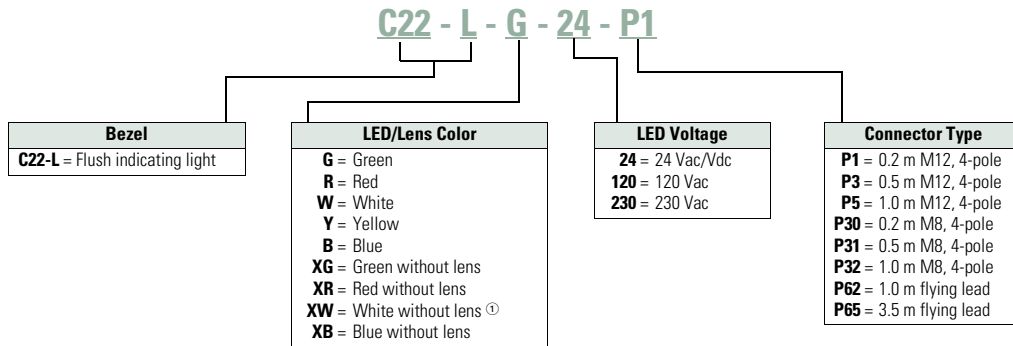

#### Product Selection

#### Indicating Lights

C22-L-\_\_

#### Indicating Lights



Lens Color	LED Color	Voltage	Catalog Number
Green	Green	24 Vac/Vdc	<b>C22-L-G-24</b>
		120 Vac	<b>C22-L-G-120</b>
		230 Vac	<b>C22-L-G-230</b>
Red	Red	24 Vac/Vdc	<b>C22-L-R-24</b>
		120 Vac	<b>C22-L-R-120</b>
		230 Vac	<b>C22-L-R-230</b>
White	White	24 Vac/Vdc	<b>C22-L-W-24</b>
		120 Vac	<b>C22-L-W-120</b>
		230 Vac	<b>C22-L-W-230</b>
Yellow	White	24 Vac/Vdc	<b>C22-L-Y-24</b>
		120 Vac	<b>C22-L-Y-120</b>
		230 Vac	<b>C22-L-Y-230</b>
Blue	Blue	24 Vac/Vdc	<b>C22-L-B-24</b>
		120 Vac	<b>C22-L-B-120</b>
		230 Vac	<b>C22-L-B-230</b>
Without Lens	Green	24 Vac/Vdc	<b>C22-L-XG-24</b>
		120 Vac	<b>C22-L-XG-120</b>
		230 Vac	<b>C22-L-XG-230</b>
	Red	24 Vac/Vdc	<b>C22-L-XR-24</b>
		120 Vac	<b>C22-L-XR-120</b>
		230 Vac	<b>C22-L-XR-230</b>
	White	24 Vac/Vdc	<b>C22-L-XW-24</b>
		120 Vac	<b>C22-L-XW-120</b>
		230 Vac	<b>C22-L-XW-230</b>
	Blue	24 Vac/Vdc	<b>C22-L-XB-24</b>
		120 Vac	<b>C22-L-XB-120</b>
		230 Vac	<b>C22-L-XB-230</b>

**Note**

Ⓢ Use white LED for both white and yellow lenses.

**C22 with Pigtail LED Options**

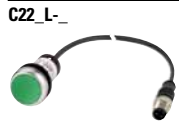

**C22 with Pigtail LED Options**

24 Vac/Vdc only indicating lights.

Color	Connector Type	0.2 m Catalog Number	0.5 m Catalog Number	1.0 m Catalog Number	3.5 m Catalog Number
Green	M8	C22-L-G-24-P30	C22-L-G-24-P31	C22-L-G-24-P32	—
	M12	C22-L-G-24-P1	C22-L-G-24-P3	C22-L-G-24-P5	—
	Flying lead	—	—	C22-L-G-24-P62	C22-L-G-24-P65
Red	M8	C22-L-R-24-P30	C22-L-R-24-P31	C22-L-R-24-P32	—
	M12	C22-L-R-24-P1	C22-L-R-24-P3	C22-L-R-24-P5	—
	Flying lead	—	—	C22-L-R-24-P62	C22-L-R-24-P65
White	M8	C22-L-W-24-P30	C22-L-W-24-P31	C22-L-W-24-P32	—
	M12	C22-L-W-24-P1	C22-L-W-24-P3	C22-L-W-24-P5	—
	Flying lead	—	—	C22-L-W-24-P62	C22-L-W-24-P65
Yellow	M8	C22-L-Y-24-P30	C22-L-Y-24-P31	C22-L-Y-24-P32	—
	M12	C22-L-Y-24-P1	C22-L-Y-24-P3	C22-L-Y-24-P5	—
	Flying lead	—	—	C22-L-Y-24-P62	C22-L-Y-24-P65
Blue	M8	C22-L-B-24-P30	C22-L-B-24-P31	C22-L-B-24-P32	—
	M12	C22-L-B-24-P1	C22-L-B-24-P3	C22-L-B-24-P5	—
	Flying lead	—	—	C22-L-B-24-P62	C22-L-B-24-P65



**Emergency Stops**



**Contents**

<i>Description</i>	<i>Page</i>
Pushbuttons—Non-Illuminated and Illuminated .....	<b>V7-T1-140</b>
Indicating Lights .....	<b>V7-T1-153</b>
Emergency Stops	
Non-Illuminated, Twist-Release .....	<b>V7-T1-157</b>
Non-Illuminated, Keyed-Release .....	<b>V7-T1-157</b>
Selector Switches .....	<b>V7-T1-159</b>
Technical Data and Specifications .....	<b>V7-T1-166</b>
Dimensions .....	<b>V7-T1-168</b>

**Emergency Stops**

**Product Description**

C22 emergency stops are a durable and reliable solution to a variety of e-stop applications. This compact e-stop, available as twist-to-release and keyed-release, is a simple product that eliminates the need for self-monitoring contact blocks, all while still meeting almost all of the industry safety standards.

E-stops with pigtails allow for direct machine mounting, eliminating the need for an enclosure with high degree of rear protection. Flying leads also allow for quick termination to nearby controls or functional safety devices.

**Note:** For additional accessories, please see **Pages V7-T1-111 to V7-T1-117**, 22.5 mm Modular Pushbuttons—M22 Accessories.

**Features**

- Available in push-pull, twist-release, twist-release with indicator, and key release 38 mm through 60 mm operators
- Available with M12 or flying lead pigtails, allowing direct machine mounting and easy reliable connections
- Meet functional safety requirements for E-stops

**Protection Type**

- Twist-Release
  - IP67/IP69K
- Keyed-Release
  - IP66
- NEMA 4X, 13
- With pigtail
  - IP65 rear rating

### Catalog Number Selection

Catalog Number Selection is for illustrative purposes only and not to be used to create new catalog numbers.

### Emergency Stops

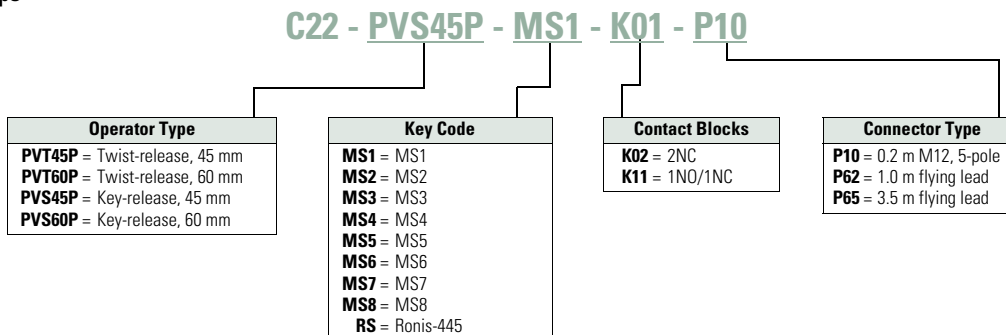

### Product Selection

#### Non-Illuminated, Twist-Release

#### C22-PVT\_ Non-Illuminated Emergency Stops, Twist-Release



Release Method	Operator Size	Contact Block Configuration	Catalog Number
Twist-release	45 mm	2NC	<b>C22-PVT45P-K02</b>
		1NO/1NC	<b>C22-PVT45P-K11</b>
	60 mm	2NC	<b>C22-PVT60P-K02</b>
		1NO/1NC	<b>C22-PVT60P-K11</b>

#### Non-Illuminated, Keyed-Release

#### C22-PVS\_ Non-Illuminated Emergency Stops, Keyed-Release



Release Method	Operator Size	Key Code	Contact Block Configuration	Catalog Number
Keyed-release	45 mm	MS1	2NC	<b>C22-PVS45P-MS1-K02</b>
			1NO/1NC	<b>C22-PVS45P-MS1-K11</b>
		MS2	2NC	<b>C22-PVS45P-MS2-K02</b>
			1NO/1NC	<b>C22-PVS45P-MS2-K11</b>
		MS3	2NC	<b>C22-PVS45P-MS3-K02</b>
			1NO/1NC	<b>C22-PVS45P-MS3-K11</b>
		MS4	2NC	<b>C22-PVS45P-MS4-K02</b>
			1NO/1NC	<b>C22-PVS45P-MS4-K11</b>
		MS5	2NC	<b>C22-PVS45P-MS5-K02</b>
			1NO/1NC	<b>C22-PVS45P-MS5-K11</b>
		MS6	2NC	<b>C22-PVS45P-MS6-K02</b>
			1NO/1NC	<b>C22-PVS45P-MS6-K11</b>
		MS7	2NC	<b>C22-PVS45P-MS7-K02</b>
			1NO/1NC	<b>C22-PVS45P-MS7-K11</b>
		MS8	2NC	<b>C22-PVS45P-MS8-K02</b>
			1NO/1NC	<b>C22-PVS45P-MS8-K11</b>
		Ronis	2NC	<b>C22-PVS45P-RS-K02</b>
			1NO/1NC	<b>C22-PVS45P-RS-K11</b>

**Note:** ⊕ = Safety function implemented with positive opening as defined in IEC/EN 60947-5-1.

C22-PVS\_





#### Non-Illuminated Emergency Stops, Keyed-Release, continued

Release Method	Operator Size	Key Code	Contact Block Configuration	Catalog Number
Keyed-release	60 mm	MS1	2NC	<b>C22-PVS60P-MS1-K02</b>
			1NO/1NC	<b>C22-PVS60P-MS1-K11</b>
		MS2	2NC	<b>C22-PVS60P-MS2-K02</b>
			1NO/1NC	<b>C22-PVS60P-MS2-K11</b>
		MS3	2NC	<b>C22-PVS60P-MS3-K02</b>
			1NO/1NC	<b>C22-PVS60P-MS3-K11</b>
		MS4	2NC	<b>C22-PVS60P-MS4-K02</b>
			1NO/1NC	<b>C22-PVS60P-MS4-K11</b>
		MS5	2NC	<b>C22-PVS60P-MS5-K02</b>
			1NO/1NC	<b>C22-PVS60P-MS5-K11</b>
		MS6	2NC	<b>C22-PVS60P-MS6-K02</b>
			1NO/1NC	<b>C22-PVS60P-MS6-K11</b>
		MS7	2NC	<b>C22-PVS60P-MS7-K02</b>
			1NO/1NC	<b>C22-PVS60P-MS7-K11</b>
		MS8	2NC	<b>C22-PVS60P-MS8-K02</b>
			1NO/1NC	<b>C22-PVS60P-MS8-K11</b>
Ronis	2NC	<b>C22-PVS60P-RS-K02</b>		
	1NO/1NC	<b>C22-PVS60P-RS-K11</b>		

#### E-stop

#### E-stop

Release Method	Operator Size	Contacts	Connector Length	Connector Type	Catalog Number	
<b>C22-PV-K11-P62</b> 	Push-pull	38 mm	2NC	1	Flying lead	<b>C22-PV-K02-P62</b>
			2NC	3.5	Flying lead	<b>C22-PV-K02-P65</b>
			1NO/1NC	1	Flying lead	<b>C22-PV-K11-P62</b>
			1NO/1NC	3.5	Flying lead	<b>C22-PV-K11-P65</b>
			2NC	0.2	M12, 5-pole	<b>C22-PV-K02-P10</b>
<b>C22-PVT-K02-P65</b> 	Twist release	38 mm	2NC	1	Flying lead	<b>C22-PVT-K02-P62</b>
			2NC	3.5	Flying lead	<b>C22-PVT-K02-P65</b>
			1NO/1NC	1	Flying lead	<b>C22-PVT-K11-P62</b>
			1NO/1NC	3.5	Flying lead	<b>C22-PVT-K11-P65</b>
			2NC	1	Flying lead	<b>C22-PVT45P-K02-P62</b>
			2NC	3.5	Flying lead	<b>C22-PVT45P-K02-P65</b>
			1NO/1NC	1	Flying lead	<b>C22-PVT45P-K11-P62</b>
			1NO/1NC	3.5	Flying lead	<b>C22-PVT45P-K11-P65</b>
			2NC	0.2	M12, 5-pole	<b>C22-PVT45P-K02-P10</b>
			<b>C22-PVT45PMPK02-P65</b> 	Twist release mechanical indication	45 mm	2NC
2NC	3.5	Flying lead				<b>C22-PVT45PMPK02-P65</b>
1NO/1NC	1	Flying lead				<b>C22-PVT45PMPK11-P62</b>
1NO/1NC	3.5	Flying lead				<b>C22-PVT45PMPK11-P65</b>

**Note:** ⊕ = Safety function implemented with positive opening as defined in IEC/EN 60947-5-1.

### Selector Switches



### Contents

<i>Description</i>	<i>Page</i>
Pushbuttons—Non-Illuminated and Illuminated .....	<b>V7-T1-140</b>
Indicating Lights .....	<b>V7-T1-153</b>
Emergency Stops .....	<b>V7-T1-156</b>
Selector Switches	
Non-Illuminated, Knob Type .....	<b>V7-T1-160</b>
Non-Illuminated, Key Operated .....	<b>V7-T1-162</b>
Technical Data and Specifications .....	<b>V7-T1-166</b>
Dimensions .....	<b>V7-T1-168</b>

### Selector Switches

#### Product Description

With over 20 variations of operation and 8 varieties of key codes, the C22 line offers a very complete line of selector switches.

Pigtail units come in M12, M8 or flying lead options.

**Note:** For additional accessories, please see **Pages V7-T1-111 to V7-T1-117**, 22.5 mm Modular Pushbuttons—M22 Accessories.

#### Features

- Selector switch (non-keyed) rated for 1 million mechanical operations
- Momentary selector switches are field convertible from momentary to maintained
- Rear pigtails provide IP65 front and rear ratings, eliminating enclosure requirements and reducing installation times

#### Protection Type

- IP65
- NEMA 4X, 13

# 1.6

## Pushbuttons and Indicating Lights

### 22.5 mm RMQ Compact Pushbuttons—C22

1

#### Catalog Number Selection

Catalog Number Selection is for illustrative purposes only and not to be used to create new catalog numbers.

#### Selector Switches—Non-Keyed

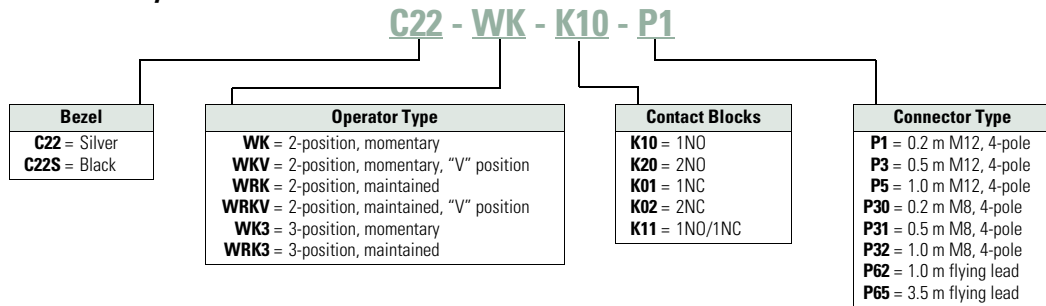

#### Product Selection

##### Non-Illuminated, Knob Type

C22(S)-WK- /  
C22(S)-WRK\_



##### Non-Illuminated Selector Switches, Knob Type

Type	Switching Position	Contact Block Configuration	Silver Bezel Catalog Number	Black Bezel Catalog Number	
Two-position	Momentary 40°	1NO	C22-WK-K10	C22S-WK-K10	
		2NO	C22-WK-K20	C22S-WK-K20	
		1NC	C22-WK-K01	C22S-WK-K01	
		2NC	C22-WK-K02	C22S-WK-K02	
		1NO/1NC	C22-WK-K11	C22S-WK-K11	
		1NO	C22-WKV-K10	C22S-WKV-K10	
	Momentary 60°	2NO	C22-WKV-K20	C22S-WKV-K20	
		1NC	C22-WKV-K01	C22S-WKV-K01	
		2NC	C22-WKV-K02	C22S-WKV-K02	
		1NO/1NC	C22-WKV-K11	C22S-WKV-K11	
		1NO	C22-WRK-K10	C22S-WRK-K10	
		2NO	C22-WRK-K20	C22S-WRK-K20	
	Maintained 40°	1NC	C22-WRK-K01	C22S-WRK-K01	
		2NC	C22-WRK-K02	C22S-WRK-K02	
		1NO/1NC	C22-WRK-K11	C22S-WRK-K11	
		1NO	C22-WRKV-K10	C22S-WRKV-K10	
		2NO	C22-WRKV-K20	C22S-WRKV-K20	
		1NC	C22-WRKV-K01	C22S-WRKV-K01	
Maintained 60°	2NC	C22-WRKV-K02	C22S-WRKV-K02		
	1NO/1NC	C22-WRKV-K11	C22S-WRKV-K11		
	Three-position	Momentary 40°	2NO	C22-WK3-K20	C22S-WK3-K20
			2NC	C22-WK3-K02	C22S-WK3-K02
			1NO/1NC	C22-WK3-K11	C22S-WK3-K11
		Maintained 60°	2NO	C22-WRK3-K20	C22S-WRK3-K20
2NC			C22-WRK3-K02	C22S-WRK3-K02	
1NO/1NC			C22-WRK3-K11	C22S-WRK3-K11	

**Note:** Momentary selector switches can be field converted to maintained.

### Non-Illuminated Selector Switches, Knob Type, with Pigtail

C22-W\_



#### Non-Illuminated Selector Switches, Knob Type, with Pigtail

Type	Switching Position	Contacts	Connector Length	Connector Type	Silver Bezel Catalog Number
Two-position	Momentary	1NC	1	Flying lead	C22-WK-K01-P62
		1NC	3.5	Flying lead	C22-WK-K01-P65
		1NO	0.5	M8	C22-WK-K10-P30
		1NO	0.5	M12	C22-WK-K10-P1
		1NO	1	M8	C22-WK-K10-P32
		1NO	1	M12	C22-WK-K10-P5
		1NO	1	Flying lead	C22-WK-K10-P62
		1NO	3.5	Flying lead	C22-WK-K10-P65
		1NO/1NC	1	Flying lead	C22-WK-K11-P62
		1NO/1NC	3.5	Flying lead	C22-WK-K11-P65
		2NC	1	Flying lead	C22-WK-K02-P62
		2NC	3.5	Flying lead	C22-WK-K02-P65
		2NO	1	Flying lead	C22-WK-K20-P62
		2NO	3.5	Flying lead	C22-WK-K20-P65
	Maintained	1NC	1	Flying lead	C22-WRK-K01-P62
		1NC	3.5	Flying lead	C22-WRK-K01-P65
		1NO	0.5	M8	C22-WRK-K10-P30
		1NO	0.5	M12	C22-WRK-K10-P1
		1NO	1	M8	C22-WRK-K10-P32
		1NO	1	M12	C22-WRK-K10-P5
		1NO	1	Flying lead	C22-WRK-K10-P62
		1NO	3.5	Flying lead	C22-WRK-K10-P65
		1NO/1NC	1	Flying lead	C22-WRK-K11-P62
		1NO/1NC	3.5	Flying lead	C22-WRK-K11-P65
		2NC	1	Flying lead	C22-WRK-K02-P62
		2NC	3.5	Flying lead	C22-WRK-K02-P65
		2NO	1	Flying lead	C22-WRK-K20-P62
		2NO	3.5	Flying lead	C22-WRK-K20-P65
Three-position	Momentary	1NO/1NC	1	Flying lead	C22-WK3-K11-P62
		1NO/1NC	3.5	Flying lead	C22-WK3-K11-P65
		2NC	1	Flying lead	C22-WK3-K02-P62
		2NC	3.5	Flying lead	C22-WK3-K02-P65
		2NO	1	Flying lead	C22-WK3-K20-P62
		2NO	3.5	Flying lead	C22-WK3-K20-P65
		Maintained	1NO/1NC	1	Flying lead
	1NO/1NC		3.5	Flying lead	C22-WRK3-K11-P65
	2NC		1	Flying lead	C22-WRK3-K02-P62
	2NC		3.5	Flying lead	C22-WRK3-K02-P65
	2NO		1	Flying lead	C22-WRK3-K20-P62
	2NO		3.5	Flying lead	C22-WRK3-K20-P65

#### 1

### Catalog Number Selection

Catalog Number Selection is for illustrative purposes only and not to be used to create new catalog numbers.

#### Selector Switches—Keyed

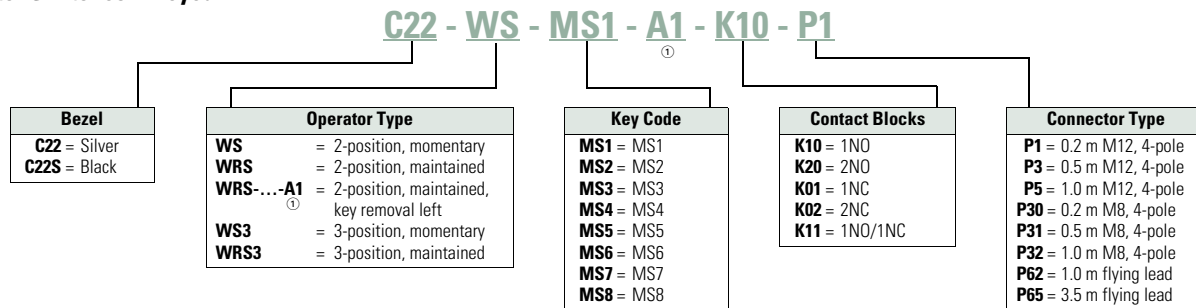

#### Non-Illuminated, Key Operated

#### C22(S)-WS-MS\_ Non-Illuminated Selector Switches, Key Operated





Position	Type	Key Code	Contact Block Configuration	Silver Bezel Catalog Number	Black Bezel Catalog Number
Two-position	Momentary key removal left  40°	MS1	1NO	C22-WS-MS1-K10	C22S-WS-MS1-K10
			2NO	C22-WS-MS1-K20	C22S-WS-MS1-K20
			1NC	C22-WS-MS1-K01	C22S-WS-MS1-K01
			2NC	C22-WS-MS1-K02	C22S-WS-MS1-K02
			1NO/1NC	C22-WS-MS1-K11	C22S-WS-MS1-K11
		MS2	1NO	C22-WS-MS2-K10	C22S-WS-MS2-K10
			2NO	C22-WS-MS2-K20	C22S-WS-MS2-K20
			1NC	C22-WS-MS2-K01	C22S-WS-MS2-K01
			2NC	C22-WS-MS2-K02	C22S-WS-MS2-K02
			1NO/1NC	C22-WS-MS2-K11	C22S-WS-MS2-K11
		MS3	1NO	C22-WS-MS3-K10	C22S-WS-MS3-K10
			2NO	C22-WS-MS3-K20	C22S-WS-MS3-K20
			1NC	C22-WS-MS3-K01	C22S-WS-MS3-K01
			2NC	C22-WS-MS3-K02	C22S-WS-MS3-K02
			1NO/1NC	C22-WS-MS3-K11	C22S-WS-MS3-K11
		MS4	1NO	C22-WS-MS4-K10	C22S-WS-MS4-K10
			2NO	C22-WS-MS4-K20	C22S-WS-MS4-K20
			1NC	C22-WS-MS4-K01	C22S-WS-MS4-K01
			2NC	C22-WS-MS4-K02	C22S-WS-MS4-K02
			1NO/1NC	C22-WS-MS4-K11	C22S-WS-MS4-K11
MS5	1NO	C22-WS-MS5-K10	C22S-WS-MS5-K10		
	2NO	C22-WS-MS5-K20	C22S-WS-MS5-K20		
	1NC	C22-WS-MS5-K01	C22S-WS-MS5-K01		
	2NC	C22-WS-MS5-K02	C22S-WS-MS5-K02		
	1NO/1NC	C22-WS-MS5-K11	C22S-WS-MS5-K11		

**Note:** Momentary selector switches can be field converted to maintained.

C22(S)-WRS-MS\_

Non-Illuminated Selector Switches, Key Operated, continued



Position	Type	Key Code	Contact Block Configuration	Silver Bezel Catalog Number	Black Bezel Catalog Number
Two-position, continued	Momentary key removal left  40°	MS6	1NO	C22-WS-MS6-K10	C22S-WS-MS6-K10
			2NO	C22-WS-MS6-K20	C22S-WS-MS6-K20
			1NC	C22-WS-MS6-K01	C22S-WS-MS6-K01
			2NC	C22-WS-MS6-K02	C22S-WS-MS6-K02
			1NO/1NC	C22-WS-MS6-K11	C22S-WS-MS6-K11
		MS7	1NO	C22-WS-MS7-K10	C22S-WS-MS7-K10
			2NO	C22-WS-MS7-K20	C22S-WS-MS7-K20
			1NC	C22-WS-MS7-K01	C22S-WS-MS7-K01
			2NC	C22-WS-MS7-K02	C22S-WS-MS7-K02
			1NO/1NC	C22-WS-MS7-K11	C22S-WS-MS7-K11
		MS8	1NO	C22-WS-MS8-K10	C22S-WS-MS8-K10
			2NO	C22-WS-MS8-K20	C22S-WS-MS8-K20
			1NC	C22-WS-MS8-K01	C22S-WS-MS8-K01
			2NC	C22-WS-MS8-K02	C22S-WS-MS8-K02
			1NO/1NC	C22-WS-MS8-K11	C22S-WS-MS8-K11
Two-position	Maintained key removal left/right  40°	MS1	1NO	C22-WRS-MS1-K10	C22S-WRS-MS1-K10
			2NO	C22-WRS-MS1-K20	C22S-WRS-MS1-K20
			1NC	C22-WRS-MS1-K01	C22S-WRS-MS1-K01
			2NC	C22-WRS-MS1-K02	C22S-WRS-MS1-K02
			1NO/1NC	C22-WRS-MS1-K11	C22S-WRS-MS1-K11
		MS2	1NO	C22-WRS-MS2-K10	C22S-WRS-MS2-K10
			2NO	C22-WRS-MS2-K20	C22S-WRS-MS2-K20
			1NC	C22-WRS-MS2-K01	C22S-WRS-MS2-K01
			2NC	C22-WRS-MS2-K02	C22S-WRS-MS2-K02
			1NO/1NC	C22-WRS-MS2-K11	C22S-WRS-MS2-K11
		MS3	1NO	C22-WRS-MS3-K10	C22S-WRS-MS3-K10
			2NO	C22-WRS-MS3-K20	C22S-WRS-MS3-K20
			1NC	C22-WRS-MS3-K01	C22S-WRS-MS3-K01
			2NC	C22-WRS-MS3-K02	C22S-WRS-MS3-K02
			1NO/1NC	C22-WRS-MS3-K11	C22S-WRS-MS3-K11

**Note:** Momentary selector switches can be field converted to maintained.







1

C22(S)-WRS...-MS1\_

#### Non-Illuminated Selector Switches, Key Operated, continued



Position	Type	Key Code	Contact Block Configuration	Silver Bezel Catalog Number	Black Bezel Catalog Number
Two-position, continued	Maintained key removal left/right  40° 	MS4	1NO	C22-WRS-MS4-K10	C22S-WRS-MS4-K10
			2NO	C22-WRS-MS4-K20	C22S-WRS-MS4-K20
			1NC	C22-WRS-MS4-K01	C22S-WRS-MS4-K01
			2NC	C22-WRS-MS4-K02	C22S-WRS-MS4-K02
			1NO/1NC	C22-WRS-MS4-K11	C22S-WRS-MS4-K11
		MS5	1NO	C22-WRS-MS5-K10	C22S-WRS-MS5-K10
			2NO	C22-WRS-MS5-K20	C22S-WRS-MS5-K20
			1NC	C22-WRS-MS5-K01	C22S-WRS-MS5-K01
			2NC	C22-WRS-MS5-K02	C22S-WRS-MS5-K02
			1NO/1NC	C22-WRS-MS5-K11	C22S-WRS-MS5-K11
	MS6	1NO	C22-WRS-MS6-K10	C22S-WRS-MS6-K10	
		2NO	C22-WRS-MS6-K20	C22S-WRS-MS6-K20	
		1NC	C22-WRS-MS6-K01	C22S-WRS-MS6-K01	
		2NC	C22-WRS-MS6-K02	C22S-WRS-MS6-K02	
		1NO/1NC	C22-WRS-MS6-K11	C22S-WRS-MS6-K11	
	MS7	1NO	C22-WRS-MS7-K10	C22S-WRS-MS7-K10	
		2NO	C22-WRS-MS7-K20	C22S-WRS-MS7-K20	
		1NC	C22-WRS-MS7-K01	C22S-WRS-MS7-K01	
		2NC	C22-WRS-MS7-K02	C22S-WRS-MS7-K02	
		1NO/1NC	C22-WRS-MS7-K11	C22S-WRS-MS7-K11	
MS8	1NO	C22-WRS-MS7-K10	C22S-WRS-MS7-K10		
	2NO	C22-WRS-MS7-K20	C22S-WRS-MS7-K20		
	1NC	C22-WRS-MS7-K01	C22S-WRS-MS7-K01		
	2NC	C22-WRS-MS7-K02	C22S-WRS-MS7-K02		
	1NO/1NC	C22-WRS-MS7-K11	C22S-WRS-MS7-K11		
Two-position	Maintained key removal left  40° 	MS1	1NO	C22-WRS-MS1-A1-K10	C22S-WRS-MS1-A1-K10
			2NO	C22-WRS-MS1-A1-K20	C22S-WRS-MS1-A1-K20
			1NC	C22-WRS-MS1-A1-K01	C22S-WRS-MS1-A1-K01
			2NC	C22-WRS-MS1-A1-K02	C22S-WRS-MS1-A1-K02
			1NO/1NC	C22-WRS-MS1-A1-K11	C22S-WRS-MS1-A1-K11
Three Position	Momentary Key Removal Center  40° 	MS1	2NO	C22-WRS3-MS1-K20	C22S-WRS3-MS1-K20
			2NC	C22-WRS3-MS1-K02	C22S-WRS3-MS1-K02
	1NO/1NC		C22-WRS3-MS1-K11	C22S-WRS3-MS1-K11	
	Maintained Key Removal Left/Right  60° 	MS1	2NO	C22-WRS3-MS1-K20	C22S-WRS3-MS1-K20
			2NC	C22-WRS3-MS1-K02	C22S-WRS3-MS1-K02
			1NO/1NC	C22-WRS3-MS1-K11	C22S-WRS3-MS1-K11

**Note:** Momentary selector switches can be field converted to maintained.

### Non-Illuminated Selector Switches, Key Operated, with Pigtail

C22-W\_



### Non-Illuminated Selector Switches, Key Operated, with Pigtail

Position	Switching Position	Contacts	Connector Length	Connector Type	Silver Bezel Catalog Number
Two-position	Momentary 40° 	1NC	1 m	Flying lead	<b>C22-WS-MS1-K01-P62</b>
		1NC	3.5 m	Flying lead	<b>C22-WS-MS1-K01-P65</b>
		1NO	0.2 m	M12	<b>C22-WS-MS1-K10-P1</b>
		1NO	0.2 m	M8	<b>C22-WS-MS1-K10-P30</b>
		1NO	1 m	M12	<b>C22-WS-MS1-K10-P5</b>
		1NO	1 m	M8	<b>C22-WS-MS1-K10-P32</b>
		1NO	1 m	Flying lead	<b>C22-WS-MS1-K10-P62</b>
		1NO	3.5 m	Flying lead	<b>C22-WS-MS1-K10-P65</b>
		1NO/1NC	1 m	Flying lead	<b>C22-WS-MS1-K11-P62</b>
		1NO/1NC	3.5 m	Flying lead	<b>C22-WS-MS1-K11-P65</b>
		2NC	1 m	Flying lead	<b>C22-WS-MS1-K02-P62</b>
		2NC	3.5 m	Flying lead	<b>C22-WS-MS1-K02-P65</b>
	2NO	1 m	Flying lead	<b>C22-WS-MS1-K20-P62</b>	
	2NO	3.5 m	Flying lead	<b>C22-WS-MS1-K20-P65</b>	
	Maintained 60° 	1NC	1 m	Flying lead	<b>C22-WRS-MS1-K01-P62</b>
		1NC	3.5 m	Flying lead	<b>C22-WRS-MS1-K01-P65</b>
		1NO	0.2 m	M12	<b>C22-WRS-MS1-K10-P1</b>
		1NO	0.2 m	M8	<b>C22-WRS-MS1-K10-P30</b>
		1NO	1 m	M12	<b>C22-WRS-MS1-K10-P5</b>
		1NO	1 m	M8	<b>C22-WRS-MS1-K10-P32</b>
		1NO	1 m	Flying lead	<b>C22-WRS-MS1-K10-P62</b>
		1NO	3.5 m	Flying lead	<b>C22-WRS-MS1-K10-P65</b>
		1NO/1NC	1 m	Flying lead	<b>C22-WRS-MS1-K11-P62</b>
		1NO/1NC	3.5 m	Flying lead	<b>C22-WRS-MS1-K11-P65</b>
2NC		1 m	Flying lead	<b>C22-WRS-MS1-K02-P62</b>	
2NC		3.5 m	Flying lead	<b>C22-WRS-MS1-K02-P65</b>	
2NO	1 m	Flying lead	<b>C22-WRS-MS1-K20-P62</b>		
2NO	3.5 m	Flying lead	<b>C22-WRS-MS1-K20-P65</b>		
Three-position	Momentary 40° 	1NO/1NC	1 m	Flying lead	<b>C22-WS3-MS1-K11-P62</b>
		1NO/1NC	3.5 m	Flying lead	<b>C22-WS3-MS1-K11-P65</b>
		2NC	1 m	Flying lead	<b>C22-WS3-MS1-K02-P62</b>
		2NC	3.5 m	Flying lead	<b>C22-WS3-MS1-K02-P65</b>
		2NO	1 m	Flying lead	<b>C22-WS3-MS1-K20-P62</b>
		2NO	3.5 m	Flying lead	<b>C22-WS3-MS1-K20-P65</b>
	Maintained 60° 	1NO/1NC	1 m	Flying lead	<b>C22-WRS3-MS1-K11-P62</b>
		1NO/1NC	3.5 m	Flying lead	<b>C22-WRS3-MS1-K11-P65</b>
		2NC	1 m	Flying lead	<b>C22-WRS3-MS1-K02-P62</b>
		2NC	3.5 m	Flying lead	<b>C22-WRS3-MS1-K02-P65</b>
		2NO	1 m	Flying lead	<b>C22-WRS3-MS1-K20-P62</b>
		2NO	3.5 m	Flying lead	<b>C22-WRS3-MS1-K20-P65</b>

# 1.6

## Pushbuttons and Indicating Lights

### 22.5 mm RMQ Compact Pushbuttons—C22

1

#### Technical Data and Specifications

##### 22.5 mm RMQ Compact Pushbuttons—C22

Description	Unit	Pushbutton Actuators		Indicator Lights C22	Selector Switch Actuators C22	Key-Operated Buttons C22	Emergency Stop/ Emergency Switching OFF Pushbuttons C22	
		Illuminated Pushbuttons C22	Momentary					Maintained
<b>General</b>								
Standards		IEC/EN 60947 VDE 0660						
Lifespan, mechanical	Operations	x 10 <sup>6</sup>	5	1	—	1	0.1	0.05
Operating frequency	Operations/h		≥3600	≥3600	—	≥2000	≥100	≥300
Actuating force	N		≥5	≥5	—	—	—	≥50
Operating torque	Nm		—	—	—	≥0.3	≥0.5	—
Terminal screw tightening torque	Nm		0.8	0.8	0.8	0.8	0.8	0.8
Threaded ring tightening torque	Nm		2	2	2	2	2	2
Protection type			IP67, IP69K	IP67, IP69K	IP67, IP69K	IP65	IP66	IP67, IP69K
Climatic proofing			Damp heat, constant, to IEC 60068-2-78 Damp heat, cyclic, to IEC 60068-2-30					
Ambient temperature								
Open	°C		–25° to 70°	–25° to 70°	–25° to 70°	–25° to 70°	–25° to 70°	–25° to 70°
Storage	°C		–30° to 80°	–30° to 80°	–30° to 80°	–30° to 80°	–30° to 80°	–30° to 80°
Mounting position			As required	As required	As required	As required	As required	As required
Mechanical shock resistance to IEC 60068-2-27 Shock duration 11 ms, half-sinusoidal	g		30	30	30	30	30	30
Terminal capacities								
Solid	mm <sup>2</sup>		2 x 0.5–1.5	2 x 0.5–1.5	2 x 0.5–1.5	2 x 0.5–1.5	2 x 0.5–1.5	2 x 0.5–1.5
Flexible with ferrule	mm <sup>2</sup>		2 x 0.5–1.5	2 x 0.5–1.5	2 x 0.5–1.5	2 x 0.5–1.5	2 x 0.5–1.5	2 x 0.5–1.5
<b>Contacts</b>								
Rated impulse withstand voltage	U <sub>imp</sub>	Vac	4000	4000	4000	4000	4000	4000
Rated insulation voltage	U <sub>i</sub>	V	250	250	250	250	250	250
Overvoltage category/pollution degree			III/3	III/3	III/3	III/3	III/3	III/3
Control circuit reliability								
at 5 Vdc/1 mA	H <sub>F</sub>	Fault probability	Values follow	Values follow	—	Values follow	Values follow	Values follow
at 17 Vdc/7 mA	H <sub>F</sub>	Fault probability	N/O contact: statistically determined 1 failure per 17 x 10 <sup>6</sup> operations N/C contact: statistically determined 1 failure per 0.9 x 10 <sup>6</sup> operations		—	N/O contact: statistically determined 1 failure per 17 x 10 <sup>6</sup> operations N/C contact: statistically determined 1 failure per 0.9 x 10 <sup>6</sup> operations		
at 24 Vdc/5 mA	H <sub>F</sub>	Fault probability	Values follow	Values follow	—	Values follow	Values follow	Values follow
Max. short-circuit protective device								
Fuse	gG/gL	A	10	10	—	10	10	10

### 22.5 mm RMQ Compact Pushbuttons—C22, continued

Description	Unit	Push-button Actuators		Indicator Lights C22	Selector Switch Actuators C22	Key-Operated Buttons C22	Emergency Stop/ Emergency Switching OFF Pushbuttons C22
		Illuminated Pushbuttons C22	Momentary				
<b>Switching Capacity</b>							
Rated operational current							
AC-15							
24V	$I_e$	A	4	4	—	4	4
110V	$I_e$	A	2	2	—	2	2
230V	$I_e$	A	1.5	1.5	—	1.5	1.5
DC-13							
24V	$I_e$	A	3	3	—	3	3
60V	$I_e$	A	1	1	—	1	1
110V	$I_e$	A	0.6	0.6	—	0.6	0.6
220V	$I_e$	A	0.3	0.3	—	0.3	0.3
Lifespan, electrical							
AC-15							
230V/0.5A	Operations	$\times 10^6$	0.4	0.4	—	0.4	0.4
230V/1.0A		$\times 10^6$	0.6	0.6	—	0.6	0.6

### Contact Travel

#### Contact Travel Diagram

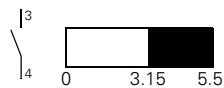

- Contact closed
- Contact open

# 1.6

## Pushbuttons and Indicating Lights

### 22.5 mm RMQ Compact Pushbuttons—C22

1

#### Dimensions

Approximate Dimensions in mm [in]

#### Illuminated Pushbuttons

*Flat*

**C22(S)-DRL\_/C22(S)-DL\_**

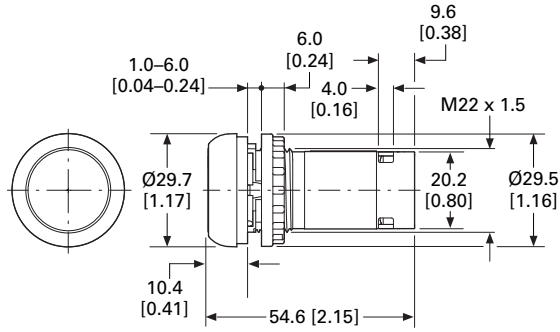

*Extended*

**C22(S)-DRLH\_/C22(S)-DLH\_**

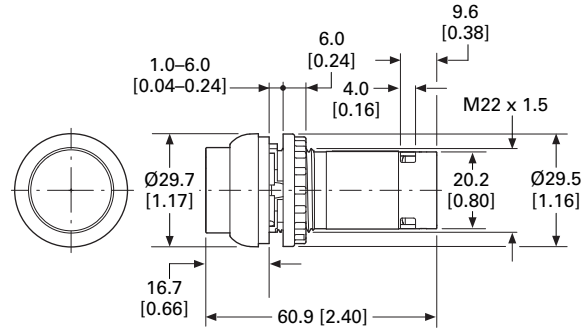

#### Pushbutton Actuators

*Flat*

**C22(S)-DR\_/C22(S)-D\_**

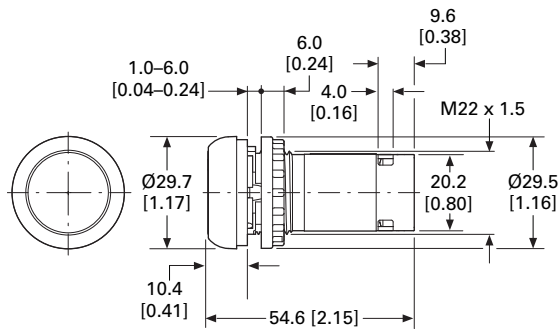

*Extended*

**C22(S)-DRH\_/C22(S)-DH\_**

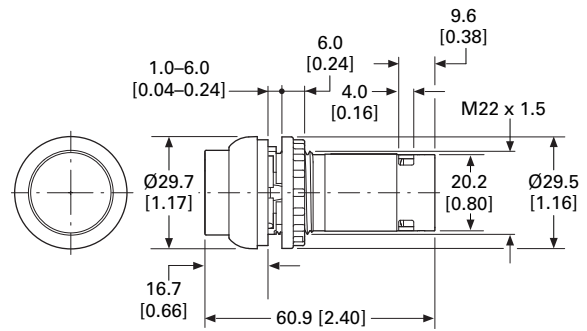

#### Indicating Lights

*Flat*

**C22-L\_**

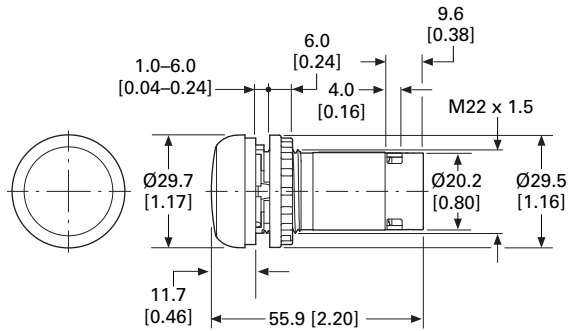

Approximate Dimensions in mm [in]

**Emergency Stop/Emergency Switching OFF Pushbuttons**

**C22-PVT45P\_**

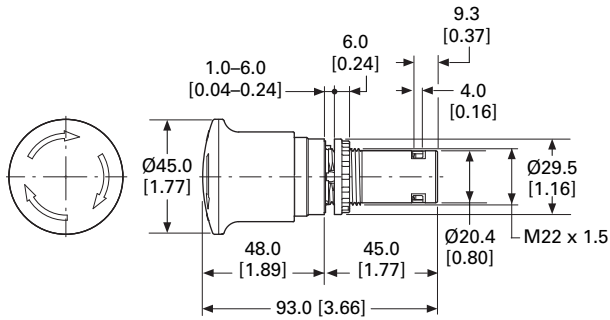

**C22-PVT60P\_**

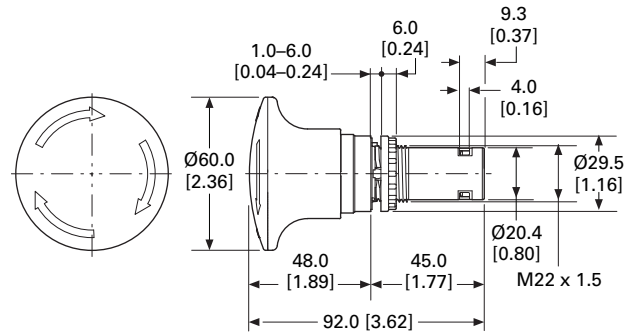

**C22-PVT45P-MS\_**

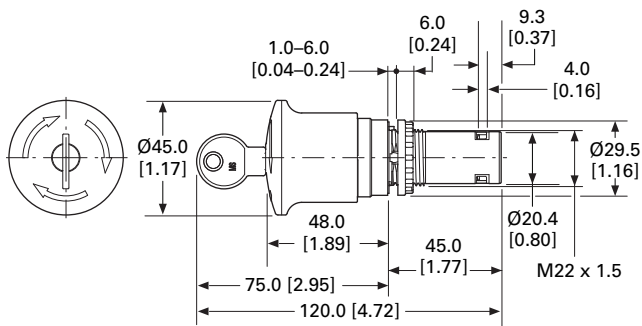

**C22-PVT45P-RS\_**

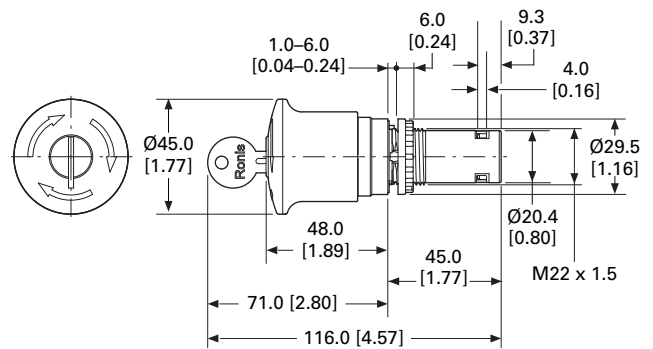

**C22-PVT60P-MS\_**

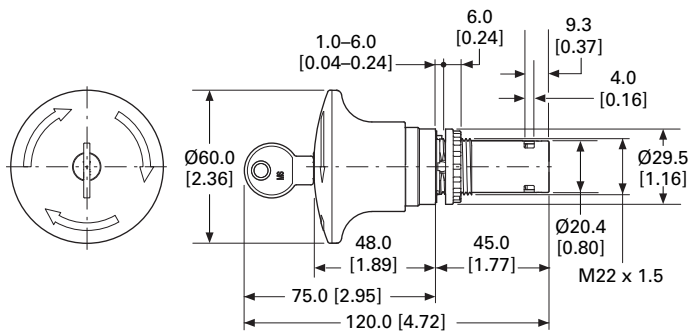

**C22-PVT60P-RS\_**

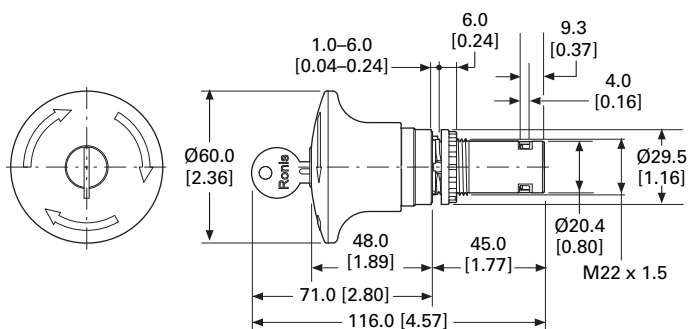

# 1.6

## Pushbuttons and Indicating Lights

### 22.5 mm RMQ Compact Pushbuttons—C22

1

Approximate Dimensions in mm [in]

#### Selector Switch Actuators

##### C22(S)-W(R)K\_

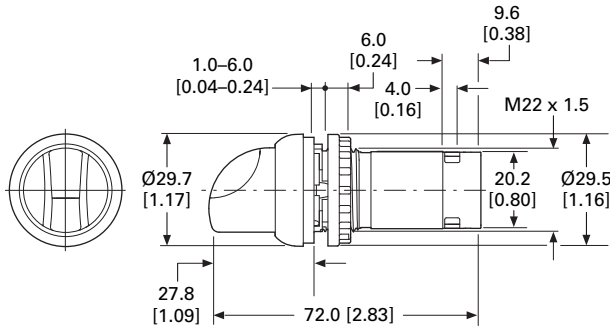

#### Selector Switch Actuators/V Position

##### C22(S)-W(R)KV\_

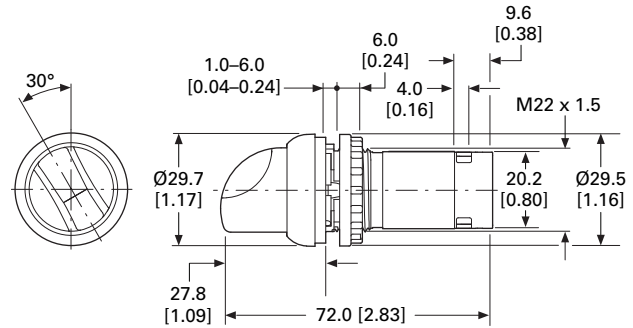

#### Key Operated Actuators

##### C22(S)-WS(3)-MS\_/C22(S)-WRS(3)-MS\_

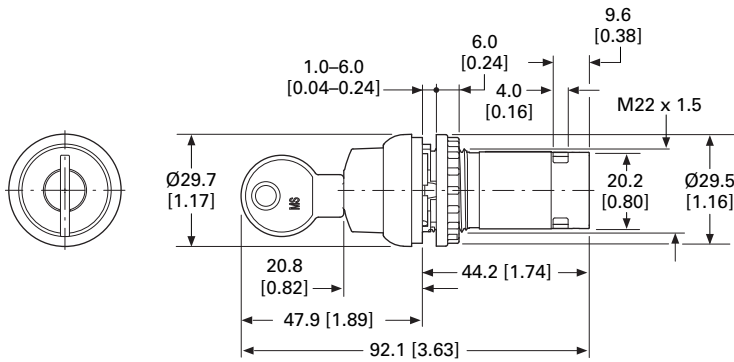

##### C22(S)-WS(3)-RS\_/C22(S)-WRS(3)-RS\_

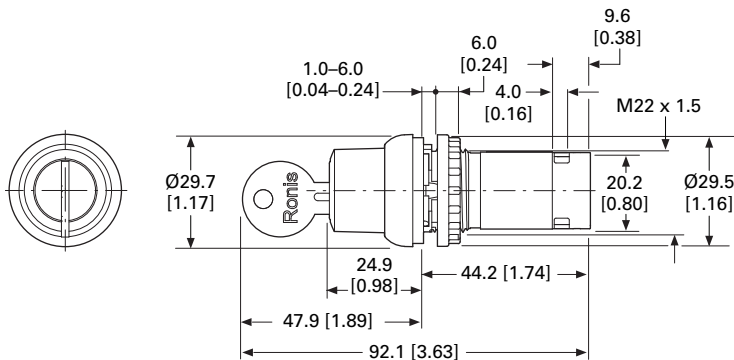

Approximate Dimensions in mm [in]

**Pushbuttons, M12A**  
C22-D...-P1/-P3/-P5

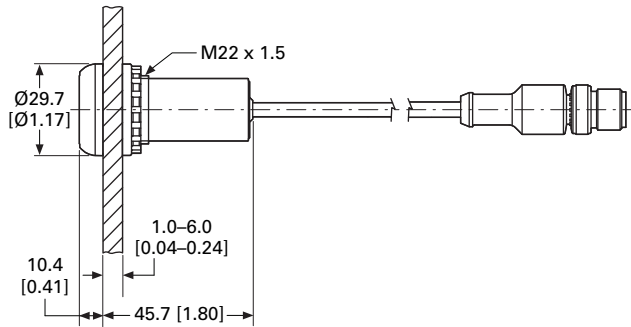

**Pushbuttons, M8**  
C22-D...-P30/-P31/-P32

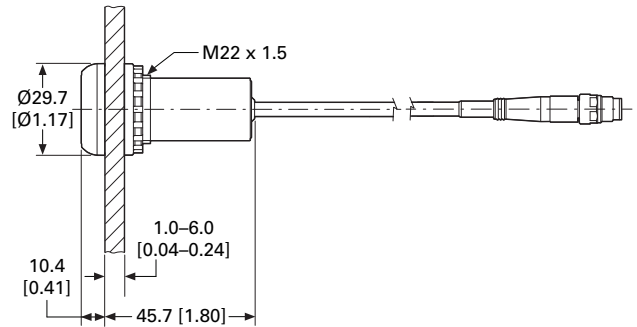

**Pushbuttons, Underterminated Cable End, Flying Lead**  
C22-D...-P/-P62/-P65

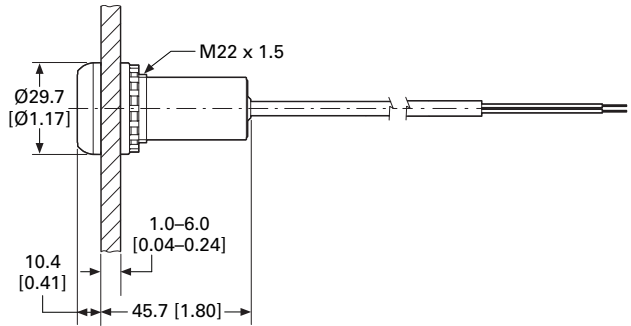

**Indicator Lights, M12A**  
C22-L...-P1/-P3/-P5

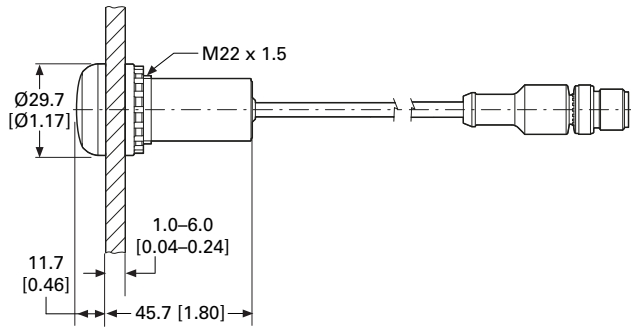

**Indicator Lights, M8**  
C22-L...-P30/-P31/-P32

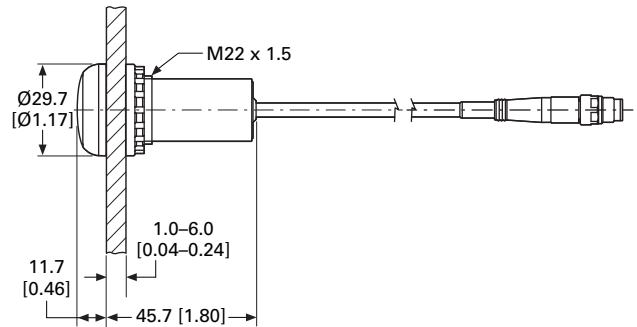

**Indicator Lights, Underterminated Cable End, Flying Lead**  
C22-L...-P62/-P65

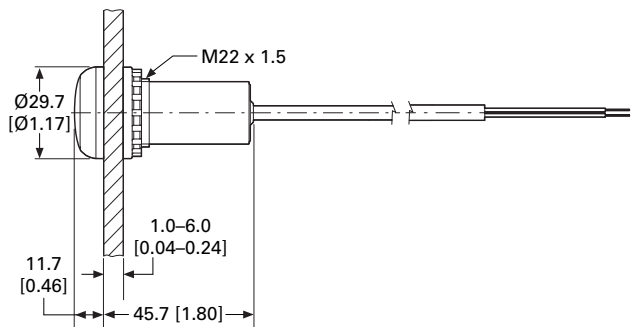



# 1.6

## Pushbuttons and Indicating Lights

### 22.5 mm RMQ Compact Pushbuttons—C22

1

Approximate Dimensions in mm [in]

#### Emergency Switching Off, M12A

C22-PVT...-P10

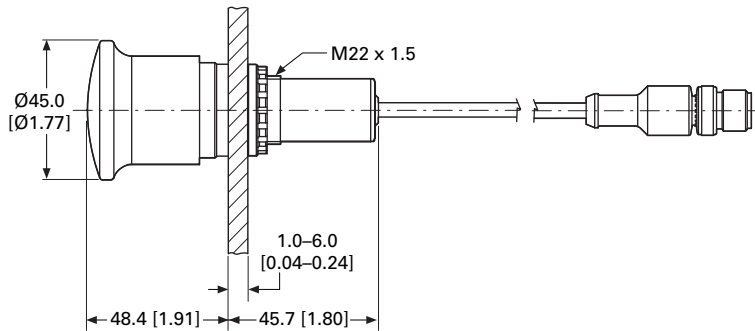

#### Emergency Switching Off, Underterminated Cable End, Flying Lead

C22-PVT...-P62/-P65

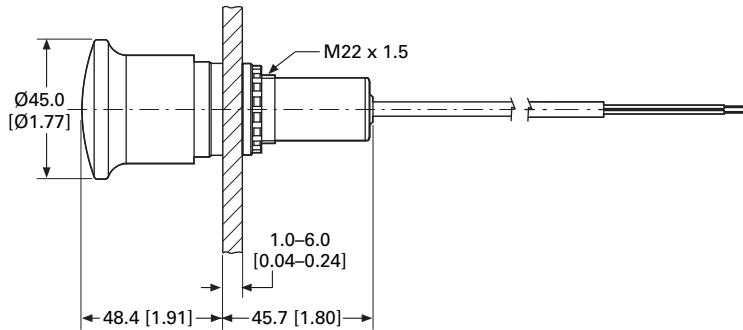

#### Emergency Switching Off, M12

C22-PV...-P10

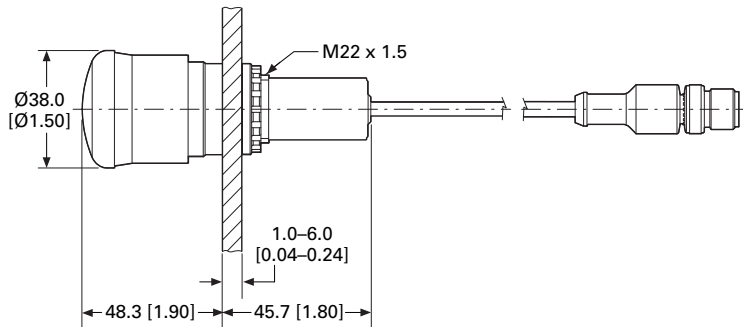

#### Emergency Switching Off, Underterminated Cable End, Flying Lead

C22-PV...-P62/-P65

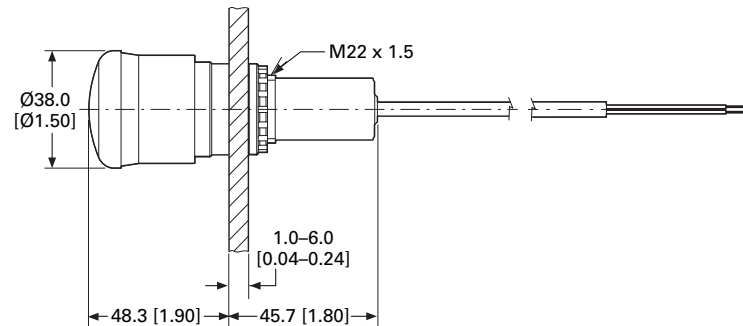

Approximate Dimensions in mm [in]

**Key-Operated Buttons, M12A**

C22-W(R)S(3)-MS1-...-P1/-P5

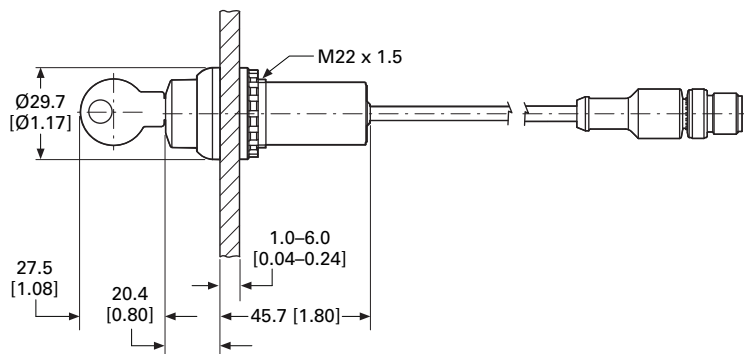

**Key-Operated Buttons, M8**

C22-W(R)S(3)-MS1-...-P30/-P32

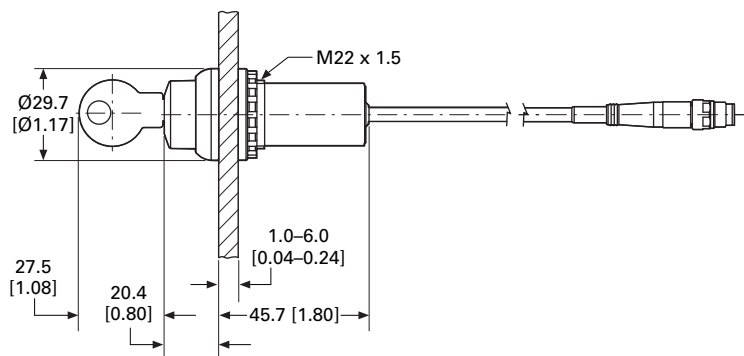

**Key-Operated Buttons, Unterminated Cable End, Flying Lead**

C22-W(R)S(3)-MS1-...-P62/-P65

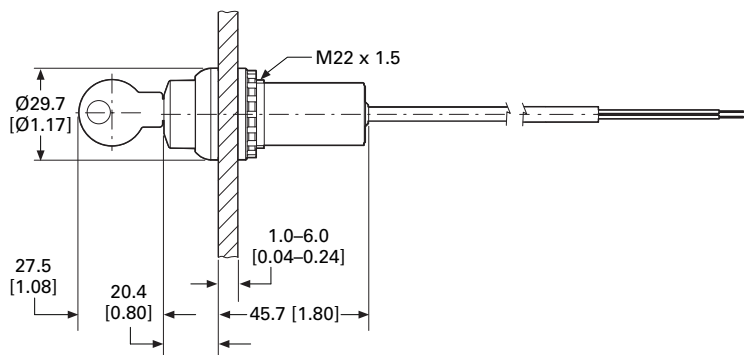

## 30.5 mm Square Multifunction Watertight/Oiltight—E30



### Product Description

The E30 industrial pushbutton and indicating light line from Eaton's Electrical Sector features a wide selection of square, multifunction operators which conveniently mount in a standard 30.5 mm (1-13/64 in) diameter panel hole. Up to six input and indicating functions can be grouped into a single operating head, saving valuable panel space. Attractive square operator styling, coupled with custom legending of colored buttons and lenses and many special function accessories, makes E30 components ideally suited for use on control consoles and for a variety of industrial OEM applications.

### Features

Type E30 control units consist of a basic operator with one or more buttons and lenses and contact block selection dependent on the specific operator configuration.

- **Pushbutton operators** will accommodate up to four single depth stackable contact blocks behind each operating button, up to eight circuits maximum.
- **Indicating lights** are supplied complete with either a transformer light unit up to 600 Vac supply line voltage or full voltage light unit up to 120 Vac/Vdc supply line voltage.
- **Combination pushbutton with indicating light** operators are supplied complete with a transformer or full voltage unit. Contact blocks must be ordered separately, up to four circuits maximum.

### Contents

<i>Description</i>	<i>Page</i>
30.5 mm Square Multifunction Watertight/Oiltight—E30	
Product Identification . . . . .	<b>V7-T1-175</b>
Product Selection	
Operators . . . . .	<b>V7-T1-176</b>
Operator Components . . . . .	<b>V7-T1-179</b>
Accessories . . . . .	<b>V7-T1-185</b>
Options . . . . .	<b>V7-T1-186</b>
Replacement Parts . . . . .	<b>V7-T1-189</b>
Technical Data and Specifications . . . . .	<b>V7-T1-190</b>
Dimensions . . . . .	<b>V7-T1-191</b>

### Standards and Certifications

- UL Listed—File No. E131568
- CSA Certified—File No. LR68551



### Ingress Protection

- Single and dual indicating lights
  - UL (NEMA) Type 1, 2, 3, 3R, 3S, 4, 4X, 12, 13
- All other operators
  - UL (NEMA) Type 3, 3R, 4, 4X, 12, 13

**Product Identification**

**30.5 mm Square Multifunction Watertight/Oiltight**

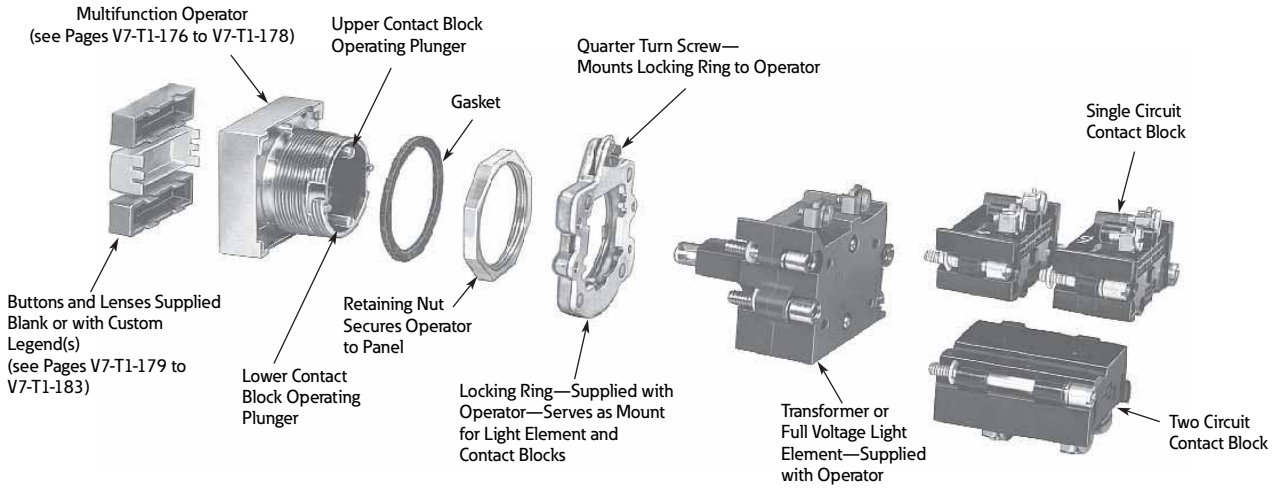

## Product Selection

### Operators

#### When Ordering a Complete E30 Control Unit Specify

Catalog Number of ...	Ordering Example (E30AB)	
Operator	E30KB130	"START"
Button(s)	E30KB231	"STOP"
Contact block(s)	E30KLA1	1NO
Accessories (if required)	E30KLA2	1NC

#### Square Multifunction Operators

UL (NEMA) Type 3, 3R, 4, 4X, 12, 13

#### Single Button Operator



Shown with Extended Button

#### Single Button Operator/without Button (Order Button Separately)

Button Type Required <sup>①</sup>	Operation	Special Features	Catalog Number
	Momentary	—	<b>E30AA</b>

#### Two Button Operator



Shown with Extended Buttons

#### Two Button Operator/without Buttons (Order Buttons Separately)

Button Types Required <sup>①</sup>	Operation		Special Features	Catalog Number
	Top Button	Bottom Button		
	Momentary	Momentary	—	<b>E30AB</b>
	Momentary	Momentary	With mechanical interlock	<b>E30AC</b>
Maintained (all contacts)	Maintained	Release (all contacts)	—	<b>E30AD</b> <sup>②</sup>
	Maintained (all contacts)	Release (all contacts)	With mechanical interlock	<b>E30AP</b> <sup>②③</sup>

#### Two Button Operator



Shown with Long Release Bar

#### Two Button Operator with Long (OFF) Release Bar—Includes OFF Bar/Button (Order Other Buttons Separately)

Button Types Required <sup>④⑤</sup>	Operation		Special Features	Catalog Number
	Top Button	Bottom Button		
	Maintained	Maintained	—	<b>E30AF</b>
	Maintained	Maintained	With mechanical interlock	<b>E30AG</b>
	Maintained	Momentary	With mechanical interlock	<b>E30AH</b>
	Maintained (all contacts)	Maintained (bottom contacts only)	Top button operates both top and bottom contacts	<b>E30AK</b> <sup>⑥</sup>



#### Notes

- ① Order from table on **Page V7-T1-179**.
- ② Limited to two single circuit, one double circuit 600V or two 120V (E30KLA9) contact blocks behind each button.
- ③ Buttons are interlocked so that one of the two is maintained at all times.  
Depressing the other button releases the maintained button and maintains the depressed button.
- ④ Operators are supplied as standard with red extended bar(s) marked "OFF" as shown in sketch.  
For other colors or markings, contact your nearest Eaton Distributor or call our Customer Service Center 1-800-356-1243.  
For replacement of standard red release bar, order **E30KR100**.
- ⑤ Order from table on **Page V7-T1-180**.
- ⑥ Limited to two single circuit, one double circuit 600V or two 120V (E30KLA9) contact blocks behind each button.

### Square Multifunction Operators and Indicating Lights

UL (NEMA) Type 3, 3R, 4, 4X, 12, 13

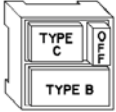
#### Two Button Operator with (OFF) Release—Includes OFF Bar/Button(s) (Order Other Buttons Separately)

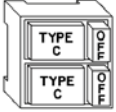
	Button Types Required <sup>①②</sup>	Operation		Special Features	Catalog Number
		Top Button	Bottom Button		
<b>Two Button Operator</b>  Shown with Release Bar for Top Button		Maintained	Momentary	Release bar for top button	<b>E30AL</b>
<b>Two Button Operator</b>  Shown with Release Bars for Each Button		Maintained	Maintained	Individual release bars for each button	<b>E30AN</b>
		Maintained with interlock	Maintained with interlock	Individual release bars for each button	<b>E30AM</b>

#### Single Indicating Light Unit/without Lens (Order Lens Separately)

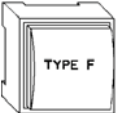
<b>Single Indicating Light Unit</b>  Shown with Lens	Lens Type Required <sup>③</sup>	Type of Light Element		Full Voltage (60/50 Hertz AC or DC)			
		Transformer (60/50 Hertz AC)					
		Voltage	Lamp Number <sup>④</sup>	Catalog Number	Voltage	Lamp Number <sup>④</sup>	Catalog Number
		120	#259	<b>E30BA</b>	24	24PSB	<b>E30BJ</b>
					120	120PSB	<b>E30BM</b>

#### Dual Indicating Light Unit/without Lenses (Order Lenses Separately)

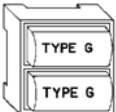
<b>Dual Indicating Light Unit</b>  Shown with Lens	Lens Types Required <sup>⑤</sup>	Type of Light Element		Full Voltage (60/50 Hertz AC or DC)			
		Transformer (60/50 Hertz AC)					
		Voltage	Lamp Number <sup>④</sup>	Catalog Number	Voltage	Lamp Number <sup>④</sup>	Catalog Number
		120	6PSB	<b>E30CA</b>	24	24PSB	<b>E30CJ</b>
					120	120PSB	<b>E30CM</b>

#### Notes

- ① Order from table on **Page V7-T1-180**.
- ② Operators are supplied as standard with red extended release bar(s) marked "OFF" as shown in sketch. For other colors or markings, contact your nearest Eaton Distributor or call our Customer Service Center 1-800-356-1243. For replacement of standard red release bar, order **E30KR101**.
- ③ Order from table on **Page V7-T1-181**.
- ④ Light units will also accept LED lamps. For LED part numbers, see table on **Page V7-T1-189**.
- ⑤ Order from table on **Page V7-T1-182**.

1

UL (NEMA) Type 3, 3R, 4, 4X, 12, 13

#### Single Button Operator and Indicating Light



Shown with Button and Lens

#### Single Button Operator with Indicating Light/without Button or Lens (Order Button and Lens Separately)

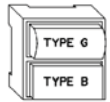
Button and Lens Types Required ①	Operation (Bottom Button)	Type of Light Element Transformer (60/50 Hertz AC)			Full Voltage (60/50 Hertz AC or DC)		
		Voltage	Lamp Number ②	Catalog Number	Voltage	Lamp Number ②	Catalog Number
	Momentary	120	6PSB	<b>E30DA</b>	24	24PSB	<b>E30DX3</b>
		120	120PSB	<b>E30DF</b>			

#### Single Button Operator with Release Bar and Indicating Light



Shown with Button and Lens

#### Single Button Operator with (OFF) Release Bar and Indicating Light—Includes OFF Bar/Button (Order Other Button and Lens Separately)

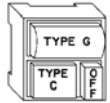
Button and Lens Types Required ①	Operation (Bottom Button)	Type of Light Element Transformer (60/50 Hertz AC)			Full Voltage (60/50 Hertz AC or DC)		
		Voltage	Lamp Number ②	Catalog Number	Voltage	Lamp Number ②	Catalog Number
	Maintained	120	6PSB	<b>E30DG</b>	24	24PSB	<b>E30DX13</b>
		120	120PSB	<b>E30DM</b>			

#### Two Button Operator with Indicating Light



Shown with Button and Lens

#### Two Button Operator with Indicating Light/without Buttons or Lens (Order Buttons and Lens Separately)

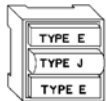
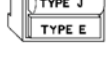
Button and Lens Types Required ④	Button Operation	Type of Light Element Transformer (60/50 Hertz AC)			Full Voltage (60/50 Hertz AC or DC)		
		Voltage	Lamp Number ②	Catalog Number	Voltage	Lamp Number ②	Catalog Number
	Momentary	120	6PSB	<b>E30EA</b>	24	24PSB	<b>E30EX3</b>
					120	120PSB	<b>E30EF</b>
	Momentary with interlock	120	6PSB	<b>E30EG</b>	24	24PSB	<b>E30EX13</b>
					120	120PSB	<b>E30EM</b>

#### Two Button Operator with Dual Indicating Lights



Shown with Button and Lens

#### Two Button Operator with Dual Indicating Lights/without Buttons and Lens

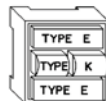
Button and Lens Types Required ①	Button Operation	Type of Light Element Transformer (60/50 Hertz AC)			Full Voltage (60/50 Hertz AC or DC)		
		Voltage	Lamp Number ②	Catalog Number	Voltage	Lamp Number ②	Catalog Number
	Momentary	120	6PSB	<b>E30JA</b>	24	24PSB	<b>E30JX3</b>
		120	120PSB	<b>E30JF</b>			

#### Notes

- ① Order from tables on **Pages V7-T1-179 to V7-T1-183.**
- ② Light units will also accept LED lamps. For LED part numbers, see table on **Page V7-T1-189.**
- ③ Operators are supplied as standard with red extended release bar(s) marked "OFF" as shown in sketch. For other colors or markings, contact your nearest Eaton Distributor or call our Customer Service Center 1-800-356-1243. For replacement of standard red release bar, order **E30KR101.**
- ④ Order from tables on **Pages V7-T1-181 and V7-T1-182.**

### Operator Components

#### Operating Buttons Only

##### Type A Extended Button

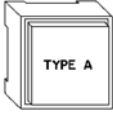

##### Type A Buttons with Standard Markings <sup>①</sup>

Button Application	Color	Marking	Extended Button Catalog Number	Short Button Catalog Number	Color	Marking	Extended Button Catalog Number	Short Button Catalog Number
	Black	Blank	E30KA100	E30KA150	Green	START	E30KA330	E30KA380
		START	—	E30KA180	Yellow	Blank	E30KA400	E30KA450
	Red	Blank	E30KA200	E30KA250	White	Blank	E30KA500	E30KA550
		EMERG. STOP	E30KA204	—	Gray	Blank	E30KA600	E30KA650
		OFF	E30KA218	E30KA268	Brown	Blank	E30KA700	E30KA750
		STOP	E30KA231	E30KA281	Orange	Blank	E30KA800	E30KA950
	Green	Blank	E30KA300	E30KA350	Blue	Blank	E30KA900	E30KA950

##### Type B Extended Button

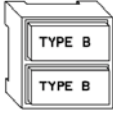

##### Type B Buttons with Standard Markings <sup>②</sup>

Button Application	Color	Marking	Extended Button Catalog Number	Short Button Catalog Number	Color	Marking	Extended Button Catalog Number	Short Button Catalog Number	
	Black	Blank	E30KB100	E30KB150	Black	REVERSE	E30KB125	E30KB175	
		AUTO	E30KB101	E30KB151		RUN	E30KB126	E30KB176	
		CLOSE	E30KB102	E30KB152		SLOW	E30KB128	E30KB178	
		DOWN	E30KB103	E30KB153		START	E30KB130	E30KB180	
		FAST	E30KB105	E30KB155		TEST	E30KB132	E30KB182	
		FORWARD	E30KB107	E30KB157		UP	E30KB134	E30KB184	
		HIGH	E30KB109	E30KB159	Red	Blank	E30KB200	E30KB250	
		IN	E30KB110	E30KB160		EMERG. STOP	E30KB204	—	
		INCH	E30KB111	E30KB161		OFF	E30KB218	E30KB268	
		JOG	E30KB112	E30KB162		STOP	E30KB231	E30KB281	
		JOG FOR.	E30KB113	E30KB163		Green	Blank	E30KB300	E30KB350
		JOG REV.	E30KB114	E30KB164			START	E30KB330	E30KB380
		LOW	E30KB115	E30KB165	Yellow	Blank	E30KB400	E30KB450	
		LOWER	E30KB116	E30KB166		White	Blank	E30KB500	E30KB550
		MAN	E30KB117	E30KB167	AUTO		E30KB501	—	
		ON	E30KB119	E30KB169	HAND	E30KB508	—		
OPEN	E30KB120	E30KB170	Gray	Blank	E30KB600	E30KB650			
OUT	E30KB121	E30KB171		Brown	Blank	E30KB700	E30KB750		
RAISE	E30KB122	E30KB172			Orange	Blank	E30KB800	E30KB850	
RESET	E30KB124	E30KB174		Blue		Blank	E30KB900	E30KB950	

#### Notes

- ① Use with operator E30AA, legend characters 3/16 in (4.8 mm) high.
- ② Use with operators E30AB thru AE, AL and DA thru DF, legend characters 3/16 in (4.8 mm) high.



1

## Type C Extended Button

Type C Buttons with Standard Markings <sup>Ⓢ</sup>

Button Application	Color	Marking	Extended Button Catalog Number	Short Button Catalog Number	Color	Marking	Extended Button Catalog Number	Short Button Catalog Number	
	Black	Blank	<b>E30KC100</b>	<b>E30KC150</b>	Black	RESET	<b>E30KC124</b>	<b>E30KC174</b>	
		AUTO	<b>E30KC101</b>	<b>E30KC151</b>		REVERSE	<b>E30KC125</b>	<b>E30KC175</b>	
		CLOSE	<b>E30KC102</b>	<b>E30KC152</b>		RUN	<b>E30KC126</b>	<b>E30KC176</b>	
		DOWN	<b>E30KC103</b>	<b>E30KC153</b>		SLOW	<b>E30KC128</b>	<b>E30KC178</b>	
		FAST	<b>E30KC105</b>	<b>E30KC155</b>		START	<b>E30KC130</b>	<b>E30KC180</b>	
		FORWARD	<b>E30KC107</b>	<b>E30KC157</b>		TEST	<b>E30KC132</b>	<b>E30KC182</b>	
		HAND	<b>E30KC108</b>	<b>E30KC158</b>		UP	<b>E30KC134</b>	<b>E30KC184</b>	
		HIGH	<b>E30KC109</b>	<b>E30KC159</b>		Red	Blank	<b>E30KC200</b>	<b>E30KC250</b>
		IN	<b>E30KC110</b>	<b>E30KC160</b>			OFF	<b>E30KC218</b>	—
		INCH	<b>E30KC111</b>	<b>E30KC161</b>			STOP	<b>E30KC231</b>	<b>E30KC281</b>
		JOG	<b>E30KC112</b>	<b>E30KC162</b>		Green	Blank	<b>E30KC300</b>	<b>E30KC350</b>
		JOG FOR.	<b>E30KC113</b>	<b>E30KC163</b>			START	<b>E30KC330</b>	<b>E30KC380</b>
		JOG REV.	<b>E30KC114</b>	<b>E30KC164</b>		Yellow	Blank	<b>E30KC400</b>	<b>E30KC450</b>
		LOW	<b>E30KC115</b>	<b>E30KC165</b>			White	Blank	<b>E30KC500</b>
LOWER	<b>E30KC116</b>	<b>E30KC166</b>	Gray	Blank	<b>E30KC600</b>	<b>E30KC650</b>			
MAN	<b>E30KC117</b>	<b>E30KC167</b>	Brown	Blank	<b>E30KC700</b>	<b>E30KC750</b>			
ON	<b>E30KC119</b>	<b>E30KC169</b>		Orange	Blank	<b>E30KC800</b>	<b>E30KC850</b>		
OPEN	<b>E30KC120</b>	<b>E30KC170</b>	Blue	Blank	<b>E30KC900</b>	<b>E30KC950</b>			
OUT	<b>E30KC121</b>	<b>E30KC171</b>							
RAISE	<b>E30KC122</b>	<b>E30KC172</b>							

**Note**

<sup>Ⓢ</sup> Use with operators E30AF thru AK, AL thru AM and DG thru DM, legend characters 1/8 in (3.2 mm) high.

### Operating Buttons and Lens Only

#### Standard Color Buttons and Lens Marking ①

**Black lettering** on — White, Amber, Yellow and Clear.

**White lettering** on — Green, Red, Blue, Brown, Black, Orange and Gray.

#### Type E Button

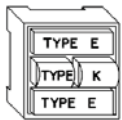

#### Type E Buttons with Standard Markings ②

Button Application	Color	Marking	Extended Button Catalog Number	Color	Marking	Extended Button Catalog Number	
	Black	Blank	<b>E30KE100</b>	Black	RESET	<b>E30KE124</b>	
		CLOSE	<b>E30KE102</b>		REVERSE	<b>E30KE125</b>	
		DOWN	<b>E30KE103</b>		RUN	<b>E30KE126</b>	
		FAST	<b>E30KE105</b>		SLOW	<b>E30KE128</b>	
		FORWARD	<b>E30KE107</b>		START	<b>E30KE130</b>	
		HIGH	<b>E30KE109</b>		TEST	<b>E30KE132</b>	
		IN	<b>E30KE110</b>		UP	<b>E30KE134</b>	
		INCH	<b>E30KE111</b>		Red	Blank	<b>E30KE200</b>
		JOG	<b>E30KE112</b>			OFF	<b>E30KE218</b>
		JOG FOR.	<b>E30KE113</b>			STOP	<b>E30KE231</b>
		JOG REV.	<b>E30KE114</b>		Green	Blank	<b>E30KE300</b>
		LOW	<b>E30KE115</b>			START	<b>E30KE330</b>
		LOWER	<b>E30KE116</b>		Yellow	Blank	<b>E30KE400</b>
		ON	<b>E30KE119</b>		White	Blank	<b>E30KE500</b>
		OPEN	<b>E30KE120</b>	Gray	Blank	<b>E30KE600</b>	
		OUT	<b>E30KE121</b>	Brown	Blank	<b>E30KE700</b>	
PHASE	<b>E30KE122</b>	Orange	Blank	<b>E30KE800</b>			
		Blue	Blank	<b>E30KE900</b>			

#### Type F Lens

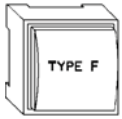

#### Type F Lenses with Standard Markings ③

Button Application	Color	Marking	Catalog Number	Color	Marking	Catalog Number	
	Red	Blank	<b>E30KF10</b>	Green	OFF	<b>E30KF22</b>	
		MOTOR RUN	<b>E30KF11</b>		Amber	Blank	<b>E30KF30</b>
		ON	<b>E30KF12</b>			Blue	Blank
		POWER ON	<b>E30KF13</b>		Clear		Blank
	Green	Blank	<b>E30KF20</b>			White	Blank
		MOTOR STOP	<b>E30KF21</b>				
MOTOR RUN		<b>E30KF23</b>					

#### Notes

- ① For lenses with special markings or with standard markings but in a different color, refer to instructions on **Pages V7-T1-186 to V7-T1-188.**
- ② Use with operators E30EA thru EM, FA thru FM and JA thru JM, legend characters 1/8 in (3.2 mm) high.
- ③ Use with operators E30BA thru BY, legend characters 3/16 in (4.8 mm) high.

#### Operating Lens Only

#### Standard Color Buttons and Lens Marking ①

**Black lettering** on — White, Amber, Yellow and Clear.

**White lettering** on — Green, Red, Blue, Brown, Black, Orange and Gray.

#### Type G Lens



#### Type G Lenses with Standard Markings ②

Lens Application	Color	Marking	Catalog Number	Color	Marking	Catalog Number
	Red	Blank	<b>E30KG10</b>	Green	OFF	<b>E30KG22</b>
		MOTOR RUN	<b>E30KG11</b>		READY	<b>E30KG23</b>
		ON	<b>E30KG12</b>	Amber	Blank	<b>E30KG30</b>
		POWER ON	<b>E30KG13</b>		Blue	Blank
Green	Blank	<b>E30KG20</b>	Clear	Blank	<b>E30KG50</b>	
	MOTOR RUN	<b>E30KG24</b>	White	Blank	<b>E30KG60</b>	
	MOTOR STOP	<b>E30KG21</b>				

#### Type J Lens



#### Type J Lenses with Standard Markings ③

Lens Application	Color	Marking	Catalog Number	Color	Marking	Catalog Number	
	Red	Blank	<b>E30KJ10</b>	Green	OFF	<b>E30KJ22</b>	
		MOTOR RUN	<b>E30KJ11</b>		ON	<b>E30KJ24</b>	
		ON	<b>E30KJ12</b>	Amber	Blank	<b>E30KJ30</b>	
		POWER ON	<b>E30KJ13</b>		Blue	Blank	<b>E30KJ40</b>
		MOTOR STOP	<b>E30KJ14</b>		Clear	Blank	<b>E30KJ50</b>
Green	Blank	<b>E30KJ20</b>	White	Blank	<b>E30KJ60</b>		
	MOTOR STOP	<b>E30KJ21</b>					
	MOTOR RUN	<b>E30KJ23</b>					

#### Type K Lenses



#### Type K Lenses with Standard Markings (Sold in Pairs Only) ④

Lens Application	Color		Marking		Catalog Number
	Left Hand Lens	Right Hand Lens	Left Hand Lens	Right Hand Lens	
	Red	Red	ON	ON	<b>E30KK12</b>
		Green	ON	OFF	<b>E30KK13</b>
	Green	Green	OFF	OFF	<b>E30KK22</b>
		Red	OFF	ON	<b>E30KK23</b>

#### Notes

- ① For lenses with special markings or with standard markings but in a different color, refer to instructions on **Pages V7-T1-186 to V7-T1-188**.
- ② Use with operators E30CA thru CM and DA thru DM, legend characters 3/16 in (4.8 mm) high except MOTOR RUN, POWER ON and MOTOR STOP are 1/8 in (3.2 mm) high.
- ③ Use with operators E30EA thru EM, FA thru FM and GA thru GM, legend characters 1/8 in (3.2 mm) high.
- ④ Use with operators E30JA thru JW, legend characters 1/8 in (3.2 mm) high.

**Type K Lenses**



**Type K Lenses—Blank (Sold in Pairs Only)**

Color			Color		
Left Hand Lens	Right Hand Lens	Catalog Number	Left Hand Lens	Right Hand Lens	Catalog Number
Red	Red	<b>E30KK10</b>	Blue	Red	<b>E30KK41</b>
	Green	<b>E30KK11</b>		Green	<b>E30KK42</b>
	Amber	<b>E30KK17</b>		Amber	<b>E30KK43</b>
	Blue	<b>E30KK14</b>		Blue	<b>E30KK40</b>
	Clear	<b>E30KK15</b>		Clear	<b>E30KK45</b>
	White	<b>E30KK16</b>		White	<b>E30KK46</b>
Green	Red	<b>E30KK21</b>	Clear	Red	<b>E30KK51</b>
	Green	<b>E30KK20</b>		Green	<b>E30KK52</b>
	Amber	<b>E30KK27</b>		Amber	<b>E30KK53</b>
	Blue	<b>E30KK24</b>		Blue	<b>E30KK54</b>
	Clear	<b>E30KK25</b>		Clear	<b>E30KK50</b>
	White	<b>E30KK26</b>		White	<b>E30KK56</b>
Amber	Red	<b>E30KK31</b>	White	Red	<b>E30KK61</b>
	Green	<b>E30KK32</b>		Green	<b>E30KK62</b>
	Amber	<b>E30KK30</b>		Amber	<b>E30KK63</b>
	Blue	<b>E30KK34</b>		Blue	<b>E30KK64</b>
	Clear	<b>E30KK35</b>		Clear	<b>E30KK65</b>
	White	<b>E30KK36</b>		White	<b>E30KK60</b>

#### Contact Blocks

**Standard Contact Blocks**—Molded, phenolic construction. Enclosed silver contacts with reliability “nibs” that improve the reliability of switching performance under dry circuit, corrosive atmosphere and fine dust conditions. For more extreme conditions, the logic level contact blocks described below are recommended.

**Logic Level Contact Blocks**—Feature palladium contacts. Palladium, which is more inert than gold, is well suited for voltages and currents approaching zero. When mounted in an enclosure rated for highly corrosive environments, logic level contact blocks can be used where exposure to chemicals may cause failure to other types of materials.

#### Mounting Limitations

See the contact block mounting limitations for Type E30 pushbutton and combination pushbutton and light operators on this page. Mounting positions 1 thru 8 indicate single depth contact blocks. Each of these positions can represent either a single circuit 600 volt block or a two-circuit 120 volt block. The two-circuit 600 volt block requires two of the numbered positions shown.

#### Mounting Positions

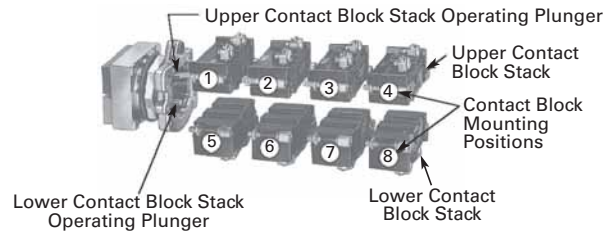

Catalog Number of Operator	Contact Blocks Can Be Mounted in Positions Listed Below	
	Upper Stack	Lower Stack
E30AA thru E30AM <sup>①</sup>	1-2-3-4	5-6-7-8
E30BA thru E30CM	None	None
E30DA thru E30DM	None	5-6-7-8
E30EA thru E30GM	2-3-4	6-7-8
E30JA thru E30JM	3-4	7-8

#### Contact Block Type <sup>②</sup> Contact Block Selection

##### Single Circuit, Screw Terminals



##### Two Circuit, Screw Terminals



##### Two Circuit, Quick Connect Terminals



##### 120 Vac Only—Two Circuit













Circuit	Pressure Terminals Standard Catalog Number	Logic Level Catalog Number	Quick Connect Terminals <sup>③</sup> Standard Catalog Number
1NO	<b>600 Vac, 250 Vdc—Single Circuit</b>		
	E30KLA1	E30KLAE1	E30KLB1
1NC	E30KLA2	E30KLAE2	E30KLB2
1NO-1NC	<b>600 Vac, 250 Vdc—Two Circuit</b>		
	E30KLA3	E30KLAE3	E30KLB3
2NO	E30KLA4	E30KLAE4	E30KLB4
2NC	E30KLA5	E30KLAE5	E30KLB5
<b>Special Contact Operation</b>			
1NO-1NC Overlapping	E30KLA6 <sup>④</sup>	—	E30KLB6 <sup>④</sup>
2NO (One early closing)	E30KLA7 <sup>④</sup>	—	E30KLB7 <sup>④</sup>
2NC (One late opening)	E30KLA8	—	E30KLB8
1NO-1NC	<b>120 Vac Only—Two Circuit</b>		
	E30KLA9 <sup>⑤</sup>	—	E30KLB9 <sup>⑤</sup>

#### Notes

- ① Except operator E30AD, AJ or AK which will accommodate contact blocks 1, 2, 5 and 6 only. (See Mounting Positions above.)
- ② Individually boxed contact blocks master packed 10 per carton.
- ③ Supplied with non-stacking screws. Limited to 2 contact blocks mounted in positions 1 and 5.
- ④ Do not use with maintained operators.
- ⑤ Contacts must be same polarity.

### Accessories

#### Accessories

	Description	Color/Type	Catalog Number
<b>E30KR_</b> 	<b>Collar</b> —Snap on mounting for assembly in the field. Permits color coding of operator heads. Size: 1-19/32 x 1-19/32 x 9/16 in.	Black	<b>E30KR1</b>
		Red	<b>E30KR2</b>
		Green	<b>E30KR3</b>
		Yellow	<b>E30KR4</b>
		White	<b>E30KR5</b>
		Gray	<b>E30KR6</b>
		Orange	<b>E30KR8</b>
		Blue	<b>E30KR9</b>
		Brown	<b>E30KR10</b>
		<b>E30KT_</b>  Full Shroud  Half Shroud	<b>Shroud</b> —Similar to collar above except for extension above the face of button to prevent accidental actuation of button. Half shroud with an extension on only half the collar may be positioned to protect top or bottom button.
Half shroud (gray)	<b>E30KT7</b>		
<b>E30KR3_</b> 	<b>Guard</b> —Two collars deep, removable slide prevents accidental operation. White slide can be marked with grease pencil.	Red with white slide	<b>E30KR31</b>
		Red with clear slide	<b>E30KR32</b>
<b>E30KR30</b> 	<b>Terminal Block</b> —2 terminals, each will accommodate 2-wire terminations.		<b>E30KR30</b>
<b>E30KT_</b> 	<b>Padlock Attachment</b> for locking single button and bottom button of multi-function operators in the depressed position. Locks NC contacts open or early closing NO contacts closed. Cannot be used in conjunction with collar, shroud or boot.	Short button	<b>E30KT1</b>
		Extended button	<b>E30KT2</b>
<b>E30KT3</b> 	<b>Transparent Boot</b> —Guards against ingress of foreign material and freezing rain. <b>Note:</b> If this boot is used in conjunction with operator types AD or AE, an extended type button must be used in the top position and a short button in the lower position.		<b>E30KT3</b> ①
<b>E30KT_</b> 	<b>Square Hole Plug</b> —	Gray enameled	<b>E30KT4</b>
		Stainless steel	<b>E30KT5</b>
<b>E30KV1</b> 	<b>Lamp and Lens Removal Tool</b> —Will not fit Cat. No. E30B light units listed on <b>Page V7-T1-177</b> .		<b>E30KV1</b>
<b>E22CW</b> 	<b>Octagonal Wrench</b> for mounting operators to panel.		<b>E22CW</b>
<b>E30KV2</b> 	<b>Button and Lens Removal Tool</b>		<b>E30KV2</b>

**Note**

① Color coordinating collars, padlock attachments or legend plates cannot be used with operators equipped with a transparent boot.

# 1

## Options

### Markings and Legend Plates

#### Buttons or Lenses with Non-Standard Horizontal Markings

Markings not listed as Standard Markings below are considered non-standard. If more than one marking is required on a button or lens, order non-standard markings.

#### Ordering Instructions

- Specify catalog number of blank button or lens of desired color, plus suffix "STAMP" for non-standard or "STD" for standard markings in order notes. See **Pages V7-T1-179 to V7-T1-183**.
- Specify size, legend desired and location in order notes by alphas as shown in example.
- Do not exceed maximum number of legend characters per line.

#### Ordering Example

Green Type B button to be marked with non-standard legend "ALL ELEVATORS DOWN."

Catalog No.: **E30KB300STAMP**  
 Letter Size: 1/8 in  
 Pos. A—ALL  
 Pos. C—ELEVATORS  
 Pos. F—DOWN

#### How to Use the Legend Location Figure

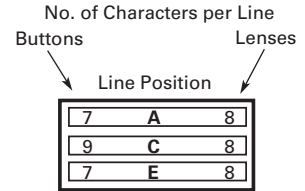

### Legend Locations

Type A buttons and Type F lenses

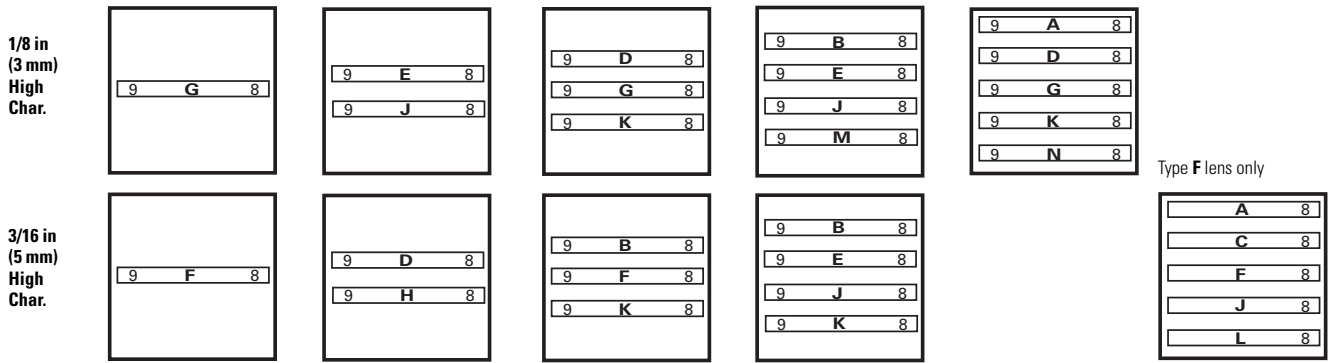

Type B buttons and Type G lenses

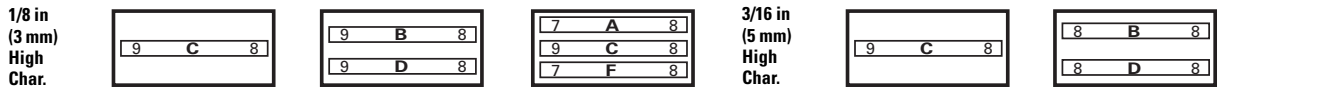

Type C buttons

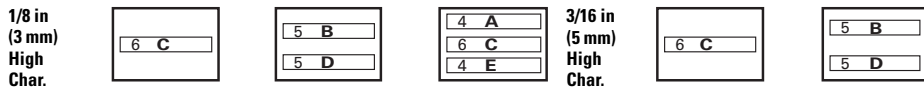

Type D buttons

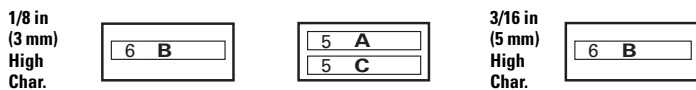

Type K buttons

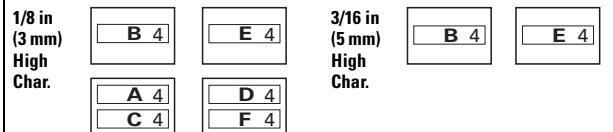

Type E buttons and Type J lenses

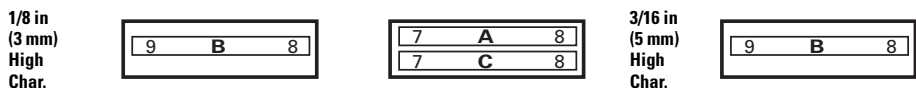

### Standard Markings

AUTO	EMERG. STOP	HAND	INCH	JOG REV.	MAN.	OPEN	RESET	SLOW	TEST	MOTOR STOP
CLOSE	FAST	HIGH	JOG	LOW	OFF	OUT	REVERSE	START	UP	POWER ON
DOWN	FORWARD	IN	JOG FOR.	LOWER	ON	RAISE	RUN	STOP	MOTOR RUN	READY

### Legend Arrangements and Legend Locations

Legend plates  
E30KM1 or KM11

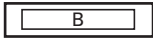

Legend plates  
E30KM4 or KM14

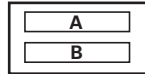

Legend plates  
E30KM3 or KM13

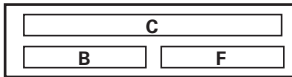
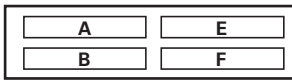
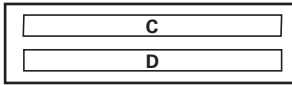

Legend plates  
E30KM5 or KM15

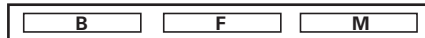
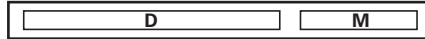
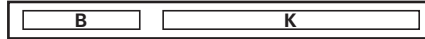
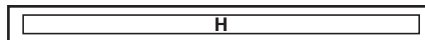

Legend plates  
E30KM2 or KM12

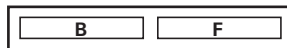
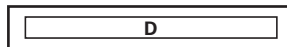

Legend plates  
E30KM6 or KM16

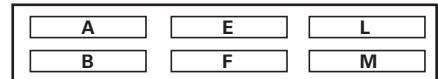
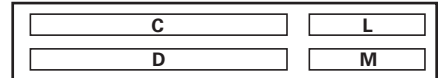
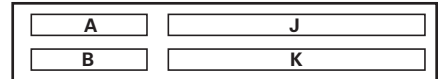
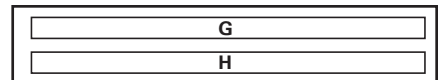

### Legend Plates E30KN76 or KN76B

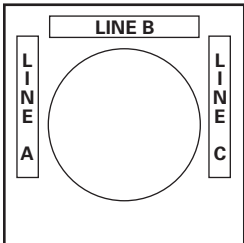

Legend plates  
E30KN76 or KN76B  
1/8 in character  
size only with a maximum  
of six characters.

### Maximum Number and Size of Permissible Legend Characters of Custom Stamped Legend Plates

Type	No. of Lines	Size and Maximum Number of Characters Per Line								
		One Span			Two Span			Three Span		
		3/32 in (2.5 mm)	1/8 in (3 mm)	3/16 in (5 mm)	3/32 in (2.5 mm)	1/8 in (3 mm)	3/16 in (5 mm)	3/32 in (2.5 mm)	1/8 in (3 mm)	3/16 in (5 mm)
Standard	1	13	10	10	30	22	22	47	34	34
Large	1	13	10	10	30	23	23	47	36	36
	2	13	10	10	30	23	23	47	36	36

Characters available for non-standard markings  
3/32 in (2.5 mm)—1/8 in (3 mm)—3/16 in (5 mm)

<b>A B C D E F G H I J K L M N O P Q R S T U V W X Y Z</b>	<b>. / — ,</b>	<b>1 2 3 4 5 6 7 8 9 0</b>
--	----------------	----------------------------



#### 1 Buttons or Lenses with Non-Standard Vertical Markings

##### Ordering Instructions

- Specify catalog number of blank button or lens of desired color, selected from listings on **Pages V7-T1-179 to V7-T1-183**.
- Specify size, legend desired, location and state “vertically marked” in order notes.

**Note:** Specify either 1/8 or 3/16 in (3.2 or 4.8 mm) character height. Do not exceed maximum number of characters as outlined in table below.

##### Ordering Example:

Green Type K button to be marked with “RUN” “ON.”

Catalog No.: **E30KK20STAMP**  
 Letter Size: 3/16 in (4.8 mm)  
 Vertically Marked  
 Pos. B—RUN  
 Pos. E—ON

##### Maximum Number of Characters

Description	Type	Maximum Number of Characters	
		1/8 in (3.2 mm)	3/16 in (4.8 mm)
Buttons	A	7	5
	B	7	5
	C	4	3
	D	5	3
	E	7	5
Lenses	F	7	5
	G	7	5
	J	7	5
	K	3	2

##### Legend Plates

Legend plates for Type E30 compact pushbutton and indicating light operators hook directly onto the operator and are clamped in place when the operator locking nut behind the panel is secured.

Two and three span plates are designed for use where two or more operators are mounted adjacent to each other **on minimum horizontal mounting centers**. These legend plates mount in the same manner as single span units.

##### When Ordering Legend Plates with Markings



- Catalog number of blank legend plate
- Insert the following in order notes:
  - Legends required
  - Size of characters—3/32, 1/8, 3/16 in (2.4, 3.2, 4.8 mm)
  - Positions of legends on one line standard and two line large legend plates by alphas as shown in sketches on following page.

##### Ordering Example:

Three span legend plate to be marked “MASTER CONTROL”, “STATION A” and “STATION B.”

Catalog No.: **E30KM3STAMP**  
 Letter Size: 1/8 in (3.2 mm)  
 Pos. C—MASTER CONTROL  
 Pos. B—STATION A  
 Pos. F—STATION B

##### Blank Legend Plates and Legend Plates with Markings

Type	One Span Catalog Number
<b>Black</b>	
<b>Standard—One Span</b> 	Standard <b>E30KM1</b>
<b>Large—One Span</b> 	Large <b>E30KM4</b>

**Replacement Parts**

**Replacement Light Units for E30 Components**

Voltage AC and DC	Part Numbers—Receptacles without Lamps				
	Single Indicating Light	Dual Indicating Light	Single Light Single Pushbutton	Single Light Dual Pushbutton	Dual Light Dual Pushbutton
<b>Full Voltage Type</b>					
6V	57-2579-3A	57-2568A	57-2568A	57-2579-3A	57-2567
12V	57-2579-3A	57-2568A	57-2568A	57-2579-3A	57-2567
18/24V	57-2579-3A	57-2568A	57-2568A	57-2579-3A	57-2567
28V	57-2579-3A	57-2568A	57-2568A	57-2579-3A	57-2567
32V	57-2579-3A	57-2568-2A	57-2568-2A	—	57-2567
48V	57-2579-3A	57-2568A	57-2568A	57-2579-3A	57-2567
120V	57-2579-3A	57-2568A	57-2568A	57-2579-3A	57-2567
<b>Transformer Type</b>					
120V	42-2672A	42-2663A	42-2663A	42-2671A	42-2664A
208V	42-2672-2A	42-2663-2A	42-2663-2A	42-2671-2A	42-2664-2A
240V	42-2672-3A	42-2663-3A	42-2663-3A	42-2671-3A	42-2664-3A
380V	42-2672-4A	42-2663-4A	42-2663-4A	42-2671-4A	42-2664-4A
480V	42-2672-5A	42-2663-5A	42-2663-5A	42-2671-5A	42-2664-5A
600V	42-2672-6A	42-2663-6A	42-2663-6A	42-2671-6A	42-2664-6A
<b>Description and Part Numbers—Related Parts</b>					
Inner lens	28-1008	28-1010	28-1010	28-1010	28-1010
Retaining nut	15-1885	15-1885	15-1885	15-1885	15-1885
Gasket	16-2092	16-2092	16-2092	16-2092	16-2092
Locking ring	52-1116	52-1116	52-1116	52-1116	52-1116

**Replacement Lamps for E30 Illuminated Operators**

Mfg. Lamp Type	Voltage	Base Style	Application	Part Number
6PSB	6V	T2 slide	E30 transformer and full voltage	28-1022
12PSB	12V	T2 slide	E30 full voltage	28-1025
24PSB	24V	T2 slide	E30 full voltage	28-1026
28PSB	28V	T2 slide	E30 full voltage	28-1027
48PSB	48V	T2 slide	E30 full voltage	28-1028
60PSB	60V	T2 slide	E30 full voltage	28-1598
120PSB	120V	T2 slide	E30 full voltage	28-1029
#259	6.3V	T3-1/4 wedge	E30 single transformer	28-949

**Replacement Lamps—Incandescent and LED**

Lamp Voltage	Incandescent Lamps			LED Lamps			
	Manufacturer's Part Number	Base Style	Eaton's Part Number	Eaton's Part Number			
				Red	Green	Yellow	Blue ①
6	6PSB	T2 slide	28-1022	35-1523	35-1523-2	35-1523-3	35-1523-17
12	12PSB	T2 slide	28-1025	35-1523-11	35-1523-12	35-1523-13	35-1523-18
24	24PSB	T2 slide	28-1026	35-1523-4	35-1523-5	35-1523-6	35-1523-19
28	28PSB	T2 slide	28-1027	35-1523-4	35-1523-5	35-1523-6	35-1523-19
48	48PSB	T2 slide	28-1028	35-1523-14	35-1523-15	35-1523-16	35-1523-20
120	120PSB	T2 slide	28-1029	35-1523-7	35-1523-8	35-1523-9	35-1523-21

**Note**

① E30 blue LED bulbs may not provide sufficient intensity for some applications.

## Technical Data and Specifications

### Operator Specifications

Description	Specification
<b>Climate Conditions</b>	
Operating	−20° to 150°F (−29° to 65°C)
<b>Terminals</b>	
Light units	Terminals are saddle clamp type for 2 stranded or solid wires up to 12 AWG (4.0 mm <sup>2</sup> ) Torque—7 lb-in (0.8 Nm)
Contact block	Terminals are saddle clamp type for 2 stranded or solid wires up to 12 AWG (4.0 mm <sup>2</sup> ) Torque—7 lb-in (0.8 Nm)
<b>Materials</b>	
Operator	Zinc base die casting with a copper-nickel-chrome plated finish Withstands the 200 hr. salt spray test in accordance with MIL Spec. QQ-M-151A and NEMA 4X testing.
Internal parts	Including shafts, washers and springs, are made of stainless steel
Buttons and lenses	Colorfast, wear resistant, molded acetal resin
Contact blocks	Made of molded, heat resistant, mineral filled phenolic Contact block plungers are molded of nylon filled phenolic Contacts are silver
Reliability nibs	These nibs combine a scrubbing action with high pressure density when the contacts are closed They push through particles and films found on contact surfaces in industrial environments Reliability nibs self-adjust to the application—dry circuit, normal or heavy-duty

### Reliability Nibs

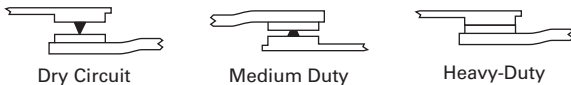

## Electrical Ratings

### Contact Blocks

#### Meet or Exceed NEMA Contact Rating Designation A600 and P300

Description	Vac A600				Vdc P300		
	120V	240V	480V	600V	24/28V	125V	250V
Make and emergency interrupting capacity (Amps)	60	30	15	12	5.73	1.1	0.55
Normal load break (Amps)	6	3	1.5	1.2	5.73	1.1	0.55
Continuous current (Amps)	10	10	10	10	5	5	5

- UL A600/P300 nominal connect 10A
- 1NO, 1NC, 2NO, 2NC, 1NO-1NC, early make, late break and overlapping configurations
- Mechanical positive drive operation on NC contacts
- Palladium alloy contact for logic level or highly corrosive environments

### Maximum Ratings for Logic Level and Hostile Atmosphere Application

Description	Specification
Maximum amperes	0.5A <sup>①</sup>
Maximum volts	120 Vac/Vdc

#### Note

<sup>①</sup> Logic level contact blocks are UL A600/P500 rated per table above.

### Light Unit

Description	Specification
<b>Bulbs—Average Life</b>	
Transformer type	20,000 hrs.
Resistor/direct voltage type	2,500 hrs. min. at rated voltage
LED	60,000 to 100,000 hrs.

Dimensions

Approximate Dimensions in Inches (mm)

Pushbutton Operators

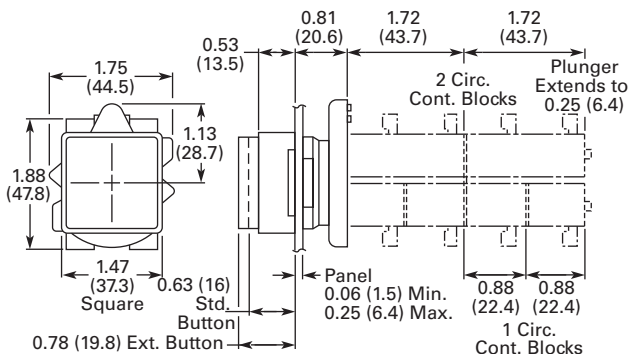

Combination Pushbutton and Indicating Light Operators

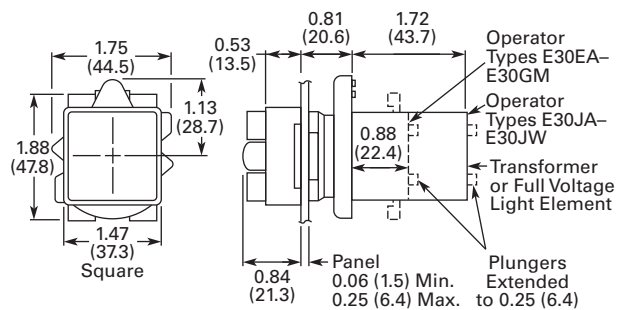

Combination Pushbutton and Indicating Light Operators

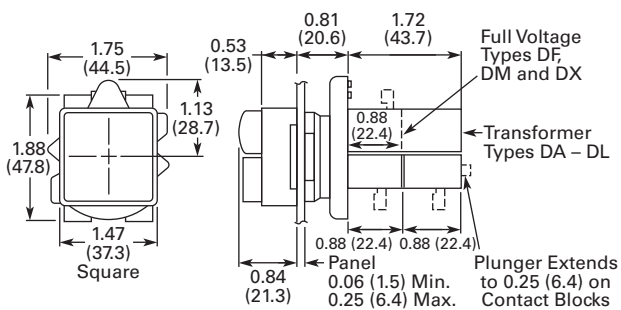

Indicating Light Operators

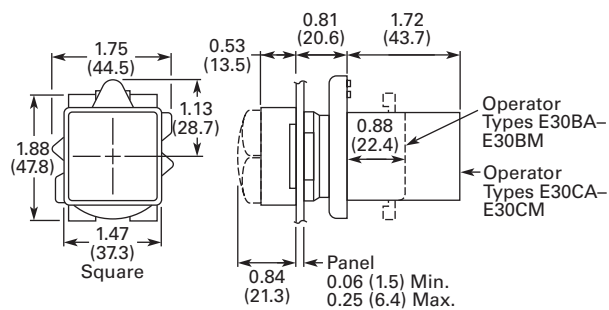

Padlocking Attachment and Half Shroud E30KT7

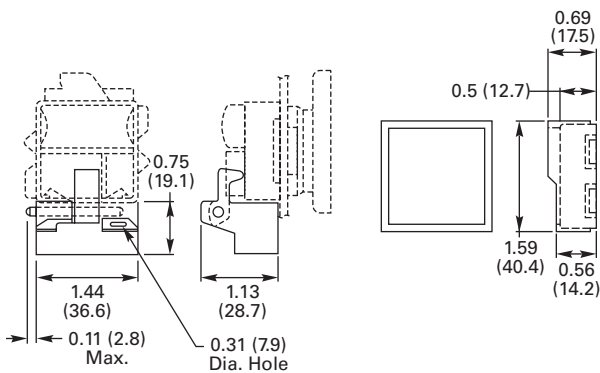

Drilling Dimensions—Minimum Spacing ①②

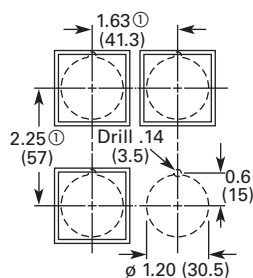

Notes

- ① Dimensions shown allow adequate space for the addition of one or two high legend plates and color coordinating collars.
- ② Locating nib hole or notch is 0.136 in (3.5 mm) drill. Alternate to drilling mounting holes use Greenlee Tool Co. punch (No. 730-S) to punch the hole and (No. 730-K) to punch the notch.

Legend Plates

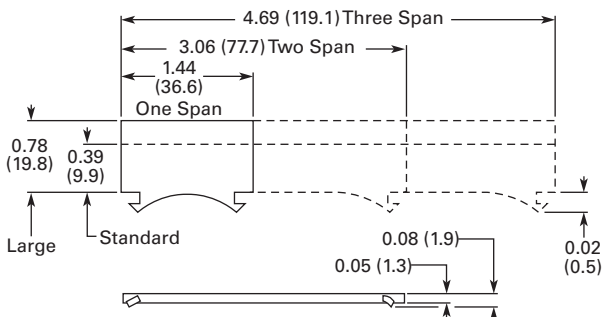



### Contents

<i>Description</i>	<i>Page</i>
30.5 mm Heavy-Duty Watertight/Oiltight—10250T	
Product Overview	V7-T1-193
Product Identification	V7-T1-193
Catalog Number Selection	V7-T1-194
Product Selection	
Point-of-Purchase Packaging	V7-T1-196
Non-Illuminated Momentary Pushbutton Units	V7-T1-197
Pushbuttons	V7-T1-198
Illuminated Momentary Pushbutton Units	V7-T1-202
Indicating Light Units	V7-T1-203
Illuminated Pushbuttons and Indicating Lights	V7-T1-204
Push-Pull Emergency Stop	V7-T1-206
Illuminated Push-Pull Units	V7-T1-209
Potentiometers	V7-T1-212
Push-Pull Operators	V7-T1-213
Selector Switch Units	V7-T1-217
Selector Switch Selection	V7-T1-218
Selector Switch Operators	V7-T1-221
Illuminated Selector Switch Operators	V7-T1-224
Joystick Units	V7-T1-225
Joysticks	V7-T1-226
Roto-Push Units	V7-T1-229
Roto-Push Operators	V7-T1-230
Accessories	V7-T1-235
Options	V7-T1-240
Replacement Parts	V7-T1-249
Technical Data and Specifications	V7-T1-251
Dimensions	V7-T1-254



Drawings  
Online

### Product Description

The 30.5 mm pushbutton line features a zinc die cast construction with chrome-plated housing and mounting nut. The same durable construction is also available with the corrosive resistant E34 line of pushbuttons. See E34 section on **Pages V7-T1-264 to V7-T1-298**.

### Features

- Heavy-duty zinc die cast construction
- Enclosed silver contacts with reliability nibs
- Diaphragm seals with drainage holes
- Grounding nibs on the operator casing

### Benefits

- Reliability nibs improve contact reliability even under dry circuit and fine dust conditions
- Drainage holes prevent buildup of liquid inside the operator which can prevent operation in freezing environments
- Grounding nibs bit through paint and other coatings to provide secure ground

### Application Description

#### Contact Operation

Slow make and break. All normally closed contacts have positive opening operation, i.e., normally closed contacts are forced open in the event of contact weld or spring breakage.

### Standards and Certifications

- CE EN 60947-5-1 and 60947-5-5
- UL 508—File No. 131568
- CSA C22.2 No. 14—File No. LR68551



### Ingress Protection

When mounted in similarly rated enclosure—

- Standard indicating lights
  - UL (NEMA) Type 1, 2, 3, 3R, 3S, 4, 4X, 12, 13
  - IEC IP65
- Most other operators
  - UL (NEMA) Type 1, 2, 3, 3R, 4, 4X, 12, 13
  - IEC IP65

**Product Overview**

**Reliability Nibs**

Eaton’s contact blocks feature enclosed silver contacts with pointed “reliability nibs” for reliable performance from logic level up to 600V. To ensure reliable switching, nibs bite through oxide which can form on silver contacts, eliminating the need for expensive logic level blocks for most applications.

**Reliability Nibs**

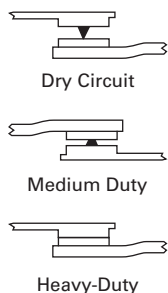

Reliability nibs improve performance in dry circuit, corrosive, fine dust and other contaminated atmospheres. Under normal environmental conditions, the minimum operational voltage is 5V and the minimum operational current is 1 mA, AC/DC. For operation under a wider range of environmental conditions, logic level contact blocks with inert palladium tipped contacts are recommended.

**Grounding Nibs**

10250T line operators have “grounding nibs”—four metal points on the operator casting designed to bite through most paints and other coatings on metal panels to enhance the ground connection when the operator is securely tightened.

**Grounding Nibs**



**Diaphragm Seal with Drainage Holes**

**Liquid Drainage**

Eaton’s pushbutton operators offer front of panel drainage via holes in the operator bushing. Hidden from view by the mounting nut, these holes prevent buildup of liquid inside the operator, which can prevent operation in freezing environments. The holes also provide a route for escaping liquid in high pressure washdowns, effectively relieving pressure from the internal diaphragm seal, ensuring reliable sealing in applications even beyond NEMA 4.

**Diaphragm Seal**

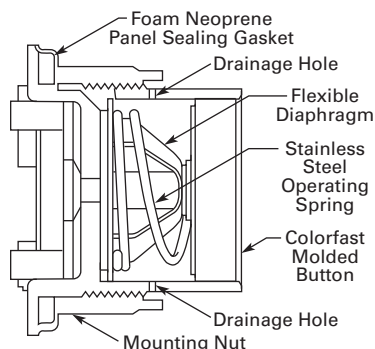

**Product Identification**

**30.5 mm Heavy-Duty Watertight/Oiltight—10250T Series**

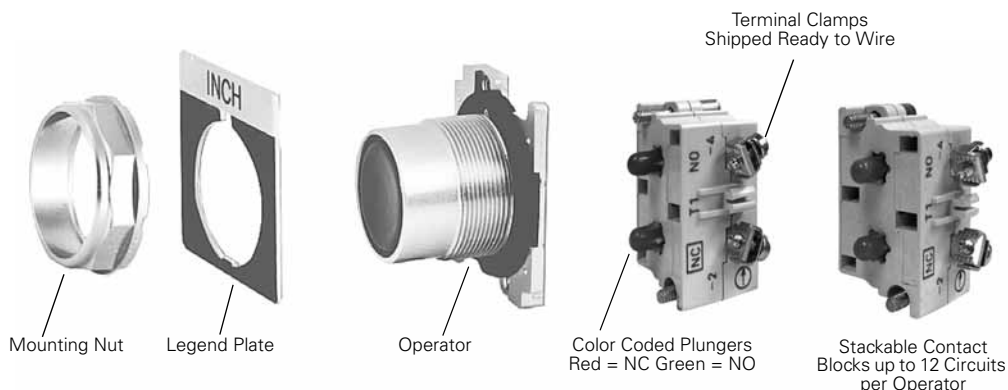

#### 1

### Catalog Number Selection

Catalog Number Selection is for illustrative purposes only and not to be used to create new catalog numbers.

#### Non-Illuminated Pushbuttons

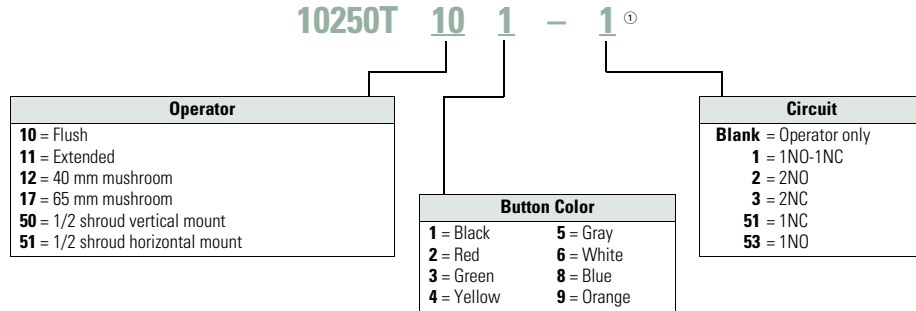

#### Illuminated and Non-Illuminated Push-Pulls

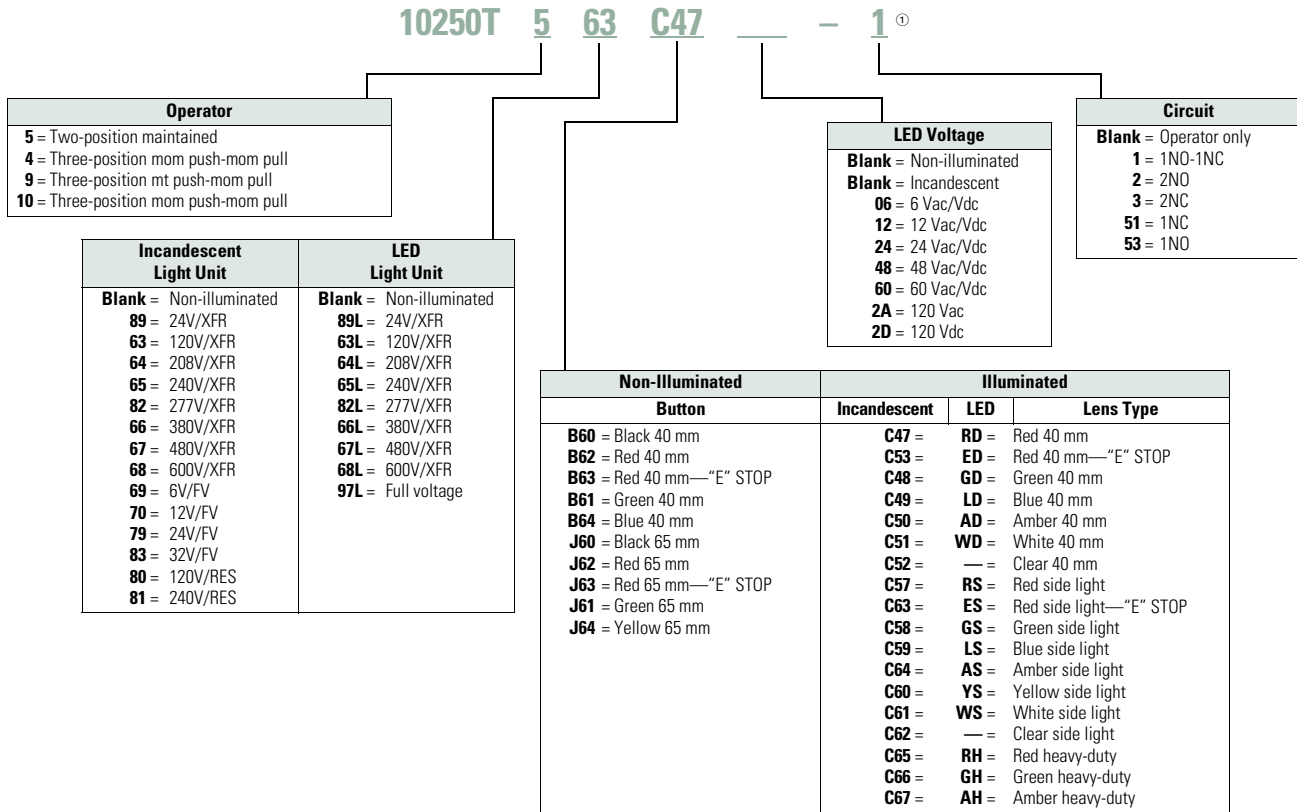

**Note**

① Add **X** at end of catalog number to receive parts assembled from factory.

Catalog Number Selection is for illustrative purposes only and not to be used to create new catalog numbers.

### Illuminated Pushbuttons

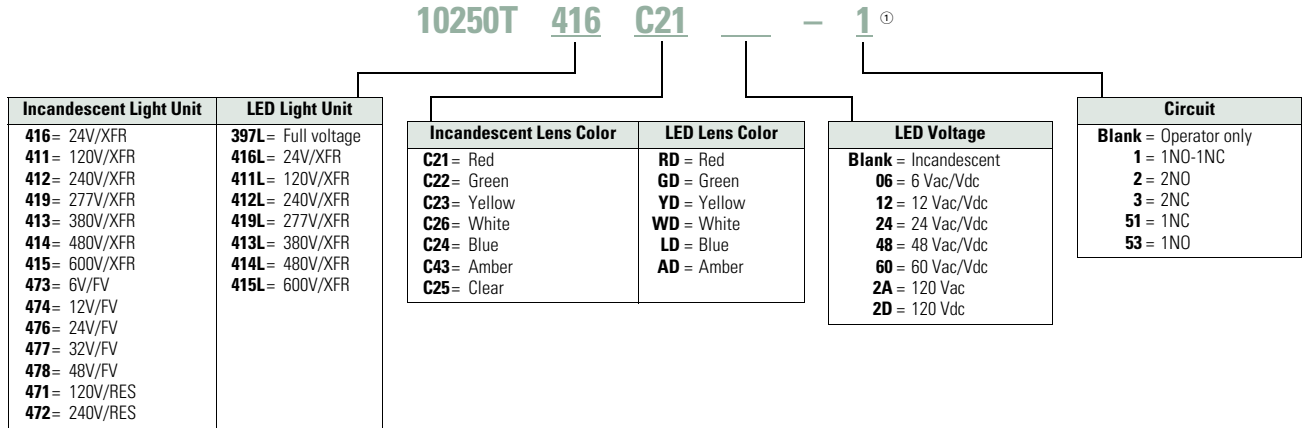

### Standard Indicating Lights, PresTest and Master Test

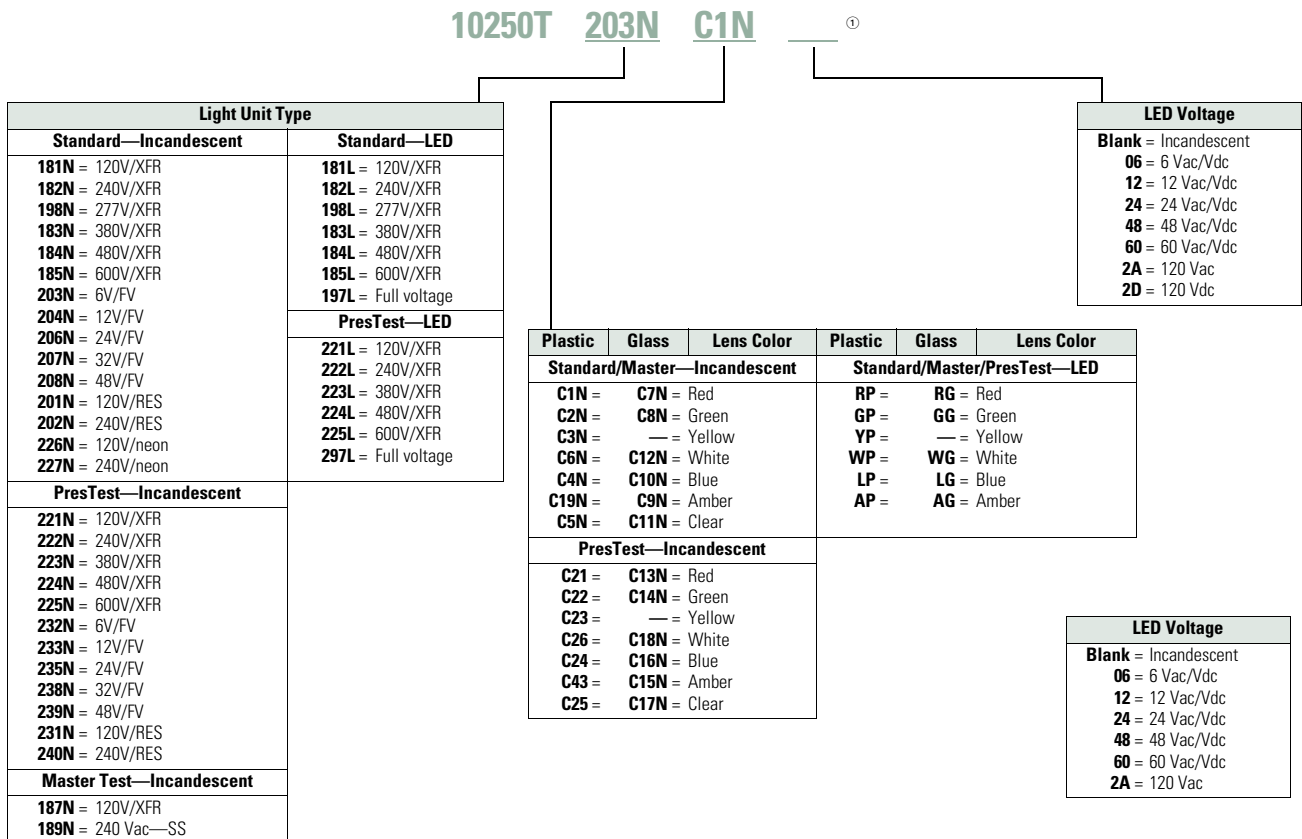

**Note**

① Add **X** at end of catalog number to receive parts assembled from factory.



## Product Selection

### Point-of-Purchase Packaging

#### Point-of-Purchase Packaged Pilot Device



#### 10250T Point-of-Purchase Packaged Pilot Devices

Product	Description	Catalog Number
<b>Emergency Stop Operators</b>		
Red non-illuminated push-pull	1NO-1NC contact block. Also includes two square engraved legend plates: EMERG. STOP and STOP.	<b>10250T5B62-1-POP</b>
Red mushroom pushbutton	1NO-1NC contact block. Also includes two square engraved legend plates: EMERG. STOP and STOP.	<b>10250T32R-POP</b>
Red jumbo mushroom pushbutton	Engraved EMERG. STOP with 1NO-1NC contact block.	<b>10250T33-POP</b>
<b>Momentary Pushbuttons</b>		
Black flush pushbutton	1NO-1NC contact block. Also includes two square engraved legend plates: START and JOG.	<b>10250T30B-POP</b>
Red extended pushbutton	1NO-1NC contact block. Also includes one square engraved legend plate: STOP.	<b>10250T31R-POP</b>
<b>Indicating Lights</b>		
Red indicating light	Full voltage 24 Vac/Vdc with two extra lenses: Green and amber. Also includes two square engraved legend plates: RUN and JOG.	<b>10250T206NC1N-POP</b>
Red indicating light	Resistor 120 Vac/Vdc with two extra lenses: Green and Amber. Also includes one square engraved legend plate: RUN and JOG.	<b>10250T34R-POP</b>
<b>Illuminated Pushbuttons</b>		
Red illuminating pushbutton	Full voltage 24 Vac/Vdc with 1NO-1NC contact block and two extra lenses: Green and amber. Also includes one square engraved legend plate: POWER ON.	<b>10250T476C21-1-POP</b>
Red illuminating pushbutton	Resistor 120 Vac/Vdc with 1NO-1NC contact block and two extra lenses: Green and amber. Also includes one square engraved legend plate: POWER ON.	<b>10250T411C21-1-POP</b>
<b>Selector Switches</b>		
Black knob two-position selector switch	1NO-1NC contact block. Also includes three square engraved legend plates: OFF/ON, HAND/AUTO and RUN/JOG.	<b>10250T20KB-POP</b>
Black knob three-position selector switch	2NO-2NC contact blocks. Also includes 1 square engraved legend plate: HAND/OFF/AUTO.	<b>10250T22KB-POP</b>
Black knob three-position selector switch	1NO-1NC contact block. Also includes legend plate: HAND/OFF/AUTO	<b>10250T21KB-POP</b>

### Non-Illuminated Momentary Pushbutton Units

UL (NEMA) Type 3, 3R, 4, 4X, 12, 13

#### Flush Button



#### Extended Button



#### Mushroom Button



#### Jumbo Mushroom



### Pushbutton Units—Flush, Extended, Mushroom Head or Jumbo Mushroom Head Operators

Contact Type	Button Color	Flush Button Catalog Number	Extended Button Catalog Number	Mushroom Button Catalog Number	Jumbo Mushroom <sup>①</sup> Catalog Number
1NO	Black	10250T23B	10250T25B	10250T26B	10250T27B
	Red	10250T23R	10250T112-53	10250T122-53	10250T172-53
	Green	10250T23G	10250T25G	10250T26G	10250T27G
	Yellow	10250T23Y	10250T25Y	10250T26Y	10250T27Y
	Red—Engraved EMERG. STOP	—	—	—	10250T17213-53
1NC	Black	10250T101-51	10250T111-51	10250T121-51	10250T171-51
	Red	10250T102-51	10250T25R	10250T26R	10250T27R
	Green	10250T103-51	10250T113-51	10250T123-51	10250T173-51
	Yellow	10250T104-51	10250T120-51	10250T124-51	10250T174-51
	Red—Engraved EMERG. STOP	—	—	—	10250T29
1NO-1NC	Black	10250T30B	10250T31B	10250T32B	10250T33B
	Red	10250T30R	10250T31R	10250T32R	10250T33R
	Green	10250T30G	10250T31G	10250T32G	10250T33G
	Yellow	10250T30Y	10250T31Y	10250T32Y	10250T33Y
	Red—Engraved EMERG. STOP	—	—	—	10250T33
2NO	Black	10250T101-2	10250T111-2	10250T121-2	10250T171-2
	Red	10250T102-2	10250T112-2	10250T122-2	10250T172-2
	Green	10250T103-2	10250T113-2	10250T123-2	10250T173-2
	Yellow	10250T104-2	10250T120-2	10250T124-2	10250T174-2
	Red—Engraved EMERG. STOP	—	—	—	10250T17213-2
2NC	Black	10250T101-3	10250T111-3	10250T121-3	10250T171-3
	Red	10250T102-3	10250T112-3	10250T122-3	10250T172-3
	Green	10250T103-3	10250T113-3	10250T123-3	10250T173-3
	Yellow	10250T104-3	10250T120-3	10250T124-3	10250T174-3
	Red—Engraved EMERG. STOP	—	—	—	10250T17213-3

**Note**







① Anodized aluminum head is not suitable for use in ultraviolet light applications.

# 1

## Pushbuttons

UL (NEMA) Type 3, 3R, 4, 4X, 12, 13

### Momentary Pushbutton Operators, Non-illuminated

Button	Color	Catalog Number		
<b>10250T10_</b> 	Flush button <sup>①</sup>	Black	<b>10250T101</b>	
		Red	<b>10250T102</b>	
		Green	<b>10250T103</b>	
		Yellow	<b>10250T104</b>	
		Gray	<b>10250T105</b>	
		White	<b>10250T106</b>	
		Blue	<b>10250T108</b>	
		Orange	<b>10250T109</b>	
<b>10250T11_</b> 	Extended button	Black	<b>10250T111</b>	
		Red	<b>10250T112</b>	
		Green	<b>10250T113</b>	
		Yellow	<b>10250T120</b>	
		White	<b>10250T116</b>	
		Blue	<b>10250T118</b>	
		Orange	<b>10250T119</b>	
	<b>10250T5_</b> 	Half shrouded button	<b>Vertical</b>	<b>Horizontal</b>
Black			<b>10250T501</b>	<b>10250T511</b>
		Red	<b>10250T502</b>	<b>10250T512</b>
		Green	<b>10250T503</b>	<b>10250T513</b>
		Yellow	<b>10250T504</b>	<b>10250T514</b>
		Gray	<b>10250T505</b>	<b>10250T515</b>
		White	<b>10250T506</b>	<b>10250T516</b>
		Blue	<b>10250T508</b>	<b>10250T518</b>
		Orange	<b>10250T509</b>	<b>10250T519</b>
<b>10250T12_</b> 		Mushroom button	Black	<b>10250T121</b>
	Red		<b>10250T122</b>	
	Green		<b>10250T123</b>	
	Yellow		<b>10250T124</b>	
	Blue		<b>10250T129</b>	
<b>10250T17_</b> 	Jumbo mushroom button <sup>②</sup>	Black	<b>10250T171</b>	
		Red	<b>10250T172</b>	
		Red (EMERG. STOP)	<b>10250T17213</b>	
		Green	<b>10250T173</b>	
		Yellow	<b>10250T174</b>	
<b>10250ED1164_</b> 	Low operating force—jumbo mushroom <sup>②③</sup>	Black	<b>10250ED1164-2</b>	
		Red	<b>10250ED1164-3</b>	
		Green	<b>10250ED1164-4</b>	
		Yellow	<b>10250ED1164-5</b>	
		Clear	<b>10250ED1164</b>	

**Note:** To order complete assembled unit using one composite catalog number, add contact block and legend plate suffix to the end of operator catalog number. Example: 10250T101-1TS33



**Operator**  
**10250T101**

+



**Contact Block**  
**10250T1**

+



**Legend Plate**  
**10250TS33**

#### Notes

- ① To order operator with factory assembled extended retaining nut, **10250TA12**, for thick panel applications, add suffix letter **E** to listed catalog number. Example: 10250T101**E**.
- ② Anodized aluminum head is not suitable for use in ultraviolet light applications.
- ③ Operating force—Standard = 2.4 lb; low force = 1.6 lb.

UL (NEMA) Type 3, 3R, 4, 4X, 12, 13

10250TA\_



### Mechanically Interlocked Pushbutton Operators

Description	Catalog Number
Black flush and green flush	10250TA66
Black flush and long red	10250TA67
Black flush and red mushroom head	10250TA68
Black flush and lock-down red mushroom head	10250TA69 <sup>①</sup>
Black flush and red jumbo mushroom head	10250TA76
Green flush and long red	10250TA72
Black long and long red	10250TA73
Green flush and red mushroom head	10250TA77
Green flush and black flush	10250TA75

**Note**

<sup>①</sup> NC contacts must be mounted behind lock-down mushroom head operator to ensure lockout.

**Lockout Pushbutton Operators with Padlock Attachments**

UL (NEMA) Type 3, 3R, 4, 4X, 12, 13

The following pushbutton and mushroom operators include an integral padlock attachment for applications requiring lockout/tagout of specific machine functions. They are available in styles which allow locking of a button in the down position

(stopped position) or locking a button in the up position (to prevent starting). Select the **“Hand”** latch type which functions as a momentary pushbutton until the operator presses the button and moves the padlock attachment into position for

locking, or choose the **“Spring Loaded”** latch type where the padlock attachment springs into place when the button is pressed. Units accept a customer supplied 1/4 in padlock.

**10250TA16****Padlockable in the Down Position** ①

Operator Type	Color	Latch Type	Catalog Number
Flush head	Red	Hand	<b>10250TA16</b>
Mushroom head	Red	Hand	<b>10250TA42</b>
	Red	Spring loaded	<b>10250TA45</b>
Jumbo head ②	Red	Hand	<b>10250TA52</b>
	Red	Spring loaded	<b>10250TA55</b>
	Red (EMERG. STOP)	Spring loaded	<b>10250ED952</b>

**Padlockable in the Up Position** ①**10250TA4\_**

Operator Type	Color	Latch Type	Catalog Number
Mushroom head	Black	Hand	<b>10250TA41</b>
	Green	Hand	<b>10250TA43</b>

**10250TA5\_**

Jumbo mushroom head ②	Black	Hand	<b>10250TA51</b>
	Green	Hand	<b>10250TA53</b>
	Yellow	Hand	<b>10250TA54</b>

**Notes**

Hand attachment must be manually moved into place for locking. Spring loaded: when operator is pressed—attachment springs into place. Must be moved manually to release button.

① Operators can be latched down without a padlock. Padlock not included.

② Jumbo mushroom heads are not recommended for use in applications where exposure to ultraviolet light exists.

**Key Pushbutton Operator**

UL (NEMA) Type 3, 3R, 4, 4X, 12, 13

These devices incorporate an integral locking mechanism which enables locking units in various positions (**Locked Down**), locking units to

prevent operation (**Locked Up**) or setting unit to lock when the button is pressed (**Push to Lock**), requiring the key to be inserted to return to

normal operation. With the key in the center position, these operators function as a normal momentary pushbutton (**Free**).

**Replacement Keys or Dissimilar Locks for Key Operators Below**

Listed operators have identical locks and keys (Key Code H661) Catalog Number 10250ED824. For dissimilar lock and key combinations, see listing on **Page V7-T1-222**.

**Replacement Keys**

Description	Catalog Number
Replacement keys (code H661)	10250ED824

10250T43



**Key Pushbutton Operator**

Key Position and Pushbutton Operations



Key Removal Positions

Vertical Mounting<sup>①</sup> Catalog Number

**Three-Position**

Lock up	Free	Lock down	All	10250T430
Lock up	Free	Lock down	L and R	10250T431
Lock up	Free	Lock down	C and R	10250T432

**Two-Position**

Lock up	Free	—	L and C	10250T433
Lock up	Free	—	L	10250T434
—	Free	Lock down	C and R	10250T435
—	Free	Lock down	R	10250T436
—	Free	Push to lock	C and R	10250T437
—	Free	Push to lock	R	10250T438

**Latch-In, Twist-to-Release Operator**

UL (NEMA) Type 3, 3R, 4, 4X, 12, 13

10250ED1043-4



**Operator Only with Button**

Description	Catalog Number
Latch-in, twist-to-release operator with red mushroom head button	10250ED1043-4

**Note**

① Horizontal mounting available on request.

## 1

**Illuminated Momentary Pushbutton Units**

UL (NEMA) Type 3, 3R, 4, 4X, 12, 13

- LED or incandescent
- Full voltage, resistor or transformer type
- Plastic lenses

**24V Full Voltage  
Illuminated Pushbutton****Illuminated Pushbutton Units**

Type	Voltage	Color	LED/Lamp Number	Illuminated Pushbutton				
				1NO Catalog Number	1NO-1NC Catalog Number	1NC Catalog Number		
<b>LED Lamp</b>								
Full voltage	24 Vac/Vdc	Red	Bayonet base	10250T397LRD24-53	10250T397LRD24-1	10250T397LRD24-51		
		Green		10250T397LGD24-53	10250T397LGD24-1	10250T397LGD24-51		
		Amber		10250T397LAD24-53	10250T397LAD24-1	10250T397LAD24-51		
		Yellow		10250T397LYD24-53	10250T397LYD24-1	10250T397LYD24-51		
		Blue		10250T397LLD24-53	10250T397LLD24-1	10250T397LLD24-51		
		White		10250T397LWD24-53	10250T397LWD24-1	10250T397LWD24-51		
		120 Vac/Vdc		Red	10250T397LRD2A-53	10250T397LRD2A-1	10250T397LRD2A-51	
				Green	10250T397LGD2A-53	10250T397LGD2A-1	10250T397LGD2A-51	
				Amber	10250T397LAD2A-53	10250T397LAD2A-1	10250T397LAD2A-51	
	Yellow		10250T397LYD2A-53	10250T397LYD2A-2	10250T397LYD2A-51			
	Blue		10250T397LLD2A-53	10250T397LLD2A-1	10250T397LLD2A-51			
	White		10250T397LWD2A-53	10250T397LWD2A-1	10250T397LWD2A-51			
	Transformer		120 Vac	Red	10250T411LRD06-53	10250T411LRD06-1	10250T411LRD06-51	
				Green	10250T411LGD06-53	10250T411LGD06-1	10250T411LGD06-51	
				Amber	10250T411LAD06-53	10250T411LAD06-1	10250T411LAD06-51	
		Yellow		10250T411LYD06-53	10250T411LYD06-1	10250T411LYD06-51		
		Blue		10250T411LLD06-53	10250T411LLD06-1	10250T411LLD06-51		
		White		10250T411LWD06-53	10250T411LWD06-1	10250T411LWD06-51		
<b>Incandescent Lamp</b>								
Full voltage		24 Vac/Vdc		Red	#757	10250T476C21-53	10250T476C21-1	10250T476C21-51
				Green		10250T476C22-53	10250T476C22-1	10250T476C22-51
	Amber		10250T476C43-53	10250T476C43-1		10250T476C43-51		
	Yellow		10250T476C23-53	10250T476C23-1		10250T476C23-51		
	Blue		10250T476C24-53	10250T476C24-1		10250T476C24-51		
	Clear		10250T476C25-53	10250T476C25-1		10250T476C25-51		
	White		10250T476C26-53	10250T476C26-1		10250T476C26-51		
	Resistor	120 Vac/Vdc	Red	120MB	10250T471C21-53	10250T471C21-1	10250T471C21-51	
			Green		10250T471C22-53	10250T471C22-1	10250T471C22-51	
			Amber		10250T471C43-53	10250T471C43-1	10250T471C43-51	
			Yellow		10250T471C23-53	10250T471C23-1	10250T471C23-51	
			Blue		10250T471C24-53	10250T471C24-1	10250T471C24-51	
			Clear		10250T471C25-53	10250T471C25-1	10250T471C25-51	
			White		10250T471C26-53	10250T471C26-1	10250T471C26-51	
			Transformer		120 Vac	Red	#755	10250T75R ①
Green	10250T75G ①	10250T76G ①		10250T77G ①				
Amber	10250T75A ①	10250T76A ①		10250T77A ①				
Yellow	10250T75Y ①	10250T76Y ①		10250T77Y ①				
Blue	10250T75B ①	10250T76B ①		10250T77B ①				
Clear	10250T75C ①	10250T76C ①		10250T77C ①				
White	10250T75W ①	10250T76W ①		10250T77W ①				

**Note**① For flashing module catalog number 10250TFL1, add suffix code **FM** to listed catalog number. Example: 10250T75R**FM**.

### Indicating Light Units ①

UL (NEMA) Type 3, 3R, 4, 4X, 12, 13

- LED or incandescent
- Full voltage, resistor or transformer type
- Standard and PresTest types
- Plastic lenses

PresTest—This device incorporates a press-to-test feature whereby depressing the lens disconnects the light from the source being

monitored and connects the lamp to a continuously energized circuit for immediate detection of faulty lamps.

24V Full Voltage Illuminated Light



120 Vac Transformer PresTest



### Indicating Light Units

Type	Voltage	Color	LED/Lamp Number	Indicating Light Catalog Number	PresTest Catalog Number	
<b>LED Lamp</b>						
Full voltage	24 Vac/Vdc	Red	Bayonet base	10250T197LRP24	10250T297LRP24	
		Green		10250T197LGP24	10250T297LGP24	
		Amber		10250T197LAP24	10250T297LAP24	
		Yellow		10250T197LYP24	10250T297LYP24	
		Blue		10250T197LLP24	10250T297LLP24	
		White		10250T197LWP24	10250T297LWP24	
		120 Vac		Red	10250T197LRP2A	10250T297LRP2A
	Green		10250T197LGP2A	10250T297LGP2A		
	Amber		10250T197LAP2A	10250T297LAP2A		
	Yellow		10250T197LYP2A	10250T297LYP2A		
	Blue		10250T197LLP2A	10250T297LLP2A		
	White		10250T197LWP2A	10250T297LWP2A		
	Transformer		120 Vac	Red	10250T181LRP06	10250T221LRP06
				Green	10250T181LGP06	10250T221LGP06
				Amber	10250T181LAP06	10250T221LAP06
				Yellow	10250T181LYP06	10250T221LYP06
		Blue		10250T181LLP06	10250T221LLP06	
White		10250T181LWP06		10250T221LWP06		
<b>Incandescent Lamp</b>						
Full voltage	24 Vac/Vdc	Red	#757	10250T206NC1N	10250T235NC21	
		Green		10250T206NC2N	10250T235NC22	
		Amber		10250T206NC19N	10250T235NC43	
		Yellow		10250T206NC3N	10250T235NC23	
		Blue		10250T206NC4N	10250T235NC24	
		Clear		10250T206NC5N	10250T235NC25	
		White		10250T206NC6N	10250T235NC26	
	Resistor	120 Vac/Vdc	Red	120MB	10250T201NC1N	10250T231NC21
			Green		10250T201NC2N	10250T231NC22
			Amber		10250T201NC19N	10250T231NC43
			Yellow		10250T201NC3N	10250T231NC23
			Blue		10250T201NC4N	10250T231NC24
			Clear		10250T201NC5N	10250T231NC25
			White		10250T201NC6N	10250T231NC26
Transformer ②	120 Vac	Red	#755	10250T34R	10250T74NR	
		Green		10250T34G	10250T74NG	
		Amber		10250T34A	10250T74NA	
		Yellow		10250T34Y	10250T74NY	
		Blue		10250T34B	10250T74NB	
		Clear		10250T34C	10250T74NC	
		White		10250T34W	10250T74NW	

**Notes**

- ① Standard indicating lights are rated UL (NEMA) 3S as well.
- ② For flashing lamp add letter **F** to listed catalog number. Example: 10250T34RF.



**Illuminated Pushbuttons and Indicating Lights**

- LED or incandescent
- Full voltage, resistor or transformer type

**Illuminated Pushbutton****Operators without Lens****Indicating Light****PresTest****Master Test**

Type	Voltage	LED/Lamp Number	Illuminated Pushbutton Catalog Number	Indicating Light Catalog Number	PresTest Catalog Number	Master Test Catalog Number
<b>Incandescent Unit</b>						
Full voltage AC/DC	6	#755	<b>10250T473</b>	<b>10250T203N</b>	<b>10250T232N</b>	—
	12	#756	<b>10250T474</b>	<b>10250T204N</b>	<b>10250T233N</b>	—
	24	#757	<b>10250T476</b>	<b>10250T206N</b>	<b>10250T235N</b>	—
	32	#1828	<b>10250T477</b>	<b>10250T207N</b>	<b>10250T238N</b>	—
	48	#1835	<b>10250T478</b>	<b>10250T208N</b>	<b>10250T239N</b>	—
Resistor AC/DC <sup>②</sup>	120	120MB	<b>10250T471</b>	<b>10250T201N</b>	<b>10250T231N</b>	—
	240	120MB	<b>10250T472</b>	<b>10250T202N</b>	<b>10250T240N</b>	—
Transformer AC only <sup>③</sup>	24	#755	<b>10250T416</b>	—	—	—
	120		<b>10250T411</b>	<b>10250T181N</b>	<b>10250T221N</b>	—
	240		<b>10250T422</b>	<b>10250T182N</b>	<b>10250T222N</b>	—
	277		<b>10250T419</b>	<b>10250T198N</b>	—	—
	380		<b>10250T413</b>	<b>10250T183N</b>	<b>10250T223N</b>	—
	480		<b>10250T414</b>	<b>10250T184N</b>	<b>10250T224N</b>	—
Neon AC/DC <sup>④</sup>	120	NE51H-R22	—	<b>10250T226N</b>	—	—
	240	NE51H-R68	—	<b>10250T227N</b>	—	—
Solid-state 50/60 Hz only	120	120MB	—	—	—	<b>10250T189N</b>
<b>LED (LEDs not included) <sup>①</sup></b>						
Full voltage	—	Bayonet base	<b>10250T397L</b>	<b>10250T197L</b>	<b>10250T297L</b>	—
Transformer AC only	24		<b>10250T416L</b>	—	—	—
	120		<b>10250T411L</b>	<b>10250T181L</b>	<b>10250T221L</b>	—
	240		<b>10250T412L</b>	<b>10250T182L</b>	<b>10250T222L</b>	—
	277		<b>10250T419L</b>	<b>10250T198L</b>	—	—
	380		<b>10250T413L</b>	<b>10250T183L</b>	<b>10250T223L</b>	—
	480		<b>10250T414L</b>	<b>10250T184L</b>	<b>10250T224L</b>	—
	600		<b>10250T415L</b>	<b>10250T185L</b>	<b>10250T225L</b>	—

**Notes**

- <sup>①</sup> These units do not include lamps. Order LED separately to match lens color. See **Page V7-T1-249** for LED Selection and **Page V7-T1-195** for Catalog Numbering System.
- <sup>②</sup> Resistor units are not available for use with LEDs, choose either transformer or full voltage LED style.
- <sup>③</sup> For flashing lamp, add letter **F** to listed catalog number. Example: 10250T181NF.
- <sup>④</sup> Resistant to shock and vibration. For best illumination use amber, yellow or clear lens.

Plastic



### Indicating and Master Test Lenses

Color	Plastic Catalog Number	Glass Catalog Number
Red	10250TC1N	10250TC7N
Green	10250TC2N	10250TC8N
Amber	10250TC19N	10250TC9N
Yellow	10250TC3N	—
Blue	10250TC4N	10250TC10N
Clear	10250TC5N	10250TC11N
White	10250TC6N	10250TC12N

Glass



10250TC2



### Illuminated Pushbutton Lenses

Color	Catalog Number
Red	10250TC21
Green	10250TC22
Yellow	10250TC23
Amber	10250TC43
Blue	10250TC24
Clear	10250TC25
White	10250TC26

Plastic



### PresTest Lenses

Color	Plastic Catalog Number	Glass Catalog Number
Red	10250TC21	10250TC13N
Green	10250TC22	10250TC14N
Amber	10250TC43	10250TC15N
Yellow	10250TC23	—
Blue	10250TC24	10250TC16N
Clear	10250TC25	10250TC17N
White	10250TC26	10250TC18N

Glass



**1 Push-Pull Emergency Stops (Compliant with IEC 60947-5-5)**

UL (NEMA) Type 3, 3R, 4, 4X, 12, 13

- Two- and three-position
- Non-illuminated
- LONC contact block

**10250T579C47-71X****Two-Position Push-Pull Units****Operator Position** ①

Pull	Push	Button Type/Color	Lamp	Type	Voltage	Catalog Number
X	0	40 mm red—illuminated	Incandescent	Transformer	120 Vac/Vdc	<b>10250T563C47-71X</b>
X	0	40 mm red—illuminated EMERG. STOP	Incandescent	Transformer	120 Vac/Vdc	<b>10250T563C53-71X</b>
X	0	40 mm red—illuminated EMERG. STOP	LED	Transformer	120 Vac/Vdc	<b>10250T563LED06-71X</b>
X	0	40 mm red—illuminated	Incandescent	Full voltage	24 Vdc	<b>10250T579C47-71X</b>
X	0	40 mm red—illuminated EMERG. STOP	Incandescent	Full voltage	24 Vdc	<b>10250T579C53-71X</b>
X	0	40 mm red—illuminated	Incandescent	Resistor	120 Vac/Vdc	<b>10250T580C47-71X</b>
X	0	40 mm red—illuminated EMERG. STOP	Incandescent	Resistor	120 Vac/Vdc	<b>10250T580C53-71X</b>
X	0	40 mm red—illuminated	Incandescent	Transformer	24 Vac	<b>10250T589C47-71X</b>
X	0	40 mm red—illuminated EMERG. STOP	Incandescent	Transformer	24 Vac	<b>10250T589C53-71X</b>
X	0	40 mm red—illuminated EMERG. STOP	LED	Transformer	24 Vac	<b>10250T589LED06-71X</b>
X	0	40 mm red—illuminated	LED	Transformer	24 Vac	<b>10250T589LRD06-71X</b>
X	0	40 mm red—illuminated EMERG. STOP	LED	Full voltage	24 Vdc	<b>10250T597LED24-71X</b>
X	0	40 mm red—illuminated EMERG. STOP	LED	Full voltage	120 Vac/Vdc	<b>10250T597LED2A-71X</b>
X	0	40 mm red—illuminated	LED	Full voltage	24 Vdc	<b>10250T597LRD24-71X</b>
X	0	40 mm red—illuminated	LED	Full voltage	120 Vac/Vdc	<b>10250T597LRD2A-71X</b>
X	0	40 mm red	—	—	—	<b>10250T5B62-71X</b>
X	0	40 mm red—EMERG. STOP	—	—	—	<b>10250T5B63-71X</b>
X	0	65 mm red	—	—	—	<b>10250T5J62-71X</b>
X	0	65 mm red—EMERG. STOP	—	—	—	<b>10250T5J63-71X</b>

**Note**

① X = closed circuit, 0 = open circuit.

UL (NEMA) Type 3, 3R, 4, 4X, 12, 13

### Two-Position Push-Pull Units

#### Operator Position <sup>①</sup>

**Pull**



**Push**



**Button Type/Color <sup>②</sup>**

**Contact Type**













**Mounting Location**

**A**



**B**

**Catalog Number <sup>②</sup>**

#### Two-Position Maintained Push, Maintained Pull

 <p><b>10250T5B62-1X</b></p>	0	X	40 mm/red	1NO			<b>10250T5B62-1X</b>
	X	0		1NC			
 <p><b>10250T5B63-1X</b></p>	0	X	40 mm engraved EMERG. STOP/red	1NO			<b>10250T5B63-1X</b>
	X	0		1NC			
 <p><b>10250T5J63-1X</b></p>	0	X	65 mm aluminum engraved EMERG. STOP/red	1NO			<b>10250T5J63-1X</b>
	X	0		1NC			
 <p><b>10250ED1080-2</b></p>	0	X	65 mm aluminum engraved EMERG. STOP/red  Special security jumbo mushroom head	1NO			<b>10250ED1080-2</b>
	X	0		1NC			

### Button and Color Selection

	<b>Color</b>	<b>Suffix Code</b>	<b>Catalog Number</b>
<b>Standard</b> 	<b>Standard—40 mm</b>		
	Red	<b>B62</b>	<b>10250TB62</b>
	Red (EMERG. STOP)	<b>B63</b>	<b>10250TB63</b>
	Green	<b>B61</b>	<b>10250TB61</b>
	Black	<b>B60</b>	<b>10250TB60</b>
	Blue	<b>B64</b>	<b>10250TB64</b>
<b>Jumbo Mushroom Head</b> 	<b>Jumbo Mushroom Head <sup>③</sup> (Anodized) Aluminum—65 mm</b>		
	Red	<b>J62</b>	<b>10250TJ62</b>
	Red (EMERG. STOP)	<b>J63</b>	<b>10250TJ63</b>
	Green	<b>J61</b>	<b>10250TJ61</b>
	Black	<b>J60</b>	<b>10250TJ60</b>
	Yellow	<b>J64</b>	<b>10250TJ64</b>

#### Notes

- ① X = closed circuit, 0 = open circuit.
- ② To order different type or color buttons, substitute the underlined characters with appropriate suffix code from the table.  
Example: 10250TB64-1X.
- ③ Anodized aluminum head is not suitable for use in ultraviolet light applications.

UL (NEMA) Type 3, 3R, 4, 4X, 12, 13

10250T\_

**Three-Position Push-Pull Units****Operator Position** <sup>①</sup>

	Pull	Intermediate	Push	Button Type/Color <sup>②</sup>	Contact Type	Mounting Location		Catalog Number <sup>②</sup>
						A	B	
<b>Maintained Push, Momentary Pull</b>								
X		0	0	40 mm/black	1NC			<b>10250T9B60-3X</b>
X		X	0	40 mm/red	1NC			<b>10250T9B62-3X</b>
				40 mm engraved EMERG. STOP/red				<b>10250T9B63-3X</b>
<b>Momentary Push, Momentary Pull</b>								
X		0	0	40 mm/black	1NC			<b>10250T4B60-3X</b>
X		X	0	40 mm/red	1NC			<b>10250T4B62-3X</b>
0	0	0	X	40 mm/black	1NO			<b>10250T10B60-1X</b>
X	0	0	0	40 mm/red	1NC			<b>10250T10B62-1X</b>

**Button and Color Selection**

Color	Suffix Code	Catalog Number
<b>Standard—40 mm</b>		
Red	<b>B62</b>	<b>10250TB62</b>
Red (EMERG. STOP)	<b>B63</b>	<b>10250TB63</b>
Green	<b>B61</b>	<b>10250TB61</b>
Black	<b>B60</b>	<b>10250TB60</b>
Blue	<b>B64</b>	<b>10250TB64</b>
<b>Jumbo Mushroom Head <sup>③</sup> (Anodized) Aluminum—65 mm</b>		
Red	<b>J62</b>	<b>10250TJ62</b>
Red (EMERG. STOP)	<b>J63</b>	<b>10250TJ63</b>
Green	<b>J61</b>	<b>10250TJ61</b>
Black	<b>J60</b>	<b>10250TJ60</b>
Yellow	<b>J64</b>	<b>10250TJ64</b>

**Notes**

<sup>①</sup> X = closed circuit, 0 = open circuit.

<sup>②</sup> To order different type or color buttons, substitute the underlined characters with appropriate suffix code from the table.  
Example: 10250T5B64-1X.

<sup>③</sup> Anodized aluminum head is not suitable for use in ultraviolet light applications.

**Standard****Jumbo Mushroom Head**

**Illuminated Push-Pull Units**

UL (NEMA) Type 3, 3R, 4, 4X, 12, 13

- LED or incandescent
- Full voltage, resistor or transformer type
- Two-position maintained

**Two-Position Push-Pull Operator**



**Two-Position Illuminated Maintained Push, Maintained Pull**

Operator Position ①

Maintained—Pull	Maintained—Push	Lamp	Type	Voltage	Contact Type	Mounting Location A	Mounting Location B	LED/Lamp Number	Red Standard Push-Pull Catalog Number ②
0	X	LED	Full Voltage	24 Vac/Vdc	1NO			Bayonet base	<u>10250T597LRD24-1X</u>
X	0			120 Vac/Vdc	1NC				<u>10250T597LRD24A-1X</u>
			Transformer	24 Vac		<u>10250T589LRD06-1X</u>			
				120 Vac		<u>10250T563LRD06-1X</u>			
0	X	Incandescent	Full voltage	24 Vac/Vdc	1NO			#757	<u>10250T579C47-1X</u>
X	0			120 Vac/Vdc	1NC			120MB	<u>10250T580C47-1X</u>
			Transformer	24 Vac			#755	<u>10250T589C47-1X</u>	
				120 Vac			<u>10250T563C47-1X</u>		

**10250ED137\_**

**Jumbo Lens Illuminated E-Stops**



Lamp	Button Type/Color	Type	Voltage	Contact Type	Catalog Number
LED	Two-position illuminated maintained push/pull— 50 mm jumbo lens/red	Full voltage	24 Vac/Vdc	1NO 1NC	<b>10250ED1375</b>
LED	Three-position illuminated momentary push/pull— 50 mm jumbo lens/red	Full voltage	24 Vac/Vdc	1NC 1NC	<b>10250ED1376</b>
LED	Three-position illuminated momentary push/pull— 50 mm jumbo lens/red	Full voltage	24 Vac/Vdc	1NO 1NC	<b>10250ED1377</b>
LED	Three-position illuminated maintained push/momentary pull— 50 mm lens/red	Full voltage		1NO 1NC	<b>10250ED1378</b>

**Notes**

- ① X = closed circuit, 0 = open circuit.
- ② To order different type or color lens, substitute the underlined characters with appropriate suffix code from table on next page. Example: 10250T579C63-1X. For LEDs with different voltages see ordering example on **Page V7-T1-215**.

# 1.8





## Pushbuttons and Indicating Lights

30.5 mm Heavy-Duty Watertight/Oiltight—10250T

1

UL (NEMA) Type 3, 3R, 4, 4X, 12, 13

### Lens and Color Selection

	Color	Incandescent Suffix Code	LED Suffix Code	Catalog Number
<b>Standard</b> 	<b>Standard—40 mm</b>			
	Red	C47	RD	10250TC47
	Red (EMERG. STOP)	C53	ED	10250TC53
	Green	C48	GD	10250TC48
	Blue	C49	LD	10250TC49
	Amber	C50	AD	10250TC50
	White	C51	WD	10250TC51
	Clear	C52	CD	10250TC52
<b>Side-Lighted Aluminum</b> 	<b>Side-Lighted Aluminum—40 mm</b> ①			
	Red	C57	RS	10250TC57
	Red (EMERG. STOP)	C63	ES	10250TC63
	Green	C58	GS	10250TC58
	Blue	C59	LS	10250TC59
	Amber	C64	AS	10250TC64
	Yellow	C60	YS	10250TC60
	White	C61	WS	10250TC61
	Clear	C62	CS	10250TC62
<b>Aluminum Transparent Center</b> 	<b>Aluminum Transparent Center—40 mm</b> ①			
	Red	C65	RH	10250TC65
	Green	C66	GH	10250TC66
<b>Jumbo Lens</b> 	<b>Jumbo Lens—50 mm</b>			
	Red	—	—	10250TC77

**Note**

① Clear anodized aluminum and colored lens.

UL (NEMA) Type 3, 3R, 4, 4X, 12, 13

**Three-Position Push-Pull Operator**



**Three-Position Illuminated Momentary Push, Momentary Pull**

**Operator Position ①**

Momentary—Pull	Maintained—Intermediate	Momentary—Push	Lamp	Type	Voltage	Contact Type	Mounting Location		LED/Lamp Number	Red Standard Push-Pull Catalog Number ③
							A	B		
0	0	X	LED	Full voltage	24 Vac/Vdc	1NO			Bayonet base	<b>10250T1097LRD24-1X</b>
X	0	0			120 Vac	1NC				<b>10250T1097LRD2A-1X</b>
					Transformer	24 Vac		<b>10250T1089LRD06-1X</b>		
				120 Vac			<b>10250T1063LRD06-1X</b>			
X	0	0		Full voltage	120 Vac	1NC			Bayonet base	<b>10250T497LRD24-3X</b>
X	X	0				1NC				<b>10250T497LRD2A-3X</b>
			Transformer			24 Vac		<b>10250T489LRD06-3X</b>		
			120 Vac			<b>10250T463LRD06-3X</b>				
0	0	X	Incan- descent	Full voltage	24 Vac/Vdc	1NO			#757	<b>10250T1079C47-1X</b>
X	0	0			120 Vac	1NC				<b>10250T1080C47-1X</b>
					Transformer	24 Vac		#755	<b>10250T1089C47-1X</b>	
				120 Vac			<b>10250T1063C47-1X</b>			
X	0	0		Full voltage	120 Vac	1NC			#757	<b>10250T479C47-3X</b>
X	X	0				1NC				<b>10250T480C47-3X</b>
			Transformer			24 Vac		#755	<b>10250T489C47-3X</b>	
			120 Vac			<b>10250T463C47-3X</b>				

**Three-Position Push-Pull Operator**



**Three-Position Illuminated Maintained Push, Momentary Pull**

**Operator Position ①**

Momentary—Pull	Maintained—Intermediate	Momentary—Push	Lamp	Type	Voltage	Contact Type	Mounting Location		LED/Lamp Number	Red Standard Push-Pull Catalog Number ②	
							A	B			
X	0	0	LED	Full voltage	24 Vac/Vdc	1NC			Bayonet base	<b>10250T997LRD24-3X</b>	
X	X	0			120 Vac	1NC				<b>10250T997LRD2A-3X</b>	
					Transformer	24 Vac		<b>10250T989LRD06-3X</b>			
				120 Vac			<b>10250T963LRD06-3X</b>				
X	0	0		Incan- descent	Full voltage	24 Vac/Vdc	1NC			#757	<b>10250T979C47-3X</b>
X	X	0				120 Vac	1NC				<b>10250T980C47-3X</b>
			Transformer			24 Vac		#755	<b>10250T989C47-3X</b>		
			120 Vac			<b>10250T963C47-3X</b>					

**Notes**

- ① X = closed circuit, 0 = open circuit.
- ② To order different type or color lens, substitute the underlined characters with appropriate suffix code from table on **Page V7-T1-210**. Example: 10250T1079C53-1X. For LEDs with different voltages see ordering example on **Page V7-T1-215**.
- ③ To order different type or color lens, substitute the underlined characters with appropriate suffix code from table on **Page V7-T1-210**. Example: 10250T979C53X. For LEDs with different voltages see ordering example on **Page V7-T1-215**.



**Potentiometers**

UL (NEMA) Type 3, 3R, 4, 4X, 12, 13

**Vertical or Horizontal  
One-Hole Mounting** ①**Potentiometer with Knob and Standard Dial Plate—Linear Type  $\pm 10\%$** 

Potentiometer Ohms	Catalog Number
<b>2 Watt (60V Max.) Single Potentiometer with Standard Aluminum Dial Plate</b> ②③	
1000	<b>10250T331</b>
2500	<b>10250T332</b>
5000	<b>10250T338</b>
10000	<b>10250T333</b>
25000	<b>10250T334</b>
50000	<b>10250T335</b>
Operator only ④	<b>10250T330</b>
Alternative—black plastic large legend with standard markings	<b>E34LP99</b>

**Notes**

- ① Shown with standard aluminum dial plate.
- ② Large dial plate with space for legend is available at no charge. To order, add suffix **36** to catalog number. Example: 10250T331**36**. To order separately, see footnote ③ below.
- ③ Large dial plate has space at top for 15 letters. 3/32 in high. For custom stamped legend plates, order legend plate as separate item **10250TR30** and specify stamping.
- ④ For use with commercially purchased potentiometers having shaft dimensions per dimension drawing on **Page V7-T1-259**.

### Push-Pull Operators

An illuminated push-pull pushbutton unit, arranged for one-hole mounting, can replace two pushbuttons and a pilot light or the non-illuminated form can replace two pushbuttons. These units are available in three basic types:

- **Maintained**—(Two-position). Maintains in the pulled or pushed position until manually actuated to the opposite mode.
- **Momentary**—(Three-position). Spring returns to an intermediate position when pulled or pushed and released.
- **Momentary Pull, Maintained Push**—(Three-position). Spring returns to intermediate position when pulled. Maintains in pushed position until manually returned to intermediate (ready to reset) position. Maintained stop holds circuit open and will prevent other series connected operators from starting the system.

The operators, buttons, contact blocks, etc., are offered as building block components that can be intermixed to satisfy many requirements. This minimizes the need for a varied and costly inventory.

#### Two-Position Maintained Push-Pull ①



#### Typical Applications

Control	Line—Diagram	Operator	Circuits	Operator Mode
Three-wire three-position momentary		Momentary push and pull 10250T4	2NC contact block 10250T3	
Two-wire two-position maintained		Maintained push and pull 10250T5	1NC contact block 10250T1	
Three-wire momentary pull maintained push		Maintained push and momentary pull 10250T9	2NC contact block 10250T3	

#### Notes

**A** and **B** circuits shown in the application illustrations are defined in the "Application Guide" on the following page.  
 ① Shown without button on lens.

# 1.8

## Pushbuttons and Indicating Lights

### 30.5 mm Heavy-Duty Watertight/Oiltight—10250T

1

#### Application Guide

To assist in the selection of contact blocks, the sketch to the right shows pictorially by symbols **A** and **B** locations of contact circuits after assembly of contact blocks

and adapter to the operator. The table below shows the effect of the push and pull operations on either NO or NC contacts. (X = contact closed, O = contact open).

#### Contact Circuit Locations

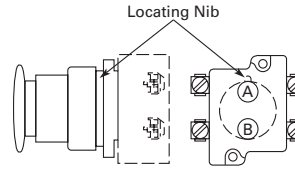

10250T579C47-71X

#### Push-Pull Operator Components



#### Operator Position and Circuit Arrangement



#### Contact Block Mounting Location

Type of Operator	Out—Pull		Intermediate		In—Push		Contact Block ①	Catalog Number
	A	B	A	B	A	B		
<b>Two-Position Operator without Lens</b>								
Maintained push-pull	O	O	No intermediate position		X	X	1NO	<b>10250T5</b>
	X or	X			O	O	1NC	
Maintained push-pull with anti-theft jumbo mushroom	O	O	No intermediate position		X	X	1NO	<b>10250ED1080</b>
	X or	X			O	O	1NC	
	O	O			X	X	2NO	
	X	X			O	O	2NC	
<b>Three-Position Operator without Lens</b>								
Momentary push-pull	O	O	O	O	X	O	1NO	<b>10250T4 ①</b>
	X or	X	O	O	O	O	1NC	
	O	O	O	O	X	O	2NO	
	X	X	O	X	O	O	2NC	
Maintained push-momentary pull	O	O	O	O	X	O	1NO	<b>10250T9 ①</b>
	X or	X	O	O	O	O	1NC	
	O	O	O	O	X	O	2NO	
	X	X	O	X	O	O	2NC	
Momentary push-pull	O	O	O	O	X	X	1NO	<b>10250T10 ①</b>
	X or	X	O	O	O	O	1NC	
	O	O	O	O	X	X	2NO	
	X	X	O	O	O	O	2ND	

#### Note

① Maximum of two blocks, four circuits. Special function contact blocks shown on **Page V7-T1-245** CANNOT be used with three-position push-pull operators 10250T4, 10250T9 or 10250T10.

### Push-Pull Light Units, Lenses and Buttons

#### Ordering Example with One Composite Number

Non-illuminated:

10250T5 + 10250TB62 + 10250T1 = **10250T5B62-1X**

Incandescent:

10250T5 + 10250T79 + 10250TC47 + 10250T1 = **10250T579C47-1X**

LED:

10250T5 + 10250T97L + 10250TC47 + Voltage code + 10250T1 = **10250T597LRD24-1X**

06—6 Vac/Vdc	60—60 Vac/Vdc
12—12 Vac/Vdc	2A—120 Vac
24—24 Vac/Vdc	2D—120 Vdc
48—48 Vac/Vdc	





### Light Units for Illuminated Push-Pull Devices

Light Unit Type	Type	Voltage	LED/Lamp Number	Catalog Number
LED (LEDs not included) <sup>①</sup>	Full voltage	—	Bayonet base	<b>10250T97L</b>
	Transformer AC only 50/60 Hz	24		<b>10250T89L</b>
		120		<b>10250T63L</b>
		208		<b>10250T64L</b>
		240		<b>10250T65L</b>
		277		<b>10250T82L</b>
		380		<b>10250T66L</b>
		480		<b>10250T67L</b>
		600		<b>10250T68L</b>
		Incandescent		Full voltage AC or DC
12	<b>10250T70</b>			
24/28	<b>10250T79</b>			
32	<b>10250T83</b>			
Resistor AC or DC	120		120MB	<b>10250T80</b>
	240			<b>10250T81</b>
Transformer AC only 50/60 Hz	24		#755	<b>10250T89</b>
	120			<b>10250T63</b>
	208			<b>10250T64</b>
	240			<b>10250T65</b>
	277			<b>10250T82</b>
	380			<b>10250T66</b>
	480			<b>10250T67</b>
	600			<b>10250T68</b>



**Note**

<sup>①</sup> These units do not include lamps. Order LED separately to match lens color, see **Page V7-T1-249**.

#### Alternate Lenses for Illuminated Push-Pull Devices

	Lens Color	Incandescent Suffix Code	LED Suffix Code <sup>①</sup>	Catalog Number
<b>Standard</b> 	<b>Standard</b>			
	Red	<b>C47</b>	<b>RD</b>	<b>10250TC47</b>
	Red (EMERG. STOP)	<b>C53</b>	<b>ED</b>	<b>10250TC53</b>
	Green	<b>C48</b>	<b>GD</b>	<b>10250TC48</b>
	Blue	<b>C49</b>	<b>LD</b>	<b>10250TC49</b>
	Amber	<b>C50</b>	<b>AD</b>	<b>10250TC50</b>
	White	<b>C51</b>	<b>WD</b>	<b>10250TC51</b>
	Clear	<b>C52</b>	<b>CD</b>	<b>10250TC52</b>
<b>Side-Lighted Anodized Aluminum Ring</b> 	<b>Side-Lighted Anodized Aluminum Ring</b>			
	Red	<b>C57</b>	<b>RS</b>	<b>10250TC57</b>
	Red (EMERG. STOP)	<b>C63</b>	<b>ES</b>	<b>10250TC63</b>
	Green	<b>C58</b>	<b>GS</b>	<b>10250TC58</b>
	Blue	<b>C59</b>	<b>LS</b>	<b>10250TC59</b>
	Amber	<b>C64</b>	<b>AS</b>	<b>10250TC64</b>
	Yellow	<b>C60</b>	<b>YS</b>	<b>10250TC60</b>
	White	<b>C61</b>	<b>WS</b>	<b>10250TC61</b>
	Clear	<b>C62</b>	<b>CS</b>	<b>10250TC62</b>
<b>Heavy-Duty Aluminum</b> 	<b>Heavy-Duty Aluminum with Transparent Center</b>			
	Red	<b>C65</b>	<b>RH</b>	<b>10250TC65</b>
	Green	<b>C66</b>	<b>GH</b>	<b>10250TC66</b>
	Amber	<b>C67</b>	<b>AH</b>	<b>10250TC67</b>
	White	<b>C68</b>	—	<b>10250TC68</b>
<b>Jumbo Lens</b> 	<b>Jumbo Lens—50 mm</b>			
Red	—	—	<b>10250TC77</b>	

#### Buttons for Non-Illuminated Push-Pull Devices

	Color	Suffix Code	Catalog Number
<b>Standard</b> 	<b>Standard</b>		
	Red	<b>B62</b>	<b>10250TB62</b>
	Red (EMERG. STOP)	<b>B63</b>	<b>10250TB63</b>
	Green	<b>B61</b>	<b>10250TB61</b>
	Black	<b>B60</b>	<b>10250TB60</b>
	Blue	<b>B64</b>	<b>10250TB64</b>
<b>Jumbo Mushroom Head (Anodized) Aluminum</b> 	<b>Jumbo Mushroom Head <sup>②</sup> (Anodized) Aluminum</b>		
	Red	<b>J62</b>	<b>10250TJ62</b>
	Red (EMERG. STOP)	<b>J63</b>	<b>10250TJ63</b>
	Green	<b>J61</b>	<b>10250TJ61</b>
	Black	<b>J60</b>	<b>10250TJ60</b>
	Yellow	<b>J64</b>	<b>10250TJ64</b>

#### Notes

- ① Suffix codes should only be used for assembling composite catalog numbers. To order lens above, order by catalog number.
- ② Anodized aluminum head is not suitable for use in ultraviolet light applications.

#### Legend Plates

For a complete listing of available legend plates see **Pages V7-T1-240 to V7-T1-242**.

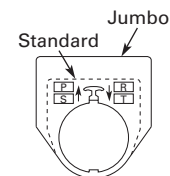

### Selector Switch Units

UL (NEMA) Type 3, 3R, 4, 4X, 12, 13

- Two-, three- and four-position maintained
- Non-illuminated and illuminated

#### Two-Position Maintained Switch



#### Two-Position Selector Switch

Operator Position <sup>①</sup>		Operator Action <sup>②</sup>	Contact Type	Mounting Location		Non-Illuminated		Illuminated—120V Transformer	
				A	B	Black Knob Catalog Number <sup>③</sup>	Black Lever Catalog Number <sup>③</sup>	Red Knob Catalog Number <sup>③</sup>	Red Lever Catalog Number <sup>③</sup>
X	0		1NC			<u>10250T20KB</u>	<u>10250T20LB</u>	<u>10250ED1117-KR</u>	<u>10250ED1117-LR</u>
0	X		1NO						

#### Three-Position Maintained Switch



#### Three-Position Selector Switch

Operator Position <sup>①</sup>			Operator Action <sup>②</sup>	Contact Type	Mounting Location		Non-Illuminated		Illuminated—120V Transformer	
					A	B	Black Knob Catalog Number <sup>③</sup>	Black Lever Catalog Number <sup>③</sup>	Red Knob Catalog Number <sup>③</sup>	Red Lever Catalog Number <sup>③</sup>
X	0	0		1NO			<u>10250T21KB</u>	<u>10250T21LB</u>	<u>10250ED1117-2KR</u>	<u>10250ED1117-2LR</u>
0	0	X		1NO						

#### Three-Position Maintained Switch



X	0	0		1NO			<u>10250T22KB</u>	<u>10250T22LB</u>	<u>10250ED1117-3KR</u>	<u>10250ED1117-3LR</u>
0	X	0		2NC (Series)						
0	0	X		1NO						

#### Three-Position Maintained Switch



#### Four-Position Selector Switch

Operator Position <sup>①</sup>				Operator Action <sup>②</sup>	Contact Type	Mounting Location		Non-Illuminated		Illuminated—120V Transformer	
						A	B	Black Knob Catalog Number <sup>③</sup>	Black Lever Catalog Number <sup>③</sup>	Red Knob Catalog Number <sup>③</sup>	Red Lever Catalog Number <sup>③</sup>
X	0	0	0		1NC			<u>10250T46KB</u>	<u>10250T46LB</u>	<u>10250ED1117-4KR</u>	<u>10250ED1117-4LR</u>
0	X	0	0		1NO						
0	0	X	0		1NO						
0	0	0	X		1NC						

#### Color Selection

Illuminated						Non-Illuminated					
Color	Code Letter	Color	Code Letter	Color	Code Letter	Color	Code Letter	Color	Code Letter	Color	Code Letter
Red	<b>R</b>	White	<b>W</b>	Amber	<b>A</b>	Black	<b>B</b>	Green	<b>G</b>	Blue	<b>L</b>
Green	<b>G</b>	Blue	<b>B</b>	Clear	<b>C</b>	Red	<b>R</b>	White	<b>W</b>	Orange	<b>O</b>

#### Notes

- ① X = closed circuit, 0 = open circuit.
- ② M = Maintained.
- ③ To order different type or color selector switch, substitute the underlined character with appropriate suffix code from the Color Selection table. Example: 10250T20KG.

#### 1

### Selector Switch Selection



#### Cam and Contact Block Selection

Selector switches in their varied forms (two-position, three-position and four-position) are a big factor contributing to the great flexibility of control that a well rounded line of “pushbuttons” can achieve. Because of their flexibility, they tend to cause difficulty with product selection and application. The following systematic approach should simplify that task.

Cam and contact block selection is better understood if you:

- Work with each incoming and outgoing wire/circuit separately.
- Recognize the terms NO and NC only identify the type of contact by its mode before mounting to the operator. The “X-O” table (Page V7-T1-220) shows how that contact will act after assembly to the operator with the selected cam shape. X = closed circuit, O = open circuit.

- Up to six NO or NC contacts may be mounted behind each plunger location for a total of twelve contacts. Single circuit contact blocks have only one plunger with the other side of the block “open.” Therefore, single circuit contact blocks transmit motion to blocks behind them only for the position containing the circuit.
- Each cam has two separate lobes, each of which operates one of the two contact block plungers independently of each other. Those are identified as position A (locating nib side) and position B (opposite of locating nib). The position designations give direction in selecting and mounting of the contact blocks.

#### Contact Circuit Locations

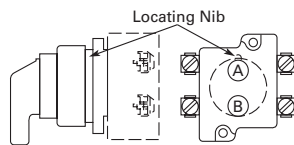

#### Systematic Approach

Application: **HAND-OFF-AUTO** selector switch. In this circuit, one incoming line is distributed to two other outgoing circuits by the switch. The two circuits can be looked at individually.

#### Step 1: Elementary Diagram.

Construct on paper, or in your mind, a simple elementary diagram of the switching scheme as follows:

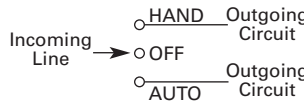

#### Step 2: “X-O” Pattern.

From the elementary diagram, you can construct an “X-O” diagram which describes when the contacts are to be closed (X) or open (O) in the various positions of the switch. The “X-O” for the **HAND** circuit looks like this:

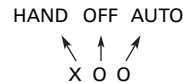

In this circuit, you want a contact closed on the left (HAND) but open in the center and right.

For the **AUTO** circuit, the “X-O” diagram would look like this:

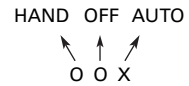

Putting them together, the complete “X-O” diagram is:



Once the “X-O” diagram has been generated the next step is to select the cam and contact block, or blocks, needed to perform the desired “X-O” functions. The selection tables on the following pages list the various types (shapes) of cams by number to choose from and the type of contact and position to achieve the function outlined in your “X-O” diagram.

### Step 3: Cam Selection.

The cam you select determines the operation of all contact blocks mounted to the operator. It is selected on the basis that it provides the simplest circuitry for the desired "X-O" diagram. The selection tables show all the "X-O" combinations. For the purpose of this example, the applicable portion of those tables is shown on this page.

Now to make the cam selection, make a simple worksheet such as:

	Cam 2	Cam 3
X O O	(A)NO-(B)NC	(A)NO
O O X	(B)NO	(B)NO

It becomes immediately obvious that cam 3 is the better choice for two reasons, (1) the series combination can be avoided making it simpler to wire, (2) only two contacts are required, which is less expensive than the three contacts required by cam 2.

### Step 4: Contact Block Selection.

Having selected the cam, contact block selection is simply a matter of gathering the A position and B position circuits into pairs which make up the most convenient contact block arrangement. If there is an imbalance in the number of circuits under A or B, then single circuit blocks must be selected for these leftover circuits.

Back to the worksheet, having selected cam 3 do this:



### Step 5: Selector Switch Operator.

Lastly, you have to choose from the many types of operators—knob and lever in various colors or keyed. Also what combinations of maintained and spring return functions are required. Selection of these operators can be found on **Page V7-T1-222**. For the example in step 4 you may want a three-position maintained black knob, cam 3—Catalog Number 10250T1323.

### The Complete Switch:

10250T1323 with one 10250T2 or, for one composite catalog number, 10250T21KB found on **Page V7-T1-217**.

### Diagrams

Circuits shown illustrate connections to obtain a selector switch circuit combination and are shown with their appropriate line diagrams. Field wiring of jumper connections required as shown.

X = Closed circuit  
O = Open circuit

### Wiring of Jumper Connections

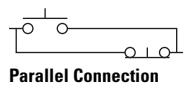

Four-position selector switches are limited to four contact blocks.

### Contact Blocks

For selection and number of available contact blocks per operator, see **Pages V7-T1-245 to V7-T1-248**.

### Example Selection Table

No.	"X-O" Pattern	Cam Code #2		Cam Code #3	
		Top A	Bottom B	Top A	Bottom B
1	X 0 0				—
4	0 0 X	—		—	

### Two-Position Selector Switch Contact Block Selection

No.	Desired Circuit and Operator Position		Contact Blocks Required to Accomplish Circuit Function	
			Top Plunger A	Bottom Plunger B
1	X	0	or	
2	0	X		

### Note

① Wired in series.



# 1.8

## Pushbuttons and Indicating Lights

### 30.5 mm Heavy-Duty Watertight/Oiltight—10250T

#### 1 Three-Position Switch—Cam and Contact Block Selection

No.	Desired Circuit and Operator Position			Operator with Cam Code #2		Operator with Cam Code #3	
				Mounting Location		Mounting Location	
	X	0	0	Top Plunger A	Bottom Plunger B	Top Plunger A	Bottom Plunger B
1	X	0	0				
2	X	X	0				
3	X	0	X				
4	0	0	X				
5	0	X	X				
6	0	X	0				

#### Four-Position Switch—Contact Block Selection

No.	Desired Circuit and Operator Position				Contact Blocks Required to Accomplish Circuit Function		No.	Desired Circuit and Operator Position				Contact Blocks Required to Accomplish Circuit Function	
					Mounting Location			Mounting Location		Mounting Location			
	X	0	0	0	Top Plunger A	Bottom Plunger B		Top Plunger A	Bottom Plunger B	Top Plunger A	Bottom Plunger B		
1	X	0	0	0			10	X	0	X	0		
2	0	X	0	0									
3	0	0	X	0			11	X	X	X	0		
4	0	0	0	X									
5	X	0	0	X			12	0	X	X	X		
6	0	X	X	0									
7	0	0	X	X			13	X	0	X	X		
8	X	X	0	0									
9	0	X	0	X			14	X	X	0	X		

**Selector Switch Operators**







**Key Operators**

UL (NEMA) Type 3, 3R, 4, 4X, 12, 13

**Two-Position Maintained** <sup>①</sup>



**Key Operators with Cam**

Positions	Operator Action <sup>②</sup>	Cam Code <sup>③</sup>	Optional Key Removal Positions <sup>④</sup>	Vertical Mounting Catalog Number	Horizontal Mounting Catalog Number
Two-position—60° throw		1	1, 2, 3	10250T1511_	10250T1611_
		1	2	10250T1571_	10250T1581_
Three-position—60° throw		2	1-7	10250T1522_	10250T1622_
		3		10250T1523_	10250T1623_
		2	1, 4, 5	10250T1532_	10250T1632_
		3		10250T1533_	10250T1633_
		2	4	10250T1542_	10250T1642_
		3		10250T1543_	10250T1643_
Four-position—40° throw		2	2, 4, 6	10250T1652_	10250T1662_
		3		10250T1653_	10250T1663_
		7	7	10250T1677_	10250T1687_

**Notes**

- ① Horizontal mount, key removal #1 keyed selector switch, cam 1 shown.
- ② M = Maintained. S = Spring return in direction of arrow (R).
- ③ For selection of the proper cam and contact block to obtain the proper circuit sequence, see selection instructions and tables on **Pages V7-T1-218, V7-T1-219 and V7-T1-220.**
- ④ Choose key removal position required for application from table on **Page V7-T1-222.** Add key removal code no. to listed catalog number. Example: 10250T15112.

#### Key Removal Positions

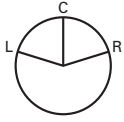

Code Suffix	Key Removal Position
1	Right only
2	Left only
3	Right and left
4	Center only
5	Right and center
6	Left and center
7	All positions

**Note:** Key removal in “spring return from” positions not recommended.

#### Replacement Keys or Dissimilar Locks for Key Operators

Operators listed on **Page V7-T1-222** have identical locks and keys (Key Code H661) Catalog Number 10250ED824. For dissimilar lock and key combinations, see listing on this page.

#### Replacement Key

Description	Catalog Number
Replacement keys (code H661)	10250ED824

#### Selector Switch Operators with Dissimilar Locks and Keys (UL [NEMA] 4, 4X and 13)

The locks in all key operators listed on **Pages V7-T1-201, V7-T1-222** and **V7-T1-359** are identical and use key code number H661. Two keys are supplied with every lock. For additional code number H661 keys, order **Catalog Number 10250ED824**. For others, order 10250ED1130 and designate lock number. When dissimilar locks for each operator or each group of operators are required, select from the lock and key combination listed below. **When Ordering Operator Only** or a complete control unit with a substitute lock, order from table below and add “except Lock and Key Code No. ...”

#### “H” Series Locks without Master Key—with Key Slot Cover

Lock and Key Code Numbers		
H501	H635	H663
H620	H639	H675
H621	H643	H683
H634	H654	H688

#### “M” Series Locks with Master Key—with Key Slot Cover

Lock and Key Code Numbers			
MD1	MD14	ME8	MJ6
MD2	MD15	ME11	MJ10
MD3	MD16	ME16	MJ11
MD4	MD19	ME17	MJ13
MD5	MD20	ME18	MJ15
MD7	ME2	ME19	MJ16
MD9	ME3	MJ1	MD17
MD10	ME5	MJ3	
MD11	ME6	MJ4	
MD13	ME7	MJ5	

#### Master Keys for Above Locks

Application	Catalog Number
For code:	
MD1–MD20	10250ED825-3
ME2–ME18	10250ED825-4
MJ1–MJ16	10250ED825-5

#### Selector Switch Operators with Caps

UL (NEMA) Type 3, 3R, 4, 4X, 12, 13

#### Selector Switch Operators with Caps

Positions	Operator Action <sup>②</sup>	Black Knob Selector Switch—Vertical Mounting <sup>③</sup>		Black Lever Selector Switch—Vertical Mounting <sup>③</sup>		
		Cam Code <sup>④</sup>	Catalog Number	Cam Code <sup>④</sup>	Catalog Number	
Two-Position Maintained <sup>①</sup>	Two-position—60° throw		1	10250T1311	1	10250T3011
			1	10250T1371	1	10250T3071
Three-Position Maintained <sup>⑤</sup>	Three-position—60° throw		2	10250T1322	2	10250T3022
			3	10250T1323	3	10250T3023
			2	10250T1332	2	10250T3032
			3	10250T1333	3	10250T3033
			2	10250T1342	2	10250T3042
			3	10250T1343	3	10250T3043
			2	10250T1352	2	10250T3052
			3	10250T1353	3	10250T3053
Four-position—40° throw		7	10250T1367	7	10250T3067	

#### Notes

- ① Black knob selector switch, cam 1 shown.
- ② M = Maintained. S = Spring return in direction of arrow.
- ③ Field convertible to horizontal mounting or order operator only and separate operator cap.
- ④ For selection of the proper cam and contact block to obtain the proper circuit sequence, see selection instructions and tables on **Pages V7-T1-218, V7-T1-219** and **V7-T1-220**.
- ⑤ Black lever selector switch, cam 3 shown.

### Selector Switch Operators without Caps

Operators can be ordered with caps assembled to them by adding the code number from the table on this page to the end of catalog number below.  
Example: 10250T4011**KB**

#### Two-Position Selector Switch Maintained



### Selector Switch Operators without Caps

Positions	Operator Action ①	Cam Code ②	Catalog Number
Two-position—60° throw		1	<b>10250T4011</b>
		1	<b>10250T4081</b>
Three-position—60° throw		2	<b>10250T4022</b>
		3	<b>10250T4023</b>
		2	<b>10250T4032</b>
		3	<b>10250T4033</b>
		2	<b>10250T4042</b>
		3	<b>10250T4043</b>
Four-position—40° throw		2	<b>10250T4052</b>
		3	<b>10250T4053</b>
		7	<b>10250T4067</b>

#### Knob



#### Lever



#### Lever for Use with Maintained Operators



#### Coin Slot



### Operating Caps

Color	Knob Catalog and Code Number	Lever Catalog and Code Number	Color	Lever ③ Catalog and Code Number	Coin Slot Catalog and Code Number
Black	<b>10250TKB</b>	<b>10250TLB</b>	Black	<b>10250TSB</b>	<b>10250TCB</b>
Red	<b>10250TKR</b>	<b>10250TLR</b>	Red	<b>10250TSR</b>	<b>10250TCR</b>
Green	<b>10250TKG</b>	<b>10250TLG</b>	Green	<b>10250TSG</b>	<b>10250TCG</b>
Yellow	<b>10250TKY</b>	<b>10250TLY</b>	Yellow	<b>10250TSY</b>	<b>10250TCY</b>
White	<b>10250TKW</b>	<b>10250TLW</b>	White	<b>10250TSW</b>	<b>10250TCW</b>
Gray	<b>10250TKA</b>	<b>10250TLA</b>	Gray	<b>10250TSA</b>	<b>10250TCA</b>
Blue	<b>10250TKL</b>	<b>10250TLL</b>	Blue	<b>10250TSL</b>	<b>10250TCL</b>
Orange	<b>10250TKD</b>	<b>10250TLO</b>	Orange	<b>10250TSO</b>	<b>10250TCO</b>

#### Notes

- ① M = Maintained. S = Spring return in direction of arrow (R).
- ② For selection of the proper cam and contact block to obtain the proper circuit sequence, see selection instructions and tables on **Pages V7-T1-218, V7-T1-219 and V7-T1-220**.
- ③ Designed for added ingress protection. For use in maintained operators only.

#### 1

### Illuminated Selector Switch Operators

#### Illuminated Selector Switches without Caps

##### Two-Position Selector Switch Maintained



#### Operator without Knob or Lever

Positions	Operator Action ①	Transformer Type—50/60 Hz 6 Volt #755 Lamp			Full Voltage Type—AC or DC ④ Lamps: 6V—#755, 12V—#756, 24V—#757, 48V—#1835, 120/240V—120MB		
		Cam Code ②	Voltage	Code Number and Catalog Number ③	Cam Code ②	Voltage	Code Number and Catalog Number ③
Two-position—60° throw		1	24	10250T5961	1	6	10250T6201
			120	10250T5971		12	10250T6211
			208	10250T6511		24	10250T6221
			240	10250T5981		48	10250T6231
			380	10250T5991		120	10250T6361
			480	10250T6001		240 ⑤	10250T6371
			600	10250T6011			
Three-position—60° throw		+ 2 or 3	24	10250T602_	+ 2 or 3	6	10250T624_
			120	10250T603_		12	10250T625_
			208	10250T652_		24	10250T626_
			240	10250T604_		48	10250T627_
			380	10250T605_		120	10250T638_
			480	10250T606_		240 ⑤	10250T639_
		600	10250T607_				
		+ 2 or 3	24	10250T654_	+ 2 or 3	6	10250T612_
			120	10250T620_		12	10250T632_
			208	10250T655_		24	10250T642_
			240	10250T656_		48	10250T672_
			380	10250T657_		120	10250T622_
			480	10250T658_		240	10250T682_
		600	10250T659_				
	+ 2 or 3	24	10250T660_	+ 2 or 3	6	10250T613_	
		120	10250T621_		12	10250T633_	
		208	10250T661_		24	10250T643_	
		240	10250T662_		48	10250T673_	
		380	10250T663_		120	10250T623_	
		480	10250T664_		240	10250T683_	
	600	10250T665_					
	+ 2 or 3	24	10250T614_	+ 2 or 3	6	10250T628_	
		120	10250T615_		12	10250T629_	
		208	10250T653_		24	10250T630_	
		240	10250T616_		48	10250T631_	
		380	10250T617_		120	10250T640_	
		480	10250T618_		240 ⑤	10250T641_	
	600	10250T619_					
Four-position—40° throw		7	24	10250T6087	7	6	10250T6327
			120	10250T6097		12	10250T6337
			208	10250T6547		24	10250T6347
			240	10250T6107		48	10250T6357
			380	10250T6117		120	10250T6427
			480	10250T6127		240 ⑤	10250T6437
			600	10250T6137			

#### Notes

- ① M = Maintained. S = Spring return in direction of arrow (R).
- ② For selection of the proper cam and contact block, to obtain the proper circuit sequence, see selection tables on **Pages V7-T1-218, V7-T1-219 and V7-T1-220**.
- ③ Operator includes lens gasket and lens attachment screws.
- ④ Full voltage light units can be used at other than listed voltages by changing lamp. Replacement lamps are listed on **Page V7-T1-249**.
- ⑤ Resistor type. May generate excess heat if used in high density.

**Knob**



**Lever**



### Illuminated Knobs and Levers

Color <sup>①</sup>	Knob Code Number and Catalog Number	Lever Code Number and Catalog Number
Red	10250TER	10250TFR
Green	10250TEG	10250TFG
Yellow	10250TEA	10250TFA
Blue	10250TEL	10250TFL
Clear	10250TEC	10250TFC
White	10250TEW	10250TFW
Amber	10250TEM	10250TFM

### Joystick Units

**Two-Position Joystick**



### Joystick Units—UL (NEMA) Type 3, 3R, 4, 4X, 12, 13

**Operator Position <sup>②</sup>**

	Up	Center	Down	Operator Action <sup>③</sup>	Contact Type	Mounting Location		Two-Position Assembled Unit Catalog Number <sup>④</sup>
						A	B	
X		0	0		1NC			10250T452-3X
0		0	X		1NC			

**Notes**

- ① Amber, clear and white lenses have a black arrow (pointer), red, green and blue lenses have a white arrow (pointer).
- ② X = closed circuit, 0 = open circuit.
- ③ M = Maintained. S = Spring return in direction of arrow (R).
- ④ Field convertible momentary to maintained or vice versa.

#### 1

### Joysticks

#### Two-Position Joystick Operators

The device mounts in the standard 30.5 mm mounting hole. Allow sufficient panel space for lever movement.

The maximum travel of the knob operator (full up to full down) is 2.2 in (24°) momentary, 2.5 in (30°) maintained, but ample space for lever operation must be allowed. These operators are field convertible from momentary to maintained operation or vice versa.

The use of NC contacts is preferred because they provide positive drive contact opening and a direct relationship between lever movement and affected terminal, i.e., up movement affects the top terminals.

#### Application Caution

Joystick operators are not recommended on certain DC applications above 24 Vdc which may involve lightly engaging the contacts (teasing) to achieve speed control, positioning, jogging, etc. Excessive arcing and deterioration of the contacts will occur.

#### Two-Position Joystick Operator



#### Two-Position Joystick Operators—UL (NEMA) Type 3, 3R, 4, 4X, 12, 13

Contact Block Limitations	Two-Position Operator Only—AC Applications Only	
	Description <sup>①</sup>	Catalog Number
<b>Momentary Mode</b> 4NC contact blocks max. 3NO contact blocks max.	Momentary up and down	<b>10250T452</b>
	Maintained up—momentary down	<b>10250T4521</b>
	Maintained down—momentary up	<b>10250T4522</b>
<b>Maintained Mode</b> 2 contact blocks max.	Maintained up and down	<b>10250T4525</b>

#### Contact Block Operation and Selection

##### Handle Position <sup>②</sup>

Up	Center	Down	Contact Block Type <sup>④</sup>	Mounting Location <sup>②③</sup>		Catalog Number
				Top A	Bottom B	
			1NC			<b>10250T51</b>
			1NC			<b>10250T51</b>
			2LONC (Series)			<b>10250T45</b>
			1NC			<b>10250T3</b>
			1NC			<b>10250T3</b>
			1LONC			<b>10250T45</b>
			1LONC			<b>10250T45</b>
			1NC			<b>10250T44 <sup>⑤</sup></b>
			1NO			<b>10250T44 <sup>⑤</sup></b>
			1NC			<b>10250T44 <sup>⑤</sup></b>
			1NO			<b>10250T44 <sup>⑤</sup></b>

#### A and B Mounting Location

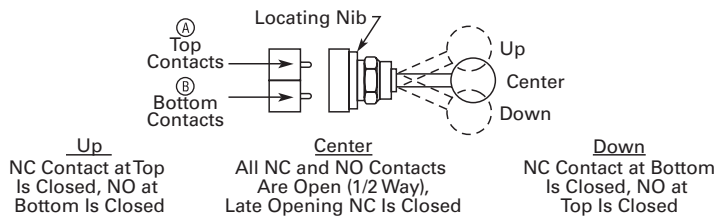

#### Notes

- ① Field convertible momentary to maintained or vice versa. To expedite shipment of maintained types, order momentary operator 10250T452 which is a stocked device.
- ② Bolded circuit corresponds to "X-O" circuit selection. X = closed circuit, O = open circuit.
- ③ See above for "A" and "B" mounting location.
- ④ NO = normally open, NC = normally closed, LONC = late opening normally closed.
- ⑤ Four circuits in single block depth—rated 300V max.

### Four-Position Joystick Operators

The joystick operated control unit is intended for AC application only. For other use, see **Application Caution** on preceding page.

The panel area required for the four-position operator is equivalent to two standard pushbutton operators.

The latch holds the lever in the center position. The trigger latch must be released before lever can move into any position.

**Four-Position Joystick Operator**



**Four-Position Joystick Operator with Latch**



### Four-Position Joystick Operators—UL (NEMA) Type 3, 3R, 4, 4X, 12, 13

Contact Block Limitations	Description <sup>①</sup>	Catalog Number
<b>Operator Only—AC Application Only</b>		
Four contact blocks max.—two in each position	Four-position—without latch	<b>10250T451_</b>
	Four-position—with latch	<b>10250T461_</b>
<b>Hole Plug</b>		
Four contact blocks max.—two in each position	To plug unused hole	<b>10250TA7</b>

### Field Conversion—Gate

The factory assembled four-position operator is assembled with a gate arranged for four handle positions.

#### Handle Positions



Four-Position Gate

Three additional gates, supplied with every operator, allow on the job conversion to three- or eight-position operation as illustrated.

### Two-, Three- or Eight-Position Operation

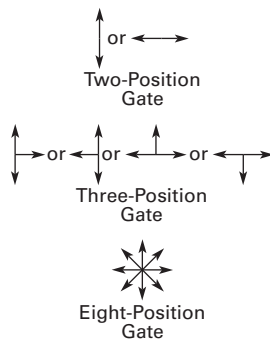

The eight-position gate controls the four functions shown as “Up,” “Down,” “Left” and “Right.” The remaining four diagonal positions each actuate two adjacent functions; for example, “Left Down” actuates both “Left” and “Down.” The operator may be arranged for spring return of handle to center position, or maintained in up to eight positions (see description of maintained position operator).

### Adjacent Functions

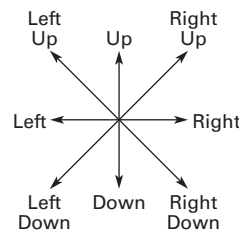

### Maintained Position

For maintained position (non-spring return), locate required maintained position or positions of operating lever and add appropriate suffix number to the catalog number selected from the table above.

### Maintained Positions

Maintained Positions				Suffix Number
Up	Down	Left	Right	
X	—	—	—	<b>1</b>
—	—	—	—	<b>2</b>
—	X	—	—	<b>3</b>
—	—	X	—	<b>4</b>
—	—	—	—	<b>5</b>
X	—	X	—	<b>6</b>
X	—	—	X	<b>7</b>
—	X	X	—	<b>8</b>
—	X	—	X	<b>9</b>
—	—	X	X	<b>10</b>
X	X	X	—	<b>11</b>
X	X	—	X	<b>12</b>
X	—	X	X	<b>13</b>
—	X	X	X	<b>14</b>
X	X	X	X	<b>15</b>

On an eight-position gate, when an adjacent vertical and horizontal position are both maintained, the included diagonal position is also maintained.

**Note**

<sup>①</sup> Momentary operators—spring return to center. For maintained operators add suffix code from table on this page. Example: 10250T451**10**. Operator without latch, maintained in left and right positions.



#### 1

#### Contact Block Operation

Contact blocks mount directly to the back of the operator. For reliable operation, the maximum number of contact blocks that should be installed behind each operator lever is two (four total).

The figure below identifies the circuits activated by each of the eight possible lever positions. Contact block plungers 1, 2, 3, 4 are depressed (change state) when handle is in the position indicated by arrows below.

#### Circuit Activation

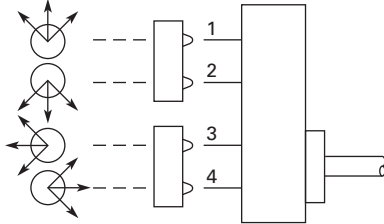

**Note:** Joystick in its resting state, center position, does not activate contact block plungers.

#### Ordering Example:

Suppose you are looking for a four-position momentary joystick without a latch and the following circuit arrangements. X = Closed Circuit, O = Open Circuit.

#### Example Circuit Arrangements

Circuit	Up	Down	Left	Right
1st	X	X	X	X
2nd	X	O	O	X

The contact blocks and their mounting locations would be as follows:

#### Example Contact Blocks and Locations

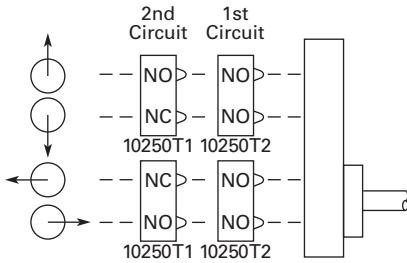

A complete bill of material for this example would include:

#### Example Order

Qty.	Catalog Number
1	10250T451
2	10250T2
2	10250T1

#### Blank Legend Plates for Joystick Operators

When ordering engraved legend plates, order by catalog number and insert the following into order notes:

- Legend required
- Size of characters: 3/16, 1/8, 3/32 in (4.8, 3.2, 2.4 mm)
- Location by letter (A–N)

Locations K and M can accommodate up to two lines horizontally; L and N up to two lines vertically.

Maximum number of characters:

- Horizontal  
3/16 in—13, 1/8 in—14, 3/32 in—19
- Vertical  
3/16 in—10, 1/8 in—13, 3/32 in—14

#### Ordering Example:

Two-position legend plate to be marked “UP” “DOWN.”

Catalog No. **10250TJ2S4STAMP**

Letter Size: 3/16 in (4.8 mm)

Pos. K—UP

Pos. M—DOWN

#### Two-Position

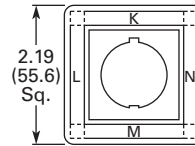

Catalog Number

Blank Plate

10250TJS3

Engraved Plate

10250TJS3STAMP

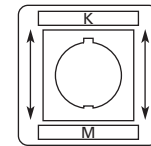

Catalog Number

Blank Plate

10250TJS4

Engraved Plate

10250TJS4STAMP

#### Four-Position

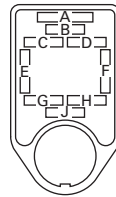

Catalog Number

Blank Plate

10250TJS1

Engraved Plate

10250TJS1STAMP

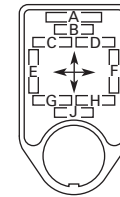

Catalog Number

Blank Plate

10250TJS2

Engraved Plate

10250TJS2STAMP

### Roto-Push Units

#### Two-Position Momentary

Complete assembled two-position Roto-Push® Units are listed below. These operators have black flush buttons and are arranged for vertical mounting. Order legend plates separately.

#### Mounting Location

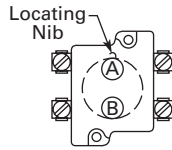

#### Roto-Push—Black Flush Button



#### Roto-Push Units—UL (NEMA) Type 3, 3R, 4, 4X, 12, 13

Typical Applications (Most Common Examples)	Operator Position ①		Collar Right		Contact Type	Mounting Location		Catalog Number ②
	Collar Left	Depressed	Normal	Depressed		A	B	
Two-Position FORWARD/REVERSE; HIGH/LOW; OPEN/CLOSE; UP/DOWN; etc.	Normal	Depressed	Normal	Depressed	1NO	A		10250T2411-2
	0	0	0	X	1NO		B	
JOG/RUN; MAN./AUTO; etc.	Normal	Depressed	Normal	Depressed	1NO	A		10250T24111-2
	0	X	0	X	1NO		B	
RUN/JOG; START/JOG; etc.	Normal	Depressed	Normal	Depressed	1NO	A		10250T24111-1
	X	X	0	0	1NC		B	
SAFE/RUN; etc.	Normal	Depressed	Normal	Depressed	1NO	A		10250T2415-2
	0	0	0	X	1NO		B	

#### Two-Position Latched

The two-position Roto-Push Latch Unit is fully assembled and only requires a legend plate for a great variety of applications. When the selector collar is in the extreme left position, the button is in the free or normal position and can be operated as a standard pushbutton. Rotating the collar to the

extreme right position automatically depresses and latches the button in the depressed position. The white filled groove in the button indicates the selector collar position. The selector collar has spring return to the left position except when in the extreme right latched position.

#### Red Long



#### Rotates to a Latch-Out Mode

Color and Type of Button	Contact Block	Vertical Mounting Catalog Number
Red long	1NC	10250T72
	2NC	10250T73

#### Notes

- ① X = closed circuit, 0 = open circuit.
- ② Roto-Push assembled with contact blocks.

#### 1

### Roto-Push Operators

#### Roto-Push Components

A Roto-Push control unit combines the function of a pushbutton and a selector switch. The contacts are operated by the combined action of rotating the outer collar and pushing a button contained in the collar.

In selecting the cam and contact blocks for the listed function, the analysis involves considering the function with the collar rotated to the given position with the button free (designated as “N”) and then in that same position with the button depressed (designated “D”). This is done for each rotational position of the collar.

#### When Ordering Specify

- Catalog number of operator with cam code suffix from tables below and on following pages, Example: 10250T2411.
- Catalog number(s) for contact blocks and legend plates if required.
- To select the cam and contact blocks needed for two-position and three-position switches, use the tables on following pages.

#### Operator and Cam



#### Operator and Cam

Color and Type of Button	Cam Code No. Select from Tables	Vertical Mounting Catalog and Code Number	Horizontal Mounting Catalog and Code Number
Black flush	+ 1 to 18	10250T241_	10250T251_
Red flush <sup>①</sup>		10250T242_	10250T252_
Green flush		10250T243_	10250T253_
Black long		10250T261_	10250T271_
Red long <sup>①</sup>		10250T262_	10250T272_
Green long		10250T263_	10250T273_

#### Two-Position Roto-Push Operator—Rotates to a Latch-Out Mode Special Rotor Latch

This differs from the other Roto-Push operators in that as the collar is rotated to the right it depresses the button and releases the button when rotated left. But the button in the released position can be momentarily pushed independent of the collar or

its position. As the button is depressed by rotating the collar, the button also rotates and indicates its mode by a white line on the button face. This button can be used as an emergency stop or latched stop.

#### Special Roto Latch— Red Long Button











































#### Special Roto Latch— UL (NEMA) Type 3, 3R, 4, 4X, 12, 13

Color and Type of Button	Vertical Mounting Catalog Number
Red long	10250T3213
Black long	10250T3214

#### Note

<sup>①</sup> Not to be used for emergency stop application.

### Cam and Contact Block Selection for Two-Position Roto-Push

Combination Number	Collar Position		Circuit Sequence <sup>①</sup>		Cam Code 1	Cam Code 2	Cam Code 3	Cam Code 4	Cam Code 5	Cam Code 6
	N	D	N	D						
1	0	0	0	X	A  NO	A  NO	—	—	A  NO	—
2	0	0	X	0	—	—	—	A  NO B  NO	A  NO B  NO	—
3	0	0	X	X	—	—	—	—	B  NO	A  NO
4	0	X	0	0	B  NO	A  NO B  NO	—	—	—	A  NO B  NO
5	0	X	0	X	A  NO B  NO	B  NO	—	A  NO	—	—
6	0	X	X	0	—	—	—	—	—	—
7	0	X	X	X	—	—	A or B NO	B  NO	—	B  NO
8	X	0	0	0	—	—	A or B NC	B  NC	—	B  NC
9	X	0	0	X	—	—	—	—	—	—
10	X	0	X	0	A  NO B  NO	B  NO	—	A  NO	—	—
11	X	0	X	X	B  NO	A  NO B  NO	—	—	—	A  NO B  NO
12	X	X	0	0	—	—	—	—	B  NO	A  NO
13	X	X	0	0	—	—	—	A  NO B  NO	A  NO B  NO	—
14	X	X	X	0	A  NO	A  NO	—	—	A  NO	—

### Series and Parallel Connections

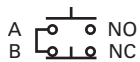

Series Connection



Parallel Connection

The connections are not made at the factory. They are illustrated in the selection table as requirements, but must be made on the job.

### Circuit Location

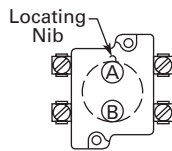

Letters "A" and "B" represent the locations which the two circuits of a contact block will occupy in relation to the locating nib of the operator.

### Note

① N = Button in free or normal position. D = Button depressed.

#### Cam and Contact Block Selection for Two-Position Roto-Push, continued

Combination Number	Collar Position		Circuit Sequence ①		Cam Code 10	Cam Code 11	Cam Code 12	Cam Code 13	Cam Code 14
	N	D	N	D					
15	0	0	0	X	—		—	—	—
16	0	0	X	0	—		A	A or B NC	A
17	0	0	X	X	B	B	—	—	—
18	0	X	0	0	A		—	—	B
19	0	X	0	X	—	A	B	—	—
20	0	X	X	0	—	—	—	—	A
21	0	X	X	X	A	A	A	—	—
22	X	0	0	0	A	A	A	—	—
23	X	0	0	X	—	—	—	—	A
24	X	0	X	0	—	A	B	—	—
25	X	0	X	X	A	A	—	—	B
26	X	X	0	0	B	B	—	—	—
27	X	X	0	0	—		A	A or B NO	A
28	X	X	X	0	—	A	—	—	—

#### Series and Parallel Connections



Series Connection



Parallel Connection

The connections are not made at the factory. They are illustrated in the selection table as requirements, but must be made on the job.

**Note**

① N = Button in free or normal position. D = Button depressed.

#### Circuit Location

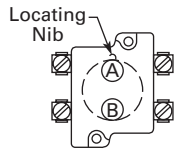

Letters “A” and “B” represent the locations which the two circuits of a contact block will occupy in relation to the locating nib of the operator.

### Cam and Contact Block Selection for Three-Position Roto-Push

Combination Number	Collar Position						Cam Code 7	Cam Code 8	Cam Code 9	Cam Code 15 <sup>②</sup>	Cam Code 16	Cam Code 17	Cam Code 18
	N	D	N	D	N	D							
1	0	0	0	0	0	X			—			—	
2	0	0	0	0	X	X	—	—		—	—		—
3	0	0	0	X	0	0	—	—		—	—	—	
4	0	0	0	X	0	X	—	—	—	—	—	—	
5	0	0	0	X	X	X	—	—		—	—	—	—
6	0	0	X	X	0	0	—		—	—	—	—	—
7	0	0	X	X	0	X	—		—	—	—	—	—
8	0	0	X	X	X	0		—	—	—	—	—	—
9	0	0	X	X	X	X		—	—	—	—	—	—
10	0	X	0	0	0	0			—				
11	0	X	0	0	0	X		—	—			—	—
12	0	X	0	0	X	X	—	—	—	—	—		—
13	0	X	0	X	0	0	—	—	—	—	—	—	
14	0	X	0	X	0	X	—	—	—	—	—	—	
15	0	X	X	X	0	0	—		—	—	—	—	—
16	0	X	X	X	0	X	—		—	—	—	—	—
17	0	X	X	X	X	X		—	—	—	—	—	—

#### Series and Parallel Connections

**Series Connection**

**Parallel Connection**

The connections are not made at the factory. They are illustrated in the selection table as requirements, but must be made on the job.

#### Circuit Location

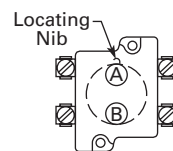

Letters “A” and “B” represent the locations which the two circuits of a contact block will occupy in relation to the locating nib of the operator.

#### Notes

- ① N = Button in free or normal position. D = Button depressed.
- ② Limited to 4 contact blocks. See Note on **Page V7-T1-246**.

#### Cam and Contact Block Selection for Three-Position Roto-Push, continued

Combination Number	Circuit Sequence <sup>①</sup>						Cam Code 7	Cam Code 8 <sup>②</sup>	Cam Code 9	Cam Code 15	Cam Code 16	Cam Code 17	Cam Code 18		
	N	D	N	D	N	D									
18	X	0	0	0	0	0	A  NC B  NC	—	—	—	—	—	—		
19	X	0	0	0	X	X	—	A	NC	—	—	—	—		
20	X	0	0	0	X	0	—	A	NC	—	—	—	—		
21	X	0	X	X	0	0	—	—	—	—	—	A	NC		
22	X	0	X	X	X	X	A	NC	A	NC	—	A	NC	A	NC
23	X	0	X	X	X	0	A	NC	—	—	—	A	NC		
24	X	0	X	0	X	0	—	—	—	A	NC	—	A	NC	
25	X	0	X	0	X	X	—	—	—	A	NC	—	A	NC	
26	X	X	0	0	0	0	B	NC	A	NC	—	—	—		
27	X	X	0	0	0	X	A	NO	NC	—	—	—	—		
28	X	X	0	0	X	0	—	B	NC	—	—	—	—		
29	X	X	0	0	X	X	—	A	NC	A	NC	—	—		
30	X	X	X	X	0	0	—	—	B	NC	—	A	NC		
31	X	X	X	X	X	0	A	NC	A	NO	—	B	NC	A	NO
32	X	X	X	0	X	0	—	—	—	B	NC	—	B	NC	
33	X	X	X	0	X	X	—	—	—	A	NO	—	A	NC	

#### Series and Parallel Connections

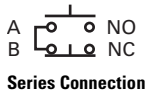

The connections are not made at the factory. They are illustrated in the selection table as requirements, but must be made on the job.

#### Circuit Location

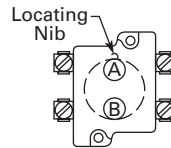

Letters "A" and "B" represent the locations which the two circuits of a contact block will occupy in relation to the locating nib of the operator.







#### Notes

- ① N = Button in free or normal position. D = Button depressed.
- ② Limited to 4 contact blocks. See Note on **Page V7-T1-246**.

### Accessories

Padlocks not included with padlocking attachments. For operators with built-in padlock attachment, see **Page V7-T1-200**.

#### Accessories

	Description	Catalog Number
<b>Padlock Attachments</b>		
	<b>10250TA2</b> <b>Padlocking Attachment for Flush Pushbutton Operators</b> Permits locking NC contacts in open position with 1/4 in padlock. Will not lock NO contact.	10250TA2
	<b>10250TA26</b> <b>Padlocking Attachment for Use with Extended Pushbutton</b> Permits locking NC contacts in open position with 1/4 in padlock.	10250TA26
	<b>10250TA36</b> <b>Padlocking Cover Guard</b> Cover locked over flush button makes it unaccessible or on extended button locks NC contacts open. Takes 1/4 in shank size padlock.	10250TA36
	<b>10250TA38</b> <b>Padlock Hasp or Flip-Up Guard</b> When used with a 1/4 in padlock, makes flush and long button and knob selector switch unaccessible, but not locked down. Without the padlock, it is a flip-up guard. Padlock hasp can be removed before assembly.	10250TA38
	<b>10250TA63</b> <b>Padlocking Attachment for Use with Flexible Weather Resistant Boot</b> Used on long button operators. Stainless steel. Use only for locking NC contacts open.	10250TA63
	<b>10250TA64</b> <b>Padlock Attachment</b> For use with illuminated pushbuttons and maintained push-pull operators having standard button or lens only. Use 1/4 in padlock. Locks in down position only.	10250TA64
	<b>10250TA11</b> <b>Padlocking Attachment for Non-Illuminated Knob Selector Switches</b> Provision for up to 5, 1/4 in padlocks.	10250TA11









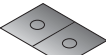

## Accessories, continued

	Description	Catalog Number
<b>Shrouds and Guards</b>		
<b>10250TA6</b> 	<b>Shroud for Mushroom Head Operator</b> Prevents accidental operation. (Not for push-pull operators.)	<b>10250TA6</b>
<b>10250TA12</b> 	<b>Extended Retaining Nut</b> Replaces standard nut and provides guard for flush head pushbutton operators.	<b>10250TA12</b>
<b>10250TA15</b> 	<b>Guard for Illuminated Pushbutton</b>	<b>10250TA15</b>
<b>10250TA56_</b> 	<b>Shroud</b> For jumbo mushroom head operator.	
	Gray	<b>10250TA56</b>
	Yellow	<b>10250TA56Y</b>
<b>10250ED1241</b> 	<b>Half Shroud</b> —Yellow For jumbo mushroom head operator.	<b>10250ED1241</b>
<b>10250TA101</b> 	<b>Fingerproof Shroud</b> —10 per package Fits new style contact blocks and light units.	<b>10250TA101</b>
<b>Boots</b>		
<b>10250TA_</b> 	<b>Flexible Weather Resistant Boot</b> For use with button operators (extended buttons preferred). Temperature to –25°F (–32°C). (See <b>Page V7-T1-239</b> for 10250TA96 Tightening Tool.)	
	Black	<b>10250TA3</b>
	Red	<b>10250TA4</b> ①
	Green	<b>10250TA10</b>
<b>10250TA25</b> 	<b>Transparent Boot</b> For regular illuminated pushbutton operators and PresTest— Temperature to –38°F (–39°C). ②	<b>10250TA25</b>
<b>10250TA4_</b> 	<b>Boot for Flush Pushbutton</b>	
	Clear	<b>10250TA46</b>
	Black	<b>10250TA47</b>
	Red	<b>10250TA48</b>
	Green	<b>10250TA49</b>

**Notes**

- ① Should not be used on flush button for STOP function.
- ② Not suitable for single contact block depth cast enclosure. Cover is too thick.

### Accessories, continued

	Description	Catalog Number
<b>Hardware and Kits</b>		
<b>10250TK3</b> 	<b>Thrust Washers</b> — To meet Ford Motor Co. mounting specifications.	<b>10250TK3</b>
<b>10250TK5</b> 	<b>Contact Block Tape Seal</b> — Seals plunger openings on last contact block. Order in multiples of 10 pieces.	<b>10250TK5</b>
<b>56-9337</b> 	<b>Selector Switch Operator Gasket</b> — Seals out dust from getting in-between the cam and contact block plungers. Supplied as standard with all selector switches.	<b>56-9337</b>
<b>10250TA3</b> 	<b>Special Retaining Nut</b> — To accommodate thick panel: Indicating lights	<b>10250TA30</b>
	PresTest, pushbuttons and selector switches	<b>10250TA31</b>
<b>10250TA62</b> 	<b>Terminal Block</b> — Two terminals, each will accommodate two wire terminations.	<b>10250TA62</b>
<b>10250TA8</b> 	<b>Spacer Ring</b> — Used when legend plate is not required.	<b>10250TA8</b>
<b>10250TA79</b> 	<b>Stacking Screw</b> — Replaces transformer mounting screws on indicating light so terminal block 10250TA62 can be mounted to light to support and connect a series resistor. This screw also fits all contact blocks. Order in multiples of 10.	<b>10250TA79</b>
<b>10250TA2</b> 	<b>Base Mounting Spacers</b> ①— Equivalent to contact block in depth (one block deep).	<b>10250TA22</b>
	Complete with screws, washers, etc. (two block deep).	<b>10250TA23</b>
<b>10250TKG</b> 	<b>Grounding Kits</b> — Kits consist of a ring connector and a #6 screw for mounting connector to rear of contact block mounting screw. All components except standard indicating lights and PresTest indicating lights.	<b>10250TKG1</b>
	Standard indicating lights	<b>10250TKG2</b> ②
	PresTest indicating lights	<b>10250TKG3</b> ②
<b>10250TA7</b> 	<b>Contact Block Terminal Jumpers</b> — Available in multiples of 100 only. Terminal to terminal—within block (short)	
	100 per pkg.	<b>10250TA70</b>
	1000 per pkg.	<b>10250TA70-2</b>
	Terminal to terminal—block to block (long)	
	100 per pkg.	<b>10250TA71</b>
	1000 per pkg.	<b>10250TA71-2</b>

#### Notes

- ① Component only. Not to be used for custom built (factory assembled) stations.
- ② Not suitable for single contact block depth cast enclosure. Cover is too thick.









## Accessories, continued

	Description	Catalog Number
<b>Special Operators and Attachments</b>		
<b>10250TA5</b> 	<b>Wobble Stick</b> Complete with retaining nut—fits standard button.	<b>10250TA5</b>
<b>10250TA14</b> 	<b>Lever Operator</b> For use with two vertically mounted flush pushbuttons.	<b>10250TA14</b>
<b>10250TA</b> 	<b>Maintained Contact Attachment Release Button Assembly</b> <sup>①</sup> Mechanically interlocks with another pushbutton and contact block (not included). Provides mode indication. Minimum hole centers 1.62 in (41.1 mm), maximum 2.313 in (58.8 mm).	
	Black	<b>10250TA17</b>
	Red	<b>10250TA18</b>
	Green	<b>10250TA19</b>
	Yellow	<b>10250TA20</b>
	Same with Long Button—Black	<b>10250TA39</b>
<b>10250TA1</b> 	<b>Maintained Contact Attachment</b> <sup>①</sup> Mechanically interlocks two buttons and provides position indication for one. Use with two pushbutton operators and one or more contact blocks.	<b>10250TA1</b>
<b>10250TA13</b> 	<b>Roto-Push Lever Operator</b> — Used to provide lever operation for Roto-Push operators.	<b>10250TA13</b>
<b>Special Light Modules</b>		
<b>10250TA79</b> 	<b>Master Test (Dual Input) Module</b> — Internal Form C relay suitable for either AC or DC applications. Total electrical isolation between monitored and test circuit. Fits all illuminated 10250T, E22, E30 and E34 devices.	
	48 Vdc	<b>10250TMT8</b>
<b>10250TFL</b> 	<b>Flasher Module</b> — Changes any AC illuminated device to a controlled flashing light. Fits 10250T, E30 and E34 devices.	
	24V	<b>10250TFL2</b>
	120V	<b>10250TFL1</b>
<b>10250ED986-4</b> 	<b>Flashing Incandescent Lamp</b> — For use with 120V transformer type or 6V full voltage type indicating lights including PresTest and most E29 devices.	<b>10250ED986-4</b>

**Note**

<sup>①</sup> Not suitable for single contact block depth cast enclosure. Cover is too thick.

### Accessories, continued

	Description	Catalog Number
<b>Hole Plugs</b>		
	<b>10250TA7 Plug</b> — For unused holes—steel, painted gray (stainless steel, use <b>E30KT5</b> , see <b>Page V7-T1-185</b> )	<b>10250TA7</b>
<b>Tools</b>		
	<b>10250TA95</b> Octagonal 10250T (notched to fit over selector switch lever), E29 and E30	<b>10250TA95</b>
	<b>E22CW</b> E22, E30, E34 and octagonal 10250T (will not fit over selector switch levers)	<b>E22CW</b>
	<b>10250TA96 Tool for Tightening Boots</b> — Used to install boot Catalog Numbers 10250TA3, A4, A10 and A25.	<b>10250TA96</b>
	<b>10250TA102 10250T, E34 Allen Wrench</b> — Used for removal of jumbo mushroom head.	<b>10250TA102</b>
	<b>10250TA74 Lamp Removal Tools</b> — For transformer type illuminated pushbuttons, push-pull and selector switches. Fits #12 lamp.	<b>10250TA74</b>
	<b>E30KV1</b> For full voltage and resistor type illuminated pushbuttons, push-pull and selector switches and E30.	<b>E30KV1</b>
	<b>E29KLT</b> Standard indicating lights. Fits #44, #755, #6S6 and #10S6.	<b>E29KLT</b>

# 1

## Options

### Legend Plates

#### Legend Plates with Standard Markings

The legend plates listed below are sized for all standard commercial enclosures and Eaton’s cast enclosures. For vertical

spacing less than 1.75 in, replace the **S** in the catalog number with **MS**, or the **M** with **P** (except push-pull). No change in price. The smaller

size legend plates, “MS” or “P” size, have limited space for legend.

#### Square Legend Plate



#### 1/2 Round Legend Plate



#### For Pushbutton Operators and Indicating Lights—Standard

Legend	Color of Field	Square ① Catalog Number	1/2 Round Catalog Number	Legend	Color of Field	Square ① Catalog Number	1/2 Round Catalog Number
<b>Blank—see table on Page V7-T1-242.</b>							
<b>Letters on Legend Plates Below are 3/16 in High</b>							
CLAMP	Black	10250TS90	10250TM90	OFF	Red	10250TS24	10250TM24
CLOSE		10250TS73	10250TM11	ON	Black	10250TS25	10250TM25
DOWN		10250TS74	10250TM12	OPEN		10250TS26	10250TM26
EMERG. STOP	Red	10250TS13	10250TM13	OUT		10250TS27	10250TM27
FAST	Black	10250TS75	10250TM14	POWER ON		10250TS80	10250TM80
FASTER		10250TS87	10250TM87	RAISE		10250TS28	10250TM28
FEEDER ON		10250TS94	10250TM94	READY		10250TS86	10250TM86
FEEDER OFF		10250TS95	10250TM95	RESET		10250TS29	10250TM29
FORWARD		10250TS15	10250TM15	REVERSE		10250TS30	10250TM30
HIGH		10250TS16	10250TM16	RUN		10250TS31	10250TM31
IN		10250TS17	10250TM17	SAFE		10250TS85	10250TM85
INCH		10250TS18	10250TM18	SLOW		10250TS32	10250TM32
JOG		10250TS19	10250TM19	SLOWER		10250TS88	10250TM88
JOG FOR.		10250TS20	10250TM20	START		10250TS33	10250TM33
JOG REV.		10250TS21	10250TM21	STOP	Red	10250TS34	10250TM34
LOW		10250TS22	10250TM22	TEST	Black	10250TS83	10250TM83
LOWER		10250TS23	10250TM23	TRANSFER		10250TS93	10250TM93
LUBE-FAIL		10250TS92	10250TM92	TRIP		10250TS84	10250TM84
MOTOR RUN		10250TS81	10250TM81	UNCLAMP		10250TS91	10250TM91
MOTOR STOP		10250TS82	10250TM82	UP		10250TS35	10250TM35

#### Blank Plastic Legend Plates—Square

Color Lettering	Field	Standard Catalog Number	Jumbo ② Catalog Number	Extra Large Catalog Number
Black	White or silver ③	10250TSP76	10250TLP76	10250TEP76
White	Red or black ③	10250TSP77	10250TLP77	10250TEP77

#### Notes

- ① Square legend plates have a satin aluminum field. Color is on lower portion.
- ② Cannot be used on cast enclosures except for top row. Suitable for most sheet metal enclosures.
- ③ If legend plate is to be engraved, specify field color required.

### Square Legend Plate



### 1/2 Round Legend Plate



### For Selector Switch and Roto-Push Operators—Standard Size

Legend	Color of Field	Square <sup>①</sup> Catalog Number	1/2 Round Catalog Number	Legend	Color of Field	Square <sup>①</sup> Catalog Number	1/2 Round Catalog Number
<b>Blank—see table on Page V7-T1-242.</b>							
<b>2-Position—5/32 in High Lettering</b>				<b>3-Position—1/8 in High Lettering</b>			
FOR. REV.	Black	10250TS38	10250TM38	AUTO OFF HAND	Black	10250TS49	10250TM49
HAND AUTO		10250TS39	10250TM39	FOR. OFF REV.		10250TS50	10250TM50
HIGH LOW		10250TS40	10250TM40	FOR. SAFE REV.		10250TS69	10250TM69
JOG RUN		10250TS41	10250TM41	HAND OFF AUTO		10250TS51	10250TM51
MAN. AUTO		10250TS67	10250TM67	MAN. OFF AUTO		10250TS68	10250TM68
OFF ON		10250TS42	10250TM42	OPEN OFF CLOSE		10250TS53	10250TM53
OPEN CLOSE		10250TS43	10250TM43	RUN SAFE JOG		10250TS70	10250TM70
RUN JOG		10250TS44	10250TM44	UP OFF DOWN		10250TS54	10250TM54
SAFE RUN		10250TS45	10250TM45	ON STOP SAFE	Red	10250TS71	10250TM71
START JOG		10250TS46	10250TM46				
START STOP		10250TS47	10250TM47				
UP DOWN		10250TS48	10250TM48				

### 70 mm Round—Plastic Legend Plate



### 45 mm and 70 mm Plastic—Round

Color	Lettering	Field	Catalog Number
<b>45 mm</b>			
Blank		Yellow or red <sup>②</sup>	10250TRP78
<b>70 mm</b>			
Blank		Yellow or red <sup>②</sup>	10250TRP76
Red	EMERG. STOP	Yellow	10250TRP79

### For Push-Pull Units <sup>③</sup>

Legend	Color of Field	Square <sup>①</sup> Catalog Number	1/2 Round Catalog Number
<b>Standard Size—Letters on Legend Plates Below are 3/32 in High</b>			
PULL START/PUSH STOP	Green/red	10250TPP2	10250TR2
PUSH ON/PULL OFF	Black	10250TPP5	10250TR5
PULL OPEN/PUSH CLOSE	Black	10250TPP8	10250TR8
PULL UP/PUSH DOWN	Black	10250TPP11	10250TR11
<b>Jumbo Size—Letters on Legend Plates Below are 1/8 in High</b>			
PULL START/PUSH STOP	Green/red	10250TPP3	10250TR3
PULL ON/PUSH OFF	Black	10250TPP6	10250TR6
PULL OPEN/PUSH CLOSE	Black	10250TPP9	10250TR9
PULL UP/PUSH DOWN	Black	10250TPP12	10250TR12

#### Notes

- ① Square legend plates have a satin aluminum field. Color is on lower portion.
- ② If legend plate is to be engraved, specify field color required.
- ③ All push-pull legend plates include the symbols ≠ ∅ in the center of the plate.

#### 1

#### Legend Plates with Non-Standard Markings

##### When Ordering Specify

- Catalog number of blank plate phase plus Suffix "STAMP"
- Insert the following into Order Notes: legend, letter size and locations (letters A–W)—combine letters for definitive locations as shown.

##### Ordering Example:

Catalog No.: **10250TS36STAMP**  
 Letter Size: 3/32 in (2.4 mm)  
 Pos. A—POWER HOUSE  
 Pos. B—START PUMP 1

##### Legend Characters Available

A B C D E F G H I J K L M N O  
 P Q R S T U V W X Y Z / - . , 1  
 2 3 4 5 6 7 8 9 0

Legend characters on black and red plates are white—on satin aluminum plates, characters are black.

##### Blackening Kit

Solution blackens aluminum exposed by engraving process. Must be applied immediately after engraving. 0.3 oz. bottle—sufficient for approximately 1100 legend plates.

Catalog Number: **10250TBK**

#### Legend Positions

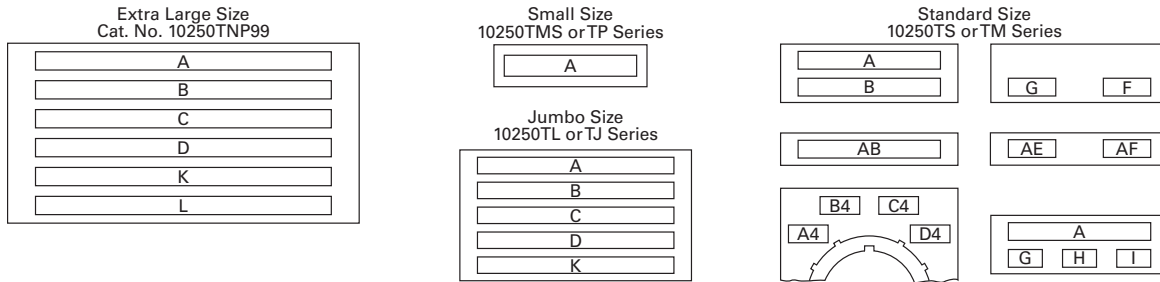

#### Blank and Custom Engraved Legend Plates

Style	Color	Small Catalog Number	Standard Catalog Number	Jumbo <sup>②</sup> Catalog Number	Extra Large <sup>③</sup> Catalog Number	Four-Position Selector Switch		Push-Pull with Symbols <sup>①</sup>	
						Custom <sup>④</sup> Catalog Number	Standard Catalog Number	Standard Catalog Number	Jumbo <sup>②</sup> Catalog Number
Square <sup>⑤</sup>	Black	10250TMS36	10250TS36	10250TL36	—	10250TS76	10250TS72	10250PPP17	10250PPP18
	Red	10250TMS37	10250TS37	10250TL37	—	—	—	—	—
	Green/red	—	—	—	—	—	—	10250PPP20	10250PPP21
	Satin alum.	—	—	—	10250TNP99	—	—	—	—
1/2 Round	Black	10250TP36	10250TM36	10250TJ36	—	—	10250TM72	10250TR17	10250TR18
	Red	10250TP37	10250TM37	10250TJ37	—	—	—	—	—
	Green/red	—	—	—	—	—	—	10250TR20	10250TR21
	Satin alum.	—	10250TM89	10250TJ89	—	—	—	—	—

#### Maximum Characters per Legend Plate and Approximate Dimensions

Top (Aluminum and Plastic)	Approximate Dimensions in Inches (mm)		Style	Character Size 3/32 in High		1/8 in High		3/16 in High	
	Width	Height		Number of Lines	Number of Characters	Number of Lines	Number of Characters	Number of Lines	Number of Characters
Small <sup>⑥</sup>	1.59 (40.4)	1.59 (40.4)	Square	1	17	—	—	—	—
			1/2 Round	1	15	1	12	1	9
Standard and custom	1.75 (44.5)	1.75 (44.5)	Square	2	18	2	13	1	9
			1/2 Round	2	15	2	12	1	9
Jumbo <sup>⑦</sup>	2.19 (55.6)	2.19 (55.6)	Square	5	23	3	18	2	12
			1/2 Round	5	19	4	15	2	11
Extra large <sup>⑧</sup>	2.44 (62.0)	2.44 (62.0)	Square	6	25	3	18	3	12



#### Notes

- <sup>①</sup> All push-pull legend plates include the symbols ≠ ∅ in the center of the plate.
- <sup>②</sup> Cannot be used on cast enclosures except for top row. Suitable for most sheet metal enclosures.
- <sup>③</sup> When used to meet Ford Motor Co. specifications, specify engraved legend. Cannot be used on standard cast or sheet metal enclosures.
- <sup>④</sup> Slightly larger than standard size for legends requiring more space—fits cast enclosures.
- <sup>⑤</sup> Square legend plates have a satin aluminum field. Color is on lower portion.
- <sup>⑥</sup> Recommended only when mounting on minimum centers (less than 1-3/4 in [44.5 mm] vertical centers).
- <sup>⑦</sup> Can be used on top row only of any enclosure.

### Enclosures

#### Die Cast, Polyester and Stainless Steel Enclosures

##### Enclosures (Case and Cover)—Surface Mounting <sup>①</sup>

	Number of Elements	One Contact Block Depth Catalog Number	Two Contact Block Depth Catalog Number
<b>Die Cast Enclosure</b>	<b>Die Cast Enclosure—In-Line <sup>②③④</sup> NEMA 4, 4X, 12, 13</b>		
	1	10250TN1	10250TN11
	2	10250TN2	10250TN12
	3	10250TN3	10250TN13
	4	—	10250TN14
<b>Polyester Enclosure</b>	<b>Polyester <sup>④</sup>—In-Line NEMA 3, 4X, 12</b>		
	1	—	E34N51
	2	—	E34N52
	3	—	E34N53
	4	—	E34N54
<b>Stainless Steel Enclosure</b>	<b>Stainless Steel <sup>④⑤</sup>—In-Line NEMA 4, 4X, 12</b>		
	1	—	10250TN33
	2	—	10250TN34
	3	—	10250TN35
	4	—	10250TN36

Dimensions, see Page V7-T1-256.

### Mounting Instructions

Two-position joystick must be used with two contact block deep enclosures (maximum number of contact blocks = 1). Four-position joysticks cannot be used within these enclosures.

#### One and Two Contact Block Depth Enclosures



#### Enclosure Layouts

Top – For Vertical Mounting

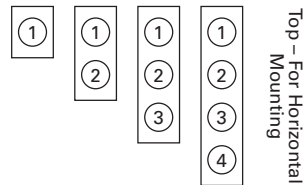

### Notes

- ① For spacing increments, see Page V7-T1-244.
- ② All die cast enclosures can be converted to base mounting of contact blocks, with spacers 10250TA22 or 10250TA23. See listing on Page V7-T1-237.
- ③ When used with E30 pushbuttons, only the one element enclosure can be used.
- ④ When used with resistor light units, only the 2 contact block depth enclosure can be used.
- ⑤ 14 gauge, type 304.



#### Die Cast and Stainless Steel—Flush Mount, Covers Only

##### Flush Mounting Covers



##### Covers Only—Flush Mounting

Number of Elements	Catalog Number	Catalog Number
<b>Flush Die Cast Covers</b>		
	<b>In-Line Deep Cover</b>	<b>In-Line Flat Cover</b>
1	10250TF11	10250TF1
2	10250TF12	10250TF2
3	10250TF13	10250TF3
4	10250TF14	10250TF4
<b>In-Line Stainless Steel Flush Plates</b> ①		
	<b>With Pullbox</b>	<b>Without Pullbox</b>
1	10250TS10	10250TS1
2	10250TS11	10250TS2
3	10250TS12	10250TS3
4	10250TS14	10250TS4
<b>Dimensions, see Page V7-T1-257.</b>		

#### Spacing Increments

Approximate Dimensions in Inches (mm)

Type	F	G	H
Die cast	2.44 (62.0)	2.5 (63.5)	1.88 (47.8)
Polyester	1.88 (47.8)	Min. 2.13 (54.1)	2.25 (57.2)
Stainless steel	1.69 (42.9)	Min. 1.73 (43.9)	2.25 (57.2)

#### Spacing Increments for Enclosures

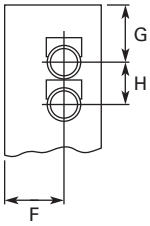

#### Enclosure Layouts

Top – For Vertical Mounting

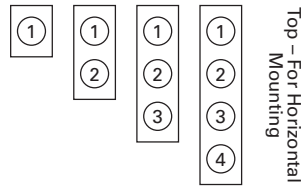

**Note**

① Not oiltight. NEMA 1 applications only.

**Contact Blocks**

**Standard Contact Blocks**

- UL A600/P600 rated
- Color-coded plungers—red/green for NC/NO circuits
- Silver contact tips with “reliability nibs”
- Gray (opaque) or amber (translucent) housings
- Pressure plate or spade terminals
- Fingerproof shrouds (for pressure terminals only)

**Logic Level Contact Blocks**

- UL A600/P600 rated
- Color-coded plungers
- Inert palladium knife-blade contacts
- Gray (opaque) housings
- Pressure plate or spade terminals

**Special Function Contact Blocks**

- UL A600/P600 rated
- Color-coded plungers
- Silver contact tips with “reliability nibs”
- Gray (opaque) housings
- Pressure plate terminals only

**Special Purpose Contact Block**

- Maximum 300V rated
- Black plungers
- Silver contact tips with “reliability nibs”
- Black (opaque) housings
- Pressure plate terminals only
- Fingerproof shrouds not available

**Reliability Nibs**

Reliability nibs are the hallmark of Eaton’s contact blocks. A pointed silver nib on the contact tip ensures reliable switching from logic level (5V) up to 600V applications. Therefore standard contact blocks can be used for most logic level applications where the contacts are not exposed to any harsh environmental conditions.

**Palladium Contacts**

Palladium, which is more inert than gold, is well suited for voltages and currents approaching zero and is recommended for applications where environmental conditions are a factor.

**Maximum Contact Block Mounting per Operator Type**

Operator	Max. Stack
Pushbuttons	6
Push-pull operators	2
Roto-push operators	4
Two- or three-position selector switches	6
Four-position selector switches	4
Joysticks	4

10250T1



Contact Blocks

Symbol	Circuit	Description <sup>①</sup>	Standard	Spade Terminal <sup>②</sup>	Logic Level	Spade Terminal <sup>②</sup>
			Pressure Terminal Catalog Number	Catalog Number	Pressure Terminal Catalog Number	Catalog Number
	1NC	Stack up to six blocks (six circuits) unless otherwise noted.	<b>10250T51</b>	<b>10250T59</b>	<b>10250T51E</b>	<b>10250T59E</b>
	1NO	Stack up to six blocks (six circuits) unless otherwise noted.	<b>10250T53</b>	<b>10250T60</b>	<b>10250T53E</b>	<b>10250T60E</b>
	NO-NC	Stack up to six blocks (12 circuits) unless otherwise noted.	<b>10250T1</b>	<b>10250T40</b>	<b>10250T1E</b>	<b>10250T40E</b>
	2NC	Stack up to six blocks (12 circuits) unless otherwise noted.	<b>10250T3</b>	<b>10250T42</b>	<b>10250T3E</b>	<b>10250T42E</b>
	2NO	Stack up to six blocks (12 circuits) unless otherwise noted.	<b>10250T2</b>	<b>10250T41</b>	<b>10250T2E</b>	<b>10250T41E</b>
<b>Special Function Blocks <sup>③</sup></b>						
	LONC	Late opening NC. Stack up to six blocks (six circuits) unless otherwise noted.	<b>10250T71 <sup>③</sup></b>	—	<b>10250T71E <sup>③</sup></b>	—
	ECNO-NC	Early closing NO and standard NC. Stack up to six blocks unless otherwise noted.	<b>10250T47 <sup>③④</sup></b>	—	<b>10250T47E <sup>③</sup></b>	—
	ECNO-NO	Early closing NO and standard NO. Stack up to four blocks unless otherwise noted.	<b>10250T57 <sup>③④</sup></b>	—	<b>10250T57E <sup>③</sup></b>	—
	2LONC	Two late opening NC contacts. Stack up to six blocks unless otherwise noted.	<b>10250T45 <sup>③</sup></b>	—	<b>10250T45E <sup>③</sup></b>	—
	LONC-ECNO	Overlapping contacts. Stack up to four blocks unless otherwise noted.	<b>10250T55 <sup>③④</sup></b>	—	<b>10250T55E <sup>③</sup></b>	—
<b>Special Purpose Blocks <sup>⑤</sup></b>						
	2NO-2NC	Four circuits in single block depth. Rated 300V max. Stack up to four blocks unless otherwise noted.	<b>10250T44 <sup>⑤</sup></b>	—		

Notes

- ① All 10250T contact blocks shown are suitable for use on standard 10250T and E34 operators. These contact blocks are not suitable for Class I Division 2 type 10250T or E34 devices.
- ② Contact blocks with spade terminals are limited to a maximum of one contact block per operator and minimum spacing between devices is 2.5 in (63.5 mm). Not suitable for use in 10250T or E34 enclosures. Also available in amber housing. Not available with fingerproof shrouds.
- ③ Special function contact blocks are not suitable for use with roto-push operators, three-position push-pull operators, or four-position selector switches.
- ④ ECNO contact blocks are not suitable for use with two-position joysticks or when operators are used with padlock attachments.
- ⑤ Special purpose 10250T44 contact blocks are not suitable on selector switches or roto-push operators. Okay to use with three-position push-pull operators only on low voltage (30V or less) circuits. Fingerproof shrouds not available.

10250T1CP



### Contact Blocks with Fingerproof Shrouds

Symbol	Circuit	Description <sup>①</sup>	Standard Pressure Terminal <sup>②</sup> Catalog Number	Logic Level Pressure Terminal <sup>②</sup> Catalog Number
Blank No Plunger	1NC	Stack up to six blocks (six circuits) unless otherwise noted.	<b>10250T51P</b>	<b>10250T51EP</b>
Blank No Plunger	1NO	Stack up to six blocks (six circuits) unless otherwise noted.	<b>10250T53P</b>	<b>10250T53EP</b>
Blank No Plunger	NO-NC	Stack up to six blocks (12 circuits) unless otherwise noted.	<b>10250T1P</b>	<b>10250T1EP</b>
Blank No Plunger	2NC	Stack up to six blocks (12 circuits) unless otherwise noted.	<b>10250T3P</b>	<b>10250T3EP</b>
Blank No Plunger	2NO	Stack up to six blocks (12 circuits) unless otherwise noted.	<b>10250T2P</b>	<b>10250T2EP</b>
<b>Special Function Blocks <sup>③</sup></b>				
Blank No Plunger	LONC	Late opening NC. Stack up to six blocks (six circuits) unless otherwise noted.	<b>10250T71P <sup>④</sup></b>	<b>10250T71EP <sup>④</sup></b>
Blank No Plunger	ECNO-NC	Early closing NO and standard NC. Stack up to six blocks unless otherwise noted.	<b>10250T47P <sup>③④</sup></b>	<b>10250T47EP <sup>④</sup></b>
Blank No Plunger	ECNO-NO	Early closing NO and standard NO. Stack up to four blocks unless otherwise noted.	<b>10250T57P <sup>③④</sup></b>	<b>10250T57EP <sup>④</sup></b>
Blank No Plunger	2LONC	Two late opening NC contacts. Stack up to six blocks unless otherwise noted.	<b>10250T45P <sup>④</sup></b>	<b>10250T45EP <sup>④</sup></b>
Blank No Plunger	LONC-ECNO	Overlapping contacts. Stack up to four blocks unless otherwise noted.	<b>10250T55P <sup>③④</sup></b>	<b>10250T55EP <sup>④</sup></b>

**Notes**

- ① All 10250T contact blocks shown are suitable for use on standard 10250T and E34 operators. These contact blocks are not suitable for Class I Division 2 type 10250T or E34 devices.
- ② To order contact blocks with translucent amber housing, change suffix P to **CP** in catalog number e.g. 10250T51**CP**.
- ③ ECNO contact blocks are not suitable for use with two-position joysticks or when operators are used with padlock attachments.
- ④ Special function contact blocks are not suitable for use with roto-push operators, three-position push-pull operators, or four-position selector switches.

## 10250T1C



## Amber Contact Blocks

Symbol	Circuit	Description <sup>①</sup>	Standard	Spade Terminal	Logic Level	Spade Terminal
			Pressure Terminal <sup>②</sup> Catalog Number	Catalog Number <sup>③</sup>	Pressure Terminal <sup>②</sup> Catalog Number	Catalog Number <sup>③</sup>
	Blank No Plunger 1NC	Stack up to six blocks (six circuits) unless otherwise noted.	<b>10250T51C</b>	<b>10250T59C</b>	<b>10250T51EC</b>	<b>10250T59EC</b>
	Blank No Plunger 1NO	Stack up to six blocks (six circuits) unless otherwise noted.	<b>10250T53C</b>	<b>10250T60C</b>	<b>10250T53EC</b>	<b>10250T60EC</b>
	NO-NC	Stack up to six blocks (12 circuits) unless otherwise noted.	<b>10250T1C</b>	<b>10250T40C</b>	<b>10250T1EC</b>	<b>10250T40EC</b>
	2NC	Stack up to six blocks (12 circuits) unless otherwise noted.	<b>10250T3C</b>	<b>10250T42C</b>	<b>10250T3EC</b>	<b>10250T42EC</b>
	2NO	Stack up to six blocks (12 circuits) unless otherwise noted.	<b>10250T2C</b>	<b>10250T41C</b>	<b>10250T2EC</b>	<b>10250T41EC</b>
<b>Special Function Blocks <sup>③</sup></b>						
	Blank No Plunger LONC	Late opening NC. Stack up to six blocks (six circuits) unless otherwise noted.	<b>10250T71C <sup>④</sup></b>	—	<b>10250T71EC <sup>④</sup></b>	—
	ECNO-NC	Early closing NO and standard NC. Stack up to six blocks unless otherwise noted.	<b>10250T47C <sup>④⑤</sup></b>	—	<b>10250T47EC <sup>④</sup></b>	—
	ECNO-NO	Early closing NO and standard NO. Stack up to four blocks unless otherwise noted.	<b>10250T57C <sup>④⑤</sup></b>	—	<b>10250T57EC <sup>④</sup></b>	—
	2LONC	Two late opening NC contacts. Stack up to six blocks unless otherwise noted.	<b>10250T45C <sup>④</sup></b>	—	<b>10250T45EC <sup>④</sup></b>	—
	LONC-ECNO	Overlapping contacts. Stack up to four blocks unless otherwise noted.	<b>10250T55C <sup>④⑤</sup></b>	—	<b>10250T55EC <sup>④</sup></b>	—

**Notes**

- <sup>①</sup> All 10250T contact blocks shown are suitable for use on standard 10250T and E34 operators. These contact blocks are not suitable for Class I Division 2 type 10250T or E34 devices.
- <sup>②</sup> To order amber contact blocks with fingerproof shrouds, change suffix to **CP** in the catalog number e.g. 10250T51**CP**. Not available with spade terminals.
- <sup>③</sup> Contact blocks with spade terminals are limited to a maximum of one contact block per operator and minimum spacing between devices is 2.5 in (63.5 mm). Not suitable for use in 10250T or E34 enclosures. Also available in amber housing. Not available with fingerproof shrouds.
- <sup>④</sup> Special function contact blocks are not suitable for use with roto-push operators, three-position push-pull operators, or four-position selector switches.
- <sup>⑤</sup> ECNO contact blocks are not suitable for use with two-position joysticks or when operators are used with padlock attachments.

Replacement Parts

Replacement Lamps—For 10250T Illuminated Operators

Mfg. Lamp Type	Voltage	Base Style	Application	Part Number
120MB	120V	T 3-1/4 bayonet	10250T resistor indicating light	28-3044
#267	6.3V	T 3-1/4 bayonet	10250T flasher	10250ED986-4
#755	6.3V	T 3-1/4 bayonet	10250T transformer, PresTest and full voltage	28-2202
#756	12V	T 3-1/4 bayonet	10250T full voltage	28-5184
#757	24V	T 3-1/4 bayonet	10250T full voltage	28-5185
#1828	32V	T 3-1/4 bayonet	10250T full voltage	28-5186
#1835	55V	T 3-1/4 bayonet	10250T resistor	28-5187
NE48	120V	T 4-1/2 bayonet	10250T neon	28-494
NE51H-R22	120V	T 3-1/4 bayonet	10250T neon	28-3754
NE51H-R68	240V	T 3-1/4 bayonet	10250T neon	28-3755

Standard LED Lamp



Replacement LED Lamps—For 10250T, E34 and E22 Units

Voltage	Color	Continuous AC/DC Catalog Number	Flashing AC Catalog Number	DC Catalog Number
6–12V	Red	E22LED612RN	E22LED006RAF	E22LED006RDF
	Orange	E22LED612ON	E22LED006OAF	E22LED006ODF
	Yellow	E22LED612YN	E22LED006YAF	E22LED006YDF
	Green	E22LED612GN	E22LED006GAF	E22LED006GDF
	Blue	E22LED612BN	E22LED006BAF	E22LED006BDF
	White	E22LED612WN	E22LED006WAF	E22LED006WDF
24V	Red	E22LED024RN	E22LED024RAF	E22LED024RDF
	Orange	E22LED024ON	E22LED024OAF	E22LED024ODF
	Yellow	E22LED024YN	E22LED024YAF	E22LED024YDF
	Green	E22LED024GN	E22LED024GAF	E22LED024GDF
	Blue	E22LED024BN	E22LED024BAF	E22LED024BDF
	White	E22LED024WN	E22LED024WAF	E22LED024WDF
48V	Red	E22LED048RN	E22LED048RAF	E22LED048RDF
	Orange	E22LED048ON	E22LED048OAF	E22LED048ODF
	Yellow	E22LED048YN	E22LED048YAF	E22LED048YDF
	Green	E22LED048GN	E22LED048GAF	E22LED048GDF
	Blue	E22LED048BN	E22LED048BAF	E22LED048BDF
	White	E22LED048WN	E22LED048WAF	E22LED048WDF
60V	Red	E22LED060RN	E22LED060RAF	E22LED060RDF
	Orange	E22LED060ON	E22LED060OAF	E22LED060ODF
	Yellow	E22LED060YN	E22LED060YAF	E22LED060YDF
	Green	E22LED060GN	E22LED060GAF	E22LED060GDF
	Blue	E22LED060BN	E22LED060BAF	E22LED060BDF
	White	E22LED060WN	E22LED060WAF	E22LED060WDF
120V	Red	E22LED120RN	E22LED120RAF	E22LED120RDF
	Orange	E22LED120ON	E22LED120OAF	E22LED120ODF
	Yellow	E22LED120YN	E22LED120YAF	E22LED120YDF
	Green	E22LED120GN	E22LED120GAF	E22LED120GDF
	Blue	E22LED120BN	E22LED120BAF	E22LED120BDF
	White	E22LED120WN	E22LED120WAF	E22LED120WDF

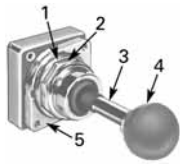

**Two-Position Joystick Operator**



**Flush Head Pushbutton Operator**

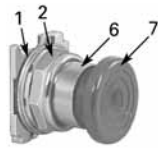

**Mushroom Head Pushbutton Operator**



**Mushroom Head Operator with Padlock Attachment**

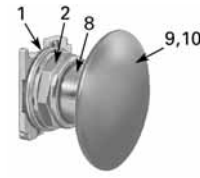

**Jumbo Mushroom Head Operator**

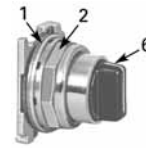

**Knob-Operated Selector Switch Operator**

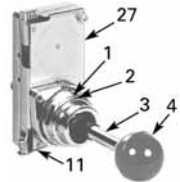

**Four-Position Joystick Operator (without Latch)**



**Illuminated Pushbutton Operator**



**Full Voltage, Resistor and Transformer Type Illuminated Selector Switch**



**Transformer Type Indicating Light**

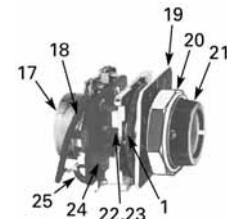

**Potentiometers**

#### 10250T Style Operator Replacement Parts

Item No.	Description	No. Req.	Part Number
1	Gasket	1	16-1548
2	Mounting nut	1	15-1530
3	Handle	1	24-5045
4	Knob	1	53-3157
	Knob (not shown) for joystick operator with latch	1	53-3159
5	Common gate (supplied with operator)	2	16-3400
6	Set screw (#6-32 x 0.250 in long hollow hex)	2	11-2014
7	Mushroom head button (includes [2] Item 6)	1	As Req. Below
	Black	—	53-1317
	Red	—	53-1317-2
	Yellow	—	53-1317-3
	Green	—	53-1317-4
	Blue	—	53-1317-22
8	Set screw (#10-32 x 0.250 in long hollow hex)	2	11-544
9	Jumbo mushroom head button (aluminum—includes [2] Item 8)	1	As Req. Below
	Red	—	53-1317-9
	Black	—	53-1317-10
	Yellow	—	53-1317-11
	Green	—	53-1317-12
10	Jumbo mushroom head button (aluminum—red EMERG. STOP) does not include Item 8	1	53-1349-18
11	Position gate:		
	Two-position	1	54-7278
	Three-position	1	54-7173
	Four-position	1	54-12278
	Eight-position	1	54-12279
12	Mounting screw (#6-32 x 0.710 in long)	2	10250TA79
	Washer	2	16-2038
13	Terminal screw and lug (captives)	Req.	80-5502KIT

Item No.	Description	No. Req.	Part Number
14	Gasket (supplied with basic unit)	1	32-803
15	Round head screw (#4-40 x 0.344 in long) (supplied with basic unit)	2	11-4553
16	Mounting screw	2	11-1632
17	Simple potentiometer (does not include items 18, 28 or 29)	1	As Req. Below
	1,000 ohms	—	41-782-2
	2,500 ohms	—	41-782-3
	5,000 ohms	—	41-782-10
	10,000 ohms	—	41-782-4
	25,000 ohms	—	41-782-5
	50,000 ohms	—	41-782-6
18	Connector (includes screw and lug)	2	25-1851
19	Indicating plate	1	As Req. Above
	Standard size (without legend)	—	30-4460
	Large size (specify legend)	—	10250TR30
20	Retaining nut	1	15-1547
21	Knob	1	53-1314
	Socket set screw (#6-32 x 0.250 in long)	2	11-2014
22	Coupling	1	29-3749-2
23	Set screw (#6-32 x 0.188 in long)	1	11-1199
24	Spacer	2	56-1066-18
25	Connector (includes screw and lug)	1	25-1851-2
26	Mounting nut	1	15-1938
27	Four-position joystick operating mechanism (complete)	1	24-6565
28	Four-position joystick operating mechanism (not shown) (with latch) complete	1	24-6565-2
29	Spring loaded latch	1	52-1214-2
30	Hand operated latch	1	52-913-3

## Technical Data and Specifications

### Mechanical Ratings

Description	Specification
<b>Frequency of Operation</b>	
All pushbuttons	6000 operations/hr.
Key and lever selection switches	3000 operations/hr.
Auto-latch devices	1200 operations/hr.
<b>Life</b>	
Pushbuttons	10 x 10 <sup>6</sup> operations
Contact blocks	10 x 10 <sup>6</sup> operations
PresTest units	10 x 10 <sup>6</sup> operations
Lever and key selector switches	0.25 x 10 <sup>6</sup> operations
Twist to release pushbuttons	0.3 x 10 <sup>6</sup> operations
<b>Shock Resistance</b>	
Duration	20 ms ≥5g

### General Specifications

Description	Specification
<b>Climate Conditions</b>	
Operating temperature	1° to 150°F (–17° to 66°C)
Storage temperature	–40° to 176°F (–40° to 80°C)
Altitude	6,562 ft (2,000m)
Humidity	Max. 95% RH at 60°C
<b>Terminals</b>	
Marking	NC-NO on the contact block to meet the NEMA requirements. Dual marking system 1–2 for normally closed, 3–4 for normally open to meet BS5472 (Cenelec EN50 005).
Clamps	Terminals are saddle clamp type for 1 x 22 AWG (0.34 mm <sup>2</sup> ) to 2 x 14 AWG (2.5 mm <sup>2</sup> ) conductors
Torque	7 lb-in (0.8 Nm)
Degree of protection against direct electrical contact	IP2X with fingerproof shroud
<b>Light Units</b>	
Transformers	Will withstand short-circuit for 1 hour per IEC 60997-5-1
Bulbs—average life:	
Transformer type	20,000 hrs.
Resistor/direct voltage type	2500 hrs. minimum at rated voltage
LED	60,000 to 100,000 hrs.

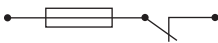

#### Electrical Ratings

Description	Specification
Insulation	$U_i = 660 \text{ Vac or Vdc}$
Thermal	$I_{th} = 10\text{A}$
<b>Short Circuit Coordination to IEC/EN 60947-5-1</b>	
Rated conditional short circuit current	1 kA
Fuse type	GE power controls TIA 10, red spot type gG, 10A, 660 Vac, 460 Vdc, BS88-2, IEC 60269-2-1
	
UL rating	A600, P600
AC load life duty cycle 1200 operations/hour	
10A	110V pf 0.4— $1 \times 10^6$ operations
5A	250V pf 0.4— $1 \times 10^6$ operations
2A	600V pf 0.4— $1 \times 10^6$ operations
Switching capacity	
AC 15 rated make/break ( $11 \times I_b$ at $1.1 \times U_b$ )	
6A	120V pf 0.3
4A	240V pf 0.3
2A	660V pf 0.3
DC13 rated make/break ( $1.1 \times I_b$ at $1.1 \times U_b$ )	
1.0A	125V L/R $\geq 0.95$ at 300 ms
0.55A	250V L/R $\geq 0.95$ at 300 ms
0.1A	660V L/R $\geq 0.95$ at 300 ms
10A	110V pure resistive
Maximum ratings for logic level and hostile atmosphere application	
Maximum amperes	0.5A
Maximum volts	120 Vac/Vdc

#### Electrical Ratings—Contact Block

Description	50 Vac or 60 Hz				Vdc		
	120	240	480	600	24/28	125	250
<b>Meet or Exceed NEMA Rating Designations A600, A300 and B300 for AC and P600 for DC</b>							
Make and emerg. interrupting capacity (amp)	60	30	15	12	5.7	1.1	0.55
Normal load break (amp)	6	3	1.5	1.2	5.7	1.1	0.55
Thermal current (amp)	10	10	10	10	5.0	5.0	5.0
Voltamperes:							
Make and emerg. interrupting capacity	7200	7200	7200	7200	138	138	138
Normal load break	720	720	720	720	138	138	138

**Mounting Options**

**Panel Thickness**

- Minimum: 0.06 in (1.6 mm)
- Maximum: 0.25 in (8 mm) including legend plate
- Maximum can be increased to 0.375 in (15.9 mm) using optional retaining nut
  - Indicating light: 10250TA30
  - Pushbutton/selector switch: 10250TA31

**Mounting Matrix**

Legend Plate	Dimensions in Inches (mm)			
	A	B	C	D
Small	1.63 (41.3)	2.25 (57.2)	2.25 (57.2)	1.63 (41.3)
Medium	1.75 (44.5)	2.25 (57.2)	2.25 (57.2)	1.75 (44.5)
Large	2.25 (57.2)	2.25 (57.2)	2.25 (57.2)	2.25 (57.2)

**Mounting Options in Inches (mm)**

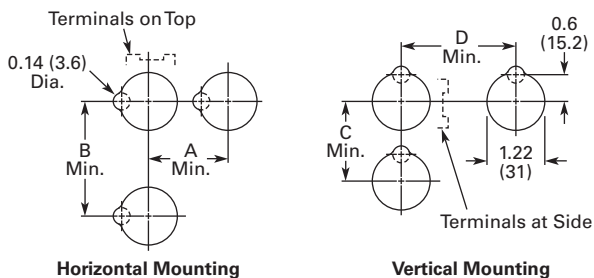

Horizontal mounting means terminals are located top and bottom of contact block. Vertical mounting means terminals are left and right of contact block. This allows close spacing of adjacent operators with easy access to terminals.

Locating nib hole or notch is 0.14 in (3.6 mm) #29 drill.

**Drilling Dimensions in Inches (mm)**

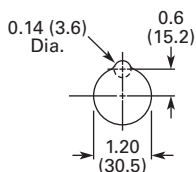

# 1.8

## Pushbuttons and Indicating Lights

30.5 mm Heavy-Duty Watertight/Oiltight—10250T

### 1

### Dimensions

Approximate Dimensions in Inches (mm)

#### Mechanically Interlocked Pushbutton Operators

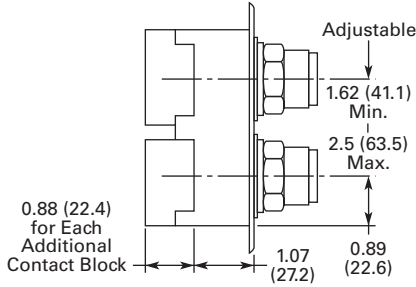

#### Lockout Pushbutton Operator Padlockable in the Down Position

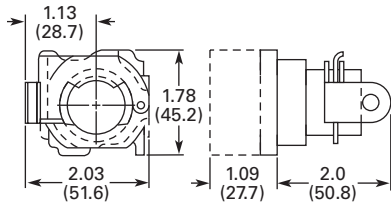

#### Lockout Pushbutton Operator Padlockable in the Up Position—Mushroom Head

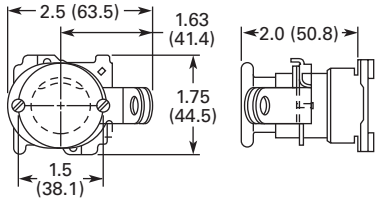

#### Lockout Pushbutton Operator Padlockable in the Up Position—Jumbo Mushroom Head

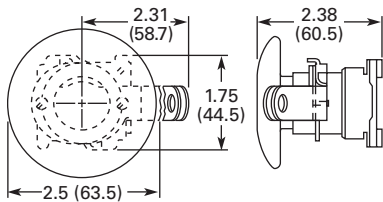

#### Potentiometer

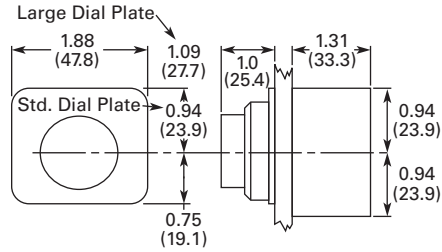

Potentiometer	A	B	C
2 watt single	1.31 (33.3)	0.94 (23.9)	0.94 (23.9)
25 watt—up to 25 mohms	2.38 (60.5)	1.19 (30.2)	0.81 (20.6)
50 mohms	2.56 (65.0)	1.69 (42.9)	1.25 (31.8)

#### Two-Position Joystick Operator

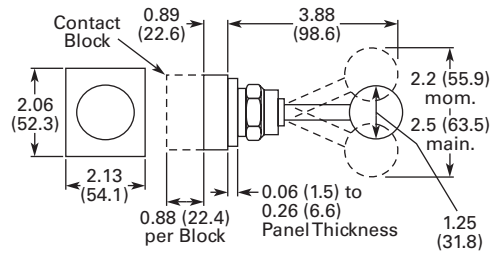

#### Four-Position Joystick Operator

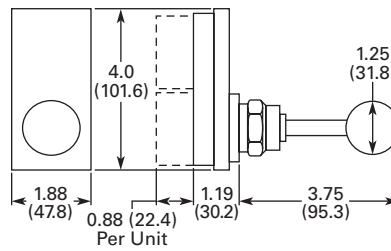

Approximate Dimensions in Inches (mm)

### Key Operated Pushbutton Operator

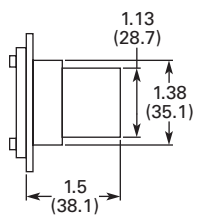

### Operator and Cam

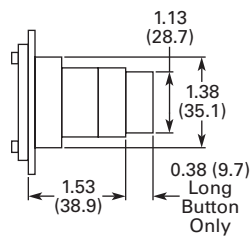

### Latch-In, Twist-to-Release Operator Only with Button

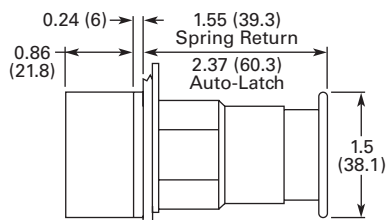

### Special Rotor Latch

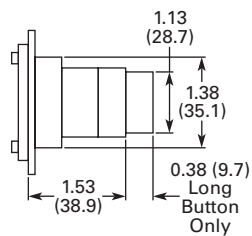

#### 1

Approximate Dimensions in Inches (mm)

#### Surface Mounting

##### Die Cast, Polyester and Stainless Steel Enclosures

4 Mtg. Holes — 10-32 Screw Size for  
 1 – 4 Element Die Cast/  
 Stainless Steel Enclosure  
 7/32 Screw Size for  
 Polyester

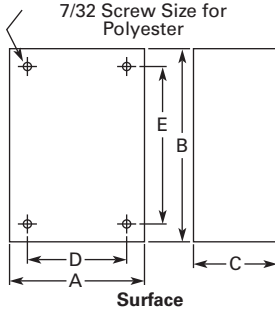

Number of Elements	Element Arrangement	Wide A	High B	Deep C	Mounting D	E	Conduit Entrance
<b>Die Cast</b>							
1	In-line	3.88 (98.6)	4.00 (101.6)	3.00 (76.3) <sup>①</sup>	2.69 (68.3)	3.25 (82.6)	3/4
2		3.88 (98.6)	5.88 (149.4)	3.00 (76.3) <sup>①</sup>	2.69 (68.3)	5.13 (130.3)	
3		3.88 (98.6)	7.75 (196.9)	3.00 (76.3) <sup>①</sup>	2.69 (68.3)	7.00 (177.8)	1
4		3.88 (98.6)	9.63 (244.6)	3.00 (76.3) <sup>①</sup>	2.69 (68.3)	8.88 (225.6)	
<b>Polyester</b>							
1	In-line	3.81 (96.8)	6.63 (168.4)	3.38 (85.9)	2.94 (74.7)	4.88 (124.0)	<sup>②</sup>
2		3.81 (96.8)	6.63 (168.4)	3.38 (85.9)	2.94 (74.7)	4.88 (124.0)	
3		3.81 (96.8)	8.88 (225.6)	3.38 (85.9)	2.94 (74.7)	7.13 (181.1)	
4		3.81 (96.8)	11.13 (282.7)	3.38 (85.9)	2.94 (74.7)	9.38 (238.3)	
<b>Stainless Steel</b>							
1	In-line	3.00 (76.2)	3.50 (88.9)	3.00 (76.2)	1.50 (38.1)	4.25 (108.0)	<sup>②</sup>
2		3.50 (88.9)	6.75 (171.5)	3.00 (76.2)	1.50 (38.1)	7.50 (190.5)	
3		3.50 (88.9)	9.00 (228.6)	3.00 (76.2)	1.50 (38.1)	9.00 (228.6)	
4		3.50 (88.9)	11.25 (285.8)	3.00 (76.2)	1.50 (38.1)	12.00 (304.8)	

#### Notes

- ① Depth given is for two contact block deep stations. One contact block deep stations subtract 3/4 in (19.1 mm).
- ② No conduit entrance holes provided. Drill as required.

Approximate Dimensions in Inches (mm)

### Flush Mounting

#### Die Cast and Stainless Steel Covers Only

4 Mtg. Holes - 10-32 Screw Size  
for 1-11 Element Encl, 1/4-20  
Screw Size for 12 Element  
and Larger

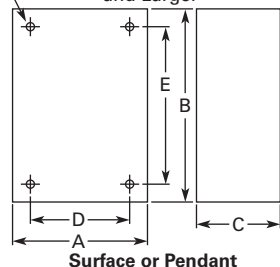

Number of Elements	Wide A	High B	Deep C	Mounting D	E
<b>Die Cast</b>					
1	3.88 (98.6)	4.00 (101.6)	0.25 (6.4) ①	3.50 (88.9)	3.63 (92.2)
2	3.88 (98.6)	5.88 (149.4)	0.25 (6.4) ①	3.50 (88.9)	5.50 (139.7)
3	3.88 (98.6)	7.75 (196.9)	0.25 (6.4) ①	3.50 (88.9)	6.00 (152.4)
4	3.88 (98.6)	9.63 (244.6)	0.25 (6.4) ①	3.50 (88.9)	9.25 (235.0)
<b>Stainless Steel</b>					
1	5.00 (127.0)	5.00 (127.0)	2.50 (63.5) ②	3.25 (82.6)	1.88 (47.8)
2	5.00 (127.0)	6.88 (174.8)	2.50 (63.5) ②	3.25 (82.6)	3.63 (92.2)
3	5.00 (127.0)	8.63 (219.2)	2.50 (63.5) ②	3.25 (82.6)	5.50 (139.7)
4	5.00 (127.0)	10.50 (266.7)	2.50 (63.5) ②	3.25 (82.6)	7.25 (184.2)

**Notes**

- ① Depth given is for flat cover. Deep cover is 3/4 in (19.1 mm) deeper.
- ② Depth given includes pull box.

# 1.8

## Pushbuttons and Indicating Lights

30.5 mm Heavy-Duty Watertight/Oiltight—10250T

1

Approximate Dimensions in Inches (mm)

### Flush and Long Pushbutton Half Shroud

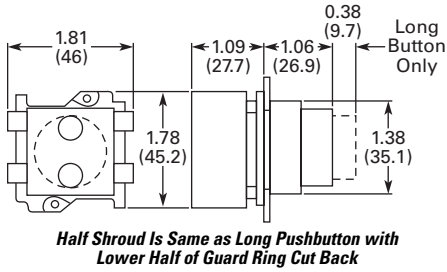

### Push-Pull Switch

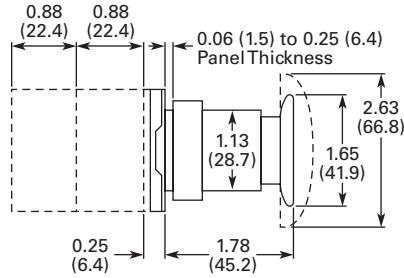

### Mushroom and Jumbo Head Pushbutton

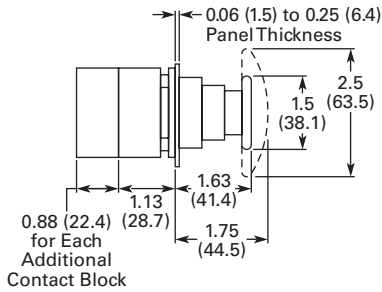

### Flush Pushbutton Operator with Padlock Attachment

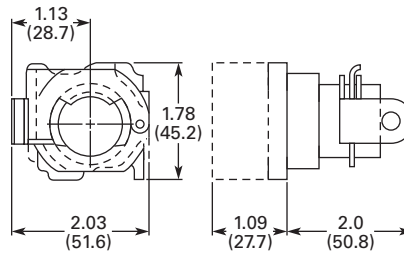

### Pushbutton with Cylinder Lock

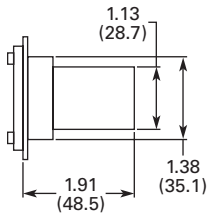

### Mushroom Head Pushbutton Operator with Padlock Attachment

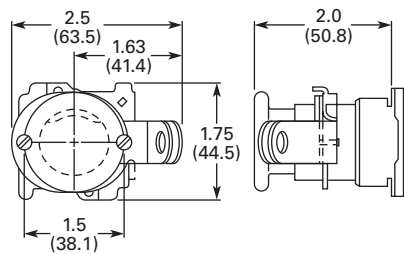

### Illuminated Pushbutton

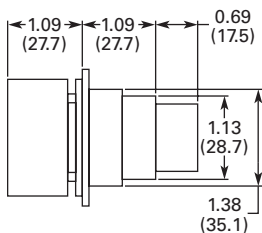

### Indicating Light—Transformer Type

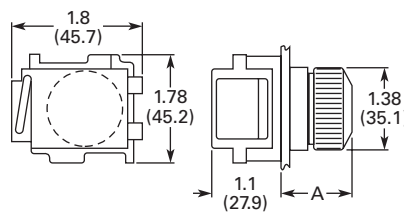

Approximate Dimensions in Inches (mm)

### PresTest Indicating Light—Transformer Type

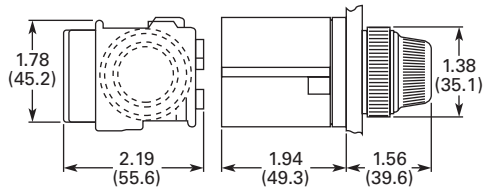

### PresTest Indicating Light—Resistor Type

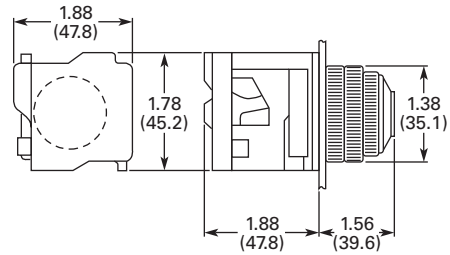

### Jumbo Mushroom Head Pushbutton Operator with Padlock Attachment

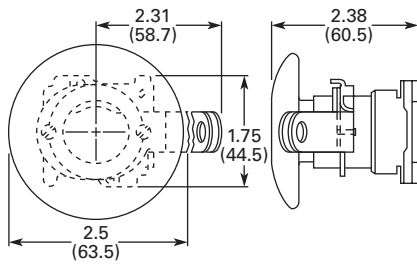

### Master Test Indicating Light

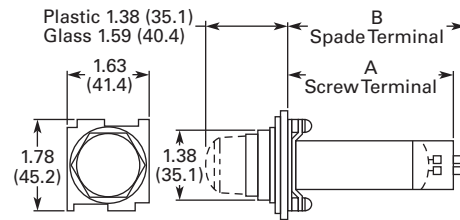

Description	B	C
Relay type	4.38 (111.2)	4.28 (108.7)
Solid-state type	2.94 (74.7)	2.88 (73.2)

### Indicating Light—Resistor and Neon Type

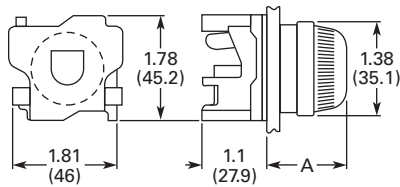

Lens	A
Plastic	1.38 (35.1)
Glass	1.56 (39.6)

### Potentiometer Shaft

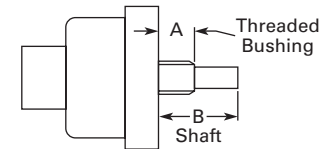

### Shaft Dimensions of Potentiometer That C-H Operator Will Accept

Operator Catalog Number	A	B
10250T330	0.38 (9.7) dia. x 0.38 (9.7) long	0.25 (6.4) dia. x 0.63 (16) long



# 1.8

## Pushbuttons and Indicating Lights

30.5 mm Heavy-Duty Watertight/Oiltight—10250T

1

Approximate Dimensions in Inches (mm)

### Coin Operated Selector Switch

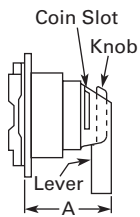

Operator	Dim. A
Knob	1.38 (35.1)
Lever	1.50 (38.1)
Coin slot	1.38 (35.1)

### Key Operated Selector Switch

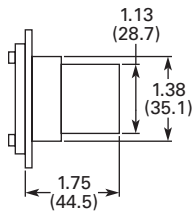

### Illuminated Selector Switch

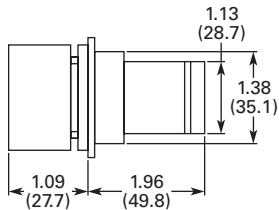

### Roto-Push

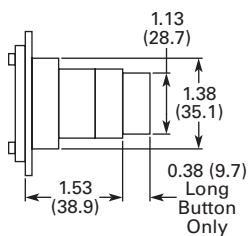

### Wobble Stick Catalog No. 10250TA5

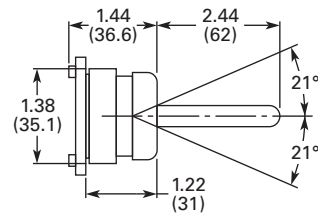

### Lever Operator—For Use with Two Vertically Mounted Flush Pushbuttons Catalog No. 10250TA14

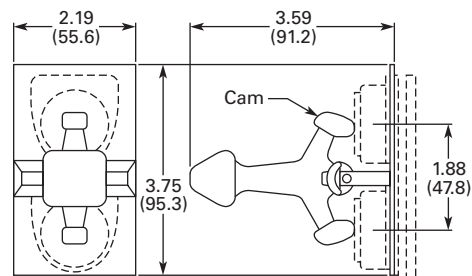

### Flexible Boot—For Protecting Flush or Long Pushbutton Catalog No. 10250TA3 Typical

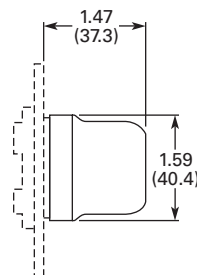

### Transparent Flexible Boot—For Illuminated Pushbutton Catalog No. 10250TA25

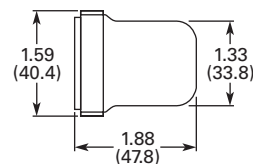

Approximate Dimensions in Inches (mm)

**Padlock Attachment—For Knob Selector Switch  
Catalog No. 10250TA11**

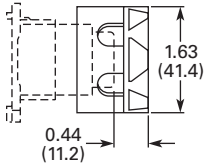

**Padlock Attachment—For Flush Pushbutton  
Catalog No. 10250TA2**

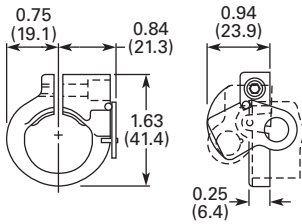

**Padlock Attachment—For Extended Pushbutton  
Catalog No. 10250TA26**

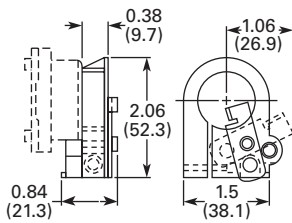

**Maintained Pushbutton  
Catalog No. 10250TA66 Typical**

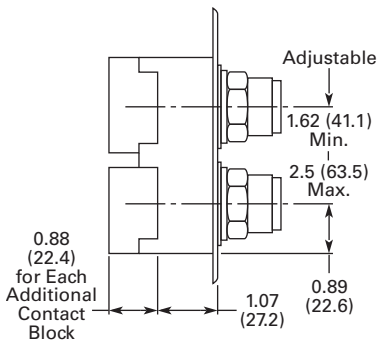

**Maintained Contact Attachment  
Catalog No. 10250TA17 Typical**

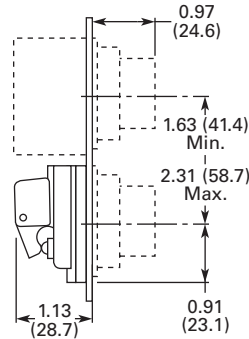

**Padlock Cover Guard for Flush Pushbutton  
Catalog No. 10250TA36**

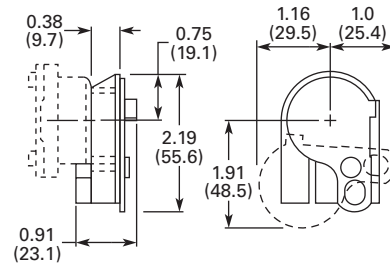

**Padlock Attachment for Maintained Push-Pull Operator  
Catalog No. 10250TA64**

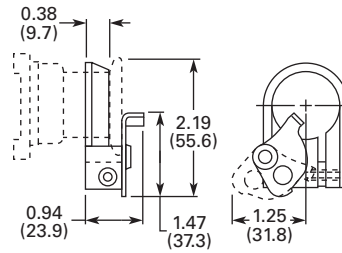

**Protecting Shroud for Jumbo Mushroom Head Button  
Catalog No. 10250TA56**

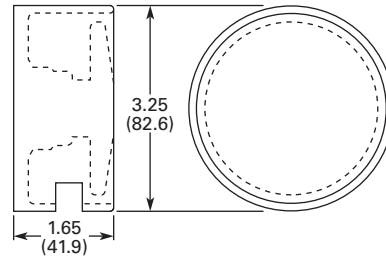

# 1.8

## Pushbuttons and Indicating Lights

30.5 mm Heavy-Duty Watertight/Oiltight—10250T

1

Approximate Dimensions in Inches (mm)

### Protecting Shroud for Mushroom Head Button Catalog No. 10250TA6

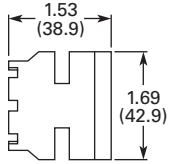

### Extended Retaining Nut Catalog No. 10250TA12

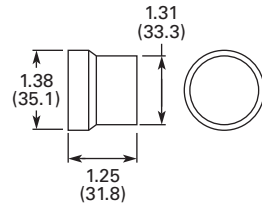

### Panel Drilling and Minimum Spacing

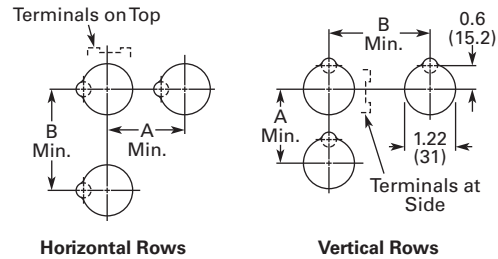

### Protecting Shroud for Illuminated Pushbutton Catalog No. 10250TA15

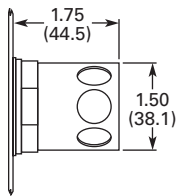

### Lever for Roto-Push Operator Catalog No. 10250TA13

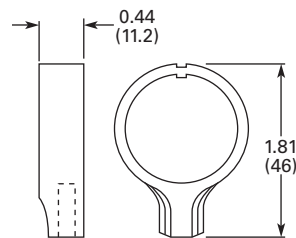

### Padlock Hasp or Flip-Up Guard Catalog No. 10250TA38

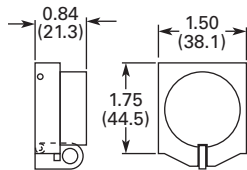

Legend Plate	A Min.	B Min.
<b>1 or 2 Circuit Contact Blocks</b>		
Small or none	1.63 (41.4)	2.25 (57.2)
Standard	1.75 (44.5)	2.25 (57.2)
Jumbo <sup>①</sup>	2.25 (57.2)	2.25 (57.2)
Extra large	2.50 (63.5)	2.60 (66.0)
<b>4 Circuit Contact Block 10250T44</b>		
Small or none	1.88 (47.8)	2.25 (57.2)
Standard	1.88 (47.8)	2.25 (57.2)
Jumbo <sup>①</sup>	2.25 (57.2)	2.25 (57.2)
Extra large	2.50 (63.5)	2.60 (66.0)

#### Notes

Locating nib hole or notch is 1.36–1.4 in (34.5–35.6 mm) #29 drill.

<sup>①</sup> If jumbo plates are to be placed one above the other vertically, add 0.13 (3.3) to minimum dimensions listed.

Approximate Dimensions in Inches (mm)

### Multiple Button Guard

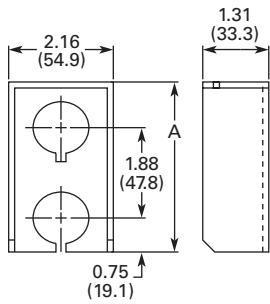

Number of Elements	A
2	4.0 (101.6)
3	5.88 (149.4)
4	7.88 (200.2)
7	13.38 (339.9)

### Chain Hook Bracket

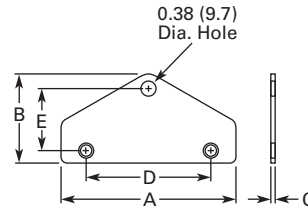

Enclosure Size (No. of Elements)	Wide A	High B	Deep C	Mounting D	E
2, 3 and 4	3.75 (95.3)	1.94 (49.3)	0.13 (3.3)	2.69 (68.3)	1.38 (35.1)
6 and 7	4.0 (101.6)	2.19 (55.6)	0.13 (3.3)	2.88 (73.2)	1.63 (41.4)

### Master Test Module, Flasher Module and Legend Plate

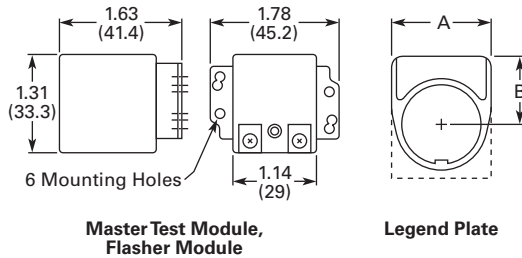

Legend Plate	A	B
<b>1/2 Round Legend Plates</b>		
Small	1.56 (39.6)	0.91 (23.1)
Standard	1.59 (40.4)	1.07 (27.2)
Jumbo	2.06 (52.3)	1.53 (38.9)
<b>Square Legend Plates</b>		
Small	1.59 (40.4) sq.	0.90 (22.9)
Standard	1.75 (44.5) sq.	1.06 (26.9) ①
Jumbo	2.19 (55.6) sq.	1.50 (38.1)
Extra large	2.44 (62.0) sq.	1.63 (41.4)

#### Notes

Locating nib hole or notch is 1.36–1.4 in (34.5–35.6 mm) #29 drill.

① For plastic legend plate, Dimension B is 1.12 (28.4).

30.5 mm Corrosion Resistant Watertight/Oiltight—E34

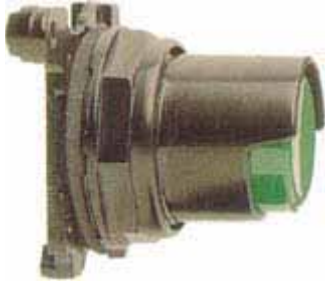

### Product Description

Eaton's E34 Series 30.5 mm pushbutton line features the same rugged die cast construction of our 10250T line with an additional two-layer 100% solid thermosetting cathodic epoxy coating. This coating provides a flat black smooth, consistent, corrosion resistant surface that has passed a demanding 600 hour salt spray test. (The industry standard for this 4X test requires only 200 hours.)

### Features

- Epoxy-coated metal operators
- Corrosion resistant
- Integral ground screw terminal on operators
- FDA approved for sanitary chemical resistance requirements

### Contents

<i>Description</i>	<i>Page</i>
30.5 mm Corrosion Resistant Watertight/Oiltight—E34	
Product Overview . . . . .	<b>V7-T1-265</b>
Product Identification . . . . .	<b>V7-T1-266</b>
Catalog Number Selection . . . . .	<b>V7-T1-267</b>
Ordering Complete Devices . . . . .	<b>V7-T1-269</b>
Product Selection	
Non-Illuminated Momentary	
Pushbutton Units . . . . .	<b>V7-T1-270</b>
Plastic Lens Indicating Light Units . . . . .	<b>V7-T1-270</b>
Pushbuttons . . . . .	<b>V7-T1-271</b>
Illuminated Pushbuttons and	
Indicating Lights . . . . .	<b>V7-T1-272</b>
Push-Pull Units . . . . .	<b>V7-T1-274</b>
Illuminated Push-Pull Units . . . . .	<b>V7-T1-275</b>
Potentiometers . . . . .	<b>V7-T1-277</b>
Push-Pull Operators . . . . .	<b>V7-T1-278</b>
Selector Switch Units . . . . .	<b>V7-T1-282</b>
Selector Switch Selection . . . . .	<b>V7-T1-283</b>
Selector Switch Operators . . . . .	<b>V7-T1-286</b>
Key Operators . . . . .	<b>V7-T1-286</b>
Illuminated Selector Switch Operators . . . . .	<b>V7-T1-288</b>
Accessories . . . . .	<b>V7-T1-289</b>
Options . . . . .	<b>V7-T1-291</b>
Replacement Parts . . . . .	<b>V7-T1-297</b>
Technical Data and Specifications . . . . .	<b>V7-T1-299</b>
Dimensions . . . . .	<b>V7-T1-302</b>

### Standards and Certifications

- CE EN60947-5-1 and 60947-5-5
- UL 508—File No. E131568
- CSA C22.2 No. 14—File No. LR68551
- FDA 3-A Sanitary Standards



### Ingress Protection

When mounted in similarly rated enclosure—

- Standard indicating lights
  - UL (NEMA) Type 1, 2, 3, 3R, 3S, 4, 4X, 12, 13
  - IEC IP65
- All other operators
  - UL (NEMA) Type 1, 2, 3, 3R, 4, 4X, 12, 13
  - IEC IP65

### Product Overview

#### Ultraviolet Light

E34 cathodic coating is not recommended for use in applications where exposure to ultraviolet light exists—use NEMA 4X 10250T operators.

#### Reliability Nibs

Eaton’s contact blocks feature enclosed silver contacts with pointed “reliability nibs” for reliable performance from logic level up to 600V. To ensure reliable switching, nibs bite through oxide which can form on silver contacts, eliminating the need for expensive logic level blocks for most applications.

#### Reliability Nibs



Dry Circuit

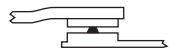

Medium Duty

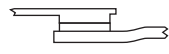

Heavy-Duty

#### Diaphragm Seal with Drainage Holes

##### Liquid Drainage

Eaton’s pushbutton operators offer front of panel drainage via holes in the operator bushing. Hidden from view by the mounting nut, these holes prevent buildup of liquid inside the operator, which can prevent operation in freezing environments. The holes also provide a route for escaping liquid in high pressure washdowns, effectively relieving pressure from the internal diaphragm seal, ensuring reliable sealing in applications even beyond NEMA 4.

##### Diaphragm Seal

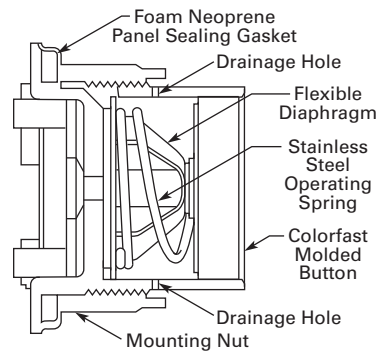

#### 1

#### Product Identification

#### 30.5 mm Corrosion Resistant Watertight/Oiltight—E34 Series

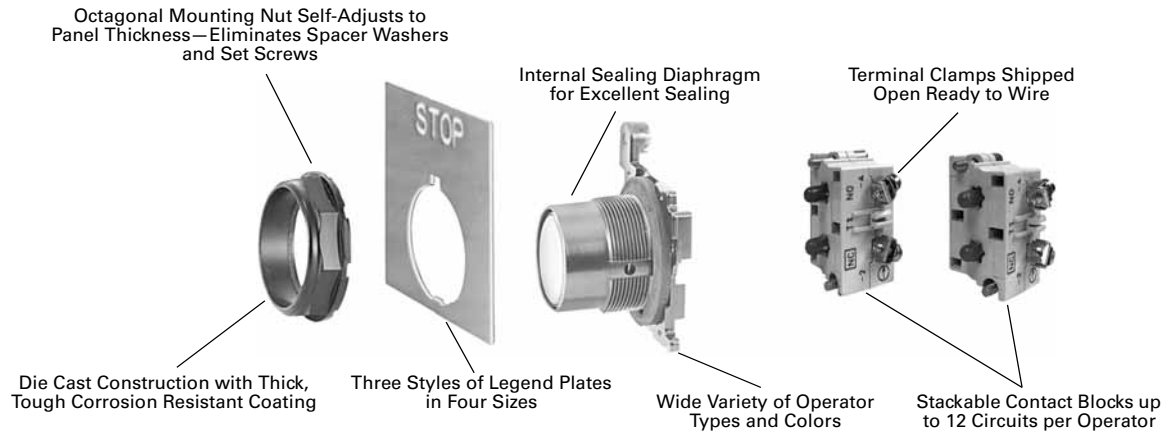

### Catalog Number Selection

Catalog Number Selection is for illustrative purposes only and not to be used to create new catalog numbers.

### Non-Illuminated Pushbuttons

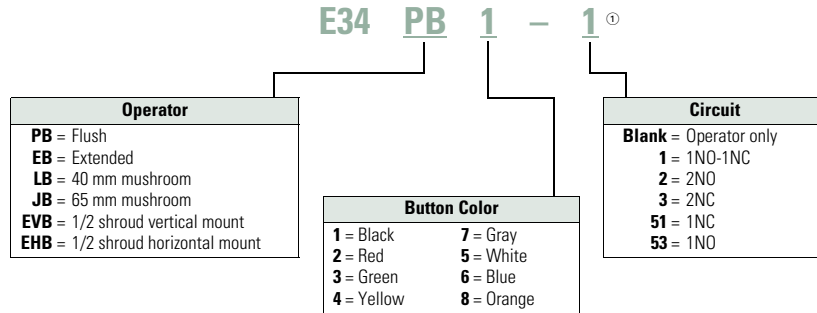

### Illuminated and Non-Illuminated Push-Pulls

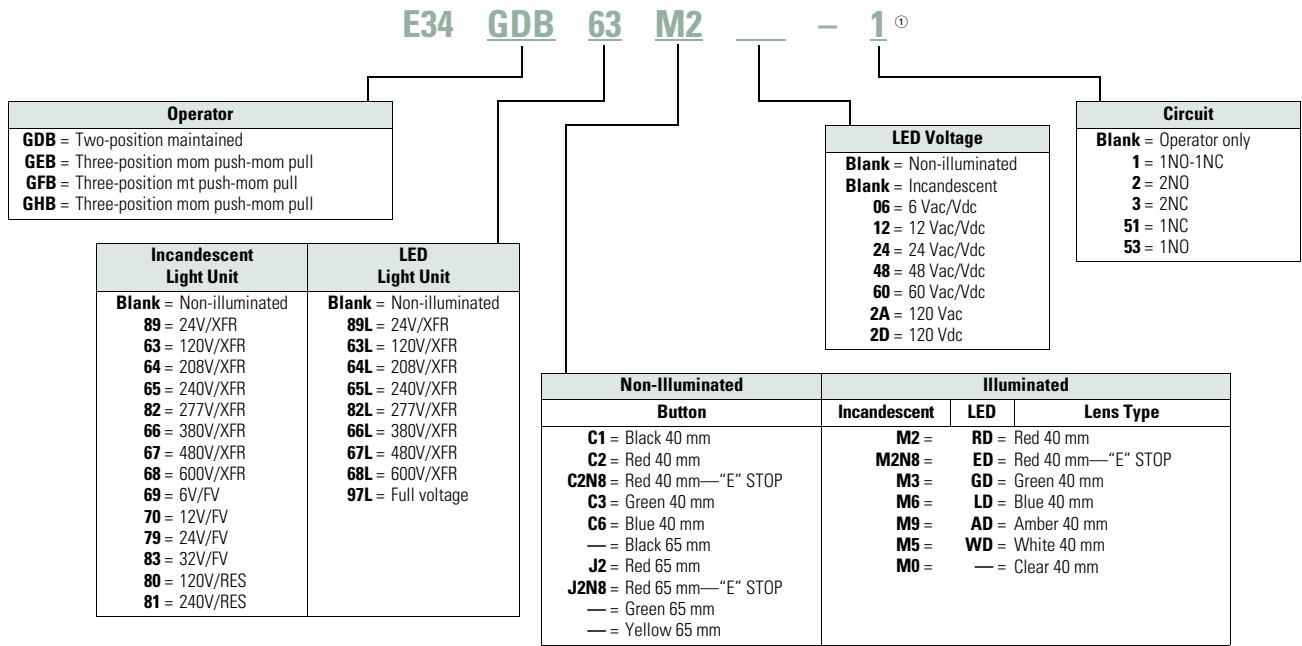

**Note**

① Add **X** at end of catalog number to receive parts assembled from factory.



Catalog Number Selection is for illustrative purposes only and not to be used to create new catalog numbers.

#### Illuminated Pushbuttons

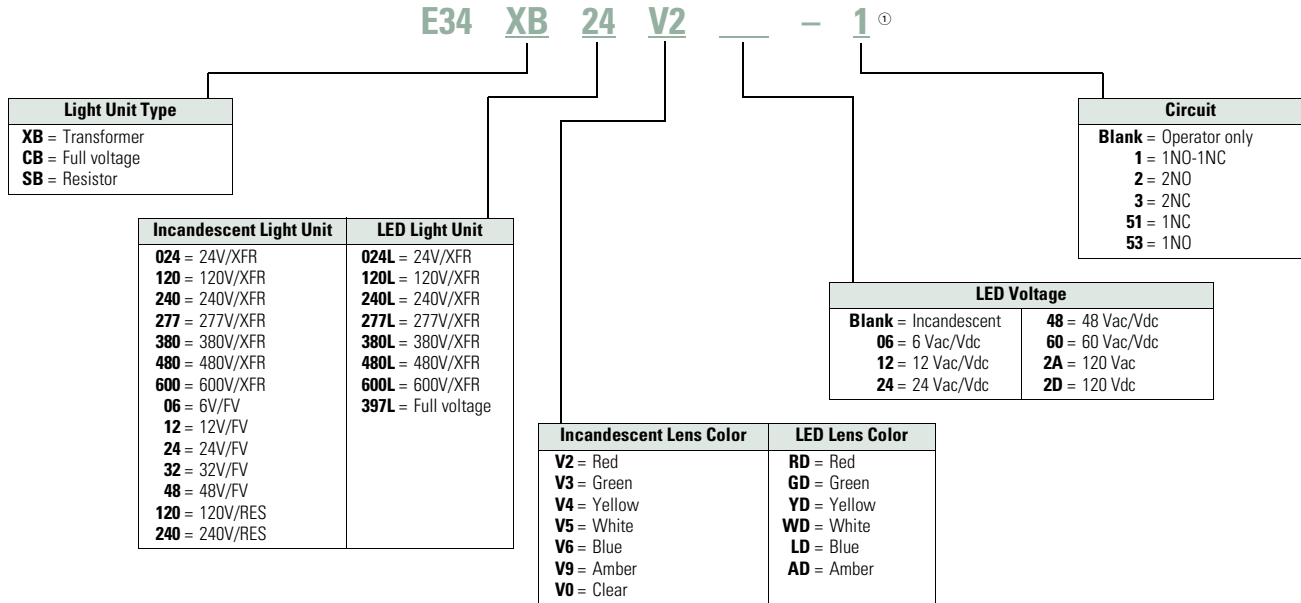

#### Standard Indicating Lights, PresTest and Master Test

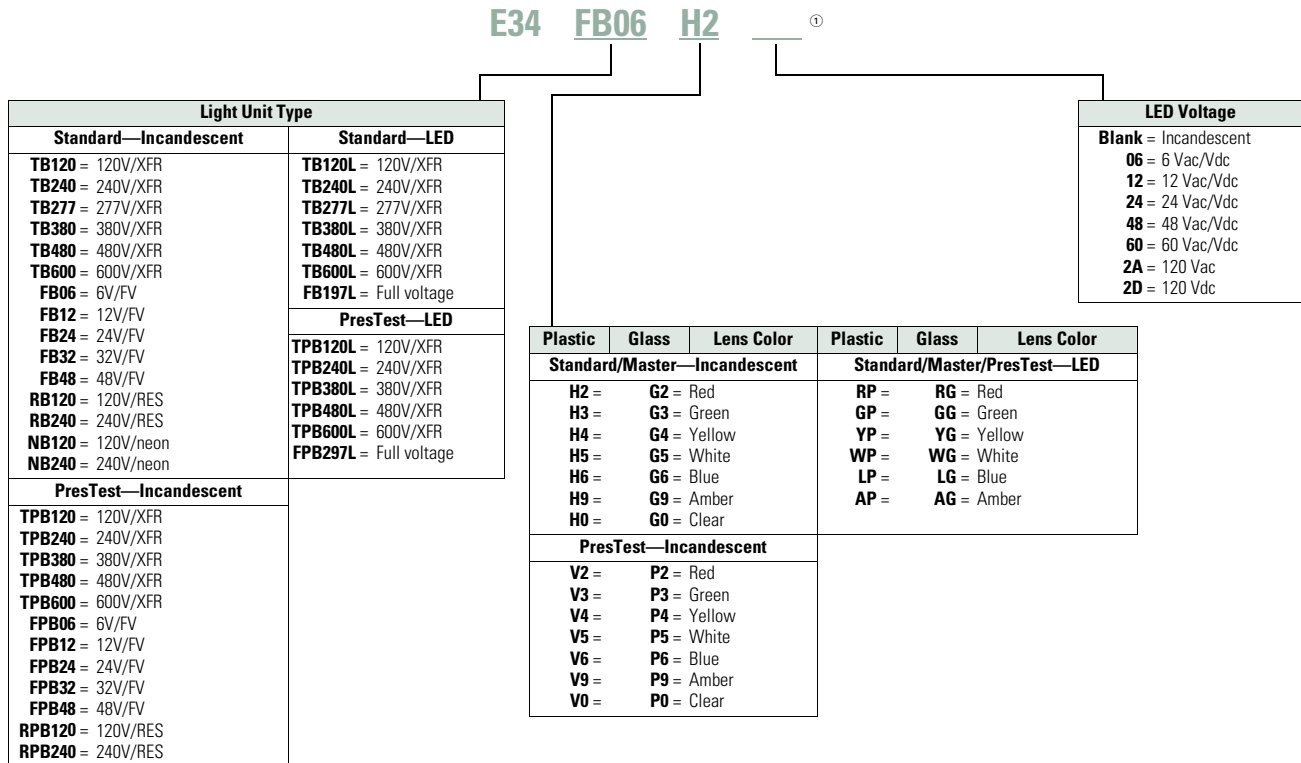

**Note**

① Add X at end of catalog number to receive parts assembled from factory.

Catalog Number Selection is for illustrative purposes only and not to be used to create new catalog numbers.

### Ordering Complete Devices

Complete E34 pushbuttons, indicating lights and/or selector switch operators including contact block(s) and legend plate can be ordered using a single composite catalog number. The

individually packaged components will be shipped unassembled in a single overpack carton marked with the composite catalog number.

### Ordering Example

Illuminated Pushbutton Device—Catalog Number E34XB120V2-153SP90

For a complete Catalog Number breakdown, see **Pages V7-T1-267 to V7-T1-268.**

### For Complete E34 Device Ordering

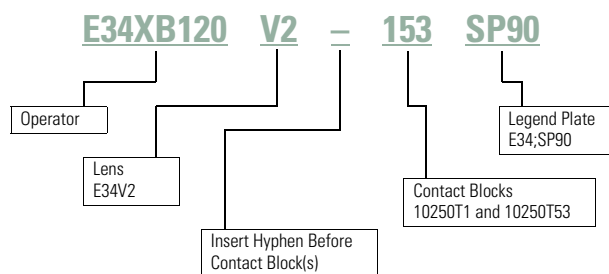

## Product Selection

### Non-Illuminated Momentary Pushbutton Units

UL (NEMA) Type 3, 3R, 4, 4X, 12, 13

#### Flush Button



#### Extended Button



#### Mushroom Button



#### Jumbo Mushroom



### Pushbutton Units

Contact Type	Button Color	Flush Button Catalog Number	Extended Button Catalog Number	Mushroom Button Catalog Number	Jumbo Mushroom <sup>①</sup> Catalog Number
1NO	Black	E34PB1-53X	E34EB1-53X	E34LB1-53X	E34JB1-53X
	Red	E34PB2-53X	E34EB2-53X	E34LB2-53X	E34JB2-53X
	Green	E34PB3-53X	E34EB3-53X	E34LB3-53X	E34JB3-53X
	Red—Engraved EMERG. STOP	—	—	—	E34JB2N8-53X
1NC	Black	E34PB1-51X	E34EB1-51X	E34LB1-51X	E34JB1-51X
	Red	E34PB2-51X	E34EB2-51X	E34LB2-51X	E34JB2-51X
	Green	E34PB3-51X	E34EB3-51X	E34LB3-51X	E34JB3-51X
	Red—Engraved EMERG. STOP	—	—	—	E34JB2N8-51X
1NO-1NC	Black	E34PB1-1X	E34EB1-1X	E34LB1-1X	E34JB1-1X
	Red	E34PB2-1X	E34EB2-1X	E34LB2-1X	E34JB2-1X
	Green	E34PB3-1X	E34EB3-1X	E34LB3-1X	E34JB3-1X
	Red—Engraved EMERG. STOP	—	—	—	E34JB2N8-1X

### Plastic Lens Indicating Light Units

UL (NEMA) Type 3, 3R, 4, 4X, 12, 13

#### 24V Full Voltage Indicating Light



### Indicating Light Units

Type	Voltage	Color	LED/Lamp Number	Indicating Light <sup>①</sup> Catalog Number
<b>LED Lamp</b>				
Full voltage	24 Vac/Vdc	Red	Bayonet base	E34FB197LRP24
		Green		E34FB197LGP24
		Amber		E34FB197LAP24
	120 Vac	Red		E34FB197LRP2A
		Green		E34FB197LGP2A
		Amber		E34FB197LAP2A
<b>Incandescent Lamp</b>				
Full voltage	24 Vac/Vdc	Red	#757	E34FB24H2X
		Green		E34FB24H3X
		Amber		E34FB24H9X
Resistor	120 Vac/Vdc	Red	120MB	E34RB120H2X
		Green		E34RB120H3X
		Amber		E34RB120H9X
Transformer	120 Vac 50/60 Hz	Red	#755	E34TB120H2X
		Green		E34TB120H3X
		Amber		E34TB120H9X

#### Notes





Use NEMA 4X 10250T operators where exposed to ultraviolet light, see **Pages V7-T1-192 to V7-T1-263**.

① Anodized aluminum head—may not be suitable for some corrosive environments.

### Pushbuttons

UL (NEMA) Type 3, 3R, 4, 4X, 12, 13

#### Momentary Pushbutton Operators, Non-Illuminated

Button	Color	Catalog Number		
<b>E34PB_</b> 	Flush button	Black	<b>E34PB1</b>	
	Red		<b>E34PB2</b>	
	Green		<b>E34PB3</b>	
	Yellow		<b>E34PB4</b>	
	White		<b>E34PB5</b>	
	Blue		<b>E34PB6</b>	
	Gray		<b>E34PB7</b>	
	Orange		<b>E34PB8</b>	
<b>E34EB_</b> 	Extended button	Black	<b>E34EB1</b>	
	Red		<b>E34EB2</b>	
	Green		<b>E34EB3</b>	
	Yellow		<b>E34EB4</b>	
	White		<b>E34EB5</b>	
	Blue		<b>E34EB6</b>	
	Gray		<b>E34EB7</b>	
	Orange		<b>E34EB8</b>	
<b>E34EHB_</b> 	Half shrouded button		<b>Vertical</b>	<b>Horizontal</b>
		Black	<b>E34EVB1</b>	<b>E34EHB1</b>
	Red	<b>E34EVB2</b>	<b>E34EHB2</b>	
	Green	<b>E34EVB3</b>	<b>E34EHB3</b>	
	Yellow	<b>E34EVB4</b>	<b>E34EHB4</b>	
	White	<b>E34EVB5</b>	<b>E34EHB5</b>	
	Blue	<b>E34EVB6</b>	<b>E34EHB6</b>	
	Gray	<b>E34EVB7</b>	<b>E34EHB7</b>	
	Orange	<b>E34EVB8</b>	<b>E34EHB8</b>	
	<b>E34LB_</b> 	Mushroom button	Black	<b>E34LB1</b>
Red			<b>E34LB2</b>	
Green			<b>E34LB3</b>	
Yellow			<b>E34LB4</b>	
Blue			<b>E34LB6</b>	
<b>E34JB_</b> 	Anodized aluminum jumbo mushroom button <sup>①</sup>	Black	<b>E34JB1</b>	
		Red	<b>E34JB2</b>	
		Red (Engraved EMERG. STOP)	<b>E34JB2N8</b>	
		Green	<b>E34JB3</b>	
		Yellow	<b>E34JB4</b>	

**Notes**

Use NEMA 4X 10250T operators where exposed to ultraviolet light, see **Pages V7-T1-192 to V7-T1-263**.

① Anodized aluminum head—may not be suitable for some corrosive environments.

## Illuminated Pushbuttons and Indicating Lights

## Illuminated Pushbutton

## Operators without Lens



## Indicating Light



## PresTest



Type	Voltage	Lamp Number	Illuminated Pushbutton Catalog Number	Indicating Light Catalog Number	PresTest Catalog Number
<b>LED Lamp (LEDs not included) ①</b>					
Full voltage	—	Bayonet base	<b>E34CB497L</b>	<b>E34FB197L</b>	<b>E34FPB297L</b>
Transformer AC only	24		<b>E34XB024L</b>	—	—
	120		<b>E34XB120L</b>	<b>E34TB120L</b>	<b>E34TPB120L</b>
	240		<b>E34XB240L</b>	<b>E34TB240L</b>	<b>E34TPB240L</b>
	277		<b>E34XB277L</b>	<b>E34TB277L</b>	—
	380		<b>E34XB380L</b>	<b>E34TB380L</b>	<b>E34TPB380L</b>
	480		<b>E34XB480L</b>	<b>E34TB480L</b>	<b>E34TPB480L</b>
	600		<b>E34XB600L</b>	<b>E34TB600L</b>	<b>E34TPB600L</b>
<b>Incandescent Lamp</b>					
Full voltage AC/DC	6	#755	<b>E34CB06</b>	<b>E34FB06</b>	<b>E34FPB06</b>
	12	#756	<b>E34CB12</b>	<b>E34FB12</b>	<b>E34FPB12</b>
	24	#757	<b>E34CB24</b>	<b>E34FB24</b>	<b>E34FPB24</b>
	32	#1828	<b>E34CB32</b>	<b>E34FB32</b>	<b>E34FPB32</b>
	48	#1835	<b>E34CB48</b>	<b>E34FB48</b>	<b>E34FPB48</b>
Resistor AC/DC ②	120	120MB	<b>E34SB120</b>	<b>E34RB120</b>	<b>E34RPB120</b>
	240		<b>E34SB240</b>	<b>E34RB240</b>	<b>E34RPB240</b>
Transformer AC only	24	#755	<b>E34XB024</b>	—	—
	120		<b>E34XB120</b>	<b>E34TB120</b>	<b>E34TPB120</b>
	240		<b>E34XB240</b>	<b>E34TB240</b>	<b>E34TPB240</b>
	277		<b>E34XB277</b>	<b>E34TB277</b>	—
	380		<b>E34XB380</b>	<b>E34TB380</b>	<b>E34TPB380</b>
	480		<b>E34XB480</b>	<b>E34TB480</b>	<b>E34TPB480</b>
	600		<b>E34XB600</b>	<b>E34TB600</b>	<b>E34TPB600</b>
Neon AC/DC	120	NE51H-R-22	—	<b>E34NB120</b>	—
	240	NE51H-4-68	—	<b>E34NB240</b>	—

**Notes**

Use NEMA 4X 10250T operators where exposed to ultraviolet light, see **Pages V7-T1-192 to V7-T1-263**.

① These units do not include lamps. Order LED separately to match lens color, see **Page V7-T1-249** for LED Selection and **Pages V7-T1-267 to V7-T1-268** for Catalog Numbering Selection.

② Resistor units are not available for use with LEDs, choose either transformer or full voltage LED style.

**Plastic**



### Indicating Light Lens

Color	Plastic Catalog Number	Glass <sup>①</sup> Catalog Number
Red	E34H2	E34G2
Green	E34H3	E34G3
Yellow	E34H4	E34G4
White	E34H5	E34G5
Blue	E34H6	E34G6
Ambler	E34H9	E34G9
Clear	E34H0	E34G0

**Glass**



**E34V\_**



### Illuminated Pushbutton Lens

Color	Catalog Number
Red	E34V2
Green	E34V3
Yellow	E34V4
White	E34V5
Blue	E34V6
Ambler	E34V9
Clear	E34V0

**Plastic**



### PresTest Lens

Color	Plastic Catalog Number	Glass <sup>①</sup> Catalog Number
Red	E34V2	E34P2
Green	E34V3	E34P3
Yellow	E34V4	E34P4
White	E34V5	E34P5
Blue	E34V6	E34P6
Ambler	E34V9	E34P9
Clear	E34V0	E34P0

**Glass**



**Note**

① Glass lens has black anodized aluminum bezel.

#### 1

#### Push-Pull Units

UL (NEMA) Type 3, 3R, 4, 4X, 12, 13

- Two- and three-position
- Non-illuminated

#### Two-Position Push-Pull Unit



#### Two-Position Push-Pull Units, Non-Illuminated

##### Operator Position ①

Pull	Push	Button Type/Color ②	Contact Type	Mounting Location		Catalog Number
				A	B	
<b>Maintained Push, Maintained Pull</b>						
0	X	40 mm/red	1NO			<b>E34GDBC2-1X</b>
X	0	40 mm engraved EMERG. STOP/red	1NC			<b>E34GDBC2N8-1X</b>
		65 mm aluminum engraved EMERG. STOP/red				<b>E34GDBJ2N8-1X</b>

#### Three-Position Push-Pull Unit



#### Three-Position Push-Pull Units, Non-Illuminated

##### Operator Position ①

Pull	Intermediate	Push	Button Type/Color ②	Contact Type	Mounting Location		Catalog Number
					A	B	
<b>Maintained Push, Momentary Pull</b>							
X	0	0	40 mm/black	1NC			<b>E34GFBC1-3X</b>
X	X	0	40 mm/red	1NC			<b>E34GFBC2-3X</b>
			40 mm engraved EMERG. STOP/red				<b>E34GFBC2N8-3X</b>
<b>Momentary Push, Momentary Pull</b>							
X	0	0	40 mm/black	1NC			<b>E34GEBc1-3X</b>
X	X	0	40 mm/red	1NC			<b>E34GEBc2-3X</b>
0	0	X	40 mm/black	1NO			<b>E34GHBC1-1X</b>
X	0	0	40 mm/red	1NC			<b>E34GHBC2-1X</b>

#### Button and Color Selection

Color	Suffix Code	Catalog Number
<b>Standard—40 mm</b>		
Black	<b>C1</b>	<b>E34C1</b>
Red	<b>C2</b>	<b>E34C2</b>
Red (EMERG. STOP)	<b>C2N8</b>	<b>E34C2N8</b>
Green	<b>C3</b>	<b>E34C3</b>
Blue	<b>C6</b>	<b>E34C6</b>
<b>Jumbo Mushroom Head (Anodized) Aluminum—65 mm</b>		
Red	<b>J2</b>	<b>E34J2</b>
Red (EMERG. STOP)	<b>J2N8</b>	<b>E34J2N8</b>

#### Notes

Use NEMA 4X 10250T operators where exposed to ultraviolet light, see **Pages V7-T1-192 to V7-T1-263**.

① X = closed circuit, 0 = open circuit.

② To order different type or color buttons, substitute the underlined characters with appropriate suffix code from the table. Example: E34GDBCC6-1X.

③ Anodized aluminum may not be suitable for use on some corrosive applications.

### Illuminated Push-Pull Units

UL (NEMA) Type 3, 3R, 4, 4X, 12, 13

- Two-position maintained
- Illuminated

#### Illuminated Push-Pull Unit



#### Two-Position Illuminated Maintained Push, Maintained Pull

Operator Position ①

Maintained—  
Pull



Maintained—  
Intermediate



		Lamp	Type	Voltage	Contact Type	Mounting Location A B	LED/Lamp Number	Red Standard Push-Pull Catalog Number ②	
0	X	LED	Full voltage	24 Vac/Vdc	1NO		Bayonet base	<b>E34GDB97LRD24-1X</b>	
X	0			120 Vac/Vdc	1NC			<b>E34GDB97LRD24-1X</b>	
				Transformer	24 Vac				<b>E34GDB89LRD06-1X</b>
				120 Vac				<b>E34GDB63LRD06-1X</b>	
0	X	Incandescent	Full voltage	24 Vac/Vdc	1NO		#757	<b>E34GDB79M2-1X</b>	
X	0			120 Vac/Vdc	1NC		120MB	<b>E34GDB80M2-1X</b>	
				Transformer	24 Vac			#755	<b>E34GDB89M2-1X</b>
					120 Vac				<b>E34GDB63M2-1X</b>

#### Standard



#### Lens and Color Selection

Color	Incandescent Suffix Code	LED Suffix Code	Catalog Number
<b>Standard</b>			
Red	<b>M2</b>	<b>RD</b>	<b>E34M2</b>
Red (EMER. STOP)	<b>M2N8</b>	<b>ED</b>	<b>E34M2N8</b>
Green	<b>M3</b>	<b>GD</b>	<b>E34M3</b>
Blue	<b>M6</b>	<b>LD</b>	<b>E34M6</b>
Amber	<b>M9</b>	<b>AD</b>	<b>E34M9</b>
White	<b>M5</b>	<b>WD</b>	<b>E34M5</b>
Clear	<b>M0</b>	<b>CD</b>	<b>E34M0</b>

#### Notes

Use NEMA 4X 10250T operators where exposed to ultraviolet light, see **Pages V7-T1-192 to V7-T1-263**.

① X = closed circuit, 0 = open circuit.

② To order different type or color lens, substitute the underlined characters with appropriate suffix code from Lens and Color Selection table above. Example: E34GDB79M3-1X. For LEDs with different voltages see ordering example on **Page V7-T1-281**.



1

UL (NEMA) Type 3, 3R, 4, 4X, 12, 13

- Three-position maintained
- Illuminated

**Illuminated Push-Pull Unit**



**Three-Position Illuminated Momentary Push, Momentary Pull**

Operator Position ①



Operator Position ①			Lamp	Type	Voltage	Contact Type	Mounting Location		LED/Lamp Number	Red Standard Push-Pull Catalog Number ②			
Momentary—Pull	Maintained—Intermediate	Momentary—Push					A	B					
0	0	X	LED	Full voltage	24 Vac/Vdc	1NO		Bayonet base		<b>E34GHB97LRD24-1X</b>			
X	0	0			120 Vac	1NC					<b>E34GHB97LRD2A-1X</b>		
					Trans-former	24 Vac					<b>E34GHB89LRD06-1X</b>		
					120 Vac					<b>E34GHB63LRD06-1X</b>			
X	0	0	LED	Full voltage	24 Vac/Vdc	1NC		Bayonet base		<b>E34GEB97LRD24-3X</b>			
X	X	0			120 Vac	1NC					<b>E34GEB97LRD2A-3X</b>		
					Trans-former	24 Vac					<b>E34GEB89LRD06-3X</b>		
					120 Vac					<b>E34GEB63LRD06-3X</b>			
0	0	X	Incandescent	Full voltage	24 Vac/Vdc	1NO		#757		<b>E34GHB79M2-1X</b>			
X	0	0			Resistor	120 Vac				1NC		120MB	<b>E34GHB80M2-1X</b>
					Trans-former	24 Vac						#755	<b>E34GHB89M2-1X</b>
					120 Vac					<b>E34GHB63M2-1X</b>			
X	0	0	LED	Full voltage	24 Vac/Vdc	1NC		#757		<b>E34GEB79M2-3X</b>			
X	X	0			Resistor	120 Vac				1NC		120MB	<b>E34GEB80M2-3X</b>
					Trans-former	24 Vac						#755	<b>E34GEB89M2-3X</b>
					120 Vac					<b>E34GEB63M2-3X</b>			

**Notes**

Use NEMA 4X 10250T operators where exposed to ultraviolet light, see **Pages V7-T1-192 to V7-T1-263**.

① X = closed circuit, 0 = open circuit.

② To order different type or color lens, substitute the underlined characters with appropriate suffix code from Lens and Color Selection table on the bottom of **Page V7-T1-275**. Example: E34GEB79M3-3X. For LEDs with different voltages see ordering example on **Page V7-T1-281**.

UL (NEMA) Type 3, 3R, 4, 4X, 12, 13

- Three-position—maintained push, momentary pull
- Illuminated

### Illuminated Push-Pull Unit



### Three-Position Illuminated Maintained Push, Momentary Pull

#### Operator Position ①



Momentary Pull	Maintained Intermediate	Maintained Push	Lamp	Type	Voltage	Contact Type	Mounting Location		LED/Lamp Number	Red Standard Push-Pull Catalog Number ②
							A	B		
X	0	0	LED	Full voltage	24 Vac/Vdc	1NC	o   o	Bayonet base		<b>E34GFB97LRD24-3X</b>
X	X	0			120 Vac	1NC				
					24 Vac					
				Trans-former	120 Vac					<b>E34GFB63LRD06-3X</b>
X	0	0	Incandescent	Full voltage	24 Vac/Vdc	1NC	o   o	#757		<b>E34GFB79M2-3X</b>
X	X	0			120 Vac	1NC				
				24 Vac			#755	<b>E34GFB89M2-3X</b>		
				120 Vac				<b>E34GFB63M2-3X</b>		

### Vertical or Horizontal One-Hole Mounting ③



### Potentiometers

UL (NEMA) Type 3, 3R, 4, 4X, 12, 13

### Potentiometer with Knob and Standard Dial Plate—Linear Type ±10%

Potentiometer Ohms	Catalog Number
<b>2 Watt (60V Max.) Single Potentiometer with Standard Aluminum Dial Plate ④⑤</b>	
1000	<b>E34PDB1F1</b>
2500	<b>E34PDB1F2</b>
5000	<b>E34PDB1F5</b>
10000	<b>E34PDB1F10</b>
25000	<b>E34PDB1F25</b>
50000	<b>E34PDB1F50</b>
Operator only ⑥	<b>E34PDB1A0</b>
Alternative—black plastic large legend with standard markings	<b>E34LP99</b>

Dimensions, see Page V7-T1-302.

#### Notes

Use NEMA 4X 10250T operators where exposed to ultraviolet light, see Pages V7-T1-192 to V7-T1-263.

① X = closed circuit, 0 = open circuit.

② To order different type or color lens, substitute the underlined characters with appropriate suffix code from table on the bottom of Page V7-T1-275.

Example: E34GFB79M3-3X. For LEDs with different voltages see ordering example on Page V7-T1-281.

③ Shown with standard aluminum dial plate.

④ Large dial plate with space for legend is available at no charge. To order, add suffix **36** to catalog number. Example: E34PDB1F1**36**. To order separately, see footnote ⑤ below.

⑤ Large dial plate has space at top for 15 letters. 3/32 in high. For custom stamped legend plates, order legend plate as separate item **10250TR30** and specify stamping.

⑥ For use with commercially purchased potentiometers having shaft dimensions per dimension drawing on Page V7-T1-254.

#### 1

#### Push-Pull Operators

An illuminated push-pull pushbutton unit, arranged for one-hole mounting, can replace two pushbuttons and a pilot light or the non-illuminated form can replace two pushbuttons. These units are available in three basic types:

- **Maintained**—(Two-position). Maintains in the pulled or pushed position until manually actuated to the opposite mode.
- **Momentary**—(Three-position). Spring returns to an intermediate position when pulled or pushed and released.

- **Momentary Pull, Maintained Push**—(Three-position). Spring returns to intermediate position when pulled. Maintains in pushed position until manually returned to intermediate (ready to reset) position. Maintained stop holds circuit open and will prevent other series connected operators from starting the system.

The operators, buttons, contact blocks, etc., are offered as building block components that can be intermixed to satisfy many requirements. This minimizes the need for a varied and costly inventory.

#### Application Guide

To assist in the selection of contact blocks, the sketch below shows pictorially by symbols **A** and **B** locations of contact circuits after assembly of contact blocks and adapter to the operator. The table below shows the effect of the push and pull operations on either NO or NC contacts. (X = contact closed, O = contact open).

#### Contact Circuit Locations

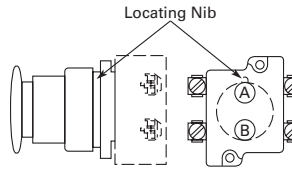

#### Two-Position Maint. Push-Pull ①



#### Push-Pull Operator Components

##### Operator Position and Circuit Arrangement

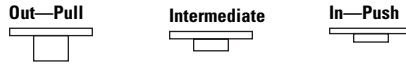

##### Contact Block Mounting Location

Type of Operator	Out—Pull		Intermediate		In—Push		Contact Block ②	Catalog Number
	A	B	A	B	A	B		
<b>Two-Position Operator without Lens</b>								
Maintained push-pull	O	O	No intermediate position		X	X	1NO	<b>E34GDB</b>
	X	X			O	O	1NC	
	O	O			X	X	2NO	
	X	X			O	O	2NC	
<b>Three-Position Operator without Lens</b>								
Momentary push-pull	O	O	O	O	X	O	1NO	<b>E34GEB ②</b>
	X	X	O	X	O	O	1NC	
	O	O	O	O	X	O	2NO	
	X	X	O	X	O	O	2NC	
Maintained push-momentary pull	O	O	O	O	X	O	1NO	<b>E34GFB ②</b>
	X	X	O	X	O	O	1NC	
	O	O	O	O	X	O	2NO	
	X	X	O	X	O	O	2NC	
Momentary push-pull	O	O	O	O	X	X	1NO	<b>E34GHB ②</b>
	X	X	O	O	O	O	1NC	
	O	O	O	O	X	X	2NO	
	X	X	O	O	O	O	2NC	

#### Notes

Use NEMA 4X 10250T operators where exposed to ultraviolet light, see **Pages V7-T1-192 to V7-T1-263**.

See Typical Applications on **Page V7-T1-213**.

① Shown without button on lens.

② Maximum of two blocks, four circuits. Special function contact blocks shown on **Page V7-T1-296** CANNOT be used with three-position push-pull operators E34GEB, E34GFB or E34GHB.

### Push-Pull Light Units, Lenses and Buttons

#### Ordering Example with One Composite Number

Non-illuminated:

E34GDB + E34C2 + 10250T1 = **E34GDBC2-1X**

Incandescent:

E34GDB + 10250T79 + E34M2 + 10250T1 = **E34GDB79M2-1X**

LED:

E34GDB + 10250T97L + E34M2 + Voltage Code + 10250T1 = **E34GDB97LRD24-1X**

06—6 Vac/Vdc  
12—12 Vac/Vdc  
24—24 Vac/Vdc  
48—48 Vac/Vdc

60—60 Vac/Vdc  
2A—120 Vac  
2D—120 Vdc

### Light Units for Illuminated Push-Pull Devices

Light Unit Type	Type	Voltage	LED/Lamp Number	Catalog Number
LED (LEDs not included) ①	Full voltage Transformer AC only 50/60 Hz	—	Bayonet base	<b>10250T97L</b>
		24		<b>10250T89L</b>
		120		<b>10250T63L</b>
		208		<b>10250T64L</b>
		240		<b>10250T65L</b>
		277		<b>10250T82L</b>
		380		<b>10250T66L</b>
		480		<b>10250T67L</b>
		600		<b>10250T68L</b>
		Incandescent		Full voltage AC or DC
12	#756		<b>10250T70</b>	
24/28	#757		<b>10250T79</b>	
32	#1828		<b>10250T83</b>	
120	120MB		<b>10250T80</b>	
Resistor AC or DC	240			<b>10250T81</b>
	24		#755	<b>10250T89</b>
Transformer AC only 50/60 Hz	120			<b>10250T63</b>
	208			<b>10250T64</b>
	240			<b>10250T65</b>
	277			<b>10250T82</b>
	380			<b>10250T66</b>
	480			<b>10250T67</b>
	600			<b>10250T68</b>

#### Notes

Use NEMA 4X 10250T operators where exposed to ultraviolet light, see **Pages V7-T1-192 to V7-T1-263**.

① These units do not include lamps. Order LED separately to match lens color from chart on **Page V7-T1-281**

## Buttons for Non-Illuminated Push-Pull Devices

Color	Incandescent Suffix Code	Catalog Number
<b>Standard Button</b>		
Black	<b>C1</b>	<b>E34C1</b>
Red	<b>C2</b>	<b>E34C2</b>
Red (EMERG. STOP)	<b>C2N8</b>	<b>E34C2N8</b>
Green	<b>C3</b>	<b>E34C3</b>
Blue	<b>C6</b>	<b>E34C6</b>
<b>Jumbo Mushroom Head</b>		
Red ①	<b>J2</b>	<b>E34J2</b>
Red (EMERG. STOP)	<b>J2N8</b>	<b>E34J2N8</b>

## E34M\_

## Alternate Lenses for Illuminated Push-Pull Devices

Color	Incandescent Suffix Code	LED Suffix Code ②	Catalog Number
Red	<b>M2</b>	<b>RD</b>	<b>E34M2</b>
Red (EMERG. STOP)	<b>M2N8</b>	<b>ED</b>	<b>E34M2N8</b>
Green	<b>M3</b>	<b>GD</b>	<b>E34M3</b>
Blue	<b>M6</b>	<b>LD</b>	<b>E34M6</b>
Amber	<b>M9</b>	<b>AD</b>	<b>E34M9</b>
White	<b>M5</b>	<b>WD</b>	<b>E34M5</b>
Clear	<b>M0</b>	—	<b>E34M0</b>

**Notes**

Use NEMA 4X 10250T operators where exposed to ultraviolet light, see **Pages V7-T1-192 to V7-T1-263**.

① Anodized aluminum may not be suitable for use on some corrosive applications.

② Suffix codes should only be used for assembling composite catalog numbers. To order lens, order by catalog number.

**Standard LED Lamp**



**LED Selection**

Voltage	Color	Catalog Number
6 Vac/Vdc suitable for use with transformers	Red	E22LED006RN
	Orange	E22LED006ON
	Yellow	E22LED006YN
	Green	E22LED006GN
	Blue	E22LED006BN
12 Vac/Vdc	White	E22LED006WN
	Red	E22LED012RN
	Orange	E22LED012ON
	Yellow	E22LED012YN
	Green	E22LED012GN
24 Vac/Vdc	Blue	E22LED012BN
	White	E22LED012WN
	Red	E22LED024RN
	Orange	E22LED024ON
	Yellow	E22LED024YN
48 Vac/Vdc	Green	E22LED024GN
	Blue	E22LED024BN
	White	E22LED024WN
	Red	E22LED048RN
	Orange	E22LED048ON
	Yellow	E22LED048YN
	Green	E22LED048GN
	Blue	E22LED048BN
	White	E22LED048WN

Voltage	Color	Catalog Number
60 Vac/Vdc	Red	E22LED060RN
	Orange	E22LED060ON
	Yellow	E22LED060YN
	Green	E22LED060GN
	Blue	E22LED060BN
120 Vac	White	E22LED060WN
	Red	E22LED120RA
	Orange	E22LED120OA
	Yellow	E22LED120YA
	Green	E22LED120GA
120 Vdc	Blue	E22LED120BA
	White	E22LED120WA
	Red	E22LED120RD
	Orange	E22LED120OD
	Yellow	E22LED120YD
	Green	E22LED120GD
	Blue	E22LED120BD
	White	E22LED120WD

#### 1

### Selector Switch Units

UL (NEMA) Type 3, 3R, 4, 4X, 12, 13

- Two-, three- and four-position—maintained
- Non-illuminated and illuminated

#### Two-Position Maint. Switch Knob



#### Two-Position Selector Switch

Operator Position <sup>①</sup>		Operator Action <sup>②</sup>	Contact Type	Mounting Location		Cam Code	Non-Illuminated		Illuminated—120V Transformer	
X	O			A	B		Black Knob Catalog Number <sup>③</sup>	Black Lever Catalog Number <sup>③</sup>	Red Knob Catalog Number <sup>③</sup>	Red Lever Catalog Number <sup>③</sup>
X	O	M M	1NC	A	B	1	E34VFBK1-1X	E34VFB1-1X	E34VFB120ER-1X	E34VFB120FR-1X
O	X		1NO							

#### Three-Position Maint. Switch Knob



#### Three-Position Selector Switch

Operator Position <sup>①</sup>			Operator Action <sup>②</sup>	Contact Type	Mounting Location		Cam Code	Non-Illuminated		Illuminated—120V Transformer	
X	O	O			A	B		Black Knob Catalog Number <sup>③</sup>	Black Lever Catalog Number <sup>③</sup>	Red Knob Catalog Number <sup>③</sup>	Red Lever Catalog Number <sup>③</sup>
X	O	O	M M M	1NO	A	B	3	E34VHBK1-2X	E34VHBL1-2X	E34VHB120TER-2X	E34VHB120TFR-2X
O	O	X		1NO							
X	O	O	M M M	1NO	A	B	3	E34VHBK1-23X	E34VHBL1-23X	E34VHB120TER-23X	E34VHB120TFR-23X
O	X	O									
O	O	X		2NC (Series)							
			1NO								

#### Four-Position Maint. Switch Lever



#### Four-Position Selector Switch

Operator Position <sup>①</sup>				Operator Action <sup>②</sup>	Contact Type	Mounting Location		Cam Code	Non-Illuminated		Illuminated—120V Transformer	
X	O	O	O			A	B		Black Knob Catalog Number <sup>③</sup>	Black Lever Catalog Number <sup>③</sup>	Red Knob Catalog Number <sup>③</sup>	Red Lever Catalog Number <sup>③</sup>
X	O	O	O	M M M M	1NC	A	B	7	E34VTBK1-23X	E34VTBL1-23X	E34VRB120TER-23X	E34VRB120TFR-23X
O	X	O	O		1NO							
O	O	X	O		1NO							
O	O	O	X		1NO							
					1NC							

#### Color Selection, Non-Illuminated

Color	Code Letter	Color	Code Letter
Black	1	White	5
Red	2	Blue	6
Green	3	Gray	7
Yellow	4	Orange	8

#### Notes

For Light Unit Voltage Suffix and Knobs, Levers tables, see **Page V7-T1-288**.

Use NEMA 4X 10250T operators where exposed to ultraviolet light, see **Pages V7-T1-192 to V7-T1-263**.

<sup>①</sup> X = closed circuit, O = open circuit.

<sup>②</sup> M = Maintained.

<sup>③</sup> To order different type or color selector switch, substitute the underlined character with appropriate suffix code from the Color Selection table. Example: E34VFBK2-X1.

### Selector Switch Selection



#### Cam and Contact Block Selection

Selector switches in their varied forms (two-position, three-position and four-position) are a big factor contributing to the great flexibility of control that a well rounded line of “pushbuttons” can achieve. Because of their flexibility, they tend to cause difficulty with product selection and application. The following systematic approach should simplify that task.

Cam and contact block selection is better understood if you:

- Work with each incoming and outgoing wire/circuit separately.
- Recognize the terms NO and NC only identify the type of contact by its mode before mounting to the operator. The “X-O” chart (Page V7-T1-285) shows how that contact will act after assembly to the operator with the selected cam shape. X = closed circuit, O = open circuit.

- Up to six NO or NC contacts may be mounted behind each plunger location for a total of twelve contacts. Single circuit contact blocks have only one plunger with the other side of the block “open.” Therefore, single circuit contact blocks transmit motion to blocks behind them only for the position containing the circuit.
- Each cam has two separate lobes, each of which operates one of the two contact block plungers independently of each other. Those are identified as position A (locating nib side) and position B (opposite of locating nib). The position designations give direction in selecting and mounting of the contact blocks.

#### Contact Circuit Locations

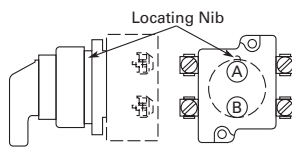

#### Systematic Approach

Application: **HAND-OFF-AUTO** selector switch. In this circuit, one incoming line is distributed to two other outgoing circuits by the switch. The two circuits can be looked at individually.

#### Step 1: Elementary Diagram.

Construct on paper, or in your mind, a simple elementary diagram of the switching scheme as follows:

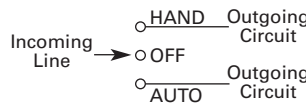

#### Step 2: “X-O” Pattern.

From the elementary diagram, you can construct an “X-O” diagram which describes when the contacts are to be closed (X) or open (O) in the various positions of the switch. The “X-O” for the **HAND** circuit looks like this:

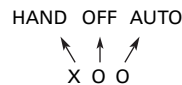

In this circuit, you want a contact closed on the left (HAND) but open in the center and right.

For the **AUTO** circuit, the “X-O” diagram would look like this:

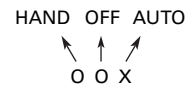

Putting them together, the complete “X-O” diagram is:



Once the “X-O” diagram has been generated, the next step is to select the cam and contact block, or blocks, needed to perform the desired “X-O” functions. The selection tables on the following pages list the various types (shapes) of cams by number to choose from and the type of contact and position to achieve the function outlined in your “X-O” diagram.



1

#### Step 3: Cam Selection.

The cam you select determines the operation of all contact blocks mounted to the operator. It is selected on the basis that it provides the simplest circuitry for the desired "X-O" diagram. The selection tables show all the "X-O" combinations. For the purpose of this example, the applicable portion of those tables is shown on this page.

Now to make the cam selection, make a simple worksheet such as:

	Cam 2	Cam 3
X O O	(A)NO-(B)NC	(A)NO
O O X	(B)NO	(B)NO

It becomes immediately obvious that cam 3 is the better choice for two reasons, (1) the series combination can be avoided making it simpler to wire, (2) only two contacts are required, which is less expensive than the three contacts required by cam 2.

#### Step 4: Contact Block Selection.

Having selected the cam, contact block selection is simply a matter of gathering the A position and B position circuits into pairs which make up the most convenient contact block arrangement. If there is an imbalance in the number of circuits under A or B, then single circuit blocks must be selected for these leftover circuits.

Back to the worksheet, having selected cam 3 do this:



#### Step 5: Selector Switch Operator.

Lastly, you have to choose from the many types of operators—knob and lever in various colors or keyed. Also what combinations of maintained and spring return functions are required. Selection of these operators can be found on **Page V7-T1-286**. For the example in step 4, you may want a three-position maintained black knob, cam 3—Catalog Number E34VHBK1.

#### The Complete Switch:

E34VHBK1 with one 10250T2 or, for one composite catalog number, E34VHBK1-Y1 found on **Page V7-T1-283**.

#### Diagrams

Circuits shown illustrate connections to obtain a selector switch circuit combination and are shown with their appropriate line diagrams. Field wiring of jumper connections required as shown.

X = Closed circuit  
O = Open circuit

#### Wiring of Jumper Connections



Series Connection

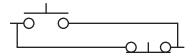

Parallel Connection

Four-position selector switches are limited to four contact blocks.

#### Contact Blocks

For selection and number of available contact blocks per operator, see **Page V7-T1-295**.

#### Example Selection Table

No.	"X-O" Pattern	Cam Code #2		Cam Code #3	
		Top A	Bottom B	Top A	Bottom B
1	X 0 0				—
4	0 0 X	—		—	

#### Two-Position Selector Switch Contact Block Selection

No.	Desired Circuit and Operator Position		Contact Blocks Required to Accomplish Circuit Function	
			Top Plunger A	Bottom Plunger B
1	X	0		or
2	0	X		or

#### Note

① Wired in series.

### Three-Position Switch—Cam and Contact Block Selection

No.	Desired Circuit and Operator Position			Contact Blocks Required to Accomplish Circuit Function (Jumpers must be installed where indicated)			
				Operator with Cam Code #2		Operator with Cam Code #3	
				Mounting Location		Mounting Location	
				Top Plunger A	Bottom Plunger B	Top Plunger A	Bottom Plunger B
1	X	0	0				
2	X	X	0				
3	X	0	X				
4	0	0	X				
5	0	X	X				
6	0	X	0				

### Four-Position Switch—Contact Block Selection

No.	Desired Circuit and Operator Position				Contact Blocks Required to Accomplish Circuit Function		No.	Desired Circuit and Operator Position				Contact Blocks Required to Accomplish Circuit Function	
					Top Plunger A	Bottom Plunger B						Top Plunger A	Bottom Plunger B
1	X	0	0	0			10	X	0	X	0		
2	0	X	0	0									
3	0	0	X	0			11	X	X	X	0		
4	0	0	0	X									
5	X	0	0	X			12	0	X	X	X		
6	0	X	X	0									
7	0	0	X	X			13	X	0	X	X		
8	X	X	0	0									
9	0	X	0	X			14	X	X	0	X		

# 1

## Selector Switch Operators

UL (NEMA) Type 3, 3R, 4, 4X, 12, 13

### Two-Position Knob Selector Switch



### Operators with Knob Assembled

Positions	Operator Action <sup>①</sup>	Black Knob Selector Switch— Vertical Mounting <sup>②</sup>	Cam Code <sup>③</sup>	Catalog Number <sup>④</sup>
Two-position—60° throw			1	<u>E34VFBK1</u>
			1	<u>E34VEBK1</u>
Three-position—60° throw			2	<u>E34VGBK1</u>
			3	<u>E34VHBK1</u>
			2	<u>E34VJBK1</u>
			3	<u>E34VKBK1</u>
			2	<u>E34VLBK1</u>
			3	<u>E34VMBK1</u>
Four-position—40° throw			2	<u>E34VNBK1</u>
			3	<u>E34VPBK1</u>
Four-position—40° throw			7	<u>E34VTBK1</u>

## Key Operators

### Three-Position Keyed Selector Switch



### Key Operators with Cam and Cap

Positions	Operator Action <sup>①</sup>	Cam Code <sup>③</sup>	Key Removal Positions <sup>⑤</sup>	Vertical Mounting Catalog Number	Horiz. Mounting Catalog Number
Two-position—60° throw		1	1, 2, 3	<u>E34KFB_</u>	<u>E34KFHB_</u>
		1	2	<u>E34KEB_</u>	<u>E34KEHB_</u>
Three-position—60° throw		2	1–7	<u>E34KGB_</u>	<u>E34KGHB_</u>
		3		<u>E34KHB_</u>	<u>E34KHGB_</u>
		2	1, 4, 5	<u>E34KJB_</u>	<u>E34KJHB_</u>
		3		<u>E34KKB_</u>	<u>E34KKHB_</u>
		2	4	<u>E34KLB_</u>	<u>E34KLHB_</u>
		3		<u>E34KMB_</u>	<u>E34KMHB_</u>
Four-position—40° throw		2	2, 4, 6	<u>E34KNB_</u>	<u>E34KNHB_</u>
		3		<u>E34KPB_</u>	<u>E34KPHB_</u>
Four-position—40° throw		7	7	<u>E34KTB_</u>	<u>E34KTHB_</u>

### Notes

Use NEMA 4X 10250T operators where exposed to ultraviolet light, see **Pages V7-T1-192 to V7-T1-263**.

① M = Maintained. S = Spring return in direction of arrow (R).

② Field convertible to horizontal mounting.

③ For selection of the proper cam and contact block to obtain the proper circuit sequence, see selection instructions and tables on **Pages V7-T1-283 to V7-T1-285**.

④ For other colors of either the knob or lever, replace the underlined characters of the catalog number with the appropriate suffix code from Alternate Knob and Lever table on **Page V7-T1-287**. Example: E34VFBL2.

⑤ Choose key removal position required for application from table on **Page V7-T1-287**. Add key removal code number to listed catalog number. Example: E34KFB2.

### Key Removal Positions <sup>①</sup>

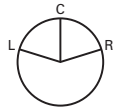

Code Suffix	Key Removal Position
1	Right only
2	Left only
3	Right and left
4	Center only
6	Left and center
7	All positions

### Dissimilar Locks and Keys

Listed operators have identical locks and keys (Key Code H661), Catalog Number **10250ED824**. For dissimilar lock and key combinations, see **Page V7-T1-222**.

### Alternate Knobs and Levers for Operators <sup>②</sup>

E34K\_



E34L\_



E34A\_



Color	Knob		Lever		Lever Designed for Added Ingress Protection <sup>③</sup>	
	Suffix Code	Catalog Number	Suffix Code	Catalog Number	Suffix Code	Catalog Number
Black	K1	E34K1	L1	E34L1	A1	E34A1
Red	K2	E34K2	L2	E34L2	A2	E34A2
Green	K3	E34K3	L3	E34L3	A3	E34A3
Yellow	K4	E34K4	L4	E34L4	A4	E34A4
White	K5	E34K5	L5	E34L5	A5	E34A5
Blue	K6	E34K6	L6	E34L6	A6	E34A6
Gray	K7	E34K7	L7	E34L7	A7	E34A7
Orange	K8	E34K8	L8	E34L8	A8	E34A8

#### Notes

- ① Key removal in “spring return from” positions not recommended.
- ② See operators on **Page V7-T1-286**.
- ③ For use on maintained operators only.

#### 1

### Illuminated Selector Switch Operators

120 Vac Transformer  
Selector Switch, Cam 1



#### Operator without Knob or Lever

Positions	Operator Action	Transformer Type—50/60 Hz 6V #755 Lamp Catalog Number <sup>③④</sup>	Full Voltage Type—AC or DC <sup>①</sup> Lamps—#755, #757, #1835, 120MB <sup>②</sup> Catalog Number <sup>④</sup>	
Two-position—60° throw		Cam Code 1 <sup>⑤</sup> E34VFB_	Cam Code 1 <sup>⑤</sup> E34SFB_	
Three-position—60° throw		Cam Code 2 <sup>⑤</sup> E34VGB_	Cam Code 3 <sup>⑤</sup> E34VHB_	Cam Code 2 <sup>⑤</sup> E34SGB_
		E34VNB_ <sup>⑥</sup>	E34VPB_ <sup>⑥</sup>	E34SNB_ <sup>⑦</sup>
		E34VJB_ <sup>⑥</sup>	E34VKB_ <sup>⑥</sup>	E34SJB_ <sup>⑦</sup>
		E34VLB_	E34VMB_	E34SLB_
		E34VSB_	E34VMB_	E34SMB_
Four-position—40° throw		E34VRB_	—	E34SRB_

#### Knob



#### Lever



#### Knobs and Levers

Color <sup>②</sup>	Knob Catalog Number and Code Number	Lever Catalog Number and Code Number
Red	10250TER	10250TFR
Green	10250TEG	10250TFG
Yellow	10250TEA	10250TFA
Blue	10250TEL	10250TFL
Clear	10250TEC	10250TFC
White	10250TEW	10250TFW
Amber	10250TEM	10250TFM

#### Light Unit Voltage Suffix

Add to operator Catalog Number listed in table above.

#### Type of Light Unit

Transformer Type 50/60 Hz		Full Voltage Type AC or DC <sup>①</sup>	
Voltage	Suffix Code	Voltage	Suffix Code
24	024	6	06
120	120	12	12
208	208	24	24
240	240	48	48
380	380	120	120
480	480	240 <sup>⑥</sup>	240
600	600		

#### Notes

Use NEMA 4X 10250T operators where exposed to ultraviolet light, see **Pages V7-T1-192 to V7-T1-263**.

<sup>①</sup> Full voltage light units can be used at other than listed voltages by changing lamp. Replacement lamps are listed on **Page V7-T1-249**.

<sup>②</sup> 120MB lamps are used on both 120V and 240V operators.

<sup>③</sup> Operator includes lens gasket and lens attachment screws.

<sup>④</sup> Add suffix code for light unit voltage to listed catalog number from Light Unit Voltage Suffix table above.

Example: For 24V transformer type light unit, order E34VFB024.

<sup>⑤</sup> For selection of the proper cam and contact block required to obtain a specific circuit sequence, see selection tables on **Pages V7-T1-283 to V7-T1-285**.

<sup>⑥</sup> 120 and 240V transformer only.

<sup>⑦</sup> 120 full voltage only.

<sup>⑧</sup> Resistor type. May generate excess heat if used in high density.

<sup>⑨</sup> Amber, clear and white lenses have a black arrow (R). Red, green and blue lenses have a white arrow (R).

### Accessories





#### Accessories

	Description	Catalog Number
<b>E34TA2</b> 	<b>Padlocking Attachment for Flush Pushbutton Operators.</b> Permits locking NC contacts in open position with 1/4 in padlock. Will not lock NO contact.	<b>E34TA2</b>
<b>10250TA_</b> 	<b>Flexible Weather Resistant Boot</b> for use with flush pushbutton operators.	
	Clear	<b>10250TA46</b>
	Black	<b>10250TA47</b>
	Red	<b>10250TA48</b>
	Green	<b>10250TA49</b>
	<b>Flexible Weather Resistant Boot</b> for use with button operators (extended buttons preferred).	
	Black	<b>10250TA3</b>
	Red	<b>10250TA4</b> ①
	Green	<b>10250TA10</b>
	Clear	<b>10250TA85</b>
	<b>Transparent Boot</b> for regular, illuminated pushbutton operators and PresTest.	<b>10250TA25</b> ②
<b>E34TA3_</b> 	<b>Special Retaining Nut</b> —to accommodate thick panel.	
	Indicating light	<b>E34TA30</b>
	PresTest, pushbuttons and selector switches	<b>E34TA31</b>
<b>E34TA6</b> 	<b>Shroud for Mushroom Head Operator</b> —prevents accidental operation. (Not for push-pull operators.)	<b>E34TA6</b>
<b>E34TA12</b> 	<b>Extended Retaining Nut</b> —replaces standard nut and provides guard for flush type pushbutton operators.	<b>E34TA12</b>
<b>E34TA15</b> 	<b>Guard for illuminated pushbutton</b>	<b>E34TA15</b>
<b>E34TA11</b> 	<b>Padlocking Attachment</b> for non-illuminated knob selector switches— accommodates up to five, 1/4 in padlocks.	<b>E34TA11</b>

**Notes**

- ① Should not be used on flush button for STOP function.
- ② Not suitable for single contact block depth cast enclosure. Cover is too thick.

#### Accessories, continued

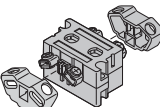
	Description	Catalog Number
<p><b>E34TK3</b></p> 	<p><b>Thrust Washer</b>—To meet Ford Motor Company mounting specifications.</p>	<p><b>E34TK3</b></p>
<p><b>10250TA7_</b></p> 	<p><b>Contact Block Terminal Jumps</b>—Available in multiples of 100 only.</p> <p>Terminal to terminal—within block (short):</p> <p>100 per package <b>10250TA70</b></p> <p>1000 per package <b>10250TA70-2</b></p> <p>Terminal to terminal—block to block (long):</p> <p>100 per package <b>10250TA71</b></p> <p>1000 per package <b>10250TA71-2</b></p>	
<p><b>10250TMT8</b></p> 	<p><b>Master Test (Dual Input) Module</b>—Internal Form C relay suitable for either AC or DC applications. Total electrical isolation between monitored and test circuit. Fits all illuminated 10250T, E22, E30 and E34 devices.</p> <p>48 Vdc <b>10250TMT8</b></p>	
<p><b>10250TFL_</b></p> 	<p><b>Flasher Module</b>—Internal Form C relay suitable for AC applications. One unit required for each operator in master test circuit.</p> <p>24 Vac <b>10250TFL2</b></p> <p>120 Vac <b>10250TFL1</b></p>	
<p><b>E22CW</b></p> 	<p><b>Panel Mounting Nut Wrench</b>—E22, E30, E34 and octagonal 10250T.</p>	<p><b>E22CW</b></p>
<p><b>10250TA101</b></p> 	<p><b>Fingerproof Shroud</b>—10 per package. Fits new style contact blocks and light units.</p>	<p><b>10250TA101</b></p>

### Options

#### Legend Plates ①

##### Field Color

Legend plates can be supplied printed on black, red, silver or white field. To order legend printed on a color other than indicated—add

suffix code to the end of the catalog number as follows:

“R” for Red field;  
“W” for White field; or  
“S” for Silver field.

Example: E34SP26**R**—  
Standard plate with red field marked OPEN.

#### Standard



#### Jumbo



#### For Pushbutton Operators and Indicating Lights

Legend	Color of Field	Standard ② Catalog Number	Jumbo Catalog Number	Legend	Color of Field	Standard ② Catalog Number	Jumbo Catalog Number
<b>Letters on Legend Plates Below are 3/16 in High</b>							
CLAMP	Black	E34SP90	E34LP90	OFF	Red	E34SP24	E34LP24
CLOSE		E34SP73	E34LP73	ON	Black	E34SP25	E34LP25
DOWN		E34SP74	E34LP74	OPEN		E34SP26	E34LP26
EMERG. STOP	Red	E34SP13	E34LP13	OUT		E34SP27	E34LP27
FAST	Black	E34SP75	E34LP75	POWER ON		E34SP80	E34LP80
FASTER		E34SP87	E34LP87	RAISE		E34SP28	E34LP28
FEEDER ON		E34SP94	E34LP94	READY		E34SP86	E34LP86
FEEDER OFF		E34SP95	E34LP95	RESET		E34SP29	E34LP29
FORWARD		E34SP15	E34LP15	REVERSE		E34SP30	E34LP30
HIGH		E34SP16	E34LP16	RUN		E34SP31	E34LP31
IN		E34SP17	E34LP17	SAFE		E34SP85	E34LP85
INCH		E34SP18	E34LP18	SLOW		E34SP32	E34LP32
JOG		E34SP19	E34LP19	SLOWER		E34SP88	E34LP88
JOG FOR.		E34SP20	E34LP20	START		E34SP33	E34LP33
JOG REV.		E34SP21	E34LP21	STOP	Red	E34SP34	E34LP34
LOW		E34SP22	E34LP22	TEST	Black	E34SP83	E34LP83
LOWER		E34SP23	E34LP23	TRANSFER		E34SP93	E34LP93
LUBE-FAIL		E34SP92	E34LP92	TRIP		E34SP84	E34LP84
MOTOR RUN		E34SP81	E34LP81	UNCLAMP		E34SP91	E34LP91
MOTOR STOP		E34SP82	E34LP82	UP		E34SP35	E34LP35

#### Blank Plastic Legend Plates—Square ③

Color Lettering	Field Side 1	Side 2	Standard Catalog Number	Jumbo Catalog Number	Extra Large Catalog Number
Black	White	Silver	10250TSP76	10250TLP76	10250TEP76
White	Red	Black	10250TSP77	10250TLP77	10250TEP77

#### Notes

- ① For dimensions, see **Page V7-T1-268**.
- ② 3/32 in high lettering.
- ③ Legend plates with non-standard markings or aluminum legend plates see 10250T listing on **Page V7-T1-242**.



1

#### Standard

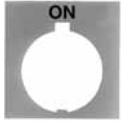

#### Jumbo



#### For Selector Switch Operators

Legend	Color of Field	Standard Catalog Number	Jumbo Catalog Number	Legend	Color of Field	Standard Catalog Number	Jumbo Catalog Number
<b>Two-Position—3/16 in High Lettering</b>				<b>Three-Position—3/16 in High Lettering</b>			
FOR. REV.	Black	<b>E34SP38</b>	<b>E34LP38</b>	AUTO OFF HAND	Black	<b>E34SP49</b>	<b>E34LP49</b>
HAND AUTO		<b>E34SP39</b>	<b>E34LP39</b>	FOR. OFF REV.		<b>E34SP50</b>	<b>E34LP50</b>
HIGH LOW		<b>E34SP40</b>	<b>E34LP40</b>	FOR. SAFE REV.		<b>E34SP69</b>	<b>E34LP69</b>
JOG RUN		<b>E34SP41</b>	<b>E34LP41</b>	HAND OFF AUTO		<b>E34SP51</b>	<b>E34LP51</b>
MAN. AUTO		<b>E34SP67</b>	<b>E34LP67</b>	MAN. OFF AUTO		<b>E34SP68</b>	<b>E34LP68</b>
OFF ON		<b>E34SP42</b>	<b>E34LP42</b>	OPEN OFF CLOSE		<b>E34SP53</b>	<b>E34LP53</b>
OPEN CLOSE		<b>E34SP43</b>	<b>E34LP43</b>	RUN SAFE JOG		<b>E34SP70</b>	<b>E34LP70</b>
RUN JOG		<b>E34SP44</b>	<b>E34LP44</b>	UP OFF DOWN		<b>E34SP54</b>	<b>E34LP54</b>
SAFE RUN		<b>E34SP45</b>	<b>E34LP45</b>	ON STOP SAFE		<b>E34SP71</b>	<b>E34LP71</b>
START JOG		<b>E34SP46</b>	<b>E34LP46</b>				
START STOP		<b>E34SP47</b>	<b>E34LP47</b>				
UP DOWN		<b>E34SP48</b>	<b>E34LP48</b>				

#### For Push-Pull Units

Legend	Color of Field	Standard <sup>①</sup> Catalog Number	Jumbo <sup>②</sup> Catalog Number
PULL ON/PUSH OFF	Black	<b>E34PP5</b>	<b>E34R5</b>
PULL OPEN/PUSH CLOSE	Black	<b>E34PP8</b>	<b>E34R8</b>
PULL UP/PUSH DOWN	Black	<b>E34PP11</b>	<b>E34R11</b>



#### Notes

- ① 3/32 in (2.4 mm) high lettering.
- ② 1/8 in (3.2 mm) high lettering.

### Enclosures

#### Die Cast, Polyester and Stainless Steel Enclosures

##### Enclosures (Case and Cover)—Surface Mounting <sup>①</sup>

	Number of Elements	One Contact Block Depth Catalog Number	Two Contact Block Depth Catalog Number
<b>Die Cast Enclosure</b> 	<b>Die Cast Enclosure—In-Line <sup>②③</sup> NEMA 4, 4X, 12, 13</b>		
	1	E34N1	E34N11
	2	E34N2	E34N12
	3	E34N3	E34N13
	4	—	E34N14
<b>Polyester Enclosure</b> 	<b>Polyester—In-Line NEMA 3, 4X, 12</b>		
	1	—	E34N51
	2	—	E34N52
	3	—	E34N53
	4	—	E34N54
<b>Stainless Steel Enclosure</b> 	<b>Stainless Steel <sup>④</sup>—In-Line NEMA 4, 4X, 12</b>		
	1	—	10250TN33
	2	—	10250TN34
	3	—	10250TN35
	4	—	10250TN36

**Dimensions, see Page V7-T1-302.**

### Mounting Instructions

These E34 Die Cast Enclosures feature a corrosion resistant coating identical to finish on the E34 operators except gray in color. Not for use in ultraviolet light applications.

#### One and Two Contact Block Depth Enclosures

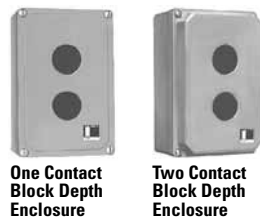

#### Enclosure Layouts

Top – For Vertical Mounting

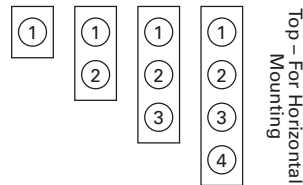

### Notes

- ① For spacing increments, see **Page V7-T1-294**.
- ② All die cast enclosures can be converted to base mounting of contact blocks with spacers 10250TA22 or 10250TA23. See listing on **Page V7-T1-237**.
- ③ When used with E30 pushbuttons, only the one element enclosure can be used.
- ④ 14 gauge, type 304.

#### Die Cast and Stainless Steel—Flush Mount, Covers Only<sup>①</sup>

##### Flush Mounting Covers



##### Covers Only—Flush Mounting

Number of Elements	Catalog Number	Catalog Number
<b>Flush Die Cast Covers</b>		
	<b>In-Line Deep Cover</b>	<b>In-Line Flat Cover</b>
1	E34F11	E34F1
2	E34F12	E34F2
3	E34F13	E34F3
4	E34F14	E34F4
<b>In-Line Stainless Steel Flush Plates<sup>②</sup></b>		
	<b>With Pullbox</b>	<b>Without Pullbox</b>
1	10250TS10	10250TS1
2	10250TS11	10250TS2
3	10250TS12	10250TS3
4	10250TS14	10250TS4
<b>Dimensions, see Page V7-T1-303.</b>		

#### Spacing Increments

Approximate Dimensions in Inches (mm)

Type	F	G	H
Die cast	2.44 (62.0)	2.5 (63.5)	1.88 (47.8)
Polyester	1.88 (47.8)	Min. 2.13 (54.1)	2.25 (57.2)
Stainless steel	1.69 (42.9)	Min. 1.73 (43.9)	2.25 (57.2)

#### Spacing Increments for Enclosures

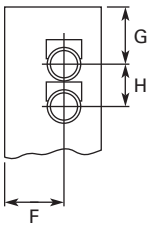

#### Enclosure Layouts

Top – For Vertical Mounting

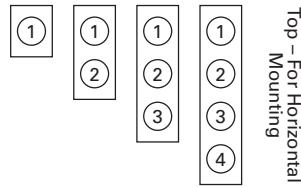

#### Notes

- ① These E34 die cast covers feature a corrosion resistant coating identical to the finish on the E34 operators except gray in color.
- ② Not oiltight. NEMA 1 applications only.

### Contact Blocks

#### Standard Contact Blocks

- UL A600/P600 rated
- Color-coded plungers—red/green for NC/NO circuits
- Silver contact tips with “reliability nibs”
- Black (opaque) or amber (translucent) housings
- Pressure plate or spade terminals
- Fingerproof shrouds (for pressure terminals only)

#### Logic Level Contact Blocks

- UL A600/P600 rated
- Black plungers
- Inert palladium knife-blade contacts
- Black (opaque) housings
- Pressure plate or spade terminals
- Fingerproof shrouds not available

#### Special Function Contact Blocks

- UL A600/P600 rated
- Black plungers
- Silver contact tips with “reliability nibs”
- Black (opaque) housings
- Pressure plate terminals only
- Fingerproof shrouds not available

#### Special Purpose Contact Block

- Maximum 300V rated
- Black plungers
- Silver contact tips with “reliability nibs”
- Black (opaque) housings
- Pressure plate terminals only
- Fingerproof shrouds not available

#### Reliability Nibs

Reliability nibs are the hallmark of Eaton’s contact blocks. A pointed silver nib on the contact tip ensures reliable switching from logic level (5V) up to 600V applications. Therefore standard contact blocks can be used for most logic level applications where the contacts are not exposed to any harsh environmental conditions.

#### Palladium Contacts

Palladium, which is more inert than gold, is well suited for voltages and currents approaching zero and is recommended for applications where environmental conditions are a factor.

#### Maximum Contact Block Mounting per Operator Type

Operator	Max. Stack
Pushbuttons	6
Push-pull operators	2
Roto-push operators	4
Two- or three-position selector switches	6
Four-position selector switches	4
Joysticks	4

10250T1



Contact Blocks

Symbol	Circuit	Description <sup>①</sup>	Standard	Spade Terminal <sup>②</sup>	Logic Level	Spade Terminal <sup>②</sup>
			Pressure Terminal Catalog Number	Catalog Number	Pressure Terminal Catalog Number	Catalog Number
	1NC	Stack up to six blocks (six circuits) unless otherwise noted.	<b>10250T51</b>	<b>10250T59</b>	<b>10250T51E</b>	<b>10250T59E</b>
	1NO	Stack up to six blocks (six circuits) unless otherwise noted.	<b>10250T53</b>	<b>10250T60</b>	<b>10250T53E</b>	<b>10250T60E</b>
	NO-NC	Stack up to six blocks (12 circuits) unless otherwise noted.	<b>10250T1</b>	<b>10250T40</b>	<b>10250T1E</b>	<b>10250T40E</b>
	2NC	Stack up to six blocks (12 circuits) unless otherwise noted.	<b>10250T3</b>	<b>10250T42</b>	<b>10250T3E</b>	<b>10250T42E</b>
	2NO	Stack up to six blocks (12 circuits) unless otherwise noted.	<b>10250T2</b>	<b>10250T41</b>	<b>10250T2E</b>	<b>10250T41E</b>
<b>Special Function Blocks <sup>③</sup></b>						
	LONC	Late opening NC. Stack up to six blocks (six circuits) unless otherwise noted.	<b>10250T71 <sup>③</sup></b>	—	<b>10250T71E <sup>③</sup></b>	—
	ECNO-NC	Early closing NO and standard NC. Stack up to six blocks unless otherwise noted.	<b>10250T47 <sup>③④</sup></b>	—	<b>10250T47E <sup>③</sup></b>	—
	ECNO-NO	Early closing NO and standard NO. Stack up to four blocks unless otherwise noted.	<b>10250T57 <sup>③④</sup></b>	—	<b>10250T57E <sup>③</sup></b>	—
	2LONC	Two late opening NC contacts. Stack up to six blocks unless otherwise noted.	<b>10250T45 <sup>③</sup></b>	—	<b>10250T45E <sup>③</sup></b>	—
	LONC-ECNO	Overlapping contacts. Stack up to four blocks unless otherwise noted.	<b>10250T55 <sup>③④</sup></b>	—	<b>10250T55E <sup>③</sup></b>	—
<b>Special Purpose Blocks <sup>⑤</sup></b>						
	2NO-2NC	Four circuits in single block depth. Rated 300V max. Stack up to four blocks unless otherwise noted.	<b>10250T44 <sup>⑤</sup></b>	—		

Notes

- ① All 10250T contact blocks shown are suitable for use on standard 10250T and E34 operators. These contact blocks are not suitable for Class I Division 2 type 10250T or E34 devices.
- ② Contact blocks with spade terminals are limited to a maximum of one contact block per operator and minimum spacing between devices is 2.5 in (63.5 mm). Not suitable for use in 10250T or E34 enclosures. Also available in amber housing. Not available with fingerproof shrouds.
- ③ Special function contact blocks are not suitable for use with roto-push operators, three-position push-pull operators, or four-position selector switches.
- ④ ECNO contact blocks are not suitable for use with two-position joysticks or when operators are used with padlock attachments.
- ⑤ Special purpose 10250T44 contact blocks are not suitable on selector switches or roto-push operators. Okay to use with three-position push-pull operators only on low voltage (30V or less) circuits.

10250T1CP



### Contact Blocks with Fingerproof Shrouds

Symbol	Circuit	Description <sup>①</sup>	Standard Pressure Terminal <sup>②</sup> Catalog Number	Logic Level Pressure Terminal <sup>②</sup> Catalog Number
Blank No Plunger	1NC	Stack up to six blocks (six circuits) unless otherwise noted.	<b>10250T51P</b>	<b>10250T51EP</b>
Blank No Plunger	1NO	Stack up to six blocks (six circuits) unless otherwise noted.	<b>10250T53P</b>	<b>10250T53EP</b>
Blank No Plunger	NO-NC	Stack up to six blocks (12 circuits) unless otherwise noted.	<b>10250T1P</b>	<b>10250T1EP</b>
Blank No Plunger	2NC	Stack up to six blocks (12 circuits) unless otherwise noted.	<b>10250T3P</b>	<b>10250T3EP</b>
Blank No Plunger	2NO	Stack up to six blocks (12 circuits) unless otherwise noted.	<b>10250T2P</b>	<b>10250T2EP</b>
<b>Special Function Blocks <sup>③</sup></b>				
Blank No Plunger	LONC	Late opening NC. Stack up to six blocks (six circuits) unless otherwise noted.	<b>10250T71P <sup>④</sup></b>	<b>10250T71EP <sup>④</sup></b>
Blank No Plunger	ECNO-NC	Early closing NO and standard NC. Stack up to six blocks unless otherwise noted.	<b>10250T47P <sup>③④</sup></b>	<b>10250T47EP <sup>④</sup></b>
Blank No Plunger	ECNO-NO	Early closing NO and standard NO. Stack up to four blocks unless otherwise noted.	<b>10250T57P <sup>③④</sup></b>	<b>10250T57EP <sup>④</sup></b>
Blank No Plunger	2LONC	Two late opening NC contacts. Stack up to six blocks unless otherwise noted.	<b>10250T45P <sup>④</sup></b>	<b>10250T45EP <sup>④</sup></b>
Blank No Plunger	LONC-ECNO	Overlapping contacts. Stack up to four blocks unless otherwise noted.	<b>10250T55P <sup>③④</sup></b>	<b>10250T55EP <sup>④</sup></b>

## Replacement Parts

### Replacement Lamps—For E34 Illuminated Operators

Mfg. Lamp Type	Voltage	Base Style	Application	Part Number
120MB	120V	T 3-1/4 bayonet	10250T resistor indicating light	<b>28-3044</b>
#267	6.3V	T 3-1/4 bayonet	10250T flasher	<b>10250ED986-4</b>
#755	6.3V	T 3-1/4 bayonet	10250T transformer, PresTest and full voltage	<b>28-2202</b>
#756	12V	T 3-1/4 bayonet	10250T full voltage	<b>28-5184</b>
#757	24V	T 3-1/4 bayonet	10250T full voltage	<b>28-5185</b>
#1828	32V	T 3-1/4 bayonet	10250T full voltage	<b>28-5186</b>
#1835	55V	T 3-1/4 bayonet	10250T resistor	<b>28-5187</b>
NE48	120V	T 4-1/2 bayonet	10250T neon	<b>28-494</b>
NE51H-R22	120V	T 3-1/4 bayonet	10250T neon	<b>28-3754</b>
NE51H-R68	240V	T 3-1/4 bayonet	10250T neon	<b>28-3755</b>

**Notes**

- ① All 10250T contact blocks shown are suitable for use on standard 10250T and E34 operators. These contact blocks are not suitable for Class I Division 2 type 10250T or E34 devices.
- ② To order contact blocks with translucent amber housing, change suffix P to **CP** in catalog number, e.g., 10250T51**CP**.
- ③ ECNO contact blocks are not suitable for use with two-position joysticks or when operators are used with padlock attachments.
- ④ Special function contact blocks are not suitable for use with roto-push operators, three-position push-pull operators, or four-position selector switches.



**Flush Head Pushbutton Operator**



**Mushroom Head Pushbutton Operator**



**Jumbo Mushroom Head Operator**

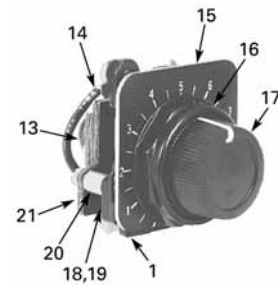

**Potentiometers**



**Illuminated Pushbutton Operator**



**Transformer Type Indicating Light**



**Knob-Operated Selector Switch Operator**

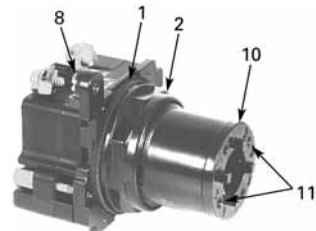

**Full Voltage, Resistor and Transformer Type Illuminated Selector Switch**

#### E34 Style Operator Replacement Parts

Item No.	Description	No. Req.	Part Number
1	Gasket	1	16-1548
2	Mounting nut	1	15-1530-4
3	Set screw (#6-32 x 0.250 in long hollow hex)	2	11-2014
4	Mushroom head button (includes [2] item 5)	1	As Req. Below
	Black	—	53-1317
	Red	—	53-1317-2
	Yellow	—	53-1317-3
	Green	—	53-1317-4
	Blue	—	53-1317-22
5	Set screw (#10-32 x 0.250 in long hollow hex)	2	11-544
6	Jumbo mushroom head button (aluminum—includes [2] item 5)	1	As Req. Below
	Red	—	53-1317-9
	Black	—	53-1317-10
	Yellow	—	53-1317-11
	Green	—	53-1317-12
7	Jumbo mushroom head button (aluminum—red EMERG. STOP) does not include item 5	1	53-1349-18
8	Mounting screw (#6-32 x 0.710 in long)	2	10250TA79
	Washer	2	16-2038
9	Terminal screw and lug (captive)	Req.	80-5502
10	Gasket (supplied with basic unit)	1	32-803
11	Round head screw (#4-40 x 0.344 in long) (supplied with basic unit)	2	11-4553

Item No.	Description	No. Req.	Part Number
12	Mounting screw	2	11-1632
13	Simple potentiometer (does not include items 18, 28 or 29)	1	As Req. Below
	1,000 ohms	—	41-782-2
	2,500 ohms	—	41-782-3
	5,000 ohms	—	41-782-10
	10,000 ohms	—	41-782-4
	25,000 ohms	—	41-782-5
	50,000 ohms	—	41-782-6
14	Connector (includes screw and lug)	2	25-1851
15	Indicating plate	1	As Req. Above
	Standard size (without legend)	—	30-4460
	Large size (specify legend)	—	10250TR30
16	Retaining nut	1	15-1547-3
17	Knob	1	53-1314
	Socket set screw (#6-32 x 0.250 in long)	1	11-2014
18	Coupling	1	11-2014 29-3749-2
19	Set screw (#6-32 x 0.188 in long)	1	11-1199
20	Spacer	2	56-1066-18
21	Connector (includes screw and lug)	1	25-1851-2
22	Mounting nut	1	15-1938-2

## Technical Data and Specifications

### Mechanical Ratings

Description	Specification
<b>Frequency of Operation</b>	
All pushbuttons	6000 operations/hr.
Key and lever selector switches	3000 operations/hr.
Auto-latch devices	1200 operations/hr.
<b>Life</b>	
Pushbuttons	10 x 10 <sup>6</sup> operations
Contact blocks	10 x 10 <sup>6</sup> operations
PresTest units	10 x 10 <sup>6</sup> operations
Lever and key selector switches	0.25 x 10 <sup>6</sup> operations
Twist to release pushbuttons	0.3 x 10 <sup>6</sup> operations
<b>Shock Resistance</b>	
Duration	210 ms ≥5g

### General Specifications

Description	Specification
<b>Climate Conditions</b>	
Operating temperature	1° to 150°F (–17° to 66°C)
Storage temperature	–40° to 176°F (–40° to 80°C)
Altitude	6,562 ft (2,000m)
Humidity	Max. 95% RH at 60°C
<b>Terminals</b>	
Marking	NC-NO on the contact block to meet the NEMA requirements. Dual marking system 1–2 for normally closed, 3–4 for normally open to meet BS5472 (Cenelec EN50 005).
Clamps	Terminals are saddle clamp type for 1 x 22 AWG (0.34 mm <sup>2</sup> ) to 2 x 14 AWG (2.5 mm <sup>2</sup> ) conductors
Torque	7 lb-in (0.8 Nm)
Degree of protection against direct electrical contact	IP2X with fingerproof shroud
<b>Light Units</b>	
Transformers	Will withstand short-circuit for 1 hour per IEC 60947-5-1
Bulbs—average life:	
Transformer type	20,000 hrs.
Resistor/direct voltage type	2500 hrs. minimum at rated V
LED	60,000 to 100,000 hrs.



#### Electrical Ratings

Description	Specification
Insulation	$U_i = 660 \text{ Vac or Vdc}$
Thermal	$I_{th} = 10\text{A}$
<b>Short Circuit Coordination to IEC/EN 60947-5-1</b>	
Rated conditional short circuit current	1 kA
Fuse type	GE power controls TIA 10, red spot type gG, 10A, 660 Vac, 460 Vdc, BS88-2, IEC 60269-2-1
	
UL rating	A600, P600
AC load life duty cycle 1200 operations/hour	
10A	110V pf 0.4— $1 \times 10^6$ operations
5A	250V pf 0.4— $1 \times 10^6$ operations
2A	600V pf 0.4— $1 \times 10^6$ operations
Switching capacity	
AC 15 rated make/break ( $11 \times I_b$ at $1.1 \times U_b$ )	
6A	120V pf 0.3
4A	240V pf 0.3
2A	660V pf 0.3
DC13 rated make/break ( $1.1 \times I_b$ at $1.1 \times U_b$ )	
1.0A	125V L/R $\geq 0.95$ at 300 ms
0.55A	250V L/R $\geq 0.95$ at 300 ms
0.1A	660V L/R $\geq 0.95$ at 300 ms
10A	110V pure resistive
Maximum ratings for logic level and hostile atmosphere application	
Maximum amperes	0.5A
Maximum volts	120 Vac/Vdc
Low voltage switching	Conical shaped points or “reliability nibs” improve performance in dry circuit, corrosive, fine dust and other contaminated atmospheres. Under normal environmental conditions, the minimum operational voltage is 5V and the minimum operational current is 1 mA, Vac/Vdc.
Contact operation	Slow make and break. All normally closed contacts have positive opening operation, i.e., normally closed contacts are forced open in the event of contact weld or spring breakage.

#### Electrical Ratings—Contact Block

Meet or Exceed NEMA Rating Designations A600, A300 and B300 for AC and P600 for DC

Description	50 Vac or 60 H				Vdc		
	120	240	480	600	24/28	125	250
<b>Meet or Exceed NEMA Rating Designations A600, A300 and B300 for AC and P600 for DC</b>							
Make and emerg. interrupting capacity (amp)	60	30	15	12	5.7	1.1	0.55
Normal load break (amp)	6	3	1.5	1.2	5.7	1.1	0.55
Thermal current (amp)	10	10	10	10	5.0	5.0	5.0
Voltamperes:							
Make and emerg. interrupting capacity	7200	7200	7200	7200	138	138	138
Normal load break	720	720	720	720	138	138	138

### Mounting Options

#### Panel Thickness

- Minimum: 0.06 in (1.6 mm)
- Maximum: 0.25 in (8 mm) including legend plate
- Maximum can be increased to 0.375 in (15.9 mm) using optional retaining nut
  - Indicating light: 10250TA30
  - Pushbutton/selector switch: 10250TA31

### Mounting Matrix

Legend Plate	Dimensions in Inches (mm)			
	A	B	C	D
Small	1.63 (41.3)	2.25 (57.2)	2.25 (57.2)	1.63 (41.3)
Medium	1.75 (44.5)	2.25 (57.2)	2.25 (57.2)	1.75 (44.5)
Large	2.25 (57.2)	2.25 (57.2)	2.25 (57.2)	2.25 (57.2)

### Mounting Options in Inches (mm)

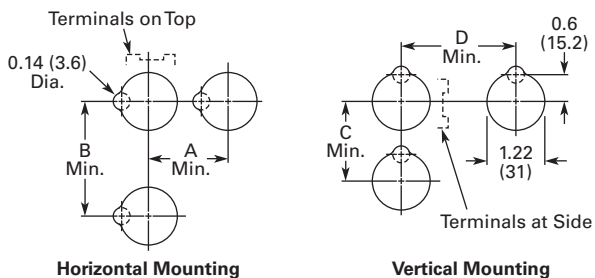

Horizontal mounting means terminals are located top and bottom of contact block. Vertical mounting means terminals are left and right of contact block. This allows close spacing of adjacent operators with easy access to terminals.

Locating nib hole or notch is 0.14 in (3.6 mm) #29 drill.

### Drilling Dimensions in Inches (mm)

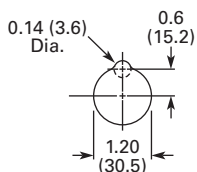

# 1

## Dimensions

Approximate Dimensions in Inches (mm)

### Potentiometer

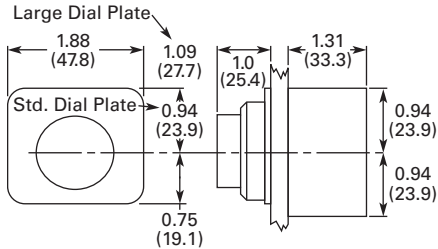

### Legend Plates

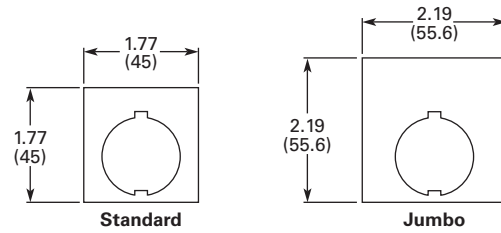

## Surface Mounting

### Die Cast, Polyester and Stainless Steel Enclosures

4 Mtg. Holes — 10-32 Screw Size for  
1 – 4 Element Die Cast/  
Stainless Steel Enclosure  
7/32 Screw Size for  
Polyester

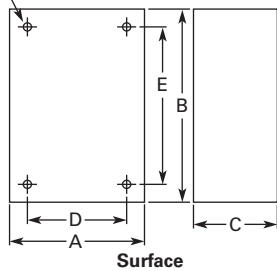

Number of Elements	Element Arrangement	Wide A	High B	Deep C	Mounting D	E	Conduit Entrance
<b>Die Cast</b>							
1	In-line	3.88 (98.6)	4.00 (101.6)	3.00 (76.3) ①	2.69 (68.3)	3.25 (82.6)	3/4
2		3.88 (98.6)	5.88 (149.4)	3.00 (76.3) ①	2.69 (68.3)	5.13 (130.3)	
3		3.88 (98.6)	7.75 (196.9)	3.00 (76.3) ①	2.69 (68.3)	7.00 (177.8)	1
4		3.88 (98.6)	9.63 (244.6)	3.00 (76.3) ①	2.69 (68.3)	8.88 (225.6)	
<b>Polyester</b>							
1	In-line	3.81 (96.8)	6.63 (168.4)	3.38 (85.9)	2.94 (74.7)	4.88 (124.0)	②
2		3.81 (96.8)	6.63 (168.4)	3.38 (85.9)	2.94 (74.7)	4.88 (124.0)	
3		3.81 (96.8)	8.88 (225.6)	3.38 (85.9)	2.94 (74.7)	7.13 (181.1)	
4		3.81 (96.8)	11.13 (282.7)	3.38 (85.9)	2.94 (74.7)	9.38 (238.3)	
<b>Stainless Steel</b>							
1	In-line	3.00 (76.2)	3.50 (88.9)	3.00 (76.2)	1.50 (38.1)	4.25 (108.0)	②
2		3.50 (88.9)	6.75 (171.5)	3.00 (76.2)	1.50 (38.1)	7.50 (190.5)	
3		3.50 (88.9)	9.00 (228.6)	3.00 (76.2)	1.50 (38.1)	9.00 (228.6)	
4		3.50 (88.9)	11.25 (285.8)	3.00 (76.2)	1.50 (38.1)	12.00 (304.8)	

### Notes

- ① Depth given is for two contact block deep stations. One contact block deep stations subtract 3/4 in (19.1 mm).
- ② No conduit entrance holes provided. Drill as required.

Approximate Dimensions in Inches (mm)

### Flush Mounting

#### Die Cast and Stainless Steel Covers Only

4 Mtg. Holes - 10-32 Screw Size  
for 1-11 Element Encl, 1/4-20  
Screw Size for 12 Element  
and Larger

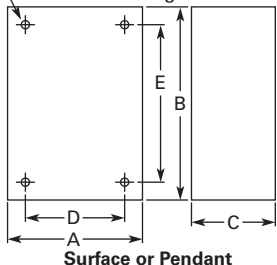

Number of Elements	Wide A	High B	Deep C	Mounting D	E
<b>Die Cast</b>					
1	3.88 (98.6)	4.00 (101.6)	0.25 (6.4) ①	3.50 (88.9)	3.63 (92.2)
2	3.88 (98.6)	5.88 (149.4)	0.25 (6.4) ①	3.50 (88.9)	5.50 (139.7)
3	3.88 (98.6)	7.75 (196.9)	0.25 (6.4) ①	3.50 (88.9)	6.00 (152.4)
4	3.88 (98.6)	9.63 (244.6)	0.25 (6.4) ①	3.50 (88.9)	9.25 (235.0)
<b>Stainless Steel</b>					
1	5.00 (127.0)	5.00 (127.0)	2.50 (63.5) ②	3.25 (82.6)	1.88 (47.8)
2	5.00 (127.0)	6.88 (174.8)	2.50 (63.5) ②	3.25 (82.6)	3.63 (92.2)
3	5.00 (127.0)	8.63 (219.2)	2.50 (63.5) ②	3.25 (82.6)	5.50 (139.7)
4	5.00 (127.0)	10.50 (266.7)	2.50 (63.5) ②	3.25 (82.6)	7.25 (184.2)

#### Notes

- ① Depth given is for flat cover. Deep cover is 3/4 in (19.1 mm) deeper.
- ② Depth given includes pull box.

# 1.9

## Pushbuttons and Indicating Lights

30.5 mm Corrosion Resistant Watertight/Oiltight—E34

1

Approximate Dimensions in Inches (mm)

### Padlocking Attachment for Flush Pushbutton Operators

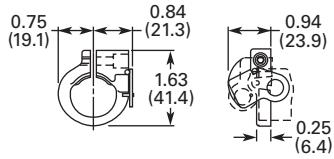

### Flexible Weather Resistant Boot

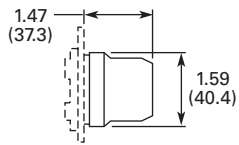

### Transparent Boot

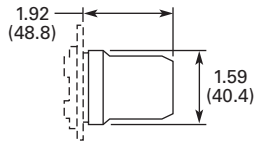

### Shroud for Mushroom Head Operator

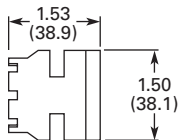

### Extended Retaining Nut

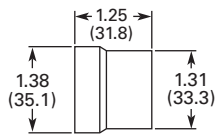

### Guard for Illuminated Pushbutton

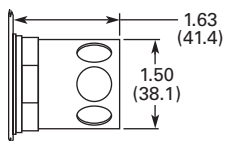

### Contact Block Terminal Jumps

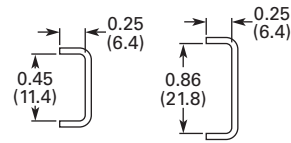

### Master Test Module and Flasher Module

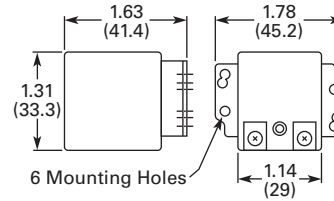

### Flush Pushbutton

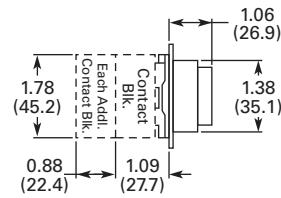

### Extended Pushbutton

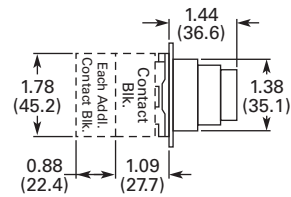

### Half Shroud Pushbutton

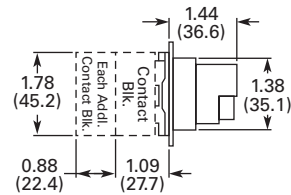

Approximate Dimensions in Inches (mm)

**Mushroom Pushbutton**

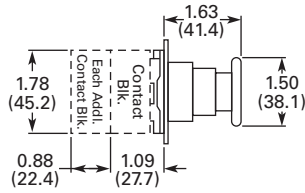

**Illuminated Pushbutton**

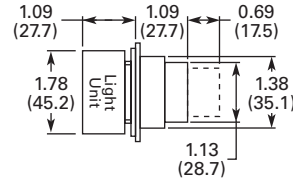

**Jumbo Mushroom Pushbutton**

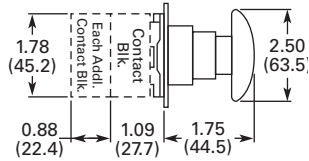

**Selector Switch**

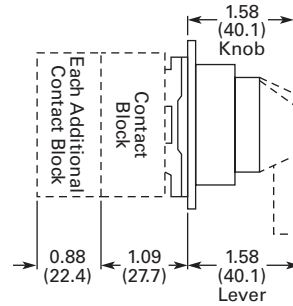

**Push-Pull Switch**

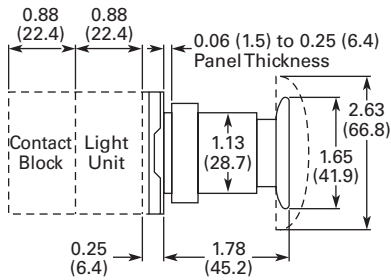

**Key Selector Switch**

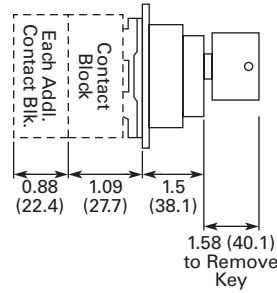

**Indicating Light**

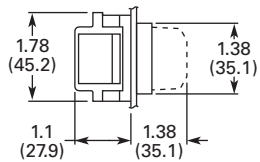

**Illuminated Selector Switch**

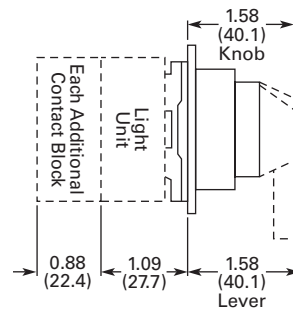

**PresTest Indicating Light**

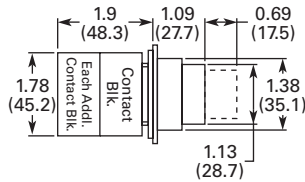



## Product Description

The HT800 Series from Eaton's Electrical Sector is a family of 30.5 mm pushbutton devices which includes momentary, illuminated and mushroom head pushbuttons, selector switches, indicating lights and push-pull switches. The HT800 devices have a familiar appearance found in most industrial applications and are suitable for replacement of several other manufacturers' 30.5 mm pushbutton devices.

## Features

- Anodized aluminum mounting rings
- Watertight double V-gasket seals
- Extended height bulbs
- Transparent housing contact blocks
- Color-coded contact blocks
- Gold-plated contacts (on low voltage contact block)
- Reliability ridge on movable contact
- Stackable screw-mounted contact blocks
- Contact blocks can be mounted in left/right or top/bottom positions
- Standard NC contact opens before NO contact closes (break before make operation)
- Bright and long lasting LED indicating lights in six colors
- Field convertible maintained selector switches—from two- to three-position and vice versa
- Field selectable knob/lever mounting positions—at any 22.5° increment

## Contents

### Description

Description	Page
30.5 mm Watertight/Oiltight—HT800	
Catalog Number Selection	V7-T1-307
Product Selection	
Momentary Pushbutton Units, Non-Illuminated	V7-T1-308
Illuminated Pushbutton Units	V7-T1-310
Guarded Illuminated Pushbutton Units	V7-T1-312
Indicating Light Units	V7-T1-314
Push-Pull Units	V7-T1-316
Illuminated Push-Pull Units	V7-T1-317
Selector Switch Units	V7-T1-318
Selector Switch Contact Block Selection	V7-T1-320
Accessories	V7-T1-321
Options	V7-T1-322
Replacement Parts	V7-T1-325
Technical Data and Specifications	V7-T1-326
Dimensions	V7-T1-327

## Benefits

- Corrosion resistant NEMA 4X finish
- Watertight and oiltight NEMA 4, 13 ingress protection
- Increased side illumination of indicating lights and illuminated pushbuttons
- Easy visual inspection of contact conditions
- Easily identifiable NO (white) or NC (black) contact blocks
- Gold-plated contacts suitable for logic level circuits
- Reliability ridge penetrates contamination buildup on stationary contacts
- Left/right or top/bottom mounted contact blocks allow correct positioning in retrofit applications
- All-purpose selector switches are convertible and can rotate in 22.5° increments to suit panel layouts

## Standards and Certifications

- UL508 per File No. E131568
- CSA C22.2 No. 14 per File No. LR68551



## Ingress Protection

- UL (NEMA) Type 1, 2, 3, 3R, 4, 4X, 12 and 13 when mounted in similarly rated enclosures

**Catalog Number Selection**

Catalog Number Selection is for illustrative purposes only and not to be used to create new catalog numbers.

**HT800 Pushbuttons, Push-Pulls and Indicating Lights**

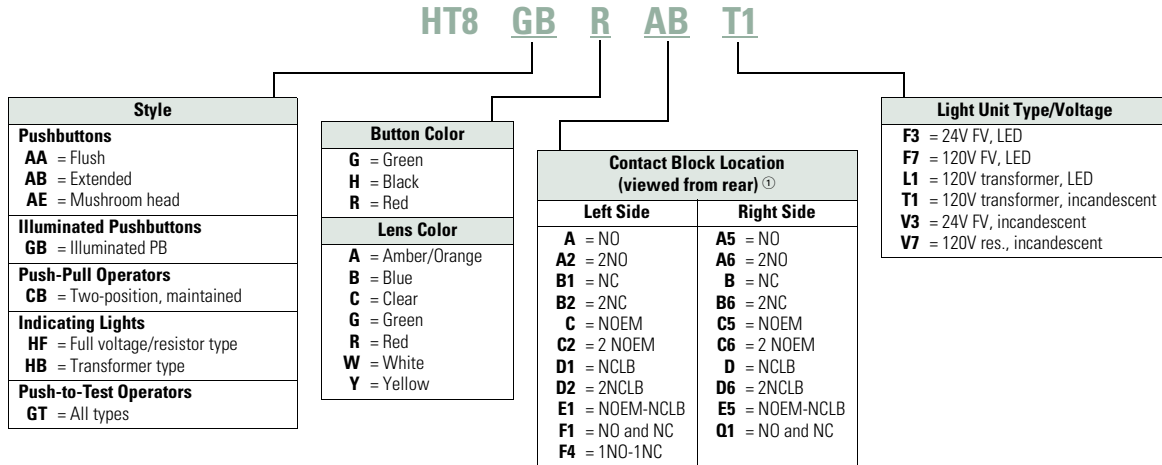

**HT800 Selector Switch**

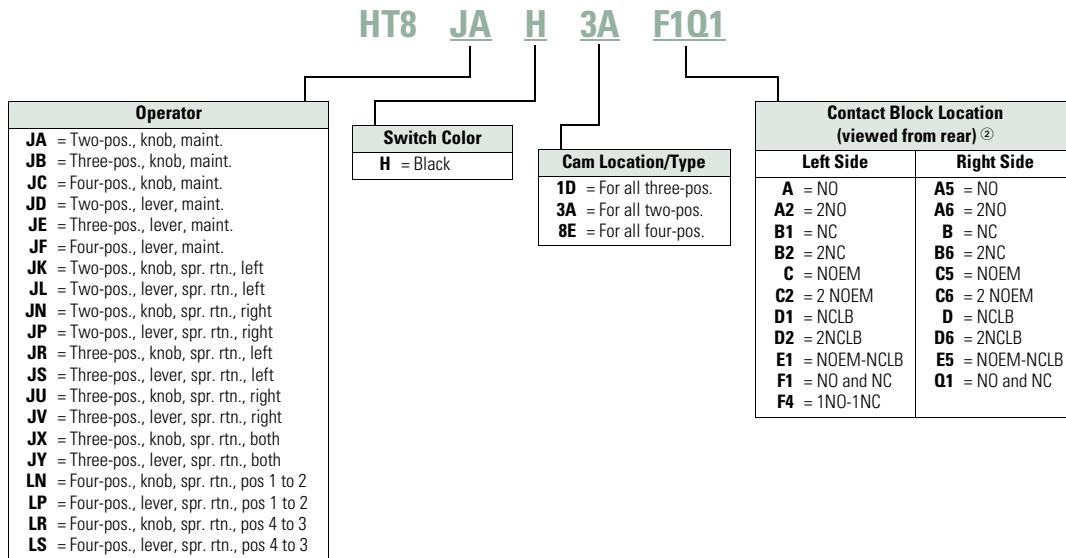

**Notes**

- ① Maximum of four contact blocks per side or a total of eight contact blocks recommended.
- ② Maximum of two contact blocks per side or a total of four contacts blocks recommended.



**Product Selection****Momentary Pushbutton Units, Non-Illuminated**

UL (NEMA) Type 3, 3R, 4, 4X, 12 and 13

- Flush, extended or 40 mm mushroom head operators

**HT800 Pushbuttons****HT800 Pushbuttons—Point-of-Purchase Units**

Description	Catalog Number
Two-position maintained selector switch 1NO/1NC contact block, three square legend plates: OFF ON, MAN. AUTO, UP DOWN	<b>HT8JAH3AAB-POP</b>
Three-position maintained selector switch, black knob, 1NO/1NC contact block, three square legend plates: HAND OFF AUTO, FOR. OFF REV., OPEN OFF CLOSE	<b>HT8JBH1DAB-POP</b>
Three-position selector switch, spring return from left and right, black knob, 1NO/1NC contact block, three square legend plates: UP OFF DOWN, FOR OFF REV., OPEN OFF CLOSE	<b>HT8JXH1DAB-POP</b>
Red push-pull emergency stop, 1NO/1NC contact block, three square legend plates: STOP, EMERG. STOP, OFF	<b>HT8CBRAB-POP</b>
Illuminated push-pull maintained red pushbutton, 120V full voltage low profile LED, three square legend plates: STOP, EMERG. STOP, OFF	<b>HT8FBRABFL7-POP</b>
Illuminated push-pull maintained red pushbutton, 24V full voltage low profile LED, three square legend plates: STOP, EMERG. STOP, OFF	<b>HT8FBRABFL3-POP</b>
Green flush pushbutton, 1NO/1NC contact block, three square legend plates: START, ON, RUN	<b>HT8AAGAB-POP</b>
Black flush pushbutton, 1NO/1NC contact block, three square legend plates: RESET, JOG, OPEN	<b>HT8AAHAB-POP</b>
Red flush pushbutton, 1NO/1NC contact block, three square legend plates: STOP, CLOSE, OFF	<b>HT8AARAB-POP</b>
Red extended pushbutton, 1NO/1NC contact block, three square legend plates: STOP, CLOSE, OFF	<b>HT8ABRAB-POP</b>
Black extended pushbutton, 1NO/1NC contact block, three square legend plates: RESET, JOG, OPEN	<b>HT8ABHAB-POP</b>
Illuminated green pushbutton, 120V full voltage incandescent, 1NO/1NC contact block, three square legend plates: START, ON, RUN	<b>HT8GBGABV7-POP</b>
Illuminated green pushbutton, 24V full voltage incandescent, 1NO/1NC contact block, three square legend plates: START, ON, RUN	<b>HT8GBGABV3-POP</b>

**Flush Head Operator**



**Extended Head Operator**



**40 mm Mushroom Head Operator**



**Momentary Contact Pushbutton Units, Non-Illuminated**

Contact Type	Button Color	Flush Head Catalog Number	Extended Head Catalog Number	Mushroom Head (40 mm) Catalog Number
No contact	Black	HT8AAH	HT8ABH	HT8AEH
	Red	HT8AAR	HT8ABR	HT8AER
	Green	HT8AAG	HT8ABG	HT8AEG
1NO	Black	HT8AAHA	HT8ABHA	HT8AEHA
	Red	HT8AARA	HT8ABRA	HT8AERA
	Green	HT8AAGA	HT8ABGA	HT8AEGA
1NC	Black	HT8AAHB	HT8ABHB	HT8AEHB
	Red	HT8AARB	HT8ABRB	HT8AERB
	Green	HT8AAGB	HT8ABGB	HT8AEGB
1NO-1NC	Black	HT8AAHAB	HT8ABHAB	HT8AEHAB
	Red	HT8AARAB	HT8ABRAB	HT8AERAB
	Green	HT8AAGAB	HT8ABGAB	HT8AEGAB
2NO-2NC	Black	HT8AAHF1Q1	HT8ABHF1Q1	HT8AEHF1Q1
	Red	HT8AARF1Q1	HT8ABRF1Q1	HT8AERF1Q1
	Green	HT8AAGF1Q1	HT8ABGF1Q1	HT8AEGF1Q1

#### 1

#### Illuminated Pushbutton Units

UL (NEMA) Type 3, 3R, 4, 4X, 12 and 13

- Incandescent or LED
- Full voltage or transformer type
- 24V and 120V

#### Illuminated Pushbutton Operator



#### Illuminated Pushbuttons

Type	Volts	Lens Color	Operator Only Catalog Number	1NO Catalog Number	1NC Catalog Number	1NO-1NC Catalog Number	2NO-2NC Catalog Number
<b>Incandescent Lamp</b>							
Full voltage	120 Vac/Vdc	No lens ①	<b>HT8GBFV</b>	—	—	—	—
		Red	<b>HT8GBRV7</b>	<b>HT8GBRAV7</b>	<b>HT8GBRBV7</b>	<b>HT8GBRABV7</b>	<b>HT8GBRF1Q1V7</b>
		Green	<b>HT8GBGV7</b>	<b>HT8GBGAV7</b>	<b>HT8GBGBV7</b>	<b>HT8GBGABV7</b>	<b>HT8GBGF1Q1V7</b>
		Amber	<b>HT8GBAV7</b>	<b>HT8GBAAV7</b>	<b>HT8GBABV7</b>	<b>HT8GBAABV7</b>	<b>HT8GBAF1Q1V7</b>
		Clear	<b>HT8GBCV7</b>	<b>HT8GBCAV7</b>	<b>HT8GBCBV7</b>	<b>HT8GBCABV7</b>	<b>HT8GBCF1Q1V7</b>
		White	<b>HT8GBWV7</b>	<b>HT8GBWAV7</b>	<b>HT8GBWBV7</b>	<b>HT8GBWABV7</b>	<b>HT8GBWF1Q1V7</b>
		Yellow	<b>HT8GBYV7</b>	<b>HT8GBYAV7</b>	<b>HT8GBYBV7</b>	<b>HT8GBYABV7</b>	<b>HT8GBYF1Q1V7</b>
	Blue	<b>HT8GBBV7</b>	<b>HT8GBBAV7</b>	<b>HT8GBBBV7</b>	<b>HT8GBBABV7</b>	<b>HT8GBBF1Q1V7</b>	
	24 Vac/Vdc	No lens ①	<b>HT8GBFV</b>	—	—	—	—
		Red	<b>HT8GBRV3</b>	<b>HT8GBRAV3</b>	<b>HT8GBRBV3</b>	<b>HT8GBRABV3</b>	<b>HT8GBRF1Q1V3</b>
		Green	<b>HT8GBGV3</b>	<b>HT8GBGAV3</b>	<b>HT8GBGBV3</b>	<b>HT8GBGABV3</b>	<b>HT8GBGF1Q1V3</b>
		Amber	<b>HT8GBAV3</b>	<b>HT8GBAAV3</b>	<b>HT8GBABV3</b>	<b>HT8GBAABV3</b>	<b>HT8GBAF1Q1V3</b>
		Clear	<b>HT8GBCV3</b>	<b>HT8GBCAV3</b>	<b>HT8GBCBV3</b>	<b>HT8GBCABV3</b>	<b>HT8GBCF1Q1V3</b>
		White	<b>HT8GBWV3</b>	<b>HT8GBWAV3</b>	<b>HT8GBWBV3</b>	<b>HT8GBWABV3</b>	<b>HT8GBWF1Q1V3</b>
Yellow		<b>HT8GBYV3</b>	<b>HT8GBYAV3</b>	<b>HT8GBYBV3</b>	<b>HT8GBYABV3</b>	<b>HT8GBYF1Q1V3</b>	
Transformer	120 Vac	No lens ①	<b>HT8GBT1</b>	—	—	—	—
		Red	<b>HT8GBRT1</b>	<b>HT8GBRAT1</b>	<b>HT8GBRBT1</b>	<b>HT8GBRABT1</b>	<b>HT8GBRF1Q1T1</b>
		Green	<b>HT8GBGT1</b>	<b>HT8GBGAT1</b>	<b>HT8GBGBT1</b>	<b>HT8GBGABT1</b>	<b>HT8GBGF1Q1T1</b>
		Amber	<b>HT8GBAT1</b>	<b>HT8GBAAT1</b>	<b>HT8GBABT1</b>	<b>HT8GBAABT1</b>	<b>HT8GBAF1Q1T1</b>
		Clear	<b>HT8GBCT1</b>	<b>HT8GBCAT1</b>	<b>HT8GBCBT1</b>	<b>HT8GBCABT1</b>	<b>HT8GBCF1Q1T1</b>
		White	<b>HT8GBWT1</b>	<b>HT8GBWAT1</b>	<b>HT8GBWBT1</b>	<b>HT8GBWABT1</b>	<b>HT8GBWF1Q1T1</b>
		Yellow	<b>HT8GBYT1</b>	<b>HT8GBYAT1</b>	<b>HT8GBYBT1</b>	<b>HT8GBYABT1</b>	<b>HT8GBYF1Q1T1</b>
Blue	<b>HT8GBBT1</b>	<b>HT8GBBAT1</b>	<b>HT8GBBBT1</b>	<b>HT8GBBABT1</b>	<b>HT8GBBF1Q1T1</b>		

**Note**

① Light unit base operator without lens or bulb.

UL (NEMA) Type 3, 3R, 4, 4X, 12 and 13

**Illuminated Pushbutton Operator**



**Illuminated Pushbuttons, continued**

Type	Volts	Lens Color	Operator Only Catalog Number	1NO Catalog Number	1NC Catalog Number	1NO-1NC Catalog Number	2NO-2NC Catalog Number
<b>LED</b>							
Full voltage	120 Vac/Vdc	No lens ①	<b>HT8GBFV</b>	—	—	—	—
		Red	<b>HT8GBRF7</b>	<b>HT8GBRAF7</b>	<b>HT8GBRBF7</b>	<b>HT8GBRABF7</b>	<b>HT8GBRF1Q1F7</b>
		Green	<b>HT8GBGF7</b>	<b>HT8GBGAF7</b>	<b>HT8GBGBF7</b>	<b>HT8GBGABF7</b>	<b>HT8GBGF1Q1F7</b>
		Amber	<b>HT8GBAF7</b>	<b>HT8GBAAF7</b>	<b>HT8GBABF7</b>	<b>HT8GBAABF7</b>	<b>HT8GBAF1Q1F7</b>
		Clear	<b>HT8GBCF7</b>	<b>HT8GBCAF7</b>	<b>HT8GBCBF7</b>	<b>HT8GBCABF7</b>	<b>HT8GBCF1Q1F7</b>
		White	<b>HT8GBWF7</b>	<b>HT8GBWAF7</b>	<b>HT8GBWBF7</b>	<b>HT8GBWABF7</b>	<b>HT8GBWF1Q1F7</b>
		Yellow	<b>HT8GBYF7</b>	<b>HT8GBYAF7</b>	<b>HT8GBYBF7</b>	<b>HT8GBYABF7</b>	<b>HT8GBYF1Q1F7</b>
	Blue	<b>HT8GBBF7</b>	<b>HT8GBBAF7</b>	<b>HT8GBBBF7</b>	<b>HT8GBBABF7</b>	<b>HT8GBBF1Q1F7</b>	
	24 Vac/Vdc	No lens ①	<b>HT8GBFV</b>	—	—	—	—
		Red	<b>HT8GBRF3</b>	<b>HT8GBRAF3</b>	<b>HT8GBRBF3</b>	<b>HT8GBRABF3</b>	<b>HT8GBRF1Q1F3</b>
		Green	<b>HT8GBGF3</b>	<b>HT8GBGAF3</b>	<b>HT8GBGBF3</b>	<b>HT8GBGABF3</b>	<b>HT8GBGF1Q1F3</b>
		Amber	<b>HT8GBAF3</b>	<b>HT8GBAAF3</b>	<b>HT8GBABF3</b>	<b>HT8GBAABF3</b>	<b>HT8GBAF1Q1F3</b>
		Clear	<b>HT8GBCF3</b>	<b>HT8GBCAF3</b>	<b>HT8GBCBF3</b>	<b>HT8GBCABF3</b>	<b>HT8GBCF1Q1F3</b>
		White	<b>HT8GBWF3</b>	<b>HT8GBWAF3</b>	<b>HT8GBWBF3</b>	<b>HT8GBWABF3</b>	<b>HT8GBWF1Q1F3</b>
Yellow		<b>HT8GBYF3</b>	<b>HT8GBYAF3</b>	<b>HT8GBYBF3</b>	<b>HT8GBYABF3</b>	<b>HT8GBYF1Q1F3</b>	
Blue	<b>HT8GBBF3</b>	<b>HT8GBBAF3</b>	<b>HT8GBBBF3</b>	<b>HT8GBBABF3</b>	<b>HT8GBBF1Q1F3</b>		
Transformer	120 Vac	No lens ①	<b>HT8GBT1</b>	—	—	—	—
		Red	<b>HT8GBRL1</b>	<b>HT8GBRAL1</b>	<b>HT8GBRBL1</b>	<b>HT8GBRABL1</b>	<b>HT8GBRF1Q1L1</b>
		Green	<b>HT8GBGL1</b>	<b>HT8GBGAL1</b>	<b>HT8GBGBL1</b>	<b>HT8GBGABL1</b>	<b>HT8GBGF1Q1L1</b>
		Amber	<b>HT8GBAL1</b>	<b>HT8GBAAL1</b>	<b>HT8GBABL1</b>	<b>HT8GBAABL1</b>	<b>HT8GBAF1Q1L1</b>
		Clear	<b>HT8GBCL1</b>	<b>HT8GBCAL1</b>	<b>HT8GBCBL1</b>	<b>HT8GBCABL1</b>	<b>HT8GBCF1Q1L1</b>
		White	<b>HT8GBWL1</b>	<b>HT8GBWAL1</b>	<b>HT8GBWBL1</b>	<b>HT8GBWABL1</b>	<b>HT8GBWF1Q1L1</b>
		Yellow	<b>HT8GBYL1</b>	<b>HT8GBYAL1</b>	<b>HT8GBYBL1</b>	<b>HT8GBYABL1</b>	<b>HT8GBYF1Q1L1</b>
		Blue	<b>HT8GBBL1</b>	<b>HT8GBBAL1</b>	<b>HT8GBBBL1</b>	<b>HT8GBBABL1</b>	<b>HT8GBBF1Q1L1</b>

**Note**

① Light unit base operator without lens or bulb.

## 1

**Guarded Illuminated Pushbutton Units**

UL (NEMA) Type 3, 3R, 4, 4X, 12 and 13

- Incandescent or LED
- Full voltage or transformer type
- 24V and 120V

**Guarded Illuminated Pushbutton Operator****Guarded Illuminated Pushbuttons**

Type	Volts	Lens Color	Operator Only Catalog Number	1NO Catalog Number	1NC Catalog Number	1NO-1NC Catalog Number	2NO-2NC Catalog Number
<b>Incandescent Lamp</b>							
Full voltage	120 Vac/Vdc	No lens ①	<b>HT8GDFV</b>	—	—	—	—
		Red	<b>HT8GDRV7</b>	<b>HT8GDRAV7</b>	<b>HT8GDRBV7</b>	<b>HT8GDRABV7</b>	<b>HT8GDRF1Q1V7</b>
		Green	<b>HT8GDGV7</b>	<b>HT8GDGAV7</b>	<b>HT8GDGBV7</b>	<b>HT8GDGABV7</b>	<b>HT8GDGF1Q1V7</b>
		Amber	<b>HT8GDAV7</b>	<b>HT8GDAAV7</b>	<b>HT8GDABV7</b>	<b>HT8GDAABV7</b>	<b>HT8GDAF1Q1V7</b>
		Clear	<b>HT8GDCV7</b>	<b>HT8GDVAV7</b>	<b>HT8GDCBV7</b>	<b>HT8GDCABV7</b>	<b>HT8GDCF1Q1V7</b>
		White	<b>HT8GDWV7</b>	<b>HT8GDWAV7</b>	<b>HT8GDWBV7</b>	<b>HT8GDWABV7</b>	<b>HT8GDWF1Q1V7</b>
		Yellow	<b>HT8GDYV7</b>	<b>HT8GDYAV7</b>	<b>HT8GDYBV7</b>	<b>HT8GDYABV7</b>	<b>HT8GDYF1Q1V7</b>
	Blue	<b>HT8GDBV7</b>	<b>HT8GDBAV7</b>	<b>HT8GDBBV7</b>	<b>HT8GDBABV7</b>	<b>HT8GDBF1Q1V7</b>	
	24 Vac/Vdc	No lens ①	<b>HT8GDFV</b>	—	—	—	—
		Red	<b>HT8GDRV3</b>	<b>HT8GDRAV3</b>	<b>HT8GDRBV3</b>	<b>HT8GDRABV3</b>	<b>HT8GDRF1Q1V3</b>
		Green	<b>HT8GDGV3</b>	<b>HT8GDGAV3</b>	<b>HT8GDGBV3</b>	<b>HT8GDGABV3</b>	<b>HT8GDGF1Q1V3</b>
		Amber	<b>HT8GDAV3</b>	<b>HT8GDAAV3</b>	<b>HT8GDABV3</b>	<b>HT8GDAABV3</b>	<b>HT8GDAF1Q1V3</b>
		Clear	<b>HT8GDCV3</b>	<b>HT8GDVAV3</b>	<b>HT8GDCBV3</b>	<b>HT8GDCABV3</b>	<b>HT8GDCF1Q1V3</b>
		White	<b>HT8GDWV3</b>	<b>HT8GDWAV3</b>	<b>HT8GDWBV3</b>	<b>HT8GDWABV3</b>	<b>HT8GDWF1Q1V3</b>
Yellow		<b>HT8GDYV3</b>	<b>HT8GDYAV3</b>	<b>HT8GDYBV3</b>	<b>HT8GDYABV3</b>	<b>HT8GDYF1Q1V3</b>	
Transformer	120 Vac	No lens ①	<b>HT8GDT1</b>	—	—	—	—
		Red	<b>HT8GDRT1</b>	<b>HT8GDRAT1</b>	<b>HT8GDRBT1</b>	<b>HT8GDRABT1</b>	<b>HT8GDRF1Q1T1</b>
		Green	<b>HT8GDGT1</b>	<b>HT8GDGAT1</b>	<b>HT8GDGBT1</b>	<b>HT8GDGABT1</b>	<b>HT8GDGF1Q1T1</b>
		Amber	<b>HT8GDAT1</b>	<b>HT8GDAAT1</b>	<b>HT8GDABT1</b>	<b>HT8GDAABT1</b>	<b>HT8GDAF1Q1T1</b>
		Clear	<b>HT8GDCT1</b>	<b>HT8GDCAT1</b>	<b>HT8GDCBT1</b>	<b>HT8GDCABT1</b>	<b>HT8GDCF1Q1T1</b>
		White	<b>HT8GDWT1</b>	<b>HT8GDWAT1</b>	<b>HT8GDWBT1</b>	<b>HT8GDWABT1</b>	<b>HT8GDWF1Q1T1</b>
		Yellow	<b>HT8GDYT1</b>	<b>HT8GDYAT1</b>	<b>HT8GDYBT1</b>	<b>HT8GDYABT1</b>	<b>HT8GDYF1Q1T1</b>
Blue	<b>HT8GDBT1</b>	<b>HT8GDBAT1</b>	<b>HT8GDBBT1</b>	<b>HT8GDBABT1</b>	<b>HT8GDBF1Q1T1</b>		

**Note**

① Light unit base operator without lens or bulb.

UL (NEMA) Type 3, 3R, 4, 4X, 12 and 13

**Guarded Illuminated Pushbutton Operator**



**Guarded Illuminated Pushbuttons, continued**

Type	Volts	Lens Color	Operator Only Catalog Number	1NO Catalog Number	1NC Catalog Number	1NO-1NC Catalog Number	2NO-2NC Catalog Number
<b>LED</b>							
Full voltage	120 Vac/Vdc	No lens ①	<b>HT8GDFV</b>	—	—	—	—
		Red	<b>HT8GDRF7</b>	<b>HT8GDRAF7</b>	<b>HT8GDRBF7</b>	<b>HT8GDRABF7</b>	<b>HT8GDRF1Q1F7</b>
		Green	<b>HT8GDGF7</b>	<b>HT8GDGAF7</b>	<b>HT8GDGBF7</b>	<b>HT8GDGABF7</b>	<b>HT8GDGF1Q1F7</b>
		Amber	<b>HT8GDAF7</b>	<b>HT8GDAAF7</b>	<b>HT8GDABF7</b>	<b>HT8GDAABF7</b>	<b>HT8GDAF1Q1F7</b>
		Clear	<b>HT8GDCF7</b>	<b>HT8GDCAF7</b>	<b>HT8GDCBF7</b>	<b>HT8GDCABF7</b>	<b>HT8GDCF1Q1F7</b>
		White	<b>HT8GDWF7</b>	<b>HT8GDWAF7</b>	<b>HT8GDWBF7</b>	<b>HT8GDWABF7</b>	<b>HT8GDWF1Q1F7</b>
		Yellow	<b>HT8GDYF7</b>	<b>HT8GDYAF7</b>	<b>HT8GDYBF7</b>	<b>HT8GDYABF7</b>	<b>HT8GDYF1Q1F7</b>
		Blue	<b>HT8GDBF7</b>	<b>HT8GDBAF7</b>	<b>HT8GDBBF7</b>	<b>HT8GDBABF7</b>	<b>HT8GDBF1Q1F7</b>
	24 Vac/Vdc	No lens ①	<b>HT8GDFV</b>	—	—	—	—
		Red	<b>HT8GDRF3</b>	<b>HT8GDRAF3</b>	<b>HT8GDRBF3</b>	<b>HT8GDRABF3</b>	<b>HT8GDRF1Q1F3</b>
		Green	<b>HT8GDGF3</b>	<b>HT8GDGAF3</b>	<b>HT8GDGBF3</b>	<b>HT8GDGABF3</b>	<b>HT8GDGF1Q1F3</b>
		Amber	<b>HT8GDAF3</b>	<b>HT8GDAAF3</b>	<b>HT8GDABF3</b>	<b>HT8GDAABF3</b>	<b>HT8GDAF1Q1F3</b>
		Clear	<b>HT8GDCF3</b>	<b>HT8GDCAF3</b>	<b>HT8GDCBF3</b>	<b>HT8GDCABF3</b>	<b>HT8GDCF1Q1F3</b>
		White	<b>HT8GDWF3</b>	<b>HT8GDWAF3</b>	<b>HT8GDWBF3</b>	<b>HT8GDWABF3</b>	<b>HT8GDWF1Q1F3</b>
		Yellow	<b>HT8GDYF3</b>	<b>HT8GDYAF3</b>	<b>HT8GDYBF3</b>	<b>HT8GDYABF3</b>	<b>HT8GDYF1Q1F3</b>
Blue		<b>HT8GDBF3</b>	<b>HT8GDBAF3</b>	<b>HT8GDBBF3</b>	<b>HT8GDBABF3</b>	<b>HT8GDBF1Q1F3</b>	
Transformer	120 Vac	No lens ①	<b>HT8GDT1</b>	—	—	—	—
		Red	<b>HT8GDRL1</b>	<b>HT8GDRAL1</b>	<b>HT8GDRBL1</b>	<b>HT8GDRABL1</b>	<b>HT8GDRF1Q1L1</b>
		Green	<b>HT8GDGL1</b>	<b>HT8GDGAL1</b>	<b>HT8GDGBL1</b>	<b>HT8GDGABL1</b>	<b>HT8GDGF1Q1L1</b>
		Amber	<b>HT8GDAL1</b>	<b>HT8GDAAL1</b>	<b>HT8GDABL1</b>	<b>HT8GDAABL1</b>	<b>HT8GDAF1Q1L1</b>
		Clear	<b>HT8GDCL1</b>	<b>HT8GDCAL1</b>	<b>HT8GDCBL1</b>	<b>HT8GDCABL1</b>	<b>HT8GDCF1Q1L1</b>
		White	<b>HT8GDWL1</b>	<b>HT8GDWAL1</b>	<b>HT8GDWBL1</b>	<b>HT8GDWABL1</b>	<b>HT8GDWF1Q1L1</b>
		Yellow	<b>HT8GDYL1</b>	<b>HT8GDYAL1</b>	<b>HT8GDYBL1</b>	<b>HT8GDYABL1</b>	<b>HT8GDYF1Q1L1</b>
		Blue	<b>HT8GDBL1</b>	<b>HT8GDBAL1</b>	<b>HT8GDBBL1</b>	<b>HT8GDBABL1</b>	<b>HT8GDBF1Q1L1</b>

**Note**

① Light unit base operator without lens or bulb.

#### 1

#### Indicating Light Units

UL (NEMA) Type 3, 3R, 4, 4X, 12 and 13

- Incandescent or LED
- Full voltage or transformer type
- Standard and PresTest types
- 24V and 120V

PresTest—This device incorporates a press-to-test feature whereby depressing the lens disconnects the light from the source

being monitored and connects the lamp to a continuously energized circuit for immediate detection of faulty lamps.

Indicating Light Unit



PresTest Light Unit



#### Indicating Light Units

Type	Volts	Lens Color	Indicating Light Catalog Number	PresTest Catalog Number
<b>Incandescent</b>				
Full voltage	120 Vac/Vdc	No lens ①	<b>HT8HFFV</b>	<b>HT8GTFV</b>
		Red	<b>HT8HFRV7</b>	<b>HT8GTRV7</b>
		Green	<b>HT8HFGV7</b>	<b>HT8GTGV7</b>
		Amber	<b>HT8HFAV7</b>	<b>HT8GTAV7</b>
		Clear	<b>HT8HFCV7</b>	<b>HT8GTCV7</b>
		White	<b>HT8HFVV7</b>	<b>HT8GTWV7</b>
		Yellow	<b>HT8HFVY7</b>	<b>HT8GTYV7</b>
	24 Vac/Vdc	No lens ①	<b>HT8HFFV</b>	<b>HT8GTFV</b>
		Red	<b>HT8HFRV3</b>	<b>HT8GTRV3</b>
		Green	<b>HT8HFGV3</b>	<b>HT8GTGV3</b>
		Amber	<b>HT8HFAV3</b>	<b>HT8GTAV3</b>
		Clear	<b>HT8HFCV3</b>	<b>HT8GTCV3</b>
		White	<b>HT8HFVV3</b>	<b>HT8GTWV3</b>
		Yellow	<b>HT8HFVY3</b>	<b>HT8GTYV3</b>
Transformer	120 Vac 50/60 Hz	No lens ①	<b>HT8HBT1</b>	<b>HT8GTT1</b>
		Red	<b>HT8HBRT1</b>	<b>HT8GTRT1</b>
		Green	<b>HT8HBGT1</b>	<b>HT8GTGT1</b>
		Amber	<b>HT8HBAT1</b>	<b>HT8GTAT1</b>
		Clear	<b>HT8HBCT1</b>	<b>HT8GTCT1</b>
		White	<b>HT8HBWT1</b>	<b>HT8GTWT1</b>
		Yellow	<b>HT8HBYT1</b>	<b>HT8GTYT1</b>
	Blue	<b>HT8HBBT1</b>	<b>HT8GTBT1</b>	

**Note**

① Light unit base operator without lens or bulb.

UL (NEMA) Type 3, 3R, 4, 4X, 12 and 13

**Indicating Light Unit**



**Indicating Light Units, continued**

**PresTest Light Unit**



Type	Volts	Lens Color	Indicating Light Catalog Number	PresTest Catalog Number
<b>LED</b>				
Full voltage	120 Vac/Vdc	No lens ①	<b>HT8HFFV</b>	<b>HT8GTFV</b>
		Red	<b>HT8HFRF7</b>	<b>HT8GTRF7</b>
		Green	<b>HT8HFGF7</b>	<b>HT8GTGF7</b>
		Amber	<b>HT8HFAF7</b>	<b>HT8GTAF7</b>
		Clear	<b>HT8HFCF7</b>	<b>HT8GTCF7</b>
		White	<b>HT8HFWF7</b>	<b>HT8GTWF7</b>
		Yellow	<b>HT8HFVF7</b>	<b>HT8GTVF7</b>
		Blue	<b>HT8HBF7</b>	<b>HT8GTBF7</b>
	24 Vac/Vdc	No lens ①	<b>HT8HFFV</b>	<b>HT8GTFV</b>
		Red	<b>HT8HFRF3</b>	<b>HT8GTRF3</b>
		Green	<b>HT8HFGF3</b>	<b>HT8GTGF3</b>
		Amber	<b>HT8HFAF3</b>	<b>HT8GTAF3</b>
		Clear	<b>HT8HFCF3</b>	<b>HT8GTCF3</b>
		White	<b>HT8HFWF3</b>	<b>HT8GTWF3</b>
		Yellow	<b>HT8HFVF3</b>	<b>HT8GTVF3</b>
		Blue	<b>HT8HBF3</b>	<b>HT8GTBF3</b>
Transformer	120 Vac 50/60 Hz	No lens ①	<b>HT8HBT1</b>	<b>HT8GTT1</b>
		Red	<b>HT8HBRL1</b>	<b>HT8GTRL1</b>
		Green	<b>HT8HBGL1</b>	<b>HT8GTGL1</b>
		Amber	<b>HT8HBAL1</b>	<b>HT8GTAL1</b>
		Clear	<b>HT8HBCL1</b>	<b>HT8GTCL1</b>
		White	<b>HT8HBWL1</b>	<b>HT8GTWL1</b>
		Yellow	<b>HT8HBYL1</b>	<b>HT8GTYL1</b>
		Blue	<b>HT8HBBL1</b>	<b>HT8GTBL1</b>

**Note**

① Light unit base operator without lens or bulb.



#### 1

#### Push-Pull Units

UL (NEMA) Type 3, 3R, 4, 4X, 12 and 13

- 40 mm mushroom head
- Two-position maintained
- Non-illuminated

#### Round Head Two-Position Push-Pull Unit



#### Flat Head Two-Position Push-Pull Unit



#### Two-Position Push-Pull, Maintained, Non-Illuminated

Contact Type	Operator Position—Maintained		Button Color	Round Head Mushroom Head Button Catalog Number	Flat Head Mushroom Head Button Catalog Number
	Out	In			
No contact	—	—	Black	<b>HT8CBH</b>	<b>HT8DBH</b>
			Red	<b>HT8CBR</b>	<b>HT8DBR</b>
			Green	<b>HT8CBG</b>	<b>HT8DBG</b>
NO	0	X	Black	<b>HT8CBHA</b>	<b>HT8DBHA</b>
			Red	<b>HT8CBRA</b>	<b>HT8DBRA</b>
			Green	<b>HT8CBGA</b>	<b>HT8DBGA</b>
NC	X	0	Black	<b>HT8CBHB</b>	<b>HT8DBHB</b>
			Red	<b>HT8CBRB</b>	<b>HT8DBRB</b>
			Green	<b>HT8CBGB</b>	<b>HT8DBGB</b>
NO-NC	0	X	Black	<b>HT8CBHAB</b>	<b>HT8DBHAB</b>
	X	0	Red	<b>HT8CBRAB</b>	<b>HT8DBRAB</b>
			Green	<b>HT8CBGAB</b>	<b>HT8DBGAB</b>
NCLB <sup>Ⓢ</sup>	X	0	Black	<b>HT8CBHD1B</b>	<b>HT8DBHD1B</b>
NC	X	0	Red	<b>HT8CBRD1B</b>	<b>HT8DBRD1B</b>
			Green	<b>HT8CBGD1B</b>	<b>HT8DBGD1B</b>
NCLB <sup>Ⓢ</sup>	X	0	Black	<b>HT8CBHD1D</b>	<b>HT8DBHD1D</b>
NCLB <sup>Ⓢ</sup>	X	0	Red	<b>HT8CBRD1D</b>	<b>HT8DBRD1D</b>
			Green	<b>HT8CBGD1D</b>	<b>HT8DBGD1D</b>

**Note**

<sup>Ⓢ</sup> NCLB = normally closed late break.

**Illuminated Push-Pull Units**

UL (NEMA) Type 3, 3R, 4, 4X, 12 and 13

- Incandescent or LED
- Full voltage or transformer type
- 24V and 120V

**Illuminated Push-Pull Unit**



**Illuminated Push-Pull Units**

Type	Volts	Lens Color	Operator Only Catalog Number	1NO Catalog Number	1NC Catalog Number	1NO-1NC Catalog Number	2NCLB Catalog Number
<b>Incandescent Lamp</b>							
Full voltage	120 Vac/Vdc	Red	HT8FBRV7	HT8FBRAV7	HT8FBRBV7	HT8FBRAV7	HT8FBRD1DV7
		Green	HT8FBGV7	HT8FBGAV7	HT8FBGBV7	HT8FBGAV7	HT8FBGD1DV7
	24 Vac/Vdc	Red	HT8FBRV3	HT8FBRAV3	HT8FBRBV3	HT8FBRAV3	HT8FBRD1DV3
		Green	HT8FBGV3	HT8FBGAV3	HT8FBGBV3	HT8FBGAV3	HT8FBGD1DV3
Transformer	120 Vac	Red	HT8FBRT1	HT8FBRA1	HT8FBRBT1	HT8FBRA1	HT8FBRD1DT1
		Green	HT8FBGT1	HT8FBGA1	HT8FBGBT1	HT8FBGA1	HT8FBGD1DT1
<b>LED Lamp</b>							
Full voltage	120 Vac/Vdc	Red	HT8FBRF7	HT8FBRAF7	HT8FBRBF7	HT8FBRAF7	HT8FBRD1DF7
		Green	HT8FBGF7	HT8FBGAF7	HT8FBGBF7	HT8FBGAF7	HT8FBGD1DF7
	24 Vac/Vdc	Red	HT8FBRF3	HT8FBRAF3	HT8FBRBF3	HT8FBRAF3	HT8FBRD1DF3
		Green	HT8FBGF3	HT8FBGAF3	HT8FBGBF3	HT8FBGAF3	HT8FBGD1DF3
Transformer	120 Vac	Red	HT8FBRL1	HT8FBRAL1	HT8FBRBL1	HT8FBRAL1	HT8FBRD1DL1
		Green	HT8FBGL1	HT8FBGAL1	HT8FBGBL1	HT8FBGAL1	HT8FBGD1DL1

**Note:** Complete illuminated push-pull switches will not fit in a standard 3 in deep enclosure.

**Illuminated Push-Pull Units with Low Profile Light Units**

Type	Voltage	Color	Fingersafe	Operator Only Catalog Number	1NO Catalog Number	1NC Catalog Number	1NO-1NC Catalog Number	2NCLB Catalog Number	1NO-1NCLB Catalog Number
<b>LED Lamp</b>									
Full voltage	120 Vac/Vdc	Red	Yes	HT8FBRFL7P	HT8FBRAF7P	HT8FBRBF7P	HT8FBRAF7P	HT8FBRD1DF7P	HT8FBRD1BFL7P
		Red	No	HT8FBRFL7	HT8FBRAF7	HT8FBRBF7	HT8FBRAF7	HT8FBRD1DF7	HT8FBRD1BFL7
	24 Vac/Vdc	Red	Yes	HT8FBRFL3P	HT8FBRAF3P	HT8FBRBF3P	HT8FBRAF3P	HT8FBRD1DF3P	HT8FBRD1BFL3P
		Red	No	HT8FBRFL3	HT8FBRAF3	HT8FBRBF3	HT8FBRAF3	HT8FBRD1DF3	HT8FBRD1BFL3
<b>Incandescent</b>									
Full voltage	120 Vac/Vdc	Red	Yes	HT8FBRVL7P	HT8FBRAVL7P	HT8FBRBV7P	HT8FBRAVL7P	HT8FBRD1DV7P	HT8FBRD1BVL7P
		Red	No	HT8FBRVL7	HT8FBRAVL7	HT8FBRBV7	HT8FBRAVL7	HT8FBRD1DV7	HT8FBRD1BVL7
	24 Vac/Vdc	Red	Yes	HT8FBRVL3P	HT8FBRAVL3P	HT8FBRBV3P	HT8FBRAVL3P	HT8FBRD1DV3P	HT8FBRD1BVL3P
		Red	No	HT8FBRVL3	HT8FBRAVL3	HT8FBRBV3	HT8FBRAVL3	HT8FBRD1DV3	HT8FBRD1BVL3

# 1

## Selector Switch Units

UL (NEMA) Type 3, 3R, 4, 4X, 12 and 13

- Two-, three- and four-position
- Non-illuminated

### Standard Knob Operator



### Standard Lever Operator



### Two-Position Selector Switch Units, Non-Illuminated

Contact Type	Operator Position <sup>①</sup>		Operating Mode <sup>②</sup>		Standard Black Knob Catalog Number	Standard Black Lever Catalog Number
No contacts	—	—	M	M	HT8JAH3A	HT8JDH3A
			S	M	HT8JKH3A	HT8JLH3A
			M	S	HT8JNH3A	HT8JPH3A
1NO	0	X	M	M	HT8JAH3AA5	HT8JDH3AA5
			S	M	HT8JKH3AA5	HT8JLH3AA5
			M	S	HT8JNH3AA5	HT8JPH3AA5
2NO	X 0	0 X	M	M	HT8JAH3AAA5	HT8JDH3AAA5
			S	M	HT8JKH3AAA5	HT8JLH3AAA5
			M	S	HT8JNH3AAA5	HT8JPH3AAA5
2NO-2NC	X 0 0 X	0 X X 0	M	M	HT8JAH3AF1Q1	HT8JDH3AF1Q1
			S	M	HT8JKH3AF1Q1	HT8JLH3AF1Q1
			M	S	HT8JNH3AF1Q1	HT8JPH3AF1Q1

### Standard Knob Operator



### Standard Lever Operator



### Three-Position Selector Switch Units, Non-Illuminated

Contact Type	Operator Position <sup>①</sup>			Operating Mode <sup>②</sup>			Standard Black Knob Catalog Number	Standard Black Lever Catalog Number
No contacts	—	—	—	M	M	M	HT8JBH1D	HT8JEH1D
				S	M	M	HT8JRH1D	HT8JSH1D
				M	M	S	HT8JUH1D	HT8JVH1D
				S	M	S	HT8JXH1D	HT8JYH1D
2NO	X 0	0 0	0 X	M	M	M	HT8JBH1DAA5	HT8JEH1DAA5
				S	M	M	HT8JRH1DAA5	HT8JSH1DAA5
				M	M	S	HT8JUH1DAA5	HT8JVH1DAA5
				S	M	S	HT8JXH1DAA5	HT8JYH1DAA5
2NO-2NC <sup>③</sup>	X 0 0	0 X 0	0 0 X	M	M	M	HT8JBH1DF1Q1	HT8JEH1DF1Q1
				S	M	M	HT8JRH1DF1Q1	HT8JSH1DF1Q1
				M	M	S	HT8JUH1DF1Q1	HT8JVH1DF1Q1
				S	M	S	HT8JXH1DF1Q1	HT8JYH1DF1Q1
2NO-2NC	X 0 0 X	0 X 0 X	X X X 0	M	M	M	HT8JBH1DF1Q1	HT8JEH1DF1Q1
				S	M	M	HT8JRH1DF1Q1	HT8JSH1DF1Q1
				M	M	S	HT8JUH1DF1Q1	HT8JVH1DF1Q1
				S	M	S	HT8JXH1DF1Q1	HT8JYH1DF1Q1

#### Notes

① X = closed circuit, 0 = open circuit.

② M = Maintained, S = Momentary.

③ For OX0, NC contacts must be wired in series—see Three-Position Selector Switch table on Page V7-T1-320.

UL (NEMA) Type 3, 3R, 4, 4X, 12 and 13

Standard Knob Operator



Four-Position Selector Switch Units, Non-Illuminated

Standard Lever Operator



Contact Type	Operator Position <sup>①</sup>				Operating Mode <sup>②</sup>				Standard Black Knob Catalog Number	Standard Black Lever Catalog Number
No contacts	—	—	—	—	M	M	M	M	HT8JCH8E	HT8JFH8E
					S	M	M	M	HT8LNH8E	HT8LPH8E
					M	M	M	S	HT8LRH8E	HT8LSH8E
2NO-2NC	X	0	0	0	M	M	M	M	HT8JCH8EF1Q1	HT8JFH8EF1Q1
	0	X	0	0	S	M	M	M	HT8LNH8EF1Q1	HT8LPH8EF1Q1
	0	0	X	0	S	M	M	M	HT8LNH8EF1Q1	HT8LPH8EF1Q1
	0	0	0	X	M	M	M	S	HT8LRH8EF1Q1	HT8LSH8EF1Q1

Notes

- ① X = closed circuit, 0 = open circuit.
- ② M = Maintained, S = Momentary.







#### 1

### Selector Switch Contact Block Selection

#### For Two-, Three- and Four-Position Selector Switches









#### Two-Position Selector Switch (Cam Code 3A)

##### Operator Position

			Left	or	Right
X	0		 NO		 NC
0		X	 NC		 NO









#### Three-Position Selector Switch (Cam Code 1D)

##### Operator Position

				Left	Right
X	0	0		 NO	—
0		X	0	 NC	 NC
0	0	0	X	—	 NO
0		X	X	 NC	—
X		X	0	—	 NC









#### Four-Position Selector Switch (Cam Code 8E)

##### Operator Position

					Left	Right
X	0	0	0		 NO	—
0		X	0	0	 NC	—
0	0	0	X	0	—	 NO
0	0	0	0	X	—	 NC

**Accessories**

**HT800 Accessories**

	Description	Catalog Number
 <p>HT8A15</p>	<b>Illuminated Pushbutton Guard</b>	HT8A15
 <p>HT8WRENCH</p>	<b>Wrench Tool</b>	HT8WRENCH
 <p>HT8LAMPTOOL</p>	<b>Lamp/Bulb Removal Tool</b>	HT8LAMPTOOL
 <p>HT8X1</p>	<b>Thrust Washer (Anti-rotation)</b> (Included with every operator)	HT8X1
 <p>HT8X2</p>	<b>Trim Ring</b> (Included with every operator)	HT8X2
 <p>HT8X3</p>	<b>Sealing/Spacer Washer</b> (Five included with every operator)	HT8X3
 <p>HT8GR1</p>	<b>Grounding Kit for Pushbuttons and Selector Switches</b> (Included with every operator)	HT8GR1
 <p>HT8GR2</p>	<b>Grounding Kit for Indicating Lights</b> (Included with indicating lights)	HT8GR2

**Light Units**

Light Unit	Type	Voltage	Catalog Number
	Full voltage	24 Vac/Vdc	HT8F3V3
		120 Vac/Vdc	HT8F7V8
	Transformer	120 Vac	HT8L1T1

## Options

### Legend Plates ①

#### Standard

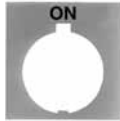

#### Jumbo



### For Pushbutton Operators and Indicating Lights

Legend	Color of Field	Standard Catalog Number	Jumbo Catalog Number	Legend	Color of Field	Standard Catalog Number	Jumbo Catalog Number
<b>Letters on Legend Plates Below are 3/16 in High</b>							
CLAMP	Black	HT8SP90	HT8LP90	OFF	Red	HT8SP24	HT8LP24
CLOSE		HT8SP73	HT8LP73	ON	Black	HT8SP25	HT8LP25
DOWN		HT8SP74	HT8LP74	OPEN		HT8SP26	HT8LP26
EMERG. STOP		HT8SP13	HT8LP13	OUT		HT8SP27	HT8LP27
FAST		HT8SP75	HT8LP75	POWER ON		HT8SP80	HT8LP80
FASTER		HT8SP87	HT8LP87	RAISE		HT8SP28	HT8LP28
FEEDER ON		HT8SP94	HT8LP94	READY		HT8SP86	HT8LP86
FEEDER OFF		HT8SP95	HT8LP95	RESET		HT8SP29	HT8LP29
FORWARD		HT8SP15	HT8LP15	REVERSE		HT8SP30	HT8LP30
HIGH		HT8SP16	HT8LP16	RUN		HT8SP31	HT8LP31
IN		HT8SP17	HT8LP17	SAFE		HT8SP85	HT8LP85
INCH		HT8SP18	HT8LP18	SLOW		HT8SP32	HT8LP32
JOG		HT8SP19	HT8LP19	SLOWER		HT8SP88	HT8LP88
JOG FOR.		HT8SP20	HT8LP20	START		HT8SP33	HT8LP33
JOG REV.		HT8SP21	HT8LP21	STOP	Red	HT8SP34	HT8LP34
LOW		HT8SP22	HT8LP22	TEST	Black	HT8SP83	HT8LP83
LOWER		HT8SP23	HT8LP23	TRANSFER		HT8SP93	HT8LP93
LUBE-FAIL		HT8SP92	HT8LP92	TRIP		HT8SP84	HT8LP84
MOTOR RUN		HT8SP81	HT8LP81	UNCLAMP		HT8SP91	HT8LP91
MOTOR STOP		HT8SP82	HT8LP82	UP		HT8SP35	HT8LP35

#### Standard

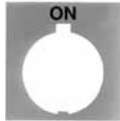

#### Jumbo



### For Selector Switch Operators

Legend	Color of Field	Standard Catalog Number	Jumbo Catalog Number	Legend	Color of Field	Standard Catalog Number	Jumbo Catalog Number
<b>Two-Position—3/16 in High Lettering</b>				<b>Three-Position—3/16 in High Lettering</b>			
FOR. REV.	Black	HT8SP38	HT8LP38	AUTO OFF HAND	Black	HT8SP49	HT8LP49
HAND AUTO		HT8SP39	HT8LP39	FOR. OFF REV.		HT8SP50	HT8LP50
HIGH LOW		HT8SP40	HT8LP40	FOR. SAFE REV.		HT8SP69	HT8LP69
JOG RUN		HT8SP41	HT8LP41	HAND OFF AUTO		HT8SP51	HT8LP51
MAN. AUTO		HT8SP67	HT8LP67	MAN. OFF AUTO		HT8SP68	HT8LP68
OFF ON		HT8SP42	HT8LP42	OPEN OFF CLOSE		HT8SP53	HT8LP53
OPEN CLOSE		HT8SP43	HT8LP43	RUN SAFE JOG		HT8SP70	HT8LP70
RUN JOG		HT8SP44	HT8LP44	UP OFF DOWN		HT8SP54	HT8LP54
SAFE RUN		HT8SP45	HT8LP45	ON STOP SAFE		HT8SP71	HT8LP71
START JOG		HT8SP46	HT8LP46				
START STOP		HT8SP47	HT8LP47				
UP DOWN		HT8SP48	HT8LP48				

### For Push-Pull Units

Legend	Color of Field	Standard ② Catalog Number	Jumbo ③ Catalog Number
ON/OFF	Black	HT8PP5	HT8R5
OPEN/CLOSE		HT8PP8	HT8R8
UP/DOWN		HT8PP11	HT8R11

### Blank Plastic Legend Plates—Square

Legend	Color of Field	Standard Catalog Number	Jumbo Catalog Number
Black	White/Silver	HT8SP76	HT8LP76
White	Red/Black	HT8SP77	HT8LP77

#### Notes

① For dimensions, see Page V7-T1-330.

② 3/32 in high lettering.

③ 1/8 in high lettering.

**Legend Plates with Non-Standard Markings**

**When Ordering Specify**

- Catalog number of blank plate.
- Insert the following into Order Notes: legend, letter size and locations. See information below.

**Ordering Example:**

Catalog no.: **HT85P76STAMP**  
 Letter size: 3/32 in (2.4 mm)  
 Pos. A—POWER HOUSE  
 Pos. B—START PUMP 1

**Legend Characters Available**

A B C D E F G H I J K L M N O  
 P Q R S T U V W X Y Z / - . , 1  
 2 3 4 5 6 7 8 9 0

**Legend Positions**

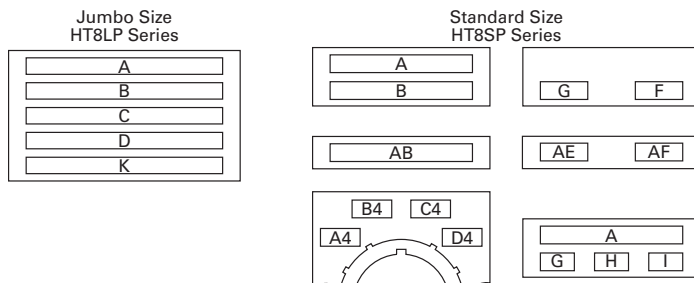

**Blank Plastic Legend Plates for Non-Standard Markings—Plastic**

Legend	Color of Field	Standard Catalog Number	Jumbo Catalog Number
Black	White/Silver	HT8SP76STAMP	HT8LP76STAMP
White	Red/Black	HT8SP77STAMP	HT8LP77STAMP

**Maximum Characters per Legend Plate and Approximate Dimensions**

Top (Aluminum and Plastic)	Style	Character Size		1/8 in High		3/16 in High	
		3/32 in High	Number of Characters	Number of Lines	Number of Characters	Number of Lines	Number of Characters
Standard	Square	2	18	2	13	1	9
Jumbo ①	Square	5	23	3	18	2	12

**Note**

① Can be used on top row only of any enclosure.



# 1

## Contact Blocks

### NO Contact Block



### NC Contact Block



### Contact Blocks <sup>①②</sup>

Description/Function	Contact Type	Without Guard Catalog Number	Fingerproof Catalog Number
Standard normally open contact	NO	<b>HT8A</b>	<b>HT8AP</b>
Standard normally closed contact	NC	<b>HT8B</b>	<b>HT8BP</b>
Normally open early make contact will make circuit before standard NO contact. DC ratings do not apply.	NOEM	<b>HT8C</b>	<b>HT8CP</b>
Normally closed late break contact will open after standard NC contact. DC ratings do not apply.	NCLB	<b>HT8D</b>	<b>HT8DP</b>
Logic level, low voltage NO contact. Gold plated contacts.	NO	<b>HT8E</b>	<b>HT8EP</b>

### Contact Block Location (Viewed from Rear)

#### Suffix Codes <sup>③④</sup>



Left Side	Right Side
<b>A</b> = NO	<b>A5</b> = NO
<b>A2</b> = 2NO	<b>A6</b> = 2NO
<b>B1</b> = NC	<b>B</b> = NC
<b>B2</b> = 2NC	<b>B6</b> = 2NC
<b>C</b> = NOEM	<b>C5</b> = NOEM
<b>C2</b> = 2 NOEM	<b>C6</b> = 2 NOEM
<b>D1</b> = NCLB	<b>D</b> = NCLB
<b>D2</b> = 2 NCLB	<b>D6</b> = 2 NCLB
<b>E1</b> = NOEM-NCLB	<b>E5</b> = NOEM-NCLB
<b>F1</b> = NO and NC	<b>Q1</b> = NO and NC
<b>F4</b> = 1NO-1NC	

#### Notes

- ① See **Page V7-T1-326** for contact block electrical ratings.
- ② Maximum of four contact blocks per side or a total of eight contact blocks recommended.
- ③ Maximum of two contact blocks per side or a total of four contact blocks recommended.
- ④ Standard contact blocks without fingerproof protection.

Replacement Parts

Replacement Bulbs and LEDs

	Voltage	Color	Catalog Number
<b>Incandescent Bulb</b> 	<b>Incandescent</b>		
	6V	—	HT8BULBV1
	24V	—	HT8BULBV3
	120V	—	HT8BULBV7
<b>LED Bulb</b> 	<b>LED</b>		
	6–12V (For use with transformers with 6V secondary winding)	Red	HT8LEDRF1
		Green	HT8LEDGF1
		Amber/orange	HT8LEDAF1
		White/clear	HT8LEDWF1
		Yellow	HT8LEDYF1
		Blue	HT8LEDBF1
	24V	Red	HT8LEDRF3
		Green	HT8LEDGF3
		Amber/orange	HT8LEDAF3
		White/clear	HT8LEDWF3
		Yellow	HT8LEDYF3
		Blue	HT8LEDBF3
	120V	Red	HT8LEDRF7
		Green	HT8LEDGF7
		Amber/orange	HT8LEDAF7
		White/clear	HT8LEDWF7
		Yellow	HT8LEDYF7
		Blue	HT8LEDBF7

Replacement Lenses

Color	Indicating Lights Catalog Number	PresTest Lights Illuminated Pushbuttons Catalog Number
Amber	HT8LA	HT8BA
Blue	HT8LB	HT8BB
Clear	HT8LC	HT8BC
Green	HT8LG	HT8BG
Red	HT8LR	HT8BR
White	HT8LW	HT8BW
Yellow	HT8LY	HT8BY

## Technical Data and Specifications

### HT800—Specifications

Description	Specification
<b>Mechanical Ratings</b>	
Frequency of operation	
Pushbuttons	6,000 operations per hour
Selector switches	3,000 operations per hour
Push-pull operators	3,000 operations per hour
Mechanical endurance/life	
Pushbuttons	10 x 10 <sup>6</sup> operations 6K ops/hr with 6 NO on left and 6 NC on right
Selector switches	250 x 10 <sup>3</sup> operations 3K ops/hr with 2 NO on left and 2 NC on right
Push-pull operators	250 x 10 <sup>3</sup> operations 3K ops/hr with 6 NO on left and 6 NC on right
<b>Climatic Conditions</b>	
Operating temperature	10° to 140°F (–12° to 60°C)
Storage temperature	–40° to 176°F (–40° to 80°C)
Altitude	6,562 ft (2,000m)
Humidity	95% RH at 60°C
<b>Terminals</b>	
Contact blocks	#6-32 posidrive saddle clamp type, 1 x 16 AWG to 2 x 14 AWG, 12 in-lbs max.
Light units	#6-32 posidrive saddle clamp type, 1 x 22 AWG to 2 x 14 AWG, 7 in-lbs max.
<b>Electrical Ratings</b>	
Standard contact blocks UL (NEMA) rating	See table below.
Logic level contact block power rating	5V 1 mA (minimum) 28V 500 mA (maximum)

### Electrical Ratings—HT800 Standard Contact Blocks, UL Rating

Description/Function	Contact Type	AC	DC	Catalog Number
Standard normally open contact	NO	A600 ①	P600 ②	<b>HT8A</b>
Standard normally closed contact	NC	A600 ①	P600 ②	<b>HT8B</b>
Normally open early make contact will make circuit before standard NO contact. DC ratings do not apply.	NOEM	A600 ①	—	<b>HT8C</b>
Normally closed late break contact will open after standard NC contact. DC ratings do not apply.	NCLB	A600 ①	—	<b>HT8D</b>
Logic level, low voltage NO contact. Gold plated contacts.	NO	5V 1 mA (minimum) 28V 500 mA (maximum)		<b>HT8E</b>

### UL A600 and P600 Ratings

Description	50 Vac or 60 Hz				Vdc ③		
	120	240	480	600	125	250	600
Make and emerg. interrupting capacity (amp)	60	30	15	12	1.1	0.55	0.2
Normal load break (amp)	6	3	1.5	1.2	1.1	0.55	0.2
Thermal current (amp)	10	10	10	10	5	5	5
Voltamperes:							
Make and emerg. interrupting capacity	7200	7200	7200	7200	138 ④	138 ④	138 ④
Normal load break	720	720	720	720	138	138	138

#### Notes

- ① Heavy-duty.
- ② Standard-duty.
- ③ DC ratings do not apply to NOEM (Normally Open Early Make) and NCLB (Normal Closed Late Break) contact blocks HT8C and HT8D.
- ④ Maximum make or break volt-amperes at 300V or less.

### Dimensions

Approximate Dimensions in Inches (mm)

#### Momentary Pushbuttons—Non-Illuminated

Back, side and bottom views of pushbutton operator with attached contact blocks.

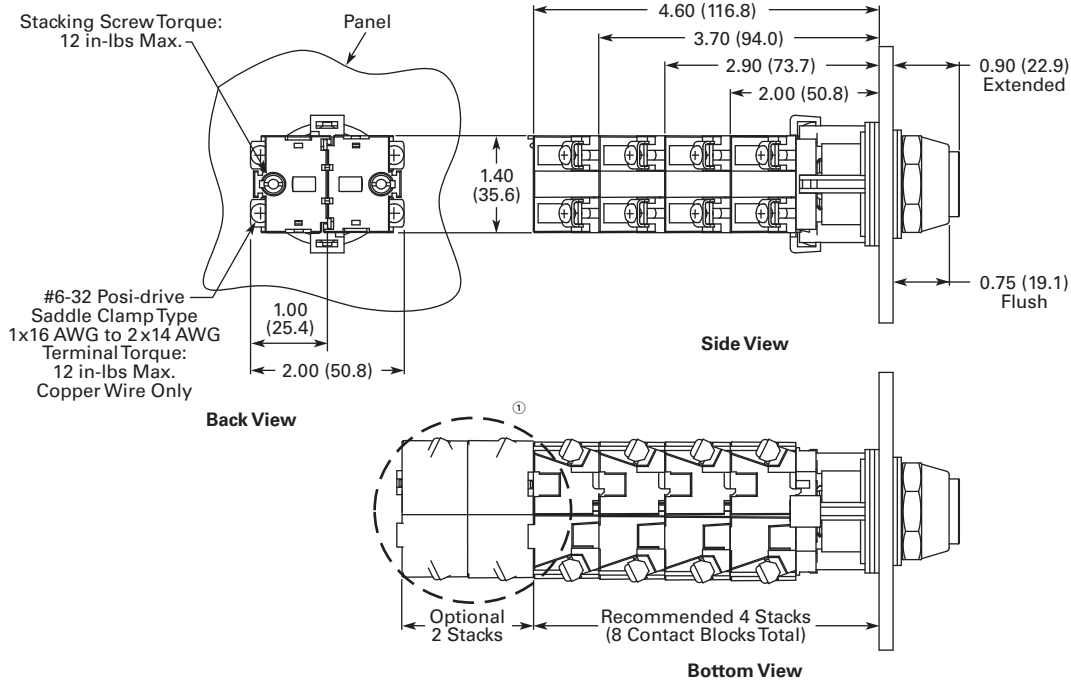

#### Illuminated Pushbuttons

Back, side and bottom views of pushbutton operator with attached contact blocks.

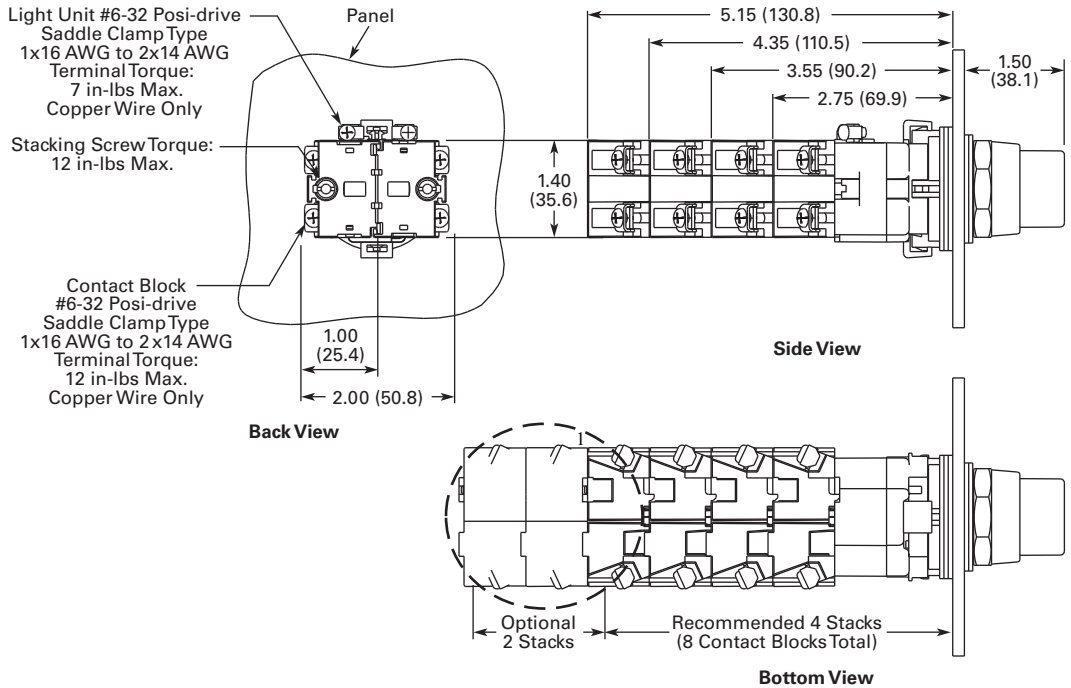

**Note**

① Recommended maximum of four tandem stacks of contact blocks behind operator. At users' discretion, two additional tandem stacks may be added.

# 1.10 Pushbuttons and Indicating Lights

## 30.5 mm Watertight/Oiltight—HT800

1

Approximate Dimensions in Inches (mm)

### Mushroom Head Pushbuttons and Round Head MRH Push-Pull Operators

Back, side and bottom views of mushroom head operator with attached contact blocks.

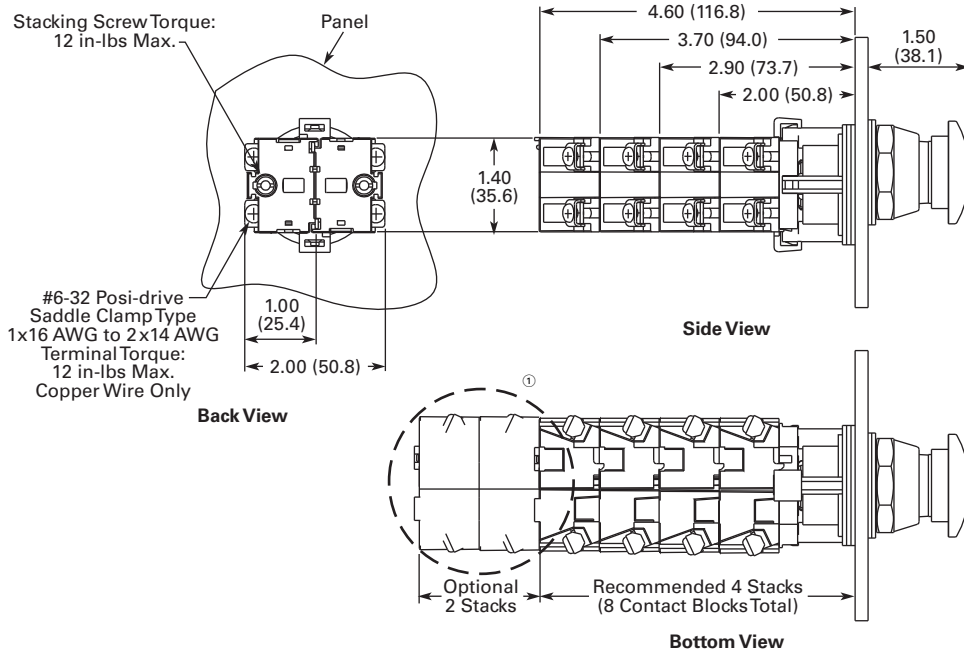

### Illuminated and Non-Illuminated Flat Head MRH Push-Pull Operators

Back, side and bottom views of push-pull operator with attached contact blocks.

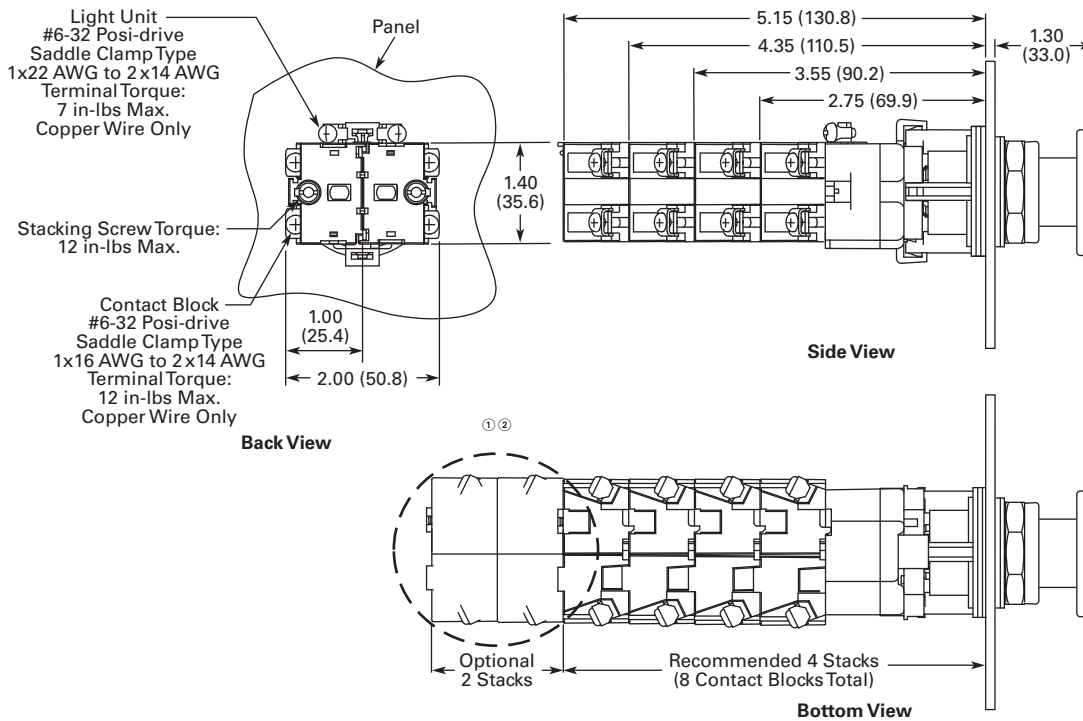

#### Notes

- ① Recommended maximum of four tandem stacks of contact blocks behind operator. At users' discretion, two additional tandem stacks may be added.
- ② Contact blocks mount directly to operator adaptor in non-illuminated version.

Approximate Dimensions in Inches (mm)

### Indicating Lights

Back, side and bottom views of indicating light operator with attached contact blocks.

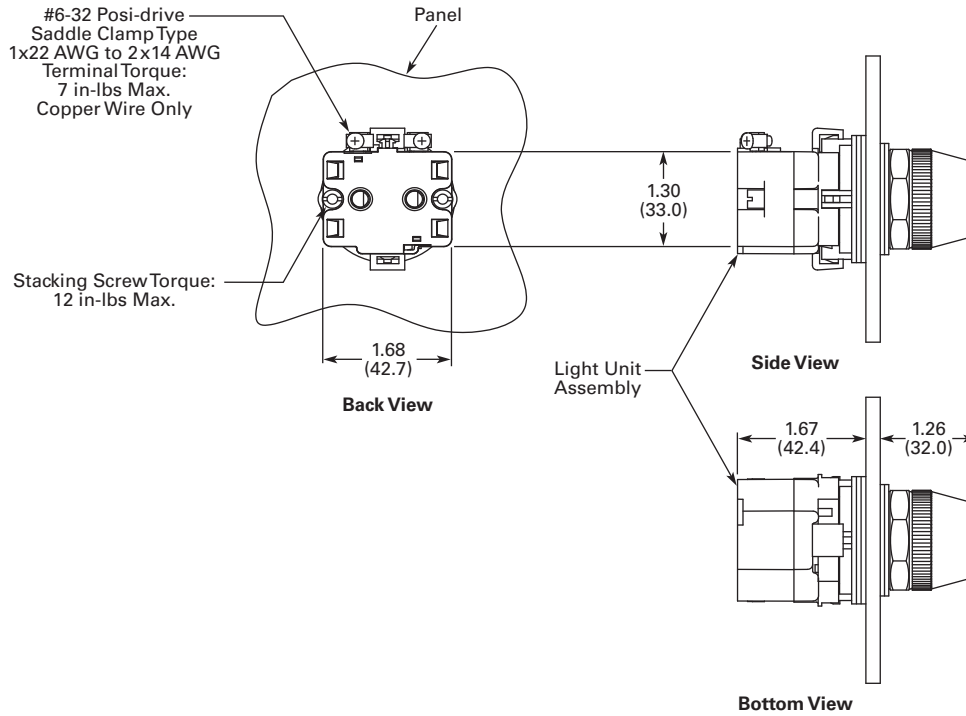

### Selector Switches

Back, side and bottom views of selector switch operator with attached contact blocks.

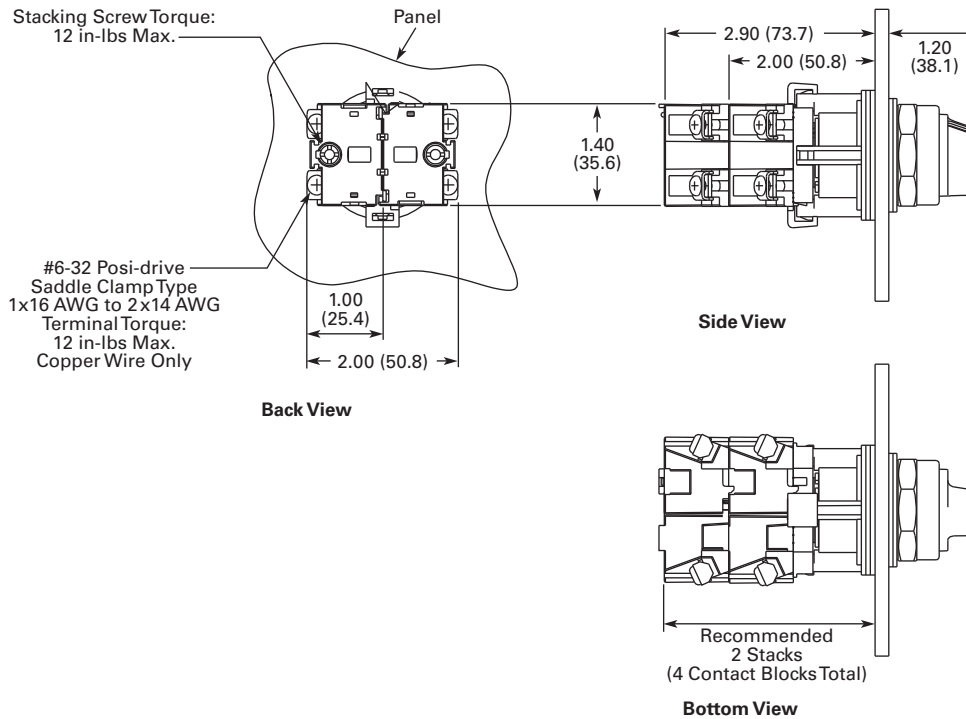

# 1.10

## Pushbuttons and Indicating Lights

30.5 mm Watertight/Oiltight—HT800

### 1 Mounting Matrix and Minimum Panel Spacing Requirements

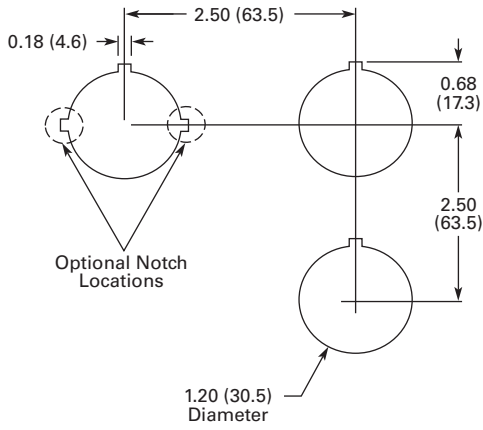

### Legend Plates

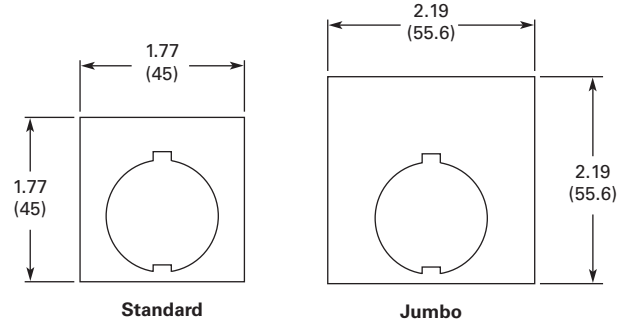

30.5 mm Class I Division 2 Hazardous Locations—10250T/E34



### Contents

<i>Description</i>	<i>Page</i>
30.5 mm Class I Division 2 Hazardous Locations—10250T/E34	
Product Overview . . . . .	<b>V7-T1-332</b>
Product Identification . . . . .	<b>V7-T1-333</b>
Catalog Number Selection . . . . .	<b>V7-T1-333</b>
Product Selection	
Momentary Pushbutton Units . . . . .	<b>V7-T1-334</b>
Non-Illuminated Pushbutton Units . . . . .	<b>V7-T1-338</b>
Illuminated Pushbutton Units . . . . .	<b>V7-T1-340</b>
Guarded Illuminated Pushbutton Units . . . . .	<b>V7-T1-341</b>
Indicating Light Units . . . . .	<b>V7-T1-342</b>
Illuminated Pushbuttons and Indicating Lights . . . . .	<b>V7-T1-343</b>
Push-Pull Units . . . . .	<b>V7-T1-345</b>
Illuminated Push-Pull Units . . . . .	<b>V7-T1-347</b>
Push-Pull Operators . . . . .	<b>V7-T1-350</b>
Selector Switch Units . . . . .	<b>V7-T1-354</b>
Selector Switch Selection . . . . .	<b>V7-T1-356</b>
Selector Switch Operators . . . . .	<b>V7-T1-359</b>
Illuminated Selector Switch Operators . . . . .	<b>V7-T1-362</b>
Options . . . . .	<b>V7-T1-364</b>
Technical Data and Specifications . . . . .	<b>V7-T1-367</b>
Dimensions . . . . .	<b>V7-T1-369</b>
Ratings . . . . .	<b>V7-T1-370</b>

### Product Description

#### All the Industry-Proven Quality of Eaton's 10250T and E34 Series of Logic Devices, plus Class I Division 2 Certification

The **10250T1H** consists of a normally open-normally closed factory sealed contact block that is UL Listed for use in Class I, Division 2, Groups B, C and D (NEC 500–503)—Class I, Zone 2, IIB + H2 (NEC 505) hazardous locations and is rated for both NEMA A600 and NEMA Q300. 10250T and E34 illuminated components have also been UL Listed for use in Class I, Division 2, Groups B, C and D (NEC 500–503)—Class I, Zone 2, IIB + H2 (NEC 505).

This, combined with the industry-proven Eaton 10250T 30.5 mm pushbutton line, offers a complete solution to Division 2 hazardous location requirements.

Single composite catalog numbers for complete assembled stations and operators for use in Division 2 hazardous locations are featured throughout this section.

### Features

- Factory sealed contact blocks
- Heavy-duty zinc die cast construction
- NEMA rated 1, 2, 3, 3R, 4, 4X, 12, 13
- Front-of-panel drainage holes
- Grounding nibs on the operator casing
- Solid thermosetting cathodic epoxy coating on E34
- Corrosion resistance in E34

### Benefits

- Pushbutton for hazardous locations
- Drainage holes prevent buildup of liquid inside the operator which can prevent operation in freezing environments
- Grounding nibs bite through paint and other coatings to provide secure ground
- Suitable for corrosive environments (E34 only)
- Earth terminal provides additional grounding point and allows for daisy chain grounding (E34 line)

### Standards and Certifications

- UL 508—File No. E131568
- UL 1604—File No. E10323
- CSA Certified C22.2 No.14—File No. LR 68551
- CSA Certified C22.2 No. 213-M1987—File No. LR 20713



### Ingress Protection

- Standard indicating lights
  - UL (NEMA) Type 3, 3R, 3S, 4, 4X, 12, 13
  - IEC IP65
- All other operators
  - UL (NEMA) Type 3, 3R, 4, 4X, 12, 13
  - IEC IP65



## Product Overview

### Operator

The 30.5 mm 10250T pushbutton line features a zinc die cast construction with chrome-plated housing and mounting nut.

Eaton's E34 Series 30.5 mm pushbutton line features the same rugged die cast construction of our 10250T line with an additional two-layer 100% solid thermosetting cathodic epoxy coating. This coating provides a flat black smooth, consistent, corrosion resistant surface that has passed a demanding 600 hour salt spray test. (The industry standard for this 4X test requires only 200 hours.)

### Ultraviolet Light

E34 epoxy coating is not recommended for use in applications where exposure to ultraviolet light exists—use NEMA 4X 10250T operators.

### Ratings

Our Class I Division 2 line of pushbuttons are UL Listed (NEMA type) 1, 2, 3, 3R, 4, 4X, 12 and 13. Our Class I Division 2 E34 line meets IEC 947-1 IP66 standards and the cathodic coating meets FDA 3A sanitary chemical resistance requirements. For a complete listing of all applicable ratings see **Pages V7-T1-367 to V7-T1-368.**

### 10250T Grounding Nibs

10250T line operators have "grounding nibs"—four metal points on the operator casting designed to bite through most paints and other coatings on metal panels to enhance the grounding connection when the operator is securely tightened.

### 10250T Grounding Nibs



### E34 Grounding Nibs

E34 line of operators is equipped with a ground screw terminal as part of its die cast construction. This earthing terminal provides an easily accessible point for grounding operators when used in a painted or nonmetallic enclosure and eliminates the need for extra kits when daisy chain grounding is required.

### E34 Grounding Nibs



### Diaphragm Seal with Drainage Holes

#### Liquid Drainage

Eaton's pushbutton operators offer front of panel drainage via holes in the operator bushing. Hidden from view by the mounting nut, these holes prevent buildup of liquid inside the operator, which can prevent operation in freezing environments. The holes also provide a route for escaping liquid in high pressure washdowns, effectively relieving pressure from the internal diaphragm seal, ensuring reliable sealing in applications even beyond NEMA 4.

### Diaphragm Seal

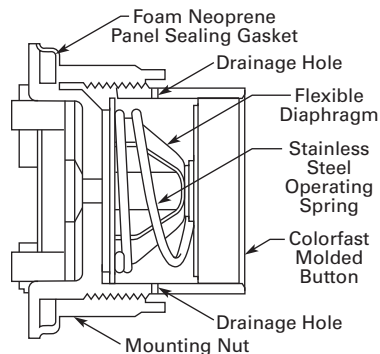

### Product Identification

#### 30.5 mm Class I Division 2 Hazardous Locations

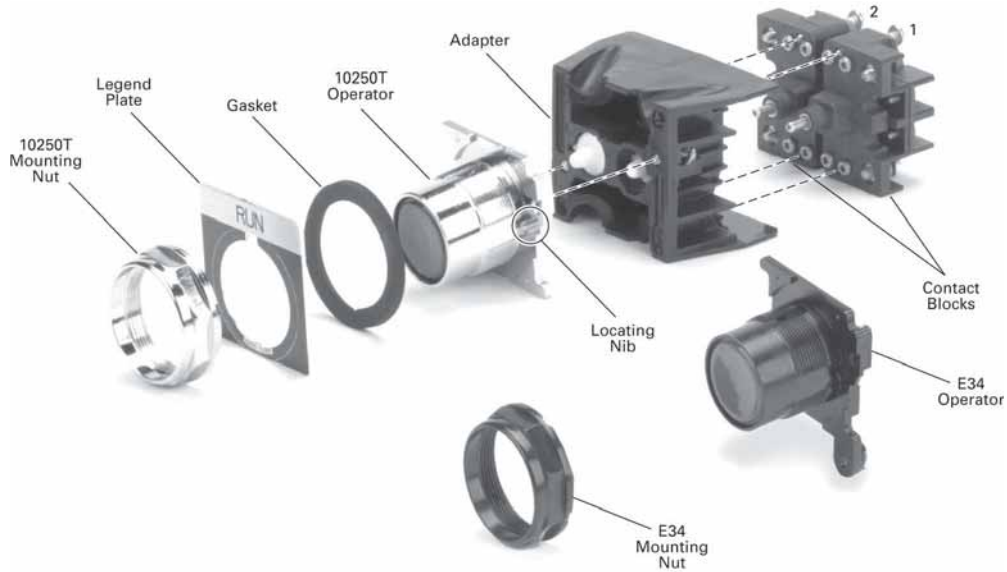

### Catalog Number Selection

Catalog Number Selection is for illustrative purposes only and not to be used to create new catalog numbers.

#### Non-Illuminated Assembled Operators

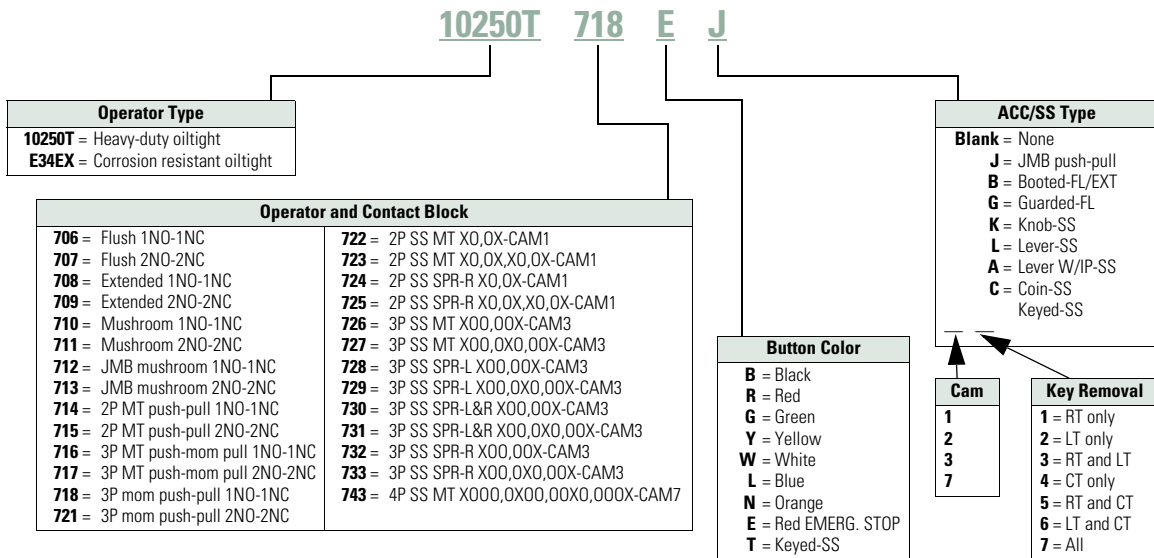

# 1

## Product Selection

### Momentary Pushbutton Units

UL (NEMA) Type 3, 3R, 4, 4X, 12, 13, NEC Class I Division 2, Groups B, C and D

#### 10250T Flush Button



#### E34 Flush Button



#### 10250T Extended Button



#### E34 Extended Button



### Non-Illuminated Flush and Extended Pushbuttons

Contact Type	Button Color ①	Flush Button		Extended Button		
		10250T Catalog Number	E34 Catalog Number	10250T Catalog Number	E34 Catalog Number	
1NO-1NC	Black	<u>10250T706B</u>	<u>E34EX706B</u>	<u>10250T708B</u>	<u>E34EX708B</u>	
	Red	<u>10250T706R</u>	<u>E34EX706R</u>	<u>10250T708R</u>	<u>E34EX708R</u>	
	Green	<u>10250T706G</u>	<u>E34EX706G</u>	<u>10250T708G</u>	<u>E34EX708G</u>	
	2NO-2NC	Black	<u>10250T707B</u>	<u>E34EX707B</u>	<u>10250T709B</u>	<u>E34EX709B</u>
		Red	<u>10250T707R</u>	<u>E34EX707R</u>	<u>10250T709R</u>	<u>E34EX709R</u>
		Green	<u>10250T707G</u>	<u>E34EX707G</u>	<u>10250T709G</u>	<u>E34EX709G</u>

### Color Selection

Color	Suffix Code	Color	Suffix Code
Black	<b>B</b>	White	<b>W</b>
Red	<b>R</b>	Blue	<b>L</b> ②
Green	<b>G</b>	Orange ③	<b>N</b>
Yellow	<b>Y</b>	Red (EMERG. STOP) ④	<b>E</b>

#### Notes

Use NEMA 4X 10250T operators where exposed to ultraviolet light.

① To order different color guarded button, simply substitute the underlined character in catalog number with appropriate suffix code from Color Selection table above. Example: 10250T710Y.

② Blue not available on jumbo mushroom pushbutton.

③ Orange is only available on flush or extended pushbuttons.

④ Red with EMERG. STOP engraved on button head for jumbo mushroom pushbutton only.

UL (NEMA) Type 3, 3R, 4, 4X, 12, 13, NEC Class I Division 2, Groups B, C and D

**10250T Mushroom Button**



**E34 Mushroom Button**



**10250T Jumbo Mushroom Button**



**E34 Jumbo Mushroom Button**



### Non-Illuminated Mushroom and Jumbo Mushroom Pushbuttons

Contact Type	Button Color <sup>①</sup>	Mushroom Button	E34	Jumbo Mushroom Button	E34 <sup>②</sup>
		10250T Catalog Number	Catalog Number	10250T <sup>②</sup> Catalog Number	Catalog Number
1NO-1NC	Black	<b>10250T710B</b>	<b>E34EX710B</b>	<b>10250T712B</b>	<b>E34EX712B</b>
	Red	<b>10250T710R</b>	<b>E34EX710R</b>	<b>10250T712R</b>	<b>E34EX712R</b>
	Green	<b>10250T710G</b>	<b>E34EX710G</b>	<b>10250T712G</b>	<b>E34EX712G</b>
2NO-2NC	Black	<b>10250T711B</b>	<b>E34EX711B</b>	<b>10250T713B</b>	<b>E34EX713B</b>
	Red	<b>10250T711R</b>	<b>E34EX711R</b>	<b>10250T713R</b>	<b>E34EX713R</b>
	Green	<b>10250T711G</b>	<b>E34EX711G</b>	<b>10250T713G</b>	<b>E34EX713G</b>

### Color Selection

Color	Suffix Code	Color	Suffix Code
Black	<b>B</b>	White	<b>W</b>
Red	<b>R</b>	Blue	<b>L</b> <sup>③</sup>
Green	<b>G</b>	Orange <sup>④</sup>	<b>N</b>
Yellow	<b>Y</b>	Red (EMERG. STOP) <sup>⑤</sup>	<b>E</b>

**Notes**

- Use NEMA 4X 10250T operators where exposed to ultraviolet light.
- <sup>①</sup> To order different color guarded button, simply substitute the underlined character in catalog number with appropriate suffix code from Color Selection table above. Example: 10250T710Y.
- <sup>②</sup> Anodized aluminum head is not suitable for use in ultraviolet applications.
- <sup>③</sup> Blue not available on jumbo mushroom pushbutton.
- <sup>④</sup> Orange is only available on flush or extended pushbuttons.
- <sup>⑤</sup> Red with EMERG. STOP engraved on button head for jumbo mushroom pushbutton only.

1

UL (NEMA) Type 3, 3R, 4, 4X, 12, 13, NEC Class I Division 2, Groups B, C and D

- Momentary contact
- Non-illuminated
- Booted or guarded

#### Booted Flush Button



#### Booted Extended Button



#### Guarded Extended Button



#### 10250T Pushbuttons Booted and Guarded

Contact Type	Button Color	Booted Flush Button Catalog Number	Booted Extended Button Catalog Number	Guarded Extended Button <sup>①</sup> Catalog Number
1NO-1NC	Black	<b>10250T706BB</b>	<b>10250T708BB</b>	<b>10250T706BG</b>
	Red	<b>10250T706RB</b> <sup>②</sup>	<b>10250T708RB</b>	<b>10250T706RG</b>
	Green	<b>10250T706GB</b>	<b>10250T708GB</b>	<b>10250T706GG</b>
2NO-2NC	Black	<b>10250T707BB</b>	<b>10250T709BB</b>	<b>10250T707BG</b>
	Red	<b>10250T707RB</b> <sup>②</sup>	<b>10250T709RB</b>	<b>10250T707RG</b>
	Green	<b>10250T707GB</b>	<b>10250T709GB</b>	<b>10250T707GG</b>

#### Color Selection

Color	Suffix Code	Color	Suffix Code
Black	<b>B</b>	White	<b>W</b>
Red	<b>R</b>	Blue	<b>L</b>
Green	<b>G</b>	Orange	<b>N</b>
Yellow	<b>Y</b>		

#### Notes

Use NEMA 4X 10250T operators where exposed to ultraviolet light.

<sup>①</sup> To order different color guarded button, simply substitute the underlined character in catalog number with appropriate suffix code from Color Selection table above. Example: 10250T706YG.

<sup>②</sup> Red booted flush pushbutton is not recommended for STOP function.

UL (NEMA) Type 3, 3R, 4, 4X, 12, 13, NEC Class I Division 2, Groups B, C and D

- Momentary contact
- Non-illuminated
- Booted or guarded

### Booted Flush Button



### E34 Pushbuttons Booted and Guarded

Contact Type	Button Color	Booted Flush Button Catalog Number	Booted Extended Button Catalog Number	Guarded Extended Button <sup>①</sup> Catalog Number
1NO-1NC	Black	E34EX706BB	E34EX708BB	E34EX706BG
	Red	E34EX706RB <sup>②</sup>	E34EX708RB	E34EX706RG
	Green	E34EX706GB	E34EX708GB	E34EX706GG
2NO-2NC	Black	E34EX707BB	E34EX709BB	E34EX707BG
	Red	E34EX707RB <sup>②</sup>	E34EX709RB	E34EX707RG
	Green	E34EX707GB	E34EX709GB	E34EX707GG

### Booted Extended Button



### Guarded Extended Button



### Color Selection

Color	Suffix Code	Color	Suffix Code
Black	<b>B</b>	White	<b>W</b>
Red	<b>R</b>	Blue	<b>L</b>
Green	<b>G</b>	Orange	<b>N</b>
Yellow	<b>Y</b>		

#### Notes

Use NEMA 4X 10250T operators where exposed to ultraviolet light.

<sup>①</sup> To order different color guarded button, simply substitute the underlined character in catalog number with appropriate suffix code from Color Selection table above. Example: 10250T706YG.

<sup>②</sup> Red booted flush pushbutton is not recommended for STOP function.

#### 1

#### Non-Illuminated Pushbutton Units

UL (NEMA) Type 3, 3R, 4, 4X, 12, and 13

##### 10250T Flush Button



##### E34 Flush Button



##### 10250T Extended Button



##### E34 Extended Button



##### 10250T Half Shrouded Button



##### E34 Half Shrouded Button



#### Non-Illuminated Pushbuttons, Momentary Contact

Color	Flush Button		Extended Button		Half Shrouded Button		E34	
	10250T <sup>①</sup> Catalog Number	E34 Catalog Number	10250T Catalog Number	E34 Catalog Number	10250T Vertical Catalog Number	Horizontal Catalog Number	Vertical Catalog Number	Horizontal Catalog Number
Black	10250T101	E34PB1	10250T111	E34EB1	10250T501	10250T511	E34EVB1	E34EHB1
Red	10250T102	E34PB2	10250T112	E34EB2	10250T502	10250T512	E34EVB2	E34EHB2
Green	10250T103	E34PB3	10250T113	E34EB3	10250T503	10250T513	E34EVB3	E34EHB3
Yellow	10250T104	E34PB4	10250T120	E34EB4	10250T504	10250T514	E34EVB4	E34EHB4
Gray	10250T105	E34PB5	—	E34EB5	10250T505	10250T515	E34EVB5	E34EHB5
White	10250T106	E34PB6	10250T116	E34EB6	10250T506	10250T516	E34EVB6	E34EHB6
Blue	10250T108	E34PB7	10250T118	E34EB7	10250T508	10250T518	E34EVB7	E34EHB7
Orange	10250T109	E34PB8	10250T119	E34EB8	10250T509	10250T519	E34EVB8	E34EHB8

#### Notes

Use NEMA 4X 10250T operators where exposed to ultraviolet light.

<sup>①</sup> To order operator with factory assembled extended retaining nut, 10250TA12, for thick panel applications, add suffix letter **E** to listed catalog number.

UL (NEMA) Type 3, 3R, 4, 4X, 12, and 13

**10250T Mushroom Button**



**Mushroom Head Non-Illuminated Pushbuttons, Momentary Contact**

Color	Mushroom Button		Anodized Aluminum Jumbo Mushroom Button	
	10250T Catalog Number	E34 Catalog Number	10250T <sup>①</sup> Catalog Number	E34 <sup>②</sup> Catalog Number
Black	10250T121	E34LB1	10250T171	E34JB1
Red	10250T122	E34LB2	10250T172	E34JB2
Red (EMERG. STOP)	—	—	10250T17213	E34JB2N8
Green	10250T123	E34LB3	10250T173	E34JB3
Yellow	10250T124	E34LB4	10250T174	E34JB4
Blue	10250T129	E34LB6	—	—

**E34 Mushroom Button**



**10250T Jumbo Mushroom Button**



**E34 Jumbo Mushroom Button**



**Notes**

- Use NEMA 4X 10250T operators where exposed to ultraviolet light.
- ① Anodized aluminum head is not suitable for use in ultraviolet light applications.
- ② Anodized aluminum head may not be suitable for some corrosive environments.



#### 1

### Illuminated Pushbutton Units

UL (NEMA) Type 3, 3R, 4, 4X, 12, 13, NEC Class I Division 2, Groups B, C and D

- Momentary contact
- Illuminated
- Plastic lenses

#### 10250T<sub>8</sub>



#### E34EX<sub>8</sub>



### Illuminated Pushbuttons

Type	Voltage	Color	Contact	10250T LED/Lamp Number	Catalog Number ①	E34 LED/Lamp Number	Catalog Number ①
<b>LED Lamp</b>							
Full voltage	24 Vac/Vdc	Red	1NO-1NC	Bayonet base	<b>10250T828RD24</b>	Bayonet base	<b>E34EX828RD24</b>
		Green			<b>10250T828GD24</b>		<b>E34EX828GD24</b>
		Amber			<b>10250T828AD24</b>		<b>E34EX828AD24</b>
Transformer	120 Vac	Red	1NO-1NC		<b>10250T828RD2A</b>		<b>E34EX828RD2A</b>
		Green		<b>10250T828GD2A</b>	<b>E34EX828GD2A</b>		
		Amber		<b>10250T828AD2A</b>	<b>E34EX828AD2A</b>		
Transformer	120 Vac	Red	1NO-1NC		<b>10250T802RD06</b>	Bayonet base 6 Vac	<b>E34EX802RD06</b>
		Green		<b>10250T802GD06</b>	<b>E34EX802GD06</b>		
		Amber		<b>10250T802AD06</b>	<b>E34EX802AD06</b>		
<b>Incandescent Lamp</b>							
Full voltage	24 Vac/Vdc	Red	1NO-1NC	#757	<b>10250T818RD</b>	#757	<b>E34EX818RD</b>
		Green			<b>10250T818GD</b>		<b>E34EX818GD</b>
		Amber			<b>10250T818AD</b>		<b>E34EX818AD</b>
Resistor	120 Vac/Vdc	Red	1NO-1NC	120MB	<b>10250T824RD</b>	120MB	<b>E34EX824RD</b>
		Green			<b>10250T824GD</b>		<b>E34EX824GD</b>
		Amber			<b>10250T824AD</b>		<b>E34EX824AD</b>
Transformer	120 Vac	Red	1NO-1NC	#755	<b>10250T802RD</b>	#755 6 Vac	<b>E34EX802RD</b>
		Green			<b>10250T802GD</b>		<b>E34EX802GD</b>
		Amber			<b>10250T802AD</b>		<b>E34EX802AD</b>

#### 10250TC<sub>2</sub>



#### E34V<sub>2</sub>



### Lens Selection

Color	Suffix Code	Catalog Number	Color	Suffix Code	Catalog Number
<b>10250T</b>			<b>E34</b>		
Red	<b>R</b>	<b>10250TC21</b>	Red	<b>R</b>	<b>E34V2</b>
Green	<b>G</b>	<b>10250TC22</b>	Green	<b>G</b>	<b>E34V3</b>
Yellow	<b>Y</b>	<b>10250TC23</b>	Yellow	<b>Y</b>	<b>E34V4</b>
Amber	<b>A</b>	<b>10250TC43</b>	Amber	<b>A</b>	<b>E34V9</b>
Blue	<b>L</b>	<b>10250TC24</b>	Blue	<b>L</b>	<b>E34V6</b>
Clear	<b>C</b>	<b>10250TC25</b>	Clear	<b>C</b>	<b>E34V0</b>
White	<b>W</b>	<b>10250TC26</b>	White	<b>W</b>	<b>E34V5</b>

#### Note

① To order different color lens, simply substitute the underlined character in the catalog number with appropriate suffix code from Lens Selection table above. Example: 10250T828YD24.

### Guarded Illuminated Pushbutton Units

UL (NEMA) Type 3, 3R, 4, 4X, 12, 13, NEC Class I Division 2, Groups B, C and D

- Momentary contact
- Guarded illuminated
- Plastic lenses

#### 10250T8\_



### Guarded Illuminated Pushbuttons

Type	Voltage	Color	Contact	10250T LED/Lamp Number	Catalog Number ①	E34 LED/Lamp Number	Catalog Number ①
<b>LED Lamp</b>							
Full voltage	24 Vac/Vdc	Red	1NO-1NC	Bayonet base	<u>10250T828RG24</u>	Bayonet base	<u>E34EX828RG24</u>
		Green			10250T828GG24		E34EX828GG24
		Amber			10250T828AG24		E34EX828AG24
Transformer	120 Vac	Red	1NO-1NC		<u>10250T828RG2A</u>		<u>E34EX828RG2A</u>
		Green			10250T828GG2A	E34EX828GG2A	
		Amber			10250T828AG2A	E34EX828AG2A	
Transformer	120 Vac	Red	1NO-1NC		<u>10250T802RG06</u>		<u>E34EX802RG06</u>
		Green			10250T802GG06	E34EX802GG06	
		Amber			10250T802AG06	E34EX802AG06	
<b>Incandescent Lamp</b>							
Full voltage	24 Vac/Vdc	Red	1NO-1NC	#757	<u>10250T818RG</u>	#757	<u>E34EX818RG</u>
		Green			10250T818GG		E34EX818GG
		Amber			10250T818AG		E34EX818AG
Resistor	120 Vac/Vdc	Red	1NO-1NC	120MB	<u>10250T824RG</u>	120MB	<u>E34EX824RG</u>
		Green			10250T824GG		E34EX824GG
		Amber			10250T824AG		E34EX824AG
Transformer	120 Vac	Red	1NO-1NC	#755	<u>10250T802RG</u>	#755 6 Vac	<u>E34EX802RG</u>
		Green			10250T802GG		E34EX802GG
		Amber			10250T802AG		E34EX802AG

#### E34EX8\_



#### 10250TC2\_



### Lens Selection

Color	Suffix Code	Catalog Number	Color	Suffix Code	Catalog Number
<b>10250T</b>			<b>E34</b>		
Red	<u>R</u>	<u>10250TC21</u>	Red	<u>R</u>	<u>E34V2</u>
Green	<u>G</u>	<u>10250TC22</u>	Green	<u>G</u>	<u>E34V3</u>
Yellow	<u>Y</u>	<u>10250TC23</u>	Yellow	<u>Y</u>	<u>E34V4</u>
Amber	<u>A</u>	<u>10250TC43</u>	Amber	<u>A</u>	<u>E34V9</u>
Blue	<u>L</u>	<u>10250TC24</u>	Blue	<u>L</u>	<u>E34V6</u>
Clear	<u>C</u>	<u>10250TC25</u>	Clear	<u>C</u>	<u>E34V0</u>
White	<u>W</u>	<u>10250TC26</u>	White	<u>W</u>	<u>E34V5</u>

**Note**

① To order different color lens, simply substitute the underlined character in the catalog number with appropriate suffix code from Lens Selection table above. Example: 10250T828YD24.

#### E34V\_



# 1

## Indicating Light Units

UL (NEMA) Type 3, 3R, 3S, 4, 4X, 12, 13, NEC Class I Division 2, Groups B, C and D

- Standard
- Plastic lenses

### 10250T\_



### E34\_



## Indicating Lights

Type	Voltage	Color	LED/Lamp Number	10250T Catalog Number ①	E34 Catalog Number ①	
<b>LED Lamp</b>						
Full voltage	24 Vac/Vdc	Red	Bayonet base	<u>10250T197HLRP24</u>	<u>E34FB197HLRP24</u>	
		Green		<u>10250T197HLGP24</u>	<u>E34FB197HLGP24</u>	
		Amber		<u>10250T197HLAP24</u>	<u>E34FB197HLAP24</u>	
	120 Vac	Red	<u>10250T197HLRP2A</u>	<u>E34FB197HLRP2A</u>		
		Green	<u>10250T197HLGP2A</u>	<u>E34FB197HLGP2A</u>		
		Amber	<u>10250T197HLAP2A</u>	<u>E34FB197HLAP2A</u>		
Transformer	120 Vac	Red		<u>10250T181HLRP06</u>	<u>E34TB120HLRP06</u>	
		Green		<u>10250T181HLGP06</u>	<u>E34TB120HLGP06</u>	
		Amber		<u>10250T181HLAP06</u>	<u>E34TB120HLAP06</u>	
	<b>Incandescent Lamp</b>					
	Full voltage	24 Vac/Vdc	Red	#757	<u>10250T206HRP</u>	<u>E34FB24HRP</u>
			Green		<u>10250T206HGP</u>	<u>E34FB24HGP</u>
Amber				<u>10250T206HAP</u>	<u>E34FB24HAP</u>	
Resistor	120 Vac/Vdc	Red	120MB	<u>10250T201HRP</u>	<u>E34RB120HRP</u>	
		Green		<u>10250T201HGP</u>	<u>E34RB120HGP</u>	
		Amber		<u>10250T201HAP</u>	<u>E34RB120HAP</u>	
Transformer	120 Vac	Red	#755	<u>10250T181HRP</u>	<u>E34TB120HRP</u>	
		Green		<u>10250T181HGP</u>	<u>E34TB120HGP</u>	
		Amber		<u>10250T181HAP</u>	<u>E34TB120HAP</u>	

### Plastic



### Glass



## Lens Selection

Color	Plastic Suffix Code	Catalog Number	Glass Suffix Code	Catalog Number	Color	Plastic Suffix Code	Catalog Number	Glass Suffix Code	Catalog Number
<b>10250T</b>					<b>E34</b>				
Red	RP	10250TC1N	RG	10250TC7N	Red	RP	E34H2	RG	E34G2
Green	GP	10250TC2N	GG	10250TC8N	Green	GP	E34H3	GG	E34G3
Amber	AP	10250TC19N	AG	10250TC9N	Amber	AP	E34H9	AG	E34G9
Yellow	YP	10250TC3N	—	—	Yellow	YP	E34H4	YG	E34G4
Blue	LP	10250TC4N	LG	10250TC10N	Blue	LP	E34H6	LG	E34G6
Clear	CP	10250TC5N	CG	10250TC11N	Clear	CP	E34H0	CG	E34G0
White	WP	10250TC6N	WG	10250TC12N	White	WP	E34H5	WG	E34G5

### Notes

Use NEMA 4X 10250T operators where exposed to ultraviolet light.

① To order different color lens, simply substitute the underlined characters in the catalog number with appropriate suffix code from the Lens Selection table above.  
Example: 10250T201HYP.

**Illuminated Pushbuttons and Indicating Lights**

NEC Class I Division 2, Groups B, C and D

**Operators without Lenses**

**10250T Illuminated Pushbutton**



**E34 Illuminated Pushbutton**



**10250T Indicating Light**



**E34 Indicating Light**



Type	Voltage	LED/Lamp Number	Illuminated Pushbutton		Indicating Light	
			10250T Catalog Number	E34 Catalog Number	10250T Catalog Number	E34 Catalog Number
<b>LED Light Unit Type (LEDs not included) ①</b>						
Full voltage	—	Bayonet base	10250T397HL	E34CB497HL	10250T197HL	E34FB197HL
Transformer AC only	24		10250T416HL	E34XB024HL	—	—
	120		10250T411HL	E34XB120HL	10250T181HL	E34TB120HL
	240		10250T412HL	E34XB240HL	10250T182HL	E34TB240HL
	277		10250T419HL	E34XB277HL	10250T198HL	E34TB277HL
	380		10250T413HL	E34XB380HL	10250T183HL	E34TB380HL
	480		10250T414HL	E34XB480HL	10250T184HL	E34TB480HL
	600		10250T415HL	E34XB600HL	10250T185HL	E34TB600HL
<b>Incandescent Light Unit Type</b>						
Full voltage AC/DC	6	#755	10250T473H	E34CB06H	10250T203H	E34FB06H
	12	#756	10250T474H	E34CB12H	10250T204H	E34FB12H
	24	#757	10250T476H	E34CB24H	10250T206H	E34FB24H
	32	#1828	10250T477H	E34CB32H	10250T207H	E34FB32H
	48	#1835	10250T478H	E34CB48H	10250T208H	E34FB48H
Resistor ② AC/DC	120	120MB	10250T471H	E34SB120H	10250T201H	E34RB120H
	240	120MB	10250T472H	E34SB240H	10250T202H	E34RB240H
Transformer AC only	24	#755	10250T416H	E34XB024H	—	—
	120		10250T411H	E34XB120H	10250T181H	E34TB120H
	240		10250T412H	E34XB240H	10250T182H	E34TB240H
	277		10250T419H	E34XB277H	10250T198H	E34TB277H
	380		10250T413H	E34XB380H	10250T183H	E34TB380H
	480		10250T414H	E34XB480H	10250T184H	E34TB480H
Neon AC/DC	120	NE51H-R-22	—	—	10250T226H	E34NB120H
	240	NE51H-4-68	—	—	10250T227H	E34NB240H





**Notes**

Use NEMA 4X 10250T operators where exposed to ultraviolet light.



① These units do not include lamps. Order LED separately to match lens color from the LED Selection table on **Page V7-T1-353**.

② Resistor units are not available for use with LEDs, choose either transformer or full voltage LED style.

#### Indicating Light Lenses

	Color	10250T Catalog Number	E34 Catalog Number
<b>Plastic</b>   <b>10250TC_</b>   <b>E34H_</b>	<b>Plastic</b>		
	Red	10250TC1N	E34H2
	Green	10250TC2N	E34H3
	Amber	10250TC19N	E34H9
	Yellow	10250TC3N	E34H4
	Blue	10250TC4N	E34H6
	Clear	10250TC5N	E34H0
White	10250TC6N	E34H5	
<b>Glass</b>   <b>10250TC_</b>   <b>E34G_</b>	<b>Glass</b>		
	Red	10250TC7N	E34G2
	Green	10250TC8N	E34G3
	Amber	10250TC9N	E34G9
	Yellow	—	E34G4
	Blue	10250TC10N	E34G6
	Clear	10250TC11N	E34G0
White	10250TC12N	E34G5	

#### Illuminated Pushbutton Lenses

	Color	10250T Catalog Number	E34 Catalog Number
<b>10250TC_</b>    <b>E34V_</b>  	<b>Illuminated Pushbutton Lenses</b>		
	Red	10250TC21	E34V2
	Green	10250TC22	E34V3
	Yellow	10250TC23	E34V4
	Amber	10250TC43	E34V9
	Blue	10250TC24	E34V6
	Clear	10250TC25	E34V0
White	10250TC26	E34V5	

### Push-Pull Units

UL (NEMA) Type 3, 3R, 4, 4X, 12, 13, NEC Class I Division 2, Groups B, C and D

- Two- and three-position
- Non-illuminated

10250T71\_

#### Two-Position Maintained Push, Maintained Pull



Operator Function (Position) ①

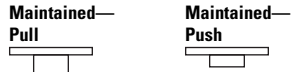

	Maintained— Pull	Maintained— Push	Contact Type	Mounting Location ①		Red Standard Push-Pull ②	
				1	2	10250T Catalog Number	E34 Catalog Number
0		X	1NO			<u>10250T714R</u>	<u>E34EX714R</u>
X	X	0	1NC				

E34EX71\_



0		X	2NO			<u>10250T715R</u>	<u>E34EX715R</u>
X	X	0	2NC				
0		X					
X	X	0					

10250T71\_

#### Three-Position Maintained Push, Momentary Pull



Operator Function (Position) ①



	Momentary— Pull	Maintained— Intermediate	Maintained— Push	Contact Type	Mounting Location ①		Red Standard Push-Pull ③	
					1	2	10250T Catalog Number	E34 Catalog Number
0		0	X	1NO			<u>10250T716R</u>	<u>E34EX716R</u>
X	X	0	0	1NC				

E34EX71\_



X		0	0	1NC			<u>10250T717R</u>	<u>E34EX717R</u>
X	X	X	0	1NC				

#### Notes

- ① Bolded circuit corresponds to "X-0" circuit selection. X = closed circuit, 0 = open circuit.
- ② To order different type or color buttons, simply substitute underlined character with appropriate suffix code from the Button and Color Selection table on **Page V7-T1-346**. Example: 10250T714G.
- ③ To order different type or color buttons, simply substitute underlined character with appropriate suffix code from the Button and Color Selection table on **Page V7-T1-346**. Example: 10250T716G.

1

UL (NEMA) Type 3, 3R, 4, 4X, 12, 13, NEC Class I Division 2, Groups B, C and D

- Two- and three-position
- Non-illuminated

10250T7\_



E34EX7\_



#### Three-Position Momentary Push, Momentary Pull

Operator Function (Position) ①

Momentary— Pull	Maintained— Intermediate	Momentary— Push	Contact Type	Mounting Location ①		Red Standard Push-Pull ②	
				1	2	10250T Catalog Number	E34 Catalog Number
0 X	0 0	X 0	1NO 1NC			<b>10250T718R</b>	<b>E34EX718R</b>
X X	0 X	0 0	1NC 1NC			<b>10250T721R</b>	<b>E34EX721R</b>

#### Button and Color Selection

Standard



Jumbo Mushroom Head



Color	Suffix Code	10250T Catalog Number	E34 Catalog Number
<b>Standard</b>			
Red	<b>R</b>	<b>10250TB62</b>	<b>E34C2</b>
Red (EMERG. STOP)	<b>E</b>	<b>10250TB63</b>	<b>E34C2N8</b>
Green	<b>G</b>	<b>10250TB61</b>	<b>E34C3</b>
Black	<b>B</b>	<b>10250TB60</b>	<b>E34C1</b>
Blue	<b>L</b>	<b>10250TB64</b>	<b>E34C6</b>
<b>Jumbo Mushroom Head (Anodized) Aluminum</b>			
Red	<b>RJ</b>	<b>10250TJ62</b>	<b>E34J2</b>
Red (EMERG. STOP)	<b>EJ</b>	<b>10250TJ63</b>	<b>E34J2N8</b>
Green	<b>GJ</b>	<b>10250TJ61</b>	—
Black	<b>BJ</b>	<b>10250TJ60</b>	—
Yellow	<b>YJ</b>	<b>10250TJ64</b>	—

#### Notes

- ① Bolded circuit corresponds to "X-0" circuit selection. X = closed circuit, 0 = open circuit.  
 ② To order different type or color buttons, simply substitute underlined character with appropriate suffix code from the Button and Color Selection table above. Example: 10250T718G.

### Illuminated Push-Pull Units

UL (NEMA) Type 3, 3R, 4, 4X, 12, 13, NEC Class I Division 2, Groups B, C and D

- Two-position maintained
- Illuminated

#### 10250T8



#### E34EX8



### Two-Position Illuminated Maintained Push, Maintained Pull

Operator Function (Position) ①

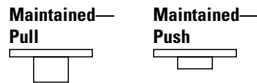

Operator Function (Position) ①		Type	Voltage	Contact Type	Mounting Location ①	Red Standard Push-Pull ②	
Maintained Pull	Maintained Push					10250T Catalog Number	E34 Catalog Number
<b>LED Lamp</b>							
0	X	Full voltage	24 Vac/Vdc	1NO		<b>10250T853RD24</b>	<b>E34EX853RD24</b>
X	0		120 Vac	1NC		<b>10250T853RD2A</b>	<b>E34EX853RD2A</b>
		Transformer	24 Vac			<b>10250T843RD06</b>	<b>E34EX843RD06</b>
			120 Vac			<b>10250T844RD06</b>	<b>E34EX844RD06</b>
<b>Incandescent Lamp</b>							
0	X	Full voltage	24 Vac/Vdc	1NO		<b>10250T849RD</b>	<b>E34EX849RD</b>
X	0		120 Vac/Vdc	1NC		<b>10250T851RD</b>	<b>E34EX851RD</b>
		Transformer	24 Vac			<b>10250T843RD</b>	<b>E34EX843RD</b>
			120 Vac			<b>10250T844RD</b>	<b>E34EX844RD</b>

### Lens and Color Selection

Color	10250T		E34	
	Suffix Code	Catalog Number	Suffix Code	Catalog Number
<b>Standard</b>				
Red	<b>RD</b>	<b>10250TC47</b>	<b>RD</b>	<b>E34M2</b>
Red (EMERG. STOP)	<b>ED</b>	<b>10250TC53</b>	<b>ED</b>	<b>E34M2N8</b>
Green	<b>GD</b>	<b>10250TC48</b>	<b>GD</b>	<b>E34M3</b>
Blue	<b>LD</b>	<b>10250TC49</b>	<b>LD</b>	<b>E34M6</b>
Amber	<b>AD</b>	<b>10250TC50</b>	<b>AD</b>	<b>E34M9</b>
White	<b>WD</b>	<b>10250TC51</b>	<b>WD</b>	<b>E34M5</b>
Clear	<b>CD</b>	<b>10250TC52</b>	<b>CD</b>	<b>E34M0</b>
<b>Side-Lighted (Anodized) Aluminum</b>				
Red	<b>RS</b>	<b>10250TC57</b>	—	—
Red (EMERG. STOP)	<b>ES</b>	<b>10250TC63</b>	—	—
Green	<b>GS</b>	<b>10250TC58</b>	—	—
Blue	<b>LS</b>	<b>10250TC59</b>	—	—
Amber	<b>AS</b>	<b>10250TC64</b>	—	—
Yellow	<b>YS</b>	<b>10250TC60</b>	—	—
White	<b>WS</b>	<b>10250TC61</b>	—	—
Clear	<b>CS</b>	<b>10250TC62</b>	—	—
<b>HD Aluminum with Transparent Center</b>				
Red	<b>RH</b>	<b>10250TC65</b>	—	—
Green	<b>GH</b>	<b>10250TC66</b>	—	—
Amber	<b>AH</b>	<b>10250TC67</b>	—	—

#### Notes

- ① Bolded circuit corresponds to “X-0” circuit selection. X = closed circuit, 0 = open circuit.
- ② To order different type or color lens, simply substitute the underlined characters with appropriate suffix code from the Lens and Color Selection table above. Example: 10250T851GS.



1

UL (NEMA) Type 3, 3R, 4, 4X, 12, 13, NEC Class I Division 2, Groups B, C and D

- Three-position—maintained push, momentary pull
- Illuminated

10250T<sub>8</sub>



E34EX<sub>8</sub>



#### Three-Position Illuminated Maintained Push, Momentary Pull

Operator Function (Position) ①



Momentary— Pull	Maintained— Intermediate	Maintained— Push	Type	Voltage	Contact Type	Mounting Location ①		Red Standard Push-Pull ②		
						1	2	10250T Catalog Number	E34 Catalog Number	
<b>LED Lamp</b>										
0	0	X	Full voltage	24 Vac/Vdc	1NO			<b>10250T864RD24</b>	<b>E34EX864RD24</b>	
X	0	0		120 Vac	1NC			<b>10250T864RD2A</b>	<b>E34EX864RD2A</b>	
				Transformer	24 Vac				<b>10250T854RD06</b>	<b>E34EX854RD06</b>
				120 Vac				<b>10250T855RD06</b>	<b>E34EX855RD06</b>	
X	0	0	Full voltage	24 Vac/Vdc	1NC			<b>10250T875RD24</b>	<b>E34EX875RD24</b>	
X	X	0		120 Vac	1NC			<b>10250T875RD2A</b>	<b>E34EX875RD2A</b>	
				Transformer	24 Vac				<b>10250T865RD06</b>	<b>E34EX865RD06</b>
				120 Vac				<b>10250T866RD06</b>	<b>E34EX866RD06</b>	
<b>Incandescent Lamp</b>										
0	0	X	Full voltage	24 Vac/Vdc	1NO			<b>10250T860RD</b>	<b>E34EX860RD</b>	
X	0	0		Resistor	120 Vac			1NC	<b>10250T862RD</b>	<b>E34EX862RD</b>
				Transformer	24 Vac				<b>10250T854RD</b>	<b>E34EX854RD</b>
				120 Vac				<b>10250T855RD</b>	<b>E34EX855RD</b>	
X	0	0	Full voltage	24 Vac/Vdc	1NC			<b>10250T871RD</b>	<b>E34EX871RD</b>	
X	X	0		Resistor	120 Vac			1NC	<b>10250T873RD</b>	<b>E34EX873RD</b>
				Transformer	24 Vac				<b>10250T865RD</b>	<b>E34EX865RD</b>
				120 Vac				<b>10250T866RD</b>	<b>E34EX866RD</b>	

**Notes**

- ① Bolded circuit corresponds to "X-0" circuit selection. X = closed circuit, 0 = open circuit.
- ② To order different type or color lens, simply substitute the underlined characters with appropriate suffix code from the Lens and Color Selection table on the bottom of **Page V7-T1-347**. Example: 10250T862**AS**.

UL (NEMA) Type 3, 3R, 4, 4X, 12, 13, NEC Class I Division 2, Groups B, C and D

- Three-position—momentary
- Illuminated

10250T8



E34EX8



### Three-Position Illuminated Momentary Push, Momentary Pull

Operator Function (Position) ①

Momentary— Pull	Maintained— Intermediate	Maintained— Push	Type	Voltage	Contact Type	Mounting Location ①		Red Standard Push-Pull ②		
						1	2	10250T Catalog Number	E34 Catalog Number	
<b>LED Lamp</b>										
0	0	X	Full voltage	24 Vac/Vdc	1NO			<b>10250T886RD24</b>	<b>E34EX886RD24</b>	
X	0	0		120 Vac	1NC			<b>10250T886RD2A</b>	<b>E34EX886RD2A</b>	
				Transformer	24 Vac				<b>10250T876RD06</b>	<b>E34EX876RD06</b>
				120 Vac				<b>10250T877RD06</b>	<b>E34EX877RD06</b>	
X	0	0	Full voltage	24 Vac/Vdc	1NC			<b>10250T897RD24</b>	<b>E34EX897RD24</b>	
X	X	0		120 Vac	1NC			<b>10250T897RD2A</b>	<b>E34EX897RD2A</b>	
				Transformer	24 Vac				<b>10250T887RD06</b>	<b>E34EX887RD06</b>
				120 Vac				<b>10250T888RD06</b>	<b>E34EX888RD06</b>	
<b>Incandescent Lamp</b>										
0	0	X	Full voltage	24 Vac/Vdc	1NO			<b>10250T882RD</b>	<b>E34EX882RD</b>	
X	0	0		Resistor	120 Vac			1NC	<b>10250T884RD</b>	<b>E34EX884RD</b>
				Transformer	24 Vac				<b>10250T876RD</b>	<b>E34EX876RD</b>
				120 Vac				<b>10250T877RD</b>	<b>E34EX877RD</b>	
X	0	0	Full voltage	24 Vac/Vdc	1NC			<b>10250T893RD</b>	<b>E34EX893RD</b>	
X	X	0		Resistor	120 Vac			1NC	<b>10250T895RD</b>	<b>E34EX895RD</b>
				Transformer	24 Vac				<b>10250T887RD</b>	<b>E34EX887RD</b>
				120 Vac				<b>10250T888RD</b>	<b>E34EX888RD</b>	

**Notes**

- ① Bolded circuit corresponds to “X-0” circuit selection. X = closed circuit, 0 = open circuit.
- ② To order different type or color lens, simply substitute the underlined characters with appropriate suffix code from the Lens and Color Selection table on the bottom of **Page V7-T1-347**. Example: 10250T862AS.

#### 1

### Push-Pull Operators

An illuminated push-pull pushbutton unit, arranged for one-hole mounting, can replace two pushbuttons and a pilot light or the non-illuminated form can replace two pushbuttons. These units are available in three basic types:

- **Maintained**—(Two-position). Maintains in the pulled or pushed position until manually actuated to the opposite mode.
- **Momentary**—(Three-position). Spring returns to an intermediate position when pulled or pushed and released.

- **Momentary Pull, Maintained Push**—(Three-position). Spring returns to intermediate position when pulled. Maintains in pushed position until manually returned to intermediate (ready to reset) position. Maintained stop holds circuit open and will prevent other series connected operators from starting the system.

The operators, buttons, contact blocks, etc., are offered as building block components that can be intermixed to satisfy many requirements. This minimizes the need for a varied and costly inventory.

### Application Guide

To assist in the selection of contact blocks, the sketch below shows pictorially by symbols **1** and **2** locations of contact circuits after assembly of contact blocks and adapter to the operator. The table below shows the effect of the push and pull operations on either NO or NC contacts. (X = contact closed, O = contact open).

### Locating Nibs

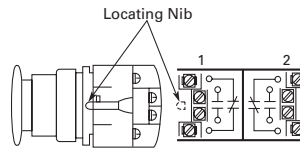

### 10250T\_ Push-Pull Operator Components



### E34G\_



### Operator Position and Circuit Arrangement



Type of Operator	Contact Block	Contact Block Mounting Location				10250T Catalog Number	E34 Catalog Number	
		Out—Pull		Intermediate				In—Push
		1	2	1	2	1	2	
<b>Two-Position Operator without Lens</b>								
Maintained push-pull	1NO	O	O	No intermediate position		10250T5	E34GDB	
	1NC	X	X					O
	2NO	O	O			X	X	
	2NC	X	X			O	O	
<b>Three-Position Operator without Lens</b>								
Momentary push-pull	1NO	O	O	O	O	10250T4	E34GEB	
	1NC	X	X	O	X			O
Maintained push-momentary pull	2NO	O	O	O	O	10250T9	E34GFB	
	2NC	X	X	O	X			O
	Momentary push-pull	1NO	O	O	O	O	10250T10	E34GHB
		1NC	X	X	O	O		
2NO		O	O	O	O	X	X	
2NC		X	X	O	O	O	O	

### Note

Use NEMA 4X 10250T operators where exposed to ultraviolet light.

### Push-Pull Light Units, Lenses and Buttons

NEC Class I Division 2 Groups B, C and D



#### Light Units for Illuminated Push-Pull Devices

Light Unit Type	Type	Voltage	LED/Lamp Number	Catalog Number	
LED (LEDs not included) ①	Full voltage	—	Bayonet base	<b>10250T97HL</b>	
	Transformer AC only 50/60 Hz	24		<b>10250T89HL</b>	
		120		<b>10250T63HL</b>	
		208		<b>10250T64HL</b>	
		240		<b>10250T65HL</b>	
		277		<b>10250T82HL</b>	
		380		<b>10250T66HL</b>	
		480		<b>10250T67HL</b>	
		600		<b>10250T68HL</b>	
		Incandescent		Full voltage AC or DC	6
12	#756		<b>10250T70H</b>		
24/28	#757		<b>10250T79H</b>		
32	#1828		<b>10250T83H</b>		
Resistor	120		120MB		<b>10250T80H</b>
AC or DC	240			<b>10250T81H</b>	
	Transformer AC only 50/60 Hz		24	#755	<b>10250T89H</b>
			120		<b>10250T63H</b>
			208		<b>10250T64H</b>
			240		<b>10250T65H</b>
277				<b>10250T82H</b>	
380			<b>10250T66H</b>		
480			<b>10250T67H</b>		
600			<b>10250T68H</b>		



**Note**

① These units do not include lamps. Order LED separately to match lens color from table on [Page V7-T1-353](#).

## Alternate Lenses for Illuminated Push-Pull Devices

	Color	10250T Catalog Number	E34 Catalog Number
<b>Standard</b> 	<b>Standard</b>		
	Red	10250TC47	E34M2
	Red (EMERG. STOP)	10250TC53	E34M2N8
	Green	10250TC48	E34M3
	Blue	10250TC49	E34M6
	Amber	10250TC50	E34M9
	White	10250TC51	E34M5
Clear	10250TC52	E34M0	
<b>Side-Lighted (Anodized) Aluminum</b> 	<b>Side-Lighted Anodized Aluminum Ring</b>		
	Red	10250TC57	—
	Red (EMERG. STOP)	10250TC63	—
	Green	10250TC58	—
	Blue	10250TC59	—
	Amber	10250TC64	—
	Yellow	10250TC60	—
	White	10250TC61	—
	Clear	10250TC62	—
<b>HD Aluminum with Transparent Center</b> 	<b>Heavy-Duty Aluminum with Transparent Center</b>		
	Red	10250TC65	—
	Green	10250TC66	—
Amber	10250TC67	—	

## Buttons for Non-Illuminated Push-Pull Devices

	Color	10250T Catalog Number	E34 Catalog Number
<b>Standard</b> 	<b>Standard</b>		
	Red	10250TB62	E34C2
	Red (EMERG. STOP)	10250TB63	E34C2N8
	Green	10250TB61	E34C3
	Black	10250TB60	E34C1
Blue	10250TB64	E34C6	
<b>Jumbo Mushroom Head</b> 	<b>Jumbo Mushroom Head (Anodized) Aluminum</b> <sup>①</sup>		
	Red	10250TJ62	E34J2
	Red (EMERG. STOP)	10250TJ63	E34J2N8
	Green	10250TJ61	—
	Black	10250TJ60	—
Yellow	10250TJ64	—	

**Notes**

Use NEMA 4X 10250T operators where exposed to ultraviolet light.

① Anodized aluminum head is not suitable for use with ultraviolet light applications.

**Standard LED Lamp**



**LED Selection**

Voltage	Color	Catalog Number	Voltage	Color	Catalog Number
6 Vac/Vdc suitable for use with transformers	Red	E22LED006RN	60 Vac/Vdc	Red	E22LED060RN
	Orange	E22LED006ON		Orange	E22LED060ON
	Yellow	E22LED006YN		Yellow	E22LED060YN
	Green	E22LED006GN		Green	E22LED060GN
	Blue	E22LED006BN		Blue	E22LED060BN
	White	E22LED006WN		White	E22LED060WN
12 Vac/Vdc	Red	E22LED012RN	120 Vac	Red	E22LED120RA
	Orange	E22LED012ON		Orange	E22LED120OA
	Yellow	E22LED012YN		Yellow	E22LED120YA
	Green	E22LED012GN		Green	E22LED120GA
	Blue	E22LED012BN		Blue	E22LED120BA
	White	E22LED012WN		White	E22LED120WA
24 Vac/Vdc	Red	E22LED024RN	120 Vdc	Red	E22LED120RD
	Orange	E22LED024ON		Orange	E22LED120OD
	Yellow	E22LED024YN		Yellow	E22LED120YD
	Green	E22LED024GN		Green	E22LED120GD
	Blue	E22LED024BN		Blue	E22LED120BD
	White	E22LED024WN		White	E22LED120WD
48 Vac/Vdc	Red	E22LED048RN			
	Orange	E22LED048ON			
	Yellow	E22LED048YN			
	Green	E22LED048GN			
	Blue	E22LED048BN			
	White	E22LED048WN			

**Note**

For a complete listing of all LEDs available, see **Page V7-T1-249**.

#### 1

#### Selector Switch Units

UL (NEMA) Type 3, 3R, 4, 4X, 12, 13, NEC Class I Division 2, Groups B, C and D

- Two- and three-position
- Non-illuminated

#### 10250T72\_



#### E34EX72\_



#### Two-Position Selector Switch—Non-Illuminated

Operator Position <sup>①</sup>		Operator Action <sup>②</sup>	Contact Type	Mounting Location <sup>①</sup>		Cam Code	Black Knob—Selector Switch <sup>③</sup>	
				1	2		10250T Catalog Number	E34 Catalog Number
X	O		1NC 1NO			1	<b>10250T722BK</b>	<b>E34EX722BK</b>
O	X						<b>10250T724BK</b>	<b>E34EX724BK</b>
X	O		1NC 1NC 1NO			1	<b>10250T723BK</b>	<b>E34EX723BK</b>
O	X						<b>10250T725BK</b>	<b>E34EX725BK</b>

#### 10250T\_



#### Three-Position Selector Switch—Non-Illuminated

Operator Position <sup>①</sup>			Operator Action <sup>②</sup>	Contact Type	Mounting Location <sup>①</sup>		Cam Code	Black Knob—Selector Switch <sup>④</sup>	
					1	2		10250T Catalog Number	E34 Catalog Number
X	O	O		1NO 1NO			3	<b>10250T726BK</b>	<b>E34EX726BK</b>
O	O	X						<b>10250T728BK</b>	<b>E34EX728BK</b>
								<b>10250T730BK</b>	<b>E34EX730BK</b>
								<b>10250T732BK</b>	<b>E34EX732BK</b>
X	O	O		1NO 1NC-1NC (Series) 1NO			3	<b>10250T727BK</b>	<b>E34EX727BK</b>
O	X	O						<b>10250T729BK</b>	<b>E34EX729BK</b>
O	O	X						<b>10250T731BK</b>	<b>E34EX731BK</b>
								<b>10250T733BK</b>	<b>E34EX733BK</b>

#### Notes

- ① Bolded circuit corresponds to "X-O" circuit selection. X = closed circuit, O = open circuit.
- ② M = Maintained. S = Spring return in direction of arrow (→).
- ③ To order different type or color selector switch, simply substitute the underlined characters with appropriate suffix code from the table on **Page V7-T1-355**.  
Example: 10250T722LL. For keyed selector switch, substitute the underlined characters with **T\_ (cam)+\_ (key removal position)**. Example: 10250T722T13.
- ④ To order different type or color selector switch, simply substitute the underlined characters with appropriate suffix code from the Switch and Color Selection table on **Page V7-T1-355**.  
Example: 10250T726LL. For keyed selector switch, substitute the underlined characters with **T\_ (cam)+\_ (key removal position)**. Example: 10250T726T13.

UL (NEMA) Type 3, 3R, 4, 4X, 12, 13, NEC Class I Division 2, Groups B, C and D

- Four-position maintained
- Non-illuminated

10250T743

### Four-Position Selector Switch—Non-Illuminated



E34EX743



#### Operator Position ①

X	0	0	0
0	X	0	0
0	0	X	0
0	0	0	X



Contact Type

1NC
1NO
1NO
1NC

#### Mounting Location ①

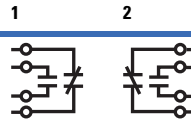

Cam Code

7
---

#### Black Knob—Selector Switch ③

10250T Catalog Number	E34 Catalog Number
10250T743BK	E34EX743BK

### Knob



### Lever



### Coin Slot ⑤



### Switch and Color Selection

Color	Knob Suffix Code	Lever Suffix Code	Lever ④ Suffix Code	Coin Slot ⑤ Suffix Code
Black	<b>BK</b>	<b>BL</b>	<b>BA</b>	<b>BC</b>
Red	<b>RK</b>	<b>RL</b>	<b>RA</b>	<b>RC</b>
Green	<b>GK</b>	<b>GL</b>	<b>GA</b>	<b>GC</b>
Yellow	<b>YK</b>	<b>YL</b>	<b>YA</b>	<b>YC</b>
White	<b>WK</b>	<b>WL</b>	<b>WA</b>	<b>WC</b>
Gray	<b>AK</b>	<b>AL</b>	<b>AA</b>	<b>AC</b>
Blue	<b>LK</b>	<b>LL</b>	<b>LA</b>	<b>LC</b>
Orange	<b>NK</b>	<b>NL</b>	<b>NA</b>	<b>NC</b>

### Key Operated Selection

Number of Position	Operator Action ⑥	Suffix and Removal Position
2	M M	T1 + 1, 2, 3
	M ← S	T1 + 2
3	M M M	T3 + 1–7
	S → M M	T3 + 1, 4, 5
	S → M ← S	T3 + 4
	M M ← S	T3 + 2, 4, 6
4	MMMM	T7 + 7

### Key Removal Positions ⑦

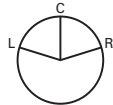

Code Suffix	Key Removal Position
<b>1</b>	Right only
<b>2</b>	Left only
<b>3</b>	Right and left
<b>4</b>	Center only
<b>6</b>	Left and center
<b>7</b>	All positions

### Notes

- ① Bolded circuit corresponds to "X-0" circuit selection. X = closed circuit, 0 = open circuit.
- ② M = Maintained.
- ③ To order different type or color selector switch, simply substitute the underlined characters with appropriate suffix code from the Switch and Color Selection table above. Example: 10250T743LL. For keyed selector switch, substitute the underlined characters with **T\_ (cam) + \_ (key removal position)**. Example: 10250T7431ZL.
- ④ Designed for added ingress protection. For use in maintained operators only.
- ⑤ 10250T only.
- ⑥ M = Maintained. S = Spring return in direction of arrow (→).
- ⑦ Key removal in "spring return from" positions not recommended.



#### 1

### Selector Switch Selection



10250T



E34

#### Cam and Contact Block Selection

Selector switches in their varied forms (two-position, three-position, and four-position) are a big factor contributing to the great flexibility of control that a well rounded line of “pushbuttons” can achieve. Because of their flexibility, they tend to cause difficulty with product selection and application. The following systematic approach should simplify that task.

Cam and contact block selection is better understood if you:

- Work with each incoming and outgoing wire/circuit separately.
- Recognize the terms NO and NC only identify the type of contact by its mode before mounting to the operator. The “X-O” table (Page V7-T1-358) shows how that contact will act after assembly to the operator with the selected cam shape. X = closed circuit, O = open circuit.

- One NO-NC contact block may be mounted behind each plunger of the mounting adapter for a total of four circuits.
- Each cam has two separate lobes, each of which operates one of the two contact block plungers independently of each other. Those are identified as position 1 (locating nib side) and position 2 (opposite of locating nib). The position designations give direction in selecting and mounting of the contact blocks.

#### Contact Circuit Locations

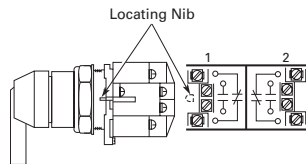

#### Systematic Approach

Application: **HAND-OFF-AUTO** selector switch. In this circuit, one incoming line is distributed to two other outgoing circuits by the switch. The two circuits can be looked at individually.

#### Step 1: Elementary Diagram.

Construct on paper, or in your mind, a simple elementary diagram of the switching scheme as follows:

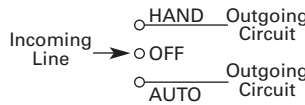

In this circuit, you want a contact closed on the left (HAND) but open in the center and right.

For the **AUTO** circuit, the “X-O” diagram would look like this:

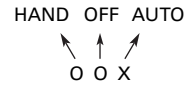

Putting them together, the complete “X-O” diagram is:



#### Step 2: “X-O” Pattern.

From the elementary diagram, you can construct an “X-O” diagram which describes when the contacts are to be closed (X) or open (O) in the various positions of the switch. The “X-O” for the **HAND** circuit looks like this:

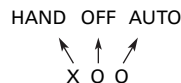

Once the “X-O” diagram has been generated, the next step is to select the cam and contact block, or blocks, needed to perform the desired “X-O” functions. The selection tables on the following pages list the various types (shapes) of cams by number to choose from and the type of contact and position to achieve the function outlined in your “X-O” diagram.

### Step 3: Cam Selection.

The cam you select determines the operation of all contact blocks mounted to the operator. It is selected on the basis that it provides the simplest circuitry for the desired "X-O" diagram. The selection tables show all the "X-O" combinations. For the purpose of this example, the applicable portion of those tables is shown on this page.

Now to make the cam selection, make a simple worksheet such as below. (1) or (2) = mounting location from chart above:

	Cam 2	Cam 3
X O O	(1)NO-(2)NC ①	(1)NO
O O X	(2)NO	(2)NO

It becomes obvious that cam 3 is the better choice because the series connection can be avoided, making it simpler to wire.

### Step 4: Contact Block Selection.

Having selected the cam, contact block selection is simply a matter of determining if you require one NO-NC contact block (Cat. No 10250T1H) or two. Given the limitations of the factory sealed contact block and the desired "X-O" application, you may have circuits that will not be needed—as seen here with the two additional NC circuits. (1) or (2) = mounting location from chart above.

Qty	Catalog No.	Cam 3
2	10250TIH	(1)NO (2)NC (1)NC (2)NO

### Step 5: Selector Switch Operator.

Lastly, you have to choose from the many types of operators—knob and lever in various colors or keyed. Also what combinations of maintained and spring return functions are required. Selection of these operators can be found on **Page V7-T1-359**. For the example in step 4, you may want a three-position maintained black knob, cam 3—Catalog Number 10250T1323 (or 34VHBK1).

**The Complete Switch:** 10250T1323 (or 34VHBK1) with two 10250T1H or for one composite catalog number—10250T726BK (or E34EX726BK) found on **Page V7-T1-354**.

### Diagrams

Circuits shown illustrate connections to obtain a selector circuit combination and are shown with their appropriate line diagrams in **BOLD**. Field wiring of jumper connections required as shown.

X = Closed circuit  
O = Open circuit

### Example Selection Table

No.	Desired Circuit and Operator Position			Cam Code #2 Contact Blocks and Mounting Location		Cam Code #3 Contact Blocks and Mounting Location	
				1	2	1	2
1	X	O	O				—
4	O	O	X	—		—	

**Note**  
① Wired in series.

# 1.11

## Pushbuttons and Indicating Lights

30.5 mm Class I Division 2 Hazardous Locations—10250T/E34

1

### Two-Position Selector Switch

Number	Desired Circuit and Operator Position		Cam Code #1 Contact Blocks and Mounting Location	
			1	2
1	X	0		
			NC	NC
2	0	X		
			NO	NO

### Three-Position Selector Switch

No.	Desired Circuit and Operator Position			Cam Code #2 Contact Blocks and Mounting Location		Cam Code #3 Contact Blocks and Mounting Location	
				1	2	1	2
1	X	0	0				—
				NO (Series)	NC	NO	
2	X	X	0	—		—	
					NC		NC
3	X	0	X		—		
				NO		NO (Parallel)	NO
4	0	0	X	—		—	
					NO		NO
5	0	X	X				—
				NC (Parallel)	NO	NC	
6	0	X	0	—			
					NO (Parallel)	NO	
7	0	0	X				
				NO (Parallel)	NC	NO (Parallel)	NC
8	X	X	0				
				NC (Parallel)	NO	NC (Parallel)	NO
9	0	X	0		—	—	
				NC			NO/NC (Parallel)
10	X	0	X				—
				NO/NC (Parallel)	NO/NC (Parallel)	NO/NC (Parallel)	

### Four-Position Selector Switch

Number	Desired Circuit and Operator Position				Cam Code #7 Contact Blocks and Mounting Location	
					1	2
1	X	0	0	0		—
					NC	
2	0	X	0	0	—	
						NO
3	0	0	X	0		—
					NO	
4	0	0	0	X	—	
						NC
5	X	0	0	X		
					NC (Parallel)	NC
6	0	X	X	0		
					NO (Parallel)	NO
7	0	0	X	X		
					NO (Parallel)	NC
8	X	X	0	0		
					NC (Parallel)	NO
9	0	X	0	X	—	
						NO/NC (Parallel)
10	X	0	X	0		—
					NO/NC (Parallel)	

### Selector Switch Operators

#### 10250T Selector Switch Operators with Caps

UL (NEMA) Type 3, 3R, 4, 4X, 12, 13

##### Black Knob Selector Switch



##### Black Lever Selector Switch



#### 10250T Selector Switch Operators with Caps

Positions	Operator Action <sup>①</sup>	Black Knob Selector Switch— Vertical Mounting <sup>②</sup>		Black Lever Selector Switch— Vertical Mounting <sup>②</sup>	
		Cam Code <sup>③</sup>	Catalog Number	Cam Code <sup>③</sup>	Catalog Number
Two-position—60° throw		1	10250T1311	1	10250T3011
		1	10250T1371	1	10250T3071
Three-position—60° throw		2	10250T1322	2	10250T3022
		3	10250T1323	3	10250T3023
		2	10250T1332	2	10250T3032
		3	10250T1333	3	10250T3033
		2	10250T1342	2	10250T3042
		3	10250T1343	3	10250T3043
Four-position—40° throw		2	10250T1352	2	10250T3052
		3	10250T1353	3	10250T3053
Four-position—40° throw		7	10250T1367	7	10250T3067

##### Horizontal Mounting



#### 10250T Key Operators with Cam

Positions	Operator Action <sup>①</sup>	Cam Code <sup>③</sup>	Optional Key Removal Positions <sup>④</sup>	Vertical Mounting Catalog Number <sup>④</sup>	Horizontal Mounting Catalog Number <sup>④</sup>
Two-position—60° throw		1	1, 2, 3	10250T1511_	10250T1611_
		1	2	10250T1571_	10250T1581_
Three-position—60° throw		2	1-7	10250T1522_	10250T1622_
		3		10250T1523_	10250T1623_
		2	1, 4, 5	10250T1532_	10250T1632_
		3		10250T1533_	10250T1633_
		2	4	10250T1542_	10250T1642_
		3		10250T1543_	10250T1643_
Four-position—40° throw		2	2, 4, 6	10250T1652_	10250T1662_
		3		10250T1653_	10250T1663_
Four-position—40° throw		7	7	10250T1677_	10250T1687_

##### Key Removal Positions

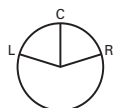

#### Key Removal Positions <sup>⑤</sup>

Code Suffix	Key Removal Position	Code Suffix	Key Removal Position
1	Right only	5	Right and center
2	Left only	6	Left and center
3	Right and left	7	All positions
4	Center only		

##### Notes

- ① M = Maintained. S = Spring return in direction of arrow (→).
- ② Field convertible to horizontal mounting or order operator only and separate operator cap.
- ③ For selection of the proper cam and contact block to obtain the proper circuit sequence, see selection instructions and table on **Pages V7-T1-356 to V7-T1-358**.
- ④ Choose key removal position required for application from table above. Add key removal code no. to listed catalog number. Example: 10250T15112.
- ⑤ Key removal in “spring return from” positions not recommended.

#### Replacement Keys or Dissimilar Locks for Above Key Operators

Listed operators have identical locks and keys (Key Code H661) Catalog Number 10250ED824.

#### Replacement Keys

Description	Catalog Number
Replacement keys (code H661)	10250ED824

1

UL (NEMA) Type 3, 3R, 4, 4X, 12, 13

**Black Knob Selector Switch**



**E34 Selector Switch Operators with Knob Assembled**

**Black Knob Selector Switch—  
Vertical Mounting <sup>②</sup>**

Positions	Operator Action <sup>①</sup>	Cam Code <sup>③</sup>	Catalog Number <sup>④</sup>
Two-position—60° throw		1	<b>E34VFBK1</b>
		1	<b>E34VEBK1</b>
Three-position—60° throw		2	<b>E34VGBK1</b>
		3	<b>E34VHBK1</b>
		2	<b>E34VJBK1</b>
		3	<b>E34VKBK1</b>
		2	<b>E34VLBK1</b>
		3	<b>E34VMBK1</b>
Four-position—40° throw		2	<b>E34VNBK1</b>
		3	<b>E34VPBK1</b>
		7	<b>E34VTBK1</b>

**E34KFB\_**



**E34 Key Operators with Cam and Cap**

Positions	Operator Action <sup>①</sup>	Cam Code <sup>③</sup>	Key Removal Positions <sup>⑤</sup>	Vertical Mounting Catalog Number	Horizontal Mounting Catalog Number
Two-position—60° throw		1	1, 2, 3	<b>E34KFB_</b>	<b>E34KFHB_</b>
		1	2	<b>E34KEB_</b>	<b>E34KEHB_</b>
Three-position—60° throw		2	1–7	<b>E34KGB_</b>	<b>E34KGHB_</b>
		3		<b>E34KHB_</b>	<b>E34KHGB_</b>
		2	1, 4, 5	<b>E34KJB_</b>	<b>E34KJHB_</b>
		3		<b>E34KKB_</b>	<b>E34KKHB_</b>
		2	4	<b>E34KLB_</b>	<b>E34KLHB_</b>
		3		<b>E34KMB_</b>	<b>E34KMHB_</b>
Four-position—40° throw		2	2, 4, 6	<b>E34KNB_</b>	<b>E34KNHB_</b>
		3		<b>E34KPB_</b>	<b>E34KPHB_</b>
		7	7	<b>E34KTB_</b>	<b>E34KTHB_</b>

**Notes**

Use NEMA 4X 10250T operators where exposed to ultraviolet light, see **Page V7-T1-359**.

① M = Maintained. S = Spring return in direction of arrow (→).

② Field convertible to horizontal mounting.

③ For selection of the proper cam and contact block to obtain the proper circuit sequence, see selection instructions and table on **Pages V7-T1-356 to V7-T1-358**.

④ For other colors of either knob or lever, replace the underlined characters of the catalog number with the appropriate suffix code from Alternate Knobs and Levers table on **Page V7-T1-361**. Example: E34VFBL2.

⑤ Choose key removal position required for application from table on **Page V7-T1-361**. Add key removal code no. to listed catalog number. Example: E34KFB2.

### Key Removal Positions

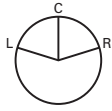

### Key Removal Positions

Code Suffix	Key Removal Position	Code Suffix	Key Removal Position
1	Right only	5	Right and center
2	Left only	6	Left and center
3	Right and left	7	All positions
4	Center only		

### Knob



### Lever



### Lever for Added Ingress Protection



### Alternate Knobs and Levers for Operators ①

Color	Knob		Lever		Lever Designed for Added Ingress Protection ②	
	Suffix Code	Catalog Number	Suffix Code	Catalog Number	Suffix Code	Catalog Number
Black	K1	E34K1	L1	E34L1	A1	E34A1
Red	K2	E34K2	L2	E34L2	A2	E34A2
Green	K3	E34K3	L3	E34L3	A3	E34A3
Yellow	K4	E34K4	L4	E34L4	A4	E34A4
White	K5	E34K5	L5	E34L5	A5	E34A5
Blue	K6	E34K6	L6	E34L6	A6	E34A6
Gray	K7	E34K7	L7	E34L7	A7	E34A7
Orange	K8	E34K8	L8	E34L8	A8	E34A8

#### Notes

- ① Key removal in “spring return from” positions not recommended.
- ② For use on maintained operators only.

# 1

## Illuminated Selector Switch Operators

Two-Position Maint. Selector Switch



### 10250T Illuminated Selector Switch Operator Only without Knob or Lever

Position	Operator Action ①	Transformer Type—50/60 Hz 6V #755 Lamp			Full Voltage Type—AC or DC ④		
		Cam Code ③	Voltage	Catalog and Code Number ②	Cam Code ③	Voltage	Catalog and Code Number ②
Two-position—60° throw		1	24	10250T5961H	1	6	10250T6201H
			120	10250T5971H		12	10250T6211H
			208	10250T6511H		24	10250T6221H
			240	10250T5981H		48	10250T6231H
			380	10250T5991H		120	10250T6361H
			480	10250T6001H		240 ⑤	10250T6371H
			600	10250T6011H			
Three-position—60° throw		+ 2 or 3	24	10250T602_H	+ 2 or 3	6	10250T624_H
			120	10250T603_H		12	10250T625_H
			208	10250T652_H		24	10250T626_H
			240	10250T604_H		48	10250T627_H
			380	10250T605_H		120	10250T638_H
			480	10250T607_H		240 ⑤	10250T639_H
			600	10250T607_H			
		+ 2 or 3	120	10250T620_H	+ 2 or 3	120	10250T622_H
			240	10250T656_H			
		+ 2 or 3	120	10250T621_H	+ 2 or 3	120	10250T623_H
			240	10250T662_H			
		+ 2 or 3	24	10250T614_H	+ 2 or 3	6	10250T628_H
			120	10250T615_H		12	10250T629_H
208			10250T653_H	24		10250T630_H	
240			10250T616_H	48		10250T631_H	
380			10250T617_H	120		10250T640_H	
480			10250T618_H	240 ⑤		10250T641_H	
600			10250T619_H				
Four-position—40° throw		7	24	10250T6087H	7	6	10250T6327H
			120	10250T6097H		12	10250T6337H
			208	10250T6547H		24	10250T6347H
			240	10250T6107H		48	10250T6357H
			380	10250T6117H		120	10250T6427H
			480	10250T6127H		240 ⑤	10250T6437H
			600	10250T6137H			

### Knob



### Lever



### Knobs and Levers

Color ⑥	Knob Catalog and Code Number	Lever Catalog and Code Number	Color ⑥	Knob Catalog and Code Number	Lever Catalog and Code Number
Red	10250TER	10250TFR	Clear	10250TEC	10250TFC
Green	10250TEG	10250TFG	White	10250TEW	10250TFW
Yellow	10250TEA	10250TFA	Amber	10250TEM	10250TFM
Blue	10250TEL	10250TFL			

#### Notes

- ① M = Maintained. S = Spring return in direction of arrow (→).
- ② For selection of the proper cam and contact block, to obtain the proper circuit sequence, see selection table on [Page V7-T1-358](#).
- ③ Operator includes lens gasket and lens attachment screws.
- ④ Full voltage light units can be used at other than listed voltages by changing lamp. Replacement lamps are listed on [Page V7-T1-249](#).
- ⑤ Resistor type. May generate excess heat if used in high density.
- ⑥ Amber, clear and white lenses have a black arrow (pointer), red, green and blue lenses have a white arrow (pointer).

**120 Vac Transformer Selector Switch, Cam 1**



### Illuminated Selector Switch Operator Only without Knob or Lever

Positions	Operator Action	Transformer Type—50/60 Hz 6V #755 Lamp Catalog Number <sup>①②</sup>		Full Voltage Type—AC or DC <sup>③</sup> Lamps—#755, #757, #1835, 120MB <sup>④</sup> Catalog Number <sup>②</sup>			
		Cam Code 1 <sup>⑤</sup>	Cam Code 2 <sup>⑤</sup>	Cam Code 3 <sup>⑤</sup>	Cam Code 1 <sup>⑤</sup>	Cam Code 2 <sup>⑤</sup>	Cam Code 3 <sup>⑤</sup>
Two-position—60° throw		E34VFB_H		E34SFB_H			
Three-position—60° throw		E34VGB_H	E34VHB_H	E34SGB_H	E34SHB_H		
		E34VNB_H <sup>⑥</sup>	E34VPB_H <sup>⑥</sup>	E34SNB_H <sup>⑦</sup>	E34SPB_H <sup>⑦</sup>		
		E34VJB_H <sup>⑥</sup>	E34VKB_H <sup>⑥</sup>	E34SJB_H <sup>⑦</sup>	E34SKB_H <sup>⑦</sup>		
		E34VLB_H	E34VMB_H	E34SLB_H	E34SMB_H		
Four-position—40° throw		E34VRB_H	—	E34SRB_H	—		

#### Knob



#### Lever



#### Knobs and Levers

Color <sup>④</sup>	Knob Catalog Number and Code Number	Lever Catalog Number and Code Number
Red	10250TER	10250TFR
Green	10250TEG	10250TFG
Yellow	10250TEA	10250TFA
Blue	10250TEL	10250TFL
Clear	10250TEC	10250TFC
White	10250TEW	10250TFW
Amber	10250TEM	10250TFM

#### Light Unit Voltage Suffix

Add to operator catalog number listed in table above.

Type of Light Unit		Full Voltage Type AC or DC <sup>③</sup>	
Transformer Type 50/60 Hz	Suffix Code	Voltage	Suffix Code
24	024	6	06
120	120	12	12
208	208	24	24
240	240	48	48
380	380	120	120
480	480	240 <sup>⑥</sup>	240
600	600		

#### Notes

Use NEMA 4X 10250T operators where exposed to ultraviolet light, see **Page V7-T1-362**.

- ① Operator includes lens gasket and lens attachment screws.
- ② Replace underscore with proper voltage suffix code from Light Unit Voltage Suffix table above. Example: three-position maintained with 120V transformer type light unit: E34VGB120H.
- ③ Full voltage light units can be used at other than listed voltages by changing lamp. Replacement lamps are listed on **Page V7-T1-249**.
- ④ 120MB lamps are used on both 120V and 240V operators.
- ⑤ For selection of the proper cam and contact block required to obtain a specific circuit sequence, see selection table on **Page V7-T1-358**.
- ⑥ 120 and 240V transformer only.
- ⑦ 120 full voltage only.
- ⑧ Resistor type. May generate excess heat if used in high density.
- ⑨ Amber, clear and white lenses have a black arrow (pointer). Red, green and blue lenses have a white arrow (pointer).



## 1

**Options****Contact Blocks and Mounting Adapters**

NEC Class I Division 2, Groups B, C and D

**Contact Block****Contact Block**

Description	Catalog Number
Class I Division 2 factory sealed contact block with 1NO-1NC	<b>10250T1H</b>

**Dimensions**, see **Page V7-T1-369**.

**Mounting Adapter****Mounting Adapter**

Description	Catalog Number
Mounting adapter for pushbuttons	<b>10250TD2</b>
Mounting adapter for selector switches	<b>10250TD3</b>

**Dimensions**, see **Page V7-T1-369**.

**Mounting Adapters with Contact Block(s)—Overpacked**

Description	Catalog Number
Pushbutton adapter with 1NO-1NC	<b>10250TD21H</b>
Pushbutton adapter with 2 (1NO-1NC)	<b>10250TD21H1H</b>
Selector switch adapter with 1NO-1NC	<b>10250TD31H</b>
Selector switch adapter with 2 (1NO-1NC)	<b>10250TD31H1H</b>

### Mounting and Assembly

#### Panel Thickness

- Minimum: 0.06 in (1.6 mm)
- Maximum: 0.25 in (8 mm) including legend plate
- Maximum can be increased to 0.375 in (15.9 mm) using optional retaining nut
  - Indicating light: 10250TA30/E34TA30
  - Pushbutton/selector switch: 10250TA31/E34TA31

#### Mounting Matrix

Legend Plate	Dimensions in Inches (mm)			
	A	B	C	D
Small	2.87 (72.6)	2.25 (57.2)	2.25 (57.2)	2.87 (72.6)
Jumbo	2.87 (72.6)	2.32 (58.6)	2.32 (58.6)	2.87 (72.6)
Extra large	2.87 (72.6)	2.56 (65.2)	2.52 (64.1)	2.87 (72.6)

#### Panel Spacing and Drilling

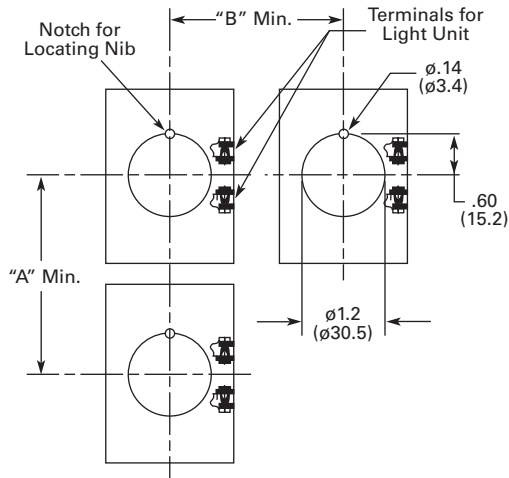

Drilling for One Hole Mounting and Dimensions for Minimum Spacing in Vertical Rows.

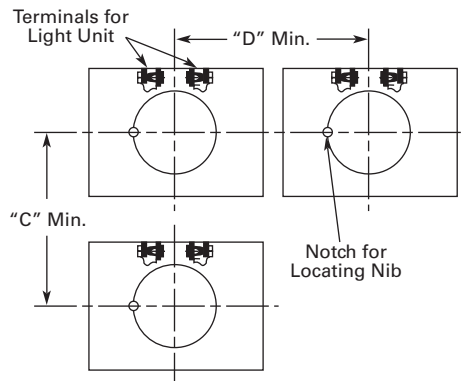

Drilling for One Hole Mounting and Dimensions for Minimum Spacing in Horizontal Rows.

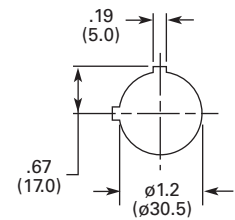

NOTE: Suitable for Use in This Alternate Mounting Hole.

#### Operator Assembly

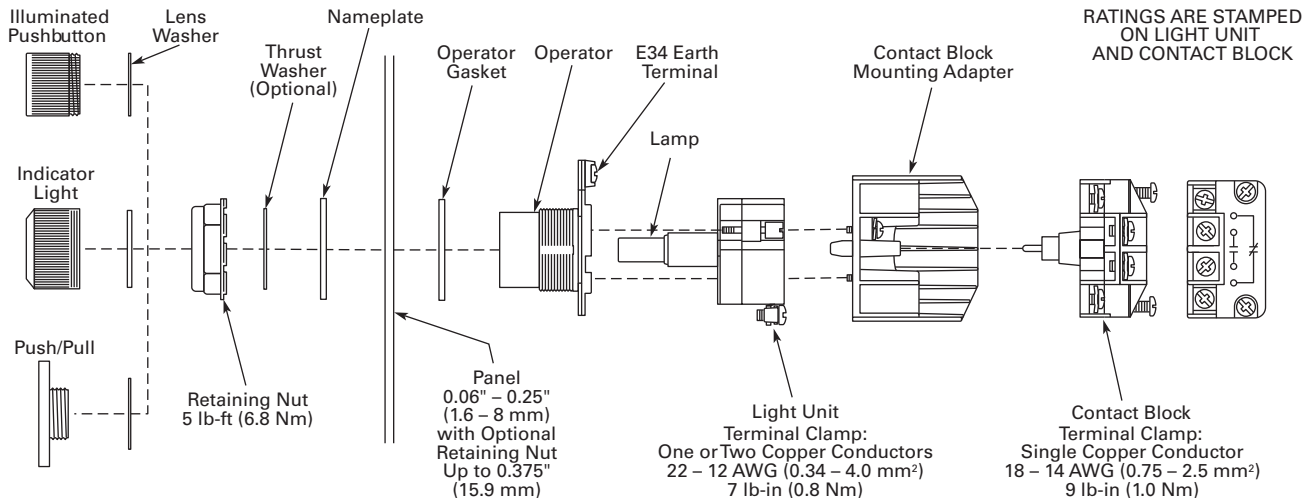



RATINGS ARE STAMPED ON LIGHT UNIT AND CONTACT BLOCK

# 1

## Enclosures

### Die Cast, Polyester and Stainless Steel Enclosures

#### Enclosures (Case and Cover)—Surface Mounting <sup>①</sup>

	Number of Elements	10250T Catalog Number	E34 Catalog Number
<b>Die Cast Enclosure</b>	<b>Die Cast Enclosure—Deep Cover—In-Line NEMA 4, 4X, 12, 13</b>		
	1	10250TN11	E34N11
	2	10250TN12	E34N12
	3	10250TN13	E34N13
	4	10250TN14	E34N14
<b>Polyester Enclosure</b>	<b>Polyester—In-Line NEMA 3, 4X, 12</b>		
	1	—	E34N51
	2	—	E34N52
	3	—	E34N53
	4	—	E34N54
<b>Stainless Steel Enclosure</b>	<b>Stainless Steel <sup>②</sup>—In-Line NEMA 4, 4X, 12</b>		
	1	—	10250TN33
	2	—	10250TN34
	3	—	10250TN35
	4	—	10250TN36

**Dimensions**, see Page V7-T1-369.

#### Notes

- <sup>①</sup> For spacing increments, see Page V7-T1-244.
- <sup>②</sup> 14 gauge, type 304.

#### Application Notes:

1. Operators need to be mounted in their horizontal orientation for all enclosures. For die cast enclosures remove locating nib on operators and use thrust washer (Catalog Number 10250TK3).
2. Polyester enclosures must be used when mounting illuminated operators.

#### Enclosure Layouts

Top – For Vertical Mounting

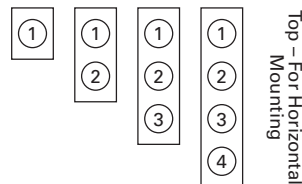

Top – For Horizontal Mounting

## Technical Data and Specifications

### Mechanical Ratings

Description	Specification
<b>Frequency of Operation</b>	
All pushbuttons	6000 operations/hr.
Key and lever selector switches	3000 operations/hr.
<b>Life</b>	
Pushbuttons	10 x 10 <sup>6</sup> operations
Contact block	10 x 10 <sup>6</sup> operations
Key and lever selector switches	0.25 x 10 <sup>6</sup> operations
<b>Shock Resistance</b>	
Duration/force	20 ms ≥5g

### Climatic Conditions

Description	Specification
Operating temperature	32° to 140°F (0° to 66°C)
Storage temperature	-40° to 176°F (-40° to 80°C)
Altitude	6,562 ft (2,000m)
Humidity	Max. 95% RH at 60°C

### Terminals

Description	Specification
<b>Light Units</b>	
Clamps	Terminals are saddle clamp type for 1 x 22 AWG (0.34 mm <sup>2</sup> ) to 2 x 14 AWG (4.0 mm <sup>2</sup> ) conductors
Torque	7 lb-in (0.8 Nm)
Degree of protection against direct electrical contact	IP2X with fingerproof shroud
<b>Contact Blocks</b>	
Clamps	Terminals are stainless steel saddle clamp type for 1 x 18–14 AWG (0.75–2.5 mm <sup>2</sup> ) solid or stranded copper conductor
Torque	9 lb-in (1.0 Nm) with size 2 Phillips screwdriver
Degree of protection against direct electrical contact	IP2X with fingerproof shroud

### Electrical Ratings

Description	Specification
<b>Light Units</b>	
Bulbs—average life:	
Transformer type	20,000 hrs.
Resistor/direct voltage type	2500 hrs. minimum at rated voltage
LED	60,000 to 100,000 hrs.

**Electrical Ratings—Contact Block****Meet or Exceed NEMA Contact Rating Designations A600 and Q300**

Description	A600 (AC)				Q300 (DC)	
	120V	240V	480V	600V	125V	250V
Make and emerg. interrupting capacity (amps)	60	30	15	12	0.55	0.27
Normal load break (amps)	6	3	1.5	1.2	0.55	0.27
Thermal current (amps)	10	10	10	10	2.5	2.5
Voltamperes:						
Maximum make	7200	7200	7200	7200	69	69
Maximum break	720	720	720	720	69	69

**Temperature Codes**

All illuminated devices have operating temperatures below 100°C except for the following catalog numbers with temperature codes per NEC table 500.5(d) and UL 1604:

10250T	E34	Temp. Code
10250T201H	E34RB120H	T3C
10250T202H	E34RB240H	T3A
10250T471H	E34SB120H	TC3
10250T472H	E34SB240H	T3B
10250T80H	—	T3C
10250T81H	—	T3B
All selector switches w/120 MB lamp		T3C
All illuminated devices with lamp 1835		T4A

**Note:** For additional technical information, see Publication Number **TD.74.T.E.04**.

### Dimensions

Approximate Dimensions in Inches (mm)

#### Surface Mounting

##### Die Cast, Polyester and Stainless Steel Enclosures

4 Mtg. Holes — 10-32 Screw Size for  
1 – 4 Element Die Cast/  
Stainless Steel Enclosure  
7/32 Screw Size for  
Polyester

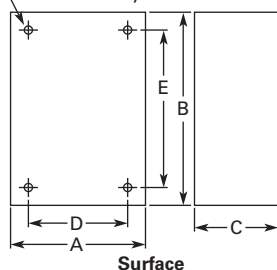

Number of Elements	Element Arrangement	Wide A	High B	Deep C	Mounting D	E	Conduit Entrance
<b>Die Cast</b>							
1	In-line	3.88 (98.6)	4.00 (101.6)	3.00 (76.3)	2.69 (68.3)	3.25 (82.6)	3/4
2		3.88 (98.6)	5.88 (149.4)	3.00 (76.3)	2.69 (68.3)	5.13 (130.3)	
3		3.88 (98.6)	7.75 (196.9)	3.00 (76.3)	2.69 (68.3)	7.00 (177.8)	1
4		3.88 (98.6)	9.63 (244.6)	3.00 (76.3)	2.69 (68.3)	8.88 (225.6)	
<b>Polyester</b>							
1	In-line	3.81 (96.8)	6.63 (168.4)	3.38 (85.9)	2.94 (74.7)	4.88 (124.0)	①
2		3.81 (96.8)	6.63 (168.4)	3.38 (85.9)	2.94 (74.7)	4.88 (124.0)	
3		3.81 (96.8)	8.88 (225.6)	3.38 (85.9)	2.94 (74.7)	7.13 (181.1)	
4		3.81 (96.8)	11.13 (282.7)	3.38 (85.9)	2.94 (74.7)	9.38 (238.3)	
<b>Stainless Steel</b>							
1	In-line	3.00 (76.2)	3.50 (88.9)	3.00 (76.2)	1.50 (38.1)	4.25 (108.0)	①
2		3.50 (88.9)	6.75 (171.5)	3.00 (76.2)	1.50 (38.1)	7.50 (190.5)	
3		3.50 (88.9)	9.00 (228.6)	3.00 (76.2)	1.50 (38.1)	9.00 (228.6)	
4		3.50 (88.9)	11.25 (285.8)	3.00 (76.2)	1.50 (38.1)	12.00 (304.8)	

#### Contact Block

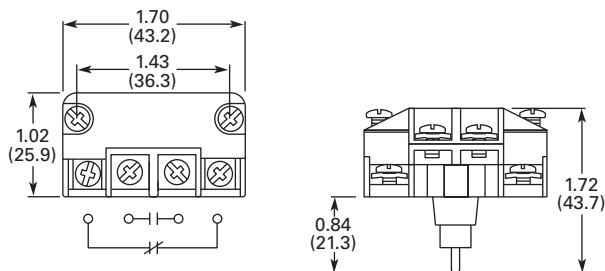

#### Mounting Adapter

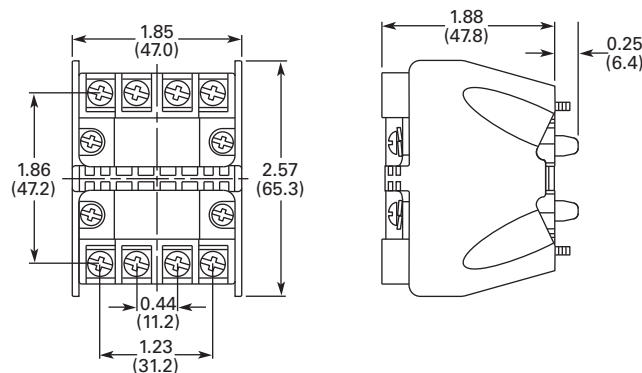

#### Note

① No conduit entrance holes provided. Drill as required.

### Ratings

#### Summary of NEC Article 500

The NEC Article 500 explains in great detail the requirements for the installation of wiring and electrical equipment in hazardous locations. The purpose of this summary is for general reference only, the National Electrical Code along with other applicable authorities having jurisdiction over the site should be the installer's guidelines when wiring or installing electrical equipment in any hazardous or potentially hazardous location.

#### Class I, Division 2 Definition

Class I, Division 2 covers hazardous locations where flammable gases, vapors or volatile liquids are handled either in a closed system, or confined within suitable enclosures, or where hazardous concentrations are normally prevented by positive mechanical ventilation. Areas adjacent to Division 1 locations, into which gases might occasionally flow, would also belong to Division 2 (NEC (500.5(b))).

#### Hazardous Location

Any area where there is the possibility of explosion and fire resulting from the presence of flammable vapors, liquids or gas, or combustible dust or fibers.

#### Summary of NEC Article 505

The NEC also classifies hazardous locations for flammable gases and vapors into zones under NEC 505. This system is more in line with the European Standards, CENELEC and IEC, with the major difference being that NEC 505 only classifies gases and vapors while CENELEC and IEC also include dusts.

### Summary of Classifications

#### NEC 500–503

Class	Division	Group
I. Gas	1. Hazard may exist—May exist in atmosphere under normal operating conditions	A. Acetylene
		B. Hydrogen and manufactured gases containing 30% hydrogen by volume (e.g. butadiene, ethylene oxide, propylene oxide)
	2. Potential hazard—May be present in atmosphere only under abnormal circumstances OR location adjacent to Class I, Division 1 location	C. Petrochemicals (e.g. carbon monoxide, ether, ethylene, hydrogen sulfide, morpholine, cyclopropane)
		D. Petrochemicals (e.g. gasoline, benzene, butane, propane, acetone, ammonia, vinyl chloride)
II. Dust	1. Hazard may exist—May exist in atmosphere under normal operating conditions	A. Acetylene
		B. Hydrogen and manufactured gases containing 30% hydrogen by volume (e.g. butadiene, ethylene oxide, propylene oxide)
		C. Petrochemicals (e.g. carbon monoxide, ether, ethylene, hydrogen sulfide, morpholine, cyclopropane)
	2. Potential hazard—May be present in atmosphere only under abnormal circumstances	D. Petrochemicals (e.g. gasoline, benzene, butane, propane, acetone, ammonia, vinyl chloride)
		E. Conductive and combustible dust (resistivity <10 <sup>9</sup> ohm/cm) (metal dusts)
		F. Carbonaceous dusts (resistivity >10 <sup>2</sup> ohms/cm but ≤10 <sup>8</sup> ohms/cm) (e.g. carbon black, coke dust, coal)
III. Fibers	1. Production areas	G. Non-conductive combustible dust (resistivity ≥10 <sup>9</sup> ohms/cm) (e.g. grain dust, flour, starch, sugar, plastics)
		F. Carbonaceous dusts (resistivity >10 <sup>2</sup> ohms/cm but ≤10 <sup>8</sup> ohms/cm) (e.g. carbon black, coke dust, coal)
	2. Handling and storage areas	G. Non-conductive combustible dust (resistivity ≥10 <sup>9</sup> ohms/cm) (e.g. grain dust, flour, starch, sugar, plastics)
		Easily ignitable fibers or flyings

#### NEC 505

Class	Zone	Group
I. Gas	0. Continuously present or present for long periods of time	IIC. Acetylene, hydrogen or equivalent hazard
		IIB. Acetaldehyde, ethylene or equivalent hazard
		IIA. Acetone, ammonia, ethyl alcohol, gasoline, methane, propane or equivalent hazard
	1. Likely to exist under normal operating or maintenance conditions or adjacent to Zone 0	IIC. Acetylene, hydrogen or equivalent hazard
		IIB. Acetaldehyde, ethylene or equivalent hazard
		IIA. Acetone, ammonia, ethyl alcohol, gasoline, methane, propane or equivalent hazard
2. Not likely to occur in normal operation and if they do occur will only exist for short period or adjacent to Zone 1	IIC. Acetylene, hydrogen or equivalent hazard	
	IIB. Acetaldehyde, ethylene or equivalent hazard	
	IIA. Acetone, ammonia, ethyl alcohol, gasoline, methane, propane or equivalent hazard	

#### Note

For additional information on grouping of compounds, see NFPA 497M-1991 and NFPA 325-1994.

### Summary of Basic Methods Available for Class I, Division 2 Locations

Method	Features Configuration	Advantages	Disadvantages
Factory sealed contact block	Closed-ended labyrinth contact block with an incendiary circuit incapable of external ignition	Higher continuous carrying amperages—up to 10A Direct drive contacts—contacts can be forced open Suitable for use in all enclosures Best suited for motor control applications	May not be suitable for logic level circuits
Hermetically sealed block	Reed switch sealed against an external atmosphere	Suitable for low energy level circuits Suitable for use in all enclosures	Lower continuous carrying amperages are not suitable for motor control applications (typically 3A to 5A rated) Contacts cannot be forced open Permanent magnet attracts metallic dust and filings that can reduce the electrical creepage distance between live terminals
Explosion proof enclosures (Class I, Division 1 and 2)	Enclosures capable of withstanding an internal explosion while preventing external ignition. Enclosures designed for Class I, Division 1 can safely be used in Class I, Division 2	Higher level of protection than required for Class I Division 2	Higher material and installation costs Conduit sealing is still required Time consuming maintenance

#### Factory Sealed Contact Blocks

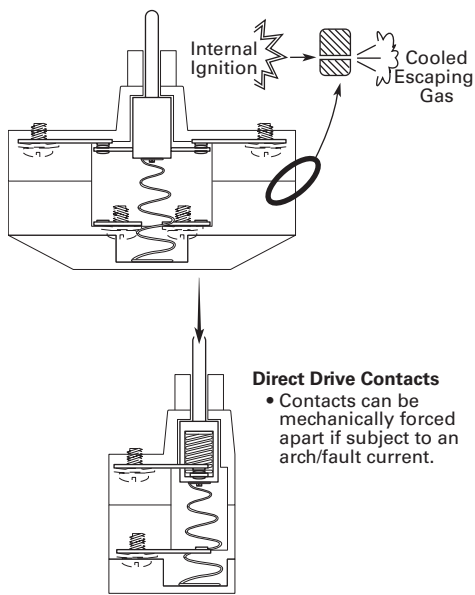

#### Hermetically Sealed Reed Contact Block

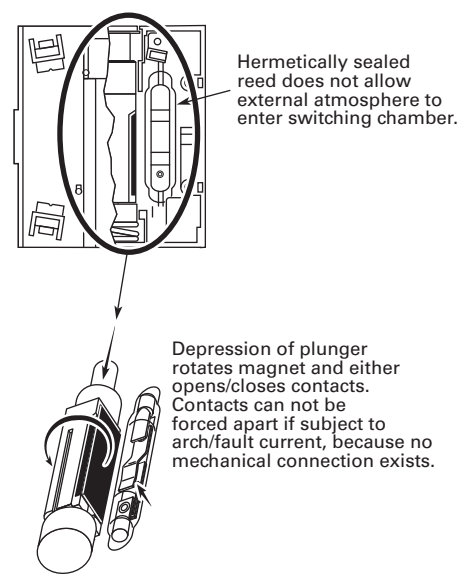

#### Explosion Proof Enclosure

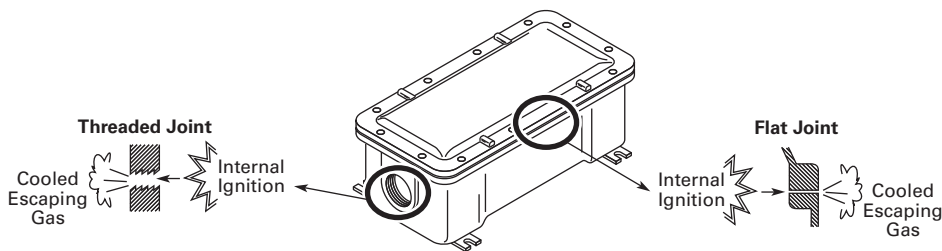



## X-ON Electronics

Largest Supplier of Electrical and Electronic Components

*Click to view similar products for [Coded Rotary Switches](#) category:*

*Click to view products by [Eaton](#) manufacturer:*

Other Similar products are found below :

[PT65SG178](#) [PT65SG23](#) [DRS4010](#) [CW1S-2E11](#) [S-1031A](#) [SBS1004](#) [P36S101TR](#) [P65THR101L254](#) [RM3AF-10R-V-T/R](#) [RH3HAF-10R-V-B](#)  
[PT65501RT](#) [P25SMT101TR](#) [P65SMT101](#) [P65THR101V](#) [MSDR-10H1](#) [GSDR-10S](#) [01-1433](#) [07-3153](#) [07-3154](#) [CRD10CM0SBR](#) [DRS4116](#)  
[94HCB16RAT](#) [94HCB10T](#) [94HBB16WT](#) [94HBB16RAT](#) [94HBB10WT](#) [94HBB10RAT](#) [94HBB08RAT](#) [94HAC10T](#) [94HAB16WT](#)  
[94HAB16T](#) [94HAB10WT](#) [94HAB10RAT](#) [94HAB08WT](#) [94HAB08RAT](#) [ND3FR10P](#) [ND3FR16B-R](#) [DRR3110](#) [94HEB08WRT](#)  
[94HCB16WT](#) [94HCB16T](#) [94HCB10RAT](#) [94HCB08T](#) [94HBB16T](#) [94HBB10T](#) [94HBB08T](#) [94HAB16RAT](#) [94HAB10T](#) [94HAB08T](#) [S-](#)  
[2011A](#)