

Single Row Terminal Blocks

A2, LP2 & CB2

Dimensions Inches (Millimeters)

A2 & LP2

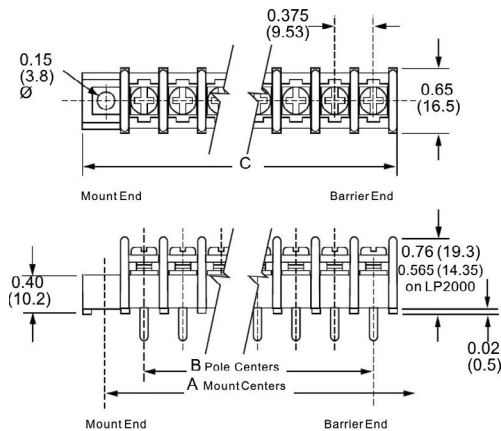

CB2

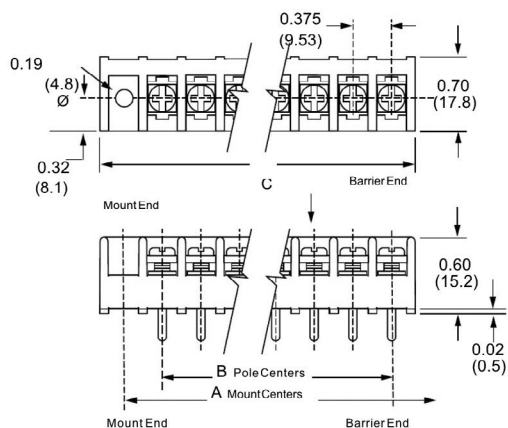

Specifications

Rating: A2: 30A, 300V* LP2: 30A, 150V* CB2: 30A, 300V*

Center Spacing: 0.375" or 3/8" (9.52mm)

Wire Range: #12-22 AWG Cu

Screw Size: #6-32 zinc-plated phillslot

Torque Rating: 9 lb-in.

Base: Standoffs standard for easy flux washing

Distance Between Barriers: 0.32" (8.1mm)

Recommended PCB Hole Diameter: 0.076" (1.93mm)

Operating Temperature: 105°C (221°F) max., -40°C (-40°F) min.

Molded Material: Black, UL Rated 94V0 Thermoplastic

Breakdown Voltage: 3400V (A2 & LP2); 4100V (CB2).

Agency Information: UL File E62622, CSA File 47235;
IEC Compliance; CE Certified

* 30A Rating achieved with a #10 copper wire crimped to a ring terminal.; 20A Rating without ring terminal.

Poles	MOUNTING ENDS ONLY		BARRIER & MOUNTING ENDS	
	A Mounting Ctrs.	C Length	B Pole Ctrs.	C Length
02	1.13	1.56	0.38	0.81
03	1.50	1.93	0.75	1.18
04	1.88	2.30	1.13	1.56
05	2.25	2.68	1.50	1.93
06	2.63	3.06	1.88	2.31
07	3.00	3.43	2.25	2.68
08	3.38	3.81	2.63	3.06
09	3.75	4.18	3.00	3.43
10	4.13	4.56	3.38	3.81
11	4.50	4.93	3.75	4.18
12	4.88	5.31	4.13	4.56
13	5.25	5.69	4.50	4.93
14	5.63	6.06	4.88	5.31
15	6.00	6.43	5.25	5.68
16	6.38	6.81	5.63	6.06
17	6.75	7.18	6.00	6.43
18	7.13	7.56	6.38	6.81
19	7.50	7.93	6.75	7.18
20	7.88	8.31	7.13	7.56
21	8.25	8.68	1.50	7.93
22	8.63	9.06	7.88	8.31
23	9.00	9.43	8.25	8.68
24	9.38	9.81	8.63	9.06
25	-	-	9.00	9.43
26	-	-	9.38	9.81



Powering Business Worldwide

Part Numbering System

Family



A2 - standard barrier

LP2 - low profile barrier

Terminal Style

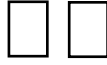

01* - handwired

02 - printed circuit

03 - non feed-thru

04 - wire wrap tail

06 - handwired

07 - extended pin

08 - printed circuit

09 - 0.250" QC short

10 - 0.187" QC

14 - printed circuit

19 - 0.250" QC long

Base/End



1 - std. base/
mnt. end

2 - std. base/
barrier end on
mount

3 - insulator
base/mnt. end

4 - insulator
base/barrier end

5 - closed base/
mount end

6 - closed base/
molded mount
end

Base/End
Note: 5 & 6
Styles only
available with 03
terminals.

Poles

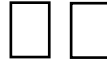

02 to 26 Barrier end

02 to 24 Mount end

Screw Options

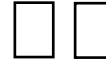

Blank-std. screws

00 - screws shipped
bulk

03* - stainless steel

04 - brass nickel-plated

07 - steel SEMS***

09* - brass SEMS
nickel-plated***

CA** - captive screw

WR* - wire ready

Options

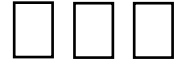

AB* - angle mnt. options (pg 11)

A1 to A9 - 0.250" QC

B1 to B9 - 0.187" QC

DR* - drilled right angle
(pg 11)

L1 to L6 marking options
(pg 25)

MP* mounting plates (pg 11)

R30 to R75 - right angle
bends (pg 11)

S1* - solder lug/flat

Covers - (pg 26)

* A2 only.

** Not compatible with 03-stainless steel screws.

*** SEMS screws not available with hardware options

Terminal Styles Inches (Millimeters)

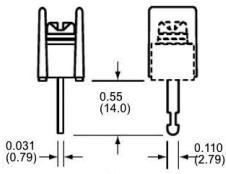

01
Handwired

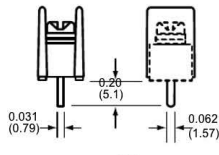

02
Printed Circuit



03
Non Feed-Thru

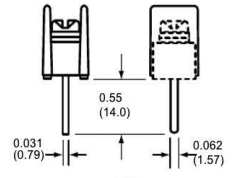

04
Wire Wrap Tail

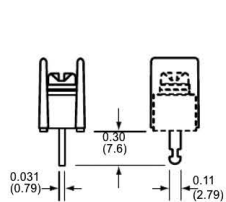

06
Handwired

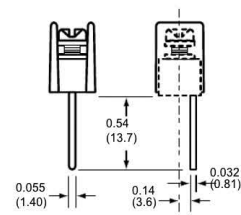

07
Extended Pin

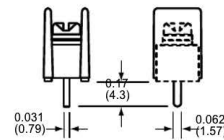

08
Printed Circuit

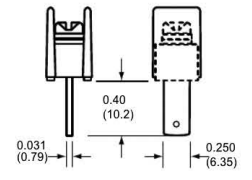

09
0.250" QC short

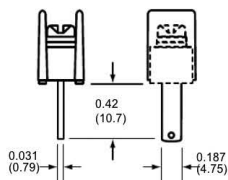

10
0.187" QC

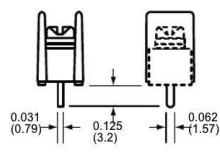

14
Printed Circuit

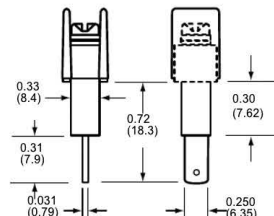

19
0.250" QC long

Screw Options

(Bulk ordering part numbers are in parentheses)



Standard
Zinc-plated Steel
(F505-J)



03
Stainless Steel
(F507-J)



04
Brass
Nickel-Plated
(F506-J)



07
Steel SEMS
(F523-J)



09
Brass SEMS
Nickel-Plated
(F524-J)



WR
Wire Ready

Hardware Options Inches (Millimeters)

(Bulk ordering part numbers are in parentheses)

Solder Lugs

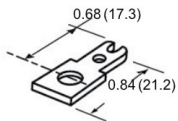

S1
(2S1-J)

Jumpers

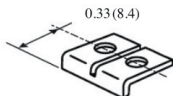

(JA2-xx-J)

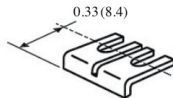

(JB2-xx-J)

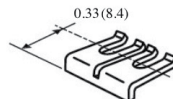

(JC2-xx-J)



†OJ2
(OJ2-J)



†OJ4
(OJ4-J)

Quick Connects

Blade Width A = 0.250" Blade Width B = 0.187"

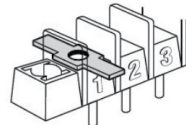

A1 & B1
(2A1-J & 2B1-J)



A2 & B2
(2A2-J & 2B2-J)

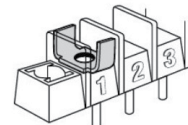

A3 & B3
(2A3-J & 2B3-J)

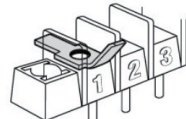

A4 & B4
(2A4-J & 2B4-J)



A5 & B5
(2A5-J & 2B5-J)

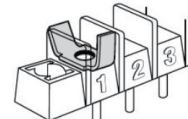

A6 & B6
(2A6-J & 2B6-J)

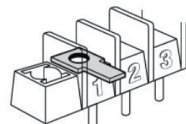

A7 & B7
(2A7-J & 2B7-J)

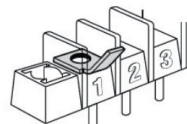

A8 & B8
(2A8-J & 2B8-J)

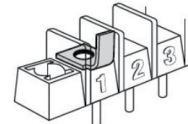

A9 & B9
(2A9-J & 2B9-J)

† Contact Eaton for desired configuration.

Base/End Options Inches (Millimeters)



1 - Standard base/mount end



2 - Standard base/barrier end



3 - Insulator base/mount end

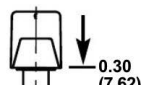

4 - Insulator base/barrier end

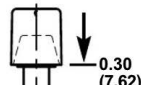

5 - Closed base/mount end



6 - Closed base/molded mount end

(not available with covers)

Mount End Details

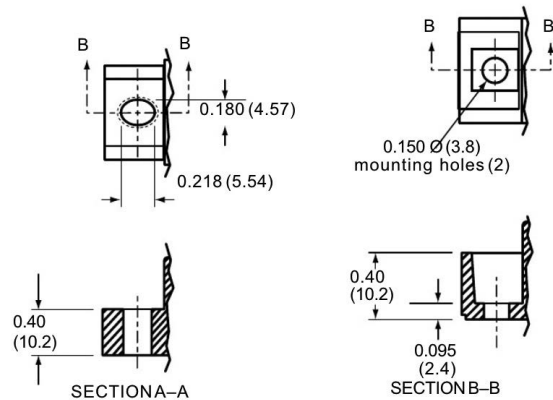

6
Molded Mount End

1, 3 & 5
Mount End

Note: On 1, 3 and 5 bases, Eaton may drill a terminal spacing to be a mount end. There will be no fit/form/function effect of mounting the product

Mounting Options Inches (Millimeters)

Right Angle Bends

Right angle terminals are offered on the A2 & LP2. Configurations are defined in these dimensions: X = pin extension beyond the block base; Z = length from block base to centerline of the terminal tip. Standard bends consist of the X and Z dimensions shown in the chart. Specify by adding the selected Bend Option Code to the terminal part number.

04 Terminal Bend Configurations

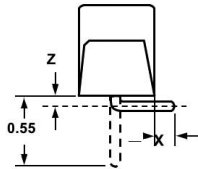

Bend Option Code	X (minimum)	Z	Available with insulator base
R35	0.01	0.23	No
R42	0.08	0.16	No
R46	0.12	0.12	No
R50	0.16	0.08	No

Dimensions in inches. To convert to millimeters, multiply by 25.4.

Angle Brackets

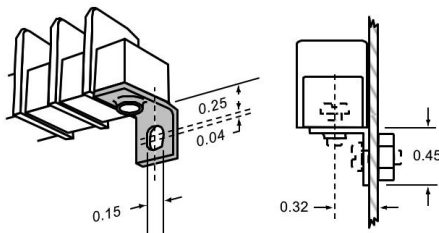

Option AB

Angle brackets enable block to be fastened at right angles to normal mount position. Bulk part number **2AB-J**.

Mounting Plates

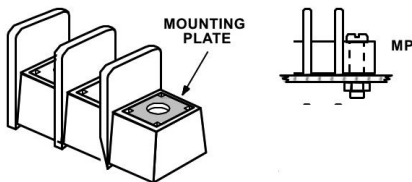

Options MP

MP Metal inserts with 0.150" dia. hole accept #6 screw.
Bulk part number **2MP-J**.

07 Terminal Bend Configurations

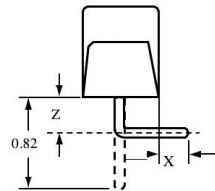

Bend Option Code	X (minimum)	Z	Available with insulator base
R35	0.01	0.50	Yes
R42	0.08	0.43	Yes
R46	0.12	0.39	Yes
R50	0.16	0.35	No
R53	0.19	0.32	No
R66	0.32	0.19	No
R75	0.41	0.10	No

Dimensions in inches. To convert to millimeters, multiply by 25.4.

Drilled Right Angle

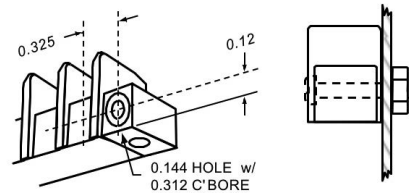

Option DR

Counterbored holes across mount ends of block enable fastening with two screws at right angles to normal mount position.

Part Numbering System

Family	Terminal Style	Base/End	Poles	Screw Options	Options
<div style="display: flex; gap: 10px;"> <div style="border: 1px solid black; padding: 2px 5px;">C</div> <div style="border: 1px solid black; padding: 2px 5px;">B</div> <div style="border: 1px solid black; padding: 2px 5px;">2</div> </div> <p>CB2 - closed back</p>	<div style="display: flex; gap: 10px;"> <div style="border: 1px solid black; width: 20px; height: 20px;"></div> <div style="border: 1px solid black; width: 20px; height: 20px;"></div> </div> <p>01 - handwired 02 - printed circuit 07 - extended pin 14 - printed circuit</p>	<div style="border: 1px solid black; width: 20px; height: 20px;"></div> <p>1 - mount end 2 - barrier end</p>	<div style="display: flex; gap: 10px;"> <div style="border: 1px solid black; width: 20px; height: 20px;"></div> <div style="border: 1px solid black; width: 20px; height: 20px;"></div> </div> <p>02 to 26 on barrier end 02 to 24 on mount end</p>	<div style="display: flex; gap: 10px;"> <div style="border: 1px solid black; width: 20px; height: 20px;"></div> <div style="border: 1px solid black; width: 20px; height: 20px;"></div> </div> <p>Blank-std. screws 07 - steel SEMS standard 09 - brass SEMS nickel-plated</p>	<div style="display: flex; gap: 10px;"> <div style="border: 1px solid black; width: 20px; height: 20px;"></div> <div style="border: 1px solid black; width: 20px; height: 20px;"></div> <div style="border: 1px solid black; width: 20px; height: 20px;"></div> </div> <p>AB - angle mounting brackets (pg 13) A7 to A9 - 0.250" QC B7 to B9 - 0.187" QC EB - exit back terminals EF - exit front terminals L1 to L6 marking options (pg 25) LT1 to LT6 marking options (pg 25) MP mtg. plates (pg 13) Covers - (pg 26)</p>

Terminal Styles Inches (Millimeters)

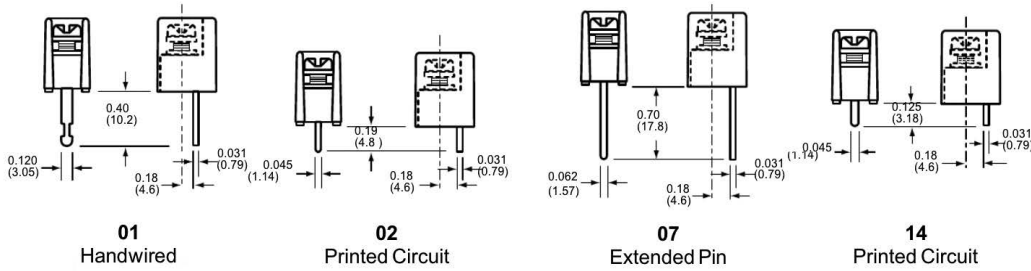

Screw Options

(Bulk ordering part numbers are in parentheses)



07
Steel SEMS
zinc-plated
(B001-7084-J)



09
Brass SEMS
nickel-plated
(F524-J)

* NOTE: Wire ready screws standard on all terminal styles.

CB2 Terminal Exit Options Inches (Millimeters)

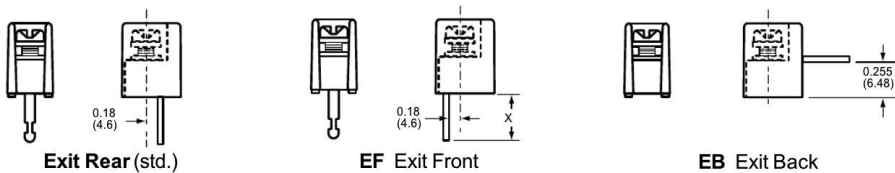

Hardware Options Inches (Millimeters)

(Bulk ordering part numbers are in parentheses)

Jumpers

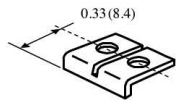

†JA
(JA2-XX-J)

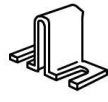

†OJ2
(OJ2-J)

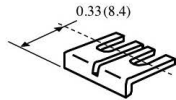

†JB
(JB2-XX-J)



†OJ4
(OJ4-J)

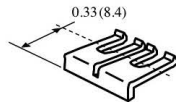

†JC
(JC2-XX-J)

† Contact Eaton for desired configuration.

Quick Connects

Blade Width A = 0.250". Blade Width B = 0.187".



A7 & B7
(2A7-J & 2B7-J)



A8 & B8
(2A8-J & 2B8-J)

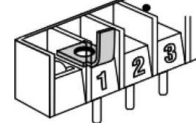

A9 & B9
(2A9-J & 2B9-J)

Mounting Options Inches (Millimeters)

Right Angle Mounting Bracket

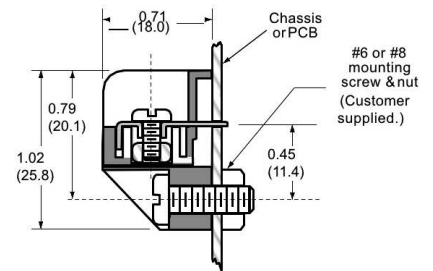
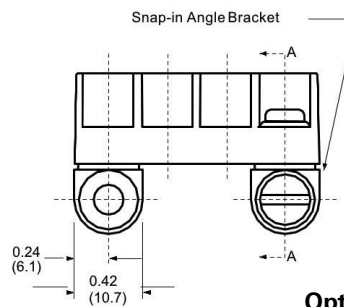
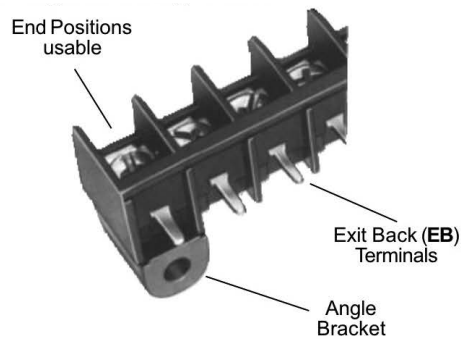

Option AB

Mounts blocks on PC boards at a right angle.

- Protects solder joints.
- Bracket snaps securely on block (no hardware required).
- Minimum strip length (end positions are usable).
- Mount with #6-32 or #8-32 screws (not supplied).
- Available on 3 pole configurations and greater

Mounting Plates

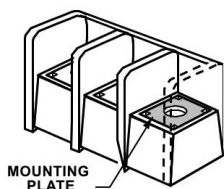

Option MP

MP Metal inserts with 0.150" dia. hole accept #6 screw.

Bulk part number 2MP-J.

Contact Us

Sales and Customer Service

Americas

Email: elx.americas@eaton.com

Europe, Middle East, Africa

Email: elx.emea@eaton.com

China

Email: elx.cn@eaton.com

Japan

Email: elx.jp@eaton.com

Korea

Email: elx.kr@eaton.com

South East Asia

Email: elx.sea@eaton.com

Taiwan

Email: elx.tw@eaton.com

Global Technical Support

Magnetics: InductorTech@eaton.com

Circuit Protection: FuseTech@eaton.com

Supercapacitors: CapacitorTech@eaton.com

www.eaton.com/terminalblocks

Tools

Eaton's Electronics Product Selection Tools



PARAMETRIC SEARCH

Drill down into the Eaton Electronics product database to find the right part for your application.



IC MATCHING

Find the Eaton Electronics parts called out on IC manufacturers' demo and evaluation boards.



CROSS REFERENCE

Find a cross to a competitor's product or to an alternate Eaton Electronics part number.



SUPERCAPACITOR CALCULATOR

Determine your calculated requirements and design capability.



TERMINAL BLOCK SELECTOR

Find the right terminal block for any application.



AUTOMOTIVE ELECTRONICS SOLUTIONS

Find electronics components for automotive solutions.

tools.eatonelectronics.com

Eaton
Electronics Division
1000 Eaton Boulevard
Cleveland, OH 44122
United States
www.eaton.com/electronics

© 2017 Eaton
All Rights Reserved
Printed in USA
Publication No. 10682 — BU-MC17075
December 2017

X-ON Electronics

Largest Supplier of Electrical and Electronic Components

Click to view similar products for [Circuit Breakers](#) category:

Click to view products by [Eaton](#) manufacturer:

Other Similar products are found below :

[M39019/04-249S](#) [M39019/04-313S](#) [M55629/1-001](#) [M55629/1-016](#) [M55629/1-018](#) [M55629/1-021](#) [M55629/1-033](#) [M55629/1-036](#) [M55629/1-046](#) [M55629/1-048](#) [M55629/1-058](#) [M55629/1-060](#) [M55629/1-067](#) [M55629/1-070](#) [M55629/1-079](#) [M55629/1-084](#) [M55629/1-085](#) [M55629/1-101](#) [M55629/1-108](#) [M55629/1-109](#) [M55629/11-102](#) [M55629/1-120](#) [M55629/12-045](#) [M55629/12-046](#) [M55629/1-243](#) [M55629/1-330](#) [M55629/1-331](#) [M55629/1-351](#) [M55629/1-366](#) [M55629/1-387](#) [M55629/1-388](#) [M55629/1-401](#) [M55629/1-430](#) [M55629/1-450](#) [M55629/1-453](#) [M55629/2-022](#) [M55629/2-037](#) [M55629/2-082](#) [M55629/2-099](#) [M55629/2-101](#) [M55629/2-102](#) [M55629/2-115](#) [M55629/2-116](#) [M55629/2-183](#) [M55629/21-HM-HM](#) [M55629/21-NS-NS](#) [M55629/21-SK-UK](#) [M55629/22-NR-NR-NR](#) [M55629/22-RS-RS-RS](#) [M55629/22-TM-TM-TM](#)