

xStart series contactors



xStart series overload relays



Motor protective circuit breaker PKZ



Motor-starter combinations



E Line contactors



E Line thermal overload relay



xStart series

| | | |
|------------|---|----------|
| 1.1 | xStart series contactors | 1 |
| | Mini contactor relays, contactor relay | 1 |
| | Contactors DIL | 1 |
| 1.2 | xStart series overload relays | 2 |
| | Bimetal relay ZE, ZB, Z5 | 2 |
| | Overload relay ZW7 | 2 |
| | Electronic overload relays ZEB | 4 |
| | EMT6 thermistor overload relay for machine protection | 4 |
| | C441 overload and monitoring relay | 37 |
| 1.3 | xStart series motor-protective circuit-breakers | 3 |
| | Motor-protective circuit-breakers PKZ | 3 |
| | Motor-protective circuit-breakers PKE | 8 |
| | DC string circuit-breaker PKZ-SOL | 47 |
| | DC switch-disconnectors P-SOL, SOL | 47 |
| 1.4 | Motor-starter combinations | 1 |
| | Motor-starter combinations | 1 |

E Line series

| | | |
|------------|---|-----------|
| 2.1 | E Line contactors | 1 |
| | Control relays XTRG | 1 |
| | Contactors XTCG | 6 |
| 2.2 | E Line thermal overload relay | 13 |
| | Thermal overload relays XTOD/XTOG | 13 |



Mini contactor relays, contactor relay, contactors

Continual operation requires high operational reliability in the components used. The DILM contactor achieves the best lifespan values in AC-3 applications and is ideal for heavy AC-4 jogging.

Mini contactor relay DILE..., contactor relays, contactors up to 12 A AC-3 at 400 V

- Compact dimensions for the highest packing densities
- Extended performance range up to 5.5 kW at 400 V

AC and DC contactor system DILM..., contactor relays, 3 pole contactors up to 170 A AC-3 at 400 V, 4 pole contactors up to 200 A AC-1

- Easier engineering through identical construction sizes for AC- and DC-operated contactors
- Energy savings and higher packing density in control panel due to minimized heat dissipation
- High wiring security through doubled box terminals
- Less coupler relays: direct actuation from the PLC for contactors up to 32 A
- Easy engineering through integrated suppressor circuits for DC
- Uniform accessories for 3- and 4-pole contactors
- Mechanical interlock double conductor run mountable without additional separation gap
- Direct fieldbus connection through the communication system SmartWire-DT®, through plug-in type protective module

High rated contactors - contactors up to 1600 A AC-3 at 400 V, contactors up to 2600 A AC-1

- Compact dimensions with high switching power
- Direct actuation from the PLC saves coupler relays
- Easy engineering through wide range coils
- Cost and energy savings for control panel ventilation due to reduced heat dissipation
- Long lifespan through vacuum technology from 580 A















Eaton after sales service





Testing switching devices in compliance with regulations applicable to this technology
→ See catalog



SmartWire-DT®

The DIL product range offers contact elements which can be connected to the SmartWire-DT® communication system. → Protective modules, Page 62

| | | |
|---|--|----|
|  | Ordering | |
| | Mini contactor relays DILER, DILEEM, DILEM | |
| | Mini contactor relays, contactors | 2 |
| | Auxiliary contact modules | 6 |
| | Accessories | 8 |
| | Actuating voltages | 66 |
|  | DILA contactor relays | |
| | Contactor relays | 10 |
| | Auxiliary contact modules | 12 |
| | Actuating voltages | 68 |
|  | Technical overview | |
| | Contactors DILM, DILH | 14 |
|  | System overview | |
| | Contactors DILM, DILH | 16 |
|  | Ordering | |
| | Contactors DILM, DILH | |
| | Basic devices up to 170 A | 18 |
| | Complete units up to 170 A | 24 |
| | Standard devices greater than 170 A | 28 |
| | Comfort devices greater than 170 A | 30 |
| | Basic devices up to 200 A, 4 pole | 34 |
| | Auxiliary contact modules | 36 |
|  | Engineering | |
| | Auxiliary contact modules | 40 |
|  | Ordering | |
| | DILK contactors for capacitors | 41 |
|  | Engineering | |
| | Contactors for power factor correction | 42 |
|  | Ordering | |
| | Star-delta combinations SDAINL | 44 |
|  | Engineering | |
| | Star-delta combinations SDAINL | 46 |
|  | Ordering | |
| | DIUL reversing combinations | 48 |
|  | Description | |
| | CMD contactor monitoring device | 64 |
| | Ordering | |
| | CMD contactor monitoring device | 64 |

| | | |
|--|--|-----|
|  | Ordering | |
| | DILM contactor relays, DILM, DILH contactors | |
| | suppressor circuit | 50 |
| | Accessories | 52 |
|  | Ordering | |
| | Actuating voltages contactors DILM, DILH | |
| | Basic devices up to 170 A | 69 |
| | Basic devices up to 200 A, 4 pole | 74 |
| | Contactors up to 150 A | |
| | with electronic actuation | 76 |
| | Replacement coils | 71 |
| | Comfort devices greater than 170 A | 77 |
| | Standard devices greater than 170 A | 77 |
| | Electronic modules including coil | 77 |
| | Contactors for capacitors | 77 |
|  | Engineering | |
| | Contact travel diagrams | 78 |
| | Enclosure | 79 |
| | UL/CSA-approved rating data | 80 |
| | UL/CSA special purpose ratings | 81 |
| | UL/CSA short circuit current rating | 82 |
| | Contactors for resistive loads | 84 |
| | Electrical life span | 86 |
| | Short-time loading | 90 |
| | Operating frequency | 91 |
| | Switching of DC current | 92 |
|  | Technical data | |
| | Mini contactor relays, contactor relays | 93 |
| | Contactor monitoring device | 96 |
| | Basic devices up to 170 A | 104 |
| | Basic devices up to 200 A, 4 pole | 120 |
| | Comfort devices greater than 170 A | 112 |
| | Standard devices greater than 170 A | 112 |
| | Contactors for capacitors | 123 |
| | Contactors up to 150 A | |
| | with electronic actuation | 126 |
| | Lighting contactors | 125 |
| | Auxiliary contact modules | 128 |
| | Accessories | 128 |
|  | Dimensions | |
| | Mini contactor relays | 130 |
| | Contactor relays | 131 |
| | Basic devices up to 170 A | 131 |
| | Basic devices up to 200 A, 4 pole | 133 |
| | Contactors larger than 170 A | 134 |
| | Contactors for capacitors | 136 |
| | Lighting contactors | 136 |
| | Contactor combinations | 137 |
| | Accessories | 138 |

1.1

Contactors

Mini contactors, relays

1 Ordering

Screw terminals

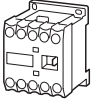

DILER mini contactor relays

| Rated operational current AC-15 | | Conventional free air thermal current | Contact | | Distinctive number | Circuit symbol | For use with |
|------------------------------------|-------|--|-----------------------------|------------------------------|-----------------------|----------------|--------------|
| 220 V | 380 V | | N/O = normally open contact | NC = normally closed contact | | | |
| 230 V | 400 V | | | | | | |
| 240 V | 415 V | | | | | | |
| I_e | I_e | I_{th} | | | | | |
| A | A | | A | | | | |
| 6 | 3 | 10 | 4 N/O | – | 40E | | DILE... |
| | | | 3 N/O | 1 NC | 31E | | DILE... |
| | | | 2 N/O | 2 NC | 22E | | DILE... |

Notes

- Coil terminal marking as specified in EN 50005
- Contact numbers to EN 50011
- The following applies to DC-operated contactors:
 - Integrated diode-resistor combination
 - Coil rating 2.6 W

Information relevant for export to North America



| | |
|-------------------|--|
| Product Standards | IEC/EN 60947-4-1; UL508; CSA-C22.2 No.14-05; |
| UL File No. | E29184 |
| UL CCN | NKCR |
| CSA File No. | 012528 |
| CSA Class No. | 3211-03 |
| NA Certification | UL Listed, CSA certified |

| AC operation | | DC operation | | Std. pack | Notes |
|--------------|----------------|--------------|----------------|-----------|-------|
| Part no. | Price | Part no. | Price | | |
| Article no. | See price list | Article no. | See price list | | |

| | | |
|-------------------------------------|------------------------------------|---|
| DILER-40(230V50Hz) 051759 | DILER-40-G(24VDC) 010223 | 5 off |
| DILER-31(230V50Hz) 051768 | DILER-31-G(24VDC) 010157 |  |
| DILER-22(230V50Hz) 051777 | DILER-22-G(24VDC) 010042 | |

With screw terminals:

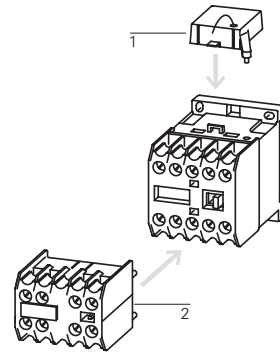

Accessories

- 1 Suppressor
- 2 Auxiliary contact modules
- Further actuating voltages

Page

- 8
- 6
- 66







1.1

Contactors

Mini contactors, relays

1

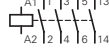
DILEM contactors

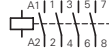
| Rated operational current | Max. motor rating for three-phase motors, 50 - 60 Hz | | | | | | Conventional thermal current $I_{th} = I_e$ AC-1 at 50 °C | | Contact | | Circuit symbol | For use with |
|---------------------------|--|-----------------------------------|---------------------|---------------------|-----------------------------------|---------------------|--|----------------|---|------|--|--------------|
| | AC-3 | | | AC-4 | | | Open | Enclosed | N/O = normally open contact NC = normally closed contact | | | |
| 380 V 400 V I_e | 220 V 230 V P | 380 V 400 V P | 660 V 690 V P | 220 V 230 V P | 380 V 400 V P | 660 V 690 V P | $I_{th} = I_e$ | $I_{th} = I_e$ | 1 N/O | 1 NC | | |
| A | kW | kW | kW | kW | kW | kW | A | A | | | | |
| 6.6 | 1.5 | 3 | 3 | 1.1 | 2.2 | 2.2 | 20 | 16 | 1 N/O | – |  ...DILEM DILE... | |
| 6.6 | 1.5 | 3 | 3 | 1.1 | 2.2 | 2.2 | 20 | 16 | – | 1 NC |  DILE... | |
| 9 | 2.2 | 4 | 4 | 1.5 | 3 | 3 | 20 | 16 | 1 N/O | – |  ...DILEM DILE... | |
| 9 | 2.2 | 4 | 4 | 1.5 | 3 | 3 | 20 | 16 | – | 1 NC |  DILE... | |
| 12 | 3.5 | 5.5 | 6.5 | 2 | 3 | 2.2 | 20 | 16 | 1 N/O | – |  ...DILEM DILE... | |
| 12 | 3.5 | 5.5 | 6.5 | 2 | 3 | 2.2 | 20 | 16 | – | 1 NC |  DILE... | |
| 9 | 2.2 | 4 | 4 | 1.5 | 3 | 3 | 20 | 16 | – | – |  ...DILEM DILE... | |

3 pole with auxiliary contact
Screw terminals

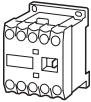

4 pole
Screw terminals

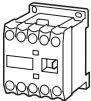

1)

Information relevant for export to North America



Product Standards IEC/EN 60947-4-1;
UL 508; CSA-C22.2
No.14-05; CE marking
UL File No. E29096
UL CC NLDX
CSA File No. 012528
CSA Class No. 3211-04
NA Certification UL Listed, CSA certified
See also → Page 80



2)

Information relevant for export to North America



Product Standards IEC/EN 60947-4-1;
UL 508; CSA-C22.2 No.14-05; CE marking
UL File No. E29096
UL CCN NLDX
CSA File No. 012528
CSA Class No. 2411-03,3211-04
NA Certification UL Listed, request filed for CSA

| AC operation | | DC operation | | Std. pack | Notes |
|-------------------------|-------------------------|-------------------------|-------------------------|-----------|-------|
| Part no. Article no. | Price See price list | Part no. Article no. | Price See price list | | |

| | | | |
|---|--|-------|---|
| DILEEM-10(230V50Hz) ¹⁾ 051608 | DILEEM-10-G(24VDC) ¹⁾ 051643 | 5 off |  |
| DILEEM-01(230V50Hz) ¹⁾ 051633 | DILEEM-01-G(24VDC) ¹⁾ 051650 | | |
| DILEM-10(230V50Hz) ¹⁾ 051786 | DILEM-10-G(24VDC) ¹⁾ 010213 | | |
| DILEM-01(230V50Hz) ¹⁾ 051795 | DILEM-01-G(24VDC) ¹⁾ 010343 | | |
| DILEM12-10(230V50Hz) ²⁾ 127075 | DILEM12-10-G(24VDC) ²⁾ 127132 | | |
| DILEM12-01(230V50Hz) ²⁾ 127091 | DILEM12-01-G(24VDC) ²⁾ 127137 | | |
| DILEM4(230V50Hz) ¹⁾ 051804 | DILEM4-G(24VDC) ¹⁾ 012701 | 5 off |  |

With screw terminals:

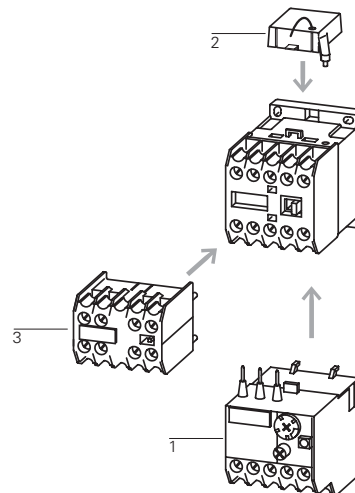

Accessories

- 1 Overload relay
- 2 Suppressor
- 3 Auxiliary contact module
- Enclosures totally insulated
- Further actuating voltages
- Accessories

Page

- Chapter 1.2
- 8
- 6
- 66
- 8

1.1

Mini contactor relays

Auxiliary contact modules

1

Screw terminals













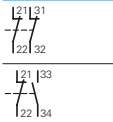

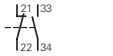

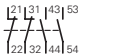





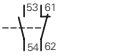







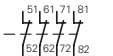

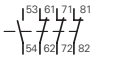

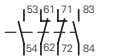
DILE Auxiliary contact modules

| | Contact | | | | Rated operational current | | Conventional thermal current I_{th} A | Distinctive number/type of combinations with basic device | | |
|--------|-----------------------------|--------------------------------|------------------------------|--------------------------------|----------------------------------|-------------------------|---|---|--------------|----------|
| | N/O = normally open contact | S _F = NO early-make | NC = normally closed contact | Ö _S = NC late-break | AC-15 220 V 230 V 240 V | 380 V 400 V 415 V | | DILER-40(-G) | DILER-31(-G) | DILER-22 |
| 2 pole | – | – | 2 NC | – | 4 | 2 | 10 | – | – | – |
| | 1 N/O | – | 1 NC | – | 4 | 2 | 10 | – | – | – |
| 4 pole | 2 N/O | – | 2 NC | – | 4 | 2 | 10 | – | – | – |
| 2 pole | – | – | 2 NC | – | 4 | 2 | 10 | 42E | 33 | 24 |
| | 1 N/O | – | 1 NC | – | 4 | 2 | 10 | 51E | 42 | 33 |
| | 2 N/O | – | – | – | 4 | 2 | 10 | 60E | 51 | 42 |
| | – | 1 S _F | – | 1 Ö _S | 4 | 2 | 10 | 51 | 42 | 33 |
| 4 pole | – | – | 4 NC | – | 4 | 2 | 10 | 44E | 35 | 26 |
| | 1 N/O | – | 3 NC | – | 4 | 2 | 10 | 53E | 44 | 35 |
| | 2 N/O | – | 2 NC | – | 4 | 2 | 10 | 62E | 53 | 44 |
| | 3 N/O | – | 1 NC | – | 4 | 2 | 10 | 71E | 62 | 53 |
| | 4 N/O | – | – | – | 4 | 2 | 10 | 80E | 71 | 62 |
| | 1 N/O | 1 S _F | 1 NC | 1 Ö _S | 4 | 2 | 10 | 62 | 53 | 44 |

Information relevant for export to North America

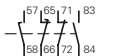

| | |
|-------------------|---|
| Product Standards | IEC/EN 60947-4-1; UL 508; CSA-C22.2 No.14-05; CE marking |
| UL File No. | E29184 |
| UL CCN | NKCR |
| CSA File No. | 012528 |
| CSA Class No. | 3211-03 |
| NA Certification | UL Listed, CSA certified |

| Circuit symbol | Can be combined with contactor | Part no. Article no. | Price See price list | Std. pack | Notes | |
|---|--------------------------------|--------------------------|-------------------------|---|------------------------------------|---|
|  | | 02DILEM 010064 | 5 off |   | With interlocked opposing contacts | <p>The following applies to ...DILEM auxiliary contacts:</p> <ul style="list-style-type: none"> • Contacts to EN 50012 <p>The following applies to ...DILE auxiliary contacts:</p> <ul style="list-style-type: none"> • Contacts to EN 50005 <p>Contacts according to EN50012 are to be preferred. Type E combinations comply with EN 50011 and are to be given preference.</p> <p>No interlocked opposing contacts in NO early-makes and NC late-breaks.</p> |
|  | | 11DILEM 010080 | 5 off |   | With interlocked opposing contacts | |
|  | | 22DILEM 010112 | 5 off |   | With interlocked opposing contacts | |
|  | | 02DILE 010240 | 5 off |   | With interlocked opposing contacts | |
|  | | 11DILE 010224 | 5 off |   | With interlocked opposing contacts | |
|  | | 20DILE 010208 | 5 off |   | With interlocked opposing contacts | |
|  | | 11DDILE 049824 | 5 off |   | – | |
|  | | 04DILE 010256 | 5 off |   | With interlocked opposing contacts | |
|  | | 13DILE 002397 | 5 off |   | With interlocked opposing contacts | |
|  | | 22DILE 010288 | 5 off |   | With interlocked opposing contacts | |
|  | | 31DILE 048912 | 5 off |   | With interlocked opposing contacts | |
|  | | 40DILE 010304 | 5 off |   | With interlocked opposing contacts | |
|  | | 22DDILE 049823 | 5 off |   | – | |

1.1

Mini contactor relays Accessories

1 VGDILE..., RCDILE..., MVDILE, BT480, P1DILEM

| Actuating voltage U_s V AC | Circuit symbol | For use with | Part no. Article no. | Price See price list | Std. pack | Information relevant for export to North America |
|------------------------------------|----------------|--------------|-------------------------|-------------------------|-----------|--|
|------------------------------------|----------------|--------------|-------------------------|-------------------------|-----------|--|

Suppressor circuits

Varistor suppressor

| | | | | | | |
|--|--------------|--|----------------------------|---------------------------|------------|--|
| | 24 - 48 AC | | DILE... | VGDILE48 010320 | 10 off | Product Standards IEC/EN 60947-4-1; UL 508; CSA-C22.2 No.14-05; CE marking E29096 UL File No. UL CCN CSA File No. CSA Class No. NA Certification NLDX 012528 3211-03 UL Listed, CSA certified |
| | 110 - 250 AC | | VGDILE250 010336 | 10 off | | |
| | 380 - 415 AC | | VGDILE415 010463 | 10 off | | |

RC-Suppressor

| | | | | | | |
|--|--------------|--|----------------------------|---------------------------|------------|---|
| | 24 - 48 AC | | DILE... | RCDILE48 044264 | 10 off | Product Standards IEC/EN 60947-4-1; UL 508; CSA-C22.2 No.14-05; CE marking E29184 UL File No. UL CCN CSA File No. NA Certification NKCR2 - UL Recognized |
| | 110 - 250 AC | | RCDILE250 046320 | 10 off | | |

Notes
For AC operated contactors 50 - 60 Hz.
DC operated contactor relays have an integrated suppressor.
Note drop-out delay.

VGDILE..., RCDILE..., MVDILE, BT480, P1DILEM

| For use with | Part no. Article no. | Price See price list | Std. pack | Information relevant for export to North America |
|--------------|-------------------------|-------------------------|-----------|--|
|--------------|-------------------------|-------------------------|-----------|--|

Mechanical interlocks

For mechanical connection of contactor and timing relays in combinations.
0 mm distance between contactors.

| | | | | |
|--|---------------------|-------------------------|------------|-----------------------------------|
| | DILE... DILET... | VODILE 026634 | 50 off | UL/CSA certification not required |
|--|---------------------|-------------------------|------------|-----------------------------------|

Mechanical interlock

For contactors with the same or different magnet system.
0 mm distance between contactors.
Mechanical lifespan 2.5×10^6 operations.
Additional auxiliary contact modules possible.

| | | | | |
|--|---------|-------------------------|-----------|---|
| | DILE... | MVDILE 010113 | 5 off | Product Standards IEC/EN 60947-4-1; UL 508; CSA-C22.2 No.14-05; CE marking E29184 UL File No. UL CCN CSA File No. CSA Class No. NA Certification NKCR2 012528 3211-07 UL Recognized, CSA certified |
|--|---------|-------------------------|-----------|---|

Paralleling link

For parallel connection of contacts

| | | | | |
|--|--------------------|--------------------------------------|--|--|
| | DILE... DILE... | BT480 ¹⁾ 052785 | 100 off | Product Standards IEC/EN 60947-4-1; UL 508; CSA-C22.2 No.14-05; CE marking E29096 UL File No. UL CCN CSA File No. CSA Class No. NA Certification NLDX 012528 3211-07 UL Listed, CSA certified |
| Consisting of two four-pole paralleling links. | | DILEEM DILEM12 DILEM | P1DILEM ²⁾ 019095 | 5 off |

Notes
1) Not protected against accidental contact as specified in VDE 0106 Part 100.
2) 4th pole can be broken off
4 pole: $I_{th} = 60$ A open
3 pole: $I_{th} = 50$ A open
AC-1 current carrying capacity of the open contactor increases by a factor of 2.5
Protected against accidental contact in accordance with VDE 0106 Part 100

HDILE, ...DILEM, MVS

| Contact sequence | For use with | Part no. Article no. | Price See price list | Std. pack | Information relevant for export to North America |
|------------------|--------------|-------------------------|-------------------------|-----------|--|
|------------------|--------------|-------------------------|-------------------------|-----------|--|



Sealable shrouds

Transparent
Snap-fitting on contactor.
Can be used with open installation or on service distribution board.
Protection type: IP40 front
Can be drilled to accommodate timing relay setting dials.

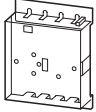

| | | | |
|---------------------|------------------------|-----------|-----------------------------------|
| DILE... DILET... | HDILE 010482 | 1 off | UL/CSA certification not required |
|---------------------|------------------------|-----------|-----------------------------------|

Start-point bridge



| | | |
|----------------------------|--------------------------------------|--------|
| DILEEM DILEM12 DILEM | SDILEM¹⁾ 220218 | 20 off |
|----------------------------|--------------------------------------|--------|

Reversing starter wiring kit

Main current wiring for reversing combinations

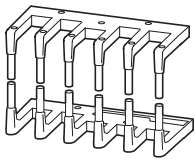

| | | | |
|---|---|-----------|---|
| DILEEM (+MVDILEM) DILEM12 (+MVDILEM) DILEM (+MVDILEM) | MVS-WB-EM²⁾ 220209 | 1 off | Product Standards IEC/EN 60947-4-1; UL 508; CSA-C22.2 No.14-05; CE marking UL File No. E36332 UL CCN NLRV7 CSA File No. 012528 CSA Class No. 3211-06 NA Certification UL Listed, CSA certified |
|---|---|-----------|---|

Star-delta wiring kit

Main current wiring for star-delta combination incl. star-point bridge

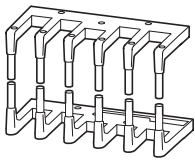

| | | | |
|---|---|-----------|---|
| DILE(E)M (+MVDILEM) DILE(E)M12 (+MVDILEM) DILE(E)M star contactor | MVS-SB-EM³⁾ 220213 | 1 off | Product Standards IEC/EN 60947-4-1; UL 508; CSA-C22.2 No.14-05; CE marking UL File No. E36332 UL CCN NLRV7 CSA File No. 012528 CSA Class No. 3211-06 NA Certification UL Listed, CSA certified |
|---|---|-----------|---|

Notes

- ¹⁾ Protected against accidental contact in accordance with VDE 0106 Part 100
- ²⁾ The following control cables are integrated in addition to electrical interlock:
 - Q11: A1 - Q12: 21
 - Q11: 21 - Q12: A1
 - Q11: A2 - Q12: A2
 For use with overload relay separate mounting.
- ³⁾ The following control cables are integrated in addition to electrical interlock:
 - Q13: A1 - Q15: 21
 - Q13: 21 - Q15: A1
 - Q13: A2 - Q15: A2
 For use with overload relay separate mounting.

1.1

Contactor relays

Basic devices

1

DILA Basic devices with positively driven contacts

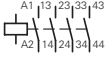
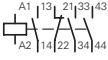
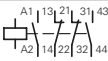
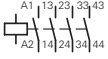
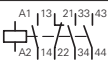
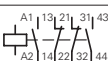
| Contact | | Rated operational current | | Conventional thermal current | Distinctive number | Can be combined with auxiliary contact | Circuit symbol |
|--------------------------------|------------------------------|---------------------------|-------|------------------------------|--------------------|--|---|
| N/O = normally open contact | NC = normally closed contact | AC-15 | | I_{th} | | | |
| | | 220 V | 380 V | A | | | |
| | | 230 V | 400 V | | | | |
| | | 240 V | 415 V | | | | |
| | | I_e | I_e | | | | |
| | | A | A | | | | |
| Screw terminals | | | | | | | |
| 4 N/O | – | 4 | 4 | 16 | 40E | DILA-XHI(V)... |  |
| 3 N/O | 1 NC | 4 | 4 | 16 | 31E | DILA-XHI(V)... |  |
| 2 N/O | 2 NC | 4 | 4 | 16 | 22E | DILA-XHI(V)... |  |
| Spring-loaded terminals | | | | | | | |
| 4 N/O | – | 4 | 4 | 16 | 40E | DILA-XHIC(V)... |  |
| 3 N/O | 1 NC | 4 | 4 | 16 | 31E | DILA-XHIC(V)... |  |
| 2 N/O | 2 NC | 4 | 4 | 16 | 22E | DILA-XHIC(V)... |  |

Screw terminals

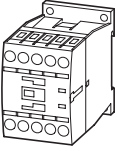

Spring-loaded terminals

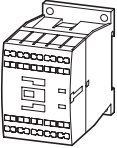

Notes

Contact numbers to EN 50011
Coil terminal markings to EN 50005
The following applies to DC-operated contactors:

- Integrated suppressor circuit

Information relevant for export to North America



| | |
|-------------------|--|
| Product Standards | IEC/EN 60947-4-1; UL 508; CSA-C22.2 No.14-05; CE marking |
| UL File No. | E29184 |
| UL CCN | NKCR |
| CSA File No. | 012528 |
| CSA Class No. | 3211-03 |
| NA Certification | UL Listed, CSA certified |

AC operation

Part no.
Article no.

Price
See price list

Std. pack

Circuit symbol

DC operation

Part no.
Article no.

Price
See price list

Std. pack

Notes

| | | | | |
|------------------------------------|-----------|--|---------------------------------|-----------|
| DILA-40(230V50Hz) 276329 | 1 off | | DILA-40(24VDC) 276344 | 1 off |
| DILA-31(230V50Hz) 276364 | 1 off | | DILA-31(24VDC) 276379 | |
| DILA-22(230V50Hz) 276399 | 1 off | | DILA-22(24VDC) 276414 | |

With screw terminals:

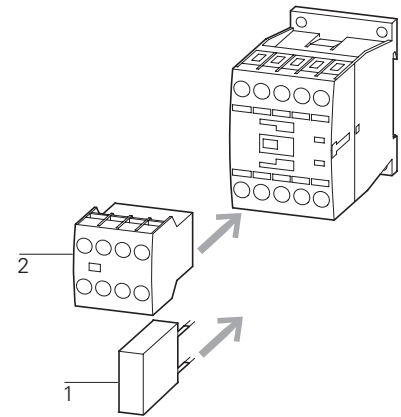

Accessories

- 1 Suppressor
- 2 Auxiliary contact modules
- Further actuating voltages

Page

- 50
- 36
- 68

| | | | | |
|-------------------------------------|-----------|--|----------------------------------|-----------|
| DILAC-40(230V50Hz) 276441 | 1 off | | DILAC-40(24VDC) 276456 | 1 off |
| DILAC-31(230V50Hz) 276473 | 1 off | | DILAC-31(24VDC) 276488 | |
| DILAC-22(230V50Hz) 276505 | 1 off | | DILAC-22(24VDC) 276520 | |

With spring-loaded terminals:

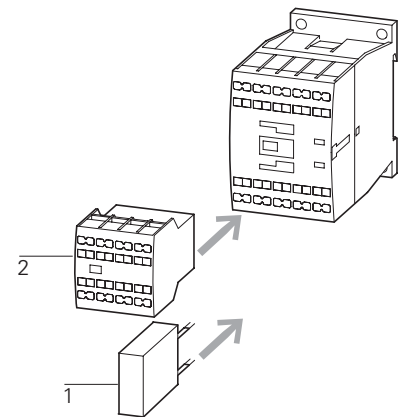

Accessories

- 1 Suppressor
- 2 Auxiliary contact modules
- Further actuating voltages

Page

- 50
- 36
- 68

1.1

Contactor relays Auxiliary contact modules

1

DILA...XHI... DILA auxiliary contact modules

| Contact | Rated operational current | Conventional thermal current | Circuit symbol |
|---|---|------------------------------|----------------|
| N/O = normally open contact S _F = NO early-make NC = normally closed contact Ö _S = NC late-break | AC-15 220 V 380 V 230 V 400 V 240 V 415 V | I _{th} | |
| | I _e A | A | A |

Screw terminals



| | | | | | | | | |
|--------|-------|------------------|------|------------------|---|---|----|--|
| 2 pole | – | – | 2 NC | – | 4 | 4 | 16 | |
| | 1 N/O | – | 1 NC | – | 4 | 4 | 16 | |
| | 2 N/O | – | – | – | 4 | 4 | 16 | |
| | – | 1 S _F | – | 1 Ö _S | 4 | 4 | 16 | |

Screw terminals



| | | | | | | | | |
|--------|-------|------------------|------|------------------|---|---|----|--|
| 4 pole | – | – | 4 NC | – | 4 | 4 | 16 | |
| | 1 N/O | – | 3 NC | – | 4 | 4 | 16 | |
| | 2 N/O | – | 2 NC | – | 4 | 4 | 16 | |
| | 3 N/O | – | 1 NC | – | 4 | 4 | 16 | |
| | 4 N/O | – | – | – | 4 | 4 | 16 | |
| | 1 N/O | 1 S _F | 1 NC | 1 Ö _S | 4 | 4 | 16 | |

Spring-loaded terminals



| | | | | | | | | |
|--------|-------|------------------|------|------------------|---|---|----|--|
| 2 pole | – | – | 2 NC | – | 4 | 4 | 16 | |
| | 1 N/O | – | 1 NC | – | 4 | 4 | 16 | |
| | 2 N/O | – | – | – | 4 | 4 | 16 | |
| | – | 1 S _F | – | 1 Ö _S | 4 | 4 | 16 | |

Spring-loaded terminals









































| | | | | | | | | |
|--------|-------|------------------|------|------------------|---|---|----|--|
| 4 pole | – | – | 4 NC | – | 4 | 4 | 16 | |
| | 1 N/O | – | 3 NC | – | 4 | 4 | 16 | |
| | 2 N/O | – | 2 NC | – | 4 | 4 | 16 | |
| | 3 N/O | – | 1 NC | – | 4 | 4 | 16 | |
| | 4 N/O | – | – | – | 4 | 4 | 16 | |
| | 1 N/O | 1 S _F | 1 NC | 1 Ö _S | 4 | 4 | 16 | |

Information relevant for export to North America



| | |
|-------------------|--|
| Product Standards | IEC/EN 60947-4-1; UL 508; CSA-C22.2 No.14-05; CE marking |
| UL File No. | E29184 |
| UL CCN | NKCR |
| CSA File No. | 012528 |
| CSA Class No. | 3211-03 |
| NA Certification | UL Listed, CSA certified |

| Distinctive number/type of combinations | | | Part no. Article no. | Price See price list | Std. pack | Description | Notes | |
|---|------------|------------|-------------------------------|-------------------------|--|------------------------------------|--|--|
| DILA(C)-40 | DILA(C)-31 | DILA(C)-22 | | | | | | |
| 42E | 33 | 24 | DILA-XHI02 276420 | | 5 off   | With interlocked opposing contacts | Type E combinations comply with EN 50011 and must be given preference. The other combinations comply with EN 50005 The DC operated contactor DILA(C)-22 must only be combined with 2 pole auxiliary contacts. | |
| 51E | 42 | 33 | DILA-XHI11 276421 | | 5 off   | With interlocked opposing contacts | | |
| 60E | 51 | 42 | DILA-XHI20 276422 | | 5 off   | With interlocked opposing contacts | | |
| 51 | 42 | 33 | DILA-XHIV11 276423 | | 5 off   | – | | |
| 44E | 35 | 26 | DILA-XHI04 276424 | | 5 off   | With interlocked opposing contacts | | |
| 53E | 44 | 35 | DILA-XHI13 276425 | | 5 off   | With interlocked opposing contacts | | |
| 62E | 53 | 44 | DILA-XHI22 276426 | | 5 off   | With interlocked opposing contacts | | |
| 71E | 62 | 53 | DILA-XHI31 276427 | | 5 off   | With interlocked opposing contacts | | |
| 80E | 71 | 62 | DILA-XHI40 276428 | | 5 off   | With interlocked opposing contacts | | |
| 62 | 53 | 44 | DILA-XHIV22 276429 | | 5 off   | – | | |
| 42E | 33 | 24 | DILA-XHIC02 276526 | | 5 off   | With interlocked opposing contacts | | Type E combinations comply with EN 50011 and must be given preference. The other combinations comply with EN 50005 The DC operated contactor DILA(C)-22 must only be combined with 2 pole auxiliary contacts. |
| 51E | 42 | 33 | DILA-XHIC11 276527 | | 5 off   | With interlocked opposing contacts | | |
| 60E | 51 | 42 | DILA-XHIC20 276528 | | 5 off   | With interlocked opposing contacts | | |
| 51 | 42 | 33 | DILA-XHICV11 276529 | | 5 off   | – | | |
| 44E | 35 | 26 | DILA-XHIC04 276530 | | 5 off   | With interlocked opposing contacts | | |
| 53E | 44 | 35 | DILA-XHIC13 276531 | | 5 off   | With interlocked opposing contacts | | |
| 62E | 53 | 44 | DILA-XHIC22 276532 | | 5 off   | With interlocked opposing contacts | | |
| 71E | 62 | 53 | DILA-XHIC31 276533 | | 5 off   | With interlocked opposing contacts | | |
| 80E | 71 | 62 | DILA-XHIC40 276534 | | 5 off   | With interlocked opposing contacts | | |
| 62 | 53 | 44 | DILA-XHICV22 276535 | | 5 off   | – | | |

1.1 Contactors

1 Technical overview

DILM, DILE(E)M, DILMP

Contactors

3 pole

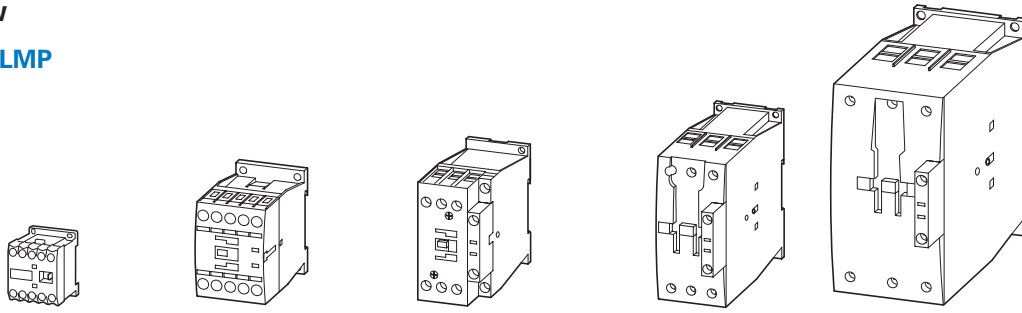

| DIL | EEM | EM | EM12 | M7 | M9 | M12 | M15 | M17 | M25 | M32 | M38 | M40 | M50 | M65 | M80 | M95 | M115 | M150 | M170 |
|---------------------------|-----|----|------|-----------|----|-----|-----|-----------|-----|-----|-----|-----------|-----|-----|-----------|-----|------|------|------|
| Basic devices | → 4 | | | → 18 | | | | → 18 | | | | → 20 | | | → 46 | | | | |
| Complete units | | - | | → Page 24 | | - | | → Page 24 | | | | → Page 26 | | | → Page 26 | | | | |
| Rated-operational voltage | kW | kW | kW | kW | kW | kW | kW | kW | kW | kW | kW | kW | kW | kW | kW | kW | kW | kW | kW |

| AC-3 | Rated operational power for 3-phase motors 50–60 Hz | | | | | | | | | | | | | | | | | | |
|----------------------|---|----------|------------|----------|----------|------------|------------|------------|-----------|-----------|-------------|-------------|-----------|-----------|-----------|-----------|-----------|-----------|-----------|
| 220 V – 230 V | 1.5 | 2.2 | 3 | 2.2 | 2.5 | 3.5 | 4 | 5 | 7.5 | 10 | 11 | 12.5 | 15.5 | 20 | 25 | 30 | 37 | 48 | 52 |
| 380 V – 400 V | 3 | 4 | 5.5 | 3 | 4 | 5.5 | 7.5 | 7.5 | 11 | 15 | 18.5 | 18.5 | 22 | 30 | 37 | 45 | 55 | 75 | 90 |
| 440 V | 3.3 | 4.6 | 5.5 | 4.5 | 5.5 | 7.5 | 8.4 | 10.5 | 15.5 | 20 | 21 | 25 | 32 | 41 | 51 | 60 | 75 | 95 | 105 |
| 500 V | 3 | 4 | 5.5 | 3.5 | 4.5 | 7 | 7.5 | 12 | 17.5 | 23 | 24 | 28 | 36 | 47 | 58 | 70 | 85 | 110 | 120 |
| 660 V/690 V | 3 | 4 | 4 | 3.5 | 4.5 | 6.5 | 7 | 11 | 14 | 17 | 21 | 23 | 30 | 35 | 63 | 75 | 90 | 96 | 140 |
| 1000 V | - | - | - | - | - | - | - | - | - | - | - | - | - | - | - | - | - | - | - |

| AC-4 | Rated operational power for 3-phase motors 50–60 Hz | | | | | | | | | | | | | | | | | | |
|----------------------|---|----------|----------|------------|------------|----------|----------|------------|----------|----------|----------|----------|-----------|-----------|-----------|-----------|-----------|-----------|-----------|
| 220 V – 230 V | 1.1 | 1.5 | 1.5 | 1 | 1.5 | 2 | 2 | 2.5 | 3.5 | 4 | 4 | 5 | 6 | 7 | 12 | 16 | 17 | 20 | 20 |
| 380 V – 400 V | 2.2 | 3 | 3 | 2.2 | 2.5 | 3 | 3 | 4.5 | 6 | 7 | 7 | 9 | 10 | 12 | 20 | 26 | 28 | 33 | 33 |
| 440 V | 2.4 | 3.3 | 3.3 | 2.4 | 3 | 3.6 | 3.6 | 5.5 | 7 | 8 | 8 | 10 | 12 | 14 | 25 | 32 | 35 | 41 | 41 |
| 500 V | 2.2 | 3 | 3 | 2.5 | 2.8 | 3.5 | 3.5 | 6 | 8 | 9 | 9 | 11 | 13 | 16 | 29 | 36 | 40 | 47 | 47 |
| 660 V/690 V | 2.2 | 3 | 3 | 2.9 | 3.6 | 4.4 | 4.4 | 6.5 | 8.5 | 10 | 10 | 12 | 14 | 17 | 26 | 35 | 43 | 48 | 48 |
| 1000 V | - | - | - | - | - | - | - | - | - | - | - | - | - | - | - | - | - | - | - |

| AC-1 | Rated operational power under resistive load, 40 °C | | | | | | | | | | | | | | | | | | |
|------------------------------|---|-----------|-----------|-----------|-----------|-----------|-----------|-----------|-----------|-----------|-----------|-----------|-----------|-----------|-----------|-----------|------------|------------|------------|
| 220 V – 230 V | 8 | 8 | 8 | 8 | 8 | 8 | 8 | 15 | 17 | 17 | 17 | 22 | 30 | 37 | 42 | 49 | 61 | 72 | 85 |
| 380 V – 400 V | 13 | 13 | 13 | 14 | 14 | 14 | 14 | 26 | 29 | 29 | 29 | 39 | 53 | 65 | 72 | 85 | 105 | 125 | 150 |
| 400 V | 15 | 15 | 15 | 16 | 16 | 16 | 16 | 30 | 34 | 34 | 34 | 45 | 58 | 71 | 80 | 94 | 116 | 138 | 170 |
| 500 V | 18 | 18 | 18 | 19 | 19 | 19 | 19 | 34 | 38 | 38 | 38 | 51 | 66 | 81 | 90 | 107 | 132 | 156 | 194 |
| 660 V/690 V | 23 | 23 | 23 | 25 | 25 | 25 | 25 | 45 | 51 | 51 | 51 | 68 | 91 | 111 | 125 | 148 | 182 | 216 | 268 |
| 1000 V | - | - | - | - | - | - | - | - | - | - | - | - | - | - | - | - | - | - | - |
| Conventional thermal Current | A | A | A | A | A | A | A | A | A | A | A | A | A | A | A | A | A | A | A |
| $I_{th} = I_e$ open at 40 °C | 22 | 22 | 22 | 22 | 22 | 22 | 22 | 40 | 45 | 45 | 45 | 60 | 80 | 98 | 110 | 130 | 160 | 190 | 225 |

DILM, DILE(E)M, DILMP

Contactors

4 pole

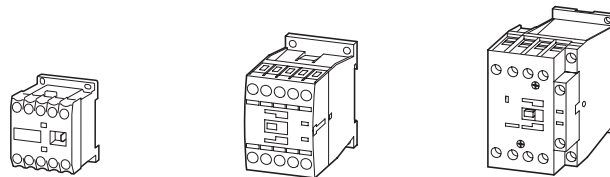

| DIL | EM4 | MP20 | MP32 |
|---------------------------|---|-----------|-----------|
| Rated operational voltage | → 4 | → Page 34 | → Page 34 |
| AC-1 | Conventional free air thermal current $I_{th} = I_e$ open, at 40 °C | | |
| up to 690 V | A | A | A |
| | 22 | 22 | 32 |

DILM, DILH, DILMP

Contactors
3 pole

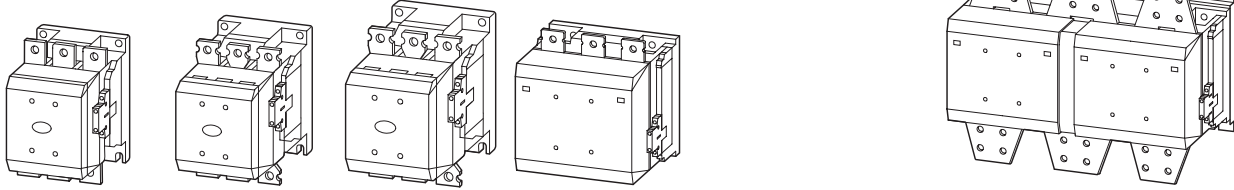

| M185A | M225A | M250A | M300A | M400 | M500 | M580 | M650 | M750 | M820 | M1000 | M1600 | M1400 | H2000 | H2200 | H2600 |
|-----------|-------|-----------|-------|------|------|-----------|------|-----------|------|-----------|-------|-------|-------|-------|-------|
| → Page 30 | | → Page 30 | | | | → Page 30 | | → Page 30 | | → Page 32 | | | | | |
| kW | kW | kW | kW | kW | kW | kW | kW | kW | kW | kW | kW | kW | kW | kW | kW |

| | | | | | | | | | | | | | | | |
|-----------|------------|------------|------------|------------|------------|------------|------------|------------|------------|------------|------------|---|---|---|---|
| 55 | 70 | 75 | 90 | 125 | 155 | 185 | 205 | 240 | 260 | 315 | 500 | - | - | - | - |
| 90 | 110 | 132 | 160 | 200 | 250 | 315 | 355 | 400 | 450 | 560 | 900 | - | - | - | - |
| 115 | 142 | 157 | 190 | 255 | 345 | 370 | 420 | 480 | 525 | 650 | 1000 | - | - | - | - |
| 132 | 160 | 180 | 215 | 290 | 360 | 420 | 470 | 550 | 600 | 730 | 1180 | - | - | - | - |
| 175 | 215 | 240 | 286 | 344 | 344 | 560 | 630 | 720 | 750 | 1000 | 1600 | - | - | - | - |
| 108 | 108 | 108 | 132 | 132 | 132 | 600 | 600 | 800 | 800 | 1000 | 1770 | - | - | - | - |

| | | | | | | | | | | | | | | | |
|-----------|-----------|------------|------------|------------|------------|------------|------------|------------|------------|------------|------------|---|---|---|---|
| 41 | 51 | 62 | 75 | 92 | 112 | 143 | 161 | 181 | 209 | 260 | 430 | - | - | - | - |
| 75 | 90 | 110 | 132 | 160 | 200 | 250 | 280 | 315 | 355 | 450 | 750 | - | - | - | - |
| 85 | 102 | 125 | 140 | 186 | 229 | 290 | 326 | 367 | 418 | 520 | 830 | - | - | - | - |
| 96 | 116 | 143 | 172 | 214 | 260 | 330 | 370 | 417 | 474 | 590 | 940 | - | - | - | - |
| 127 | 155 | 189 | 229 | 283 | 344 | 440 | 494 | 556 | 633 | 780 | 1300 | - | - | - | - |
| 108 | 108 | 108 | 132 | 132 | 132 | 509 | 509 | 678 | 678 | 1000 | 1650 | - | - | - | - |

| | | | | | | | | | | | | | | | |
|------------|------------|------------|------------|------------|------------|------------|------------|------------|------------|------------|-------------|-------------|-------------|-------------|-------------|
| 121 | 139 | 155 | 177 | 221 | 310 | 354 | 376 | 398 | 443 | 443 | 717 | 620 | 886 | 1075 | 1269 |
| 210 | 241 | 268 | 306 | 382 | 535 | 612 | 650 | 689 | 766 | 766 | 1247 | 1071 | 1531 | 1870 | 2207 |
| 243 | 279 | 310 | 354 | 443 | 620 | 709 | 753 | 797 | 886 | 886 | 1371 | 1240 | 1773 | 2058 | 2427 |
| 277 | 317 | 352 | 403 | 503 | 705 | 806 | 856 | 906 | 1007 | 1007 | 1558 | 1410 | 2015 | 2338 | 2758 |
| 365 | 419 | 465 | 532 | 664 | 930 | 1064 | 1130 | 1196 | 1330 | 1330 | 2151 | 1861 | 2660 | 3227 | 3806 |
| 554 | 635 | 705 | 806 | 1007 | 1410 | 1612 | 1712 | 1813 | 2015 | 2015 | 2420 | 2417 | 3223 | 4676 | 5516 |

| | | | | | | | | | | | | | | | |
|-----|-----|-----|-----|-----|-----|-----|------|------|------|------|------|------|------|------|------|
| A | A | A | A | A | A | A | A | A | A | A | A | A | A | A | A |
| 337 | 356 | 400 | 430 | 612 | 857 | 980 | 1041 | 1102 | 1225 | 1225 | 2200 | 1714 | 2450 | 2700 | 3185 |

DILM, DILE(E)M, DILMP

Contactors
4 pole

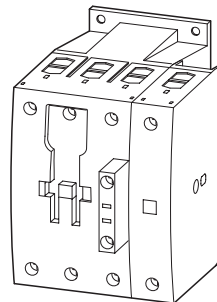
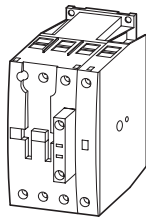

| MP45 | MP63 | MP80 | MP125 | MP160 | MP200 |
|-----------|------|-----------|-------|-----------|-------|
| → Page 34 | | → Page 34 | | → Page 34 | |
| A | A | A | A | A | A |
| 45 | 63 | 80 | 125 | 160 | 200 |

1.1 Contactors

1 System overview

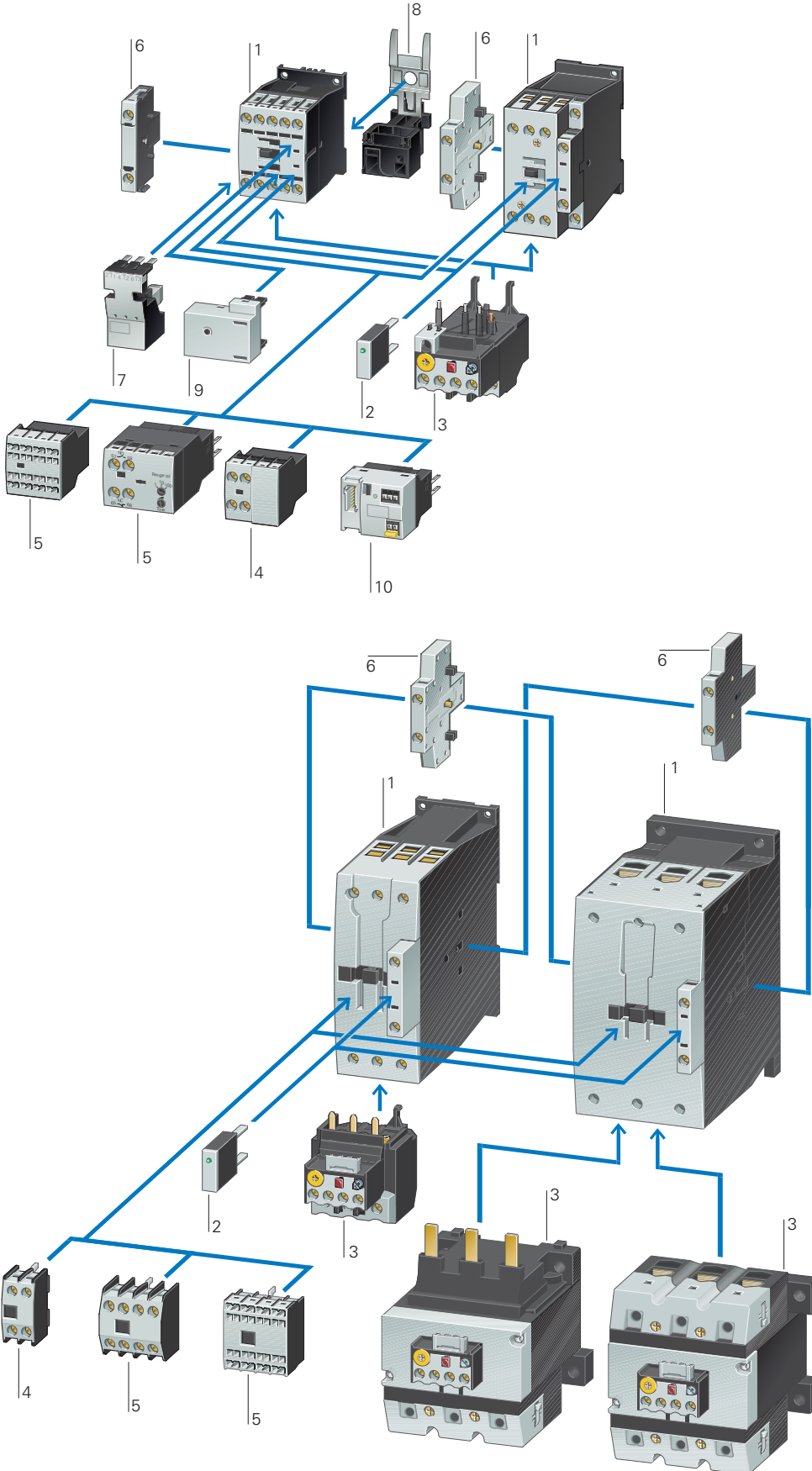

DILM7...DILM170

Contactors up to 90 kW (AC-3/400V) 1

3 pole

→ Page 18

4 pole

→ Page 34

Suppressor circuits 2

→ Page 50

Overload relays 3

→ Chapter 1.2 (Page 8)

Auxiliary contact modules 4

→ Page 36

Auxiliary contact modules 5

→ Page 36

Auxiliary contact modules 6

→ Page 39

Motor feeder plug 7

→ Page 58

PE module with contact plate 8

→ Page 58

Motor suppressor module 9

→ Page 59

SmartWire-DT® contactor module 10

→ Page 58

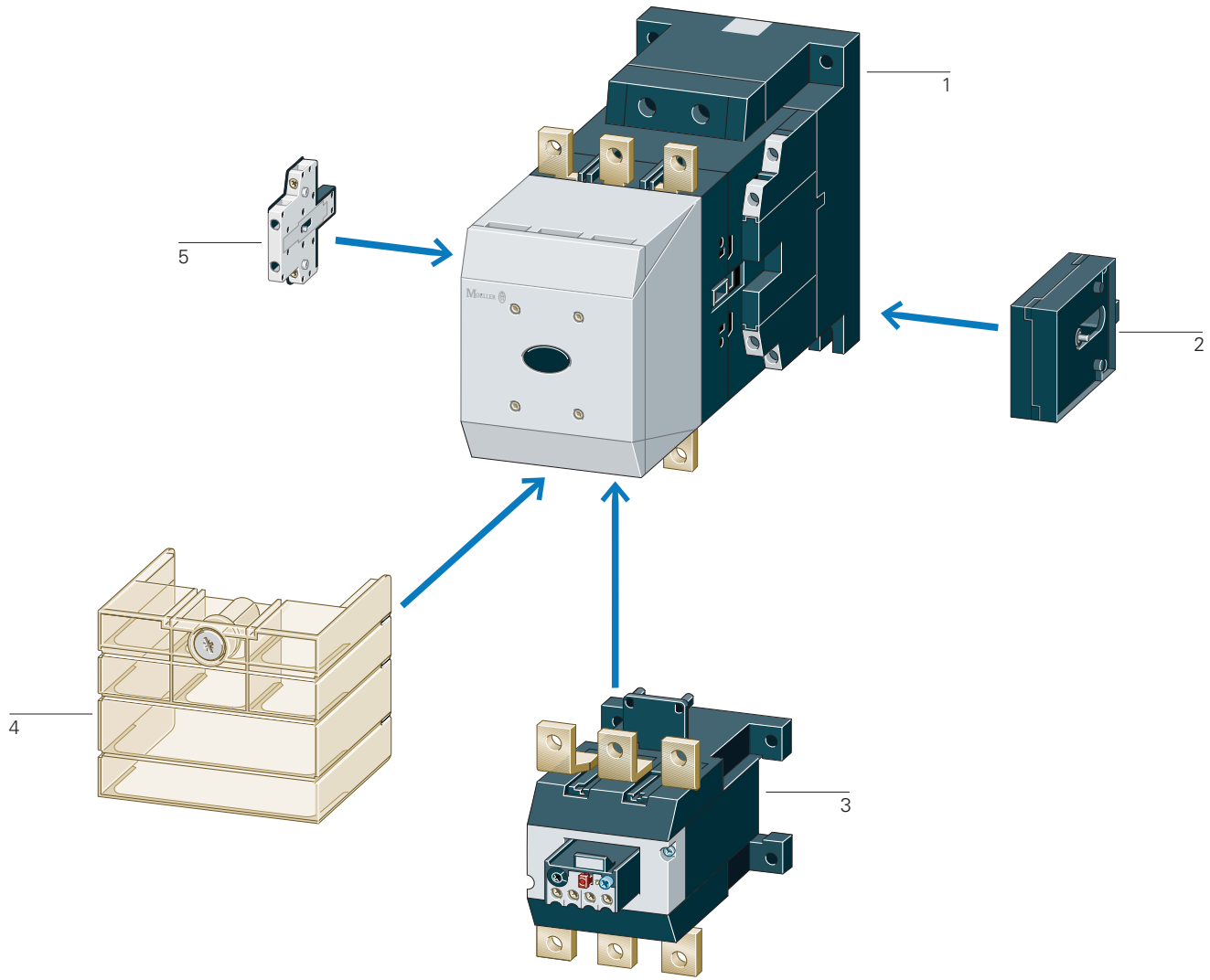

DILM185... DILH2600

| | |
|---|----------|
| Contactors 90 – 900 kW (AC-3/400 V) Comfort series | 1 |
| → Page 30 | |
| Standard range 90–250kW | 1 |
| → Page 28 | |

| | |
|-----------------------------|----------|
| Mechanical interlock | 2 |
| → Page 52 | |
| Overload relays | 3 |
| → Chapter 1.2 (Page 12) | |

| | |
|----------------------------------|----------|
| Terminal shroud | 4 |
| → Page 61 | |
| Auxiliary contact modules | 5 |
| → Page 39 | |

1.1

Contactors

Basic devices up to 170 A

1

DILM Basic device

Rated operational current

Max. motor rating for three-phase motors 50 - 60 Hz

Conventional thermal current $I_{th} = I_e$ AC-1 at 60 °C

Contact configuration

Circuit symbol

| AC-3 | AC-3 | | AC-4 | | Open | $I_{th} = I_e$ | A | Contact configuration | Circuit symbol | |
|-------------|----------------|----------------|----------------|----------------|------------|----------------|----|-----------------------|----------------|----------------|
| | 380 V 400 V | 220 V 230 V | 380 V 400 V | 660 V 690 V | | | | | | 220 V 230 V |
| 7 | 2.2 | 3 | 3.5 | 1 | 2.2 | 2.9 | 20 | 1 N/O | – | |
| 7 | 2.2 | 3 | 3.5 | 1 | 2.2 | 2.9 | 20 | – | 1 NC | |
| 9 | 2.5 | 4 | 4.5 | 1.5 | 2.5 | 3.6 | 20 | 1 N/O | – | |
| 9 | 2.5 | 4 | 4.5 | 1.5 | 2.5 | 3.6 | 20 | – | 1 NC | |
| 12 | 3.5 | 5.5 | 6.5 | 2 | 3 | 4.4 | 20 | 1 N/O | – | |
| 12 | 3.5 | 5.5 | 6.5 | 2 | 3 | 4.4 | 20 | – | 1 NC | |
| 15.5 | 4 | 7.5 | 7 | 2 | 3 | 4.4 | 20 | 1 N/O | – | |
| 15.5 | 4 | 7.5 | 7 | 2 | 3 | 4.4 | 20 | – | 1 NC | |
| 18 | 5 | 7.5 | 11 | 2.5 | 4.5 | 6.5 | 35 | 1 N/O | – | |
| 18 | 5 | 7.5 | 11 | 2.5 | 4.5 | 6.5 | 35 | – | 1 NC | |
| 25 | 7.5 | 11 | 14 | 3.5 | 6 | 8.5 | 40 | 1 N/O | – | |
| 25 | 7.5 | 11 | 14 | 3.5 | 6 | 8.5 | 40 | – | 1 NC | |
| 32 | 10 | 15 | 17 | 4 | 7 | 10 | 40 | 1 N/O | – | |
| 32 | 10 | 15 | 17 | 4 | 7 | 10 | 40 | – | 1 NC | |
| 38 | 11 | 18.5 | 21 | 4 | 7 | 10 | 40 | 1 N/O | – | |
| 38 | 11 | 18.5 | 21 | 4 | 7 | 10 | 40 | – | 1 NC | |

Screw terminals
3 pole

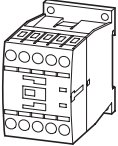

Screw terminals
3 pole

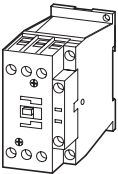

Information relevant for export to North America



| | |
|-------------------|--|
| Product Standards | IEC/EN 60947-4-1; UL 508; CSA-C22.2 No.14-05; CE marking |
| UL File No. | E29096 |
| UL CCN | NLDX |
| CSA File No. | 012528 |
| CSA Class No. | 2411-03, 3211-04 |
| NA Certification | UL Listed, CSA certified |
| See also | → Page 80 |

| | AC operation | DC operation | | | |
|--|--------------------------------|--------------------------------|--------------------------------|--------------------------------|-----------|
| Can be combined with auxiliary contact | Part no. Article no. | Part no. Article no. | Price See price list | Price See price list | Std. pack |

Notes

| | | | | | |
|---|---|--|--|--|--|
| DILM32-XHI.. DILA-XHI(V).. | DILM7-10(230V50Hz) 276550 | DILM7-10(24VDC) 276565 | | | |
| DILA-XHI(V).. | DILM7-01(230V50Hz) 276585 | DILM7-01(24VDC) 276600 | | | |
| DILM32-XHI.. DILA-XHI(V).. | DILM9-10(230V50Hz) 276690 | DILM9-10(24VDC) 276705 | | | |
| DILA-XHI(V).. | DILM9-01(230V50Hz) 276725 | DILM9-01(24VDC) 276740 | | | |
| DILM32-XHI.. DILA-XHI(V).. | DILM12-10(230V50Hz) 276830 | DILM12-10(24VDC) 276845 | | | |
| DILA-XHI(V).. | DILM12-01(230V50Hz) 276865 | DILM12-01(24VDC) 276880 | | | |
| DILM32-XHI.. DILA-XHI(V).. | DILM15-10(230V50Hz)¹⁾ 290058 | DILM15-10(24VDC)¹⁾ 290073 | | | |
| DILA-XHI(V).. | DILM15-01(230V50Hz)¹⁾ 290093 | DILM15-01(24VDC)¹⁾ 290108 | | | |
| DILM32-XHI.. DILA-XHI(V).. DILM32-XHI11-S | DILM17-10(230V50Hz) 277004 | DILM17-10(RDC24) 277018 | | | |
| DILA-XHI(V).. DILM32-XHI11-S | DILM17-01(230V50Hz) 277036 | DILM17-01(RDC24) 277050 | | | |
| DILM32-XHI.. DILA-XHI(V).. DILM32-XHI11-S | DILM25-10(230V50Hz) 277132 | DILM25-10(RDC24) 277146 | | | |
| DILA-XHI(V).. DILM32-XHI11-S | DILM25-01(230V50Hz) 277164 | DILM25-01(RDC24) 277178 | | | |
| DILM32-XHI.. DILA-XHI(V).. DILM32-XHI11-S | DILM32-10(230V50Hz) 277260 | DILM32-10(RDC24) 277274 | | | |
| DILA-XHI(V).. DILM32-XHI11-S | DILM32-01(230V50Hz) 277292 | DILM32-01(RDC24) 277306 | | | |
| DILM32-XHI.. DILA-XHI(V).. DILM32-XHI11-S | DILM38-10(230V50Hz)¹⁾ 112428 | DILM38-10(RDC24)¹⁾ 112442 | | | |
| DILA-XHI(V).. DILM32-XHI11-S | DILM38-01(230V50Hz)¹⁾ 112456 | DILM38-01(RDC24)¹⁾ 112470 | | | |

1 off

Contacts to EN 50 012.
For all DC operated contactors DILM7 - DILM15 the following applies:

- Integrated varistor-suppressor circuit.

For DC operated contactors DILM17 - DILM170 the following applies:

- Integrated suppressor circuit in actuating electronics

For AC operated contactors DILM115 - DILM170 the following applies:

- Integrated suppressor circuit in actuating electronics
- With mirror contact.

¹⁾ Electrical lifespan → 87

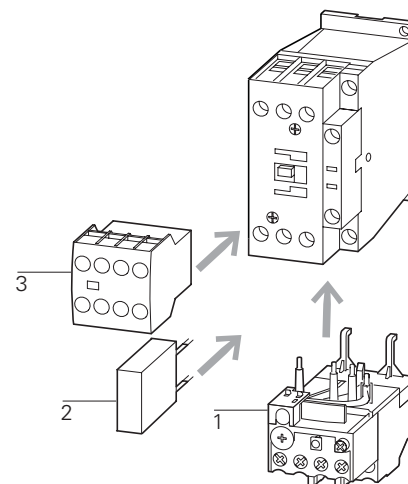

Accessories

- 1 Overload relay
- 2 Suppressor
- 3 Auxiliary contact module
- Further actuating voltages
- Accessories

Page

- Chapter 1.2
- 50
- 36
- 69
- 52

1.1

Contactors

Basic devices up to 170 A

1

DILM Basic device

Rated operational current

Max. motor rating for three-phase motors 50 - 60 Hz

Conventional thermal current $I_{th} = I_e$ AC-1 at 60 °C

Contact configuration

Circuit symbol

| AC-3 | AC-3 | | AC-4 | | AC-4 | | |
|--------------|-------|--------------|-------|-------|--------------|-------|------|
| 380 V | 220 V | 380 V | 660 V | 220 V | 380 V | 660 V | Open |
| 400 V | 230 V | 400 V | 690 V | 230 V | 400 V | 690 V | |

N/O = normally open contact
NC = normally closed contact

Screw terminals
3 pole

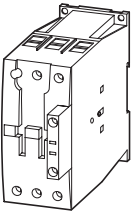

Screw terminals
3 pole

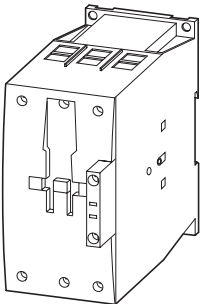

| I_e A | P kW | P kW | P kW | P kW | P kW | P kW | $I_{th} = I_e$ A | | | |
|------------|---------|----------------|---------|---------|----------------|---------|---------------------|---|---|--|
| 40 | 12.5 | 18.5 | 23 | 5 | 9 | 12 | 50 | — | — | |
| 50 | 15.5 | 22 | 30 | 6 | 10 | 14 | 65 | — | — | |
| 65 | 20 | 30 | 35 | 7 | 12 | 17 | 80 | — | — | |
| 72 | 25 | 37 | 35 | 7 | 12 | 17 | 80 | — | — | |
| 80 | 25 | 37 | 63 | 12 | 20 | 26 | 90 | — | — | |
| 95 | 30 | 45 | 75 | 16 | 26 | 35 | 110 | — | — | |
| 115 | 37 | 55 | 90 | 17 | 28 | 43 | 130 | — | — | |
| 150 | 48 | 75 | 96 | 20 | 33 | 48 | 160 | — | — | |
| 170 | 52 | 90 | 140 | 20 | 33 | 48 | 185 | — | — | |

Information relevant for export to North America



| | |
|-------------------|--|
| Product Standards | IEC/EN 60947-4-1; UL 508; CSA-C22.2 No.14-05; CE marking |
| UL File No. | E29096 |
| UL CCN | NLDX |
| CSA File No. | 012528 |
| CSA Class No. | 2411-03, 3211-04 |
| NA Certification | UL Listed, CSA certified |
| See also | → Page 80 |

| | | | | | | |
|--|--|--------------------------------|--|--------------------------------|-----------|--------------|
| Can be combined with auxiliary contact | AC operation Part no. Article no. | Price See price list | DC operation Part no. Article no. | Price See price list | Std. pack | Notes |
|--|--|--------------------------------|--|--------------------------------|-----------|--------------|

| | | |
|---------------------------------------|--|--|
| DILM150-XHI(V).. DILM1000-XHI(V).. | DILM40(230V50Hz) 277766 | DILM40(RDC24) 277780 |
| DILM150-XHI(V).. DILM1000-XHI(V).. | DILM50(230V50Hz) 277830 | DILM50(RDC24) 277844 |
| DILM150-XHI(V).. DILM1000-XHI(V).. | DILM65(230V50Hz) 277894 | DILM65(RDC24) 277908 |
| DILM150-XHI(V).. DILM1000-XHI(V).. | DILM72(230V50Hz)¹⁾ 107670 | DILM72(RDC24)¹⁾ 107671 |
| DILM150-XHI(V).. DILM1000-XHI(V).. | DILM80(230V50Hz) 239402 | DILM80(RDC24) 239416 |
| DILM150-XHI(V).. DILM1000-XHI(V).. | DILM95(230V50Hz) 239480 | DILM95(RDC24) 239510 |
| DILM150-XHI(V).. DILM1000-XHI(V).. | DILM115(RAC240) 239548 | DILM115(RDC24) 239555 |
| DILM150-XHI(V).. DILM1000-XHI(V).. | DILM150(RAC240) 239588 | DILM150(RDC24) 239591 |
| DILM150-XHI(V).. DILM1000-XHI(V).. | DILM170(RAC240)¹⁾ 107013 | DILM170(RDC24)¹⁾ 107016 |



Contacts to EN 50012.
For all DC operated contactors DILM7 - DILM15 the following applies:
 • Integrated varistor-suppressor circuit.
 For DC operated contactors DILM17 - DILM170 the following applies:
 • Integrated suppressor circuit in actuating electronics
 For AC operated contactors DILM115 - DILM170 the following applies:
 • Integrated suppressor circuit in actuating electronics
 For DILM7-01 – DILM38-01 the following applies:
 • With mirror contact.

¹⁾ Electrical lifespan → 87

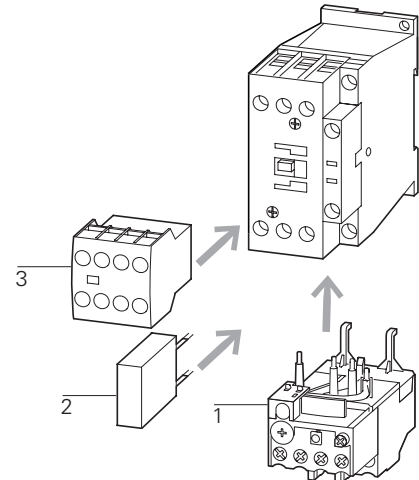

| | |
|----------------------------|---------------|
| Accessories | Page |
| 1 Overload relay | → Chapter 1.2 |
| 2 Suppressor | → 50 |
| 3 Auxiliary contact module | → 36 |
| Further actuating voltages | → 71 |
| Accessories | → 52 |

1.1

Contactors

Basic devices up to 170 A

1

DILM Basic device

| Rated operational current | Max. motor rating for three-phase motors 50 - 60 Hz | | | | | | Conventional thermal current $I_{th} = I_e$ AC-1 at 60 °C | Contact configuration | Circuit symbol | |
|------------------------------|---|--------------|-------|-------|--------------|-------|---|---|----------------|--|
| | AC-3 | | AC-3 | | AC-4 | | | | | |
| 380 V 400 V | 220 V | 380 V | 660 V | 220 V | 380 V | 660 V | Open | N/O = normally open contact NC = normally closed contact | | |
| I_e A | 230 V | 400 V | 690 V | 230 V | 400 V | 690 V | | | | |
| | P | P | P | P | P | P | $I_{th} = I_e$ A | | | |
| | kW | kW | kW | kW | kW | kW | | | | |
| 7 | 2.2 | 3 | 3.5 | 1 | 2.2 | 2.9 | 20 | 1 N/O | – | |
| 7 | 2.2 | 3 | 3.5 | 1 | 2.2 | 2.9 | 20 | – | 1 NC | |
| 9 | 2.5 | 4 | 4.5 | 1.5 | 2.5 | 3.6 | 20 | 1 N/O | – | |
| 9 | 2.5 | 4 | 4.5 | 1.5 | 2.5 | 3.6 | 20 | – | 1 NC | |
| 12 | 3.5 | 5.5 | 6.5 | 2 | 3 | 4.4 | 20 | 1 N/O | – | |
| 12 | 3.5 | 5.5 | 6.5 | 2 | 3 | 4.4 | 20 | – | 1 NC | |
| 15.5 | 4 | 7.5 | 7 | 2 | 3 | 4.4 | 20 | 1 N/O | – | |
| 15.5 | 4 | 7.5 | 7 | 2 | 3 | 4.4 | 20 | – | 1 NC | |
| 18 | 5 | 7.5 | 11 | 2.5 | 4.5 | 6.5 | 35 | 1 N/O | – | |
| 18 | 5 | 7.5 | 11 | 2.5 | 4.5 | 6.5 | 35 | – | 1 NC | |
| 25 | 7.5 | 11 | 14 | 3.5 | 6 | 8.5 | 40 | 1 N/O | – | |
| 25 | 7.5 | 11 | 14 | 3.5 | 6 | 8.5 | 40 | – | 1 NC | |
| 32 | 10 | 15 | | | 7 | 10 | 40 | 1 N/O | – | |
| 32 | 10 | 15 | | | 7 | 10 | 40 | – | 1 NC | |
| 40 | 12.5 | 18.5 | | | 9 | 12 | 50 | – | – | |
| 50 | 15.5 | 22 | | | 10 | 14 | 65 | – | – | |
| 65 | 20 | 30 | | | 12 | 17 | 80 | – | – | |
| 80 | 25 | 37 | 63 | 12 | 20 | 26 | 90 | – | – | |
| 95 | 30 | 45 | 75 | 16 | 26 | 35 | 110 | – | – | |
| 115 | 37 | 55 | 90 | 17 | 28 | 43 | 130 | – | – | |
| 150 | 48 | 75 | 96 | 20 | 33 | 48 | 160 | – | – | |

Spring-loaded terminals 3 pole

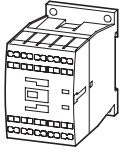

Spring-loaded terminals on auxiliary and control circuit terminals 3 pole

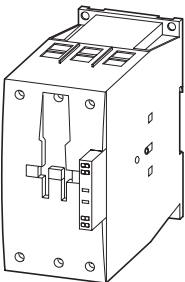
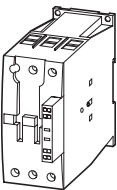
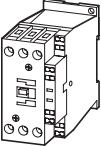

Information relevant for export to North America



| | |
|-------------------|--|
| Product Standards | IEC/EN 60947-4-1; UL 508; CSA-C22.2 No.14-05; CE marking |
| UL File No. | E29096 |
| UL CCN | NLDX |
| CSA File No. | 012528 |
| CSA Class No. | 2411-03, 3211-04 |
| NA Certification | UL Listed, CSA certified |
| See also | → Page 80 |

Can be combined with auxiliary contact

AC operation

DC operation

Std. pack

Notes

Part no.
Article no.

Price
See price list

Part no.
Article no.

Price
See price list

| | | |
|-----------------------------------|---------------------------------------|------------------------------------|
| DILM32-XHIC.. DILA-XHIC(V).. | DILMC7-10(230V50Hz) 277389 | DILMC7-10(24VDC) 277404 |
| DILA-XHIC(V).. | DILMC7-01(230V50Hz) 277421 | DILMC7-01(24VDC) 277436 |
| DILM32-XHIC.. DILA-XHIC(V).. | DILMC9-10(230V50Hz) 277453 | DILMC9-10(24VDC) 277468 |
| DILA-XHIC(V).. | DILMC9-01(230V50Hz) 277485 | DILMC9-01(24VDC) 277500 |
| DILM32-XHIC.. DILA-XHIC(V).. | DILMC12-10(230V50Hz) 277517 | DILMC12-10(24VDC) 277532 |
| DILA-XHIC(V).. | DILMC12-01(230V50Hz) 277549 | DILMC12-01(24VDC) 277564 |
| DILM32-XHIC... DILA-XHIC(V)... | DILMC15-10(230V50Hz) 293911 | DILMC15-10(24VDC) 293926 |
| DILA-XHIC(V)... | DILMC15-01(230V50Hz) 293946 | DILMC15-01(24VDC) 293961 |
| DILM32-XHIC.. DILA-XHIC(V).. | DILMC17-10(230V50Hz) 277581 | DILMC17-10(RDC24) 277595 |
| DILA-XHIC(V).. | DILMC17-01(230V50Hz) 277611 | DILMC17-01(RDC24) 277625 |
| DILM32-XHIC.. DILA-XHIC(V).. | DILMC25-10(230V50Hz) 277641 | DILMC25-10(RDC24) 277655 |
| DILA-XHIC(V).. | DILMC25-01(230V50Hz) 277671 | DILMC25-01(RDC24) 277685 |
| DILM32-XHIC.. DILA-XHIC(V).. | DILMC32-10(230V50Hz) 277701 | DILMC32-10(RDC24) 277715 |
| DILA-XHIC(V).. | DILMC32-01(230V50Hz) 277731 | DILMC32-01(RDC24) 277745 |
| DILM150-XHIC(V).. | DILMC40(230V50Hz) 277965 | DILMC40(RDC24) 277979 |
| DILM1000-XHIC.. | DILMC50(230V50Hz) 277995 | DILMC50(RDC24) 278009 |
| | DILMC65(230V50Hz) 278025 | DILMC65(RDC24) 278039 |
| | DILMC80(230V50Hz) 239618 | DILMC80(RDC24) 239652 |
| | DILMC95(230V50Hz) 239685 | DILMC95(RDC24) 239715 |
| | DILMC115(RAC240) 239736 | DILMC115(RDC24) 239741 |
| | DILMC150(RAC240) 239751 | DILMC150(RDC24) 239765 |

1 off

Contacts to EN 50 012.

For DILMC7 – DILMC15 the following applies:

- Auxiliary coil, and main current terminals with spring-loaded terminals.

For DILMC17 – DILMC150 the following applies:

- Auxiliary connections, coil connections with spring-loaded connection terminals.
- Main current connections with screw terminals.

For DC operated contactors DILMC7 - DILMC15 the following applies:

- Integrated varistor-suppressor circuit.

For DC operated contactors DILMC17 - DILMC150 the following applies:

- Integrated suppressor circuit in actuating electronics

For AC operated contactors DILMC115 - DILMC150 the following applies:

- Integrated suppressor circuit in actuating electronics

For DILMC7-01 – DILMC32-01 the following applies:

- With mirror contact.

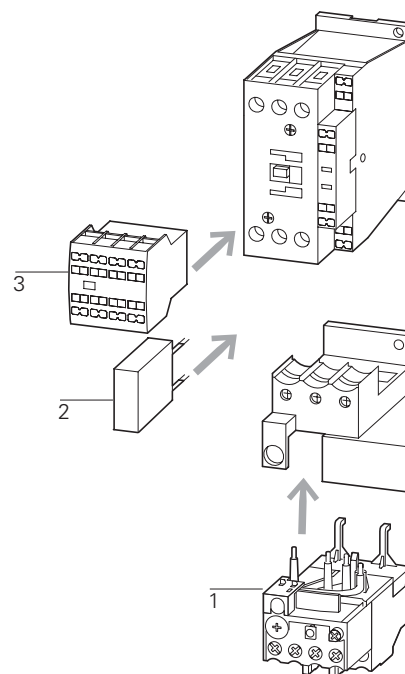

Accessories

- 1 Overload relay
- 2 Suppressor
- 3 Auxiliary contact module
- Further actuating voltages
- Accessories

Page

- Chapter 1.2
- 50
- 36
- 73
- 52

1.1

Contactors

Complete device up to 170 A

1

DILM complete device

| Rated operational current AC-3 | Max. motor rating for three-phase motors 50 - 60 Hz | | | | | | Conventional free air thermal current $I_{th} = I_e$ AC-1 at 60 °C | Contact configuration: ⊕ = Safety function by positive opening according to IEC/EN 60947-5-1 | Circuit symbol | |
|-----------------------------------|---|------------------------------|----------------|----------------|------------------------------|----------------|---|---|----------------|--|
| | AC-3 | | | AC-4 | | | | | | |
| 380 V 400 V | 220 V 230 V | 380 V 400 V | 660 V 690 V | 220 V 230 V | 380 V 400 V | 660 V 690 V | Open $I_{th} = I_e$ | N/O = normally open contact NC = normally closed contact | | |
| I_e | P | P | P | P | P | P | A | | | |
| A | kW | kW | kW | kW | kW | kW | | | | |
| 7 | 2.2 | 3 | 3.5 | 1 | 2.2 | 2.9 | 20 | 2 N/O | 1 NC | |
| 7 | 2.2 | 3 | 3.5 | 1 | 2.2 | 2.9 | 20 | 2 N/O | 1 NC | |
| 7 | 2.2 | 3 | 3.5 | 1 | 2.2 | 2.9 | 20 | 3 N/O | 2 NC | |
| 9 | 2.5 | 4 | 4.5 | 1.5 | 2.5 | 3.6 | 20 | 2 N/O | 1 NC | |
| 9 | 2.5 | 4 | 4.5 | 1.5 | 2.5 | 3.6 | 20 | 2 N/O | 1 NC | |
| 9 | 2.5 | 4 | 4.5 | 1.5 | 2.5 | 3.6 | 20 | 3 N/O | 2 NC | |
| 12 | 3.5 | 5.5 | 6.5 | 2 | 3 | 4.4 | 20 | 2 N/O | 1 NC | |
| 12 | 3.5 | 5.5 | 6.5 | 2 | 3 | 4.4 | 20 | 2 N/O | 1 NC | |
| 12 | 3.5 | 5.5 | 6.5 | 2 | 3 | 4.4 | 20 | 3 N/O | 2 NC | |
| 15.5 | 4 | 7.5 | 7 | 2 | 3 | 4.4 | 20 | 2 N/O | 2 NC | |
| 18 | 5 | 7.5 | 11 | 2.5 | 4.5 | 6.5 | 35 | 2 N/O | 1 NC | |
| 18 | 5 | 7.5 | 11 | 2.5 | 4.5 | 6.5 | 35 | 2 N/O | 1 NC | |
| 18 | 5 | 7.5 | 11 | 2.5 | 4.5 | 6.5 | 35 | 3 N/O | 2 NC | |
| 25 | 7.5 | 11 | 14 | 3.5 | 6 | 8.5 | 40 | 2 N/O | 1 NC | |
| 25 | 7.5 | 11 | 14 | 3.5 | 6 | 8.5 | 40 | 2 N/O | 1 NC | |
| 25 | 7.5 | 11 | 14 | 3.5 | 6 | 8.5 | 40 | 3 N/O | 2 NC | |
| 32 | 10 | 15 | 17 | 4 | 7 | 10 | 40 | 2 N/O | 1 NC | |
| 32 | 10 | 15 | 17 | 4 | 7 | 10 | 40 | 2 N/O | 1 NC | |
| 32 | 10 | 15 | 17 | 4 | 7 | 10 | 40 | 3 N/O | 2 NC | |

Screw terminals

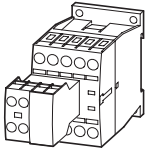

Screw terminals

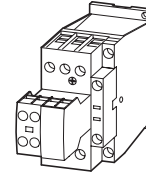

Information relevant for export to North America



| | |
|-------------------|--|
| Product Standards | IEC/EN 60947-4-1; UL 508; CSA-C22.2 No.14-05; CE marking |
| UL File No. | E29096 |
| UL CCN | NLDX |
| CSA File No. | 012528 |
| CSA Class No. | 2411-03, 3211-04 |
| NA Certification | UL Listed, CSA certified |
| See also | → Page 80 |

| AC operation | | DC operation | | Std. pack | Notes |
|-------------------------|----------------------------|-------------------------|----------------------------|-----------|-------|
| Part no. Article no. | Price See price list | Part no. Article no. | Price See price list | | |

| | |
|--------------------------------------|-----------------------------------|
| DILM7-21(230V50Hz) 276620 | DILM7-21(24VDC) 276635 |
| DILM7-22(230V50Hz) 106360 | DILM7-22(24VDC) 106367 |
| DILM7-32(230V50Hz) 276655 | DILM7-32(24VDC) 276670 |
| DILM9-21(230V50Hz) 276760 | DILM9-21(24VDC) 276775 |
| DILM9-22(230V50Hz) 106361 | DILM9-22(24VDC) 106368 |
| DILM9-32(230V50Hz) 276795 | DILM9-32(24VDC) 276810 |
| DILM12-21(230V50Hz) 276900 | DILM12-21(24VDC) 276915 |
| DILM12-22(230V50Hz) 106362 | DILM12-22(24VDC) 106369 |
| DILM12-32(230V50Hz) 276935 | DILM12-32(24VDC) 276950 |
| DILM15-22(230V50Hz) 106363 | DILM15-22(24VDC) 106370 |
| DILM17-21(230V50Hz) 277068 | DILM17-21(RDC24) 277082 |
| DILM17-22(230V50Hz) 106364 | DILM17-22(RDC24) 106371 |
| DILM17-32(230V50Hz) 277100 | DILM17-32(RDC24) 277114 |
| DILM25-21(230V50Hz) 277196 | DILM25-21(RDC24) 277210 |
| DILM25-22(230V50Hz) 106365 | DILM25-22(RDC24) 106372 |
| DILM25-32(230V50Hz) 277228 | DILM25-32(RDC24) 277242 |
| DILM32-21(230V50Hz) 277324 | DILM32-21(RDC24) 277338 |
| DILM32-22(230V50Hz) 106366 | DILM32-22(RDC24) 106373 |
| DILM32-32(230V50Hz) 277356 | DILM32-32(RDC24) 277370 |

1 off

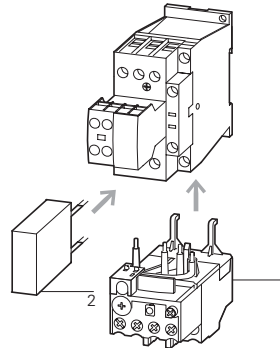
Accessories

- 1 Overload relay
- 2 Suppressor
- Accessories

Page

- Chapter 1.2
- 50
- 52

For all DC operated contactors DILM7 - DILM15 the following applies:

- Integrated varistor suppressor circuit.

For DC operated contactors DILM17 - DILM170 the following applies:

- Integrated suppressor circuit in actuating electronics

For AC operated contactors DILM115 - DILM170 the following applies:

- Integrated suppressor circuit in actuating electronics

For DILM7 - DILM150 the following applies:

- With mirror contact.

Contacts to EN 50012

1.1

Contactors

Complete device up to 170 A

1

DILM complete device

| Rated operational current AC-3 | Max. motor rating for three-phase motors 50 - 60 Hz | | | | | | Conventional free air thermal current $I_{th} = I_e$ AC-1 at 60 °C | Contact configuration: ⊕ = Safety function by positive opening according to IEC/EN 60947-5-1 | Circuit symbol | |
|-----------------------------------|---|-------------|-------|-------|-----------|-------|---|---|------------------------------|--|
| | AC-3 | | | AC-4 | | | | | | |
| | 220 V | 380 V | 660 V | 220 V | 380 V | 660 V | | | | |
| I_e | P | P | P | P | P | P | Open $I_{th} = I_e$ | N/O = normally open contact | NC = normally closed contact | |
| A | kW | kW | kW | kW | kW | kW | A | | | |
| 40 | 12.5 | 18.5 | 23 | 5 | 9 | 12 | 50 | 2 N/O | 2 NC | |
| 50 | 15.5 | 22 | 30 | 6 | 10 | 14 | 65 | 2 N/O | 2 NC | |
| 65 | 20 | 30 | 35 | 7 | 12 | 17 | 80 | 2 N/O | 2 NC | |
| 80 | 25 | 37 | 63 | 12 | 20 | 26 | 90 | 2 N/O | 2 NC | |
| 95 | 30 | 45 | 75 | 16 | 26 | 35 | 110 | 2 N/O | 2 NC | |
| 115 | 37 | 55 | 90 | 17 | 28 | 43 | 130 | 2 N/O | 2 NC | |
| 150 | 48 | 75 | 96 | 20 | 34 | 48 | 160 | 2 N/O | 2 NC | |

Screw terminals

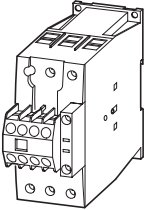

Screw terminals

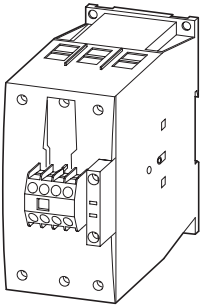

Information relevant for export to North America

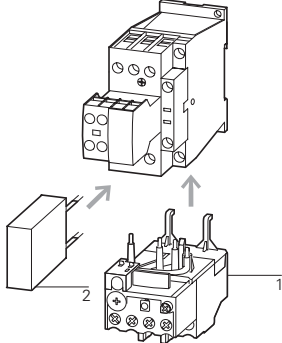

| | |
|-------------------|--|
| Product Standards | IEC/EN 60947-4-1; UL 508; CSA-C22.2 No.14-05; CE marking |
| UL File No. | E29096 |
| UL CCN | NLDX |
| CSA File No. | 012528 |
| CSA Class No. | 2411-03, 3211-04 |
| NA Certification | UL Listed, CSA certified |
| See also | → Page 80 |

| AC operation | | DC operation | | Std. pack | Notes |
|--------------------------------------|----------------------------|------------------------------------|----------------------------|--|--|
| Part no. Article no. | Price See price list | Part no. Article no. | Price See price list | | |
| DILM40-22(230V50Hz) 277798 | | DILM40-22(RDC24) 277812 | | 1 off  |  |
| DILM50-22(230V50Hz) 277862 | | DILM50-22(RDC24) 277876 | | | |
| DILM65-22(230V50Hz) 277926 | | DILM65-22(RDC24) 277940 | | | |
| DILM80-22(230V50Hz) 239449 | | DILM80-22(RDC24) 239463 | | | |
| DILM95-22(230V50Hz) 239527 | | DILM95-22(RDC24) 239541 | | | |
| DILM115-22(RAC240) 239578 | | DILM115-22(RDC24) 239581 | | | |
| DILM150-22(RAC240) 239598 | | DILM150-22(RDC24) 239601 | | | |

| Accessories | Page |
|------------------|---------------|
| 1 Overload relay | → Chapter 1.2 |
| 2 Suppressor | → 50 |
| Accessories | → 52 |

For DC operated contactors DILM17 - DILM170 the following applies:

- Integrated suppressor circuit in actuating electronics

For AC operated contactors DILM115 - DILM170 the following applies:

- Integrated suppressor circuit in actuating electronics

For DILM7 - DILM150 the following applies:

- With mirror contact.

Contacts to EN 50012

1.1

Contactors DILM, DILH

Standard devices greater than 150 A

1

DILM...S/22... Standard device for currents greater than 150 A

| Rated operational current | Max. motor rating for three-phase motors 50 - 60 Hz | | | | | | Conventional thermal current $I_{th} = I_e$ AC-1 at 40 °C Open $I_{th} = I_e$ | Circuit symbol | For use with |
|-------------------------------------|---|------------------------------|----------------|----------------|------------------------------|----------------|---|----------------|----------------|
| | AC-3 | | AC-3 | | AC-4 | | | | |
| 380 V 400 V | 220 V 230 V | 380 V 400 V | 660 V 690 V | 220 V 230 V | 380 V 400 V | 660 V 690 V | | | |
| I_e A | P kW | P kW | P kW | P kW | P kW | P kW | | | |
| 250 | 75 | 132 | 240 | 62 | 110 | 189 | 400 | | DILM820-XHI... |
| 300 | 90 | 160 | 195 | 75 | 132 | 160 | 430 | | DILM820-XHI... |
| 400 | 125 | 200 | 344 | 92 | 160 | 283 | 612 | | DILM820-XHI... |
| 500 | 155 | 250 | 344 | 112 | 200 | 344 | 857 | | DILM820-XHI... |
| 580 | 185 | 315 | 344 | 112 | 200 | 344 | 920 | | DILM820-XHI... |

DILM complete device

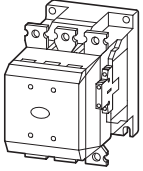

DILM complete device

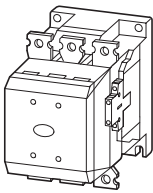

Notes

¹⁾ Availability from August 2010.
Previous DILM300/22, see Online Catalog at <http://www.eaton.com/seasia-electrical>

For all contactors the following applies:

- 660 V, 690 V or 1000 V: do not reverse directly
- Integrated suppressor circuit in actuating electronics.

DILM...S contactors are actuated conventionally

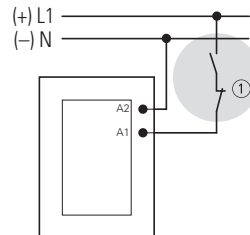





① Stopping in the event of an emergency (emergency switching off)

Accessories

- Auxiliary contact modules
- Enclosures totally insulated
- Further actuating voltages

Page

- 38
- 77

| Part no. Article no. | Price See price list | Std. pack | Information relevant for export to North America | |
|--|-------------------------|---|---|--|
| DILM250-S/22(220-240V50/60Hz) 274190 | 1 off |  | Product Standards UL File No. UL CCN CSA File No. CSA Class No. NA Certification | IEC/EN 60947-4-1; UL 508; CSA-C22.2 No.14-05; CE marking E29096 NLDX 1017510 3211-04 UL Listed, CSA certified |
| DILM300A-S/22(220-240V50/60Hz)¹⁾ 139559 | 1 off |  | Request filed for UL and CSA | |
| DILM400-S/22(220-240V50/60Hz) 274196 | 1 off |  | Product Standards UL File No. UL CCN CSA File No. CSA Class No. NA Certification See also | IEC/EN 60947-4-1; UL 508; CSA-C22.2 No.14-05; CE marking E29096 NLDX 012528 3211-04 UL Listed, CSA certified |
| DILM500-S/22(220-240V50/60Hz) 274199 | 1 off |  | Product Standards UL File No. UL CCN CSA File No. CSA Class No. NA Certification See also | IEC/EN 60947-4-1; UL 508; CSA-C22.2 No.14-05; CE marking E29096 NLDX 012528 3211-04 UL Listed, CSA certified |
| DILM570-S/22(220-240V50/60Hz) 110744 | 1 off |  | Product Standards UL File No. UL CCN CSA File No. CSA Class No. NA Certification See also | IEC/EN 60947-4-1; UL 508; CSA-C22.2 No.14-05; CE marking E29096 NLDX 012528 3211-04 UL Listed, CSA certified Additional approvals, → Page 82 |

1.1

Contactors DILM, DILH

Comfort devices greater than 150 A

1

DILM, DILH

Rated operational current

Max. motor rating for three-phase motors 50 - 60 Hz

Conventional thermal current $I_{th} = I_e$
AC-1 at 60 °C

Circuit symbol

| AC-3 380 V 400 V I_e A | AC-3 | | | AC-4 | | | Open $I_{th} = I_e$ | A |
|--------------------------------------|----------------|----------------|----------------|--------|----------------|----------------|------------------------|----|
| | 220 V 230 V | 380 V 400 V | 660 V 690 V | 1000 V | 220 V 230 V | 380 V 400 V | | |
| | P | P | P | P | P | P | P | P |
| | kW | kW | kW | kW | kW | kW | kW | kW |

Contactors, comfort DILM

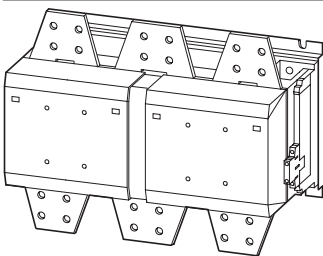
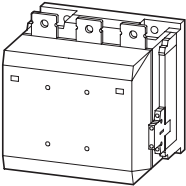
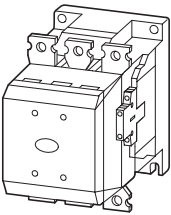
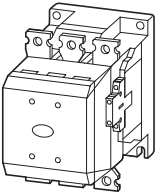
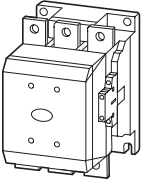

| | | | | | | | | | | |
|-------------|-----|------------|------|------|-----|------------|------|------|------|--|
| 185 | 55 | 90 | 140 | 108 | 41 | 75 | 102 | 77 | 275 | |
| 225 | 70 | 110 | 150 | 108 | 51 | 90 | 110 | 77 | 315 | |
| 250 | 75 | 132 | 195 | 108 | 62 | 110 | 160 | 109 | 330 | |
| 300 | 90 | 160 | 195 | 132 | 75 | 132 | 160 | 109 | 350 | |
| 400 | 125 | 200 | 344 | 132 | 92 | 160 | 283 | 132 | 500 | |
| 500 | 155 | 250 | 344 | 132 | 112 | 200 | 344 | 132 | 700 | |
| 580 | 185 | 315 | 560 | 600 | 143 | 250 | 440 | 509 | 800 | |
| 650 | 205 | 355 | 630 | 600 | 161 | 280 | 494 | 509 | 850 | |
| 750 | 240 | 400 | 720 | 800 | 181 | 315 | 556 | 678 | 900 | |
| 820 | 260 | 450 | 750 | 800 | 209 | 355 | 633 | 678 | 1000 | |
| 1000 | 315 | 560 | 1000 | 1100 | 260 | 450 | 780 | 1000 | 1000 | |
| 1600 | 500 | 900 | 1600 | 1770 | 430 | 750 | 1300 | 1650 | 1800 | |

Notes

¹⁾ Availability from August 2010.

Previous DILM185/22 to DILM300/22, see Online Catalog at <http://www.eaton.com/seasia-electrical>

For all contactors the following applies:

- 660 V, 690 V or 1000 V: do not reverse directly
- Integrated suppressor circuit in actuating electronics.

When operating contactors DILM580 to DILM1600 behind a frequency inverter or mains with strong harmonic loads, the suppressor circuit on the load side must be removed.

During high-voltage tests, the suppressor circuit on the load-side for DILM580 to DILH2600 contactors must be disconnected (see instructional leaflet).

Control voltages

RA250 $\hat{=}$ 110 V - 250 V AC/DC

RAW250 $\hat{=}$ 230 V - 250 V AC/DC

Accessories

Auxiliary contact modules

Suppressor circuits on load side

Enclosures

Further actuating voltages

Page

→ 38

→ 61

totally insulated

→ 72

Part no.
Article no.

Price
See price list

Std. pack

Notes

DILM185A/22(RAC240)¹⁾
139537



Conventional
A1/A2 are attached to power supply as normal

DILM 185 A, DILM 225 A

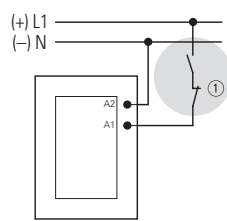

DILM250 to DILM1000, DILH1400

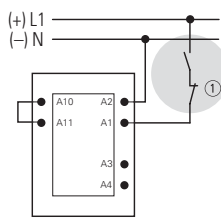

DILM1600 to DILH 2600

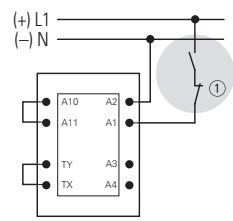

DILM225A/22(RAC240)¹⁾
139547

DILM250/22(RA250)²⁾
208201

DILM300A/22(RA250)^{1) 2)}
139556

Directly from the PLC

A 24 V output from the PLC can be directly connected to the terminals A4/A24.

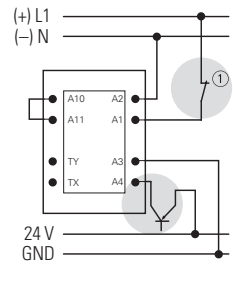
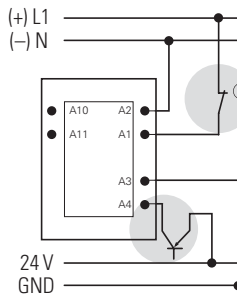
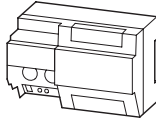

DILM400/22(RA250)³⁾
208209

DILM500/22(RA250)³⁾
208213

From a low-power command device

Low-power actuating devices such as PCB relays, pilot devices or position switches can be directly connected to A10/A11.

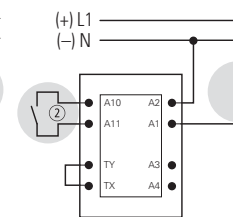
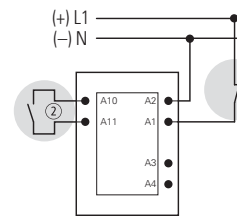

DILM580/22(RA250)³⁾
208216

DILM650/22(RA250)³⁾
208219

DILM750/22(RA250)³⁾
208222

DILM820/22(RA250)³⁾
208225

DILM1000/22(RA250)³⁾
267214

DILM1600/22(RAW250)³⁾
106727

- ① Stopping in the event of an emergency (emergency switching off)
- ② Max. cable capacitance 6 nF

Information relevant for export to North America



- 1)
NA Certification Request filed for UL and CSA
- 2)
Product Standards IEC/EN 60947-4-1; UL 508; CSA-C22.2 No.14-05; CE marking
UL File No. E29096
UL CCN NLDX
CSA File No. 1017510
CSA Class No. 3211-04
NA Certification UL Listed, CSA certified
- 3)
Product Standards IEC/EN 60947-4-1; UL 508; CSA-C22.2 No.14-05; CE marking
UL File No. E29096
UL CCN NLDX
CSA File No. 012528
CSA Class No. 3211-04
NA Certification UL Listed, CSA certified
See also Additional approvals, → Page 82

1.1

Contactors DILM, DILH Comfort devices greater than 150 A

1

DILM, DILH

Conventional thermal current $I_{th} = I_e$
AC-1 at 60 °C
Open
 $I_{th} = I_e$
A

Circuit symbol

Part no.
Article no.

Price
See price
list

Std. pack

DILH comfort devices AC-1

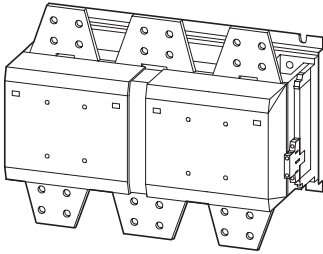

| | | | |
|------|--|---|-----------|
| 1400 | | DILH1400/22(RAW250)¹⁾ 272441 | 1 off |
| 2000 | | DILH2000/22(RAW250)¹⁾ 272442 | 1 off |
| 2200 | | DILH2200/22(RAW250)¹⁾ 111793 | 1 off |
| 2600 | | DILH2600/22(RAW250)²⁾ 125945 | 1 off |

Notes

For all contactors the following applies:

- 660 V, 690 V or 1000 V: do not reverse directly
- Integrated suppressor circuit in actuating electronics.

When operating contactors DILM580 to DILM1600 behind a frequency inverter or mains with strong harmonic loads, the suppressor circuit on the load side must be removed.

During high-voltage tests, the suppressor circuit on the load-side for DILM580 to DILH2600 contactors must be disconnected (see instructional leaflet).

Control voltages

RAW250 \pm 230 V - 250 V AC/DC

Accessories

Auxiliary contact modules

Page

→ 38

Suppressor circuits on load side

→ 61

Enclosures

totally insulated

Notes

Conventional

A1/A2 are attached to power supply as normal

DILH1400

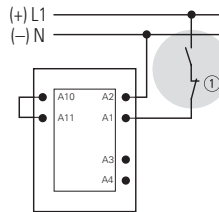

DILM1600 to DILH 2600

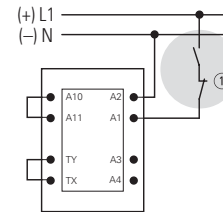

Directly from the PLC

A 24 V output from the PLC can be directly connected to the terminals A4/A24.

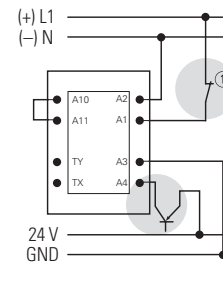
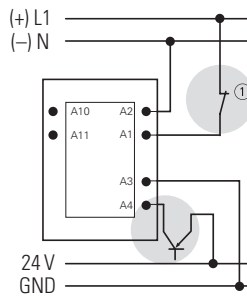
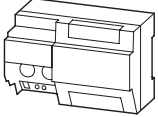

From a low-power command device

Low-power actuating devices such as PCB relays, pilot devices or position switches can be directly connected to A10/A11.

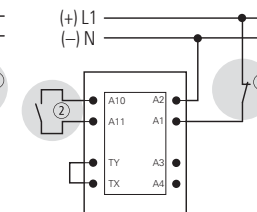
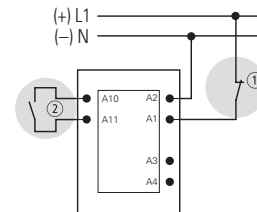

- ① Stopping in case of emergency (Emergency-stop)
- ② Max. cable capacitance 6 nF

Information relevant for export to North America



| | |
|-------------------|--|
| 1) | |
| Product Standards | IEC/EN 60947-4-1; UL 508; CSA-C22.2 No.14-05; CE marking |
| UL File No. | E29096 |
| UL CCN | NLDX |
| CSA File No. | 012528 |
| CSA Class No. | 3211-04 |
| NA Certification | UL Listed, CSA certified |

| | |
|------------------|------------------------------|
| 2) | |
| NA Certification | Request filed for UL and CSA |

1.1

Leistungsschütze

Basic devices up to 200 A

1

DILMP 4 pole

Rated operational current open

Conventional thermal current

Circuit symbol

For use with

AC-1

$I_{th} = I_e$ AC-1 at 50 °C

Open

40 °C 55 °C 70 °C

$I_{th} = I_e$

| A | A | A | A |
|----|----|----|----|
| 22 | 21 | 30 | 20 |



DILM32-XHI(C)...
DILA-XHI(V)(C)...

Contactors up to 200 A
4 pole

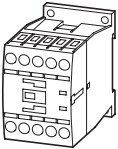

Notes

¹⁾ DILM1000-XHI... can only be fitted on the left of DILMP.

Contacts to EN 50012.

For DC operated contactors DILMP20 the following applies:

- Integrated varistor suppressor circuit.

For DC operated contactors DILMP32 - DILMP200 the following applies:

- Integrated suppressor circuit in actuating electronics.

For AC operated contactors DILMP125 - DILMP200 the following applies:

- Integrated suppressor circuit in actuating electronics.

For DILMP32-01 and DILMP45-01 the following applies:

- With mirror contact.

AC operation

Part no.
Article no.

Price
See price list

Std. pack

DC operation

Part no.
Article no.

Price
See price list

Std. pack

Notes

DILMP20(230V50Hz,240V60Hz)
276970

1 off 

DILMP20(24VDC)
276985

1 off 

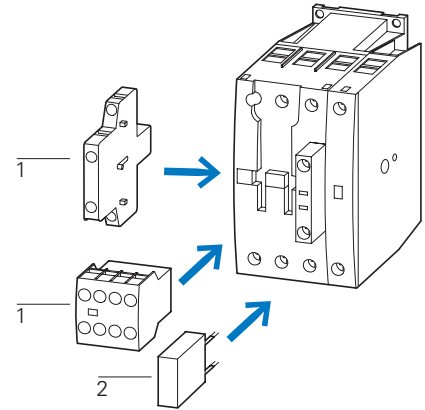

Accessories

- 1 Auxiliary contact module
- 2 Suppressor
- Further actuating voltages
- Accessories

Page

- 36
- 50
- 74
- 52









































Information relevant for export to North America



| | |
|-------------------|--|
| Product Standards | IEC/EN 60947-4-1; UL 508; CSA-C22.2 No.14-05; CE marking |
| UL File No. | E29096 |
| UL CCN | NLDX |
| CSA File No. | 012528 |
| CSA Class No. | 2411-03, 3211-04 |
| NA Certification | UL Listed, CSA certified |
| See also | → Page 81 |

DILM, DILA Auxiliary contact modules

With interlocked opposing contacts, except ...XHI(C)V

| Terminal type | Pole | Conventional thermal current $I_{th} = I_e$ AC-1 at 60 °C Open $I_{th} = I_e$ A | Contact configuration | Circuit symbol | For use with | Part no. Article no. | Price See price list | Std. pack |
|--|--------|--|---|---|--|--------------------------------|-------------------------|--|
|  Top mounting auxiliary contacts Screw terminals | 2 pole | 16 | 1 N/O 1 NC |  | DILM(C)7-10... DILM(C)9-10... | DILM32-XHI11 277376 | | 5 off  |
| | 2 pole | 16 | — 1 NC |  | DILM(C)12-10... DILM(C)15-10... DILM(C)17-10... DILM(C)25-10... DILM(C)32-10... DILM38-...10 DILMP20... DILMP32-10... DILMP45-10... DILL... | DILM32-XHI02 277375 | | 5 off  |
|  Top mounting auxiliary contacts Screw terminals | 4 pole | 16 | 2 N/O 2 NC |  | | DILM32-XHI22 277377 | | 5 off  |
| | 4 pole | 16 | 3 N/O 1 NC |  | | DILM32-XHI31 106112 | | 5 off  |
|  Top mounting auxiliary contacts Spring-loaded terminals | 2 pole | 16 | 1 N/O 1 NC |  | | DILM32-XHIC11 277751 | | 5 off  |
| | 2 pole | 16 | — 2 NC |  | | DILM32-XHIC02 277750 | | 5 off  |
|  Top mounting auxiliary contacts Spring-loaded terminals | 4 pole | 16 | 2 N/O 2 NC |  | | DILM32-XHIC22 277752 | | 5 off  |
|  Top mounting auxiliary contacts Screw terminals | 2 pole | 16 | 1 N/O — |  | DILM(C)9... DILM(C)9... DILM(C)12... DILM(C)15... DILM(C)17... DILM(C)25... DILM(C)32... DILM38... DILMP20... DILMP32... DILMP45... DILL... | DILA-XHI20 276422 | | 5 off  |
| | 2 pole | 16 | 1 N/O 1 NC |  | | DILA-XHI11 276421 | | 5 off  |
| | 2 pole | 16 | — 2 NC |  | | DILA-XHI02 276420 | | 5 off  |
| | 2 pole | 16 | 1 S _F 1 Ö _S |  | | DILA-XHIV11 276423 | | 5 off  |
|  Top mounting auxiliary contacts Screw terminals | 4 pole | 16 | 4 N/O — |  | | DILA-XHI40 276428 | | 5 off  |
| | 4 pole | 16 | 3 N/O 1 NC |  | | DILA-XHI31 276427 | | 5 off  |
| | 4 pole | 16 | 2 N/O 2 NC |  | | DILA-XHI22 276426 | | 5 off  |
| | 4 pole | 16 | 1 N/O 3 NC |  | | DILA-XHI13 276425 | | 5 off  |
| | 4 pole | 16 | — 4 NC |  | | DILA-XHI04 276424 | | 5 off  |
| | 4 pole | 16 | 1 N/O 1 NC 1 S _F 1 Ö _S |  | | DILA-XHIV22 276429 | | 5 off  |

Notes



- Auxiliary NC usable as mirror contact according to IEC/EN 60947-4-1, Annex F
- Interlocked opposing contacts according to IEC/EN 60947-5-1 Annex L, inside the auxiliary contact modules, also for the integrated auxiliary contacts of the DILM 7 - DILM32

Information relevant for export to North America

| | | |
|---|-------------------|---|
|  | Product Standards | IEC/EN 60947-4-1; UL 508; CSA-C22.2 No.14-05; CE marking |
| | UL File No. | E29184 |
| | UL CCN | NKCR |
| | CSA File No. | 012528 |
| | CSA Class No. | 3211-03 |
| | NA Certification | UL Listed, CSA certified |

DILM, DILA
Auxiliary contact modules

With interlocked opposing contacts, except ...XHI(C)V

| Terminal type | Pole | Conventional thermal current $I_{th} = I_e$ AC-1 at 60 °C Open $I_{th} = I_e$ A | Contact configuration | Circuit symbol | For use with | Part no. Article no. | Price See price list | Std. pack |
|--|--------|--|---------------------------|--------------------------|--|---|-------------------------|-----------|
|  <p>Top mounting auxiliary contacts Spring-loaded terminals</p> | 2 pole | 16 | 2 N/O | — | DILM(C)7... DILM(C)9... DILM(C)12... DILM(C)15... DILM(C)17... DILM(C)25... DILM(C)32... DILM38... DILMP20... DILMP32... DILMP45... DILL... | DILA-XHIC20 276528 | 5 off | |
| | 2 pole | 16 | 1 N/O | 1 NC | | DILA-XHIC11 276527 | 5 off | |
| | 2 pole | 16 | — | 2 NC | | DILA-XHIC02 276526 | 5 off | |
| | 2 pole | 16 | 1 S _F | 1 Ö _S | | DILA-XHICV11 276529 | 5 off | |
|  <p>Top mounting auxiliary contacts Screw terminals</p> | 2 pole | 16 | 2 N/O | 2 NC | | DILA-XHIR22¹⁾ 139580 | 5 off | |
| | 2 pole | 16 | 1 N/O | 1 NC | | DILA-XHIR11 110140 | 5 off | |
|  <p>Top mounting auxiliary contacts Spring-loaded terminals</p> | 4 pole | 16 | 4 N/O | — | DILM(C)9... DILM(C)9... DILM(C)12... DILM(C)15... DILM(C)17... DILM(C)25... DILM(C)32... | DILA-XHIC40 276534 | 5 off | |
| | 4 pole | 16 | 3 N/O | 1 NC | | DILA-XHIC31 276533 | 5 off | |
| | 4 pole | 16 | 2 N/O | 2 NC | | DILA-XHIC22 276532 | 5 off | |
| | 4 pole | 16 | 1 N/O | 3 NC | | DILA-XHIC13 276531 | 5 off | |
| | 4 pole | 16 | — | 4 NC | | DILA-XHIC04 276530 | 5 off | |
| | 4 pole | 16 | 1 N/O 1 S _F | 1 NC 1 Ö _S | | DILA-XHICV22 276535 | 5 off | |

Notes

- Auxiliary NC usable as mirror contact according to IEC/EN 60947-4-1, Annex F
- Interlocked opposing contacts according to IEC/EN 60947-5-1 Annex L, inside the auxiliary contact modules, also for the integrated auxiliary contacts of the DILM 7 - DILM32

¹⁾ 1 N/C + 1 N/O above microswitch for electronic applications

































Information relevant for export to North America

| | | |
|--|-------------------|---|
| | Product Standards | IEC/EN 60947-4-1; UL 508; CSA-C22.2 No.14-05; CE marking |
| | UL File No. | E29184 |
| | UL CCN | NKCR |
| | CSA File No. | 012528 |
| | CSA Class No. | 3211-03 |
| | NA Certification | UL Listed, CSA certified |

¹⁾ NA Certification Request filed for UL and CSA

DILM Auxiliary contact modules

With interlocked opposing contacts

| Connection type | Pole | conventional thermal current $I_{th} = I_e$ AC-1 at 60 °C Open $I_{th} = I_e$ A | Contact configuration N/O = normally open contact SF = N/O early make NC = normally closed contact ÖS = NC late-break | Circuit symbol | For use with | Part no. Article no. | Price See price list | Std. pack | Notes |
|--|-----------------|--|---|-------------------------|---|---|--|--|---|
|  | Screw terminals | 2 pole | 16 | 2 N/O – |  | DILM40... DILM50... DILM65... DILM72... DILM80... DILM95... DILM115... DILM150... DILM170... DILMP63... DILMP80... DILMP125... DILMP160... DILMP200... | DILM150-XHI20 277945 | 5 off  | Interlocked opposing contacts according to IEC/EN 60947-5-1 Annex L, inside the auxiliary contact modules Auxiliary NC usable as mirror contact according to IEC/EN 60947-4-1, Annex F |
| | | 2 pole | 16 | 1 N/O 1 NC |  | DILM150-XHI11 277946 | 5 off  | | |
| | | 2 pole | 16 | 1 N/O 1 NC |  | DILM150-XHIA11 283463 | 5 off  | | |
| | | 2 pole | 16 | – 2 NC |  | DILM150-XHI02 277947 | 5 off  | | |
|  | Screw terminals | 4 pole | 16 | 4 N/O – |  | DILM150-XHI40 277948 | 5 off  | | |
| | | 4 pole | 16 | 3 N/O 1 NC |  | DILM150-XHI31 277949 | 5 off  | | |
| | | 4 pole | 16 | 2 N/O 2 NC |  | DILM150-XHI22 277950 | 5 off  | | |
| | | 4 pole | 16 | 2 N/O 2 NC |  | DILM150-XHIA22 283464 | 5 off  | | |
| | | 4 pole | 16 | 1 N/O 3 NC |  | DILM150-XHI13 277951 | 5 off  | | |
| | | 4 pole | 16 | – 4 NC |  | DILM150-XHI04 277952 | 5 off  | | |
| | | 4 pole | 16 | 1 N/O 1 NC 1 SF 1 ÖS |  | DILM150-XHIV22 277953 | 5 off  | | |
| | |  | Screw terminals | 2 pole | 16 | 2 N/O – |  | | DILA-XHIT7... DILM9... DILM12... DILM15... DILL... |
| 2 pole | 16 | | | 1 N/O 1 NC |  | DILA-XHIT11 101043 | 5 off  | | |
| 2 pole | 16 | | | – 2 NC |  | DILA-XHIT02 101041 | 5 off  | | |
|  | Screw terminals | 4 pole | 16 | 2 N/O 2 NC |  | DILA-XHIT22 101044 | 5 off  | | |

Notes 1) Suitable for the combination with electrical wiringlinks in tool-less plug connection usable with:

- DILM12-XSL
- DILM12-XRL
- DILM12-XS1
- PKZM0-XDM12
- PKZM0-XRM12
- PKZM0-XSM12

- 1 PKZM0
- 2 DILM7 - DILM15
- 3 DILA-XHIT
- 4 PKZM0-XDM12

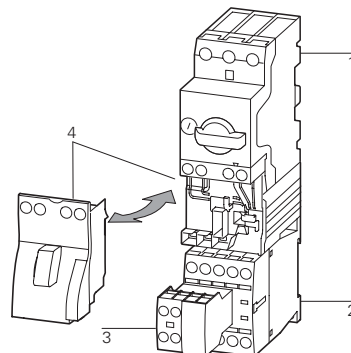

Information relevant for export to North America













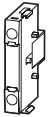























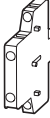

Product Standards

IEC/EN 60947-4-1; UL 508;
CSA-C22.2 No.14-05; CE marking

- UL File No.
- UL CCN
- CSA File No.
- CSA Class No.
- NA Certification

- E29184
- NKCR
- 012528
- 3211-03
- UL Listed, CSA certified

DILM, DILA

| Connection type | Pole | conventional thermal current $I_{th} = I_e$ AC-1 at 60 °C Open $I_{th} = I_e$ A | Contact configuration N/O = normally open contact SF = N/O early make NC = normally closed contact ÖS = NC late-break | Circuit symbol | For use with | Part no. Article no. | Price See price list | Std. pack | Notes |
|--|-------------------------|--|---|----------------|---|--|-------------------------------------|--|---|
| Side-mounting auxiliary contacts  | Screw terminals | 1 pole | 10 | 1 N/O – |  | DILM(C)7... DILM(C)9... DILM(C)12... DILM(C)15... DILMP20... DILA(C)... | DILA-XHI10-S 115948 | 1 off   | 1) |
| | | 1 pole | 10 | – 1 NC |  | | DILA-XHI01-S 115949 | 1 off   | |
| | Spring-loaded terminals | 1 pole | 10 | 1 N/O – |  | | DILA-XHIC10-S 115950 | 1 off   | |
| | | 1 pole | 10 | – 1 NC |  | | DILA-XHIC01-S 115951 | 1 off   | |
| Side-mounting auxiliary contacts  | Screw terminals | 2 pole | 10 | 1 N/O 1 NC |  | DILM17... DILM25... DILM32... DILM38... | DILM32-XHI11-S 101371 | 1 off   | Can only be left on the contactor. Cannot be combined with mechanical interlock |
| Side-mounting auxiliary contacts  | Screw terminals | 2 pole | 10 | 1 N/O 1 NC |  | DILM250 - DILH2600 | DILM820-XHI11-SI 208281 | 1 off   | 1) |
| | | 2 pole | 10 | 1 N/O 1 NC |  | | DILM820-XHI11-SA 208282 | 1 off   | |
| | | 2 pole | 10 | 1 SF 1 ÖS |  | | DILM820-XHI11V-SI 208283 | 1 off   | |
| Side-mounting auxiliary contacts  | Screw terminals | 2 pole | 10 | 1 N/O 1 NC |  | DILM40 - DILM225A DILMP63 - DILMP200 | DILM1000-XHI11-SI 278425 | 1 off   | |
| | | 2 pole | 10 | 1 SF 1 ÖS |  | | DILM1000-XHIV11-SI 278426 | 1 off   | |
| | | 2 pole | 10 | 1 N/O 1 NC |  | | DILM1000-XHI11-SA 278427 | 1 off   | |

Notes

- Interlocked opposing contacts according to IEC/EN 60947-5-1 Annex L, inside the auxiliary contact module, also for the integrated auxiliary contacts of the DILM7 – DILM32 (not NO early-make and NC late-break)
- Auxiliary NC usable as mirror contact according to IEC/EN 60947-4-1, Annex F (no NC late-breaks)
- No auxiliary contact is possible between 2 contactors with mechanical interlock.

Information relevant for export to North America

2)

Product Standards

UL File No.

UL CCN

CSA File No.

CSA Class No.

NA Certification

 IEC/EN 60947-4-1; UL 508;
 CSA-C22.2 No.14-05; CE marking
 E29184
 NKCR
 012528
 3211-03,3211-04
 UL Listed, CSA certified

1.1

Contactors

Auxiliary contact modules

1 Engineering

DILM, DILH

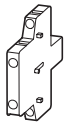

DILM1000-
XHI(V)11-SI

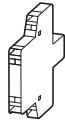

DILM820-
XHI(V)11-SI

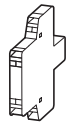

DILM1000-
XHI(V)11-SA



DILM820-
XHI(V)11-SA



DILM150-XHI20
DILM150-XHI11
DILM150-XHI02



DILM150-XHI40
DILM150-XHI31
DILM150-
XHI(V)22
DILM150-XHI13
DILM150-XHI04



DILM150-
XHIA11



DILM150-
XHIA22

| | | | | | | | | |
|---------------------|-----|-----|-----|-----|-----|-----|-----|-----|
| DILM40 | 2 x | – | – | – | – | – | 1 x | – |
| ... DILM72 | – | – | 2 x | – | 1 x | – | – | – |
| | 1 x | – | – | – | – | – | – | 1 x |
| | – | – | 1 x | – | – | 1 x | – | – |
| DILM80 | 2 x | – | 2 x | – | – | – | – | – |
| ... DILM170 | 2 x | – | – | – | – | – | – | 1 x |
| | 2 x | – | – | – | – | – | 1 x | – |
| | – | – | 2 x | – | – | 1 x | – | – |
| | – | – | 2 x | – | 1 x | – | – | – |
| DILM185A | 2 x | – | 2 x | – | – | – | – | – |
| DILM222A | 2 x | – | – | – | – | – | – | – |
| DILM250 DILM1600 | – | 2 x | – | 2 x | – | – | – | – |
| DILH1400 | – | 2 x | – | 2 x | – | – | – | – |
| ... DILH2600 | – | – | – | – | – | – | – | – |

Notes

Side mounting auxiliary contacts

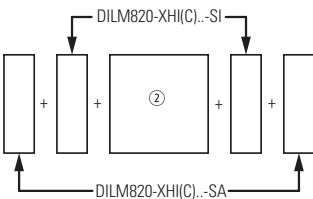
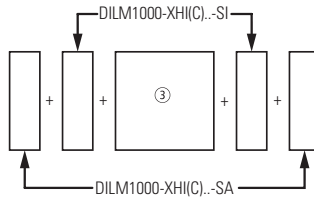
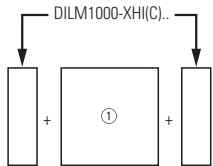

- ① DILM40 – DILM72
- ② DILM250 – DILH2600
- ③ DILM80-DILM225A

- Interlocked opposing contacts according to IEC/EN 60947-5-1 Annex L, inside the auxiliary contact module (not N/O early close and N/C late open)
- Auxiliary contacts can be used as mirror contacts according to IEC/EN 60947-4-1, Annex F (not N/C late open)
- No auxiliary contact is possible between two contactors with mechanical interlock.
- 2 auxiliary contacts DILM820-XHI11-SI are already built into the contactors DILM250 to DILH2600/22.
- 2 DILM1000-XHI11-SI auxiliary contacts are already installed in DILM185A and DILH225A contactors.

Ordering

DILK

Three-phase capacitors
50 – 60 Hz
Open

Circuit symbol

Part no.
Article no.

Price
See price list

Std. pack

| | | | |
|-------|-------|-------|-------|
| 230 V | 400 V | 525 V | 690 V |
|-------|-------|-------|-------|

| | | | |
|------|------|------|------|
| kvar | kvar | kvar | kvar |
|------|------|------|------|

| | | | |
|-----|------|------|----|
| 7.5 | 12.5 | 16.7 | 20 |
|-----|------|------|----|

| | | | |
|----|----|----|------|
| 11 | 20 | 25 | 33.3 |
|----|----|----|------|

| | | | |
|----|----|------|----|
| 15 | 25 | 33.3 | 40 |
|----|----|------|----|

| | | | |
|----|------|----|----|
| 20 | 33.3 | 40 | 55 |
|----|------|----|----|

| | | | |
|----|----|----|----|
| 25 | 50 | 65 | 85 |
|----|----|----|----|

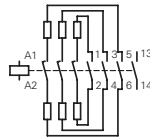
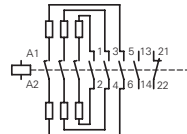

DILK12-11(230V50Hz,240V60Hz)
293988 1 off

DILK20-11(230V50Hz,240V60Hz)
294010 1 off

DILK25-11(230V50Hz,240V60Hz)
294032 1 off

DILK33-10(230V50Hz,240V60Hz)
294054 1 off

DILK50-10(230V50Hz,240V60Hz)
294076 1 off

With series resistors Basic Units

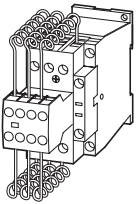

Notes

Weld-resistant for capacitors with inrush current peaks up to $180 \times I_N$

With group compensation multi-stage capacitor banks are connected to the mains as required. This can cause, transient currents of up to $180 \times I_e$ to flow between the capacitors.

The capacitors are pre-charged via the early-make auxiliary contacts and the fitted wire resistors, thereby reducing the inrush current. The main contacts then close after a time lag and carry the continuous current.

The contactors for capacitors are weld-resistant with inrush current peaks up to $180 \times I_e$ due to their special contacts.

DILK... cannot be combined with other auxiliary contacts.

For the switching of reactive-power compensation equipment please see Engineering notes on power factor correction → page 33.

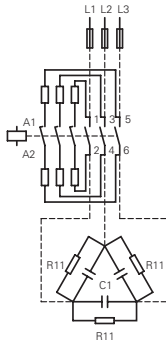

Accessories Page

Enclosures → 52
Accessories → 76
Further actuating voltages → 76

Information relevant for export to North America



| | |
|-------------------|--|
| Product Standards | IEC/EN 60947-4-1; UL 508; CSA-C22.2 No.14-05; CE marking |
| UL File No. | E29096 |
| UL CCN | NLDX |
| CSA File No. | 012528 |
| CSA Class No. | 3211-04 |
| NA Certification | UL Listed, CSA certified |
| See also | Further approvals → Page 66 |

1.1

Contactors

Contactors for power factor correction

1 Engineering

DILM, DILK

| Part no. | Page | Switching power | | | |
|--|----------|-----------------|-------------------------|-------|-------|
| | | 230 V | 400 V 420 V 440 V | 525 V | 690 V |
| Ordering data | Part no. | kvar | kvar | kvar | kvar |
| Individual compensation, open version | | | | | |
| DILM7-...(…) | → 18 | 1.5 | 3 | 3.5 | 5 |
| DILM9-...(…) | → 18 | 2 | 4 | 4.5 | 6 |
| DILM12-...(…) | → 18 | 2.5 | 4.5 | 5.5 | 7 |
| DILM15-...(…) | → 18 | 2.5 | 4.5 | 5.5 | 7 |
| DILM17-...(…) | → 18 | 6.5 | 12 | 14.5 | 19 |
| DILM25-...(…) | → 18 | 7 | 13.5 | 16 | 21 |
| DILM32-...(…) | → 18 | 7.5 | 14.5 | 17 | 22.5 |
| DILM40(…) | → 20 | 11 | 20.5 | 24.5 | 32 |
| DILM50(…) | → 20 | 11.5 | 22 | 26 | 34.5 |
| DILM65(…) | → 20 | 12.5 | 23.5 | 28 | 37 |
| DILM80(…) | → 20 | 16 | 30.5 | 36.5 | 48 |
| DILM95(…) | → 20 | 18 | 34 | 41 | 54 |
| DILM115(…) | → 20 | 24 | 46 | 54.5 | 72 |
| DILM150(…) | → 20 | 28 | 53 | 63.5 | 83.5 |
| DILM185A(…) | → 30 | 87 | 150 | 190 | 150 |
| DILM300A(…) | → 30 | 115 | 200 | 265 | 200 |
| DILM580(…) | → 30 | 175 | 300 | 400 | 300 |
| Group compensation, with choke, open version | | | | | |
| DILM7-...(…) | → 18 | 4 | 7 | 7.5 | 12 |
| DILM9-...(…) | → 18 | 5 | 8 | 10 | 14 |
| DILM12-...(…) | → 18 | 5.5 | 10 | 12 | 16 |
| DILM15-...(…) | → 18 | 5.5 | 10 | 12 | 16 |
| DILM17-...(…) | → 18 | 7.5 | 18 | 20 | 28 |
| DILM25-...(…) | → 18 | 10 | 20 | 23 | 30 |
| DILM32-...(…) | → 18 | 12.5 | 25 | 25 | 32 |
| DILM40(…) | → 20 | 15 | 30 | 30 | 40 |
| DILM50(…) | → 20 | 20 | 40 | 40 | 48 |
| DILM65(…) | → 20 | 25 | 50 | 50 | 57 |
| DILM80(…) | → 20 | 30 | 60 | 70 | 90 |
| DILM95(…) | → 20 | 35 | 70 | 80 | 104 |
| DILM115(…) | → 20 | 50 | 95 | 100 | 125 |
| DILM150(…) | → 20 | 55 | 115 | 115 | 152 |
| DILM185A(…) | → 30 | 80 | 150 | 200 | 260 |
| DILM225A(…) | → 30 | 100 | 175 | 230 | 300 |
| DILM250(…) | → 30 | 110 | 190 | 260 | 340 |
| DILM300A(…) | → 30 | 130 | 225 | 290 | 390 |
| DILM400(…) | → 30 | 160 | 280 | 370 | 480 |
| DILM500(…) | → 30 | 220 | 390 | 500 | 680 |
| Group compensation, without choke, open version | | | | | |
| DILK12-...(…) | → 41 | 7.5 | 12.5 | 16.7 | 20 |
| DILK20-...(…) | → 41 | 11 | 20 | 25 | 33.3 |
| DILK25-...(…) | → 41 | 15 | 25 | 33.3 | 40 |
| DILK33-...(…) | → 41 | 20 | 33.3 | 40 | 55 |
| DILK50-...(…) | → 41 | 25 | 50 | 65 | 85 |
| DILM185A(…) | → 30 | 66 | 115 | 145 | 115 |
| DILM300A(…) | → 30 | 85 | 150 | 195 | 150 |
| DILM580(…) | → 30 | 145 | 250 | 333 | 250 |

Notes

Use of the contactors DILM without series resistor for group compensation

When using the contactors for group compensation in a system without chokes each capacitor must have a minimum induction of approx. 6 µH to limit the peak inrush current. This corresponds to an air-cored coil with 5 windings and a coil diameter of approximately Ø 140 mm. The conductor cross section must correspond to the rated operational current.

1.1

Contactors combinations

Star-delta combinations

Ordering

1

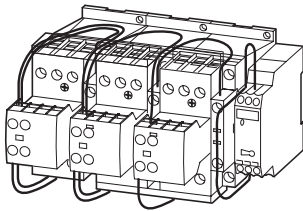
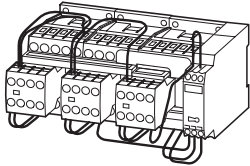
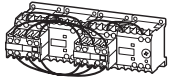

Star-delta combinations SDAINL

Operating frequency: maximum 30 starts per hour

| Rated operational current AC-3 | Max. rated operational power for three-phase motors, 50 - 60 Hz | | | | | Max. change- over time s | Part no. Article no. | Price See price list | Std. pack |
|-----------------------------------|--|---------|---------|---------|---------|-----------------------------------|---------------------------------------|----------------------------|--------------|
| | 400 V | 230 V | 400 V | 500 V | 690 V | | | | |
| I_e A | P kW | P kW | P kW | P kW | P kW | | | | |
| 12 | 4 | 5.5 | 5.5 | – | – | < 30 | SDAINLEM(230V50Hz) 051840 | 1 off | |
| 12 | 3 | 5.5 | 5.5 | 5.5 | – | < 20 | SDAINLM12(230V50Hz) 278286 | 1 off | |
| 12 | 3 | 5.5 | 5.5 | 5.5 | – | < 20 | SDAINLM12(400V50Hz) 101380 | 1 off | |
| 12 | 3 | 5.5 | 5.5 | 5.5 | – | < 20 | SDAINLM12(24VDC) 100416 | 1 off | |
| 16 | 4 | 7.5 | 7.5 | 7.5 | – | < 20 | SDAINLM16(230V50Hz) 278311 | 1 off | |
| 16 | 4 | 7.5 | 7.5 | 7.5 | – | < 20 | SDAINLM16(400V50Hz) 101381 | 1 off | |
| 16 | 4 | 7.5 | 7.5 | 7.5 | – | < 20 | SDAINLM16(24VDC) 100417 | 1 off | |
| 22 | 5.5 | 11 | 11 | 11 | – | < 20 | SDAINLM22(230V50Hz) 278336 | 1 off | |
| 22 | 5.5 | 11 | 11 | 11 | – | < 20 | SDAINLM22(400V50Hz) 101382 | 1 off | |
| 22 | 5.5 | 11 | 11 | 11 | – | < 20 | SDAINLM22(24VDC) 100418 | 1 off | |
| 30 | 7.5 | 15 | 18.5 | 18.5 | – | < 20 | SDAINLM30(230V50Hz) 278361 | 1 off | |
| 30 | 7.5 | 15 | 18.5 | 18.5 | – | < 20 | SDAINLM30(400V50Hz) 101383 | 1 off | |
| 30 | 7.5 | 15 | 18.5 | 18.5 | – | < 20 | SDAINLM30(RDC24) 100419 | 1 off | |
| 45 | 11 | 22 | 30 | 22 | – | < 20 | SDAINLM45(230V50Hz) 278386 | 1 off | |
| 45 | 11 | 22 | 30 | 22 | – | < 20 | SDAINLM45(400V50Hz) 101384 | 1 off | |
| 45 | 11 | 22 | 30 | 22 | – | < 20 | SDAINLM45(RDC24) 100420 | 1 off | |
| 55 | 15 | 30 | 37 | 30 | – | < 20 | SDAINLM55(230V50Hz) 278411 | 1 off | |
| 55 | 15 | 30 | 37 | 30 | – | < 20 | SDAINLM55(400V50Hz) 101385 | 1 off | |
| 55 | 15 | 30 | 37 | 30 | – | < 20 | SDAINLM55(RDC24) 100421 | 1 off | |
| 70 | 18.5 | 37 | 45 | 37 | – | < 20 | SDAINLM70(230V50Hz) 239895 | 1 off | |
| 70 | 18.5 | 37 | 45 | 37 | – | < 20 | SDAINLM70(400V50Hz) 101386 | 1 off | |
| 90 | 22 | 45 | 55 | 45 | – | < 20 | SDAINLM90(230V50Hz) 239937 | 1 off | |
| 115 | 30 | 55 | 75 | 55 | – | < 20 | SDAINLM115(230V50Hz) 239963 | 1 off | |
| 140 | 37 | 75 | 90 | 90 | – | < 20 | SDAINLM140(230V50Hz) 240009 | 1 off | |
| 165 | 45 | 90 | 110 | 132 | – | < 20 | SDAINLM165(230V50Hz) 240035 | 1 off | |
| 200 | 55 | 110 | 132 | 160 | – | < 20 | SDAINLM200(230V50Hz) 101010 | 1 off | |
| 260 | 75 | 132 | 160 | 160 | – | < 20 | SDAINLM260(230V50Hz) 101031 | 1 off | |

| Individual components of the combination | | | | Spare auxiliary contacts | | | Notes |
|--|-------------------------|------------------------|------------------|--------------------------|-----|-----|---|
| Mains contactor Q11 | Delta contactor Q15 | Star contactor Q13 | Timing relays K1 | Q11 | Q13 | Q15 | |
| Part no. | Part no. | Part no. | Part no. | | | | |
| DILEM-10 + 22DILEM | DILEM-01 | DILEM-10 + 02DILEM | DILET | | — | — | <p>Main circuit: Depending on the type of coordination required (i.e. Type "1" or Type "2") it must be established whether the fuse protection and the input wiring for the mains contactor and delta contactor are to be common or separate.</p> <p>The following applies for SDAINLM 140 – SDAINLM 260:</p> <ul style="list-style-type: none"> On the mounting plate. <p>Circuit diagrams, Star-delta combinations → page 46</p> |
| DILM7-10 + DILA-XHI20 | DILM7-01 + DILA-XHI20 | DILM7-01 + DILA-XHI20 | ETR4-51 | | | | |
| DILM7-10 + DILA-XHI20 | DILM7-01 + DILA-XHI20 | DILM7-01 + DILA-XHI20 | ETR4-51 | | | | |
| DILM7-10 + DILA-XHI20 | DILM7-01 + DILA-XHI20 | DILM7-01 + DILA-XHI20 | ETR4-51 | | | | |
| DILM9-10 + DILA-XHI20 | DILM9-01 + DILA-XHI20 | DILM7-01 + DILA-XHI20 | ETR4-51 | | | | |
| DILM9-10 + DILA-XHI20 | DILM9-01 + DILA-XHI20 | DILM7-01 + DILA-XHI20 | ETR4-51 | | | | |
| DILM9-10 + DILA-XHI20 | DILM9-01 + DILA-XHI20 | DILM7-01 + DILA-XHI20 | ETR4-51 | | | | |
| DILM12-10 + DILA-XHI20 | DILM12-01 + DILA-XHI20 | DILM7-01 + DILA-XHI20 | ETR4-51 | | | | |
| DILM12-10 + DILA-XHI20 | DILM12-01 + DILA-XHI20 | DILM7-01 + DILA-XHI20 | ETR4-51 | | | | |
| DILM12-10 + DILA-XHI20 | DILM12-01 + DILA-XHI20 | DILM7-01 + DILA-XHI20 | ETR4-51 | | | | |
| DILM17-10 + DILA-XHI20 | DILM17-01 + DILA-XHI20 | DILM17-01 + DILA-XHI20 | ETR4-51 | | | | |
| DILM17-10 + DILA-XHI20 | DILM17-01 + DILA-XHI20 | DILM17-01 + DILA-XHI20 | ETR4-51 | | | | |
| DILM17-10 + DILA-XHI20 | DILM17-01 + DILA-XHI20 | DILM17-01 + DILA-XHI20 | ETR4-51 | | | | |
| DILM25-10 + DILA-XHI20 | DILM25-01 + DILA-XHI20 | DILM17-01 + DILA-XHI20 | ETR4-51 | | | | |
| DILM25-10 + DILA-XHI20 | DILM25-01 + DILA-XHI20 | DILM17-01 + DILA-XHI20 | ETR4-51 | | | | |
| DILM25-10 + DILA-XHI20 | DILM25-01 + DILA-XHI20 | DILM17-01 + DILA-XHI20 | ETR4-51 | | | | |
| DILM32-10 + DILA-XHI20 | DILM32-01 + DILA-XHI20 | DILM25-01 + DILA-XHI20 | ETR4-51 | | | | |
| DILM32-10 + DILA-XHI20 | DILM32-01 + DILA-XHI20 | DILM25-01 + DILA-XHI20 | ETR4-51 | | | | |
| DILM32-10 + DILA-XHI20 | DILM32-01 + DILA-XHI20 | DILM25-01 + DILA-XHI20 | ETR4-51 | | | | |
| DILM40 + DILM150-XHI31 | DILM40 + DILM150-XHI11 | DILM40 + DILM150-XHI11 | ETR4-51 | | — | — | |
| DILM40 + DILM150-XHI31 | DILM40 + DILM150-XHI11 | DILM40 + DILM150-XHI11 | ETR4-51 | | — | — | |
| DILM50 + DILM150-XHI31 | DILM50 + DILM150-XHI11 | DILM40 + DILM150-XHI11 | ETR4-51 | | — | — | |
| DILM65 + DILM150-XHI31 | DILM65 + DILM150-XHI11 | DILM40 + DILM150-XHI11 | ETR4-51 | | — | — | |
| DILM80 + DILM150-XHI31 | DILM80 + DILM150-XHI11 | DILM50 + DILM150-XHI11 | ETR4-51 | | — | — | |
| DILM95 + DILM150-XHI31 | DILM95 + DILM150-XHI11 | DILM65 + DILM150-XHI11 | ETR4-51 | | — | — | |
| DILM115 + DILM150-XHI31 | DILM115 + DILM150-XHI11 | DILM80 + DILM150-XHI11 | ETR4-51 | | — | — | |
| DILM150 + DILM150-XHI31 | DILM150 + DILM150-XHI11 | DILM95 + DILM150-XHI11 | ETR4-51 | | — | — | |

Accessories
1 Overload relay
Accessories

Page
→ Chapter 1.2
→ 52

1.1 Contactor combinations

Star-delta combinations

1 Engineering

SDAINL Circuit diagrams, Star-delta combinations

SDAINLEM

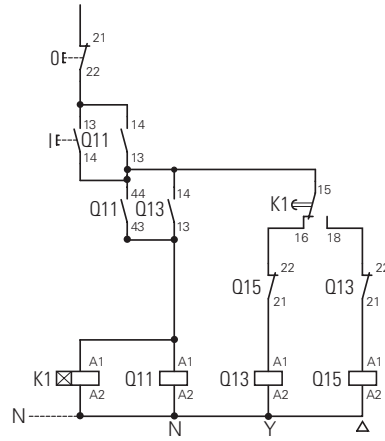
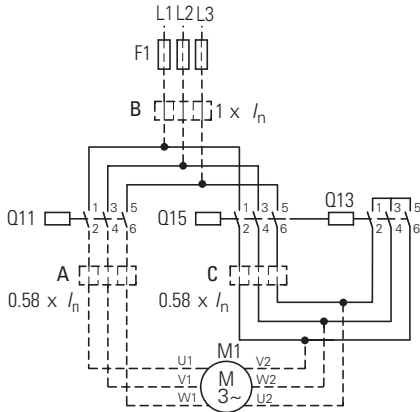

SDAINLM12...SDAINLM55

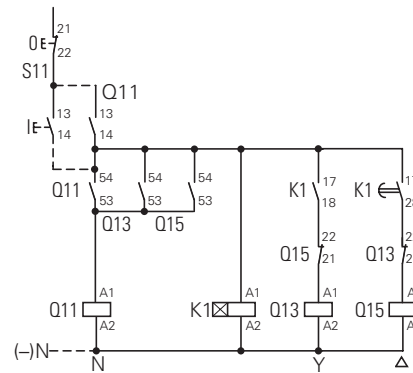
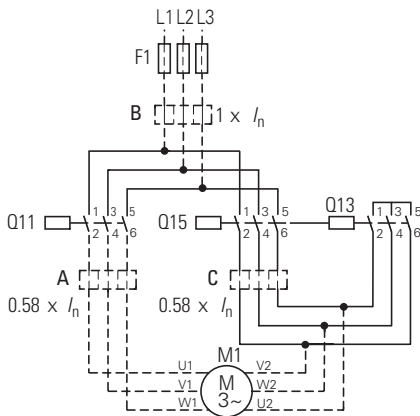

SDAINLM70...SDAINLM260

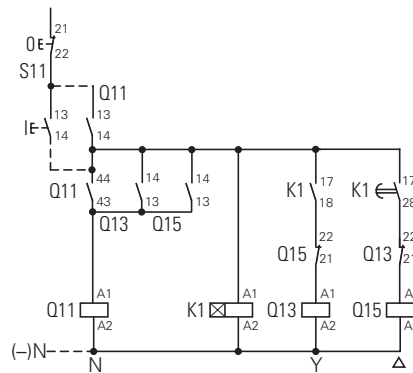
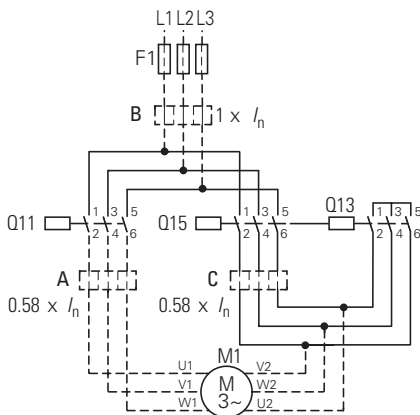

Overload relay settings

- A:** $I_N \times 0.58$
Motor protected in Y and Δ - positions
- B:** $I_N \times 1$
Only partial motor protection in Y position
- C:** $I_N \times 0.58$
Motor not protected in Y position
- Timing relay set to approx. 10 s
- Main circuit:

Starting

- ≤ 15 s
- 15 – 40 s
- > 40 s

Depending on the type of coordination required (i.e. Type "1" or Type "2") it must be established whether the fuse protection and the input wiring for the mains contactor and delta contactor are to be common or separate.

SDAINL Components for self-assembly of star-delta combinations

Maximum operational rating of AC motors 50 - 60 Hz
AC-3

Changeover time¹⁾

Individual components of the combination

Spare auxiliary contacts

| 230 V kW | 400 V kW | 500 V kW | 690 V kW | 1000 V kW | up to 12 s | up to 20 s | up to 30 s | Coil to EN 50005 Switching element to EN 50005 and EN 50012 | | | | Q11 | Q15 | Q13 |
|-------------|-------------|-------------|-------------|--------------|---------------|---------------|---------------|--|---|--|-----------------------------------|-----|-----|-----|
| | | | | | | | | Mains contactor Q11 Part no. DIL | Delta contactor Q15 Part no. DIL | Star contactor Q13 Part no. DIL | Timing relay K1 Part no. | | | |
| 90 | 160 | 200 | 250 | 132 | ● | ● | ● | M185A/22 | M185A/22 | M115/22 | ETR4-51 | | | |
| 110 | 200 | 250 | 315 | 160 | ● | ● | — | M225A/22 | M225A/22 | M150/22 | ETR4-51 | | | |
| 132 | 250 | 315 | 400 | 200 | ● | ● | ● | M250/22 | M250/22 | M185A/22 | ETR4-51 | | | |
| 160 | 300 | 355 | 450 | 200 | ● | ● | ● | M300A/22 | M300A/22 | M185A/22 | ETR4-51 | | | |
| 200 | 355 | 450 | 560 | 220 | ● | ● | — | M400/22 | M400/22 | M250/22 | ETR4-51 | | | |
| 250 | 450 | 560 | 600 | 220 | ● | ● | ● | M500/22 | M500/22 | M300A/22 | ETR4-51 | | | |
| 300 | 560 | 710 | 900 | 355 | ● | ● | ● | M580/22 | M580/22 | M400/22 | ETR4-51 | | | |
| 350 | 630 | 750 | 950 | 355 | ● | ● | ● | M650/22 | M650/22 | M400/22 | ETR4-51 | | | |
| 400 | 710 | 900 | 1200 | 1400 | ● | ● | ● | M750/22 | M750/22 | M580/22 | ETR4-51 | | | |
| 450 | 800 | 950 | 1300 | 1400 | ● | ● | ● | M820/22 | M820/22 | M580/22 | ETR4-51 | | | |
| 560 | 1000 | 1200 | 1700 | 1700 | ● | ● | — | M1000/22 | M1000/22 | M650/22 | ETR4-51 | | | |

Notes

¹⁾ Longer changeover times please enquire

Components for self-assembly

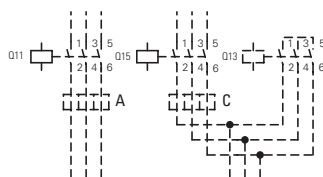
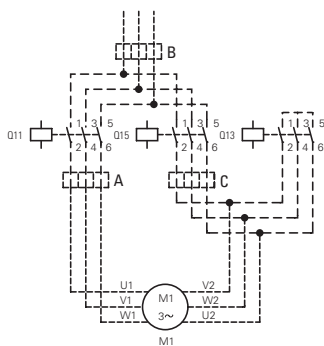

Notes

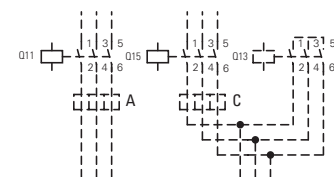

Overload relay settings

Timing relay set to approx. 10 s

| I_N | Starting | Main circuit: Depending on the coordination type required (i.e. Type "1" or Type "2") it must be established whether the fuse protection and the input wiring for the mains contactor and delta contactor are to be common or separate. |
|---|-------------|--|
| A x 0.58 Motor protection in Y and Δ positions | ≤ 15 s | |
| B x 1 In Y position only limited motor protection | 15 – 40 s | Control circuit: If the combinations are to be used within the scope of IEC/EN 60 204 Part 1, VDE 0113 Part 1, then Point 9.1.1 regarding the supply of control circuits, must be observed. |
| C x 0.58 Motor not protected in Y position | > 40 s | |

1.1

Contactors combinations

Reversing combinations

1 Ordering

DIUL reversing combinations

Rated operational current Max. motor rating for three-phase motors 50 - 60 Hz **Part no.** Article no. **Price** See price list Std. pack

| AC-3 400 V | AC-3 | | | AC-4 | | | Part no. Article no. | Price See price list | Std. pack |
|---------------------|----------------|----------------|----------------|----------------|----------------|----------------|-------------------------|-------------------------|-----------|
| | 220 V 230 V | 380 V 400 V | 660 V 690 V | 220 V 230 V | 380 V 400 V | 660 V 690 V | | | |
| I _e A | P kW | P kW | P kW | P kW | P kW | P kW | | | |

AC operation

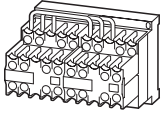

| | | | | | | | | | |
|---|-----|---|---|-----|---|---|---|-------|--|
| 9 | 2.2 | 4 | 4 | 1.5 | 3 | 3 | DIULEM/21(MV(230V50Hz))¹⁾ 051849 | 1 Off | |
| 9 | 2.2 | 4 | 4 | 1.5 | 3 | 3 | DIULEM/21(MV-G(24VDC))²⁾ 214655 | 1 Off | |

AC operation

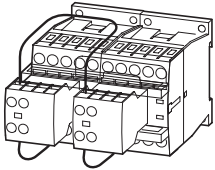

| | | | | | | | | | |
|---|-----|---|-----|---|-----|-----|---|-------|--|
| 7 | 2.2 | 3 | 3.5 | 1 | 2.2 | 2.9 | DIULM7/21(230V50Hz)²⁾ 278061 | 1 Off | |
|---|-----|---|-----|---|-----|-----|---|-------|--|

| | | | | | | | | | |
|---|-----|---|-----|---|-----|-----|--|-------|--|
| 7 | 2.2 | 3 | 3.5 | 1 | 2.2 | 2.9 | DIULM7/21(24VDC)²⁾ 107021 | 1 Off | |
|---|-----|---|-----|---|-----|-----|--|-------|--|

| | | | | | | | | | |
|---|-----|---|-----|-----|-----|-----|---|-------|--|
| 9 | 2.5 | 4 | 4.5 | 1.5 | 2.5 | 3.6 | DIULM9/21(230V50Hz)²⁾ 278086 | 1 Off | |
|---|-----|---|-----|-----|-----|-----|---|-------|--|

| | | | | | | | | | |
|---|-----|---|-----|-----|-----|-----|--|-------|--|
| 9 | 2.5 | 4 | 4.5 | 1.5 | 2.5 | 3.6 | DIULM9/21(24VDC)²⁾ 107022 | 1 Off | |
|---|-----|---|-----|-----|-----|-----|--|-------|--|

| | | | | | | | | | |
|----|-----|-----|-----|---|---|-----|--|-------|--|
| 12 | 3.5 | 5.5 | 6.5 | 2 | 3 | 4.4 | DIULM12/21(230V50Hz)²⁾ 278111 | 1 Off | |
|----|-----|-----|-----|---|---|-----|--|-------|--|

| | | | | | | | | | |
|----|-----|-----|-----|---|---|-----|---|-------|--|
| 12 | 3.5 | 5.5 | 6.5 | 2 | 3 | 4.4 | DIULM12/21(24VDC)²⁾ 107023 | 1 Off | |
|----|-----|-----|-----|---|---|-----|---|-------|--|

| | | | | | | | | | |
|----|---|-----|----|-----|-----|-----|--|-------|--|
| 18 | 5 | 7.5 | 11 | 2.5 | 4.5 | 6.5 | DIULM17/21(230V50Hz)²⁾ 278136 | 1 Off | |
|----|---|-----|----|-----|-----|-----|--|-------|--|

| | | | | | | | | | |
|----|---|-----|----|-----|-----|-----|---|-------|--|
| 18 | 5 | 7.5 | 11 | 2.5 | 4.5 | 6.5 | DIULM17/21(RDC24)²⁾ 107024 | 1 Off | |
|----|---|-----|----|-----|-----|-----|---|-------|--|

| | | | | | | | | | |
|----|-----|----|----|-----|---|-----|--|-------|--|
| 25 | 7.5 | 11 | 14 | 3.5 | 6 | 8.5 | DIULM25/21(230V50Hz)²⁾ 278161 | 1 Off | |
|----|-----|----|----|-----|---|-----|--|-------|--|

| | | | | | | | | | |
|----|-----|----|----|-----|---|-----|---|-------|--|
| 25 | 7.5 | 11 | 14 | 3.5 | 6 | 8.5 | DIULM25/21(RDC24)²⁾ 107025 | 1 Off | |
|----|-----|----|----|-----|---|-----|---|-------|--|

| | | | | | | | | | |
|----|----|----|----|---|---|----|--|-------|--|
| 32 | 10 | 15 | 17 | 4 | 7 | 10 | DIULM32/21(230V50Hz)²⁾ 278186 | 1 Off | |
|----|----|----|----|---|---|----|--|-------|--|

| | | | | | | | | | |
|----|----|----|----|---|---|----|---|-------|--|
| 32 | 10 | 15 | 17 | 4 | 7 | 10 | DIULM32/21(RDC24)²⁾ 107026 | 1 Off | |
|----|----|----|----|---|---|----|---|-------|--|

| | | | | | | | | | |
|----|------|------|----|---|---|----|--|-------|--|
| 40 | 12.5 | 18.5 | 23 | 5 | 9 | 12 | DIULM40/11(230V50Hz)²⁾ 278211 | 1 Off | |
|----|------|------|----|---|---|----|--|-------|--|

| | | | | | | | | | |
|----|------|----|----|---|----|----|--|-------|--|
| 50 | 15.5 | 22 | 30 | 6 | 10 | 14 | DIULM50/11(230V50Hz)²⁾ 278236 | 1 Off | |
|----|------|----|----|---|----|----|--|-------|--|

| | | | | | | | | | |
|----|----|----|----|---|----|----|--|-------|--|
| 65 | 20 | 30 | 35 | 7 | 12 | 17 | DIULM65/11(230V50Hz)²⁾ 278261 | 1 Off | |
|----|----|----|----|---|----|----|--|-------|--|

Information relevant for export to North America



| | |
|-------------------------|---|
| 1) Product Standards | IEC/EN 60947-4-1; UL 508; CSA-C22.2 No.14-05; CE marking |
| UL File No. | E29096 |
| UL CCN | NLDX |
| CSA File No. | 012528 |
| CSA Class No. | 3211-04 |
| NA Certification | UL Listed, CSA certified |

Information relevant for export to North America



| | |
|-------------------------|---|
| 2) Product Standards | IEC/EN 60947-4-1; UL 508; CSA-C22.2 No.14-05; CE marking |
| UL File No. | E29096 |
| UL CCN | NLDX |
| CSA File No. | 012528 |
| CSA Class No. | 2411-03, 3211-04 |
| NA Certification | UL Listed, CSA certified |

| Individual components of the combination | | Spare auxiliary contacts | | | Circuit diagram | Notes |
|--|---------------------------|--------------------------|-----|----------------------|-----------------|--|
| Contactor Q11 | Contactor Q12 | Q11 | Q12 | Mechanical interlock | | |
| Part no. | Part no. | | | | | |
| DILEM-10 + 11DILEM | DILEM-10 + 11DILEM | | | + | | Accessories 1 Overload relay Accessories Reversing contactors |
| DILEM-10-G + 11DILEM | DILEM-10-G + 11DILEM | | | + | | |
| DILM7-01 + DILA-XHI20 | DILM7-01 + DILA-XHI20 | | | + | | Accessories 1 Overload relay Accessories Reversing contactors DIULM7/21 to DIULM65/11 with mechanical interlock |
| DILM7-01 + DILA-XHI20 | DILM7-01 + DILA-XHI20 | | | + | | |
| DILM9-01 + DILA-XHI20 | DILM9-01 + DILA-XHI20 | | | + | | |
| DILM9-01 + DILA-XHI20 | DILM9-01 + DILA-XHI20 | | | + | | |
| DILM12-01 + DILA-XHI20 | DILM12-01 + DILA-XHI20 | | | + | | |
| DILM12-01 + DILA-XHI20 | DILM12-01 + DILA-XHI20 | | | + | | |
| DILM17-01 + DILA-XHI20 | DILM17-01 + DILA-XHI20 | | | + | | |
| DILM17-01 + DILA-XHI20 | DILM17-01 + DILA-XHI20 | | | + | | |
| DILM25-01 + DILA-XHI20 | DILM25-01 + DILA-XHI20 | | | + | | |
| DILM25-01 + DILA-XHI20 | DILM25-01 + DILA-XHI20 | | | + | | |
| DILM32-01 + DILA-XHI20 | DILM32-01 + DILA-XHI20 | | | + | | |
| DILM32-01 + DILA-XHI20 | DILM32-01 + DILA-XHI20 | | | + | | |
| DILM40 + DILM150-XHI11 | DILM40 + DILM150-XHI11 | - | - | + | | |
| DILM50 + DILM150-XHI11 | DILM50 + DILM150-XHI11 | - | - | + | | |
| DILM65 + DILM150-XHI11 | DILM65 + DILM150-XHI11 | - | - | + | | |

Page
 → Chapter 1.2
 → 52

1.1

Contactor relays, contactors

Suppressor circuit

1 Ordering

DILM...-XSP... Suppressor circuits

| Voltage U_s V | For use with | Circuit symbol | Part no. Article no. | Price See price list | Std. pack | Notes | |
|---|--|----------------|---------------------------------|-------------------------|-----------|--|--|
| 24 - 48 AC 110 - 240 AC 240 - 500 AC | DILM7 - DILM15 DILMP20 DILA | | DILM12-XSPR48 281199 | 10 Off | | For AC operated contactors 50 - 60 Hz. DC operated contactors and DILM115 and DILM150 have an integrated suppressor. Note drop-out delay. | |
| | | | DILM12-XSPR240 281200 | 10 Off | | | |
| | | | DILM12-XSPR500 281201 | 10 Off | | | |
| 24 - 48 AC 110 - 240 AC 240 - 500 AC | DILM17 - DILM32 DILK12 - DILK25 DILL... DILMP32 - DILMP45 | | DILM32-XSPR48 281202 | 10 Off | | | |
| | | | DILM32-XSPR240 281203 | 10 Off | | | |
| | | | DILM32-XSPR500 281204 | 10 Off | | | |
| 24 - 48 AC 110 - 240 AC 240 - 500 AC | DILM40 - DILM95 DILK33 - DILK50 DILMP63 - DILMP200 | | DILM95-XSPR48 281205 | 10 Off | | | |
| | | | DILM95-XSPR240 281206 | 10 Off | | | |
| | | | DILM95-XSPR500 281207 | 10 Off | | | |
| 24 - 48 AC 48 - 130 AC 130 - 240 AC 240 - 500 AC | DILM7 - DILM15 DILMP20 DILA | | DILM12-XSPV48 281208 | 10 Off | | | For AC operated contactors 50 - 60 Hz. DC operated contactors and DILM115 and DILM150 have an integrated suppressor. Note drop-out delay. |
| | | | DILM12-XSPV130 281209 | 10 Off | | | |
| | | | DILM12-XSPV240 281210 | 10 Off | | | |
| 24 - 48 AC 48 - 130 AC 130 - 240 AC 240 - 500 AC | DILM17 - DILM32 DILK12 - DILK25 DILL... DILMP32 - DILMP45 | | DILM12-XSPV500 281211 | 10 Off | | | |
| | | | DILM32-XSPV48 281212 | 10 Off | | | |
| | | | DILM32-XSPV130 281213 | 10 Off | | | |
| 24 - 48 AC 48 - 130 AC 130 - 240 AC 240 - 500 AC | DILM40 - DILM95 DILK33 - DILK50 DILMP63 - DILMP200 | | DILM32-XSPV240 281214 | 10 Off | | | |
| | | | DILM32-XSPV500 281215 | 10 Off | | | |
| | | | DILM95-XSPV48 281216 | 10 Off | | | |
| 24 - 48 AC 48 - 130 AC 130 - 240 AC 240 - 500 AC | DILM40 - DILM95 DILK33 - DILK50 DILMP63 - DILMP200 | | DILM95-XSPV130 281217 | 10 Off | | | |
| | | | DILM95-XSPV240 281218 | 10 Off | | | |
| | | | DILM95-XSPV500 281219 | 10 Off | | | |

Information relevant for export to North America



| | |
|-------------------|--|
| Product Standards | IEC/EN 60947-4-1; UL 508; CSA-C22.2 No.14-05; CE marking |
| UL File No. | E29096 |
| UL CCN | NLDX |
| CSA File No. | 227038 |
| CSA Class No. | 3211-07 |
| NA Certification | UL Listed, CSA certified |

Ordering

DILM...-XSP... Suppressor circuits

Varistor suppressors with integrated LED

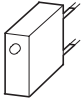

Diode suppressor



| Voltage U_s V | For use with | Circuit symbol | Part no. Article no. | Price See price list | Std. pack | Notes |
|-----------------------|------------------------------------|----------------|----------------------------------|-------------------------|------------|---|
| 24 - 48 AC | DILM7 - DILM15 DILMP20 | | DILM12-XSPVL48 281220 | | 10 Off | For AC operated contactors 50 - 60 Hz. DC operated contactors and DILM115 and DILM150 have an integrated suppressor. Note drop-out delay. |
| 130 - 240 AC | DILA | | DILM12-XSPVL240 281221 | | 10 Off | |
| 24 - 48 AC | DILM17 - DILM32 DILK12 - DILK25 | | DILM32-XSPVL48 281222 | | 10 Off | |
| 130 - 240 AC | DILL... DILMP32 - DILMP45 | | DILM32-XSPVL240 281223 | | 10 Off | |
| 24 - 48 AC | DILM40 - DILM95 DILK33 - DILK50 | | DILM95-XSPVL48 281224 | | 10 Off | |
| 130 - 240 AC | DILMP63 - DILMP200 | | DILM95-XSPVL240 281225 | | 10 Off | |
| 12 - 250 DC | DILM7 - DILM15 DILMP20 DILA | | DILM12-XSPD 101672 | | 10 Off | DC operated contactors. Prevention of negative switch-off voltage when the contactor is used together with a safety PLC. |











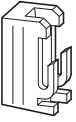

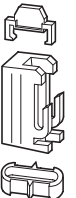

Information relevant for export to North America

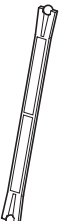
| | | |
|--|-------------------|--|
| | Product Standards | IEC/EN 60947-4-1; UL 508; CSA-C22.2 No.14-05; CE marking |
| | UL File No. | E29096 |
| | UL CCN | NLDX |
| | CSA File No. | 227038 |
| | CSA Class No. | 3211-07 |
| | NA Certification | UL Listed, CSA certified |



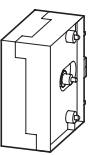















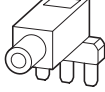

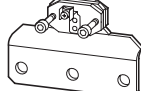





1.1 Contactor relays, contactors

Accessories

1 DILM...-XDILM...-XVB, DILM...-XMV







| | For use with | Part no. Article no. | Price See price list | Std. pack | Notes | Information relevant for export to North America  | |
|---|--|-------------------------------|-------------------------|--|--|---|--|
| Mechanical interlocks | | | | | | | |
| For mechanically linking contactors in combinations 0 mm distance between contactors. | | | | | | | |
|  | DILM7 - DILM72 DILA | DILM32-XVB 281227 | | 50 Off  | – | Product Standards | IEC/EN 60947-4-1; UL 508; CSA-C22.2 No.14-05; CE marking |
| | | | | | | UL File No. | E36332 |
| | | | | | | UL CCN | NLRV |
| | | | | | | CSA File No. | 012528 |
| | | | | | | CSA Class No. | 3211-05 |
| | | | | | | NA Certification | UL Listed, CSA certified |
|  | DILM80 - DILM170 | DILM150-XVB 281226 | | 10 Off  | – | Product Standards | IEC/EN 60947-4-1; UL 508; CSA-C22.2 No.14-05; CE marking |
| | | | | | | UL File No. | E29184 |
| | | | | | | UL CCN | NKCR |
| | | | | | | CSA File No. | 012528 |
| | | | | | | CSA Class No. | 3211-03 |
| | | | | | | NA Certification | UL Listed, CSA certified |
| Mechanical interlocks | | | | | | | |
|  | DILM7 - DILM15 DILMP20 DILA | DILM12-XMV 281196 | | 1 Off  | For two contactors with AC or DC operation arranged vertically or horizontally. Distance between contactors 0 mm, including contactor connector Mechanical lifespan 2.5 x 10 ⁶ operations. DILM 150-XMV including mounting plate for contactors. Additional auxiliary contact modules possible. →36 | Product Standards | IEC/EN 60947-4-1; UL 508; CSA-C22.2 No.14-05; CE marking |
| | | | | | | UL File No. | E29096 |
| | | | | | | UL CCN | NLDX |
| | | | | | | CSA File No. | 012528 |
| | | | | | | CSA Class No. | 2411-03 |
| | | | | | | NA Certification | UL Listed, CSA certified |
|  | DILM17 - DILM38 | DILM32-XMV 281197 | | 1 Off  | | Product Standards | IEC/EN 60947-4-1; UL 508; CSA-C22.2 No.14-05; CE marking |
| | | | | | | UL File No. | E29096 |
| | | | | | | UL CCN | NLDX |
| | | | | | | CSA File No. | 012528 |
| | | | | | | CSA Class No. | 2411-03,3211-04 |
| | | | | | | NA Certification | UL Listed, CSA certified |
| | DILM40 - DILM72 | DILM65-XMV 281198 | | 1 Off  | | Product Standards | IEC/EN 60947-4-1; UL 508; CSA-C22.2 No.14-05; CE marking |
| | | | | | | UL File No. | E29096 |
| | | | | | | UL CCN | NLDX |
| | | | | | | CSA File No. | 012528 |
| | | | | | | CSA Class No. | 2411-03 |
| | | | | | | NA Certification | UL Listed, CSA certified |
| | DILM80 - DILM170 | DILM150-XMV 240081 | | 1 Off  | | Product Standards | IEC/EN 60947-4-1; UL 508; CSA-C22.2 No.14-05; CE marking |
| | | | | | | UL File No. | E29096 |
| | | | | | | UL CCN | NLDX |
| | | | | | | CSA File No. | 012528 |
| | | | | | | CSA Class No. | 2411-03 |
| | | | | | | NA Certification | UL Listed, CSA certified |
|  | DILM185A, DILM225A, DILM250, DILM300A, DILM400, DILM500, DILM570 | DILM500-XMV 208289 | | 1 Off  | For contactors with the same or different magnet systems mounted horizontally or vertically, mechanical lifespan 5 x 10 ⁶ operations. No auxiliary contact permitted between mechanical interlock and contactor. Combination only with consecutive installation sizes or DILM185A - DILM570. | Product Standards | IEC/EN 60947-4-1; UL 508; CSA-C22.2 No.14-05; CE marking |
| | | | | | | UL File No. | E29184 |
| | | | | | | UL CCN | NKCR |
| | | | | | | CSA File No. | 012528 |
| | | | | | | CSA Class No. | 3211-04 |
| | | | | | | NA Certification | UL Listed, CSA certified |
| | DILM580, DILM650, DILM750, DILM820 DILM1000 | DILM820-XMV 208288 | | 1 Off  | For contactors with the same or different magnet systems mounted horizontally or vertically, mechanical lifespan 5 x 10 ⁶ operations. No auxiliary contact permitted between mechanical interlock and contactor. DILM820-XMV consists of interlock element and mounting plate. | Product Standards | IEC/EN 60947-4-1; UL 508; CSA-C22.2 No.14-05; CE marking |
| | | | | | | UL File No. | E29184 |
| | | | | | | UL CCN | NKCR |
| | | | | | | CSA File No. | 012528 |
| | | | | | | CSA Class No. | 3211-04 |
| | | | | | | NA Certification | UL Listed, CSA certified |
| Set of spare parts for mechanical interlock | | | | | | | |
| Ball for mechanical interlock, incl. contactor connector. | | | | | | | |
| – | DILM80 - DILM170 | DILM150-XMVE 107020 | | 1 Off  | | UL/CSA certification not required | |

DILM...-XP1, DILM...-XS1

| For use with | Circuit symbol | Part no. Article no. | Price See price list | Std. pack | Notes | Information relevant for export to North America |
|---|--------------------|------------------------------|-------------------------|---|--|--|
| Paralleling links for main contacts | | | | | | |
| Consisting of 2 paralleling links | | | | | | |
|  | DILM7 - DILM15 | DILM12-XP1 281193 | | 5 Off   | 4th pole can be broken off AC-1 current carrying capacity of the open contactor increases by a factor of 2.5 Protected against accidental contact in accordance with VDE 0106 Part 100 | Product Standards UL File No. UL CCN CSA File No. CSA Class No. NA Certification |
|  | DILM17 - DILM32 | DILM32-XP1 281194 | | 5 Off   | | IEC/EN 60947-4-1; UL 508; CSA-C22.2 No.14-05; CE marking E29096 NLDX 012528 3211-03 UL Listed, CSA certified |
|  | DILM40 - DILM72 | DILM65-XP1 281195 | | 1 Off   | A cover is included with DILM185-XP1 for protection against accidental contact. | |
|  | DILM80 - DILM170 | DILM150-XP1 284769 | | 1 Off   | Connection cross section for DILM...-XP1 Technical data | |
|  | DILM185A | DILM185-XP1 208292 | | 1 Off | | – |
| Star-point bridges | | | | | | |
|  | DILM7 - DILM15 | DILM12-XS1 281190 | | 20 Off   | <ul style="list-style-type: none"> Designed as tool-less plug connection Use as DILA-XHIT... contactor auxiliary contact → 38 | Product Standards UL File No. UL CCN CSA File No. CSA Class No. NA Certification |
|  | DILM17 - DILM32 | DILM32-XS1 281191 | | 20 Off   | Use as DILA-XHIT... contactor auxiliary contact → 38 | Product Standards UL File No. UL CCN CSA File No. CSA Class No. NA Certification |
| | DILM40 - DILM72 | DILM65-XS1 281192 | | 10 Off   | – | IEC/EN 60947-4-1; UL 508; CSA-C22.2 No.14-05; CE marking E36332 NLRV 012528 3211-04 UL Listed, CSA certified |
| | DILM80 - DILM170 | DILM150-XS1 284768 | | 5 Off   | – | Product Standards UL File No. UL CCN CSA File No. CSA Class No. NA Certification |
|  | DILM185A - DILM400 | DILM400-XS1 208291 | | 1 Off   | A cover is included for protection against accidental contact. | Product Standards UL File No. UL CCN CSA File No. CSA Class No. NA Certification |
| | DILM500 | DILM500-XS1 208290 | | 1 Off   | A cover is included for protection against accidental contact. | Product Standards UL File No. UL CCN NA Certification |









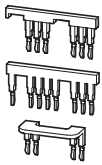

DILM...-XSL Star-delta wiring kit

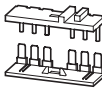
Main current wiring for star-delta combination Including star-point bridge







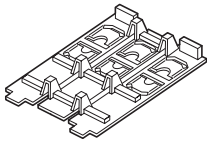

| For use with | Part no. Article no. | Price See price list | Std. pack | Notes | Information relevant for export to North America |
|--|---|------------------------------|--|---|--|
|  | DILM7/9/12/15 mains contactors DILM7/9/12/15 delta contactors DILM7/9/12/15 star contactors | DILM12-XSL 283130 | 1 Off  | <ul style="list-style-type: none"> Designed for tool-less plug connection Use as DILA-XHIT... contactor auxiliary contact → 38 The following control cables are integrated in addition to electrical interlock: <ul style="list-style-type: none"> Q13: A1 - Q15: 21 Q13: 21 - Q15: A1 Q13: A2 - Q15: A2 | Product Standards IEC/EN 60947-4-1; UL 508; CSA-C22.2 No.14-05; CE marking 012528 CSA File No. 3211-05 CSA Class No. 3211-05 NA Certification UL Listed, CSA certified |
| | DILM17/25/32 mains contactors DILM17/25/32 delta contactors DILM17/25/32 star contactors | DILM32-XSL 283131 | 1 Off  | Consists of the following connection bridges: <ul style="list-style-type: none"> Mains - delta contactors Delta - star contactors Star-point bridge | Product Standards IEC/EN 60947-4-1; UL 508; CSA-C22.2 No.14-05; CE marking UL File No. E36332 UL CCN NLRV CSA File No. 012528 CSA Class No. 3211-04 NA Certification UL Listed, CSA certified |
| | DILM40/50/65 mains contactors DILM40/50/65 delta contactors DILM40/50/65 star contactors | DILM65-XSL 101058 | 1 Off  | | Product Standards IEC/EN 60947-4-1; UL 508; CSA-C22.2 No.14-05; CE marking UL File No. E36332 UL CCN NLRV CSA File No. 012528 CSA Class No. 3211-04 NA Certification UL Listed, CSA certified |
| | DILM 80/95 mains contactors DILM80/95 delta contactors DILM50/65 star contactors | DILM95-XSL 101486 | 1 Off | | – |
|  | DILM 115/150 mains contactors DILM115/150 delta contactors DILM80/95/115 star contactors | DILM150-XSL 101487 | 1 Off  | | Product Standards IEC/EN 60947-4-1; UL 508; CSA-C22.2 No.14-05; CE marking UL File No. E36332 UL CCN NLRV CSA File No. 012528 CSA Class No. 2411-03,3211-04 NA Certification UL Listed, CSA certified |
| | DILM 185/225 mains contactors DILM185/225 delta contactors DILM115/150 star contactors | DILM225-XSL 101488 | 1 Off | | – |

DILM...-XRL, DILM...XIP2X Reversing starter wiring kits

Main current wiring for reversing combinations

| For use with | Part no. Article no. | Price See price list | Std. pack | Notes | Information relevant for export to North America |
|---|-------------------------|------------------------------|--|--|---|
|  | DILM7 | DILM12-XRL 283108 | 1 Off   | <ul style="list-style-type: none"> Designed for tool-less plug connection As auxiliary contact DILA-XHIT...use → 38 The following control cables are integrated in addition to electrical interlock: <ul style="list-style-type: none"> Q11: A1 - Q12: 21 Q11: 21 - Q12: A1 Q11: A2 - Q12: A2 | Product Standards IEC/EN 60947-4-1; UL 508; CSA-C22.2 No.14-05; CE marking E36332 UL File No. NLRV UL CCN 012528 CSA File No. 3211-05 CSA Class No. UL Listed, CSA certified NA Certification |
| | DILM9 | | | | |
| | DILM12 | | | | |
|  | DILM17 | DILM32-XRL 283109 | 1 Off   | - | Product Standards IEC/EN 60947-4-1; UL 508; CSA-C22.2 No.14-05; CE marking E36332 UL File No. NLRV UL CCN 012528 CSA File No. 3211-04 CSA Class No. UL Listed, CSA certified NA Certification |
| | DILM25 | | | | |
| | DILM32 | | | | |
|  | DILM40 | DILM65-XRL 101057 | 1 Off   | - | Product Standards IEC/EN 60947-4-1; UL 508; CSA-C22.2 No.14-05; CE marking E36332 UL File No. NLRV UL CCN 012528 CSA File No. 3211-04 CSA Class No. UL Listed, CSA certified NA Certification |
| | DILM50 | | | | |
| | DILM65 | | | | |
|  | DILM80 | DILM150-XRL 101681 | 1 Off   | - | Product Standards IEC/EN 60947-4-1; UL 508; CSA-C22.2 No.14-05; CE marking E36332 UL File No. NLRV UL CCN 012528 CSA File No. 2411-03, 3211-04 CSA Class No. UL Listed, CSA certified NA Certification |
| | DILM95 | | | | |
| | DILM115 | | | | |
| | DILM150 | | | | |

DILM...-XRL, DILM...XIP2X IP2X cover set







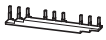

| For use with | Part no. Article no. | Price See price list | Std. pack | Notes | Information relevant for export to North America |
|---|-------------------------|--------------------------------|--|---|---|
|  | DILM17 | DILM32-XIP2X 118855 | 1 Off   | Each cover set consists of two three-pole and two single-pole covers. | UL/CSA certification not required |
| | DILM25 | | | | |
| | DILM32 | | | | |
| | DILM38 | | | | |
| | DILMP32 | | | | |
| | DILMP45 | | | | |
|  | DILM40 | DILM65-XIP2X 106491 | 8 Off   | 2 covers are required per phase The cover set consists of 8 covers | UL/CSA certification not required |
| | DILM50 | | | | |
| | DILM65 | | | | |
| | DILM72 | | | | |
| | DILMP63 | | | | |
| | DILMP80 | | | | |
|  | DILM80 | DILM150-XIP2X 106492 | 8 Off   | | UL/CSA certification not required |
| | DILM95 | | | | |
| | DILM115 | | | | |
| | DILM150 | | | | |
| | DILM170 | | | | |
| | DILMP125 | | | | |
| | DILMP160 | | | | |
| | DILMP200 | | | | |
| | ZB150 | | | | |

1

DILM12-XDSBS Three-phase commoning links

Protected against accidental contact, short-circuit proof, $U_e = 690\text{ V}$, $I_u = 35\text{ A}$ Can be extended by rotating by mounting







| For use with | Part no. Article no. | Price See price list | Std. pack | Notes | Information relevant for export to North America |
|------------------------------------|---------------------------------|-------------------------|--|---|--|
| DILM7 DILM9 DILM12 DILM15 | DILM12-XDSB0/3 240084 | | 5 Off   | Suitable for 3 contactors. Length 112 mm | Product Standards   IEC/EN 60947-4-1; UL 508; CSA-C22.2 No.14-05; CE marking E36332 UL File No. UL CCN CSA File No. CSA Class No. NA Certification |
| DILM7 DILM9 DILM12 DILM15 | DILM12-XDSB0/4 240085 | | 5 Off   | Suitable for 4 contactors. Length 157 mm | NLRV 012528 2411-03 UL Listed, CSA certified |
| DILM7 DILM9 DILM12 DILM15 | DILM12-XDSB0/5 240086 | | 5 Off   | Suitable for 5 contactors. Length 202 mm | |

DILM12-XDSBS Incoming connection block

For use with





| Part no. Article no. | Price See price list | Std. pack | Notes | Information relevant for export to North America |
|-------------------------|-------------------------|-----------|-------|--|
|-------------------------|-------------------------|-----------|-------|--|

| | | | | | |
|------------------------------------|-----------------------------|--|--|--|--|
| DILM7 DILM9 DILM12 DILM15 | DILM12-XEK 240083 | | 5 Off   | For three-phase commoning link, protected against accidental contact, $U_e = 690\text{ V}$, $I_u = 35\text{ A}$. Terminal capacities: Stranded 2.5...16 mm ² Flexible with ferrule 2.5...16 mm ² AWG14...8 | Product Standards   IEC/EN 60947-4-1; UL 508; CSA-C22.2 No.14-05; CE marking E36332 UL File No. UL CCN CSA File No. CSA Class No. NA Certification |
|------------------------------------|-----------------------------|--|--|--|--|

DILM12-XDSBS Adapter plate

Enables clipping on of switches on to DIN rails



| For use with | Part no. Article no. | Price See price list | Std. pack | Notes | Information relevant for export to North America |
|---|----------------------------|-------------------------|--|------------------------|---|
| DILM80 DILM95 DILM115 DILM150 DILM170 | NZM2-XC75 260215 | | 1 Off   | For top-hat rail 75 mm | Product Standards   IEC/EN 60947-4-1; UL 489; CSA-C22.2 No.14-05; CE marking E140305 UL File No. UL CCN DIHS CSA File No. CSA Class No. NA Certification |

DILM32-XTE

Electronic timer modules

On-delayed, Cannot be combined with top mounting auxiliary contacts Incl. suppressor circuits

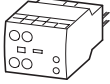

Off-delayed, auxiliary voltage-free Cannot be combined with top mounting auxiliary contacts Incl. suppressor circuits

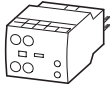

For star-delta applications Cannot be combined with top mounting auxiliary contacts Incl. suppressor circuits

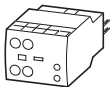

| | For use with | Circuit symbol | Part no. Article no. | Price See price list | Std. pack | Notes | |
|------------------|------------------------------------|----------------|--|--|-----------|---|-----------------------------|
| 24 V AC/DC | DILM7 - DILM32 | | DILM32-XTEE11(RA24) 101440 | | 1 Off | Time range can be selected | |
| 100 ... 130 V AC | DILMP20 DILMP32-DILMP45 DILA | | DILM32-XTEE11(RAC130) 101441 | | 1 Off | 0.05 s...1 s 0.5 s...10 s 5 s...100 s | |
| 200 ... 240 V AC | | | DILM32-XTEE11(RAC240) 101442 | | 1 Off | | |
| 24 V AC/DC | DILM7 - DILM32 | | DILM32-XTED11-1(RA24) 105210 | | 1 Off | Time range 0.05 s...1 s | |
| 24 V AC/DC | DILMP20 DILMP32-DILMP45 DILA | | DILM32-XTED11-10(RA24) 104943 | | 1 Off | Time range 0.5 s...10 s | |
| 24 V AC/DC | | | DILM32-XTED11-100(RA24) 104946 | | 1 Off | Time range 5 s...100 s | |
| 100 ... 130 V AC | | | DILM32-XTED11-1(RAC130) 105211 | | 1 Off | Time range 0.05 s...1 s | |
| 100 ... 130 V AC | | | DILM32-XTED11-10(RAC130) 104944 | | 1 Off | Time range 0.5 s...10 s | |
| 100 ... 130 V AC | | | DILM32-XTED11-100(RAC130) 104947 | | 1 Off | Time range 5 s...100 s | |
| 200 ... 240 V AC | | | DILM32-XTED11-1(RAC240) 105212 | | 1 Off | Time range 0.05 s...1 s | |
| 200 ... 240 V AC | | | DILM32-XTED11-10(RAC240) 104945 | | 1 Off | Time range 0.5 s...10 s | |
| 200 ... 240 V AC | | | DILM32-XTED11-100(RAC240) 104948 | | 1 Off | Time range 5 s...100 s | |
| 24 V AC/DC | DILM7 - DILM32 | | | DILM32-XTEY20(RA24) 101446 | | 1 Off | Changeover time 1...30 s |
| 100 ... 130 V AC | DILMP20 DILMP32-DILMP45 DILA | | | DILM32-XTEY20(RAC130) 101447 | | 1 Off | 50 ms changeover delay |
| 200 ... 240 V AC | | | | DILM32-XTEY20(RAC240) 101448 | | 1 Off | Sample circuit → Page 92 |

Information relevant for export to North America



| | |
|-------------------|--|
| Product Standards | IEC/EN 60947-4-1; UL 508; CSA-C22.2 No.14-05; CE marking |
| UL File No. | E29184 |
| UL CCN | NKCR |
| CSA File No. | 012528 |
| CSA Class No. | 3211-03 |
| NA Certification | UL Listed, CSA certified |

1.1

Contactors relays, contactors



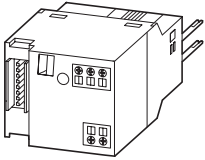

Accessories

1









DIL-SWD..., DILM12-XMC SWD contactor modules

SmartWire-DT® module for installation on contactors. One module per contactor

| | For use with | Part no. Article no. | Price See price list | Std. pack | Notes |
|---|--|--|----------------------------|--|---|
| Two digital inputs for potential-free contacts. 1 electrical interlock for the surface mounting of reversing starters. Messages: Contactor switch status, status of the digital inputs 1 and 2. Commands: Contactor actuation | DILM(C)7... - DILM(C)32 DILM38 DILA | DIL-SWD-32-001¹⁾ 118560 | | 5 Off   | <ul style="list-style-type: none"> Take into account the max. current consumption of the contactor coils per SmartWire-DT® line. A2 terminals must not be bridged. Wiring sets DILM 12-XRL and PKZM0-XRM12 cannot be used. Connection terminals for electrical interlocking are not suitable for safety technology. |
| Two digital inputs for potential-free contacts. 1 electrical interlock for the surface mounting of reversing starters. 1-0-A switch for manual or automatic operation. Messages: contactor switching position, status of the digital inputs 1 and 2, 1-0-A switch position. Commands: Contactor actuation | DILM(C)7... - DILM(C)32 DILM38 DILA | DIL-SWD-32-002¹⁾ 118561 | | 5 Off   | |

DIL-SWD..., DILM12-XMC Wiring set for motor feeder plug

| For use with | Part no. Article no. | Price See price list | Std. pack | Notes |
|---|---|----------------------------|--|--|
| DILM(C)7 DILM(C)9 DILM(C)12 DILM(C)15 | DILM12-XMCE²⁾ 121764 | | 5 Off   | 35x7.5 (15) mm mounting rail (as per DIN EN 60715) with PE function required. For connection of: PE 0.75 – 4 mm ² |
| DILM(C)7 DILM(C)9 DILM(C)12 DILM(C)15 | DILM12-XMCP/E²⁾ 121769 | | 1 Off   | 35x7.5 (15) mm mounting rail (as per DIN EN 60715) with PE function required. For connection of: L1, L2, L3, PE 0.75 – 2.5 mm ² |
| PKZM0/PKE + DILM(C)7 PKZM0/PKE + DILM(C)9 PKZM0/PKE + DILM(C)12 PKZM0/PKE + DILM(C)15 MSC-D(E)-...-M7... MSC-D(E)-...-M9... MSC-D(E)-...-M15... | DILM12-XMCP/T²⁾ 121770 | | 1 Off   | For connection of: L1, L2, L3, PE 0.75 – 2.5 mm ² |

PE module with contact plate

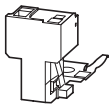

Motor plate with PE module and contact plate

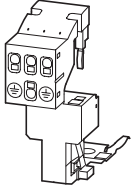

Motor plate with PE module and contact plate











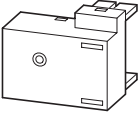

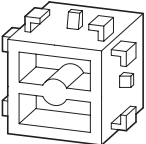
Information relevant for export to North America

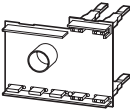

- 1) NA Certification Request filed for UL and CSA
2) Product Standards IEC/EN 60947-4-1; UL 508; CSA-C22.2 No. 14-05; CE marking
NA Certification Request filed for UL and CSA

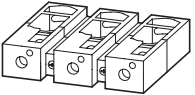
DILM...-X...

| | For use with | Part no. Article no. | Price See price list | Std. pack | Notes | Information relevant for export to North America  |
|---|--|---------------------------------|-------------------------|---|--|--|
| Motor suppressor module | | | | | | |
| Can be used at 380...575 V 50/60 Hz. | | | | | | |
|  | DILM7 - DILM15 | DILM12-XMSM 109399 | | 4 Off  | <ul style="list-style-type: none"> • Tool-less version using tool-less plug connection • RC suppressor • Ambient temperature -25...+60 °C, open. • Insulated material, difficult to ignite according to UL 94. • Weight = 0.05 kg. • UL/CSA approval applied for | Product Standards IEC/EN 60947-4-1; UL 508; CE marking UL File No. E300273 UL CCN NMTR2 NA Certification UL Listed |
| Test block | | | | | | |
| Suitable for switching on contactor off-load | | | | | | |
|  | DILM7 - DILM38 DILA | DILM32-XMAN 110955 | | 1 Off  | – | UL/CSA certification not required |
| Printed board contact | | | | | | |
| For the adaption of a control circuit on a printed-circuit board | | | | | | |
|  | DILM7 - DILM15 DILA | DILM12-XPBC 109400 | | 4 Off | – | – |
| Load resistor | | | | | | |
| For DC contactors in order to increase power consumption | | | | | | |
|  | DILM17 DILM25 DILM32 DILM38 DILMP32 DILMP45 | DILM32-XSPLW24 112419 | | 1 Off  | Installed in a suppressor circuit enclosure. Required when using special PLC outputs for actuation, e.g.: Beckhoff safety controllers. | Product Standards IEC/EN 60947-4-1; CSA-C22.2 No.14-05; CE marking CSA File No. 225135 CSA Class No. 3211-07 NA Certification CSA certified |
| Extension terminals | | | | | | |
| | DILM80 DILM95 DILM115 DILM150 DILM170 | DILM150-XZK 104486 | | 10 Off  | Can be fitted on every main terminal of the contactor. Connection options: maximum 2 x 4 mm ² solid maximum 2 x 2.5 mm ² flexible with ferrule | Product Standards IEC/EN 60947-4-1; UL 508; CSA-C22.2 No.14-05;CE marking UL File No. E29184 UL CCN NKCR CSA File No. 012528 CSA Class No. 2411-03, 2411-04 NA Certification UL Listed, CSA certified |
| Cable terminal block | | | | | | |
| With control circuit terminal Consisting of three flat ribbon terminals | | | | | | |
|  | DILM250 DILM300A DILM400 | DILM400-XKU-S 208293 | | 1 Off  | Connection options: round conductors, flexible and stranded, ribbon cables. | Product Standards IEC/EN 60947-4-1; UL 508; CSA-C22.2 No.14-05;CE marking UL File No. E29184 UL CCN NKCR CSA File No. 012528 CSA Class No. 3211-04 NA Certification UL Listed, CSA certified |

1.1

Contactors relays, contactors



Accessories

1

DILM...-XK... Flat strip conductor terminal kit

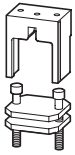





With control cable connection















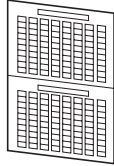

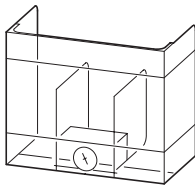



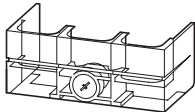

| For use with | Part no. Article no. | Price See price list | Std. pack | Notes | Information relevant for export to North America   |
|--|--------------------------------|-------------------------|-----------|--------------------------------------|---|
| DILM580 DILM650 DILM750 DILM820 | DILM820-XKB-S 208295 | | 1 Off | Connection options: ribbon cables | |

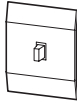
DILM...-XK... Connection terminal sets for North America

Consist of three individual terminals

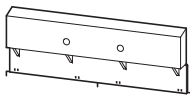
| Conductor material | Cross-section X number of cores mm ² | For use with | Part no. Article no. | Price See price list | Std. pack | Notes | Information relevant for export to North America   |
|---------------------|--|--|---------------------------------|-------------------------|--|--|--|
| Copper, aluminum | 2 x (AWG4 ... MCM500) | DILM500/22 | DILM500-XK-CNA 232192 | | 1 Off   | Including cover With control cable connec- tion | Product Standards IEC/EN 60947-4-1; UL 508; CSA-C22.2 No.14-05; CE marking E29184 NKCR UL File No. UL CCN CSA File No. CSA Class No. NA Certification 012528 3211-04 UL Listed, CSA certified |
| Copper, aluminum | 4 x (AWG2 ... MCM500) | DILM580/22 DILM650/22 DILM750/22 DILM820/22 | DILM820-XK-CNA 232194 | | 1 Off   | | |

DILM...-XHB, DILM...-XAB

| Description | For use with | Part no. Article no. | Price See price list | Std. pack | Notes | Information relevant for export to North America  |
|---|---|--------------------------------|--|---|---|--|
| Sealable shrouds | | | | | | |
| Transparent | | | | | | |
|  | DILM32-XTE... | DILM32-XTEPLH 101449 | | 1 Off | - | - |
| Device labelling, label sheet | | | | | | |
| 7.5 x 17 mm Colour: yellow HKS 3 (≈ RAL 1018) | | | | | | |
|  | Labelling with laser printer, plotter, film plotter, copier | XGKE-GE 207517 | | 25 Off  | 1 off = 1 sheet 240 labels per sheet 1 sheet = DIN A4, Can be split into two DIN A5 sheets | UL/CSA certification not required |
| Covers | | | | | | |
| Terminal cover | | | | | | |
|  | DILM185A | DILM225A-XHB 139560 | | 1 Off  | To provide terminals with protection against accidental contact vertical from the front | UL/CSA certification not required |
| | DILM225A | | | 1 Off  | | |
| | DILM250 | DILM400-XHB 208287 | | 1 Off  | | |
| | DILM300A | | | | | |
| | DILM400 | | | | | |
| | DILM500 | DILM500-XHB 208286 | | 1 Off  | | |
| DILM580 | DILM650-XHB 208285 | | 1 Off  | | | |
| DILM650 | | | | | | |
| DILM750 | DILM820-XHB 208284 | | 1 Off  | | | |
| DILM820, | | | | | | |
| DILM1000 | | | | | | |
| Shroud for star-point bridge | | | | | | |
|  | DILM400-XS1 | DILM400-XHBS1 101687 | | 1 Off  | Can be combined with star-delta wiring kits DILM250-XSL and DILM400-XSL. | UL/CSA certification not required |
| Auxiliary contact seat cover | | | | | | |
|  | DILM7 - DILM38 DILMP32 DILMP45 DILA DILL | DILM32-XAB 129538 | | 10 Off  | For preventing manual actuation. Cannot be combined with additional surface mounting accessories | UL/CSA certification not required |
|  | DILM40 - DILM170 DILMP63 - DILMP200 | DILM150-XAB 121712 | | 10 Off  | | |
| Suppressor circuits for vacuum contactors (on load side) | | | | | | |
|  | DILM580 | DILM1000-XSM 125947 | | 1 Off  | For damping the cutout overvoltage when switching off inductive loads. | NA Certification Request filed for UL and CSA |
| | DILM650 | | | | | |
| DILM750 | | | | | | |
| DILM820 | | | | | | |
| DILM1000 | | | | | | |
| DILH2000 | DILH2600-XSM 125946 | | 1 Off  | | | |
| DILH2200 | | | | | | |
| DILH2600 | | | | | | |

1.1

Contactors relays, contactors

Accessories

1

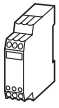

DILM...-XSP... Amplifier module for separate mounting

Input with integrated suppressor circuit for overvoltage limitation

| Rated operational current | | Actuating voltage | Actuating current | Circuit symbol | For use with | Part no. Article no. | Price See price list | Std. pack | Information relevant for export to North America |
|---------------------------|-------|-------------------|-------------------|----------------|--------------|---------------------------|-------------------------|-----------|--|
| AC-15 | DC | | | | | | | | |
| 230 V | 400 V | 220 V | | | | | | | |
| I_e | I_e | I_e | U_s | I | | | | | |
| A | A | A | V DC | mA | | | | | |
| 2 | 2 | 0.03 | 24 | 25 | | ETS4-VS3 083094 | | 1 Off | Product Standards IEC/EN 60947-4-1; UL 508; CSA-C22.2 No. 14-05; CE marking UL File No. E36332 UL CCN NLRV CSA File No. 012528 CSA Class No. 2411-03, 3211-04 NA Certification UL Listed, CSA certified |

Notes Contactor coils with rated operational current > 2 A must be actuated via the DILER-G mini contactor relay.
 Rated operational current DC:
 Making and breaking conditions DC-13, time L/R 300ms

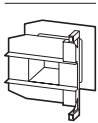

DILM...-XSP... Individual coils

| For use with | DC voltage | Part no. Article no. | Prices See price list | AC voltage | Part no. Article no. | Price See price list | Std. pack | Notes |
|--------------------------------------|------------|---|--------------------------|--|-------------------------|-------------------------|-----------|---|
| DILM17 DILM25 DILM32 DILM38 | | DILM32-XSP(RDC24)¹⁾ 281155 | | DILM32-XSP(230V50Hz,240V60Hz) | 281141 | | 1 Off | For additional actuating voltages → Page 75 |
| DILM40 DILM50 DILM65 DILM72 | | DILM65-XSP(RDC24)¹⁾ 281185 | | DILM65-XSP(230V50Hz,240V60Hz) | 281171 | | 1 Off | |
| DILM80 DILM95 | | DILM95-XSP(RDC24)¹⁾ 230080 | | DILM95-XSP(230V50Hz,240V60Hz) | 230062 | | 1 Off | |
| DILM115 DILM150 DILM170 | | DILM150-XSP(RDC24)¹⁾ 230115 | | DILM150-XSP(RAC240)¹⁾ | 230112 | | 1 Off | |
| DILM185A DILM225A | | DILM225A-XSP(RDC24)¹⁾ 139568 | | DILM225A-XSP(RAC240)¹⁾ | 139565 | | 1 Off | |

Notes ¹⁾ Incl. electronic module

Information relevant for export to North America

| | | |
|--|-------------------|--|
| | Product Standards | IEC/EN 60947-4-1; UL 508; CSA-C22.2 No.14-05; CE marking |
| | UL File No. | E29096 |
| | UL CCN | NLDX |
| | CSA File No. | 012528 |
| | CSA Class No. | 2411-03, 3211-04 |
| | NA Certification | UL Listed, CSA certified |

DILM...-XSP/E... Electronic modules including coils

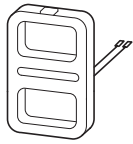
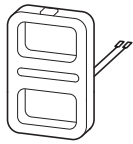

| For use with | DC voltage Part no. Article no. | Price See price list | AC voltage Part no. Article no. | Price See price list | Std. pack | Notes |
|--|--|----------------------------|---|----------------------------|-----------|--|
| DILM250 DILM300A | DILM250-XSP/E(RA250) ¹⁾ 208252 | | DILM250-XSP/E(RA250) ¹⁾ 208252 | | 1 Off | For additional actuating voltages → Page 77 |
| DILM400 DILM500 | DILM500-XSP/E(RA250) ¹⁾ 208256 | | DILM500-XSP/E(RA250) ¹⁾ 208256 | | 1 Off | |
| DILM580 DILM650 DILM750 DILM820 DILM1000 | DILM1000-XSP/E(RA250) ¹⁾ 289145 | | DILM1000-XSP/E(RA250) ¹⁾ 289145 | | 1 Off | |
| DILH1400 | – | | DILH1400-XSP/E(RAW250) ²⁾ 289161 | | 1 Off | |
| DILM250-S DILM300A-S | – | | DILM250-S-XSP/E(220-240V50/60Hz) ²⁾ 274202 | | 1 Off | |
| DILM400-S DILM500-S | – | | DILM500-S-XSP/E(220-240V50/60Hz) ²⁾ 274205 | | 1 Off | |

1)

Information relevant for export to North America



| | |
|-------------------|--|
| Product Standards | IEC/EN 60947-4-1; UL 508; CSA-C22.2 No.14-05; CE marking |
| UL File No. | E29096 |
| UL CCN | NLDX |
| CSA File No. | 1017510 |
| CSA Class No. | 3211-04 |
| NA Certification | UL Listed, CSA certified |

2)

Information relevant for export to North America



| | |
|-------------------|--|
| Product Standards | IEC/EN 60947-4-1; UL 508; CSA-C22.2 No.14-05; CE marking |
| UL File No. | E29096 |
| UL CCN | NLDX |
| CSA File No. | 012528 |
| CSA Class No. | 3211-04 |
| NA Certification | UL Listed, CSA certified |

1.1 Contactor monitoring devices

1 Description, ordering



General

For safety-related off switching to safety category 3 and 4 according to EN 954-1, at present two contactors must be used in series. Especially with larger contactors this is an expensive solution.

Application

This is where the CMD can be used. The function of the CMD is to monitor the main contacts of a contactor against welding. For this the control voltage of the contactor is compared with the state of the main contacts which is reliably monitored using a mirror contact (IEC EN 60947-4-1 Annex F). If the coil is de-energized and the contactor does not drop out the CMD trips the upstream circuit-breaker/motor protective circuit breaker/switch-disconnector via a shunt release.

Safety

The CMD has a safety-compliant design so that in safety combinations with a circuit-breaker/motor protective circuit breaker/switch-disconnector the reliable switch off in the case of a "welded contactor" can be guaranteed. In this application it replaces the series connection of a second contactor. As a component it conforms to safety category 3 according to EN 954-1 and EN ISO 13849.

Mounting

The CMD can be combined with the following Eaton components:

- Contactors:
 - DILEM
 - DILM7 to DILM150
 - DILM185(-S) to DILM500(-S):
 - DILM580 to DILM1600
 - DILH1400 ... DILH2000
 - SE-1A-PKZ2 and S-PKZ2
- Motor-protective circuit-breakers/circuit-breakers:
 - PKZ2 + U-PKZ2(18VDC)
 - NZM1 + NZM1-XUVL
 - NZM2 + NZM2/3-XUV
 - NZM3 + NZM2/3-XUV
 - NZM4 + NZM4-XUV
 - N1 + NZM1-XUVL
 - N2 + NZM2/3-XUV
 - N3 + NZM2/3-XUV
 - N4 + NZM4-XUV

For the wiring of the CMD the auxiliary N/C contact, mirror contact must be according to IEC/EN 60947-4-1 and the auxiliary N/O contact must be interlocked and opposing according to IEC/EN 60947-5-1. Also the auxiliary N/C contact for the feedback circuit must have a mirror contact function according to IEC/EN 60947-4-1.

Auxiliary contact requirements per contactor:

| | CMD | Self maintaining | Feedback circuit | Electrical interlock |
|-------------------|------------------|------------------|------------------|----------------------|
| DOL starter | 1 N/O + 1 N/C | 1S | 1 B | |
| Reversing starter | 1 N/O + 1 N/C | 1S | 1 B | 1 B |

Ordering

CMD contactor monitoring device

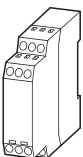

CMD

| Part no. Article no. | Price See Price List | Std. pack |
|----------------------------------|-------------------------|-----------|
| CMD(24VDC) 106170 | | 1 Off |
| CMD(220-240VAC) 106172 | | 1 Off |

Engineering

DOL starter

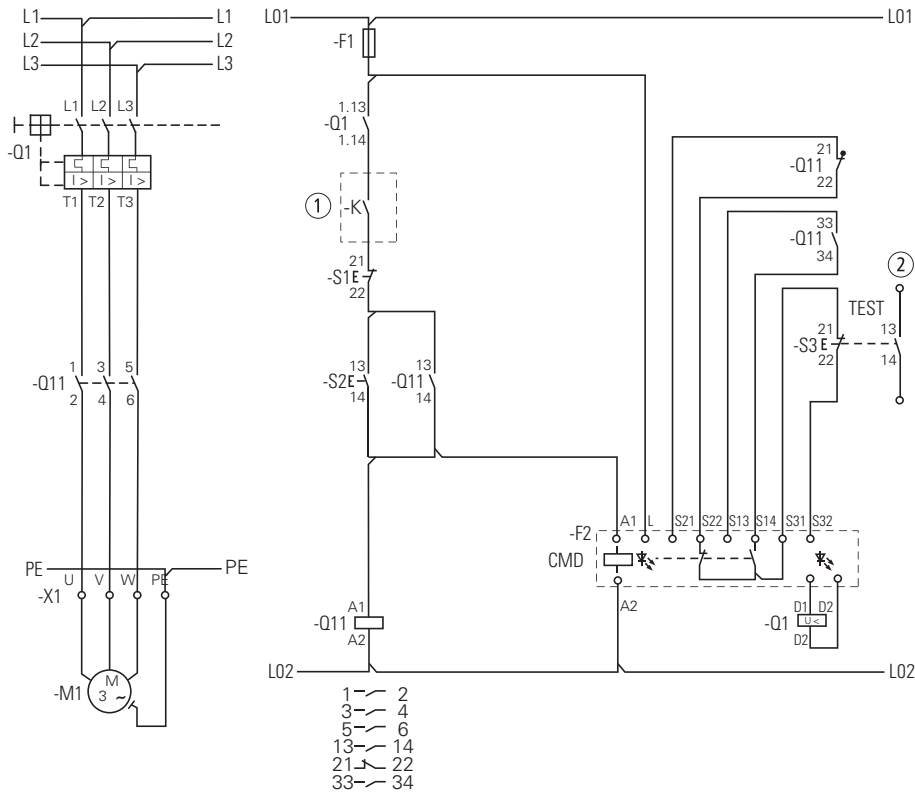

Reversing starter

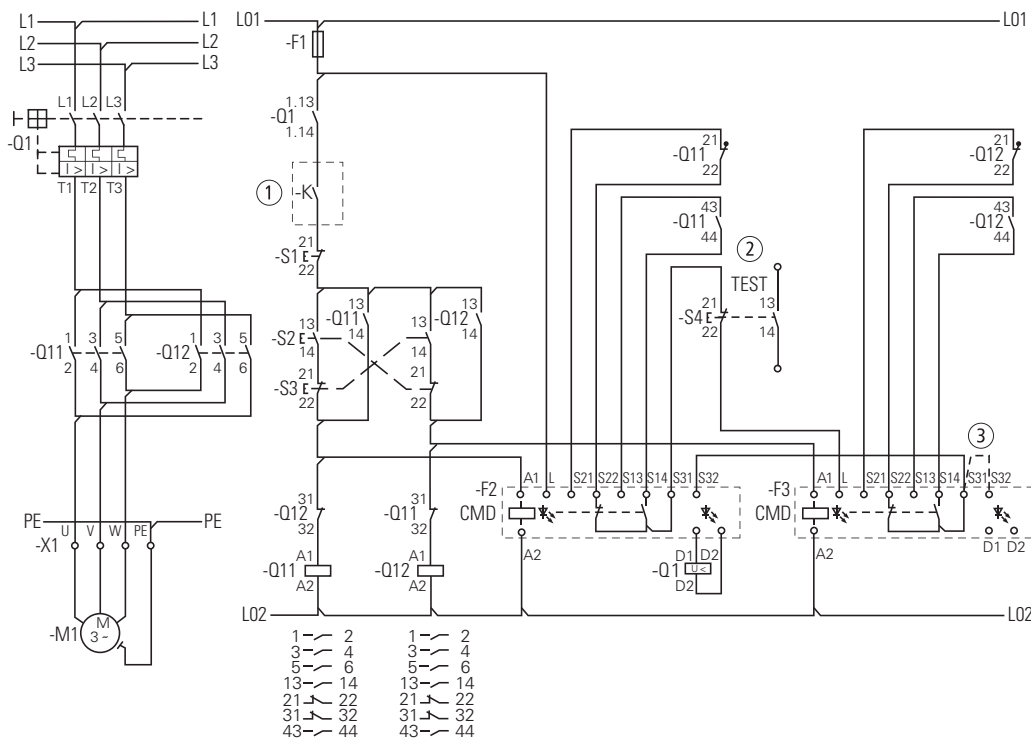

- ① Switching by safety relay of safety PLC
- ② Signal contact to PLC evaluation
- ③ CMD (24VDC)

1.1

Mini contactor relays, contactor relays

Actuating voltages

1 Ordering

DILER, DILEEM

| AC | DILER-40(...) | DILER-31(...) | DILER-22(...) | DILEEM-10(...) | DILEEM-01(...) |
|---------------------------------|---------------------------|---------------------------|---------------------------|---------------------------|---------------------------|
| | Article no. ¹⁾ | Article no. ¹⁾ | Article no. ¹⁾ | Article no. ¹⁾ | Article no. ¹⁾ |
| Standard voltages | See price list | See price list | See price list | See price list | See price list |
| 24V 50Hz | 010094 | 010251 | 010344 | 051604 | 051629 |
| 48V 50Hz | 010190 | 010044 | 010201 | 051603 | 051628 |
| 240V 50Hz | 010478 | 010300 | 010138 | 051602 | 051627 |
| 115V 60Hz | 010270 | 010204 | 010211 | 051598 | 051624 |
| 42V 50Hz, 48V 60Hz | – | – | – | 051612 | 051637 |
| 110V 50Hz, 120V 60Hz | 051756 | 051765 | 051774 | 051611 | 051636 |
| 190V 50Hz, 220V 60Hz | 051757 | 051766 | 051775 | 051610 | 051635 |
| 220V 50Hz, 240V 60Hz | 051758 | 051767 | 051776 | 051609 | 051634 |
| 230V 50Hz, 240V 60Hz | 051759 | 051768 | 051777 | 051608 | 051633 |
| 380V 50Hz, 440V 60Hz | 051760 | 051769 | 051778 | 051607 | 051632 |
| 400V 50Hz, 440V 60Hz | 051761 | 051770 | 051779 | 051606 | 051631 |
| 415V 50Hz, 480V 60Hz | 051762 | 051771 | 051780 | 051605 | 051630 |
| 24V 50/60Hz | 021924 | 021594 | 021704 | 051596 | 051621 |
| 42V 50/60Hz | 033459 | 029869 | 029433 | 051595 | 051620 |
| 110V 50/60Hz | 021961 | 021624 | 021871 | 051592 | 051618 |
| 230V 50/60Hz | 052725 | 052509 | 052508 | 056674 | 058771 |

DILER, DILEEM

| DC | DILER-40-G(...) | DILER-31-G(...) | DILER-22-G(...) | DILEEM-10-G(...) | DILEEM-01-G(...) |
|--------------------------|---------------------------|---------------------------|---------------------------|---------------------------|---------------------------|
| | Article no. ¹⁾ | Article no. ¹⁾ | Article no. ¹⁾ | Article no. ¹⁾ | Article no. ¹⁾ |
| Standard voltages | See price list | See price list | See price list | See price list | See price list |
| 12V DC | 079711 | 079761 | 080728 | 051644 | 051649 |
| 24V DC | 010223 | 010157 | 010042 | 051643 | 051650 |
| 48V DC | 010255 | 010205 | 010346 | 051642 | 051648 |
| 110V DC | 010287 | 010253 | 010043 | 051640 | 051646 |
| 220V DC | 010303 | 010269 | 010091 | 051639 | 051645 |

Notes

¹⁾ To obtain the article number for ordering, read under selected part number and actuating voltage from the table.
Devices with dual-voltage coils are to be ordered under a single article number.

DILEM

| AC | DILEM-10(...) | DILEM-01(...) | DILEM12-10(...) | DILEM12-01(...) | DILEM4(...) |
|---------------------------------|---------------------------|---------------------------|---------------------------|---------------------------|---------------------------|
| | Article no. ¹⁾ | Article no. ¹⁾ | Article no. ¹⁾ | Article no. ¹⁾ | Article no. ¹⁾ |
| Standard voltages | See price list | See price list | See price list | See price list | See price list |
| 24V 50Hz | 010005 | 010086 | 127067 | 127083 | 014754 |
| 48V 50Hz | 010020 | 010294 | – | – | – |
| 240V 50Hz | 010032 | 010151 | – | – | 014305 |
| 115V 60Hz | 010024 | 010470 | – | – | – |
| 42V 50Hz, 48V 60Hz | 051782 | 051791 | – | – | – |
| 110V 50Hz, 120V 60Hz | 051783 | 051792 | 127072 | 127088 | 051801 |
| 190V 50Hz, 220V 60Hz | 051784 | 051793 | – | – | – |
| 220V 50Hz, 240V 60Hz | 051785 | 051794 | – | – | 051803 |
| 230V 50Hz, 240V 60Hz | 051786 | 051795 | – | – | 051804 |
| 380V 50Hz, 440V 60Hz | 051787 | 051796 | – | – | – |
| 400V 50Hz, 440V 60Hz | 051788 | 051797 | – | – | 051806 |
| 415V 50Hz, 480V 60Hz | 051789 | – | – | – | – |
| 24V 50/60Hz | 021417 | 020402 | 127079 | 127095 | 022044 |
| 42V 50/60Hz | 032174 | 033233 | – | – | – |
| 110V 50/60Hz | 021455 | 020436 | 127081 | 127097 | – |
| 230V 50/60Hz | 052302 | 051114 | 127082 | 127098 | 052506 |

DILEM

| DC | DILEM-10-G(...) | DILEM-01-G(...) | DILEM12-10-G(...) | DILEM12-01-G(...) | DILEM4-G(...) |
|--------------------------|---------------------------|---------------------------|---------------------------|---------------------------|---------------------------|
| | Article no. ¹⁾ | Article no. ¹⁾ | Article no. ¹⁾ | Article no. ¹⁾ | Article no. ¹⁾ |
| Standard voltages | See price list | See price list | See price list | See price list | See price list |
| 12V DC | 079594 | 079642 | – | – | 079680 |
| 24V DC | 010213 | 010343 | 127132 | 127137 | 012701 |
| 48V DC | 010245 | 010496 | – | – | – |
| 110V DC | 010309 | 010136 | – | – | – |
| 220V DC | 010325 | 010168 | – | – | – |

Notes

¹⁾ To obtain the article number for ordering, read under selected part number and actuating voltage from the table. Devices with **dual-voltage coils** are to be ordered under a **single** article number.

1.1

Contactor relays

Actuating voltages

1

DILA

AC

| | With screw terminals | | | With Spring-loaded terminals | | |
|---|---------------------------|---------------------------|---------------------------|------------------------------|---------------------------|---------------------------|
| | DILA-40(...) | DILA-31(...) | DILA-22(...) | DILAC-40(...) | DILAC-31(...) | DILAC-22(...) |
| | Article no. ¹⁾ | Article no. ¹⁾ | Article no. ¹⁾ | Article no. ¹⁾ | Article no. ¹⁾ | Article no. ¹⁾ |
| Standard voltages | See price list | See price list | See price list | See price list | See price list | See price list |
| 24V 50Hz | 276316 | 276351 | 276386 | 276431 | 276463 | 276495 |
| 240V 50Hz | 276318 | 276353 | 276388 | – | – | – |
| 110V 50Hz 120V 60Hz | 276326 | 276361 | 276396 | 276438 | 276470 | 276502 |
| 190V 50Hz 220V 60Hz | 276327 | 276362 | 276397 | – | – | – |
| 220V 50Hz 240V 60Hz | 276328 | 276363 | 276398 | – | – | – |
| 230V 50Hz 240V 60Hz | 276329 | 276364 | 276399 | 276441 | 276473 | 276505 |
| 380V 50Hz 440V 60Hz | 276330 | 276365 | 276400 | – | – | – |
| 400V 50Hz 440V 60Hz | 276331 | 276366 | 276401 | – | – | – |
| 24V 50Hz/60Hz | 276333 | 276368 | 276403 | 276445 | 276477 | 276509 |
| 42V 50Hz/60Hz | 276334 | 276369 | 276404 | – | – | – |
| 110V 50Hz/60Hz | 276335 | 276370 | 276405 | – | – | – |
| 220V 50Hz/60Hz | 276336 | 276371 | 276406 | – | – | – |
| 230V 50Hz/60Hz | 276337 | 276372 | 276407 | 276449 | 276481 | 276513 |
| Special voltages other than the already shown normal voltages ²⁾ | See price list | See price list | See price list | See price list | See price list | See price list |
| ...V 50Hz(12-500V)³⁾ | 276341 | 276376 | 276411 | 276453 | 276485 | 276517 |
| ...V 60Hz(12-600V)³⁾ | 276342 | 276377 | 276412 | 276454 | 276486 | 276518 |

DILA

DC

| | With screw terminals | | | With Spring-loaded terminals | | |
|---|---------------------------|---------------------------|---------------------------|------------------------------|---------------------------|---------------------------|
| | DILA-40(...) | DILA-31(...) | DILA-22(...) | DILAC-40(...) | DILAC-31(...) | DILAC-22(...) |
| | Article no. ¹⁾ | Article no. ¹⁾ | Article no. ¹⁾ | Article no. ¹⁾ | Article no. ¹⁾ | Article no. ¹⁾ |
| Standard voltages | See price list | See price list | See price list | See price list | See price list | See price list |
| 24V DC | 276344 | 276379 | 276414 | 276456 | 276488 | 276520 |
| 48V DC | 276345 | 276380 | 276415 | – | – | – |
| 110V DC | 276347 | 276382 | 276417 | 276459 | 276491 | 276523 |
| 220V DC | 276348 | 276383 | 276418 | 276460 | 276492 | 276524 |
| Special voltages other than the already shown normal voltages ²⁾ | See price list | See price list | See price list | See price list | See price list | See price list |
| ...V DC(12-250V)³⁾ | 276349 | 276384 | 276419 | 276461 | 276493 | 276525 |

Notes

¹⁾ The article number is a combination of part no. and operating voltage devices with dual-voltage coils can be ordered under a single article no.

²⁾ With non-standard voltages the required actuating voltage from the defined range (...-...V) must be stated.

³⁾ Minimum order quantity 10 units

DILM

| AC | DILM7-10 (...) | DILM7-01 (...) | DILM9-10 (...) | DILM9-01 (...) | DILM12-10 (...) | DILM12-01 (...) | DILM15-10 (...) | DILM15-01 (...) |
|---|---------------------------|---------------------------|---------------------------|---------------------------|---------------------------|---------------------------|---------------------------|---------------------------|
| | Article no. ¹⁾ | Article no. ¹⁾ | Article no. ¹⁾ | Article no. ¹⁾ | Article no. ¹⁾ | Article no. ¹⁾ | Article no. ¹⁾ | Article no. ¹⁾ |
| Standard voltages | See price list | See price list | See price list | See price list | See price list | See price list | See price list | See price list |
| 24V 50Hz | 276537 | 276572 | 276677 | 276712 | 276817 | 276852 | 290045 | 290080 |
| 240V 50Hz | 276539 | 276574 | 276679 | 276714 | 276819 | 276854 | – | – |
| 42V 50Hz | 276546 | – | 276686 | – | 276826 | – | – | – |
| 48V 60Hz | | | | | | | | |
| 110V 50Hz | 276547 | 276582 | 276687 | 276722 | 276827 | 276862 | 290055 | 290090 |
| 120V 60Hz | | | | | | | | |
| 190V 50Hz | 276548 | 276583 | 276688 | 276723 | 276828 | 276863 | – | – |
| 220V 60Hz | | | | | | | | |
| 220V 50Hz | 276549 | 276584 | 276689 | 276724 | 276829 | 276864 | – | – |
| 240V 60Hz | | | | | | | | |
| 230V 50Hz | 276550 | 276585 | 276690 | 276725 | 276830 | 276865 | 290058 | 290093 |
| 240V 60Hz | | | | | | | | |
| 380V 50Hz | 276551 | 276586 | 276691 | 276726 | 276831 | 276866 | – | – |
| 440V 60Hz | | | | | | | | |
| 400V 50Hz | 276552 | 276587 | 276692 | 276727 | 276832 | 276867 | – | – |
| 440V 60Hz | | | | | | | | |
| 415V 50Hz | 276553 | – | 276693 | – | 276833 | – | – | – |
| 480V 60Hz | | | | | | | | |
| 24V 50Hz/60Hz | 276554 | 276589 | 276694 | 276729 | 276834 | 276869 | 290062 | 290097 |
| 42V 50Hz/60Hz | 276555 | 276590 | 276695 | 276730 | 276835 | 276870 | – | – |
| 110V 50Hz/60Hz | 276556 | 276591 | 276696 | 276731 | 276836 | 276871 | – | – |
| 220V 50Hz/60Hz | 276557 | 276592 | 276697 | 276732 | 276837 | 276872 | – | – |
| 230V 50Hz/60Hz | 276558 | 276593 | 276698 | 276733 | 276838 | 276873 | 290066 | 290101 |
| Special voltages other than the already shown normal voltages ²⁾ | See price list | See price list | See price list | See price list | See price list | See price list | See price list | See price list |
| ...V 50Hz (12 – 600V)³⁾ | 276562 | 276597 | 276702 | 276737 | 276842 | 276877 | 290070 | 290105 |
| ...V 60Hz (12 – 600V)³⁾ | 276563 | 276598 | 276703 | 276738 | 276843 | 276878 | 290071 | 290106 |

DILM

| DC | DILM7-10 (...) | DILM7-01 (...) | DILM9-10 (...) | DILM9-01 (...) | DILM12-10 (...) | DILM12-01 (...) | DILM15-10 (...) | DILM15-01 (...) |
|---|---------------------------|---------------------------|---------------------------|---------------------------|---------------------------|---------------------------|---------------------------|---------------------------|
| | Article no. ¹⁾ | Article no. ¹⁾ | Article no. ¹⁾ | Article no. ¹⁾ | Article no. ¹⁾ | Article no. ¹⁾ | Article no. ¹⁾ | Article no. ¹⁾ |
| Standard voltages | See price list | See price list | See price list | See price list | See price list | See price list | See price list | See price list |
| 24V DC | 276565 | 276600 | 276705 | 276740 | 276845 | 276880 | 290073 | 290108 |
| 48V DC | 276566 | 276601 | 276706 | 276741 | 276846 | 276881 | – | – |
| 110V DC | 276568 | 276603 | 276708 | 276743 | 276848 | 276883 | – | – |
| 220V DC | 276569 | 276604 | 276709 | 276744 | 276849 | 276884 | – | – |
| Special voltages other than the already shown normal voltages ²⁾ | See price list | See price list | See price list | See price list | See price list | See price list | See price list | See price list |
| ...V DC (12-250V)³⁾ | 276570 | 276605 | 276710 | 276745 | 276850 | 276885 | 290078 | 290113 |

Notes

- ¹⁾ To obtain the article number for ordering, read under selected part number and actuating voltage from the table. devices with dual-voltage coils can be ordered under a single article no.
- ²⁾ With non-standard voltages the required actuating voltage from the defined range (...–...V) must be stated.
- ³⁾ Minimum order quantity 10 units

1 DILM

| AC | DILM17-10 (...) | DILM17-01 (...) | DILM25-10 (...) | DILM25-01 (...) | DILM32-10 (...) | DILM32-01 (...) | DILM38-10(...) (...) | DILM38-01(...) (...) |
|---|---------------------------|---------------------------|---------------------------|---------------------------|---------------------------|---------------------------|---------------------------|---------------------------|
| | Article no. ¹⁾ | Article no. ¹⁾ | Article no. ¹⁾ | Article no. ¹⁾ | Article no. ¹⁾ | Article no. ¹⁾ | Article no. ¹⁾ | Article no. ¹⁾ |
| Standard voltages | See price list | See price list | See price list | See price list | See price list | See price list | See price list | See price list |
| 24V 50Hz | 276991 | 277023 | 277119 | 277151 | 277247 | 277279 | 112378 | 112446 |
| 240V 50Hz | 276993 | – | 277121 | – | 277249 | – | 112420 | – |
| 42V 50Hz | 277000 | – | 277128 | – | 277256 | – | 112424 | – |
| 48V 60Hz | | | | | | | | |
| 110V 50Hz | 277001 | 277033 | 277129 | 277161 | 277257 | 277289 | 112425 | 112454 |
| 120V 60Hz | | | | | | | | |
| 190V 50Hz | 277002 | – | 277130 | – | 277258 | – | 112426 | – |
| 220V 60Hz | | | | | | | | |
| 220V 50Hz | 277003 | – | 277131 | – | 277259 | – | 112427 | – |
| 240V 60Hz | | | | | | | | |
| 230V 50Hz | 277004 | 277036 | 277132 | 277164 | 277260 | 277292 | 112428 | 112457 |
| 240V 60Hz | | | | | | | | |
| 380V 50Hz | 277005 | – | 277133 | – | 277261 | – | 112429 | – |
| 440V 60Hz | | | | | | | | |
| 400V 50Hz | 277006 | 277038 | 277134 | 277166 | 277262 | 277294 | 112430 | 112459 |
| 440V 60Hz | | | | | | | | |
| 415V 50Hz | 277007 | – | 277135 | – | 277263 | – | 112431 | – |
| 480V 60Hz | | | | | | | | |
| 24V 50Hz/60Hz | 277008 | 277040 | 277136 | 277168 | 277264 | 277296 | 112432 | 112461 |
| 42V 50Hz/60Hz | 277009 | – | 277137 | – | 277265 | – | 112433 | – |
| 110V 50Hz/60Hz | 277010 | 277042 | 277138 | 277170 | 277266 | 277298 | 112434 | 112463 |
| 220V 50Hz/60Hz | 277011 | 277043 | 277139 | 277171 | 277267 | 277299 | 112435 | 112464 |
| 230V 50Hz/60Hz | 277012 | 277044 | 277140 | 277172 | 277268 | 277300 | 112436 | 112465 |
| Special voltages other than the already shown normal voltages ²⁾ | See price list | See price list | See price list | See price list | See price list | See price list | See price list | See price list |
| ...V 50Hz (24 – 600V) | 277016 ⁷⁾ | 277048 ⁷⁾ | 277144 ⁷⁾ | 277176 ⁷⁾ | 277272 ⁷⁾ | 277304 ⁸⁾ | 112440 ⁷⁾ | 112468 ⁷⁾ |
| ...V 60Hz (24 – 600V) | 277017 ⁷⁾ | 277049 ⁷⁾ | 277145 ⁷⁾ | 277177 ⁷⁾ | 277273 ⁷⁾ | 277305 ⁸⁾ | 112441 ⁷⁾ | 112469 ⁷⁾ |

DILM

| DC | DILM17-10(...) | DILM17-01(...) | DILM25-10(...) | DILM25-01(...) | DILM32-10(...) | DILM32-01(...) | DILM38-10(...) | DILM38-01(...) |
|-----------------------------|---------------------------|---------------------------|---------------------------|---------------------------|---------------------------|---------------------------|---------------------------|---------------------------|
| | Article no. ¹⁾ | Article no. ¹⁾ | Article no. ¹⁾ | Article no. ¹⁾ | Article no. ¹⁾ | Article no. ¹⁾ | Article no. ¹⁾ | Article no. ¹⁾ |
| Standard voltages | See price list | See price list | See price list | See price list | See price list | See price list | See price list | See price list |
| RDC 24³⁾ | 277018 | 277050 | 277146 | 277178 | 277274 | 277306 | 112442 | 112470 |
| RDC 60⁴⁾ | 277019 | 277051 | 277147 | 277179 | 277275 | 277307 | 112443 | 112471 |
| RDC 130⁵⁾ | 277020 | 277052 | 277148 | 277180 | 277276 | 277308 | 112444 | 112472 |
| RDC 240⁶⁾ | 277021 | 277053 | 277149 | 277181 | 277277 | 277309 | 112445 | 112473 |

Notes

- ¹⁾ To obtain the article number for ordering, read under selected part number and actuating voltage from the table. devices with dual-voltage coils can be ordered under a single article no.
- ²⁾ With non-standard voltages the required actuating voltage from the defined range (...–...V) must be stated.
- ³⁾ 24 – 27 V DC
- ⁴⁾ 48 – 60 V DC
- ⁵⁾ 110 – 130 V DC
- ⁶⁾ 200 – 240 V DC
- ⁷⁾ Minimum order quantity 10 units
- ⁸⁾ Minimum order quantity 5 units

DILM

| AC | DILM40(...) | DILM50(...) | DILM65(...) | DILM72(...) |
|---|---------------------------|---------------------------|---------------------------|---------------------------|
| | Article no. ¹⁾ | Article no. ¹⁾ | Article no. ¹⁾ | Article no. ¹⁾ |
| Standard voltages | See price list | See price list | See price list | See price list |
| 24V 50Hz | 277753 | 277817 | 277881 | – |
| 240V 50Hz | 277755 | 277819 | 277883 | 109183 |
| 42V 50Hz 48V 60Hz | 277762 | 277826 | 277890 | – |
| 110V 50Hz 120V 60Hz | 277763 | 277827 | 277891 | 109191 |
| 190V 50Hz 220V 60Hz | 277764 | 277828 | 277892 | – |
| 220V 50Hz 240V 60Hz | 277765 | 277829 | 277893 | – |
| 230V 50Hz 240V 60Hz | 277766 | 277830 | 277894 | 107670 |
| 380V 50Hz 440V 60Hz | 277767 | 277831 | 277895 | – |
| 400V 50Hz 440V 60Hz | 277768 | 277832 | 277896 | 109195 |
| 415V 50Hz 480V 60Hz | 277769 | 277833 | 277897 | – |
| 24V 50Hz/60Hz | 277770 | 277834 | 277898 | 109197 |
| 42V 50Hz/60Hz | 277771 | 277835 | 277899 | – |
| 110V 50Hz/60Hz | 277772 | 277836 | 277900 | 109199 |
| 220V 50Hz/60Hz | 277773 | 277837 | 277901 | 109200 |
| 230V 50Hz/60Hz | 277774 | 277838 | 277902 | 109201 |
| Special voltages other than the already shown normal voltages ²⁾ | See price list | See price list | See price list | See price list |
| ...V 50Hz (24 – 600V) | 277778 ⁸⁾ | 277842 ⁸⁾ | 277906 ⁸⁾ | 109205 ⁷⁾ |
| ...V 60Hz (24 – 600V) | 277779 ⁸⁾ | 277843 ⁸⁾ | 277907 ⁸⁾ | 109206 ⁷⁾ |

DILM

| DC | DILM40(...) | DILM50(...) | DILM65(...) | DILM72(...) |
|-----------------------------|---------------------------|---------------------------|---------------------------|---------------------------|
| | Article no. ¹⁾ | Article no. ¹⁾ | Article no. ¹⁾ | Article no. ¹⁾ |
| Standard voltages | See price list | See price list | See price list | See price list |
| RDC 24³⁾ | 277780 | 277844 | 277908 | 107671 |
| RDC 60⁴⁾ | 277781 | 277845 | 277909 | – |
| RDC 130⁵⁾ | 277782 | 277846 | 277910 | – |
| RDC 240⁶⁾ | 277783 | 277847 | 277911 | 109209 |

Notes

- ¹⁾ To obtain the article number for ordering, read under selected part number and actuating voltage from the table.
devices with dual-voltage coils can be ordered under a single article no.
- ²⁾ With non-standard voltages the required actuating voltage from the defined range (...–...V) must be stated.
- ³⁾ 24 – 27 V DC
- ⁴⁾ 48 – 60 V DC
- ⁵⁾ 110 – 130 V DC
- ⁶⁾ 200 – 240 V DC
- ⁷⁾ Minimum order quantity 10 units

1.1

Contactors Actuating voltages

1 DILM

| AC | DILM80 (...) | DILM95 (...) |
|---|---|---|
| | Article no. ¹⁾ See price list | Article no. ¹⁾ See price list |
| Standard voltages | | |
| 24 V 50 Hz | 235904 | 239467 |
| 240V 50Hz | 235910 | 239469 |
| 42V 50Hz 48V 60Hz | 239394 | 239476 |
| 110V 50Hz 120V 60Hz | 239399 | 239477 |
| 190V 50Hz 220V 60Hz | 239400 | 239478 |
| 220V 50Hz 240V 60Hz | 239401 | 239479 |
| 230V 50Hz 240V 60Hz | 239402 | 239480 |
| 380V 50Hz 440V 60Hz | 239403 | 239481 |
| 400V 50Hz 440V 60Hz | 239404 | 239482 |
| 415V 50Hz 480V 60Hz | 239405 | 239483 |
| 24V 50Hz/60Hz | 239406 | 239484 |
| 42V 50Hz/60Hz | 239407 | 239485 |
| 110V 50Hz/60Hz | 239408 | 239486 |
| 220V 50Hz/60Hz | 239409 | 239487 |
| 230V 50Hz/60Hz | 239410 | 239488 |
| Special voltages other than the already shown normal voltages ²⁾ | See price list | list |
| ...V 50Hz (24 – 600V) ¹³⁾ | 239414 | 239504 |
| ...V 60Hz (24 – 600V) ¹³⁾ | 239415 | 239509 |

DILM

| DC | DILM80 (...) | DILM95 (...) |
|-----------------------------|---|---|
| | Article no. ¹⁾ See price list | Article no. ¹⁾ See price list |
| Standard voltages | | |
| RDC 24³⁾ | 239416 | 239510 |
| RDC 60⁴⁾ | 239417 | 239511 |
| RDC 130⁵⁾ | 239418 | 239512 |
| RDC 240⁶⁾ | 239419 | 239513 |

DILM

| AC | DILM115 (...) | DILM150 (...) | DILM170 (...) | DILM185A/ 22(...) | DILM225A/ 22(...) |
|------------------------------|---|---|---|---|---|
| | Article no. ¹⁾ See price list | Article no. ¹⁾ See price list | Article no. ¹⁾ See price list | Article no. ¹⁾ See price list | Article no. ¹⁾ See price list |
| Standard voltages | | | | | |
| RAC 24⁷⁾ | 239545 | 239585 | 107010 | 139534 | 139544 |
| RAC 48⁸⁾ | 239546 | 239586 | 107011 | 139535 | 139545 |
| RAC 120⁹⁾ | 239547 | 239587 | 107012 | 139536 | 139546 |
| RAC 240¹⁰⁾ | 239548 | 239588 | 107013 | 139537 | 139547 |
| RAC 440¹¹⁾ | 239549 | 239589 | 107014 | 139538 | 139548 |
| RAC 500¹²⁾ | 239550 | 239590 | 107015 | 139539 | 139549 |

DILM

| DC | DILM115 (...) | DILM150 (...) | DILM170 (...) | DILM185A/ 22(...) | DILM225A/ 22(...) |
|-----------------------------|---|---|---|---|---|
| | Article no. ¹⁾ See price list | Article no. ¹⁾ See price list | Article no. ¹⁾ See price list | Article no. ¹⁾ See price list | Article no. ¹⁾ See price list |
| Standard voltages | | | | | |
| RDC 24³⁾ | 239555 | 239591 | 107016 | 139540 | 139550 |
| RDC 60⁴⁾ | 239560 | 239592 | 107017 | 139541 | 139551 |
| RDC 130⁵⁾ | 239567 | 239593 | 107018 | 139542 | 139552 |
| RDC 240⁶⁾ | 239572 | 239594 | 107019 | 139543 | 139553 |

Notes

- ¹⁾ The article no. results from combining the part no. and the actuating voltage. Devices with dual-voltage coils must be ordered under a single article no.
- ²⁾ With non-standard voltages the required actuating voltage from the defined range (...-...V) must be stated.
- ³⁾ 24 - 27 V DC
- ⁴⁾ 48 – 60 V DC
- ⁵⁾ 110 - 130 V DC
- ⁶⁾ 200 - 240 V DC
- ⁷⁾ 24 V 50/60 Hz
- ⁸⁾ 42 – 48 V 50/60 Hz
- ⁹⁾ 100 – 120 V 50/60 Hz
- ¹⁰⁾ 190 – 240 V 50/60 Hz
- ¹¹⁾ 380 – 440 V 50/60 Hz
- ¹²⁾ 480 – 500 V 50/60 Hz
- ¹³⁾ Minimum order quantity 5 units

DILM

| AC | DILMC7-10 (...) | DILMC7-01 (...) | DILMC9-10 (...) | DILMC9-01 (...) | DILMC12-10 (...) | DILMC12-01 (...) | DILMC15-10 (...) | DILMC15-01 (...) |
|---|---------------------------|---------------------------|---------------------------|---------------------------|---------------------------|---------------------------|---------------------------|---------------------------|
| | Article no. ¹⁾ | Article no. ¹⁾ | Article no. ¹⁾ | Article no. ¹⁾ | Article no. ¹⁾ | Article no. ¹⁾ | Article no. ¹⁾ | Article no. ¹⁾ |
| Standard voltages | See price list | See price list | See price list | See price list | See price list | See price list | See price list | See price list |
| 24 V 50 Hz | 277379 | 277411 | 277443 | 277475 | 277507 | 277539 | 293938 | 293933 |
| 110V 50Hz | 277386 | 277418 | 277450 | 277482 | 277514 | 277546 | 293908 | 293943 |
| 120V 60Hz | | | | | | | | |
| 230V 50Hz | 277389 | 277421 | 277453 | 277485 | 277517 | 277549 | 293911 | 293946 |
| 240V 60Hz | | | | | | | | |
| 24V 50Hz/60Hz | 277393 | 277425 | 277457 | 277489 | 277521 | 277553 | 293915 | 293950 |
| 230V 50Hz/60Hz | 277397 | 277429 | 277461 | 277493 | 277525 | 277557 | 293919 | 293954 |
| Special voltages other than the already shown normal voltages ²⁾ | See price list | See price list | See price list | See price list | See price list | See price list | See price list | See price list |
| ...V 50Hz (12 – 600V)⁶⁾ | 277401 | 277433 | 277465 | 277497 | 277529 | 277561 | 293923 | 293958 |
| ...V 60Hz (12 – 600V)⁶⁾ | 277402 | 277434 | 277466 | 277498 | 277530 | 277562 | 293924 | 293959 |

DILM

| DC | DILMC7-10 (...) | DILMC7-01 (...) | DILMC9-10 (...) | DILMC9-01 (...) | DILMC12-10 (...) | DILMC12-01 (...) | DILMC15-10 (...) | DILMC15-01 (...) |
|---|---------------------------|---------------------------|---------------------------|---------------------------|---------------------------|---------------------------|---------------------------|---------------------------|
| | Article no. ¹⁾ | Article no. ¹⁾ | Article no. ¹⁾ | Article no. ¹⁾ | Article no. ¹⁾ | Article no. ¹⁾ | Article no. ¹⁾ | Article no. ¹⁾ |
| Standard voltages | See price list | See price list | See price list | See price list | See price list | See price list | See price list | See price list |
| 24V DC | 277404 | 277436 | 277468 | 277500 | 277532 | 277564 | 293926 | 293961 |
| 110V DC | 277407 | 277439 | 277471 | 277503 | 277535 | 277567 | 293929 | 293964 |
| 220V DC | 277408 | 277440 | 277472 | 277504 | 277536 | 277568 | 293930 | 293965 |
| Special voltages other than the already shown normal voltages ²⁾ | See price list | See price list | See price list | See price list | See price list | See price list | See price list | See price list |
| ...VDC (12 – 250V)⁶⁾ | 277409 | 277441 | 277473 | 277505 | 277537 | 277569 | 293931 | 293966 |

DILM

| AC | DILMC17-10 (...) | DILMC17-01(...) | DILMC25-10 (...) | DILMC25-01 (...) | DILMC32-10 (...) | DILMC32-01 (...) |
|---|---------------------------|---------------------------|---------------------------|---------------------------|---------------------------|---------------------------|
| | Article no. ¹⁾ | Article no. ¹⁾ | Article no. ¹⁾ | Article no. ¹⁾ | Article no. ¹⁾ | Article no. ¹⁾ |
| Standard voltages | See price list | See price list | See price list | See price list | See price list | See price list |
| 24 V 50 Hz | 277570 | 277600 | 277630 | 277660 | 277690 | 277720 |
| 110V 50Hz | 277578 | 277608 | 277638 | 277668 | 277698 | 277728 |
| 120V 60Hz | | | | | | |
| 230V 50Hz | 277581 | 277611 | 277641 | 277671 | 277701 | 277731 |
| 240V 60Hz | | | | | | |
| 24V 50Hz/60Hz | 277585 | 277615 | 277645 | 277675 | 277705 | 277735 |
| 220V 50Hz/60Hz | 277588 | 277618 | 277648 | 277678 | 277708 | 277738 |
| 230V 50Hz/60Hz | 277589 | 277619 | 277649 | 277679 | 277709 | 277739 |
| Special voltages other than the already shown normal voltages ²⁾ | See price list | See price list | See price list | See price list | See price list | See price list |
| ...V 50Hz (24 – 600V)⁶⁾ | 277593 | 277623 | 277653 | 277683 | 277713 | 277743 |
| ...V 60Hz (24 – 600V)⁶⁾ | 277594 | 277624 | 277654 | 277684 | 277714 | 277744 |

DILM

| DC | DILMC17-10 (...) | DILMC17-01 (...) | DILMC25-10 (...) | DILMC25-01 (...) | DILMC32-10 (...) | DILMC32-01 (...) |
|-----------------------------|---------------------------|---------------------------|---------------------------|---------------------------|---------------------------|---------------------------|
| | Article no. ¹⁾ | Article no. ¹⁾ | Article no. ¹⁾ | Article no. ¹⁾ | Article no. ¹⁾ | Article no. ¹⁾ |
| Standard voltages | See price list | See price list | See price list | See price list | See price list | See price list |
| RDC 24³⁾ | 277595 | 277625 | 277655 | 277685 | 277715 | 277745 |
| RDC 130⁴⁾ | 277597 | 277627 | 277657 | 277687 | 277717 | 277747 |
| RDC 240⁵⁾ | 277598 | 277628 | 277658 | 277688 | 277718 | 277748 |

Notes

- ¹⁾ The article no. results from combining the part no. and the actuating voltage. Devices with dual-voltage coils must be ordered under a single article no.
- ²⁾ With non-standard voltages the required actuating voltage from the defined range (...-...V) must be stated.
- ³⁾ 24 - 27 V DC
- ⁴⁾ 110 - 130 V DC
- ⁵⁾ 200 - 240 V DC
- ⁶⁾ Minimum order quantity 10 units

1.1

Contactors Actuating voltages

1 DILMP20

| AC | DILMP20 (...) | AC | DILMP20 (...) | AC | DILMP20 (...) |
|--------------------------|---------------------------|-----------------------------|---------------------------|---|---------------------------|
| | Article no. ¹⁾ | | Article no. ¹⁾ | | Article no. ¹⁾ |
| Standard voltages | See price list | Standard voltages | See price list | Non-standard voltages²⁾ | See price list |
| 240V 50Hz | – | RAC 24⁴⁾ | – | ...V 50Hz (12 – 600V)³⁾ | 276982 |
| 110V 50Hz | 276967 | RAC 120⁵⁾ | – | ...V 60Hz (12 – 600V)³⁾ | 276983 |
| 120V 60Hz | – | RAC 240⁶⁾ | – | | |
| 230 V 50Hz | 276970 | | | | |
| 240V 60Hz | – | | | | |
| 24V 50/60Hz | 276974 | | | | |
| 230V 50/60Hz | 276978 | | | | |

DILMP20

| DC | DILMP20 (...) | DC | DILMP20 (...) |
|----------------------------|---------------------------|---|---------------------------|
| | Article no. ¹⁾ | | Article no. ¹⁾ |
| Standard voltages | See price list | Non-standard voltages²⁾ | See price list |
| 24V DC | 276985 | ...V DC (12 – 250V)³⁾ | 276990 |
| RDC 24⁷⁾ | – | | |

Notes

- 1) The article number is a combination of part no. and actuating voltage
- 2) For non-standard voltages, state the actuating voltage selected from the range (... – ...V) shown.
- 3) Minimum order quantity: 10 units
- 4) 24 V 50/60 Hz
- 5) 100 – 120 V 50/60 Hz
- 6) 190 – 240 V 50/60 Hz
- 7) 24 – 27 V DC

DILM...XSP...

| AC | DILM32-XSP (...) | DILM65-XSP (...) | DILM95- XSP |
|---|---------------------------|---------------------------|---------------------------|
| | Article no. ¹⁾ | Article no. ¹⁾ | Article no. ¹⁾ |
| Standard voltages | See price list | See price list | See price list |
| 24V 50Hz | 281130 | 281160 | 229984 |
| 240V 50Hz | 281132 | 281162 | 229986 |
| 24V 60Hz | 281134 | 281164 | 229988 |
| 115V 60Hz | 281136 | 281166 | 229990 |
| 42V 50Hz 48V 60Hz | 281137 | 281167 | 229994 |
| 110V 50Hz 120V 60Hz | 281138 | 281168 | 230058 |
| 190V 50Hz 220V 60Hz | 281139 | 281169 | 230059 |
| 220V 50Hz 240V 60Hz | 281140 | 281170 | 230061 |
| 230V 50Hz 240V 60Hz | 281141 | 281171 | 230062 |
| 380V 50Hz 440V 60Hz | 281142 | 281172 | 230063 |
| 400V 50Hz 440V 60Hz | 281143 | 281173 | 230064 |
| 415V 50Hz 480V 60Hz | 281144 | 281174 | 230065 |
| 24V 50Hz/60Hz | 281145 | 281175 | 230066 |
| 42V 50Hz/60Hz | 281146 | 281176 | 230067 |
| 110V 50Hz/60Hz | 281147 | 281177 | 230068 |
| 220V 50Hz/60Hz | 281148 | 281178 | 230073 |
| 230V 50Hz/60Hz | 281149 | 281179 | 230074 |
| Special voltages other than the already shown normal-voltages ²⁾ | See price list | See price list | See price list |
| ...V 50Hz (24 – 600V) | 281153 ¹³⁾ | 281183 ¹⁴⁾ | 230078 ¹⁴⁾ |
| ...V 60Hz (24 – 600V) | 281154 ¹³⁾ | 281184 ¹⁴⁾ | 230079 ¹⁴⁾ |

DILM...XSP...

| DC | DILM32-XSP (...) | DILM65-XSP (...) | DILM95- XSP |
|-----------------------------|---------------------------|---------------------------|---------------------------|
| | Article no. ¹⁾ | Article no. ¹⁾ | Article no. ¹⁾ |
| Standard voltages | See price list | See price list | See price list |
| RDC 24³⁾ | 281155 | 281185 | 230080 |
| RDC 60⁴⁾ | 281156 | 281186 | 230081 |
| RDC 130⁵⁾ | 281157 | 281187 | 230082 |
| RDC 240⁶⁾ | 281158 | 281188 | 230107 |

DILM...XSP...

| AC | DILM150-XSP (...) | DILM225A-XSP (...) |
|------------------------------|---------------------------|---------------------------|
| | Article no. ¹⁾ | Article no. ¹⁾ |
| Standard voltages | See price list | See price list |
| RAC 24⁷⁾ | 230109 | 139562 |
| RAC 48⁸⁾ | 230110 | 139563 |
| RAC 120⁹⁾ | 230111 | 139564 |
| RAC 240¹⁰⁾ | 230112 | 139565 |
| RAC 440¹¹⁾ | 230113 | 139566 |
| RAC 500¹²⁾ | 230114 | 139567 |

DILM...XSP...

| DC | DILM150-XSP (...) | DILM225A-XSP (...) |
|-----------------------------|---------------------------|---------------------------|
| | Article no. ¹⁾ | Article no. ¹⁾ |
| Standard voltages | See price list | See price list |
| RDC 24³⁾ | 230115 | 139568 |
| RDC 60⁴⁾ | 230116 | 139569 |
| RDC 130⁵⁾ | 230117 | 139570 |
| RDC 240⁶⁾ | 230122 | 139571 |

Notes

- 1) To obtain the article number for ordering, read under selected part number and actuating voltage from the table.
Devices with dual-voltage coils are to be ordered under a single article number.
- 2) With non-standard voltages the required actuating voltage from the defined range (...–...V) must be stated.
- 3) 24 – 27 V DC
- 4) 48 – 60 V DC
- 5) 110 – 130 V DC
- 6) 200 – 240 V DC
- 7) 24 V 50/60 Hz
- 8) 42 – 48 V 50/60 Hz
- 9) 100 – 120 V 50/60 Hz
- 10) 190 – 240 V 50/60 Hz
- 11) 380 – 440 V 50/60 Hz
- 12) 480 – 500 V 50/60 Hz
- 13) Minimum order quantity 10 units
- 14) Minimum order quantity 5 units

1.1

Contactor for capacitors, contactor

Actuating voltages

1 DILK, DILMF

| AC | DILK12-11 (...) | DILK20-11 (...) | DILK25-11 (...) | DILK33-10 (...) | DILK50-10 (...) |
|---|---------------------------|---------------------------|---------------------------|---------------------------|---------------------------|
| | Article no. ¹⁾ | Article no. ¹⁾ | Article no. ¹⁾ | Article no. ¹⁾ | Article no. ¹⁾ |
| Standard voltages | See price list | See price list | See price list | See price list | See price list |
| 110V 50Hz, 120V 60Hz | 293985 | 294007 | 294029 | 294051 | 294073 |
| 190V 50Hz, 220V 60Hz | 293986 | 294008 | 294030 | 294052 | 294074 |
| 230V 50Hz, 240V 60Hz | 293988 | 294010 | 294032 | 294054 | 294076 |
| 400V 50Hz, 440V 60Hz | 293990 | 294012 | 294034 | 294056 | 294078 |
| Special voltages other than the already shown normal voltages ²⁾ | See price list | See price list | See price list | | |
| ... V 50Hz (24 – 600V)³⁾ | 293997 | 294019 | 294041 | – | – |
| ... V 60Hz (24 – 600V)³⁾ | 293998 | 294020 | 294042 | – | – |

Notes

- ¹⁾ The article no. results from combining the part no. and the actuating voltage.
Devices with dual-voltage coils must be ordered under a single article no.
- ²⁾ With non-standard voltages the required actuating voltage from the defined range (...–...V) must be stated.
- ³⁾ Minimum order quantity 10 units

DILM

Complete comfort devices

| | DILM250 /22(...) | DILM300A /22(...) | DILM400 /22(...) | DILM500 /22(...) | DILM580 /22(...) | DILM650 /22(...) | DILM750 /22(...) | DILM820 /22(...) | DILM1000 /22(...) |
|--------------------------------|---|---|---|---|---|---|---|---|---|
| Voltage variants | Article no. ¹⁾ See price list | Article no. ¹⁾ See price list | Article no. ¹⁾ See price list | Article no. ¹⁾ See price list | Article no. ¹⁾ See price list | Article no. ¹⁾ See price list | Article no. ¹⁾ See price list | Article no. ¹⁾ See price list | Article no. ¹⁾ See price list |
| RDC 48²⁾ | 208199 | 139554 | 208207 | 208211 | – | – | – | – | – |
| RA 110³⁾ | 208200 | 139555 | 208208 | 208212 | 208215 | 208218 | 208221 | 208224 | – |
| RA 250⁴⁾ | 208201 | 139556 | 208209 | 208213 | 208216 | 208219 | 208222 | 208225 | 267214 |
| RAC 500^{5) 6)} | 208202 | 139557 | 208210 | 208214 | 208217 | 208220 | 208223 | 208226 | – |

DILM

Complete units Standard

| | DILM250 -S/22(...) | DILM300A -S/22(...) | DILM400 -S/22(...) | DILM500 -S/22(...) |
|-------------------------|---|---|---|---|
| Voltage variants | Article no. ¹⁾ See price list | Article no. ¹⁾ See price list | Article no. ¹⁾ See price list | Article no. ¹⁾ See price list |
| 110-120V 50/60Hz | 274189 | 139558 | 274195 | 274198 |
| 220-240V 50/60Hz | 274190 | 139559 | 274196 | 274199 |

DILM

Electronic module, incl. coil, for comfort model

| | DILM250-XSP/E(...) | DILM500-XSP/E(...) | DILM1000-XSP/E(...) |
|--------------------------------|---|---|---|
| Voltage variants | Article no. ¹⁾ See price list | Article no. ¹⁾ See price list | Article no. ¹⁾ See price list |
| RDC 48²⁾ | 208250 | 208254 | – |
| RA 110³⁾ | 208251 | 208255 | 289146 |
| RA 250⁴⁾ | 208252 | 208256 | 289145 |
| RAC 500^{5) 6)} | 208253 | 208257 | 289147 |

DILM

Electronic module, incl. coil, for standard model

| | DILM250-S-XSP/E(...) | DILM500-S-XSP/E(...) |
|-------------------------|---|---|
| Voltage variants | Article no. ¹⁾ See price list | Article no. ¹⁾ See price list |
| 110-120V 50/60Hz | 274201 | 274204 |
| 220-240V 50/60Hz | 274202 | 274205 |

Notes

- ¹⁾ The article no. results from combining the part no. and the voltage variant.
- ²⁾ 24 – 48 V DC
- ³⁾ 48 – 110 V 40 – 60 Hz/48 – 110 V DC
- ⁴⁾ 110 – 250 V 40 – 60 Hz/110 – 250 V DC
- ⁵⁾ 250 – 500 V 40 – 60 Hz
- ⁶⁾ DC on request

1 Engineering

DILM, DILA, DILE, DILH

The diagrams show the closing and opening travel of the contacts at no load.

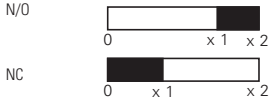

| | | x1 | x2 |
|-------------------------|------------------------|------|------|
| DILE AC | N/O | 1.9 | 2.8 |
| | NC | 0.95 | 2.8 |
| | ...DILE | 1.9 | 2.8 |
| | NC | 0.9 | 2.8 |
| ...DDILE | NO early-make | 1.06 | 2.9 |
| | Late-break N/C contact | 1.86 | 2.9 |
| | N/O | 1.9 | 2.8 |
| | NC | 0.9 | 2.8 |
| DILE DC | N/O | 1.9 | 2.85 |
| | NC | 0.95 | 2.85 |
| DILE... | N/O | 1.9 | 2.8 |
| | NC | 0.9 | 2.8 |
| ...DDILE | NO early-make | 1.06 | 2.9 |
| | Late-break N/C contact | 1.86 | 2.9 |
| | N/O | 1.9 | 2.8 |
| | NC | 0.9 | 2.8 |
| DILA AC | N/O | 3.3 | 4.5 |
| | NC | 1.0 | 4.5 |
| DILA-XHI | N/O | 3.2 | 4.5 |
| | NC | 1.6 | 4.5 |
| DILA-XHIV | NO early-make | 2.0 | 4.5 |
| | Late-break N/C contact | 2.8 | 4.5 |
| | N/O | 3.2 | 4.5 |
| | NC | 1.6 | 4.5 |
| DILA DC | N/O | 2.1 | 2.9 |
| | NC | 0.7 | 2.9 |
| DILA-XHI | N/O | 2.3 | 2.9 |
| | NC | 0.7 | 2.9 |
| DILA-XHIV | NO early-make | 1.1 | 2.9 |
| | Late-break N/C contact | 1.9 | 2.9 |
| | N/O | 2.3 | 2.9 |
| | NC | 0.7 | 2.9 |
| DILM7/9 AC | N/O | 3.3 | 4.5 |
| | NC | 1.0 | 4.5 |
| DILM32-XHI, DILA-XHI | N/O | 3.2 | 4.5 |
| | NC | 1.6 | 4.5 |
| DILA-XHIV | NO early-make | 2.0 | 4.5 |
| | Late-break N/C contact | 2.8 | 4.5 |
| | N/O | 3.2 | 4.5 |
| | NC | 1.6 | 4.5 |
| DILM7/9 DC | N/O | 2.1 | 2.9 |
| | NC | 0.7 | 2.9 |
| DILM32-XHI, DILA-XHI | N/O | 2.3 | 2.9 |
| | NC | 0.7 | 2.9 |
| DILA-XHIV | NO early-make | 1.1 | 2.9 |
| | Late-break N/C contact | 1.9 | 2.9 |
| | N/O | 2.3 | 2.9 |
| | NC | 0.7 | 2.9 |
| DILM12/15/P20 AC | N/O | 3.3 | 4.5 |
| | NC | 1.0 | 4.5 |
| DILM32-XHI, DILA-XHI | N/O | 3.2 | 4.5 |
| | NC | 1.6 | 4.5 |
| DILA-XHIV | NO early-make | 2.0 | 4.5 |
| | Late-break N/C contact | 2.8 | 4.5 |
| | N/O | 3.2 | 4.5 |
| | NC | 1.6 | 4.5 |
| DILM12/15/P20 DC | N/O | 3.3 | 4.4 |
| | NC | 1.0 | 4.4 |
| DILM32-XHI, DILA-XHI | N/O | 3.2 | 4.4 |
| | NC | 1.6 | 4.4 |

DILM, DILA, DILE, DILH

The diagrams show the closing and opening travel of the contacts at no load.

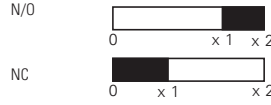

| | | x1 | x2 |
|---|------------------------|------|------|
| DILA-XHIV | NO early-make | 2.0 | 4.4 |
| | Late-break N/C contact | 2.8 | 4.4 |
| | N/O | 3.2 | 4.4 |
| | NC | 1.6 | 4.4 |
| DILM17/25/32/P32/P45 | N/O | 4.0 | 6.0 |
| | Auxiliary N/C | 1.8 | 6.0 |
| DILM32-XHI, DILA-XHI | Auxiliary N/O | 3.2 | 6.0 |
| | N/O | 3.2 | 6.0 |
| DILA-XHIV | NC | 1.6 | 6.0 |
| | NO early-make | 2.0 | 6.0 |
| DILA-XHIV | Late-break N/C contact | 2.8 | 6.0 |
| | N/O | 3.2 | 6.0 |
| DILA-XHIV | NC | 1.6 | 6.0 |
| | NC | 1.6 | 6.0 |
| DILM40/50/65/P63/P80 | N/O | 5.1 | 7.5 |
| | N/O | 5.7 | 7.5 |
| DILM150-XHI | NC | 3.9 | 7.5 |
| | NC | 3.9 | 7.5 |
| DILM150-XHIV | NO early-make | 3.8 | 7.5 |
| | Late-break N/C contact | 5.4 | 7.5 |
| DILM150-XHIV | N/O | 5.7 | 7.5 |
| | NC | 3.9 | 7.5 |
| DILM1000-XHI | N/O | 5.5 | 7.5 |
| | NC | 3.6 | 7.5 |
| DILM1000-XHIV | NO early-make | 4.1 | 7.5 |
| | Late-break N/C contact | 5.0 | 7.5 |
| DILM80/95/115/150/170/P125/P160/P200 | N/O | 8.0 | 11 |
| | N/O | 9.2 | 11 |
| DILM150-XHI | NC | 7.4 | 11 |
| | NC | 7.4 | 11 |
| DILM150-XHIV | NO early-make | 7.3 | 11 |
| | Late-break N/C contact | 8.9 | 11 |
| DILM150-XHIV | N/O | 9.2 | 11 |
| | NC | 7.4 | 11 |
| DILM1000-XHI | N/O | 9.0 | 11 |
| | NC | 7.1 | 11 |
| DILM1000-XHIV | NO early-make | 7.6 | 11 |
| | Late-break N/C contact | 8.5 | 11 |
| DILM185A/225A | N/O | 10.0 | 13.0 |
| | N/O | 10.0 | 13.0 |
| DILM1000-XHI | NC | 8.1 | 13.0 |
| | NC | 8.1 | 13.0 |
| DILM1000-XHIV | NO early-make | 8.4 | 13.0 |
| | Late-break N/C contact | 9.5 | 13.0 |
| DILM250/300A | N/O | 10.1 | 13.1 |
| | N/O | 10.3 | 13.1 |
| DILM820-XHI | NC | 8.4 | 13.1 |
| | NC | 8.4 | 13.1 |
| DILM820-XHIV | NO early-make | 8.7 | 13.1 |
| | Late-break N/C contact | 9.8 | 13.1 |
| DILM400/500/570 | N/O | 8.9 | 13.1 |
| | N/O | 10.3 | 13.1 |
| DILM820-XHI | NC | 8.4 | 13.1 |
| | NC | 8.4 | 13.1 |
| DILM820-XHIV | NO early-make | 8.7 | 13.1 |
| | Late-break N/C contact | 9.8 | 13.1 |
| DILM580/650/750/820 | N/O | 2.0 | 4.1 |
| | N/O | 7.4 | 10.5 |
| DILM820-XHI | NC | 5.5 | 10.5 |
| | NC | 5.5 | 10.5 |
| DILM820-XHIV | NO early-make | 6.0 | 10.5 |
| | Late-break N/C contact | 6.8 | 10.5 |
| DILM1000/1600, DILH1400/2000/2200/2600 | N/O | 2.0 | 4.1 |
| | N/O | 7.4 | 10.5 |
| DILM820-XHI | NC | 5.5 | 10.5 |
| | NC | 5.5 | 10.5 |
| DILM820-XHIV | NO early-make | 6.0 | 10.5 |
| | Late-break N/C contact | 6.8 | 10.5 |

DILE, DILM, SDAINL, DIUL

Components

Contactor selection

| Part no. | With top mounting auxiliary contacts | With side mounting auxiliary contacts | With overload relay | With parallel connector | Insulated enclosures |
|-------------------------|--------------------------------------|---------------------------------------|--|-------------------------|-----------------------------|
| DILE...(-G)(-C) | – | – | – | – | CI-K1-95-TS |
| DILE...(-G)(-C) | ● | – | – | – | CI-K2-145-TS |
| DILE...(-G) | ● | – | ● | – | CI-K2-145-AD |
| DILE...(-G) | – | – | – | ● | CI-K2-100-TS |
| DILE...(-G) | ● | – | – | ● | CI-K2-145-TS |
| DILM7 to DILM15 | ● | – | – | – | CI-K2-145-TS |
| DILM7 to DILM15 | ● | – | ● | – | CI-K3-160-TS |
| DILM17 to DILM32 | – | – | – | – | CI-K2-145-TS |
| DILM17 to DILM32 | ● | – | ● | – | CI23E-150 |
| DILM40 to DILM65 | – | ● | – | – | CI-K3-160-TS |
| DILM40 to DILM65 | ● | ● | ● | – | CI43E-150 |
| DILM80 to DILM170 | ● | ● | – | – | CI43E-200 |
| DILM80 to DILM170 | ● | ● | ● | – | CI44E-200 |
| DILM185A | – | ● | – | – | CI48-250 |
| DILM225A | – | ● | – | – | CI48-250 |
| DILM250 | – | ● | – | – | CI48-250 |
| DILM300A | – | ● | – | – | CI48-250 |
| DILM400 | – | ● | – | – | CI48-250 |
| DILM500 | – | ● | – | – | CI48-250 |
| DILM580 | – | ● | – | – | CI48-250 |
| DILM650 | – | ● | – | – | CI48-250 |
| DILM750 | – | ● | – | – | CI48-250 |
| DILM820 | – | ● | – | – | CI48-250 |
| DIULE... | ● | – | – | – | CI-K3-125-TS |
| DIULE... | ● | – | ● | – | CI-K3-125-TS |
| DIULM7 to DIULM12 | ● | – | – | – | CI-K4-160-TS |
| DIULM17 to DIULM32 | ● | – | – | – | CI23E-150 |
| DIULM40 to DIULM65 | ● | – | – | – | CI43E-200 |
| SDAINLEM... | ● | – | – | – | CI-K5-125-TS CI-K5-125-M |
| SDAINLM12 to SDAINLM22 | ● | – | – | – | CI-K5-160-TS |
| SDAINLM30 to SDAINLM65 | ● | – | – | – | CI23E-150 |
| SDAINLM70 to SDAINLM115 | ● | – | – | – | CI43E-200 |
| Notes | CI-K small enclosure | → See catalog | Insulated PE, N or PEN terminal for enclosure CI-K | → See catalog | |
| | Terminal for CI-K enclosure | → See catalog | | | |
| | CI enclosure | → See catalog | | | |

1.1

Contactors

UL/CSA-approved rating data

1 for North America

DILE, DILA, DILM

Rating data for approved types



Maximum alternating current-motor rating

Single-phase

3-phase

| 115 V 120 V HP | 230 V 240 V HP | 200 V 208 V HP | 230 V 240 V HP | 460 V 480 V HP | 575 V 600 V HP |
|----------------------|----------------------|----------------------|----------------------|----------------------|----------------------|
|----------------------|----------------------|----------------------|----------------------|----------------------|----------------------|

GENERAL USE

Maximum motor-rated current
 I_{th}
Open/enclosed

A

Contactors

NEMA size

| | | | | | | A | Part no. | |
|----|----|-----|-----|------|------|---------|-------------------------------------|----|
| ½ | 1½ | 2 | 3 | 5 | 5 | 15/13.5 | DILEM(4) | 00 |
| ¼ | 1 | 1½ | 2 | 3 | 5 | 20 | DILM7-...(…) | 00 |
| ½ | 1½ | 3 | 3 | 5 | 7½ | 20 | DILM9-...(…) | 00 |
| 1 | 2 | 3 | 3 | 10 | 10 | 20 | DILM12-...(…) | 0 |
| 1 | 3 | | 5 | 10 | 10 | 20 | DILM15-...(…) | 0 |
| 2 | 3 | 5 | 7½ | 10 | 15 | 35 | DILM17-...(…) | 0 |
| 2 | 5 | 7½ | 7½ | 15 | 20 | 35 | DILM25-...(…) | 1 |
| 3 | 5 | 10 | 10 | 20 | 25 | 40 | DILM32-...(…), DILM38-...(…) | 1 |
| 3 | 7½ | 10 | 15 | 30 | 40 | 55 | DILM40(…) | 2 |
| 3 | 10 | 15 | 20 | 40 | 50 | 65 | DILM50(…) | 2 |
| 5 | 15 | 20 | 25 | 40 | 60 | 80 | DILM65(…), DILM70(…) | 2 |
| 7½ | 15 | 25 | 30 | 60 | 75 | 125 | DILM80(…) | 3 |
| 7½ | 15 | 25 | 40 | 75 | 100 | 125 | DILM95(…) | 3 |
| 10 | 25 | 40 | 50 | 100 | 125 | 160 | DILM115(…) | 4 |
| 15 | 30 | 40 | 60 | 125 | 125 | 160 | DILM150(…), DILM170(…) | 4 |
| – | – | 50 | 60 | 125 | 150 | 225 | DILM185(…) | 4 |
| – | – | 60 | 75 | 150 | 200 | 250 | DILM225(…) | 4 |
| – | – | 75 | 100 | 200 | 250 | 350 | DILM250(…) | 5 |
| – | – | 100 | 125 | 250 | 300 | 350 | DILM300(…) | 5 |
| – | – | 125 | 150 | 300 | 400 | 450 | DILM400(…) | 5 |
| – | – | 150 | 200 | 400 | 500 | 550 | DILM500(…) | 6 |
| – | – | 200 | 200 | 400 | 600 | 630 | DILM580(…) | 6 |
| – | – | 200 | 250 | 500 | 600 | 700 | DILM650(…) | 6 |
| – | – | 250 | 300 | 600 | 700 | 800 | DILM750(…) | 6 |
| – | – | 290 | 350 | 700 | 860 | 850 | DILM820(…) | 6 |
| – | – | 350 | 400 | 800 | 1000 | 1000 | DILM1000(…) | 7 |
| – | – | 560 | 640 | 1200 | 1300 | 1600 | DILM1600(…) | 8 |

DILE, DILA, DILM

Approved rating data UL - File No. E29184 for auxiliary contacts



Pilot Duty

General Use

| Part no. | Pilot Duty | | General Use | | | |
|--|------------|------|-------------|----|---------|-----|
| | AC | DC | AC V | A | DC V | A |
| DIL(E)EM-10(-01) DILER-40(31)(22) ...(D)DILE | A600 | P300 | 600 | 10 | 250 | 0.5 |
| DILM7-10(-01) To DILM32-10(-01) DILA... | A600 | P300 | 600 | 15 | 250 | 1 |
| DILA-XHI... DILM32-XHI... | A600 | P300 | 600 | 15 | 250 | 1 |
| DILM...-XHI11-SI DILM...-XHI11-SA DILM...-XHI11V-SI | A600 | P600 | 600 | 10 | – | – |

Further approvals → 81

- Elevator control
- Refrigeration control
- Resistance air heating
- Incandescent lamps
- Electrical discharge lamps
- Capacitive switching

for North America

DILM, DILMP, DILK

Special purpose rating



| | DIL | M7 | M9 | M12 | M15 | M17 | M25 MP32 MP45 | M32 | M40 MP63 | M50 MP80 | M65 M72 | M80 MP125 | M95 MP160 | M115 | M150 M170 MP200 |
|---|--------|----------|---------|----------|----------|---------|---------------------|-----------|-------------|-------------|------------|--------------|--------------|----------|-----------------------|
| Electrical discharge lamps (ballast) | | | | | | | | | | | | | | | |
| 480V 60Hz 3phase, 277V 60Hz 1phase | A | 12 | 18 | 20 | 20 | 27 | 35 | 40 | 63 | 79 | 88 | 85 | 100 | 136 | 160 |
| 600V 60Hz 3phase, 347V 60Hz 1phase | A | 12 | 18 | 20 | 20 | 27 | 35 | 40 | 63 | 79 | 88 | 85 | 100 | 136 | 160 |
| Incandescent lamps (Tungsten) | | | | | | | | | | | | | | | |
| 480V 60Hz 3phase, 277V 60Hz 1phase | A | 8 | 11 | 14 | 14 | 23 | 32 | 40 | 55 | 74 | 88 | 85 | 100 | 136 | 160 |
| 600V 60Hz 3phase, 347V 60Hz 1phase | A | 8 | 11 | 14 | 14 | 23 | 32 | 40 | 55 | 74 | 88 | 85 | 100 | 136 | 160 |
| Resistance air heating | | | | | | | | | | | | | | | |
| 480V60Hz 3phase, 277V60Hz 1phase | A | 12 | 18 | 20 | 20 | 27 | 35 | 40 | 63 | 79 | 88 | 94 | 110 | 136 | 160 |
| 600V60Hz 3phase, 347V60Hz 1phase | A | 12 | 18 | 20 | 20 | 27 | 35 | 40 | 63 | 79 | 88 | 94 | 110 | 136 | 160 |
| Refrigeration control (CSA only) | | | | | | | | | | | | | | | |
| LRA 480V 60Hz 3phase | A | 60 | 60 | 60 | 60 | 240 | 240 | 240 | 270 | 270 | 270 | 540 | 540 | 540 | 540 |
| LRA 600V 60Hz 3phase | A | 60 | 60 | 60 | 60 | 180 | 180 | 180 | 270 | 270 | 270 | 420 | 420 | 540 | 540 |
| 480V 60Hz 3phase | A | 6 | 7.5 | 10 | 10 | 23 | 32 | 40 | 26 | 36 | 45 | 63 | 70 | 84 | 90 |
| 600V 60Hz 3phase | A | 6 | 7.5 | 10 | 10 | 17 | 24 | 30 | 26 | 36 | 45 | 63 | 70 | 84 | 90 |
| Elevator control | | | | | | | | | | | | | | | |
| 200V 60Hz 3phase | HP (A) | ¾ (3.7) | 2 (7.8) | 2 (7.8) | 2 (7.8) | 3 (11) | 3 (11) | 7½ (25.3) | 7½ (25.3) | 10 (32.2) | 10 (32.2) | 20 (62.1) | 20 (62.1) | 30 (92) | 30 (92) |
| 240V 60Hz 3phase | HP (A) | 1½ (6.0) | 2 (6.8) | 2 (6.8) | 3 (9.6) | 3 (9.6) | 5 (15.2) | 7½ (22) | 10 (28) | 15 (42) | 15 (42) | 25 (68) | 30 (80) | 40 (104) | 40 (104) |
| 480V 60Hz 3phase | HP (A) | 2 (3.4) | 3 (4.8) | 7½ (11) | 7½ (11) | 7½ (11) | 10 (14) | 20 (27) | 25 (34) | 30 (40) | 30 (40) | 50 (65) | 60 (77) | 75 (96) | 75 (96) |
| 600V 60Hz 3phase | HP (A) | 3 (3.9) | 5 (6.1) | 7½ (9.6) | 7½ (9.6) | 10 (11) | 15 (17) | 20 (22) | 30 (32) | 40 (41) | 40 (41) | 60 (62) | 75 (77) | 100 (99) | 100 (99) |

DILM, DILMP, DILK

Special purpose rating



| | DIL | K12 | K20 | K25 | K33 | K50 |
|----------------------------|------|------|-----|------|-----|-----|
| Capacitor Switching | | | | | | |
| 240V 60Hz 3phase | A | 18 | 28 | 36 | 48 | 72 |
| 480V 60Hz 3phase | A | 18 | 28 | 36 | 48 | 72 |
| 600V 60Hz 3phase | A | 14.4 | 28 | 38.4 | 48 | 72 |
| 240V 60Hz 3phase | kvar | 7.5 | 12 | 15 | 20 | 30 |
| 480V 60Hz 3phase | kvar | 15 | 20 | 30 | 40 | 60 |
| 600V 60Hz 3phase | kvar | 15 | 30 | 40 | 50 | 75 |

1.1

Contactors

UL/CSA short circuit current rating

1 for North America

DILM

Short circuit current rating (SCCR)



| Contactor | Basic Rating | | | 480 V High Fault | | | | 600 V High Fault | | | |
|---------------|--------------|----------------|--------------|------------------|----------------|----|--------------|------------------|----------------|----|--------------|
| | kA | Max. fuse A | Max. CB A | kA | Max. fuse A | kA | Max. CB A | kA | Max. fuse A | kA | Max. CB A |
| DILM7-...(…) | 5 | 45 | 60 | 100 | 20 Class J | - | Fuse only | 30 | 25 | - | Fuse only |
| DILM9-...(…) | 5 | 45 | 60 | 100 | 20 Class J | - | Fuse only | 30 | 25 | - | Fuse only |
| DILM12-...(…) | 5 | 45 | 60 | 100 | 20 Class J | - | Fuse only | 30 | 25 | - | Fuse only |
| DILM15-...(…) | 5 | 45 | 60 | | 20 Class J | - | Fuse only | 30 | 25 | - | Fuse only |
| DILM17-...(…) | 5 | 125 | 125 | 100 | 70 Class J | 10 | 50 | 10 | 125 | 10 | 50 |
| DILM25-...(…) | 5 | 125 | 125 | 100 | 100 Class J | 10 | 50 | 10 | 125 | 10 | 50 |
| DILM32-...(…) | 5 | 125 | 125 | 100 | 125 Class J | 10 | 50 | 10 | 125 | 10 | 50 |
| DILM38-...(…) | 5 | 125 | 125 | 100 | 125 Class J | 10 | 50 | 10 | 125 | 10 | 50 |
| DILM40(…) | 10 | 250 | 250 | 100 | 150 Class J | 65 | 100 | 30 | 250 | 30 | 250 |
| DILM50(…) | 10 | 250 | 250 | 100 | 150 Class J | 65 | 100 | 30 | 250 | 30 | 250 |
| DILM65(…) | 10 | 250 | 250 | 100 | 150 Class J | 65 | 100 | 30 | 250 | 30 | 250 |
| DILM72(…) | 10 | 250 | 250 | 100 | 150 Class J | 65 | 100 | 30 | 250 | 30 | 250 |
| DILM80(…) | 10 | 600 | 600 | 100 | 300 Class J | 65 | 250 | 30 | 300 | 30 | 350 |
| DILM95(…) | 10 | 600 | 600 | 100 | 300 Class J | 65 | 250 | 30 | 300 | 30 | 350 |
| DILM115(…) | 10 | 600 | 600 | 100 | 300 Class J | 65 | 250 | 30 | 300 | 30 | 350 |
| DILM150(…) | 10 | 600 | 600 | 100 | 300 Class J | 65 | 250 | 30 | 300 | 30 | 350 |
| DILM170(…) | 10 | 600 | 600 | 100 | 300 Class J | 65 | 250 | 30 | 300 | 30 | 350 |
| DILM185(…) | 18 | 700 | 600 | - | CB only | 65 | 250 | - | - | - | - |
| DILM225(…) | 18 | 700 | 600 | - | CB only | 65 | 250 | - | - | - | - |
| DILM250(…) | 18 | 700 | 600 | - | CB only | 65 | 250 | - | - | - | - |
| DILM300(…) | 30 | 800 | 600 | - | CB only | 42 | 600 | 30 | 800 | 30 | 600 |
| DILM400(…) | 30 | 800 | 600 | - | CB only | 42 | 600 | 30 | 800 | 30 | 600 |
| DILM500(…) | 30 | 800 | 600 | - | CB only | 42 | 600 | 30 | 800 | 30 | 600 |
| DILM570(…) | 30 | 800 | 600 | - | CB only | 42 | 600 | 30 | 800 | 30 | 600 |
| DILM580(…) | 30 | 2000 | 1200 | 85 | 2000 | 85 | 1200 | 85 | 2000 | 85 | 1200 |
| DILM650(…) | 30 | 2000 | 1200 | 85 | 2000 | 85 | 1200 | 85 | 2000 | 85 | 1200 |
| DILM750(…) | 42 | 2000 | 1200 | 85 | 2000 | 85 | 1200 | 85 | 2000 | 85 | 1200 |
| DILM820(…) | 42 | 2000 | 1200 | 85 | 2000 | 85 | 1200 | 85 | 2000 | 85 | 1200 |
| DILM1000(…) | 85 | 2000 | 1200 | 85 | 2000 | 85 | 1200 | 85 | 2000 | 85 | 1200 |
| DILM1600(…) | 85 | 2000 | - | 85 | 2000 | - | - | 85 | 2000 | 85 | - |

1.1

Contactors

Contactors for resistive load

1 DILM, DILEM

Rating data

Single-phase rating AC-1

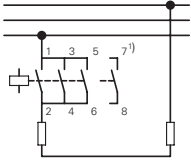

Three-phase rating AC-1

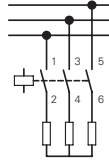

Three-phase rating AC-1

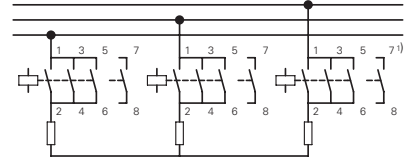

| Single-phase rating AC-1 | | | | | Three-phase rating AC-1 | | | | | Three-phase rating AC-1 | | | | |
|--------------------------|-----|-----|--------------------------|---|-------------------------|-----|-----|--------------------------|---|-------------------------|-----|-----|--------------------------|---|
| Voltage in V | | | Max. upstream fuse gG/gL | Rated operational current I _e = I _{th} or I _{Ithe} | Voltage in V | | | Max. upstream fuse gG/gL | Rated operational current I _e = I _{th} or I _{Ithe} | Voltage in V | | | Max. upstream fuse gG/gL | Rated operational current I _e = I _{th} or I _{Ithe} |
| 220 | 380 | 660 | | | 220 | 380 | 660 | | | 220 | 380 | 660 | | |
| kW | kW | kW | A | A | kW | kW | kW | A | A | kW | kW | kW | A | A |
| 230 | 400 | 690 | | | 230 | 400 | 690 | | | 230 | 400 | 690 | | |
| 240 | 440 | | | | 240 | 440 | | | | 240 | 440 | | | |

Open version

| | | | | | | | | | | | | | | |
|------|------|------|------|------|-----|------|------|------|------|------|------|------|----|------|
| 10 | 18 | 31 | 50 | 50 | 7 | 13 | 20 | 20 | 20 | 18 | 31 | 54 | 50 | 50 |
| 10 | 18 | 31 | 50 | 50 | 7 | 13 | 20 | 20 | 20 | 18 | 31 | 54 | 50 | 50 |
| 12 | 21 | 37 | 63 | 60 | – | – | – | – | – | 21 | 37 | 65 | 63 | 60 |
| 10 | 18 | 31 | – | 50 | 7 | 13 | 22 | – | 20 | 18 | 31 | 54 | – | 50 |
| 13 | 22 | 38 | – | 60 | – | – | – | – | – | 22 | 38 | 65 | – | 60 |
| 18 | 32 | 55 | – | 88 | 13 | 22 | 38 | – | 35 | 32 | 55 | 95 | – | 88 |
| 21 | 36 | 63 | – | 100 | 14 | 25 | 43 | – | 40 | 36 | 63 | 109 | – | 100 |
| 26 | 45 | 78 | – | 125 | 18 | 31 | 54 | – | 50 | 45 | 78 | 136 | – | 125 |
| 34 | 59 | 102 | – | 163 | 24 | 41 | 71 | – | 65 | 59 | 102 | 176 | – | 163 |
| 42 | 72 | 125 | – | 200 | 29 | 50 | 87 | – | 80 | 72 | 125 | 217 | – | 200 |
| 47 | 81 | 141 | – | 225 | 33 | 56 | 98 | – | 90 | 81 | 141 | 244 | – | 225 |
| 57 | 99 | 172 | – | 275 | 40 | 69 | 119 | – | 110 | 100 | 172 | 299 | – | 275 |
| 68 | 117 | 204 | – | 325 | 47 | 81 | 141 | – | 130 | 118 | 203 | 353 | – | 325 |
| 84 | 144 | 251 | – | 400 | 58 | 100 | 174 | – | 160 | 145 | 250 | 434 | – | 400 |
| 101 | 175 | 317 | – | 460 | 70 | 120 | 220 | – | 185 | 175 | 302 | 549 | – | 460 |
| 144 | 248 | 431 | 800 | 688 | 100 | 172 | 299 | 315 | 275 | 262 | 453 | 786 | – | 688 |
| 165 | 284 | 494 | 800 | 788 | 114 | 197 | 342 | 315 | 315 | 300 | 519 | 900 | – | 788 |
| 172 | 297 | 516 | 1000 | 825 | 120 | 206 | 357 | 400 | 330 | 333 | 576 | 1000 | – | 875 |
| 183 | 316 | 548 | 1000 | 875 | 126 | 219 | 380 | 400 | 350 | 381 | 658 | 1143 | – | 1000 |
| 261 | 451 | 784 | 1250 | 1250 | 181 | 313 | 543 | 500 | 500 | 476 | 825 | 1429 | – | 1250 |
| 366 | 632 | 1097 | – | 1750 | 253 | 438 | 760 | 800 | 700 | 667 | 1152 | 2000 | – | 1750 |
| 418 | 722 | 1254 | – | 2000 | 290 | 500 | 869 | 800 | 800 | 762 | 1316 | 2286 | – | 2000 |
| 444 | 767 | 1332 | – | 2125 | 308 | 531 | 923 | 1000 | 850 | 810 | 1400 | 2429 | – | 2125 |
| 470 | 812 | 1411 | – | 2250 | 326 | 563 | 977 | 1000 | 900 | 857 | 1480 | 2572 | – | 2250 |
| 523 | 903 | 1568 | – | 2500 | 362 | 625 | 1086 | 1000 | 1000 | 953 | 1646 | 2858 | – | 2500 |
| 732 | 1264 | 2195 | – | 3500 | 507 | 875 | 1520 | – | 1400 | 1334 | 2300 | 4000 | – | 3500 |
| 1045 | 1805 | 3135 | – | 5000 | 724 | 1251 | 2172 | – | 2000 | 1905 | 3290 | 5716 | – | 5000 |
| 1150 | 1985 | 3449 | – | 5500 | 796 | 1376 | 2389 | – | 2200 | 2095 | 3619 | 6288 | – | 5500 |
| 1358 | 2346 | 4075 | – | 6500 | 941 | 1626 | 2827 | – | 2600 | 2476 | 4277 | 7430 | – | 6500 |

Notes

¹⁾ Contact 7 – 8 only with DILEM4(-G), DILMP20...

DILM, DILEM

| Part no. | Ordering data | Required accessories: | Notes |
|----------|---------------|--------------------------|-------|
| | | Paralleling links | |

| AC operated | Page | Part no. | Accessories | Page |
|-----------------|------|-------------|---------------------------|------|
| DILEM-10(...) | → 4 | P1DILEM | | |
| DILEM-01(...) | → 4 | P1DILEM | | |
| DILEM4(...) | → 4 | P1DILEM | | |
| DILM7-...(...) | → 18 | DILM12-XP1 | Auxiliary contact modules | → 6 |
| DILMP20(...) | → 34 | DILM12-XP1 | Set of paralleling links | → 36 |
| DILM17-...(...) | → 18 | DILM32-XP1 | Enclosure | → 53 |
| DILM25-...(...) | → 18 | DILM32-XP1 | Accessories | → 63 |
| DILM40(...) | → 20 | DILM65-XP1 | | → 52 |
| DILM50(...) | → 20 | DILM65-XP1 | | |
| DILM65(...) | → 20 | DILM65-XP1 | | |
| DILM80(...) | → 20 | DILM150-XP1 | | |
| DILM95(...) | → 20 | DILM150-XP1 | | |
| DILM115(...) | → 20 | DILM150-XP1 | | |
| DILM150(...) | → 20 | DILM150-XP1 | | |
| DILM170(...) | → 20 | DILM150-KP1 | | |
| DILM185A(...) | → 30 | DILM185-XP1 | | |
| DILM225A(...) | → 30 | DILM185-XP1 | | |
| DILM250(...) | → 30 | - | | |
| DILM300A(...) | → 30 | - | | |
| DILM400(...) | → 30 | - | | |
| DILM500(...) | → 30 | - | | |
| DILM580(...) | → 30 | - | | |
| DILM650(...) | → 30 | - | | |
| DILM750(...) | → 30 | - | | |
| DILM820(...) | → 30 | - | | |
| DILH1400(...) | → 32 | - | | |
| DILH2000(...) | → 32 | - | | |
| DILH2200(...) | → 32 | - | | |
| DILH2600(...) | → 32 | - | | |

1.1

Mini contactor relays, contactor relays

Electrical lifespan

1 DILA (AC-15)

Component lifespan (operations)
 I_e = Rated operational current

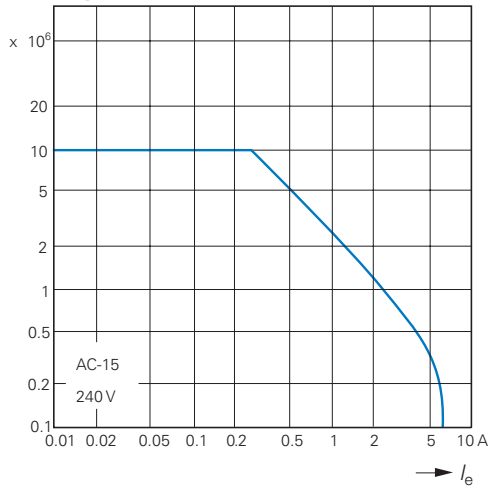

DILA DC¹⁾

Component lifespan (operations)
 I_e = Rated operational current

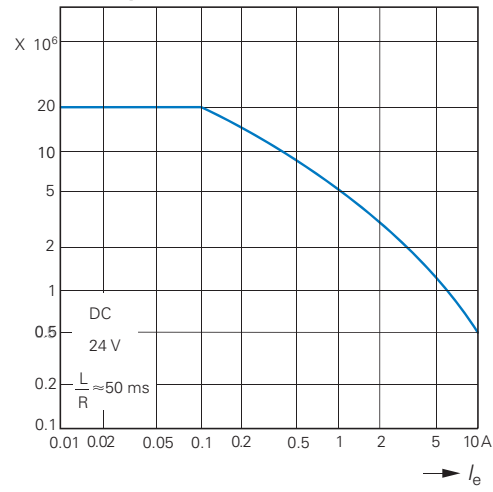

¹⁾ Three contacts in series

DILER (AC-15)

Component lifespan (operations)
 I_e = Rated operational current

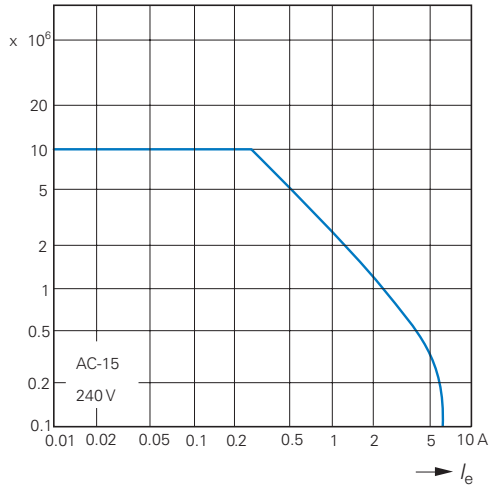

Normal switching duty

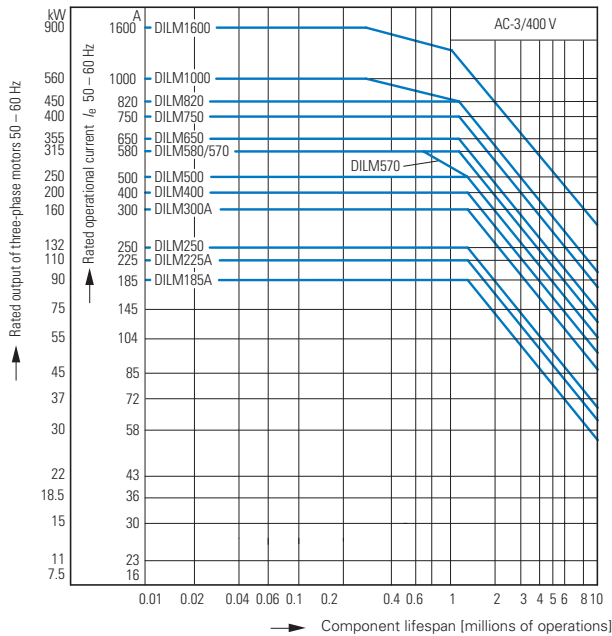
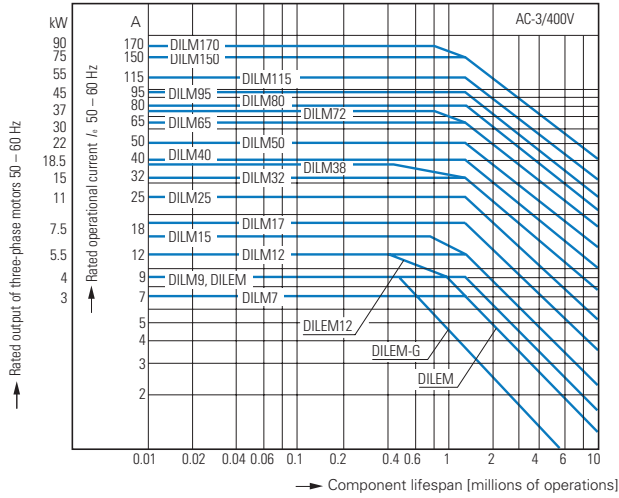

Extreme switching duty

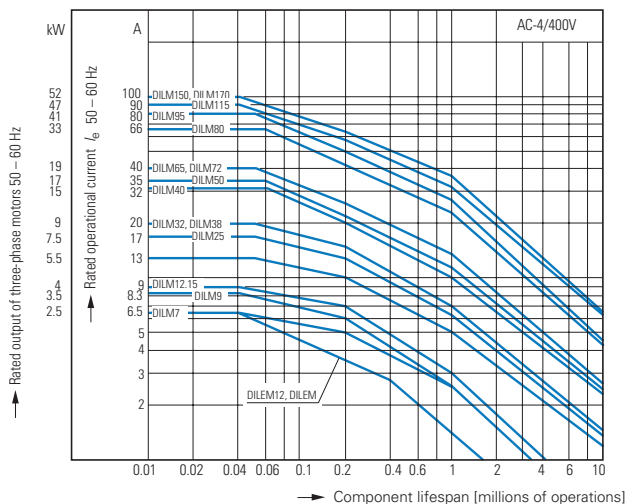

Normal AC induction motor

Operating characteristics

Make: from stop

Break: during run

Electrical characteristics:

Make: up to 6 X rated motor current

Break: 1 X rated motor current

Utilization category

100 % AC-3

Typical applications:

- | | | |
|--|-----------------|-----------------------|
| Compressors | Lifts | Mixers |
| Pumps | Escalators | Agitators |
| Fan | Conveyor belts | Centrifuges |
| Hinged flaps | Bucket-elevator | Air conditioning sys- |
| General drives for manufacturing and processing machines | | |

Normal AC induction motor

Operating characteristics

Inching, plugging, reversing

Electrical characteristics:

Make: up to 6 X rated motor current

Break: 6 X rated motor current

Utilization category

100 % AC-4

Typical applications:

- | | | |
|---|--------------|-------------|
| Printing machines | Wire-drawing | Centrifuges |
| Special drives on manufacturing and processing machines | | |

1.1

Contactors

Switching conditions

1 Extreme switching duty

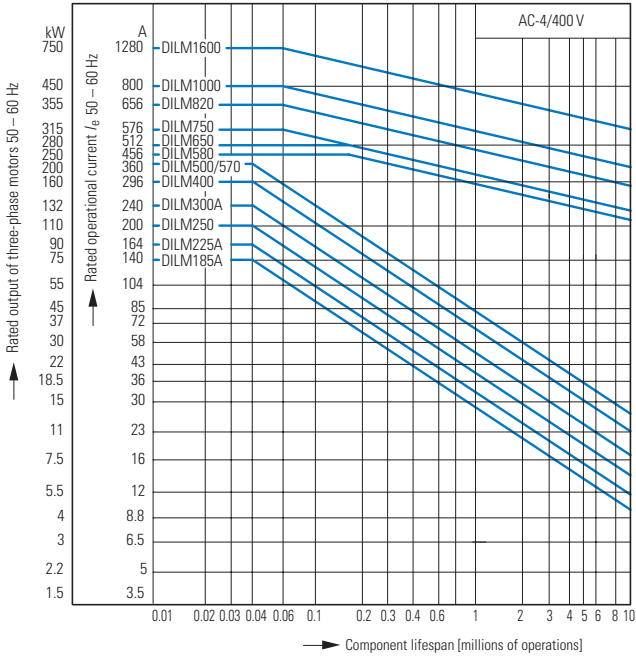

Normal AC induction motor

Operating characteristics

Inching, plugging, reversing

Electrical characteristics:

Make: up to 6 X rated motor current

Break: 6 X rated motor current

Utilization category

100% AC-4

Typical applications:

Printing machines Wire-drawing machines Centrifuges

Special drives on manufacturing and processing machines

Switching conditions for 3 pole, non-motor loads

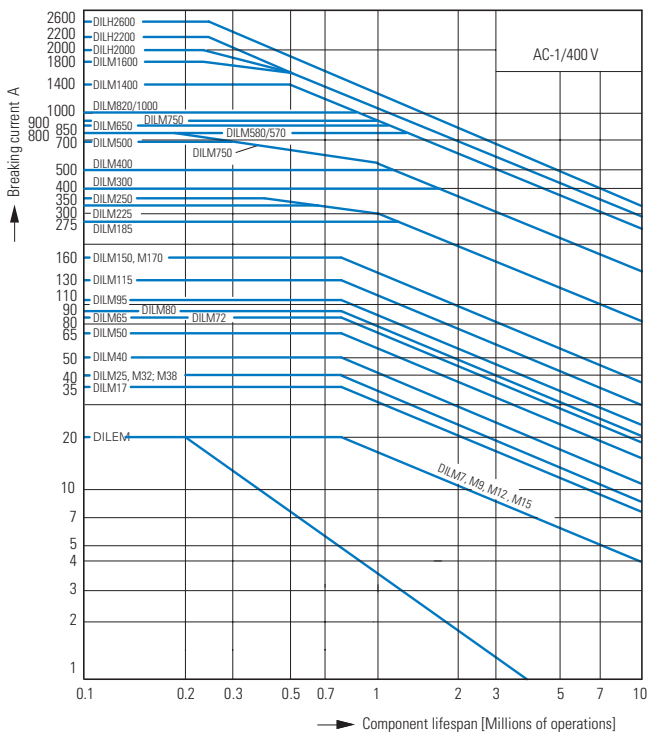

Operating characteristics

Non inductive and slightly inductive loads

Electrical characteristics:

Make: 1 X rated operational current

Break: 1 X rated operational current

Utilization category

100% AC-1

Typical applications:

Electric heat

Switching conditions for 4 pole, non-motor loads

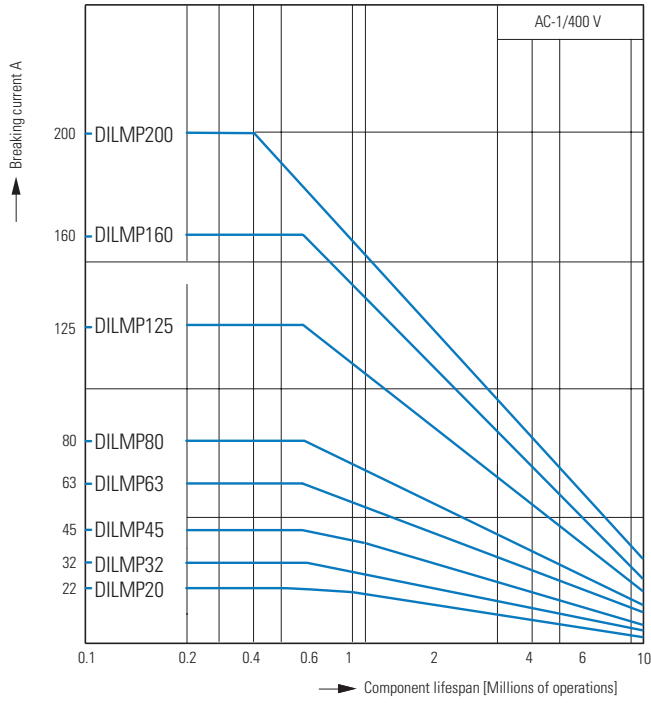

- Operating characteristics
 - Non inductive and slightly inductive loads
- Electrical characteristics:
 - Make: 1 X rated operational current
 - Break: 1 X rated operational current
- Utilization category
 - 100% AC-1
- Typical applications:
 - Electric heat

1.1

Contactors

Short-time loading

1 Short-time loading 3 pole

Time interval between two loads: 15 minutes

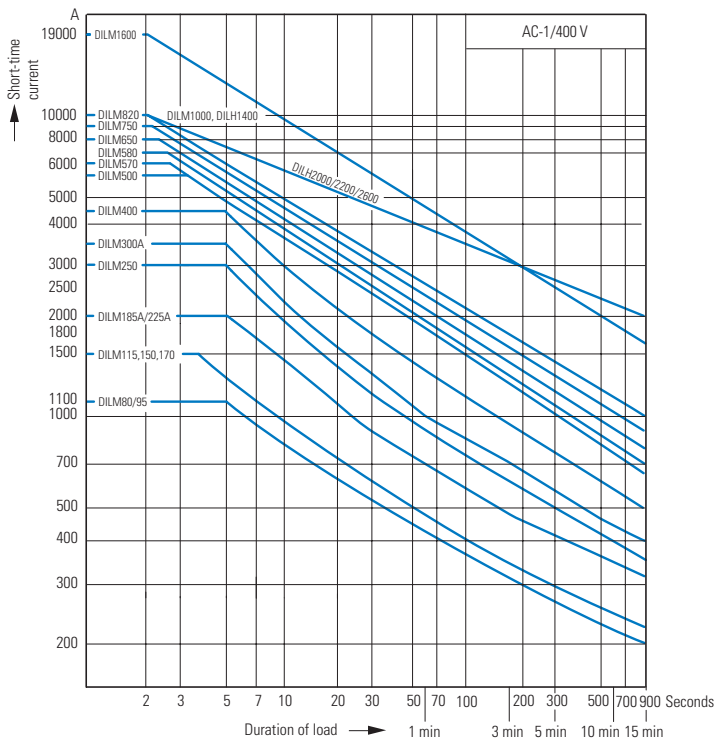
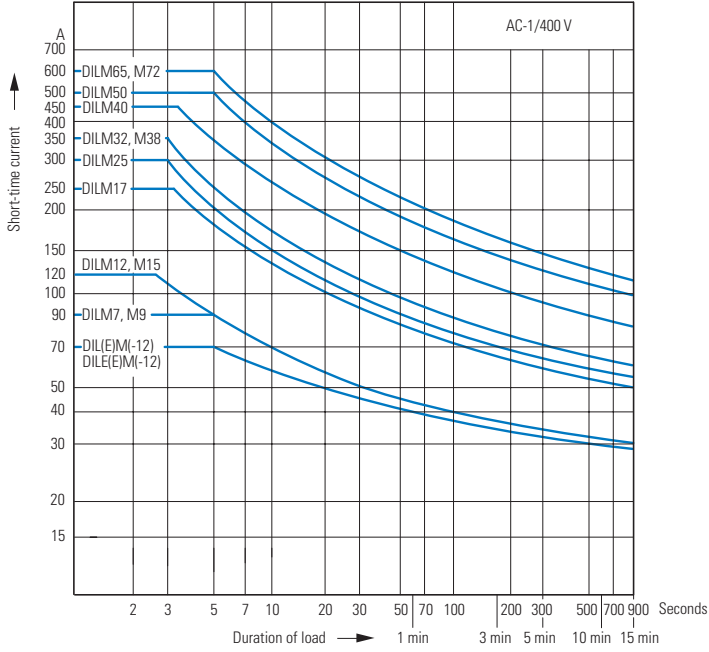

Determination of the maximum operating frequency dependent on the rating and utilization category (recommended values) for 400 V

P_N = max. rated motor output (kW) of respective contactor according to → Page 18 and → Page 4

S/h = max. operation per hour

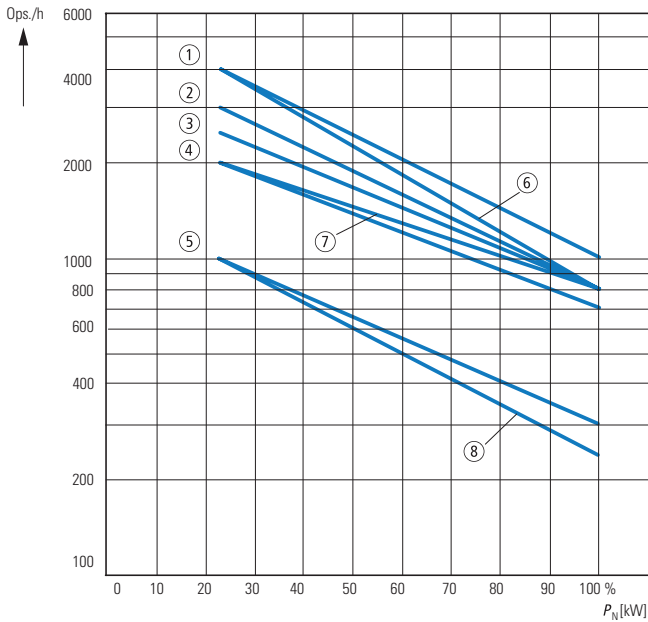

DILEM, DILM, DILH

| Part no. | Characteristic | | |
|---------------------------|----------------|------|--------------|
| | AC-1 | AC-3 | AC-2 AC-4 |
| DILE(E)M(-12) | 7 | 6 | 8 |
| DILM7, 9, 12, 15 | 3 | 1 | 5 |
| DILM17, 25, 32, 38 | 3 | 2 | 5 |
| DILM40, 50, 65, 72 | 3 | 2 | 5 |
| DILM80, 95, 115, 150, 170 | 3 | 4 | 5 |

Determination of the maximum operating frequency dependent on the rating and utilization category (recommended values)

P_N = max. rated motor output (kW) of respective contactor according to → Page 28 and → Page 32

S/h = max. operation per hour

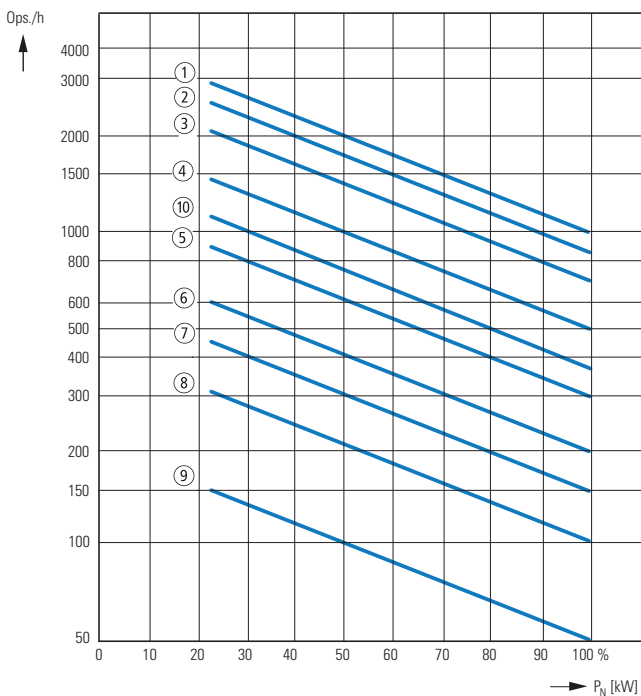

DILEM, DILM, DILH

| Part no. | Characteristic | | |
|----------|----------------|------|------|
| | AC-1 | AC-3 | AC-4 |
| DILM185A | 2 | 1 | 8 |
| DILM225A | 2 | 1 | 8 |
| DILM250 | 2 | 1 | 8 |
| DILM300A | 3 | 2 | 9 |
| DILM400 | 3 | 2 | 9 |
| DILM500 | 3 | 2 | 9 |
| DILM580 | 3 | 4 | 7 |
| DILM650 | 3 | 4 | 7 |
| DILM750 | 3 | 4 | 7 |
| DILM820 | 3 | 4 | 7 |
| DILM1000 | 3 | 4 | 7 |
| DILM1600 | 10 | 10 | 7 |
| DILH1400 | 10 | – | – |
| DILH2000 | 10 | – | – |
| DILH2200 | 10 | – | – |
| DILH2600 | 10 | – | – |

1.1

Contactors

Switching of DC current

1 DC current switching

----- when necessary
conductor to be
supplied by customer

DILEEM ... DILM700

Without overload relay
≤ 60 V DC

> 60 V DC

With overload relay
> 60 V DC

1 pole

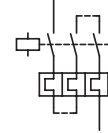

2 pole

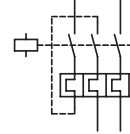

DILEM4 DILMP...

1 pole

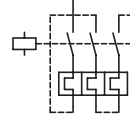
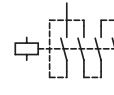

2 pole

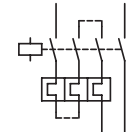

Wiring, star-delta combination with DILM32-XTEY20

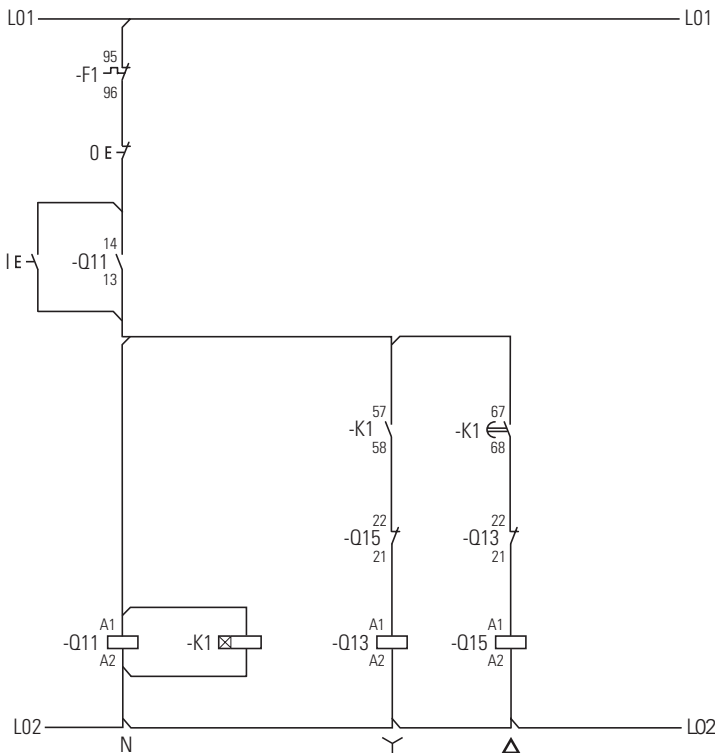

Technical data

DILER, DILA

| | | | DILA | DILA...XHI | DILER | DILE... |
|---|------------------------------------|-------------------|---|--------------------------------------|--------------------------------------|---|
| General | | | | | | |
| Standards | | | IEC/EN 60947, VDE 0660, UL, CSA | | | |
| Lifespan, mechanical | | | | | | |
| AC operated | Operations | x 10 ⁶ | 20 | 10 | 10 | 10 |
| DC operated | Operations | x 10 ⁶ | 20 | 10 | 20 | 20 |
| Maximum operating frequency | | | | | | |
| Maximum operating frequency | Operations/h | | 9000 | 9000 | 9000 | 9000 |
| Climatic proofing | | | | | | |
| | | | Damp heat, constant, to IEC 60068-2-78; Damp heat, cyclic, to IEC 60068-2-30 | | | |
| Ambient temperature | | | | | | |
| Open | | °C | -25...60 | -25...60 | -25...50 | -25...50 |
| Enclosed | | °C | -25...40 | -25...40 | -25...40 | -25...40 |
| Ambient temperature for storage | | °C | -40 - 80 | -40 - 80 | | |
| Mounting position | | | | | | |
| | | | | | | Any, except vertically with terminals A1/A2 below |
| Mechanical shock resistance (IEC/EN 60068-2-27) | | | | | | |
| Half-sinusoidal shock 10 ms | | | | | | |
| Basic devices with auxiliary contact module | | | | | | |
| | | g | 7 | 7 | 10 | 10 |
| | N/O | g | 7 | 7 | 10 | 10 |
| | NC | g | 5 | 5 | 8 | 8 |
| Protection type | | | | | | |
| | | | IP20 | IP20 | IP20 | IP20 |
| Protection against direct contact when actuated from front (EN 50274) | | | | | | |
| | | | Finger- and back-of-hand proof | | | |
| Weight | | | | | | |
| AC operated | | kg | 0.23 | 0.05 | 0.17 | – |
| DC operated | | kg | 0.28 | 0.05 | 0.2 | – |
| Terminal capacity | | | | | | |
| Screw terminals | | | | | | |
| | Solid | mm ² | 1 x (0.75 - 4) 2 x (0.75 - 2.5) | 1 x (0.75 - 4) 2 x (0.75 - 2.5) | 1 x (0.75 - 2.5) 2 x (0.75 - 2.5) | 1 x (0.75 - 2.5) 2 x (0.75 - 2.5) |
| | Flexible with ferrule | mm ² | 1 x (0.75 - 2.5) 2 x (0.75 - 2.5) | 1 x (0.75 - 2.5) 2 x (0.75 - 2.5) | 1 x (0.75 - 1.5) 2 x (0.75 - 1.5) | 1 x (0.75 - 1.5) 2 x (0.75 - 1.5) |
| | Solid or stranded | AWG | 18 - 14 | 18 - 14 | 18 - 14 | 18 - 14 |
| | Terminal screw | | M3.5 | M3.5 | M3.5 | M3.5 |
| | Pozidriv screwdriver | Size | 2 | 2 | 2 | 2 |
| | Flat-blade screwdriver | mm | 0.8 x 5.5 1 x 6 | 0.8 x 5.5 1 x 6 | 0.8 x 5.5 1 x 6 | 0.8 x 5.5 1 x 6 |
| | Max. tightening torque | Nm | 1.2 | 1.2 | 1.2 | 1.2 |
| Spring-loaded terminals | | | | | | |
| | Solid | mm ² | 1 x (0.75 - 2.5) 2 x (0.75 - 2.5) | 1 x (0.75 - 2.5) 2 x (0.75 - 2.5) | 1 x (1 - 2.5) 2 x (1 - 2.5) | 1 x (1 - 2.5) 2 x (1 - 2.5) |
| | Flexible with ferrule | mm ² | 1 x (0.75 - 1.5) 2 x (0.75 - 1.5) | 1 x (0.75 - 1.5) 2 x (0.75 - 1.5) | 1 x (1 - 2.5) 2 x (1 - 2.5) | 1 x (1 - 2.5) 2 x (1 - 2.5) |
| | Flexible without ferrule DIN 46228 | mm ² | 1 x (0.75 - 2.5) 2 x (0.75 - 2.5) | 1 x (0.75 - 1.5) 2 x (0.75 - 1.5) | – | – |
| | Solid or stranded | AWG | 18 - 14 | 18 - 14 | 1 x (16 - 14) 2 x (16 - 14) | 1 x (16 - 14) 2 x (16 - 14) |
| | Flat-blade screwdriver | mm | 0.6 x 3.5 | 0.6 x 3.5 | 0.6 x 3.5 | 0.6 x 3.5 |

1.1 Mini contactor relays, contactor relays

1 DILER, DILA

| | | | | DILA | DILA...XHI | DILER | DILE... |
|--|-----------|---------|------|-------------------|------------|---|---------|
| Contacts | | | | | | | |
| Interlocked opposing contacts to EN 60947-4-1, Annex L, including auxiliary contact module | | | | Yes | Yes | Yes | Yes |
| Rated impulse withstand voltage | U_{imp} | V AC | 6000 | 6000 | 6000 | 6000 | 6000 |
| Overvoltage category/degree of pollution | | | | III/3 | III/3 | III/3 | III/3 |
| Rated insulation voltage | U_i | V AC | 690 | 690 | 690 | 690 | 690 |
| Rated operating voltage | U_e | V AC | 690 | 500 | 600 | 600 | 600 |
| Safe isolation according to EN 61140 | | | | | | | |
| Between coil and auxiliary contacts | | | | V AC | 400 | 300 | 300 |
| Between the auxiliary contacts | | | | V AC | 400 | 300 | 300 |
| Rated operational current | | | | | | | |
| AC-15 | | | | | | | |
| 220/240 V | I_e | A | 4 | 4 | 6 | 4 | |
| 380/415 V | I_e | A | 4 | 4 | 3 | 2 | |
| 500 V | I_e | A | 1.5 | 1.5 | 1.5 | 1.5 | |
| DC ¹⁾ | | | | | | | |
| L/R \leq 15 ms | | | | | | | |
| Contacts in series: | | | | | | | |
| 1 | 24 V | A | 10 | 10 | 2.5 | 2.5 | |
| 1 | 60 V | A | 6 | 6 | – | – | |
| 2 | 60 V | A | 10 | 10 | 2.5 | 2.5 | |
| 1 | 110 V | A | 3 | 3 | – | – | |
| 3 | 110 V | A | 6 | 6 | 1.5 | 1.5 | |
| 1 | 220 V | A | 1 | 1 | – | – | |
| 3 | 220 V | A | 5 | 5 | 0.5 | 0.5 | |
| L/R \leq 50 ms | | | | | | | |
| Contacts in series: | | | | | | | |
| 3 | 24 V | A | 4 | 2.5 | – | – | |
| 3 | 60 V | A | 4 | 1 | – | – | |
| 3 | 110 V | A | 2 | 0.5 | – | – | |
| 3 | 220 V | A | 1 | 0.25 | – | – | |
| DC-13 (6xP) | | | | | | | |
| Contacts in series: | | | | | | | |
| 3 | 24 V | A | 2.5 | 2.5 | – | – | |
| 3 | 60 V | A | 1 | 1 | – | – | |
| 3 | 110 V | A | 0.5 | 0.5 | – | – | |
| 3 | 220 V | A | 0.25 | 0.25 | – | – | |
| Control circuit reliability (at $U_e = 24$ V DC, $U_{min} = 17$ V, $I_{min} = 5.4$ mA) | | | | Fault probability | λ | <10 ⁻⁸ , < one failure in 100 million operations | |
| Conventional thermal current | | | | I_{th} | A | 16 | 16 |
| Short-circuit strength without welding | | | | | | | |
| Maximum overcurrent protection device | | | | | | | |
| 220/240 V | | PKZM0 | 4 | – | 4 | 4 | |
| 380/415 V | | PKZM0 | 4 | – | 4 | 4 | |
| Short-circuit protection rating maximum fuse ²⁾ | | | | | | | |
| 500 V | | A gG/gL | 10 | 10 | 6 | 6 | |
| 500 V | | A fast | – | – | 10 | 10 | |
| Current heat loss at load of I_{th} | | | | | | | |
| AC operated | | | | W | 0.3 | 0.2 | 0.2 |
| DC operated | | | | W | 0.3 | 0.3 | 0.3 |

Notes

¹⁾ Switch-on and switch-off conditions based on DC-13, time constant as specified

²⁾ See characteristic curve "Fuses" for time/current characteristics (please enquire)

DILER, DILA

| | | | DILA | DILA...XHI | DILER | DILE... | |
|--|---|-------------------|---------|------------|-------|------------|----|
| Magnet systems | | | | | | | |
| Voltage tolerance | | | | | | | |
| AC operated | | | | | | | |
| | Single-voltage coil 50 Hz and dual-voltage coil 50 Hz, 60 Hz | Pick-up | $x U_c$ | 0.8...1.1 | – | 0.8...1.1 | – |
| | Dual-frequency coil 50/60 Hz | Pick-up | $x U_c$ | 0.8...1.1 | – | 0.85...1.1 | – |
| DC operated ¹⁾ | | | | | | | |
| | Starting voltage | Pick-up | $x U_c$ | 0.8...1.1 | – | 0.85...1.3 | – |
| | At 24 V: without auxiliary contact module (40 °C) | Pick-up | $x U_c$ | 0.7 - 1.3 | – | 0.7 - 1.3 | – |
| Power consumption | | | | | | | |
| | 50 Hz | Pick-up | VA | 24 | – | 25 | – |
| | 50 Hz | Sealing | VA | 3.4 | – | 4.6 | – |
| | 50 Hz | Sealing | W | 1.2 | – | 1.3 | – |
| | 60 Hz | Pick-up | VA | 30 | – | 25 | – |
| | 60 Hz | Sealing | VA | 4.4 | – | 4.6 | – |
| | 60 Hz | Sealing | W | 1.4 | – | 1.3 | – |
| | 50/60 Hz | Pick-up | VA | 27 25 | – | 30 29 | – |
| | 50/60 Hz | Sealing | VA | 4.2 3.3 | – | 5.4 3.9 | – |
| | 50/60 Hz | Sealing | W | 1.4 1.2 | – | 1.6 1.1 | – |
| | DC operated | Pick-up = sealing | W | 3 | – | 2.6 | – |
| Duty factor | | | % DF | 100 | – | 100 | – |
| Changeover times at 100 % U_c (recommended values) | | | | | | | |
| | AC operated closing delay | | ms | 15 - 21 | – | 14 - 21 | – |
| | AC operated normally open contact opening delay | | ms | 9 - 18 | – | 8 - 18 | – |
| | AC operated with auxiliary contact module, max. closing delay | | ms | – | – | 45 | 45 |
| | DC operated closing delay | | ms | 31 | – | 26 - 35 | – |
| | DC operated normally open contact opening delay | | ms | 12 | – | 15 - 25 | – |
| | DC operated with auxiliary contact module, max. closing delay | | ms | – | – | 70 | 70 |

Notes
¹⁾ Smoothed DC, three-phase bridge rectifier or smoothed two-phase bridge rectifier

1.1

Contactors

Amplifier modules, electronic timer module, contactor monitoring device

1 ETS-VS3, DILM, CMD

| | | | ETS4-VS3 | DILM32-XTE | CMD(24VDC) CMD(220-240VAC) |
|---|--------------|-------------------|--|---|--------------------------------------|
| General | | | | | |
| Standards | | | IEC/EN 60947, VDE 0660, UL, CSA | DIN EN 61812, IEC/EN 60947, VDE 0660, UL, CSA | IEC/EN 60947 UL CSA |
| Lifespan, mechanical | | | | | |
| AC operated | c (contacts) | x 10 ⁶ | – | 3 | 10 |
| DC operated | c (contacts) | x 10 ⁶ | 30 | 3 | 3 |
| Maximum operating frequency | | | | | |
| DC operated | c (contacts) | x 10 ⁶ | 72000 | – | 9000 |
| Climatic proofing | | | | | |
| | | | Damp heat, constant, to IEC 60068-2-78 Damp heat, cyclic, to IEC 60068-2-30 | | |
| Ambient temperature | | | | | |
| Storage | | °C | – | -40 - 80 | -40 - 80 |
| Open | | °C | -25 - 60 | -25 - 60 | -25 - 50 |
| Enclosed | | °C | -25 - 45 | -25 - 40 | – |
| Mounting position | | | Any | As required, except suspended | Any |
| Mechanical shock resistance (IEC/EN 60068-2-27) | | | | | |
| Half-sinusoidal shock 20 ms | | | | | |
| N/O | | g | 10 | – | – |
| Half-sinusoidal shock 10 ms | | | | | |
| N/O | | g | – | 6 | 4 |
| NC | | g | – | 6 | 4 |
| Protection type | | | IP20 | IP20 | IP20 |
| Protection against direct contact when actuated from front (EN 50274) | | | Finger- and back-of-hand proof | | |
| Weight | | kg | 0.09 | 0.08 | 0.1 |
| Terminal capacity | | | | | |
| Solid | | mm ² | 1 x (0.75 - 2.5) 2 x (0.75 - 2.5) ¹⁾ | 1 x (0.75 - 2.5) 2 x (0.75 - 1.5) | 1 x (0.75...2.5) 2 x (0.75...1.5) |
| Flexible with ferrule | | mm ² | 1 x (0.75 - 2.5) 2 x (0.75 - 1.5) ¹⁾ | 1 x (0.75 - 1.5) 2 x (0.75 - 1.5) | 1 x (0.75...1.5) 2 x (0.75...1.5) |
| Solid or stranded | | AWG | 16 - 14 | 18 - 14 | 18...14 |
| Terminal screw | | | M3.5 | M3.5 | M3.5 |
| Pozidriv screwdriver | | Size | 2 | 2 | 2 |
| Flat-blade screwdriver | | mm | 0.8 x 5.5 1 x 6 | 0.8 x 5.5 1 x 6 | 0.8 x 5.5 1 x 6 |
| Max. tightening torque | | Nm | 1.2 | 1.2 | 1.2 |

Notes

¹⁾ Use equal cross-sections only

ETS-VS3, DILM, CMD

| | | | ETS4-VS3 | DILM32-XTE | CMD(24VDC) | CMD(220-240VAC) |
|---|-------------------|---------------|--|------------|------------|-----------------|
| Contacts | | | | | | |
| Rated impulse withstand voltage | U_{imp} | V AC | 6000 | 6000 | 8000 | 4000 |
| Overvoltage category/degree of pollution | | | III/2 | III/3 | III/3 | III/3 |
| Rated insulation voltage | U_i | V AC | 440 | 600 | 100 | 250 |
| Rated operating voltage | U_e | V | 440 AC | 400 AC | 24 DC | 250 AC |
| Rated operational current | | | | | | |
| AC-15 | | | | | | |
| 220/240 V | I_e | A | 2 | 3 | – | – |
| 280/415 V | I_e | A | 2 | – | – | – |
| DC-13 ¹⁾ | | | | | | |
| DC-13 L/R ≤ 15 ms | | | | | | |
| Contacts in series: | | | | | | |
| 1 | 24 V | A | 2.6 | 1 | – | – |
| 1 | 60 V | A | 1 | 0.2 | – | – |
| 1 | 110 V | A | 0.6 | 0.2 | – | – |
| 1 | 220 V | A | 0.2 | 0.1 | – | – |
| DC-13 L/R ≤ 50 ms | | | | | | |
| Contacts in series: | | | | | | |
| 1 | 24 V | A | 2 | 1 | – | – |
| 1 | 60 V | A | 0.6 | 0.2 | – | – |
| 1 | 110 V | A | 0.08 | 0.2 | – | – |
| 1 | 220 V | A | 0.08 | 0.1 | – | – |
| DC-13 L/R ≤ 300 ms | | | | | | |
| Contacts in series: | | | | | | |
| 1 | 24 V | A | 0.6 | 1 | – | – |
| 1 | 60 V | A | 0.2 | 0.2 | – | – |
| 1 | 110 V | A | 0.08 | 0.2 | – | – |
| 1 | 220 V | A | 0.03 | 0.1 | – | – |
| Safe isolation according to EN 61140 | | | | | | |
| Between coil and auxiliary contacts | | V AC | – | 250 | – | – |
| Between the auxiliary contacts | | V AC | – | 250 | – | – |
| Control circuit reliability (at $U_e = 24$ V DC, $U_{min} = 17$ V, $I_{min} = 5.4$ mA) | Fault probability | λ | $<10^{-8}$, < one failure in 100 million operations | – | – | – |
| Conventional thermal current | I_{th} | A | 6 | 4 | – | – |
| Component lifespan | | | | | | |
| AC-15 | | | | | | |
| 230 V, $I_e = 0.1$ A | Switch operations | $\times 10^6$ | 7 | – | – | – |
| 230 V, $I_e = 1.2$ A | Switch operations | $\times 10^6$ | 1 | – | – | – |
| Short-circuit rating without welding | | | | | | |
| Short-circuit protection rating maximum fuse ²⁾ | | | | | | |
| 500 V | | A gG/gL | – | 4 | 2 | 2 |
| 500 V | | A fast | 4 | – | – | – |

Notes

¹⁾ Switch-on and switch-off conditions based on DC-13, time constant as specified

²⁾ See transparent overlay "Fuses" for time/current characteristics (please enquire)

1.1

Contactors

Amplifier modules, electronic timer module, contactor monitoring device

1 ETS-VS3, DILM, CMD

| | | | ETS4-VS3 | DILM32-XTE | CMD(24VDC) CMD(220-240VAC) |
|--|-----------------------------|-------------------|----------|------------|-------------------------------|
| Magnet systems | | | | | |
| Voltage tolerance | | | | | |
| Starting voltage | | | | | |
| | AC operated | | | | |
| | | Pick-up | $x U_c$ | – | 0.85 - 1.1 |
| | DC operated ¹⁾ | | | | 0.85 - 1.1 |
| | | Pick-up | $x U_c$ | 0.85 - 1.2 | 0.7 - 1.2 |
| Power consumption | | | | | |
| | AC operated | Sealing | VA | – | 2 |
| | AC operated | Sealing | W | – | 1.8 |
| | DC operated | Pick-up = sealing | W | 0.6 | – |
| | | | | | 4 |
| Duty factor | | | | | |
| | | % DF | 100 | 100 | 100 |
| Changeover times at 100 % U_c (recommended values) | | | | | |
| | DC operated closing delay | | ms | 7 | – |
| | DC operated opening delay | | ms | 3 | – |
| Maximum operating frequency | | | | | |
| | Max. operating frequency | | Ops/h | – | 3600 |
| | 6 A/250 V | | Ops/h | – | 360 |
| Minimum on duration | | | | | |
| | On-delayed | | ms | – | < 50 |
| | Off-delayed | | ms | – | < 200 |
| Repetition accuracy (with constant parameters) | | | | | |
| | Deviation | | % | – | < 5 |
| Recovery time (after 100% time delay) | | | | | |
| | | | ms | – | 70 |
| Contact changeover time | | | | | |
| | DILM32-XTEE11/DILM32-XTED11 | t_u | ms | – | 10 |
| | DILM32-XTEY20 | t_u | ms | – | 50 |
| | CMD | t_u | ms | – | – |
| | | | | | 100 ± 20% |

Notes

¹⁾ Smoothed DC, three-phase bridge rectifier or smoothed two-phase bridge rectifier

DILEEM, DILEM

| | | DILEEM DILEM DILEM12 | DILEEM-G DILEM-G DILEM12-G | DILEM4 | DILEM4-G |
|---|---|--|----------------------------------|--------|---|
| General | | | | | |
| Standards | | IEC/EN 60947, VDE 0660, CSA, UL | | | |
| Lifespan, mechanical; Coil 50/60 Hz | at 50 Hz | 7 | – | 7 | – |
| Lifespan, mechanical | c (contacts) x 10 ⁶ | 10 | 20 | 20 | – |
| Maximum operating frequency | | | | | |
| Mechanical | Ops/h | 9000 | | | |
| Electrical (Contactor without overload relay) | | → Characteristic curves Page 91 | | | |
| Climatic proofing | | Damp heat, constant, to IEC 60068-2-78 Damp heat, cyclic, to IEC 60068-2-30 | | | |
| Ambient temperature | | | | | |
| Open | °C | -25 - 50 | | | |
| Enclosed | °C | -25 - 40 | | | |
| Mounting position | | Any, except for vertically with terminals A1/A2 below | | |  |
| Mechanical shock resistance (IEC/EN 60068-2-27) | | | | | |
| Half-sinusoidal shock 10 ms | | | | | |
| Basic device without auxiliary contact module | | | | | |
| | Main circuit normally open contact | g | 10 | | |
| | Auxiliary contacts NC/Normally open contact | g | 10/8 | 10/8 | – – |
| Basic devices with auxiliary contact module | | | | | |
| | Main circuit normally open contact | g | 10 | | |
| | Auxiliary contacts Normally open contact/NC | g | 20/20 | | |
| Protection type | | IP20 | | | |
| Protection against direct contact when actuated from front (EN 50274) | | Finger- and back-of-hand proof | | | |
| Weight | kg | 0.2 | 0.17 | 0.2 | 0.17 |
| Terminal capacity: main and auxiliary contacts | | | | | |
| Solid | mm ² | 1 x (0.75 - 2.5) 2 x (0.75 - 2.5) | | | |
| Flexible with ferrule | mm ² | 1 x (0.75 - 1.5) 2 x (0.75 - 1.5) | | | |
| Solid or stranded | AWG | 18 - 14 | | | |
| Terminal screw | | M3.5 | | | |
| Pozidriv screwdriver | | Size 2 | | | |
| Flat-blade screwdriver | | mm 0.8 x 5.5 1 x 6 | | | |
| Max. tightening torque | | Nm 1.2 | | | |
| Terminal capacity springloaded terminals main and control circuits | | | | | |
| Solid | mm ² | 1 x (1 - 2.5) 2 x (1 - 2.5) | | | |
| Flexible with ferrule | mm ² | 1 x (1 - 2.5) 2 x (1 - 2.5) | | | |
| Flat-blade screwdriver | | mm 0.6 x 3.5 | | | |

1.1

Mini contactor relays

DILEEM, DILEM

1

| | | | | DILEEM DILEEM-G | DILEM DILEM-G | DILEM4 | DILEM4-G | DILEM12 DILEM12-G | |
|--|---|-----------|----------|-----------------------|------------------|--------|----------|----------------------|-----|
| Main contacts | | | | | | | | | |
| Rated impulse withstand voltage | U_{imp} | V AC | | 6000 | 6000 | 6000 | 6000 | 6000 | |
| Overvoltage category/pollution degree | | | | III/3 | III/3 | III/3 | III/3 | III/3 | |
| Rated insulation voltage | U_i | V AC | | 690 | 690 | 690 | 690 | 690 | |
| Rated operating voltage | U_e | V AC | | 690 | 690 | 690 | 690 | 690 | |
| Safe isolation according to EN 61140 | | | | | | | | | |
| Between coil and contacts | | V AC | | 300 | 300 | 300 | 300 | 300 | |
| Between the contacts | | V AC | | 300 | 300 | 300 | 300 | 300 | |
| Making capacity of up to 440 V (cos ϕ as specified in IEC/EN 60947) | | A | | 110 | 110 | 110 | 110 | 120 | |
| Breaking capacity | 220/230 V | A | | 90 | 90 | 90 | 90 | 96 | |
| | 380/400 V | A | | 90 | 90 | 90 | 90 | 96 | |
| | 500 V | A | | 64 | 64 | 64 | 64 | 72 | |
| | 660/690 V | A | | 42 | 42 | 42 | 42 | 42 | |
| Devices lifespan | AC-1 | | | → Engineering Page 88 | | | | | |
| | AC-3 | | | → Engineering Page 87 | | | | | |
| | AC-4 | | | → Engineering Page 87 | | | | | |
| Short-circuit protection rating maximum fuse | | | | | | | | | |
| | Type "2" coordination 500 V | gL/gG | A | 10 | 10 | 10 | 10 | 20 | |
| | Type "1" coordination 500 V | gL/gG | A | 20 | 20 | 20 | 20 | 35 | |
| AC voltage | | | | | | | | | |
| AC-1 operation | | | | | | | | | |
| Conventional thermal current 3 pole 50 - 60 Hz | | | | | | | | | |
| Open | | at 40 °C | I_{th} | A | 22 | 22 | 22 | 22 | |
| | | at 50 °C | I_{th} | A | 20 | 20 | 20 | 20 | |
| | | at 55 °C | I_{th} | A | 19 | 19 | 19 | 19 | |
| Enclosed ¹⁾ | | | I_{th} | A | 16 | 16 | 16 | 16 | |
| Conventional thermal current, 1-pole | | | | | | | | | |
| Open ¹⁾ | | | I_{th} | A | 50 | 50 | 60 | 50 | |
| Enclosed ¹⁾ | | | I_{th} | A | 40 | 40 | 50 | 40 | |
| AC-3 operation | | | | | | | | | |
| Rated operational current AC-3 open, 50 - 60 Hz, 3-pole1) | 220/230 V | I_e | A | 6.6 | 9 | 9 | 9 | 12 | |
| | 240 V | I_e | A | 6.6 | 9 | 9 | 9 | 12 | |
| | 380/400 V | I_e | A | 6.6 | 9 | 9 | 9 | 12 | |
| | 415 V | I_e | A | 6.6 | 9 | 9 | 9 | 12 | |
| | 440 V | I_e | A | 6.6 | 9 | 9 | 9 | 10.5 | |
| | 500 V | I_e | A | 5 | 6.4 | 6.4 | 6.4 | 9 | |
| Motor rating | 660/690 V | I_e | A | 3.5 | 4.8 | 4.8 | 4.8 | 5.2 | |
| | 220/230 V | P | kW | 1.5 | 2.2 | 2.2 | 2.2 | 3.5 | |
| | 240 V | P | kW | 1.8 | 2.5 | 2.5 | 2.5 | 3 | |
| | 380/400 V | P | kW | 3 | 4 | 4 | 4 | 5.5 | |
| | 415 V | P | kW | 3.1 | 4.3 | 4.3 | 4.3 | 5.5 | |
| | 440 V | P | kW | 3.3 | 4.6 | 4.6 | 4.6 | 5.5 | |
| AC-4 operation | 500 V | P | kW | 3 | 4 | 4 | 4 | 5.5 | |
| | 660/690 V | P | kW | 3 | 4 | 4 | 4 | 4 | |
| | Rated operational current AC-4 open, 50 - 60 Hz, 3-pole1) | 220/230 V | I_e | A | 5 | 6.6 | 6.6 | 6.6 | 6.6 |
| | | 240 V | I_e | A | 5 | 6.6 | 6.6 | 6.6 | 6.6 |
| | | 280/400 V | I_e | A | 5 | 6.6 | 6.6 | 6.6 | 6.6 |
| | | 415 V | I_e | A | 5 | 6.6 | 6.6 | 6.6 | 6.6 |
| 440 V | | I_e | A | 5 | 6.6 | 6.6 | 6.6 | 6.6 | |
| 500 V | | I_e | A | 3.7 | 5 | 5 | 5 | 5 | |
| Rated operational power | 660/690 V | I_e | A | 2.9 | 3.4 | 3.4 | 3.4 | 3.4 | |
| | 220/230 V | P | kW | 1.1 | 1.5 | 1.5 | 1.5 | 1.5 | |
| | 240 V | P | kW | 1.3 | 1.8 | 1.8 | 1.8 | 1.8 | |
| | 380/400 V | P | kW | 2.2 | 3 | 3 | 3 | 3 | |
| | 415 V | P | kW | 2.3 | 3.1 | 3.1 | 3.1 | 3.1 | |
| | 440 V | P | kW | 2.4 | 3.3 | 3.3 | 3.3 | 3.3 | |
| 500 V | P | kW | 2.2 | 3 | 3 | 3 | 2.2 | | |
| 660/690 V | P | kW | 2.2 | 3 | 3 | 3 | 2.2 | | |

Notes

¹⁾ At maximum permissible ambient air temperature

DILEEM, DILEM

| | | | | DILEEM | DILEEM-G | DILEM | DILEM-G | DILEM4 | DILEM4-G | DILEM12 | DILEM12-G |
|--|---|---------|-------------------------------|-----------------------|-----------|------------|-----------|------------|------------|-----------|-----------|
| DC voltage | | | | | | | | | | | |
| Operations | | | | → Engineering Page 92 | | | | | | | |
| Rated operational current open | | | | | | | | | | | |
| DC-1 | 12 V | I_e | A | 20 | 20 | 20 | 20 | 20 | 20 | 20 | 20 |
| | 24 V | I_e | A | 20 | 20 | 20 | 20 | 20 | 20 | 20 | 20 |
| | 60 V | I_e | A | 20 | 20 | 20 | 20 | 20 | 20 | 20 | 20 |
| | 110 V | I_e | A | 20 | 20 | 20 | 20 | 20 | 20 | 20 | 20 |
| | 220 V | I_e | A | 20 | 20 | 20 | 20 | 20 | 20 | 20 | 20 |
| DC-3 | 12 V | I_e | A | 6 | 6 | 8 | 8 | 8 | 8 | 8 | 8 |
| | 24 V | I_e | A | 6 | 6 | 8 | 8 | 8 | 8 | 6 | 8 |
| | 60 V | I_e | A | 3 | 3 | 4 | 4 | 4 | 4 | 4 | 4 |
| | 110 V | I_e | A | 2 | 2 | 3 | 3 | 3 | 3 | 3 | 3 |
| | 220 V | I_e | A | – | – | – | – | 1 | 1 | – | – |
| DC-5 | 12 V | I_e | A | 1.8 | 1.8 | 2.5 | 2.5 | 2.5 | 2.5 | 2.5 | 2.5 |
| | 24 V | I_e | A | 1.8 | 1.8 | 2.5 | 2.5 | 2.5 | 2.5 | 2.5 | 2.5 |
| | 60 V | I_e | A | 1.8 | 1.8 | 2.5 | 2.5 | 2.5 | 2.5 | 2.5 | 2.5 |
| | 110 V | I_e | A | 1.8 | 1.8 | 1.5 | 1.5 | 2.5 | 2.5 | 1.5 | 1.5 |
| | 220 V | I_e | A | 0.2 | 0.2 | 0.3 | 0.3 | 1 | 1 | 0.3 | 0.3 |
| Current heat loss (3-pole or 4-pole) | | | | | | | | | | | |
| At I_{th} | | | W | 2 | 3.5 | 2 | 3.5 | 2.7 | 4.7 | 2 | 3.5 |
| At I_e to AC-3/400 V | | | W | 0.5 | 0.7 | 0.5 | 0.7 | – | – | 0.5 | 0.7 |
| Magnet systems | | | | | | | | | | | |
| Voltage tolerance | | | | | | | | | | | |
| Single-voltage coil 50 Hz and dual-voltage coil 50 Hz, 60 Hz | | Pick-up | $x U_c$ | 0.8 - 1.1 | – | 0.8 - 1.1 | – | 0.8 - 1.1 | – | 0.8 - 1.1 | – |
| Dual-frequency coil 50/60 Hz | | Pick-up | $x U_c$ | 0.8 - 1.1 | – | 0.85 - 1.1 | – | 0.85 - 1.1 | – | 0.8 - 1.1 | – |
| DC operated | | Pick-up | $x U_c$ | – | 0.8 - 1.1 | – | 0.8 - 1.1 | – | 0.85 - 1.1 | – | 0.8 - 1.1 |
| Power consumption | | | | | | | | | | | |
| AC operation | Single-voltage coil, 50 Hz, and dual-voltage coil, 50 Hz, 60 Hz | Pick-up | VA | 25 | – | 25 | – | 25 | – | 25 | – |
| | | Pick-up | W | 22 | – | 22 | – | 22 | – | 22 | – |
| | | Sealing | VA | 4.6 | – | 4.6 | – | 4.6 | – | 4.6 | – |
| | | Sealing | W | 1.3 | – | 1.3 | – | 1.3 | – | 1.3 | – |
| | Dual-frequency coil 50/60 Hz at 50 Hz | Pick-up | VA | 30 | – | 30 | – | 30 | – | 30 | – |
| | | Pick-up | W | 26 | – | 26 | – | 26 | – | 26 | – |
| | | Sealing | VA | 5.4 | – | 5.4 | – | 5.4 | – | 5.4 | – |
| | | Sealing | W | 1.6 | – | 1.6 | – | 1.6 | – | 1.6 | – |
| | Dual-frequency coil 50/60 Hz at 60 Hz | Pick-up | VA | 29 | – | 29 | – | 29 | – | 29 | – |
| | | Pick-up | W | 24 | – | 24 | – | 24 | – | 24 | – |
| | | Sealing | VA | 3.9 | – | 3.9 | – | 3.9 | – | 3.9 | – |
| | | Sealing | W | 1.1 | – | 1.1 | – | 1.1 | – | 1.1 | – |
| | Single-voltage coil, 50 Hz, and dual-voltage coil, 50 Hz, 60 Hz | Pick-up | VA | 25 | – | 25 | – | 25 | – | 25 | – |
| | | Pick-up | VA | 30 | – | 30 | – | 30 | – | 30 | – |
| Pick-up | | VA | 29 | – | 29 | – | 29 | – | 29 | – | |
| Pick-up | | VA | 29 | – | 29 | – | 29 | – | 29 | – | |
| DC operation ¹⁾ | Power consumption pick-up = sealing | | VA/W | – | 2.6 | – | 2.6 | – | 2.6 | – | 2.6 |
| Duty fac tor | | | % DF | 100 | 100 | 100 | 100 | 100 | 100 | 100 | 100 |
| Switching times at 100 % U_c | | | | | | | | | | | |
| N/O | Closing delay min. | | ms | 14 | 26 | 14 | 26 | 14 | 26 | 14 | 26 |
| | Closing delay max. | | ms | 21 | 35 | 21 | 35 | 21 | 35 | 21 | 35 |
| | Opening delay min. | | ms | 8 | 15 | 8 | 15 | 8 | 15 | 8 | 15 |
| | Opening delay max. | | ms | 18 | 25 | 18 | 25 | 18 | 25 | 18 | 25 |
| | Closing delay with top mounting auxiliary contact | | ms | Max. 45 | Max. 70 | Max. 45 | Max. 70 | Max. 45 | Max. 70 | Max. 45 | Max. 70 |
| Reversing con- | Changeover time at 110 % U_c factors | | | | | | | | | | |
| | Changeover time min. | | ms | 16 | 40 | 16 | 40 | 16 | 40 | 16 | 40 |
| | Changeover time maX. | | ms | 21 | 50 | 21 | 50 | 21 | 50 | 21 | 50 |
| Arcing time at 690 V AC | | ms | Max. 12 | Max. 12 | Max. 12 | Max. 12 | Max. 12 | Max. 12 | Max. 12 | Max. 12 | Max. 12 |
| Coil | Lifespan, mechanical; Coil 50/60 Hz | | c(contacts) x 10 ⁶ | 7 | – | 7 | – | 7 | – | 7 | – |

Notes

¹⁾ Smoothed DC or three-phase bridge rectifier

1.1 Mini contactor relays

DILEEM, DILEM

1

| | | DILE(E)M(-12)... | | ...DILEM |
|---|--|-------------------|---------------|--|
| Auxiliary contact | | | | |
| Interlocked opposing contacts to EN 60947-5-1 Annex L, including auxiliary contact module | | Yes | | Yes |
| Rated impulse withstand voltage | U_{imp} | V AC | 6000 | 6000 |
| Overvoltage category/pollution degree | | III/3 | | III/3 |
| Rated insulation voltage | U_i | V AC | 690 | 690 |
| Rated operating voltage | U_e | V AC | 600 | 600 |
| Safe isolation according to EN 61140 | | | | |
| Between coil and auxiliary contacts | | V AC | 300 | 300 |
| Between the auxiliary contacts | | V AC | 300 | 300 |
| Rated operational current | | | | |
| AC-15 | | | | |
| | 220/240 V | I_e | A | 6 |
| | 380/415 V | I_e | A | 3 |
| | 500 V | I_e | A | 1.5 |
| DC | $L/R \leq 15$ ms | | | |
| Contacts in series: | | | | |
| | 1 | 24 V | A | 2.5 |
| | 2 | 60 V | A | 2.5 |
| | 3 | 100 V | A | 1.5 |
| | 3 | 220 V | A | 0.5 |
| Conventional thermal current | | I_{th} | A | 10 |
| Control circuit reliability (at $U_e = 24$ V DC, $U_{min} = 17$ V, $I_{min} = 5.4$ mA) | | Fault probability | λ | $<10^{-8}$, < one failure in 100 million operations |
| Component lifespan at $U_e = 240$ V | | | | |
| AC-15 | | c (contacts) | $\times 10^6$ | 0.2 |
| DC ¹⁾ | | | | |
| | $L/R = 50$ ms: 2 contacts in series at $I_e = 0.5$ A | c (contacts) | $\times 10^6$ | 0.15 |
| Short-circuit rating without welding | | | | |
| Maximum overcurrent protective device | | PKZM0-4 | | PKZM0-4 |
| Short-circuit protection rating maximum fuse | | | | |
| | 500 V | A gG/gL | 6 | 6 |
| | 500 V | A fast | 10 | 10 |
| Current heat loss at load of I_{th} | | | | |
| | Per contact | W | 0.2 | 0.2 |

Notes ¹⁾ Switch-on and switch-off conditions based on DC-13, time constant as specified

DILM7 ... DILM170

1

| | | | DILM7 | DILM9 | DILM12 | DILM15 | DILM17 | DILM25 |
|---|-----------------|--------------------------------------|--|----------|----------|----------|--------------------------------------|----------|
| General | | | | | | | | |
| Standards | | | IEC/EN 60947, VDE 0660, UL, CSA | | | | | |
| Lifespan, mechanical | | | | | | | | |
| AC operated | c (contacts) | x 10 ⁶ | 10 | 10 | 10 | 10 | 10 | 10 |
| DC operated | c (contacts) | x 10 ⁶ | 10 | 10 | 10 | 10 | 10 | 10 |
| Operating frequency, mechanical | | | | | | | | |
| Mechanical, AC operated | Operations/h | | 9000 | 9000 | 9000 | 5000 | 5000 | 5000 |
| DC operated | Operations/h | | 9000 | 9000 | 9000 | 5000 | 5000 | 5000 |
| Maximum operating frequency | | | | | | | | |
| Electrical (Contactor without overload relay) | | | → Characteristic curves Page 74 | | | | | |
| Climatic proofing | | | | | | | | |
| | | | Damp heat, constant, to IEC 60068-2-78 Damp heat, cyclic, to IEC 60068-2-30 | | | | | |
| Ambient temperature | | | | | | | | |
| Open | °C | | -25...60 | -25...60 | -25...60 | -25...60 | -25...60 | -25...60 |
| Enclosed | °C | | -25...40 | -25...40 | -25...40 | -25...40 | -25...40 | -25...40 |
| Storage | °C | | -40 - 80 | -40 - 80 | -40 - 80 | -40 - 80 | -40 - 80 | -40 - 80 |
| Mounting position AC- and DC operated | | | | | | | | |
| Mechanical shock resistance (IEC/EN 60068-2-27) | | | | | | | | |
| Half-sinusoidal shock 10 ms | | | | | | | | |
| Main contacts | | | | | | | | |
| | N/O | g | 10 | 10 | 10 | 10 | 10 | 10 |
| Auxiliary contacts | | | | | | | | |
| | N/O | g | 7 | 7 | 7 | 7 | 7 | 7 |
| | NC | g | 5 | 5 | 5 | 5 | 5 | 5 |
| Mechanical shock resistance (IEC/EN 60068-2-27) with table mounting | | | | | | | | |
| Half-sinusoidal shock 10 ms | | | | | | | | |
| Main contacts | | | | | | | | |
| | N/O | g | 5.7 | 5.7 | 5.7 | 5.7 | 6.9 | 6.9 |
| Auxiliary contacts | | | | | | | | |
| | N/O | g | 3.4 | 3.4 | 3.4 | 3.4 | 5.3 | 5.3 |
| | NC | g | 3.4 | 3.4 | 3.4 | 3.4 | 3.5 | 3.5 |
| Protection type | | | IP20 IP20 IP20 IP20 IP00 IP00 | | | | | |
| Protection against direct contact when actuated from front (EN 50274) | | | Finger- and back-of-hand proof | | | | | |
| Weight | | | | | | | | |
| AC operated | kg | | 0.23 | 0.23 | 0.23 | 0.23 | 0.42 | 0.42 |
| DC operated | kg | | 0.28 | 0.28 | 0.28 | 0.28 | 0.48 | 0.48 |
| Terminal type, screw connection | | | | | | | | |
| Terminal capacity of main cable | | | | | | | | |
| Solid | mm ² | | 1 x (0.75 - 4) 2 x (0.75 - 2.5) | | | | 1 x (0.75 - 16) 2 x (0.75 - 10) | |
| Flexible with ferrule | mm ² | | 1 x (0.75 - 2.5) 2 x (0.75 - 2.5) ¹⁾ | | | | 1 x (0.75 - 16) 2 x (0.75 - 10) | |
| Stranded | mm ² | | - | | | | 1 x 16 1 x 16 | |
| Solid or stranded | AWG | | 18 - 10 18 - 10 18 - 10 18 - 10 | | | | 18 - 6 18 - 6 | |
| Flat conductor | mm | Number of layers x width x thickness | - | | | | - | |
| Terminal capacity of control circuit cable | | | | | | | | |
| Solid | mm ² | | 1 x (0.75 - 4) 2 x (0.75 - 2.5) | | | | 1 x (0.75 - 4) 2 x (0.75 - 4) | |
| Flexible with ferrule | mm ² | | 1 x (0.75 - 2.5) 2 x (0.75 - 2.5) | | | | 1 x (0.75 - 2.5) 2 x (0.75 - 2.5) | |
| Solid or stranded | AWG | | 18 - 10 18 - 10 18 - 10 18 - 10 | | | | 18 - 14 18 - 14 | |

Notes

¹⁾ Also without ferrule.

| DILM32 | DILM38 | DILM40 | DILM50 | DILM65 | DILM72 | DILM80 | DILM95 | DILM115 | DILM150 | DILM170 |
|--------|--------|--------|--------|--------|--------|--------|--------|---------|---------|---------|
|--------|--------|--------|--------|--------|--------|--------|--------|---------|---------|---------|

IEC/EN 60947, VDE 0660, UL, CSA

| | | | | | | | | | | |
|------|------|------|------|------|------|------|------|------|------|------|
| 10 | 10 | 10 | 10 | 10 | 10 | 10 | 10 | 10 | 10 | 10 |
| 10 | 10 | 10 | 10 | 10 | 10 | 10 | 10 | 10 | 10 | 10 |
| 5000 | 5000 | 5000 | 5000 | 5000 | 5000 | 3600 | 3600 | 3600 | 3600 | 3000 |
| 5000 | 5000 | 5000 | 5000 | 5000 | 5000 | 3600 | 3600 | 3600 | 3600 | 3000 |

→ Characteristic curves Page 74

Damp heat, constant, to IEC 60068-2-78

Damp heat, cyclic, to IEC 60068-2-30

| | | | | | | | | | | |
|----------|----------|----------|----------|----------|----------|----------|----------|----------|----------|----------|
| -25...60 | -25...60 | -25...60 | -25...60 | -25...60 | -25...60 | -25...60 | -25...60 | -25...60 | -25...60 | -25...60 |
| -25...40 | -25...40 | -25...40 | -25...40 | -25...40 | -25...40 | -25...40 | -25...40 | -25...40 | -25...40 | -25...40 |
| -40 - 80 | -40 - 80 | -40 - 80 | -40 - 80 | -40 - 80 | -40 - 80 | -40 - 80 | -40 - 80 | -40 - 80 | -40 - 80 | -40 - 80 |

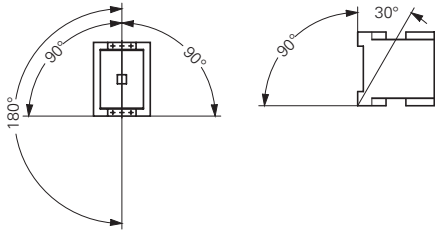

| | | | | | | | | | | |
|----|----|----|----|----|----|----|----|----|----|----|
| 10 | 10 | 10 | 10 | 10 | 10 | 10 | 10 | 10 | 10 | 10 |
| 7 | 7 | 7 | 7 | 7 | 7 | 7 | 7 | 7 | 7 | 7 |
| 5 | 5 | 5 | 5 | 5 | 5 | 5 | 5 | 5 | 5 | 5 |

| | | | | | | | | | | |
|------|------|------|------|------|------|------|------|------|------|------|
| 6.9 | 6.9 | 10 | 10 | 10 | 10 | 10 | 10 | 10 | 10 | 10 |
| 5.3 | 5.3 | 7 | 7 | 7 | 7 | 7 | 7 | 7 | 7 | 7 |
| 3.5 | 3.5 | 5 | 5 | 5 | 5 | 5 | 5 | 5 | 5 | 5 |
| IP00 | IP00 | IP00 | IP00 | IP00 | IP00 | IP00 | IP00 | IP00 | IP00 | IP00 |

Finger- and back-of-hand proof

| | | | | | | | | | | |
|------|------|-----|-----|-----|-----|-----|-----|-----|-----|-----|
| 0.42 | 0.42 | 0.9 | 0.9 | 0.9 | 0.9 | 2 | 2 | 2 | 2 | 2 |
| 0.48 | 0.48 | 1.1 | 1.1 | 1.1 | 1.1 | 2.1 | 2.1 | 2.1 | 2.1 | 2.1 |

| | | | | | | | | | | |
|------------------------------------|--------|------------------------------------|--------|--------|--------|--------------------------------|---------|---------|---------|---------|
| 1 x (0.75 - 16) 2 x (0.75 - 10) | | 1 x (0.75 - 16) 2 x (0.75 - 16) | | | | | | | | |
| 1 x (0.75 - 16) 2 x (0.75 - 10) | | 1 x (0.75 - 35) 2 x (0.75 - 25) | | | | 1 x (10 - 95) 2 x (10 - 70) | | | | |
| 1 x 16 | 1 x 16 | 1 x (16 - 50) 2 x (16 - 35) | | | | 1 x (16 - 95) 2 x (16 - 70) | | | | |
| 18 - 6 | 18 - 6 | 12 - 2 | 12 - 2 | 12 - 2 | 12 - 2 | 8...3/0 | 8...3/0 | 8...3/0 | 8...3/0 | 8...3/0 |
| - | - | 2 x (6 x 9 x 0.8) | | | | 2 x (6 x 16 x 0.8) | | | | |

1 x (0.75 - 4)
2 x (0.75 - 4)
1 x (0.75 - 2.5)
2 x (0.75 - 2.5)

| | | | | | | | | | | |
|---------|---------|---------|---------|---------|---------|---------|---------|---------|---------|---------|
| 18 - 14 | 18 - 14 | 18 - 14 | 18 - 14 | 18 - 14 | 18 - 14 | 18 - 14 | 18 - 14 | 18 - 14 | 18 - 14 | 18 - 14 |
|---------|---------|---------|---------|---------|---------|---------|---------|---------|---------|---------|

1 DILM7 ... DILM170

| | | | DILM7 | DILM9 | DILM12 | DILM15 | DILM17 | DILM25 |
|--|-----------|-----------------|--------------------------------------|--------------------|--------------------|--------------------|--------------------|--------------------|
| General | | | | | | | | |
| Main cable connection screw/bolt | | | M3.5 | M3.5 | M3.5 | M3.5 | M5 | M5 |
| Tightening torque | Nm | | 1.2 | 1.2 | 1.2 | 1.2 | 3.2 | 3.2 |
| Control circuit cable connection screw/bolt | | | M3.5 | M3.5 | M3.5 | M3.5 | M3.5 | M3.5 |
| Tightening torque | Nm | | 1.2 | 1.2 | 1.2 | 1.2 | 1.2 | 1.2 |
| Tools | | | | | | | | |
| Main conductors | | | | | | | | |
| Pozidriv screwdriver | | Size | 2 | 2 | 2 | 2 | 2 | 2 |
| Internal hexagon | SW | mm | – | – | – | – | – | – |
| Flat-blade screwdriver | | mm | 0.8 x 5.5 1 x 6 | 0.8 x 5.5 1 x 6 | 0.8 x 5.5 1 x 6 | 0.8 x 5.5 1 x 6 | 0.8 x 5.5 1 x 6 | 0.8 x 5.5 1 x 6 |
| Auxiliary conductors | | | | | | | | |
| Pozidriv screwdriver | | Size | 2 | 2 | 2 | 2 | 2 | 2 |
| Flat-blade screwdriver | | mm | 0.8 x 5.5 1 x 6 | 0.8 x 5.5 1 x 6 | 0.8 x 5.5 1 x 6 | 0.8 x 5.5 1 x 6 | 0.8 x 5.5 1 x 6 | 0.8 x 5.5 1 x 6 |
| Terminal type spring-cage terminal | | | | | | | | |
| Terminal capacity of main cable | | | | | | | | |
| Solid | | mm ² | 1 x (0.75 - 2.5) 2 x (0.75 - 2.5) | | | | – | – |
| Flexible | | mm ² | 1 x (0.75 - 2.5) 2 x (0.75 - 2.5) | | | | – | – |
| Flexible with ferrule | | mm ² | 1 x (0.75 - 1.5) 2 x (0.75 - 1.5) | | | | – | – |
| Flexible without ferrule | | mm ² | 1 x (0.75 - 2.5) 2 x (0.75 - 2.5) | | | | – | – |
| Solid or stranded | | AWG | 18 - 14 | 18 - 14 | 18 - 14 | 18 - 14 | – | – |
| Terminal capacity of control circuit cable | | | | | | | | |
| Solid | | mm ² | 1 x (0.75 - 2.5) 2 x (0.75 - 2.5) | | | | | |
| Flexible | | mm ² | 1 x (0.75 - 2.5) 2 x (0.75 - 2.5) | | | | | |
| Flexible with ferrule | | mm ² | 1 x (0.75 - 1.5) 2 x (0.75 - 1.5) | | | | | |
| Flexible without ferrule | | mm ² | 1 x (0.75 - 2.5) 2 x (0.75 - 2.5) | | | | – | – |
| Solid or stranded | | AWG | 18 - 14 | 18 - 14 | 18 - 14 | 18 - 14 | 18 - 14 | 18 - 14 |
| Tools | | | | | | | | |
| Strip length | | mm | 10 | 10 | 10 | 10 | 10 | 10 |
| Screwdriver blade width | | mm | 3.5 | 3.5 | 3.5 | 3.5 | 3.5 | 3.5 |
| Main contacts | | | | | | | | |
| Rated impulse withstand voltage | U_{imp} | V AC | 8000 | 8000 | 8000 | 8000 | 8000 | 8000 |
| Overvoltage category/pollution degree | | | III/3 | III/3 | III/3 | III/3 | III/3 | III/3 |
| Rated insulation voltage | U_i | V AC | 690 | 690 | 690 | 690 | 690 | 690 |
| Rated operating voltage | U_e | V AC | 690 | 690 | 690 | 690 | 690 | 690 |
| Safe isolation according to EN 61140 | | | | | | | | |
| Between coil and contacts | | V AC | 400 | 400 | 400 | 400 | 440 | 440 |
| Between the contacts | | V AC | 400 | 400 | 400 | 400 | 440 | 440 |
| Making capacity (cos Φ to IEC/EN 60947) | To 690 V | A | 112 | 112 | 144 | 155 | 238 | 350 |
| Breaking capacity | | | | | | | | |
| 230 V | | A | 70 | 90 | 120 | 124 | 170 | 250 |
| 280/400 V | | A | 70 | 90 | 120 | 124 | 170 | 250 |
| 500 V | | A | 50 | 70 | 100 | 100 | 170 | 250 |
| 660/690 V | | A | 40 | 50 | 70 | 70 | 120 | 150 |
| Short-circuit rating | | | | | | | | |
| Short-circuit protection rating maximum fuse | | | | | | | | |
| Type "2" coordination | | | | | | | | |
| 400 V | | gG/gL 500 V | A | 20 | 20 | 20 | 20 | 35 |
| 690 V | | gG/gL 690 V | A | 16 | 16 | 20 | 20 | 35 |
| Type "1" coordination | | | | | | | | |
| 400 V | | gG/gL 500 V | A | 35 | 35 | 35 | 63 | 100 |
| 690 V | | gG/gL 690 V | A | 20 | 20 | 25 | 50 | 50 |

| DILM32 | DILM38 | DILM40 | DILM50 | DILM65 | DILM72 | DILM80 | DILM95 | DILM115 | DILM150 | DILM170 |
|--------------------------------------|--------------------|--------------------|--------------------|--------------------|--------------------|--------------------|--------------------|--------------------|--------------------|--------------------|
| M5 | M5 | M6 | M6 | M6 | M6 | M10 | M10 | M10 | M10 | M10 |
| 3.2 | 3.2 | 3.3 | 3.3 | 3.3 | 3.3 | 14 | 14 | 14 | 14 | 14 |
| M3.5 | M3.5 | M3.5 | M3.5 | M3.5 | M3.5 | M3.5 | M3.5 | M3.5 | M3.5 | M3.5 |
| 1.2 | 1.2 | 1.2 | 1.2 | 1.2 | 1.2 | 1.2 | 1.2 | 1.2 | 1.2 | 1.2 |
| 2 | 2 | 2 | 2 | 2 | 2 | – | – | – | – | – |
| – | – | – | – | – | – | 5 | 5 | 5 | 5 | 5 |
| 0.8 x 5.5 1 x 6 | 0.8 x 5.5 1 x 6 | 0.8 x 5.5 1 x 6 | 0.8 x 5.5 1 x 6 | 0.8 x 5.5 1 x 6 | 0.8 x 5.5 1 x 6 | – | – | – | – | – |
| 2 | 2 | 2 | 2 | 2 | 2 | 2 | 2 | 2 | 2 | 2 |
| 0.8 x 5.5 1 x 6 | 0.8 x 5.5 1 x 6 | 0.8 x 5.5 1 x 6 | 0.8 x 5.5 1 x 6 | 0.8 x 5.5 1 x 6 | 0.8 x 5.5 1 x 6 | 0.8 x 5.5 1 x 6 | 0.8 x 5.5 1 x 6 | 0.8 x 5.5 1 x 6 | 0.8 x 5.5 1 x 6 | 0.8 x 5.5 1 x 6 |
| – | – | – | – | – | – | – | – | – | – | – |
| – | – | – | – | – | – | – | – | – | – | – |
| – | – | – | – | – | – | – | – | – | – | – |
| – | – | – | – | – | – | – | – | – | – | – |
| – | – | – | – | – | – | – | – | – | – | – |
| – | – | – | – | – | – | – | – | – | – | – |
| 1 x (0.75 - 2.5) 2 x (0.75 - 2.5) | | | | | | | | | | |
| 1 x (0.75 - 2.5) 2 x (0.75 - 2.5) | | | | | | | | | | |
| 1 x (0.75 - 1.5) 2 x (0.75 - 1.5) | | | | | | | | | | |
| – | – | – | – | – | – | – | – | – | – | – |
| 18 - 14 | 18 - 14 | 18 - 14 | 18 - 14 | 18 - 14 | 18 - 14 | 18 - 14 | 18 - 14 | 18 - 14 | 18 - 14 | 18 - 14 |
| 10 | 10 | 10 | 10 | 10 | 10 | 10 | 10 | 10 | 10 | 10 |
| 3.5 | 3.5 | 3.5 | 3.5 | 3.5 | 3.5 | 3.5 | 3.5 | 3.5 | 3.5 | 3.5 |
| 8000 | 8000 | 8000 | 8000 | 8000 | 8000 | 8000 | 8000 | 8000 | 8000 | 8000 |
| III/3 | III/3 | III/3 | III/3 | III/3 | III/3 | III/3 | III/3 | III/3 | III/3 | III/3 |
| 690 | 690 | 690 | 690 | 690 | 690 | 690 | 690 | 690 | 690 | 690 |
| 690 | 690 | 690 | 690 | 690 | 690 | 690 | 690 | 690 | 690 | 690 |
| 440 | 440 | 440 | 440 | 440 | 440 | 690 | 690 | 690 | 690 | 690 |
| 440 | 440 | 440 | 440 | 440 | 440 | 690 | 690 | 690 | 690 | 690 |
| 384 | 384 | 560 | 700 | 910 | 910 | 1120 | 1330 | 1610 | 2100 | 2100 |
| 320 | 320 | 400 | 500 | 650 | 650 | 800 | 950 | 1150 | 1500 | 1500 |
| 320 | 320 | 400 | 500 | 650 | 650 | 800 | 950 | 1150 | 1500 | 1500 |
| 320 | 320 | 400 | 500 | 650 | 650 | 800 | 950 | 1150 | 1500 | 1500 |
| 180 | 180 | 250 | 320 | 370 | 370 | 650 | 800 | 1100 | 1200 | 1320 |
| 63 | 63 | 63 | 80 | 125 | 125 | 160 | 160 | 250 | 250 | 250 |
| 35 | 35 | 50 | 63 | 80 | 80 | 160 | 160 | 250 | 250 | 250 |
| 125 | 125 | 125 | 160 | 250 | 250 | 250 | 250 | 250 | 250 | 250 |
| 63 | 63 | 80 | 80 | 100 | 100 | 200 | 200 | 250 | 250 | 250 |

1.1

Contactors

Basic devices up to 170 A

1 DILM7 ... DILM170

| | | | | DILM7 | DILM9 | DILM12 | DILM15 | DILM17 | DILM25 | |
|--|-----------|----------|----------|-----------------------------------|-------|--------|--------|--------|--------|------|
| AC voltage | | | | | | | | | | |
| AC-1 operation | | | | | | | | | | |
| Conventional free air thermal current 3 pole 50 - 60 Hz | Open | at 50 °C | I_{th} | A | 22 | 22 | 22 | 22 | 40 | 45 |
| | | at 50 °C | I_{th} | A | 21 | 21 | 21 | 21 | 38 | 43 |
| | Enclosed | at 55 °C | I_{th} | A | 21 | 21 | 21 | 21 | 37 | 42 |
| | | at 60 °C | I_{th} | A | 20 | 20 | 20 | 20 | 35 | 40 |
| Conventional free air thermal current 1 pole | Open | | I_{th} | A | 50 | 50 | 50 | 50 | 88 | 100 |
| | Enclosed | | I_{th} | A | 45 | 45 | 45 | 45 | 80 | 90 |
| AC-3 operation | | | | | | | | | | |
| Rated operational current AC -3 open, 50 - 60 Hz, 3 pole | 220/230 V | | I_e | A | 7 | 9 | 12 | 15.5 | 18 | 25 |
| | 240 V | | I_e | A | 7 | 9 | 12 | 15.5 | 18 | 25 |
| | 380/400 V | | I_e | A | 7 | 9 | 12 | 15.5 | 18 | 25 |
| | 415 V | | I_e | A | 7 | 9 | 12 | 15.5 | 18 | 25 |
| | 440 V | | I_e | A | 7 | 9 | 12 | 15.5 | 18 | 25 |
| | 500 V | | I_e | A | 5 | 7 | 10 | 12.5 | 18 | 25 |
| | 660/690 V | | I_e | A | 4 | 5 | 7 | 9 | 12 | 15 |
| Rated operational power | 220/230 V | | P | kW | 2.2 | 2.5 | 3.5 | 4 | 5 | 7.5 |
| | 240 V | | P | kW | 2.2 | 3 | 4 | 4.6 | 5.5 | 8.5 |
| | 380/400 V | | P | kW | 3 | 4 | 5.5 | 7.5 | 7.5 | 11 |
| | 415 V | | P | kW | 4 | 5.5 | 7 | 8 | 10 | 14.5 |
| | 440 V | | P | kW | 4.5 | 5.5 | 7.5 | 8.4 | 10.5 | 15.5 |
| | 500 V | | P | kW | 3.5 | 4.5 | 7 | 7.5 | 12 | 17.5 |
| | 660/690 V | | P | kW | 3.5 | 4.5 | 6.5 | 7 | 11 | 14 |
| AC-4 operation | | | | | | | | | | |
| Rated operational current AC-4 open, 50 - 60 Hz, 3 pole | 220/230 V | | I_e | A | 5 | 6 | 7 | 7 | 10 | 13 |
| | 240 V | | I_e | A | 5 | 6 | 7 | 7 | 10 | 13 |
| | 380/400 V | | I_e | A | 5 | 6 | 7 | 7 | 10 | 13 |
| | 415 V | | I_e | A | 5 | 6 | 7 | 7 | 10 | 13 |
| | 440 V | | I_e | A | 5 | 6 | 7 | 7 | 10 | 13 |
| | 500 V | | I_e | A | 4.5 | 5 | 6 | 6 | 10 | 13 |
| | 660/690 V | | I_e | A | 4 | 4.5 | 5 | 5 | 8 | 10 |
| Rated operational power | 220/230 V | | P | kW | 1 | 1.5 | 2 | 2 | 2.5 | 3.5 |
| | 240 V | | P | kW | 1.5 | 1.6 | 2.2 | 2.2 | 3 | 4 |
| | 380/400 V | | P | kW | 2.2 | 2.5 | 3 | 3 | 4.5 | 6 |
| | 415 V | | P | kW | 2.3 | 2.8 | 3.4 | 3.4 | 5 | 6.5 |
| | 440 V | | P | kW | 2.4 | 3 | 3.6 | 3.6 | 5.5 | 7 |
| | 500 V | | P | kW | 2.5 | 2.8 | 3.5 | 3.5 | 6 | 8 |
| | 660/690 V | | P | kW | 2.9 | 3.6 | 4.4 | 4.4 | 6.5 | 8.5 |
| DC voltage | | | | | | | | | | |
| Operations | | | | → Switching of DC current Page 92 | | | | | | |
| Rated operational current I_e open | | | | | | | | | | |
| DC-1 operation | 60 V | | I_e | A | 20 | 20 | 20 | 20 | 35 | 40 |
| | 110 V | | I_e | A | 20 | 20 | 20 | 20 | 35 | 40 |
| | 220 V | | I_e | A | 15 | 15 | 15 | 15 | 35 | 40 |
| | 440 V | | I_e | A | 1 | 1.3 | 1.3 | 1.3 | 2.9 | 2.9 |
| DC-3 operation | 660 V | | I_e | A | 20 | 20 | 20 | 20 | 35 | 35 |
| | 110 V | | I_e | A | 20 | 20 | 20 | 20 | 35 | 35 |
| | 220 V | | I_e | A | 1.5 | 1.5 | 1.5 | 1.5 | 10 | 10 |
| | 440 V | | I_e | A | 0.2 | 0.2 | 0.2 | 0.2 | 0.6 | 0.6 |
| DC-5 operation | 60 V | | I_e | A | 20 | 20 | 20 | 20 | 35 | 35 |
| | 110 V | | I_e | A | 20 | 20 | 20 | 20 | 35 | 35 |
| | 220 V | | I_e | A | 1.5 | 1.5 | 1.5 | 1.5 | 10 | 10 |
| | 440 V | | I_e | A | 0.2 | 0.2 | 0.2 | 0.2 | 0.6 | 0.6 |

| DILM32 | DILM38 | DILM40 | DILM50 | DILM65 | DILM72 | DILM80 | DILM95 | DILM115 | DILM150 | DILM170 |
|--------|--------|--------|--------|--------|--------|--------|--------|---------|---------|---------|
| 45 | 45 | 60 | 80 | 98 | 98 | 110 | 130 | 160 | 190 | 225 |
| 43 | 43 | 57 | 71 | 88 | 88 | 98 | 125 | 142 | 180 | 200 |
| 42 | 42 | 55 | 68 | 83 | 83 | 94 | 115 | 135 | 170 | 190 |
| 40 | 40 | 50 | 65 | 80 | 80 | 90 | 110 | 130 | 160 | 185 |
| 36 | 36 | 45 | 58 | 72 | 72 | 80 | 100 | 115 | 144 | 166 |
| 100 | 100 | 125 | 162 | 200 | 200 | 225 | 275 | 325 | 400 | 460 |
| 90 | 90 | 112 | 145 | 180 | 180 | 200 | 250 | 285 | 360 | 415 |
| 32 | 38 | 40 | 50 | 65 | 72 | 80 | 95 | 115 | 150 | 170 |
| 32 | 38 | 40 | 50 | 65 | 72 | 80 | 95 | 115 | 150 | 170 |
| 32 | 38 | 40 | 50 | 65 | 72 | 80 | 95 | 115 | 150 | 170 |
| 32 | 38 | 40 | 50 | 65 | 72 | 80 | 95 | 115 | 150 | 170 |
| 32 | 38 | 40 | 50 | 65 | 72 | 80 | 95 | 115 | 150 | 170 |
| 32 | 38 | 40 | 50 | 65 | 72 | 80 | 95 | 115 | 150 | 170 |
| 18 | 22.5 | 25 | 32 | 37 | 37 | 65 | 80 | 93 | 100 | 150 |
| 10 | 11 | 12.5 | 15.5 | 20 | 22 | 25 | 30 | 37 | 48 | 52 |
| 11 | 12 | 13.5 | 17 | 22 | 25 | 27.5 | 32 | 40 | 52 | 57 |
| 15 | 18.5 | 18.5 | 22 | 30 | 37 | 37 | 45 | 55 | 75 | 90 |
| 19 | 20 | 24 | 30 | 39 | 41 | 48 | 57 | 70 | 91 | 100 |
| 20 | 21 | 25 | 32 | 41 | 44 | 51 | 60 | 75 | 95 | 105 |
| 23 | 24 | 28 | 36 | 47 | 50 | 58 | 70 | 85 | 110 | 120 |
| 17 | 21 | 23 | 30 | 35 | 35 | 63 | 75 | 90 | 96 | 140 |
| 15 | 15 | 18 | 21 | 25 | 25 | 40 | 50 | 55 | 65 | 65 |
| 15 | 15 | 18 | 21 | 25 | 25 | 40 | 50 | 55 | 65 | 65 |
| 15 | 15 | 18 | 21 | 25 | 25 | 40 | 50 | 55 | 65 | 65 |
| 15 | 15 | 18 | 21 | 25 | 25 | 40 | 50 | 55 | 65 | 65 |
| 15 | 15 | 18 | 21 | 25 | 25 | 40 | 50 | 55 | 65 | 65 |
| 12 | 12 | 14 | 17 | 20 | 20 | 27 | 37 | 45 | 50 | 50 |
| 4 | 4 | 5 | 6 | 7 | 7 | 12 | 16 | 17 | 20 | 20 |
| 4.5 | 4.5 | 5.5 | 6.5 | 7.5 | 7.5 | 13 | 17 | 19 | 22 | 22 |
| 7 | 7 | 9 | 10 | 12 | 12 | 20 | 26 | 28 | 33 | 33 |
| 7.5 | 7.5 | 9.5 | 11 | 13 | 13 | 24 | 30 | 33 | 39 | 39 |
| 8 | 8 | 10 | 12 | 14 | 14 | 25 | 32 | 35 | 41 | 41 |
| 9 | 9 | 11 | 13 | 16 | 16 | 29 | 36 | 40 | 47 | 47 |
| 10 | 10 | 12 | 14 | 17 | 17 | 26 | 35 | 43 | 48 | 48 |
| 40 | 40 | 50 | 60 | 72 | 72 | 110 | 110 | 160 | 160 | 160 |
| 40 | 40 | 50 | 50 | 72 | 72 | 110 | 110 | 160 | 160 | 160 |
| 40 | 40 | 45 | 45 | 65 | 65 | 70 | 70 | 90 | 90 | 90 |
| 2.9 | 2.9 | 2.9 | 2.9 | 2.9 | 2.9 | 4.5 | 4.5 | 4.5 | 4.5 | 4.5 |
| 40 | 40 | 50 | 60 | 72 | 72 | 110 | 110 | 160 | 160 | 160 |
| 40 | 40 | 50 | 50 | 72 | 72 | 110 | 110 | 160 | 160 | 160 |
| 25 | 25 | 25 | 25 | 35 | 35 | 35 | 35 | 40 | 40 | 40 |
| 0.6 | 0.6 | 0.6 | 0.6 | 0.6 | 0.6 | 1 | 1 | 1 | 1 | 1 |
| 40 | 40 | 50 | 60 | 72 | 72 | 110 | 110 | 160 | 160 | 160 |
| 40 | 40 | 50 | 50 | 72 | 72 | 110 | 110 | 160 | 160 | 160 |
| 10 | 10 | 25 | 25 | 35 | 35 | 35 | 35 | 40 | 40 | 40 |
| 0.6 | 0.6 | 0.6 | 0.6 | 0.6 | 0.6 | 1 | 1 | 1 | 1 | 1 |

1 DILM7 ... DILM170

| | | | DILM7 | DILM9 | DILM12 | DILM15 | DILM17 | DILM25 |
|---|---------------|---------|--|-------------------------|-------------------------|-------------------------|-------------------------|-------------------------|
| Current heat loss (3 pole) | | | | | | | | |
| Current heat loss at I_{th} | W | | 3 | 3 | 3 | 3 | 7.3 | 9.6 |
| Current heat loss at I_e to AC-3/400 V | W | | 0.37 | 0.6 | 1.1 | 1.8 | 1.9 | 3.8 |
| Impedance per pole | mΩ | | 2.5 | 2.5 | 2.5 | 2.5 | 2 | 2 |
| Magnet systems | | | | | | | | |
| Voltage tolerance | | | | | | | | |
| AC operated | Pick-up | x U_c | 0.8 - 1.1 | 0.8 - 1.1 | 0.8 - 1.1 | 0.8 - 1.1 | 0.8 - 1.1 | 0.8 - 1.1 |
| AC operated | Drop-out | x U_c | 0.3 - 0.6 | 0.3 - 0.6 | 0.3 - 0.6 | 0.3 - 0.6 | 0.3 - 0.6 | 0.3 - 0.6 |
| DC operated ³⁾ | Pick-up | x U_c | 0.8 - 1.1 | 0.8 - 1.1 ¹⁾ | 0.8 - 1.1 ¹⁾ | 0.8 - 1.1 ¹⁾ | 0.7 - 1.2 ²⁾ | 0.7 - 1.2 ²⁾ |
| DC operated ³⁾ | Drop-out | x U_c | 0.15 - 0.6 | 0.15 - 0.6 | 0.15 - 0.6 | 0.15 - 0.6 | 0.15 - 0.6 | 0.15 - 0.6 |
| Power consumption of the coil in a cold state and 1.0 x U_c | | | | | | | | |
| 50 Hz | Pick-up | VA | 24 | 24 | 24 | 24 | 52 | 52 |
| 50 Hz | Sealing | VA | 3.4 | 3.4 | 3.4 | 3.4 | 7.1 | 7.1 |
| 50 Hz | Sealing | W | 1.2 | 1.2 | 1.2 | 1.2 | 2.1 | 2.1 |
| 60 Hz | Pick-up | VA | 30 | 30 | 30 | 30 | 67 | 67 |
| 60 Hz | Sealing | VA | 4.4 | 4.4 | 4.4 | 4.4 | 8.7 | 8.7 |
| 60 Hz | Sealing | W | 1.4 | 1.4 | 1.4 | 1.4 | 2.6 | 2.6 |
| 50/60 Hz | Pick-up | VA | 27 | 27 | 27 | 27 | 62 | 62 |
| | | | 25 | 25 | 25 | 25 | 58 | 58 |
| 50/60 Hz | Sealing | VA | 4.2 | 4.2 | 4.2 | 4.2 | 9.1 | 9.1 |
| | | | 3.3 | 3.3 | 3.3 | 3.3 | 6.5 | 6.5 |
| 50/60 Hz | Sealing | W | 1.4 | 1.4 | 1.4 | 1.4 | 2.5 | 2.5 |
| | | | 1.2 | 1.2 | 1.2 | 1.2 | 2 | 2 |
| DC operated | Pick-up | W | 3 | 3 | 4.5 | 4.5 | 12 | 12 |
| DC operated | Sealing | W | 3 | 3 | 4.5 | 4.5 | 0.5 | 0.5 |
| Duty factor | % DF | | 100 | 100 | 100 | 100 | 100 | 100 |
| Changeover times at 100 % U_c (recommended values) | | | | | | | | |
| Main contacts | | | | | | | | |
| AC operated | Closing delay | ms | 15...21 | 15...21 | 15...21 | 15...21 | 16...22 | 16...22 |
| | Opening delay | ms | 9...18 | 9...18 | 9...18 | 9...18 | 8...14 | 8...14 |
| DC operated | Closing delay | ms | 31 | 31 | 31 | 31 | 47 | 47 |
| | Opening delay | ms | 12 | 12 | 12 | 12 | 30 | 30 |
| Arcing time | | ms | 10 | 10 | 10 | 10 | 10 | 10 |
| Permissible residual current when A1 - A2 are actuated from the electronic system (with 0 signal) | | mA | – | – | – | – | – | – |
| Lifespan, mechanical; Coil 50/60 Hz | At 50 Hz | | Mechanical lifespan at 50 Hz approx. 30% lower than under → Technical data general | | | | | |
| Electromagnetic compatibility (EMC) | | | | | | | | |
| Emitted interference | | | To EN 60947-1 | | | | | |
| Interference immunity | | | To EN 60947-1 | | | | | |

Notes

¹⁾ At 24 V DC: 0.7 – 1.3 without auxiliary contact module and at ambient temperature + 40 °C

²⁾ RDC 24 (Umin 24 V DC/Umax 27 V DC)
 RDC 60 (Umin 48 V DC/Umax 60 V DC)
 RDC 130 (Umin 110 V DC/Umax 130 V DC)
 RDC 240 (Umin 200 V DC/Umax 240 V DC)

Example: $U_c = 0.7 \times U_{min} - 1.2 \times U_{max} / U_c = 0.7 \times 24 \text{ V} - 1.2 \times 27 \text{ V DC}$

³⁾ At least: smoothed two-phase bridge rectifier or three-phase rectifier

| DILM32 | DILM38 | DILM40 | DILM50 | DILM65 | DILM72 | DILM80 | DILM95 | DILM115 | DILM150 | DILM170 |
|-------------------------|-------------------------|-------------------------|-------------------------|-------------------------|-------------------------|-------------------------|-------------------------|-------------------------|-------------------------|-------------------------|
| 12.1 | 12.1 | 11.3 | 19 | 28.8 | 28.8 | 12.2 | 18.2 | 20.3 | 30.7 | 41.1 |
| 6.1 | 6.1 | 7.2 | 11.3 | 19 | 23 | 9.6 | 13.5 | 15.9 | 27 | 34.7 |
| 2 | 2 | 1.5 | 1.5 | 1.5 | 1.5 | 0.5 | 0.5 | 0.4 | 0.4 | 0.4 |
| 0.8 - 1.1 | 0.8 - 1.1 | 0.8 - 1.1 | 0.8 - 1.1 | 0.8 - 1.1 | 0.8 - 1.1 | 0.8 - 1.1 | 0.8 - 1.1 | 0.8 - 1.15 | 0.8 - 1.15 | 0.8 - 1.15 |
| 0.3 - 0.6 | 0.3 - 0.6 | 0.3 - 0.6 | 0.3 - 0.6 | 0.3 - 0.6 | 0.3 - 0.6 | 0.3 - 0.6 | 0.3 - 0.6 | 0.25 - 0.6 | 0.25 - 0.6 | 0.25 - 0.6 |
| 0.7 - 1.2 ²⁾ | 0.7 - 1.2 ²⁾ | 0.7 - 1.2 ²⁾ | 0.7 - 1.2 ²⁾ | 0.7 - 1.2 ²⁾ | 0.7 - 1.2 ²⁾ | 0.7 - 1.2 ²⁾ | 0.7 - 1.2 ²⁾ | 0.7 - 1.2 ²⁾ | 0.7 - 1.2 ²⁾ | 0.7 - 1.2 ²⁾ |
| 0.15 - 0.6 | 0.15 - 0.6 | 0.15 - 0.6 | 0.15 - 0.6 | 0.15 - 0.6 | 0.15 - 0.6 | 0.15 - 0.6 | 0.15 - 0.6 | 0.15 - 0.6 | 0.15 - 0.6 | 0.15 - 0.6 |
| 52 | 52 | 149 | 149 | 149 | 149 | 310 | 310 | 180 | 180 | 180 |
| 7.1 | 7.1 | 16 | 16 | 16 | 16 | 26 | 26 | 3.1 | 3.1 | 3.1 |
| 2.1 | 2.1 | 4.3 | 4.3 | 4.3 | 4.3 | 5.8 | 5.8 | 2.1 | 2.1 | 2.1 |
| 67 | 67 | 178 | 178 | 178 | 178 | 345 | 345 | 170 | 170 | 170 |
| 8.7 | 8.7 | 19 | 19 | 19 | 19 | 30 | 30 | 3.1 | 3.1 | 3.1 |
| 2.6 | 2.6 | 5.3 | 5.3 | 5.3 | 5.3 | 7.1 | 7.1 | 2.1 | 2.1 | 2.1 |
| 62 | 62 | 168 | 168 | 168 | 168 | 372 | 372 | 170 | 170 | 170 |
| 58 | 58 | 154 | 154 | 154 | 154 | 328 | 328 | 170 | 170 | 170 |
| 9.1 | 9.1 | 22 | 22 | 22 | 22 | 37.1 | 37.1 | 3.1 | 3.1 | 3.1 |
| 6.5 | 6.5 | 14 | 14 | 14 | 14 | 22.6 | 22.6 | 3.1 | 3.1 | 3.1 |
| 2.5 | 2.5 | 5.3 | 5.3 | 5.3 | 5.3 | 7.5 | 7.5 | 2.1 | 2.1 | 2.1 |
| 2 | 2 | 4.3 | 4.3 | 4.3 | 4.3 | 6.1 | 6.1 | 2.1 | 2.1 | 2.1 |
| 12 | 12 | 24 | 24 | 24 | 24 | 90 | 90 | 149 | 149 | 149 |
| 0.5 | 0.5 | 0.5 | 0.5 | 0.5 | 0.5 | 1.3 | 1.3 | 2.1 | 2.1 | 2.1 |
| 100 | 100 | 100 | 100 | 100 | 100 | 100 | 100 | 100 | 100 | 100 |
| 16...22 | 16...22 | 12...18 | 12...18 | 12...18 | 12...18 | 14...20 | 14...20 | 28...33 | 28...33 | 28...33 |
| 8...14 | 8...14 | 8...13 | 8...13 | 8...13 | 8...13 | 9...14 | 9...14 | 35...41 | 35...41 | 35...41 |
| 47 | 47 | 54 | 54 | 54 | 54 | 45 | 45 | 35 | 35 | 35 |
| 30 | 30 | 24 | 24 | 24 | 24 | 34 | 34 | 30 | 30 | 30 |
| 10 | 10 | 10 | 10 | 10 | 10 | 15 | 15 | 15 | 15 | 15 |
| - | - | - | - | - | - | ≤1 | ≤1 | ≤1 | ≤1 | ≤1 |

Mechanical lifespan at 50 Hz approx. 30% lower than under → Technical data general

To EN 60947-1

To EN 60947-1

1.1

Contactors

Comfort devices and standard devices greater than 170 A

1 DILM185...DILM1600, DILH

Contactors

DILM185A DILM225A DILM250 DILM300A DILM400 DILM500 DILM570

| General | | | DILM185A | DILM225A | DILM250 | DILM300A | DILM400 | DILM500 | DILM570 |
|---|--------------|-------------------|--|---------------|---------------|---------------|---------------|---------------|---------------|
| Standards | | | IEC/EN 60947, VDE 0660, UL, CSA | | | | | | |
| Lifespan, mechanical | | | | | | | | | |
| AC operated | c (contacts) | x 10 ⁶ | 10 | 10 | 10 | 10 | 7 | 7 | 7 |
| DC operated | c (contacts) | x 10 ⁶ | 10 | 10 | 10 | 10 | 7 | 7 | 7 |
| Operating frequency, mechanical | | | | | | | | | |
| AC operated | Operations/h | | 3000 | 3000 | 3000 | 3000 | 2000 | 2000 | 2000 |
| DC operated | Operations/h | | 3000 | 3000 | 3000 | 3000 | 2000 | 2000 | 2000 |
| Maximum operating frequency | | | → Engineering Page 91 | | | | | | |
| Electrical (Contactor without overload relay) | | | → Engineering Page 91 | | | | | | |
| Climatic proofing | | | Damp heat, constant, to IEC 60068-2-78 Damp heat, cyclic, to IEC 60068-2-30 | | | | | | |
| Ambient temperature | | | | | | | | | |
| Open | | °C | -25...60 | -25...60 | -25...60 | -25...60 | -25...60 | -25...60 | -25...60 |
| Enclosed | | °C | -25...40 | -25...40 | -25...40 | -25...40 | -25...40 | -25...40 | -25...40 |
| Storage | | °C | -40 - 80 | -40 - 80 | -40 - 80 | -40 - 80 | -40 - 80 | -40 - 80 | -40 - 80 |
| Mounting position: AC and DC-actuated | | | | | | | | | |
| Mechanical shock resistance (IEC/EN 60068-2-27) | | | | | | | | | |
| Half-sinusoidal shock 10 ms | | | | | | | | | |
| Main contacts | | | | | | | | | |
| N/O | | g | 10 | 10 | 10 | 10 | 10 | 10 | 10 |
| Auxiliary contacts | | | | | | | | | |
| N/O | | g | 10 | 10 | 10 | 10 | 10 | 10 | 10 |
| NC | | g | 8 | 8 | 8 | 8 | 8 | 8 | 8 |
| Protection type | | | IP00 IP00 IP00 IP00 IP00 IP00 IP00 | | | | | | |
| Protection against direct contact when actuated from front (EN 90274) | | | Finger- and back-of-hand proof with cover or terminal block | | | | | | |
| Weight | | | | | | | | | |
| Weight | | kg | 3.2 | 3.2 | 6.5 | 6.5 | 8 | 8 | 8 |
| Terminal capacity of main cable | | | | | | | | | |
| Flexible with cable lug | | mm ² | 50 - 185 | 50 - 185 | 50 - 240 | 50 - 240 | 50 - 240 | 50 - 240 | 50 - 240 |
| Stranded with cable lug | | mm ² | 50 - 185 | 70 - 185 | 70 - 240 | 70 - 240 | 70 - 240 | 70 - 240 | 70 - 240 |
| Solid or stranded | | AWG | 1/0 - 350 | 2/0 - 250 | 2/0 - 500 | 2/0 - 500 | 2/0 - 500 | 2/0 - 500 | 2/0 - 500 |
| | | MCM | | MCM | MCM | MCM | MCM | MCM | MCM |
| Busbar | Width | mm | 32 | 32 | 25 | 25 | 25 | 30 | 30 |
| Main cable connection screw/bolt | | | M10 M10 M10 M10 M10 M10 M10 | | | | | | |
| Tightening torque | | | Nm 24 24 24 24 24 24 24 | | | | | | |
| Terminal capacity of control circuit cable | | | | | | | | | |
| Solid | | mm ² | 1 x (0.75 - 2.5) 2 x (0.75 - 2.5) | | | | | | |
| Flexible with ferrule | | mm ² | 1 x (0.75 - 2.5) 2 x (0.75 - 2.5) | | | | | | |
| Solid or stranded | | AWG | 2 x (18 - 12) | 2 x (18 - 12) | 2 x (18 - 12) | 2 x (18 - 12) | 2 x (18 - 12) | 2 x (18 - 12) | 2 x (18 - 12) |
| Control circuit cable connection screw/bolt | | | M3.5 M3.5 M3.5 M3.5 M3.5 M3.5 M3.5 | | | | | | |
| Tightening torque | | | Nm 1.2 1.2 1.2 1.2 1.2 1.2 1.2 | | | | | | |
| Tools | | | | | | | | | |
| Main conductors | | | | | | | | | |
| Wrench | | mm | 16 | 16 | 16 | 16 | 16 | 16 | 16 |
| Auxiliary conductors | | | | | | | | | |
| Pozidriv screwdriver | | Size | 2 | 2 | 2 | 2 | 2 | 2 | 2 |

| DILM580 | DILM650 | DILM750 | DILM820 | DILM1000 | DILM1600 | DILH1400 | DILH2000 | DILH2200 | DILH2600 |
|---|---------------|---------------|---------------|---------------|---------------|---------------|---------------|---------------|---------------|
| IEC/EN 60947, VDE 0660, UL, CSA | | | | | | | | | |
| 5 | 5 | 5 | 5 | 5 | 5 | 5 | 5 | 5 | 5 |
| 5 | 5 | 5 | 5 | 5 | 5 | 5 | 5 | 5 | 5 |
| 1000 | 1000 | 1000 | 1000 | 1000 | 1000 | 1000 | 1000 | 1000 | 1000 |
| 1000 | 1000 | 1000 | 1000 | 1000 | 1000 | 1000 | 1000 | 1000 | 1000 |
| → Engineering Page 91 | | | | | | | | | |
| Damp heat, constant, to IEC 60068-2-78 | | | | | | | | | |
| Damp heat, cyclic, to IEC 60068-2-30 | | | | | | | | | |
| -25...60 | -25...60 | -25...60 | -25...60 | -25...60 | -25...60 | -25...60 | -25...60 | -25...60 | -25...60 |
| -25...40 | -25...40 | -25...40 | -25...40 | -25...40 | -25...40 | -25...40 | -25...40 | -25...40 | -25...40 |
| -40 - 80 | -40 - 80 | -40 - 80 | -40 - 80 | -40 - 80 | -40 - 80 | -40 - 80 | -40 - 80 | -40 - 80 | -40 - 80 |
| | | | | | | | | | |
| 10 | 10 | 10 | 10 | 10 | 10 | 10 | 10 | 10 | 10 |
| 10 | 10 | 10 | 10 | 10 | 10 | 10 | 10 | 10 | 10 |
| 8 | 8 | 8 | 8 | 8 | 8 | 8 | 8 | 8 | 8 |
| IP00 | IP00 | IP00 | IP00 | IP00 | IP00 | IP00 | IP00 | IP00 | IP00 |
| Finger- and back-of-hand proof with cover or terminal block | | | | | | | | | |
| 15 | 15 | 15 | 15 | 15 | 32 | 15 | 32 | 32 | 32 |
| 50 - 240 | 50 - 240 | 50 - 240 | 50 - 240 | 50 - 240 | – | – | – | – | – |
| 70 - 240 | 70 - 240 | 70 - 240 | 70 - 240 | 70 - 240 | – | – | – | – | – |
| 2/0 - 500 MCM | 2/0 - 500 MCM | 2/0 - 500 MCM | 2/0 - 500 MCM | 2/0 - 500 MCM | – | – | – | – | – |
| 50 | 50 | 60 | 60 | 60 | 100 | 80 | 100 | 100 | 100 |
| M10 | M10 | M12 | M12 | M12 | M12 | M12 | M12 | M12 | M12 |
| 24 | 24 | 35 | 35 | 35 | 35 | 35 | 35 | 35 | 35 |
| 1 x (0.75 - 2.5) | | | | | | | | | |
| 2 x (0.75 - 2.5) | | | | | | | | | |
| 1 x (0.75 - 2.5) | | | | | | | | | |
| 2 x (0.75 - 2.5) | | | | | | | | | |
| 2 x (18 - 12) | 2 x (18 - 12) | 2 x (18 - 12) | 2 x (18 - 12) | 2 x (18 - 12) | 2 x (18...12) | 2 x (18 - 12) | 2 x (18 - 12) | 2 x (18 - 12) | 2 x (18 - 12) |
| M3.5 | M3.5 | M3.5 | M3.5 | M3.5 | M3.5 | M3.5 | M3.5 | M3.5 | M3.5 |
| 1.2 | 1.2 | 1.2 | 1.2 | 1.2 | 1.2 | 1.2 | 1.2 | 1.2 | 1.2 |
| 16 | 16 | 18 | 18 | 18 | 18 | 18 | 18 | 18 | 18 |
| 2 | 2 | 2 | 2 | 2 | 2 | 2 | 2 | 2 | 2 |

1 DILM185...DILM1600, DILH

Contactors

DILM185A DILM225A DILM250 DILM300A DILM400 DILM500 DILM570

Main contacts

| | | | DILM185A | DILM225A | DILM250 | DILM300A | DILM400 | DILM500 | DILM570 |
|--|-----------|------|----------|----------|---------|----------|---------|---------|---------|
| Rated impulse withstand voltage | U_{imp} | V AC | 8000 | 8000 | 8000 | 8000 | 8000 | 8000 | 8000 |
| Overvoltage category/pollution degree | | | III/3 | III/3 | III/3 | III/3 | III/3 | III/3 | III/3 |
| Rated insulation voltage | U_i | V AC | 1000 | 1000 | 1000 | 1000 | 1000 | 1000 | 1000 |
| Rated operating voltage | U_e | V AC | 1000 | 1000 | 1000 | 1000 | 1000 | 1000 | 1000 |
| Safe isolation according to EN 61140 | | | | | | | | | |
| Between coil and contacts | | V AC | 500 | 500 | 500 | 500 | 500 | 500 | 500 |
| Between the contacts | | V AC | 500 | 500 | 500 | 500 | 500 | 500 | 500 |
| Making capacity (cos Φ to IEC/EN 60947) | | A | 2700 | 2700 | 3000 | 3600 | 5500 | 5500 | 6000 |
| Breaking capacity | | | | | | | | | |
| 220/230 V | | A | 2250 | 2250 | 2500 | 3000 | 5000 | 5000 | 5800 |
| 380/440 V | | A | 2250 | 2250 | 2500 | 3000 | 5000 | 5000 | 5800 |
| 500 V | | A | 2250 | 2250 | 2500 | 3000 | 5000 | 5000 | 5800 |
| 660/690 V | | A | 2250 | 2250 | 2500 | 3000 | 5000 | 5000 | 5800 |
| 1000 V | | A | 760 | 760 | 760 | 950 | 950 | 950 | 950 |

Component lifespan

→ Page 87

Short-circuit rating

| Short-circuit protection rating maximum fuse | | | | | | | | | |
|--|--------------|---|-----|-----|-----|-----|-----|-----|-----|
| Type "2" coordination | | | | | | | | | |
| 400 V | gG/gL 500 V | A | 250 | 250 | 315 | 315 | 500 | 500 | 500 |
| 690 V | gG/gL 690 V | A | 250 | 250 | 315 | 315 | 500 | 500 | 500 |
| 1000 V | gG/gL 1000 V | A | 160 | 160 | 160 | 160 | 200 | 200 | 200 |
| Type "1" coordination | | | | | | | | | |
| 400 V | gG/gL 500 V | A | 400 | 400 | 400 | 400 | 630 | 630 | 800 |
| 690 V | gG/gL 690 V | A | 315 | 315 | 400 | 400 | 630 | 630 | 630 |
| 1000 V | gG/gL 1000 V | A | 200 | 200 | 200 | 200 | 250 | 250 | 250 |

AC voltage

AC-1 operation

| Conventional thermal current 3 pole 50 - 60 Hz | | | | | | | | | |
|--|----------|---|-----|-----|-----|-----|------|------|------|
| Open | | | | | | | | | |
| at 40 °C | I_{th} | A | 337 | 356 | 400 | 430 | 612 | 857 | 920 |
| at 50 °C | I_{th} | A | 301 | 310 | 360 | 385 | 548 | 767 | 821 |
| at 55 °C | I_{th} | A | 287 | 295 | 340 | 365 | 522 | 731 | 783 |
| at 60 °C | I_{th} | A | 275 | 285 | 330 | 350 | 500 | 700 | 750 |
| Enclosed ¹⁾ | I_{th} | A | 245 | 275 | 300 | 315 | 450 | 650 | – |
| Conventional thermal current, 1-pole | | | | | | | | | |
| Open ¹⁾ | I_{th} | A | 685 | 707 | 825 | 875 | 1250 | 1750 | 1875 |
| Enclosed ¹⁾ | I_{th} | A | 625 | 636 | 742 | 785 | 1125 | 1600 | – |

AC-3 operation

| Rated operational current AC -3 open, 50 – 60 Hz, 3 pole | | | | | | | | | |
|--|-------|----|-----|-----|-----|-----|-----|-----|-----|
| 220/230 V | I_e | A | 185 | 225 | 250 | 300 | 400 | 500 | 580 |
| 240 V | I_e | A | 185 | 225 | 250 | 300 | 400 | 500 | 580 |
| 380/400 V | I_e | A | 185 | 225 | 250 | 300 | 400 | 500 | 580 |
| 415 V | I_e | A | 185 | 225 | 250 | 300 | 400 | 500 | 580 |
| 440 V | I_e | A | 185 | 225 | 250 | 300 | 400 | 500 | 580 |
| 500 V | I_e | A | 185 | 225 | 250 | 300 | 400 | 500 | 500 |
| 660/690 V | I_e | A | 150 | 160 | 250 | 210 | 360 | 360 | 360 |
| 1000 V | I_e | A | 76 | 76 | 76 | 95 | 95 | 95 | 95 |
| Rated operational power | | | | | | | | | |
| 220/230 V | P | kW | 55 | 70 | 75 | 90 | 125 | 155 | 185 |
| 240 V | P | kW | 62 | 75 | 85 | 100 | 132 | 170 | 200 |
| 380/400 V | P | kW | 90 | 110 | 132 | 160 | 200 | 250 | 315 |
| 415 V | P | kW | 110 | 132 | 148 | 180 | 240 | 300 | 348 |
| 440 V | P | kW | 115 | 138 | 132 | 185 | 200 | 250 | 370 |
| 500 V | P | kW | 132 | 160 | 180 | 215 | 290 | 360 | 360 |
| 660/690 V | P | kW | 140 | 150 | 240 | 195 | 344 | 344 | 344 |
| 1000 V | P | kW | 108 | 108 | 108 | 132 | 132 | 132 | 132 |

Notes

¹⁾ At maximum permissible ambient air temperature²⁾ To 690 V

| DILM580 | DILM650 | DILM750 | DILM820 | DILM1000 | DILM1600 | DILH1400 | DILH2000 | DILH2200 | DILH2600 |
|-----------|---------|---------|---------|----------|--------------------|--------------------|--------------------|--------------------|--------------------|
| 8000 | 8000 | 8000 | 8000 | 8000 | 8000 | 8000 | 8000 | 8000 | 8000 |
| III/3 | III/3 | III/3 | III/3 | III/3 | III/3 | III/3 | III/3 | III/3 | III/3 |
| 1000 | 1000 | 1000 | 1000 | 1000 | 1000 | 1000 | 1000 | 1000 | 1000 |
| 1000 | 1000 | 1000 | 1000 | 1000 | 1000 | 1000 | 1000 | 1000 | 1000 |
| 500 | 500 | 500 | 500 | 500 | 500 | 500 | 500 | 500 | 500 |
| 500 | 500 | 500 | 500 | 500 | 500 | 500 | 500 | 500 | 500 |
| 7800 | 7800 | 9840 | 9840 | 9840 | 19000 | 9840 | 9840 | 9840 | 9840 |
| 6500 | 6500 | 8200 | 8200 | 8200 | 16000 | 8200 | 8200 | 8200 | 8200 |
| 6500 | 6500 | 8200 | 8200 | 8200 | 16000 | 8200 | 8200 | 8200 | 8200 |
| 6500 | 6500 | 8200 | 8200 | 8200 | 16000 | 8200 | 8200 | 8200 | 8200 |
| 6500 | 6500 | 8200 | 8200 | 8200 | 16000 | 8200 | 8200 | 8200 | 8200 |
| 4350 | 4350 | 5800 | 5800 | 5800 | 5800 | 5800 | 5800 | 5800 | 5800 |
| → Page 87 | | | | | | | | | |
| 630 | 630 | 630 | 630 | 630 | - | - | - | - | - |
| 630 | 630 | 630 | 630 | 630 | - | - | - | - | - |
| 500 | 500 | 630 | 630 | 630 | - | - | - | - | - |
| 1000 | 1000 | 1200 | 1200 | 1200 | - | - | - | - | - |
| 1000 | 1000 | 1200 | 1200 | 1200 | - | - | - | - | - |
| 630 | 630 | 800 | 800 | 800 | - | - | - | - | - |
| 980 | 1041 | 1102 | 1225 | 1225 | 2200 ²⁾ | 1714 ²⁾ | 2450 ²⁾ | 2700 ²⁾ | 3185 ²⁾ |
| 876 | 931 | 986 | 1095 | 1095 | 1970 ²⁾ | 1533 ²⁾ | 2190 ²⁾ | 2400 ²⁾ | 2847 ²⁾ |
| 836 | 888 | 940 | 1044 | 1044 | 1880 ²⁾ | 1462 ²⁾ | 2089 ²⁾ | 2300 ²⁾ | 2716 ²⁾ |
| 800 | 850 | 900 | 1000 | 1000 | 1800 ²⁾ | 1400 ²⁾ | 2000 ²⁾ | 2200 ²⁾ | 2600 ²⁾ |
| - | - | - | - | - | - | - | - | - | - |
| 2000 | 2125 | 2250 | 2500 | 2500 | 4500 | 3500 | 5000 | 5500 | 6500 ²⁾ |
| - | - | - | - | - | - | - | - | - | - |
| 580 | 650 | 750 | 820 | 1000 | 1600 | - | - | - | - |
| 580 | 650 | 750 | 820 | 1000 | 1600 | - | - | - | - |
| 580 | 650 | 750 | 820 | 1000 | 1600 | - | - | - | - |
| 580 | 650 | 750 | 820 | 1000 | 1600 | - | - | - | - |
| 580 | 650 | 750 | 820 | 1000 | 1600 | - | - | - | - |
| 580 | 650 | 750 | 820 | 1000 | 1600 | - | - | - | - |
| 580 | 650 | 750 | 820 | 1000 | 1600 | - | - | - | - |
| 435 | 435 | 580 | 580 | 750 | 1200 | - | - | - | - |
| 185 | 205 | 240 | 260 | 315 | 500 | - | - | - | - |
| 200 | 225 | 260 | 285 | 340 | 550 | - | - | - | - |
| 315 | 355 | 400 | 450 | 560 | 900 | - | - | - | - |
| 348 | 390 | 455 | 500 | 610 | 930 | - | - | - | - |
| 370 | 420 | 480 | 450 | 650 | 1000 | - | - | - | - |
| 420 | 470 | 550 | 600 | 730 | 1180 | - | - | - | - |
| 560 | 630 | 720 | 750 | 1000 | 1600 | - | - | - | - |
| 600 | 600 | 800 | 800 | 1100 | 1770 | - | - | - | - |

1.1

Contactors

Comfort devices and standard devices greater than 170 A

1 DILM185...DILM1600, DILH

Contactors

DILM185A DILM225A DILM250 DILM300A DILM400 DILM500 DILM570

AC voltage

AC-4 operation

| Rated operational current AC -4 open, 50 – 60 Hz, 3 pole | | | DILM185A | DILM225A | DILM250 | DILM300A | DILM400 | DILM500 | DILM570 |
|--|-------|----|----------|----------|---------|----------|---------|---------|---------|
| 220/230 V | I_e | A | 136 | 164 | 200 | 240 | 296 | 360 | 360 |
| 240 V | I_e | A | 136 | 164 | 200 | 240 | 296 | 360 | 360 |
| 380/400 V | I_e | A | 136 | 164 | 200 | 240 | 296 | 360 | 360 |
| 415 V | I_e | A | 136 | 164 | 200 | 240 | 296 | 360 | 360 |
| 440 V | I_e | A | 136 | 164 | 200 | 240 | 296 | 360 | 360 |
| 500 V | I_e | A | 136 | 164 | 200 | 240 | 296 | 360 | 360 |
| 660/690 V | I_e | A | 110 | 120 | 200 | 170 | 296 | 296 | 296 |
| 1000 V | I_e | A | 55 | 55 | 76 | 76 | 95 | 95 | 95 |
| Rated operational power | | | DILM185A | DILM225A | DILM250 | DILM300A | DILM400 | DILM500 | DILM570 |
| 220/230 V | P | kW | 41 | 51 | 62 | 75 | 92 | 112 | 112 |
| 240 V | P | kW | 45 | 54 | 68 | 82 | 101 | 122 | 122 |
| 380/400 V | P | kW | 75 | 90 | 110 | 132 | 160 | 200 | 200 |
| 415 V | P | kW | 80 | 96 | 117 | 142 | 176 | 216 | 216 |
| 440 V | P | kW | 85 | 102 | 125 | 150 | 186 | 229 | 229 |
| 500 V | P | kW | 96 | 116 | 143 | 172 | 214 | 260 | 260 |
| 660/690 V | P | kW | 102 | 110 | 189 | 160 | 283 | 344 | 344 |
| 1000 V | P | kW | 77 | 77 | 108 | 109 | 132 | 132 | 132 |

Capacitor operation

Individual compensation rated operational current I_e of alternating current capacitor

| Open | | | DILM185A | DILM225A | DILM250 | DILM300A | DILM400 | DILM500 | DILM570 |
|--------------------------|--------------|----------|----------|----------|---------|----------|---------|---------|---------|
| To 525 V | | A | 220 | 220 | 220 | 307 | 307 | 307 | 307 |
| 690 V | | A | 133 | 133 | 133 | 177 | 177 | 177 | 177 |
| Max. peak inrush current | $x I_e$ | | 30 | 30 | 30 | 30 | 30 | 30 | 30 |
| Component lifespan | c (contacts) | $x 10^6$ | 0.1 | 0.1 | 0.1 | 0.1 | 0.1 | 0.1 | 0.1 |
| Max. operating frequency | | Ops/h | 200 | 200 | 200 | 200 | 200 | 200 | 200 |

DC voltage

Operations

→ Engineering Page 92

Rated operational current I_e open

| DC-1 operation | | | DILM185A | DILM225A | DILM250 | DILM300A | DILM400 | DILM500 | DILM570 |
|----------------|-------|---|----------|----------|---------|----------|---------|---------|---------|
| 60 V | I_e | A | 300 | 300 | 300 | 400 | 400 | 400 | 400 |
| 110 V | I_e | A | 300 | 300 | 300 | 400 | 400 | 400 | 400 |
| 220 V | I_e | A | 300 | 300 | 300 | 400 | 400 | 400 | 400 |
| 440 V | I_e | A | 11 | 11 | 11 | 11 | 11 | 11 | 11 |
| DC-3 operation | | | DILM185A | DILM225A | DILM250 | DILM300A | DILM400 | DILM500 | DILM570 |
| 60 V | I_e | A | 300 | 300 | 300 | 400 | 400 | 400 | 400 |
| 110 V | I_e | A | 300 | 300 | 300 | 400 | 400 | 400 | 400 |
| 220 V | I_e | A | 300 | 300 | 300 | 400 | 400 | 400 | 400 |
| DC-5 operation | | | DILM185A | DILM225A | DILM250 | DILM300A | DILM400 | DILM500 | DILM570 |
| 60 V | I_e | A | 300 | 300 | 300 | 400 | 400 | 400 | 400 |
| 110 V | I_e | A | 300 | 300 | 300 | 400 | 400 | 400 | 400 |
| 220 V | I_e | A | 300 | 300 | 300 | 400 | 400 | 400 | 400 |

Current heat loss (3 pole)

| | | | | | | | | |
|--|---|----|----|----|----|----|-----|-----|
| Current heat loss at I_{th} | W | 34 | 45 | 55 | 37 | 58 | 113 | 130 |
| Current heat loss at I_e to AC-3/400 V | W | 16 | 23 | 28 | 21 | 37 | 58 | 78 |

| DILM580 | DILM650 | DILM750 | DILM820 | DILM1000 | DILM1600 | DILH1400 | DILH2000 | DILH2200 | DILH2600 |
|---------|---------|---------|---------|----------|----------|----------|----------|----------|----------|
| 456 | 512 | 576 | 656 | 800 | 1280 | - | - | - | - |
| 456 | 512 | 576 | 656 | 800 | 1280 | - | - | - | - |
| 456 | 512 | 576 | 656 | 800 | 1280 | - | - | - | - |
| 456 | 512 | 576 | 656 | 800 | 1280 | - | - | - | - |
| 456 | 512 | 576 | 656 | 800 | 1280 | - | - | - | - |
| 456 | 512 | 576 | 656 | 800 | 1280 | - | - | - | - |
| 456 | 512 | 576 | 656 | 800 | 1280 | - | - | - | - |
| 348 | 348 | 464 | 464 | 700 | 1120 | - | - | - | - |
| 143 | 161 | 181 | 209 | 260 | 430 | - | - | - | - |
| 156 | 176 | 200 | 228 | 280 | 450 | - | - | - | - |
| 250 | 280 | 315 | 355 | 450 | 750 | - | - | - | - |
| 274 | 307 | 346 | 394 | 490 | 770 | - | - | - | - |
| 290 | 326 | 367 | 418 | 520 | 830 | - | - | - | - |
| 330 | 370 | 417 | 474 | 590 | 940 | - | - | - | - |
| 440 | 494 | 556 | 633 | 780 | 1300 | - | - | - | - |
| 509 | 509 | 678 | 678 | 1000 | 1650 | - | - | - | - |
| 463 | 463 | 463 | 463 | 463 | - | - | - | - | - |
| 265 | 265 | 265 | 265 | 265 | - | - | - | - | - |
| 30 | 30 | 30 | 30 | 30 | - | - | - | - | - |
| 0.1 | 0.1 | 0.1 | 0.1 | 0.1 | - | - | - | - | - |
| 200 | 200 | 200 | 200 | 200 | - | - | - | - | - |
| - | - | - | - | - | - | - | - | - | - |
| - | - | - | - | - | - | - | - | - | - |
| - | - | - | - | - | - | - | - | - | - |
| - | - | - | - | - | - | - | - | - | - |
| - | - | - | - | - | - | - | - | - | - |
| - | - | - | - | - | - | - | - | - | - |
| - | - | - | - | - | - | - | - | - | - |
| - | - | - | - | - | - | - | - | - | - |
| - | - | - | - | - | - | - | - | - | - |
| - | - | - | - | - | - | - | - | - | - |
| - | - | - | - | - | - | - | - | - | - |
| - | - | - | - | - | - | - | - | - | - |
| 61 | 69 | 78 | 96 | 96 | 155 | 188 | 192 | 232 | 250 |
| 32 | 41 | 54 | 65 | 96 | 123 | - | - | - | - |

DILM185...DILM1600, DILH

| | | | | Contactors | | | | | | |
|---|--|----------|---------|------------|------------------------------------|--|------------------------------------|-------------------|-------------------|-------------------|
| | | | | DILM185A | DILM225A | DILM250 | DILM300A | DILM400 | DILM500 | DILM570 |
| Magnet systems | | | | | | | | | | |
| Voltage tolerance ¹⁾ | AC operated | Pick-up | $x U_c$ | 0.8 - 1.15 | 0.8 - 1.15 | | | | | |
| | AC operated | Drop-out | $x U_c$ | 0.25 - 0.6 | 0.25 - 0.6 | | | | | |
| | DC operated | Pick-up | $x U_c$ | 0.7 - 1.2 | 0.7 - 1.2 | | | | | |
| | DC operated | Drop-out | $x U_c$ | 0.15 - 0.6 | 0.15 - 0.6 | | | | | |
| Power consumption of the coil in a cold state and $1.0 x U_c$ | 50/60 Hz | Pick-up | VA | 210 | 210 | – | – | – | – | – |
| | 50/60 Hz | Sealing | VA | 2.6 | 2.6 | – | – | – | – | – |
| | 50/60 Hz | Sealing | W | 2.6 | 2.6 | – | – | – | – | – |
| | DC operated | Pick-up | W | 180 | 180 | – | – | – | – | – |
| | DC operated | Sealing | W | 2.1 | 2.1 | – | – | – | – | – |
| Voltage tolerance | Comfort series DILM... | Pick-up | $x U_c$ | – | – | $0.7 x U_{c\ min} - 1.15 x U_{c\ max}$ | | | | |
| | Standard range DILM...-S | Pick-up | $x U_c$ | – | – | $0.85 x U_{c\ min} - 1.1 x U_{c\ max}$ | | | | |
| | Comfort series DILM... | Drop-out | $x U_c$ | – | – | $0.2 x U_{c\ min} - 0.6 x U_{c\ min}$ | | | | |
| | Standard range DILM...-S | Drop-out | $x U_c$ | – | – | $0.2 x U_{c\ min} - 0.4 x U_{c\ min}$ | | | | |
| Power consumption of the coil in a cold state and $1.0 x U_c$ | Comfort series DILM... | Pick-up | VA | – | – | 380 ²⁾ | 380 ²⁾ | 450 ²⁾ | 450 ²⁾ | 450 ²⁾ |
| | Comfort series DILM... | Pick-up | W | – | – | 250 | 250 | 350 | 350 | 350 |
| | Comfort series DILM... | Sealing | VA | – | – | 4.3 | 4.3 | 4.3 | 4.3 | 4.3 |
| | Comfort series DILM... | Sealing | W | – | – | 3.3 | 3.3 | 3.3 | 3.3 | 3.3 |
| | Standard range DILM...-S | Pick-up | VA | – | – | 360 ⁴⁾ | 360 ⁴⁾ | 715 ⁴⁾ | 715 ⁴⁾ | 715 ⁴⁾ |
| | Standard range DILM...-S | Pick-up | W | – | – | 325 | 625 | 645 | 645 | 645 |
| | Standard range DILM...-S | Sealing | VA | – | – | 4.3 | 4.3 | 4.3 | 4.3 | 4.3 |
| | Standard range DILM...-S | Sealing | W | – | – | 3.3 | 3.3 | 3.3 | 3.3 | 3.3 |
| Duty factor | | | % DF | – | – | 100 | 100 | 100 | 100 | 100 |
| Changeover time at 100 % U_c (recommended values), main circuit | | | | | | | | | | |
| Comfort series DILM... | Closing delay | ms | | – | – | < 100 | < 80 | < 80 | < 80 | < 80 |
| | Opening delay | ms | | – | – | < 110 | < 110 | < 110 | < 110 | < 110 |
| Standard range DILM...-S | Closing delay | ms | | < 60 | < 60 | < 55 | < 55 | < 55 | < 55 | < 55 |
| | Opening delay | ms | | < 40 | < 40 | < 40 | < 40 | < 50 | < 50 | < 50 |
| Behavior in limit range and transition area, hold state | | | | | | | | | | |
| Voltage interruption | $(0 - 0.2 x U_{c\ min}) \leq 10\ ms$ | | | | – | – | Targeted bridging during this time | | | |
| | $(0 - 0.2 x U_{c\ min}) > 10\ ms$ | | | | Drop-out of the contactor | | | | | |
| Voltage drops | $(0 - 0.2 x U_{c\ min}) \leq 12\ ms$ | | | | Targeted bridging during this time | | | | | |
| | $(0.2 - 0.6 x U_{c\ min}) > 12\ ms$ | | | | Drop-out of the contactor | | | | | |
| | $(0.6 - 0.7 x U_{c\ min})$ | | | | Contactor remains switched on | | | | | |
| Excess voltage | $(1.15 - 1.3 x U_{c\ max})$ | | | | Contactor remains switched on | | | | | |
| | $(> 1.3 x U_{c\ max}) \leq 3\ s$ | | | | Contactor remains switched on | | | | | |
| | $(> 1.3 x U_{c\ max}) > 3\ s$ | | | | Drop-out of the contactor | | | | | |
| Pick-up phase | $(0.7 x U_{c\ min})$ | | | | Contactor does not switch on | | | | | |
| | $(0.7 x U_{c\ min} - 1.15 x U_{c\ max})$ | | | | Contactor switches on safely | | | | | |
| | $(> 1.15 x U_{c\ max})$ | | | | Contactor switches on safely | | | | | |
| Permissible transitional contact resistance (of external control unit when A11 is actuated) | | | mΩ | – | – | ≤ 500 | ≤ 500 | ≤ 500 | ≤ 500 | – |
| Permissible residual current (when A11 is actuated from the electronic system in the event of a 0 signal) | | | mA | – | – | ≤ 1 | ≤ 1 | ≤ 1 | ≤ 1 | – |
| PLC signal level (A3 - A4) to IEC/EN 61131-2 (part no. 2) | | | | | | | | | | |
| High | | | V | 15 | 15 | 15 | 15 | 15 | 15 | – |
| Low | | | V | 5 | 5 | 5 | 5 | 5 | 5 | – |

Electromagnetic compatibility (EMC)

Electromagnetic compatibility

This product is designed for operation in industrial environments (environment 2). The use in residential environments (environment 1) could cause electrical interference so that addition suppression must be planned.

Notes

- ¹⁾ $U_{c\ min}$, $U_{c\ max}$,
- ²⁾ Control transformer with $u_k \leq 0.6$
- ³⁾ Control transformer with $u_k \leq 0.7$
- ⁴⁾ $u_k \leq 10\ %$

1.1

Contactors

Basic devices up to 200 A, 4 pole

DILMP20 ... DILMP200

1

DILMP20 DILMP32 DILMP63 DILMP125
 DILMP45 DILMP80 DILMP160 DILMP200

| General | | | | | | |
|---|---|-------------------|--------------------------------------|--------------------------------------|--------------------------------------|--------------------------------------|
| Standards | IEC/EN 60947, VDE 0660, UL, CSA | | | | | |
| Lifespan, mechanical | | | | | | |
| AC operated | c (contacts) | x 10 ⁶ | 10 | | | |
| DC operated | c (contacts) | x 10 ⁶ | 10 | | | |
| Operating frequency, mechanical | | | | | | |
| Mechanical, AC operated | Operations/h | | 5000 | | 3600 | |
| DC operated | Operations/h | | 5000 | | 3600 | |
| Maximum operating frequency | | | | | | |
| Electrical (Contactor without overload relay) | 600 | | | | | |
| Climatic proofing | Damp heat, constant, to IEC 60068-2-3 Damp heat, cyclic, to IEC 60068-2-30 | | | | | |
| Ambient temperature | | | | | | |
| Open | °C | | -25...60 | | | |
| Enclosed | °C | | -25...40 | | | |
| Storage | °C | | -40 - 80 | | | |
| Mounting position AC- and DC operated | | | | | | |
| Mechanical shock resistance (IEC/EN 60068-2-27) | | | | | | |
| Half-sinusoidal shock 10 ms | | | | | | |
| Main contacts | | g | 10 | | | |
| Auxiliary contacts | | g | 7 | | | |
| | NC | g | 5 | | | |
| Protection type | | | IP20 | IP00 | | |
| With accessories | | | – | IP20 | | |
| Protection against direct contact when actuated from front (EN 50274) | Finger- and back-of-hand proof | | | | | |
| Terminal type, screw connection | | | | | | |
| Terminal capacity of main cable | | | | | | |
| Solid | | mm ² | 1 x (0.75 - 4) 2 x (0.75 - 2.5) | 1 x (0.75 - 16) 2 x (0.75 - 10) | 1 x (2.5 - 16) 2 x (2.5 - 16) | – |
| Flexible with ferrule | | mm ² | 1 x (0.75 - 2.5) 2 x (0.75 - 2.5) | 1 x (0.75 - 16) 2 x (0.75 - 10) | 1 x (2.5 - 35) 2 x (2.5 - 25) | 1 x (10 - 95) 2 x (10 - 70) |
| Stranded | | mm ² | – | 1 x 16 | 1 x (16 - 50) 2 x (16 - 35) | 1 x (16 - 120) 2 x (16 - 95) |
| Solid or stranded | | AWG | 18 - 14 | 18 - 6 | 12 - 2 | 8 - 250MCM |
| Flat conductor | Number of layers x width x thickness | mm | – | – | 2 x (6 x 9 x 0.8) | 2 x (6 x 16 x 0.8) |
| Terminal capacity of control circuit cable | | | | | | |
| Solid | | mm ² | 1 x (0.75 - 4) 2 x (0.75 - 2.5) | 1 x (0.75 - 4) 2 x (0.75 - 2.5) | 1 x (0.75 - 4) 2 x (0.75 - 4) | 1 x (0.75 - 4) 2 x (0.75 - 4) |
| Flexible with ferrule | | mm ² | 1 x (0.75 - 2.5) 2 x (0.75 - 2.5) | 1 x (0.75 - 2.5) 2 x (0.75 - 2.5) | 1 x (0.75 - 2.5) 2 x (0.75 - 2.5) | 1 x (0.75 - 2.5) 2 x (0.75 - 2.5) |
| Solid or stranded | | AWG | 18 - 14 | 18 - 14 | 18 - 14 | 18 - 14 |
| Main cable connection screw/bolt | | | M3.5 | M5 | M6 | M10 |
| Tightening torque | | | Nm 1.2 | 3 | 3.3 | 14 |
| Control circuit cable connection screw/bolt | | | M3.5 | M3.5 | M3.5 | M3.5 |
| Tightening torque | | | Nm 1.2 | 1.2 | 1.2 | 1.2 |
| Tools | | | | | | |
| Main conductors | | | | | | |
| Pozidriv screwdriver | | Size | 2 | 2 | 2 | – |
| Internal hexagon | SW | mm | – | – | – | 5 |
| Flat-blade screwdriver | | mm | 0.8 x 5.5 1 x 6 | 0.8 x 5.5 1 x 6 | 0.8 x 5.5 1 x 6 | – |
| Auxiliary conductors | | | | | | |
| Pozidriv screwdriver | | Size | 2 | 2 | 2 | 2 |
| Flat-blade screwdriver | | mm | 0.8 x 5.5 1 x 6 | 0.8 x 5.5 1 x 6 | 0.8 x 5.5 1 x 6 | 0.8 x 5.5 1 x 6 |

DILMP20 ... DILMP200

| | | | | DILMP20 | DILMP32 DILMP45 | DILMP63 DILMP80 | DILMP125 DILMP160 | DILMP200 | | | | |
|--|---------------------------|-------------|----------|---------|--------------------|--------------------|----------------------|----------|------|------|------|-----|
| Main contacts | | | | | | | | | | | | |
| Rated impulse withstand voltage | U_{imp} | V AC | | 8000 | | | | | | | | |
| Overvoltage category/pollution degree | | | | III/3 | | | | | | | | |
| Rated insulation voltage | U_i | V AC | | 690 | | | | | | | | |
| Rated operating voltage | U_e | V AC | | 690 | | | | | | | | |
| Safe isolation according to EN 61140 | | | | | | | | | | | | |
| | Between coil and contacts | | V AC | 400 | 440 | | | | | | | |
| | Between the contacts | | V AC | 400 | 440 | | | | | | | |
| Making capacity (cos φ to IEC/EN 60947) | To 690 V | A | | 144 | 238 | 350 | 560 | 700 | 1120 | 1330 | 1800 | |
| Breaking capacity | | | | | | | | | | | | |
| | 220/230 V | A | | 120 | 180 | 250 | 400 | 500 | 800 | 950 | 1150 | |
| | 380/400 V | A | | 120 | 180 | 250 | 400 | 500 | 800 | 950 | 1150 | |
| | 500 V | A | | 100 | 180 | 250 | 400 | 500 | 800 | 950 | 1150 | |
| | 660/690 V | A | | 70 | 120 | 144 | 250 | 296 | 650 | 750 | 800 | |
| Short-circuit rating | | | | | | | | | | | | |
| Short-circuit protection rating maximum fuse | | | | | | | | | | | | |
| Type "2" coordination | | | | | | | | | | | | |
| | 400 V | gG/gL 500 V | A | 20 | 35 | 35 | 63 | 80 | 160 | 160 | 250 | |
| | 690 V | gG/gL 690 V | A | 20 | 35 | 35 | 50 | 63 | 160 | 160 | 200 | |
| Type "1" coordination | | | | | | | | | | | | |
| | 400 V | gG/gL 500 V | A | 35 | 63 | 100 | 125 | 160 | 250 | 250 | 250 | |
| | 690 V | gG/gL 690 V | A | 25 | 50 | 50 | 80 | 80 | 200 | 200 | 200 | |
| AC voltage | | | | | | | | | | | | |
| AC-1 operation | | | | | | | | | | | | |
| Conventional thermal current 3 pole 50 - 60 Hz | | | | | | | | | | | | |
| | Open | at 40 °C | I_{th} | A | 22 | 32 | 45 | 63 | 80 | 125 | 160 | 200 |
| | | at 50 °C | I_{th} | A | 21 | 30 | 41 | 60 | 76 | 116 | 150 | 188 |
| | | at 60 °C | I_{th} | A | 20 | 28 | 39 | 54 | 69 | 108 | 138 | 172 |
| | Enclosed | | I_{th} | A | 18 | 27 | 36 | 50 | 64 | 100 | 128 | 160 |
| Conventional thermal current, 1 pole | | | | | | | | | | | | |
| | Open | | I_{th} | A | 60 | 84 | 117 | 162 | 207 | 325 | 415 | 516 |
| | Enclosed | | I_{th} | A | 54 | 76 | 105 | 146 | 186 | 292 | 373 | 464 |
| Rated operational power | | | | | | | | | | | | |
| | 220/230 V | P | kW | 8 | 12 | 16 | 23 | 29 | 45 | 58 | 72 | |
| | 240 V | P | kW | 9 | 13 | 18 | 25 | 32 | 49 | 63 | 79 | |
| | 380 V | P | kW | 14 | 20 | 28 | 39 | 50 | 78 | 100 | 125 | |
| | 415 V | P | kW | 15 | 22 | 31 | 43 | 55 | 85 | 109 | 137 | |
| | 440 V | P | kW | 16 | 23 | 33 | 46 | 58 | 90 | 116 | 145 | |
| | 500 V | P | kW | 18 | 26 | 37 | 52 | 66 | 103 | 132 | 165 | |
| | 690 V | P | kW | 24 | 35 | 49 | 68 | 87 | 136 | 174 | 217 | |
| AC-3 operation | | | | | | | | | | | | |
| Rated operational current AC -3 open, 50 – 60 Hz, 3 pole | | | | | | | | | | | | |
| | 220/230 V | I_e | A | 12 | 18 | 25 | 40 | 50 | 80 | 95 | 115 | |
| | 240 V | I_e | A | 12 | 18 | 25 | 40 | 50 | 80 | 95 | 115 | |
| | 380/400 V | I_e | A | 12 | 18 | 25 | 40 | 50 | 80 | 95 | 115 | |
| | 415 V | I_e | A | 12 | 18 | 25 | 40 | 50 | 80 | 95 | 115 | |
| | 440 V | I_e | A | 12 | 18 | 25 | 40 | 50 | 80 | 95 | 115 | |
| | 500 V | I_e | A | 10 | 18 | 25 | 40 | 50 | 80 | 95 | 115 | |
| | 660/690 V | I_e | A | 7 | 12 | 15 | 25 | 32 | 65 | 80 | 93 | |
| Rated operational power | | | | | | | | | | | | |
| | 220/230 V | P | kW | 3.5 | 5 | 7.5 | 12.5 | 15.5 | 25 | 30 | 37 | |
| | 240 V | P | kW | 4 | 5.5 | 8.5 | 13.5 | 17 | 27.5 | 33 | 40 | |
| | 380/400 V | P | kW | 5.5 | 7.5 | 11 | 18.5 | 22 | 37 | 45 | 55 | |
| | 415 V | P | kW | 7 | 10 | 14.5 | 24 | 30 | 48 | 57 | 70 | |
| | 440 V | P | kW | 7.5 | 10.5 | 15.5 | 25 | 32 | 51 | 60 | 75 | |
| | 500 V | P | kW | 7 | 12 | 17.5 | 28 | 36 | 58 | 70 | 85 | |
| | 660/690 V | P | kW | 6.5 | 11 | 14 | 23 | 30 | 63 | 75 | 90 | |

1.1

Contactors

Basic devices up to 200 A, 4 pole

1 DILMP20 ... DILMP200

| | | | | DILMP20 | DILMP32 | DILMP63 | DILMP125 | | | | |
|---|---------------|------------|-----------|------------|------------|------------|-----------|-----|-----|-----|----------|
| | | | | | DILMP45 | DILMP80 | DILMP160 | | | | DILMP200 |
| DC voltage | | | | | | | | | | | |
| Rated operational current I_e open | | | | | | | | | | | |
| DC-1 operation | | | | | | | | | | | |
| 60 V | I_e | A | 22 | 32 | 45 | 63 | 80 | 125 | 160 | 200 | |
| 110 V | I_e | A | 22 | 32 | 45 | 63 | 80 | 125 | 160 | 200 | |
| 220 V | I_e | A | 6 | 32 | 45 | 63 | 80 | 125 | 160 | 200 | |
| 440 V | I_e | A | 1.3 | 3 | 3 | 5 | 5 | 10 | 10 | 10 | |
| DC-3 operation | | | | | | | | | | | |
| 60 V | I_e | A | 20 | 32 | 45 | 63 | 80 | 125 | 160 | 200 | |
| 110 V | I_e | A | 20 | 32 | 45 | 63 | 80 | 125 | 160 | 200 | |
| 220 V | I_e | A | 1.5 | 32 | 45 | 63 | 80 | 125 | 160 | 200 | |
| 440 V | I_e | A | 0.2 | 6 | 6 | 8 | 8 | 9 | 9 | 9 | |
| DC-5 operation | | | | | | | | | | | |
| 60 V | I_e | A | 20 | 32 | 45 | 63 | 80 | 125 | 160 | 200 | |
| 110 V | I_e | A | 20 | 25 | 32 | 50 | 80 | 125 | 160 | 200 | |
| 220 V | I_e | A | 1.5 | 15 | 22 | 38 | 70 | 100 | 125 | 150 | |
| 440 V | I_e | A | 0.2 | 4 | 4 | 8 | 8 | 8 | 8 | 8 | |
| Current heat loss (3 pole) | | | | | | | | | | | |
| Current heat loss at I_{th} | | | | | | | | | | | |
| | | W | 4.7 | 8.2 | 12 | 16 | 23 | 29 | 46 | 60 | |
| Impedance per pole | | | | | | | | | | | |
| | | m Ω | 2.5 | 2 | 1.5 | 1 | 0.7 | 0.6 | 0.6 | 0.5 | |
| Magnet systems | | | | | | | | | | | |
| Voltage tolerance | | | | | | | | | | | |
| AC operated 50 Hz | Pick-up | $x U_c$ | 0.8 - 1.1 | 0.8 - 1.1 | 0.8 - 1.1 | 0.8 - 1.1 | 0.8 - 1.1 | | | | |
| AC operated 50/60 Hz | | $x U_c$ | 0.8 - 1.1 | 0.85 - 1.1 | 0.85 - 1.1 | 0.85 - 1.1 | 0.8 - 1.1 | | | | |
| AC operated | Drop-out | $x U_c$ | 0.4 - 0.6 | 0.4 - 0.6 | 0.4 - 0.6 | 0.4 - 0.6 | 0.4 - 0.6 | | | | |
| DC operated ¹⁾ | Pick-up | $x U_c$ | 0.8 - 1.1 | 0.7 - 1.2 | 0.7 - 1.2 | 0.7 - 1.2 | 0.7 - 1.2 | | | | |
| DC operated ¹⁾ | Drop-out | $x U_c$ | 0.2 - 0.6 | 0.2 - 0.6 | 0.2 - 0.6 | 0.2 - 0.6 | 0.2 - 0.6 | | | | |
| Power consumption of the coil in a cold state and $1.0 \times U_c$ | | | | | | | | | | | |
| AC operated 50/60 Hz | Pick-up | VA | 24 | 50 | | 150 | 180 | | | | |
| AC operated 50/60 Hz | Pick-up | W | 19 | 40 | | 95 | 150 | | | | |
| AC operated 50/60 Hz | Sealing | VA | 4 | 8 | | 16 | 3.1 | | | | |
| AC operated 50/60 Hz | Sealing | W | 1.2 | 2.4 | | 4 | 2.1 | | | | |
| DC operated ¹⁾ | Pick-up | W | 4.5 | 12 | | 24 | 149 | | | | |
| DC operated ¹⁾ | Sealing | W | 4.5 | 0.5 | | 0.5 | 2.1 | | | | |
| Duty factor | | | | | | | | | | | |
| | | % DF | 100 | 100 | | 100 | 100 | | | | |
| Changeover times at 100 % U_c (recommended values) | | | | | | | | | | | |
| Main contacts | | | | | | | | | | | |
| AC operated | | | | | | | | | | | |
| | Closing delay | ms | 15...21 | 16...22 | | 12...18 | 28...33 | | | | |
| | Opening delay | ms | 9...18 | 8...14 | | 8...13 | 35...41 | | | | |
| DC operated ¹⁾ | | | | | | | | | | | |
| | Closing delay | ms | 31 | 47 | | 54 | 35 | | | | |
| | Opening delay | ms | 12 | 30 | | 24 | 30 | | | | |
| Arcing time | | | | | | | | | | | |
| | | ms | 10 | 10 | | 10 | 15 | | | | |
| Permissible residual current when A1 - A2 are actuated from the electronic system (with 0 signal) | | | | | | | | | | | |
| | | mA | ≤ 1 | ≤ 1 | | ≤ 1 | ≤ 1 | | | | |

Notes

¹⁾ At least double-pulse bridge rectifier

DILK

1

| | | | DILK12 | DILK20 | DILK25 | DILK33 | DILK50 | |
|---|--------------------------------------|----|--------------------------------|-------------------|-----------------|-------------------|-------------------|------|
| General | | | | | | | | |
| Standards | | | IEC/EN 60947, VDE 0660 | | | | | |
| Ambient temperature | | | | | | | | |
| Open | °C | | -25...60 | -25...60 | -25...60 | -25...60 | -25...60 | |
| Enclosed | °C | | -25...40 | -25...40 | -25...40 | -25...40 | -25...40 | |
| Mounting position | | | | | | | | |
| Protection type | | | IP00 | IP00 | IP00 | IP00 | IP00 | |
| Protection against direct contact when actuated from front (EN 50274) | | | Finger- and back-of-hand proof | | | | | |
| Weight basic device | | | | | | | | |
| AC operated | kg | | 0.55 | 0.55 | 0.55 | 1 | 1 | |
| Terminal capacity of main cable | | | | | | | | |
| Solid | mm ² | | 1 x (0.75 - 16) | 1 x (0.75 - 16) | 1 x (0.75 - 16) | 1 x (2.5 - 16) | 1 x (2.5 - 16) | |
| Flexible with ferrule | mm ² | | 1 x (0.75 - 16) | 1 x (0.75 - 16) | 1 x (0.75 - 16) | 1 x (2.5 - 35) | 1 x (2.5 - 35) | |
| Stranded | mm ² | | 1 x 16 | 1 x 16 | 1 x 16 | 1 x (16 - 50) | 1 x (16 - 50) | |
| Solid or stranded | AWG | | 18 - 16 | 18 - 6 | 18 - 6 | 12 - 2 | 12 - 2 | |
| Flat conductor | Number of layers x width x thickness | mm | - | - | - | 1 x (6 x 9 x 0.8) | 1 x (6 x 9 x 0.8) | |
| Group compensation | | | | | | | | |
| 60 Hz | | | | | | | | |
| 230 V | kvar | | 7.5 | 11 | 15 | 20 | 25 | |
| 400 V | kvar | | 12.5 | 20 | 25 | 33.3 | 50 | |
| 525 V | kvar | | 16.7 | 25 | 33.3 | 40 | 65 | |
| 690 V | kvar | | 20 | 33.3 | 40 | 55 | 85 | |
| 50/60 Hz | | | | | | | | |
| Open | | | | | | | | |
| 230 V | I_e | A | 18 | 29 | 38 | 50 | 72 | |
| 400 V | I_e | A | 18 | 29 | 38 | 50 | 72 | |
| 525 V | I_e | A | 18 | 29 | 38 | 50 | 72 | |
| 690 V | I_e | A | 18 | 29 | 38 | 50 | 72 | |
| Enclosed | | | | | | | | |
| 230 V | I_e | A | 16 | 26 | 34 | 45 | 65 | |
| 400 V | I_e | A | 16 | 26 | 34 | 45 | 65 | |
| 525 V | I_e | A | 16 | 26 | 34 | 45 | 65 | |
| 690 V | I_e | A | 16 | 26 | 34 | 45 | 65 | |
| Making capacity (i-peak value) without damping | | | x I_e | 180 | 180 | 180 | 180 | 180 |
| Component lifespan | | | c (contacts) | x 10 ⁶ | 0.15 | 0.15 | 0.15 | 0.15 |
| Maximum operating frequency | | | Ops/h | 120 | 120 | 120 | 120 | 120 |

1.1

Contactors

Contactor for capacitors

1 DILK

| | | | DILK12 | DILK20 | DILK25 | DILK33 | DILK50 |
|---|---------------|---------|---------------|---------------|---------------|---------------|---------------|
| Magnet systems | | | | | | | |
| Voltage tolerance | | | | | | | |
| AC operated | Pick-up | $x U_c$ | 0.8 - 1.1 | 0.8 - 1.1 | 0.8 - 1.1 | 0.8 - 1.15 | 0.8 - 1.15 |
| AC operated | Drop-out | $x U_c$ | 0.3 - 0.6 | 0.3 - 0.6 | 0.3 - 0.6 | 0.3 - 0.6 | 0.3 - 0.6 |
| Power consumption of the coil in a cold state and $1.0 x U_c$ | | | | | | | |
| 50 Hz | Pick-up | VA | 58 | 58 | 58 | 45 | 45 |
| 50 Hz | Sealing | VA | 7.6 | 7.6 | 7.6 | 1.5 | 1.5 |
| 50 Hz | Sealing | W | 2.3 | 2.3 | 2.3 | 1.5 | 1.5 |
| 60 Hz | Pick-up | VA | 71 | 71 | 71 | 45 | 45 |
| 60 Hz | Sealing | VA | 9.3 | 9.3 | 9.3 | 1.5 | 1.5 |
| 60 Hz | Sealing | W | 2.8 | 2.8 | 2.8 | 1.5 | 1.5 |
| 50/60 Hz | Pick-up | VA | 65 | 65 | 65 | 45 | 45 |
| | | | 59 | 59 | 59 | 45 | 45 |
| 50/60 Hz | Sealing | VA | 9.6 | 9.6 | 9.6 | 1.5 | 1.5 |
| | | | 7 | 7 | 7 | 1.5 | 1.5 |
| 50/60 Hz | Sealing | W | 2.7 | 2.7 | 2.7 | 1.5 | 1.5 |
| | | | 2.2 | 2.2 | 2.2 | 1.5 | 1.5 |
| Duty factor | | % DF | 100 | 100 | 100 | 100 | 100 |
| Changeover times at 100 % U_c (recommended values) | | | | | | | |
| Main contacts | | | | | | | |
| AC operated | | | | | | | |
| | Closing delay | ms | 16...22 | 16...22 | 16...22 | 50 | 50 |
| | Opening delay | ms | 8...14 | 8...14 | 8...14 | 40 | 40 |
| Arcing time | | ms | 10 | 10 | 10 | 10 | 10 |
| Electromagnetic compatibility (EMC) | | | | | | | |
| Emitted interference | | | To EN 60947-1 | To EN 60947-1 | To EN 60947-1 | To EN 60947-1 | To EN 60947-1 |
| Interference immunity | | | To EN 60947-1 | To EN 60947-1 | To EN 60947-1 | To EN 60947-1 | To EN 60947-1 |
| Further technical data | | | | | | | |
| As per contactor | | DIL | M17 | M25 | M32 | M50 | M65 |

DILL

| | | | | DILL12 | DILL18 | DILL20 |
|---|----------|------------------|-------------------|---|----------|----------|
| General | | | | | | |
| Standards | | | | IEC/EN 60947, VDE 0660, UL, CSA | | |
| Lifespan, mechanical | | | | | | |
| AC operated | | c (contacts) | x 10 ⁶ | 1 | 1 | 1 |
| Operating frequency, mechanical | | | | | | |
| Mechanical, AC operated | | Operations/h | | 60 | 60 | 60 |
| Maximum operating frequency | | | | | | |
| Electrical | | Operations/h | | 60 | 60 | 60 |
| Climatic proofing | | | | Damp heat, constant, to IEC 60068-2-78; Damp heat, cyclic, to IEC 60068-2-30 | | |
| Ambient temperature | Open | °C | | -25...60 | -25...60 | -25...60 |
| | Enclosed | °C | | -25...40 | -25...40 | -25...40 |
| | Storage | °C | | -40 - 80 | -40 - 80 | -40 - 80 |
| Mounting position | | | | | | |
| Mechanical shock resistance (IEC/EN 60068-2-27) | | | | | | |
| Half-sinusoidal shock 10 ms | | | | 6.9 | 6.9 | 6.9 |
| Protection type | | | | IP00 | IP00 | IP00 |
| Weight | | | | | | |
| AC operated | | kg | | 0.42 | 0.42 | 0.42 |
| Main contacts | | | | | | |
| Rated impulse withstand voltage | | U _{imp} | V AC | 8000 | 8000 | 8000 |
| Overvoltage category/pollution degree | | | | III/3 | III/3 | III/3 |
| Rated insulation voltage | | U _i | V AC | 690 | 690 | 690 |
| Rated operating voltage | | U _e | V AC | 690 | 690 | 690 |
| Making capacity | | A | | 238 | 350 | 550 |
| Breaking capacity | | 380/400 V | A | 170 | 250 | 320 |
| Lifespan, electrical | | c (contacts) | | 10000 | 10000 | 10000 |
| Short-circuit protection rating maximum fuse | | | | | | |
| 400 V | | gG/gL 500 V | A | 63 | 100 | 125 |
| AC voltage | | | | | | |
| AC-1 operation | | | | | | |
| Conventional thermal current | | | | | | |
| at 40 °C | | I _{th} | A | 27 | 40 | 45 |
| at 60 °C | | I _{th} | A | 24 | 35 | 40 |
| 230 V | | I _e | A | 12 | 18 | 20 |
| 400 V | | I _e | A | 12 | 18 | 20 |
| AC-1 operation | | | | | | |
| 220/230 V | | I _e | A | 14 | 21 | 27 |
| 400 V | | I _e | A | 14 | 21 | 27 |
| Electric lamps | | | | | | |
| Filament bulbs | | A | | 14 | 21 | 27 |
| Mercury blended lamps | | A | | 12 | 16 | 23 |
| Fluorescent lamp load | | | | | | |
| Conventional reactor starter connection | | A | | 20 | 26 | 35 |
| Duo circuit | | A | | 20 | 26 | 35 |
| Electronic upstream devices | | A | | 12 | 18 | 20 |
| High-pressure mercury vapour lamps | | A | | 12 | 18 | 20 |
| Metal-halide lamps | | A | | 12 | 18 | 20 |
| High-pressure sodium lamps | | A | | 12 | 18 | 20 |
| Low-pressure sodium lamps | | A | | 7.5 | 10 | 12 |
| Maximum permissible compensation capacitance | | µF | | 470 | 470 | 470 |
| Further technical data | | | | | | |
| As per contactor | | DIL | | M17 | M25 | M32 |

1.1

Contactors

Contactors up to 150 A with electronic actuation

1 DILMF

DILMF8 DILMF11 DILMF14 DILMF17

General

Mounting position

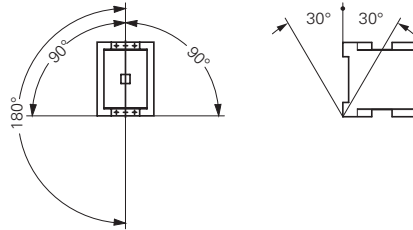

AC voltage

AC-3 operation

| | | | | | | | |
|--|-----------|-------|----|-----|-----|-----|------|
| Rated operational current AC-3 open, 50 – 60 Hz, 3 pole | 220/230 V | I_e | A | 7 | 9 | 12 | 18 |
| | 240 V I | I_e | A | 7 | 9 | 12 | 18 |
| | 380/400 V | I_e | A | 7 | 9 | 12 | 18 |
| | 415 V | I_e | A | 7 | 9 | 12 | 18 |
| | 440 V | I_e | A | 7 | 9 | 12 | 18 |
| | 500 V | I_e | A | 5 | 7 | 10 | 18 |
| | 660/690 V | I_e | A | 4 | 5 | 7 | 12 |
| Rated operational power | 220/230 V | P | kW | 2.2 | 2.5 | 3.5 | 5 |
| | 240 V | P | kW | 2.2 | 3 | 4 | 5.5 |
| | 380/400 V | P | kW | 3 | 4 | 5.5 | 7.5 |
| | 415 V | P | kW | 4 | 5.5 | 7 | 10 |
| | 440 V | P | kW | 4.5 | 5.5 | 7.5 | 10.5 |
| | 500 V | P | kW | 3.5 | 4.5 | 7 | 12 |
| | 660/690 V | P | kW | 3.5 | 4.5 | 6.5 | 11 |

AC-4 operation

| | | | | | | | |
|--|-------------|-------|----|-----|-----|-----|-----|
| Rated operational current AC-4 open, 50 - 60 Hz, 3 pole | 220/230 V I | I_e | A | 5 | 6 | 7 | 10 |
| | 240 V | I_e | A | 5 | 6 | 7 | 10 |
| | 380/400 V | I_e | A | 5 | 6 | 7 | 10 |
| | 415 V | I_e | A | 5 | 6 | 7 | 10 |
| | 440 V | I_e | A | 5 | 6 | 7 | 10 |
| | 500 V | I_e | A | 4.5 | 5 | 6 | 10 |
| | 660/690 V | I_e | A | 4 | 4.5 | 5 | 8 |
| Rated operational power | 220/230 V | P | kW | 1 | 1.5 | 2 | 2.5 |
| | 240 V | P | kW | 1.5 | 1.6 | 2.2 | 3 |
| | 380/400 V | P | kW | 2.2 | 2.5 | 3 | 4.5 |
| | 415 V | P | kW | 2.3 | 2.8 | 3.4 | 5 |
| | 440 V | P | kW | 2.4 | 3 | 3.6 | 5.5 |
| | 500 V | P | kW | 2.5 | 2.8 | 3.5 | 6 |
| | 660/690 V | P | kW | 2.9 | 3.6 | 4.4 | 6.5 |

Current heat loss (3 pole)

| | | | | | | |
|--|--|---|-----|-----|-----|-----|
| Current heat loss at I_{th} | | W | 2.4 | 2.4 | 2.4 | 7.3 |
| Current heat loss at I_e to AC-3/400 V | | W | 0.3 | 0.6 | 1 | 1.9 |

Magnet systems

| | | | | | | | |
|--|----------------------|----------|---------|------------|------------|------------|------------|
| Voltage tolerance | AC operated | Pick-up | $x U_c$ | 0.8 - 1.15 | 0.8 - 1.15 | 0.8 - 1.15 | 0.8 - 1.15 |
| | AC operated | Drop-out | $x U_c$ | 0.2 - 0.5 | 0.2 - 0.5 | 0.2 - 0.5 | 0.2 - 0.5 |
| Power consumption of the coil in a cold state and $1.0 \times U_c$ | Electronic actuation | Pick-up | VA | 14 | 14 | 14 | 14 |
| | Electronic actuation | Sealing | VA | 0.7 | 0.7 | 0.7 | 0.7 |
| | Electronic actuation | Sealing | W | 0.7 | 0.7 | 0.7 | 0.7 |
| Duty factor | | % DF | 100 | 100 | 100 | 100 | |
| Switching times | Closing delay | ms | 40 | 40 | 40 | 40 | |
| | Opening delay | ms | 45 | 45 | 45 | 45 | |

suitable according to

SEMI F47 SEMI F47 SEMI F47 SEMI F47

Electromagnetic compatibility (EMC)

| | |
|-----------------------|---------------|
| Emitted interference | To EN 60947-1 |
| Interference immunity | To EN 60947-1 |

Further technical data

| | | | | | |
|------------------|-----|----|----|-----|-----|
| As per contactor | DIL | M7 | M9 | M12 | M17 |
|------------------|-----|----|----|-----|-----|

Terminal type

| | | | | | |
|------------------|-----|-----|-----|-----|-----|
| As per contactor | DIL | M17 | M17 | M17 | M17 |
|------------------|-----|-----|-----|-----|-----|

| DILMF25 | DILMF32 | DILMF40 | DILMF50 | DILMF65 | DILMF80 | DILMF95 | DILMF115 | DILMF150 |
|---------|---------|---------|---------|---------|---------|---------|----------|----------|
|---------|---------|---------|---------|---------|---------|---------|----------|----------|

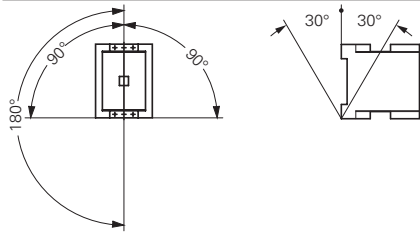

| | | | | | | | | |
|------|----|------|------|----|------|----|-----|-----|
| 25 | 32 | 40 | 50 | 65 | 80 | 95 | 115 | 150 |
| 25 | 32 | 40 | 50 | 65 | 80 | 95 | 115 | 150 |
| 25 | 32 | 40 | 50 | 65 | 80 | 95 | 115 | 150 |
| 25 | 32 | 40 | 50 | 65 | 80 | 95 | 115 | 150 |
| 25 | 32 | 40 | 50 | 65 | 80 | 95 | 115 | 150 |
| 15 | 18 | 25 | 32 | 37 | 65 | 80 | 93 | 100 |
| 7.5 | 10 | 12.5 | 15.5 | 20 | 25 | 30 | 37 | 48 |
| 8.5 | 11 | 13.5 | 17 | 22 | 27.5 | 4 | 40 | 52 |
| 11 | 15 | 18.5 | 22 | 30 | 37 | 45 | 55 | 75 |
| 14.5 | 19 | 24 | 30 | 39 | 48 | 57 | 70 | 91 |
| 15.5 | 20 | 25 | 32 | 41 | 51 | 60 | 75 | 95 |
| 17.5 | 23 | 28 | 36 | 47 | 58 | 70 | 85 | 110 |
| 14 | 17 | 23 | 30 | 35 | 63 | 75 | 90 | 96 |

| | | | | | | | | |
|-----|-----|-----|-----|-----|----|----|----|----|
| 13 | 15 | 18 | 21 | 25 | 40 | 50 | 55 | 65 |
| 13 | 15 | 18 | 21 | 25 | 40 | 50 | 55 | 65 |
| 13 | 15 | 18 | 21 | 25 | 40 | 50 | 55 | 65 |
| 13 | 15 | 18 | 21 | 25 | 40 | 50 | 55 | 65 |
| 13 | 15 | 18 | 21 | 25 | 40 | 50 | 55 | 65 |
| 13 | 15 | 18 | 21 | 25 | 40 | 50 | 55 | 65 |
| 10 | 12 | 14 | 17 | 20 | 27 | 37 | 45 | 50 |
| 3.5 | 4 | 5 | 6 | 7 | 12 | 16 | 17 | 20 |
| 4 | 4.5 | 5.5 | 6.5 | 7.5 | 13 | 17 | 19 | 22 |
| 6 | 7 | 9 | 10 | 12 | 20 | 26 | 28 | 33 |
| 6.5 | 7.5 | 9.5 | 11 | 13 | 24 | 30 | 33 | 39 |
| 7 | 8 | 10 | 12 | 14 | 25 | 32 | 35 | 41 |
| 8 | 9 | 11 | 13 | 16 | 29 | 36 | 40 | 47 |
| 8.5 | 10 | 12 | 14 | 17 | 26 | 35 | 43 | 48 |

| | | | | | | | | |
|-----|------|------|------|------|------|------|------|------|
| 9.6 | 12.1 | 11.3 | 19 | 28.8 | 14.6 | 21.8 | 30.4 | 46.1 |
| 3.8 | 6.1 | 7.2 | 11.3 | 19 | 11.5 | 16.2 | 23.8 | 40.5 |

| | | | | | | | | |
|------------|------------|------------|------------|------------|------------|------------|------------|------------|
| 0.8 - 1.15 | 0.8 - 1.15 | 0.8 - 1.15 | 0.8 - 1.15 | 0.8 - 1.15 | 0.8 - 1.15 | 0.8 - 1.15 | 0.8 - 1.15 | 0.8 - 1.15 |
| 0.2 - 0.5 | 0.2 - 0.5 | 0.2 - 0.5 | 0.2 - 0.5 | 0.2 - 0.5 | 0.2 - 0.5 | 0.2 - 0.5 | 0.2 - 0.5 | 0.2 - 0.5 |
| 14 | 14 | 45 | 45 | 45 | 75 | 75 | 180 | 180 |
| 0.7 | 0.7 | 1.5 | 1.5 | 1.5 | 2 | 2 | 3.1 | 3.1 |
| 0.7 | 0.7 | 1.5 | 1.5 | 1.5 | 2 | 2 | 2.1 | 2.1 |
| 100 | 100 | 100 | 100 | 100 | 100 | 100 | 100 | 100 |
| 40 | 40 | 50 | 50 | 50 | 55 | 55 | 40 | 40 |
| 45 | 45 | 45 | 45 | 45 | 40 | 40 | 40 | 40 |
| SEMI F47 | SEMI F47 | SEMI F47 | SEMI F47 | SEMI F47 | SEMI F47 | SEMI F47 | SEMI F47 | SEMI F47 |

To EN 60947-1
To EN 60947-1

| | | | | | | | | |
|-----|-----|-----|-----|-----|-----|-----|------|------|
| M25 | M32 | M40 | M50 | M65 | M80 | M95 | M115 | M150 |
| M25 | M32 | M40 | M50 | M65 | M80 | M95 | M115 | M150 |

1.1

Contactors

Auxiliary contact modules

1 DILM..., DILA...

| | | | DILM7-... - DILM38-... | DILA- XHI(C)...(-S) | DILM32- XHI(C)...(-S) | DILM150- XHI... | DILM1000-XHI... DILM820-XHI... |
|---|-------------------|----------------|--|------------------------|--------------------------|---------------------|---|
| Auxiliary contact | | | | | | | |
| Interlocked opposing contacts within an auxiliary contact module (to IEC 60947-5-1 Annex L) ¹⁾ | | | - | Yes | Yes | Yes | Yes |
| Normally closed (not late-normally closed) suitable as a mirror contact (to IEC/EN 60947-4-1, Annex F) | | | DILM7 - DILM38 | DILM7 - DILM38 | DILM7 - DILM38 | DILM40 - DILM170 | DILM40 - DILM225A DILM250 - DILM1000 |
| Rated impulse withstand voltage | U _{imp} | V AC | 6000 | 6000 | 6000 | 6000 | 6000 |
| Overvoltage category/pollution degree | | | III/3 | III/3 | III/3 | III/3 | III/3 |
| Rated insulation voltage | U _i | V AC | 690 | 690 | 690 | 690 | 690 |
| Rated operating voltage | U _e | V AC | 500 | 500 | 500 | 500 | 500 |
| Safe isolation according to EN 61140 | | | | | | | |
| Between coil and auxiliary contacts | | V AC | 400 | 400 | 400 | 440 | 440 |
| Between the auxiliary contacts | | V AC | 400 | 400 | 400 | 440 | 440 |
| Rated operational current | | | | | | | |
| AC-15 | | | | | | | |
| | 230 V | I _e | A | 4 | 4 | 4 | 4 |
| | 380/415 V | I _e | A | 4 | 4 | 4 | 4 |
| | 500 V | I _e | A | 1.5 | – | 1.5 | 1.5 |
| DC L/R ≅ 15 ms ²⁾ | | | | | | | |
| | 24 V | I _e | A | 10 | 10 | 10 | 10 |
| | 60 V | I _e | A | 6 | 6 | 6 | 6 |
| | 110 V | I _e | A | 3 | 3 | 3 | 3 |
| | 220 V | I _e | A | 1 | 1 | 1 | 1 |
| DC-13 (6xP) | | | | | | | |
| Contacts in series: | | | | | | | |
| | 3 | 24 V | A | 2.5 | 2.5 | 2.5 | – |
| | 3 | 60 V | A | 1 | 1 | 1 | – |
| | 3 | 110 V | A | 0.5 | 0.5 | 0.5 | – |
| | 3 | 220 V | A | 0.25 | 0.25 | 0.25 | – |
| Conventional thermal current | I _{th} | A | 10 | 16 | 16 | 16 | 10 |
| Control circuit reliability (at U _e = 24 V DC, U _{min} = 17 V, I _{min} = 5.4 mA) | Fault probability | λ | < 10 ⁻⁸ , < 1 one failure in 100 million operations | | | | |
| Component lifespan | | | | | | | |
| at U _e = 230 V, AC-15, 3 A | | c (contacts) | x 10 ⁶ | 1.3 | 1.3 | 1.3 | 1.3 |
| Short-circuit rating without welding | | | | | | | |
| Max. fuse | | A gG/gL | 10 | 10 | 10 | 16 | 16 |

Notes

¹⁾ Not with DIL...-XHIV and DIL...-XHICV.

²⁾ Switch-on and switch-off conditions based on DC-13, time constant as specified.

P1SIL...M, DILM...-XP1

1

| | | | P1DILEM DILM12-XP1 | DILM32-XP1 | DILM65-XP1 | DILM150-XP1 | DILM185-XP1 |
|--|--------------------------------------|-----------------|----------------------------------|---------------|----------------|----------------------------------|--|
| Parallel connector | | | | | | | |
| Terminal capacity | | | | | | | |
| Solid | | mm ² | 1 - 16 | 16 | 16 | – | – |
| Flexible with ferrule | | mm ² | 1 x (0.5 - 25) 2 x (0.5 - 16) | 1 x (16 - 35) | 1 x (16 - 120) | – | – |
| Stranded | | mm ² | 1 x (0.5 - 25) 2 x (0.5 - 16) | 1 x (16 - 50) | 1 x (16 - 120) | 1 x (35 - 300) 2 x (35 - 120) | – |
| Flat conductor | Number of layers x width x thickness | mm | 6 x 9 x 0.8 | – | – | 2 x (11 x 21 x 1) | 1 x (6 x 16 x 0.8) 2 x (20 x 32 x 0.5) 2 x (11 x 21 x 1) |
| Tightening torque | | Nm | 4 | 4 | 14 | 14 | 6 |
| Terminal capacity of control circuit cable | | | | | | | |
| Solid | | mm ² | – | – | – | – | 1 x (0.75 - 4) 2 x (0.75 - 4) |
| Flexible with ferrule | | mm ² | – | – | – | – | 1 x (0.75 - 2.5) 2 x (0.75 - 2.5) |
| Tools | | | | | | | |
| Pozidriv screwdriver | | Size | 2 | 2 | – | – | – |
| Internal hexagon | SW | mm | – | – | 5 | 6 | 5 |
| Conventional thermal current | | | | | | | |
| 3 pole | I _{th} | A | 50 | 100 | 180 | 400 | 700 |
| 4 pole | I _{th} | A | 60 | – | – | – | – |

1.1

Contactors

Minicontactor relay, contactor combination

Dimensions

1 Mini contactor relays

DILER-...(-C)
DILER-...-G(-C)

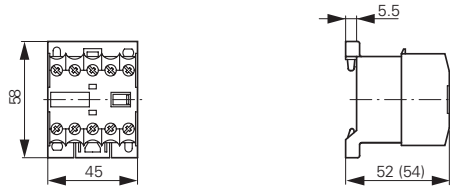

DILER-...(-C) + ...DILE(-C)
DILER-...-G(-C) + ...DILE(-C)

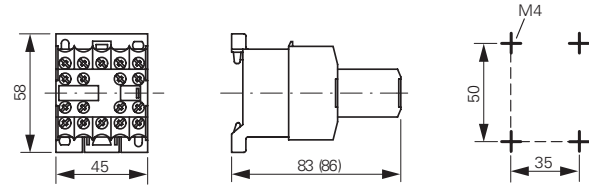

DILEEM-..., DILEM-...(-C), DILEM-12-...
DILEEM-...-G, DILEM-...-G(-C), DILEM-12-...-G

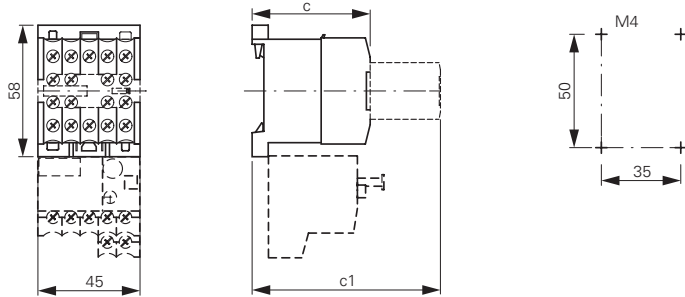

| Part no. | c | c1 |
|--------------------|----|----|
| DILE(E)M-...(-G) | 52 | 83 |
| DILE(E)M-...-G(-C) | 54 | 86 |

DILER-... + HDILE
DILER-...-G + HDILE



Suppressor circuit

RCDILE...
VGDILE

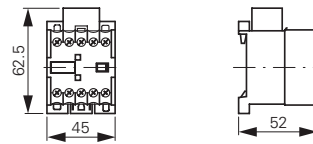

2DILE-... + MVDILE
2DILE-...-G + MVDILE

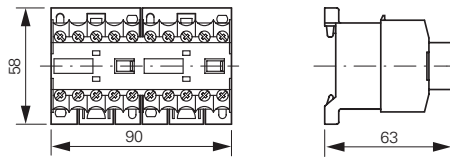

2DILE-... + MVDILE + ...DILE
2DILE-...-G + MVDILE + ...DILE

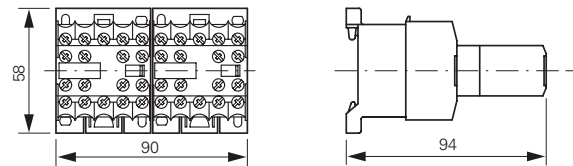

Star-delta contactors

DIULEM

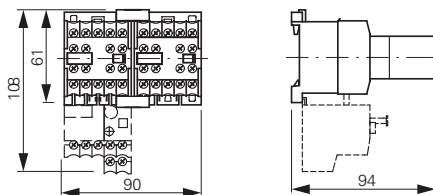

Star-delta contactors

SDAINLEM

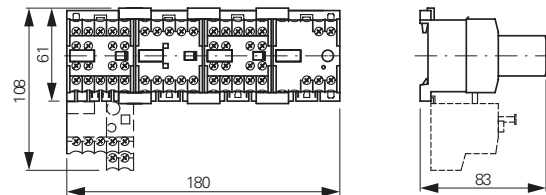

DILER-... + TDDILE24

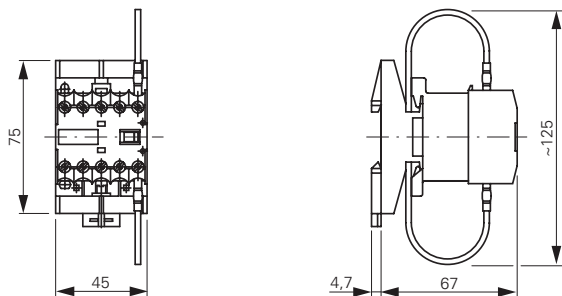

Parallel connector

P1DILEM

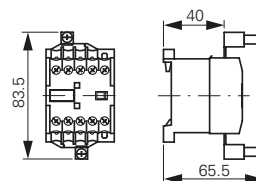

Contactor with auxiliary contact module

DILM7...DILM15

DILA...

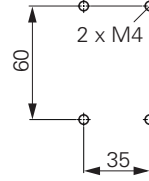
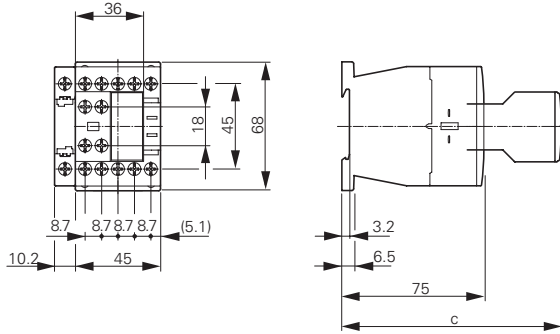

| Part no. | c |
|--------------|-----|
| DILM32-XHI | 117 |
| DILA-XHI | 117 |
| DILA-XHI...T | 125 |

DILMC7...DILMC15

DILAC...

DILA-XHIC...

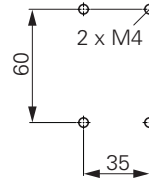
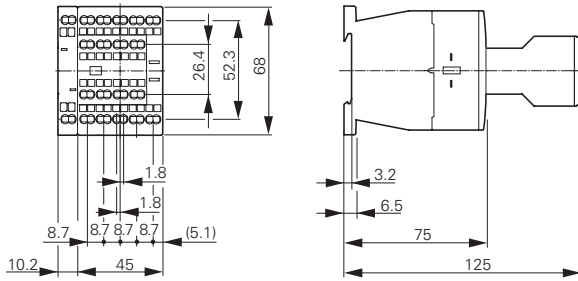

DILM17...DILM38

DILMC17...DILMC32

DILMF8...DILMF32

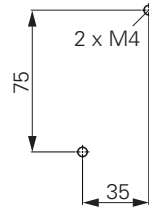
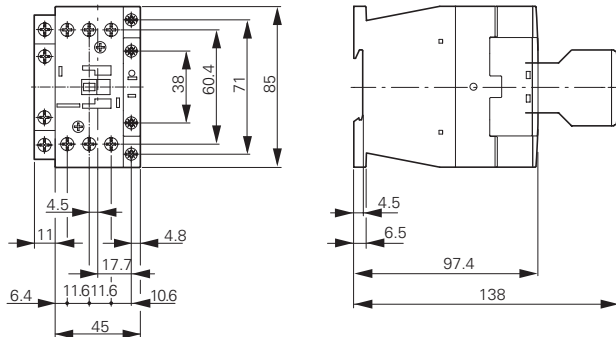

Clearance at side to grounded parts: 6 mm

1.1

Contactors

Basic devices up to 170 A, suppressor circuit

1 Contactors

DILM40...DILM72
DILMC40...DILMC65
DILMF40...DILMF65

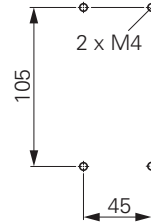
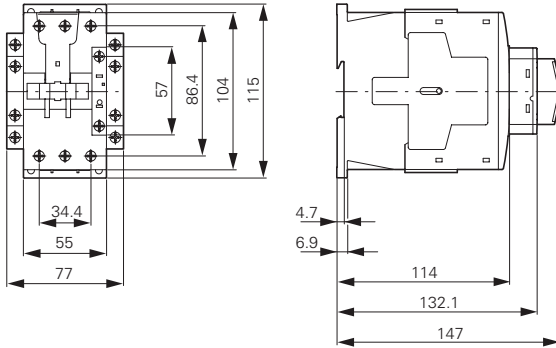

Clearance at side to grounded parts: 6 mm

DILM80...DILM170
DILMC80...DILMC150
DILMF80...DILMF150

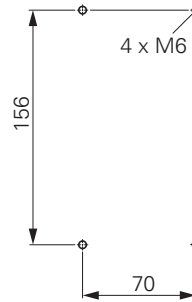
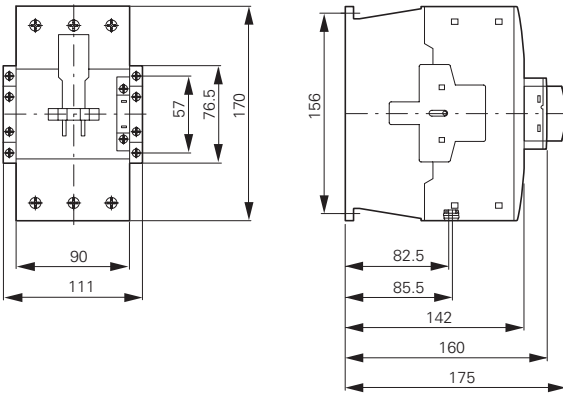

Clearance at side to grounded parts: 10 mm

Suppressor circuits

DILM...XSP...

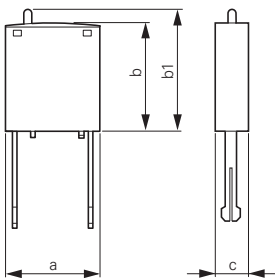

| Part no. | a | b | b1 | c |
|---------------|----|----|-----|---|
| DILM12-XSP... | 25 | 28 | ≈32 | 9 |
| DILM32-XSP... | 25 | 28 | ≈32 | 9 |
| DILM95-XSP... | 25 | 28 | ≈32 | 9 |

Contactor with auxiliary contact module

DILMP20

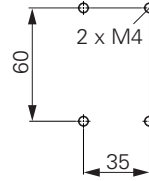
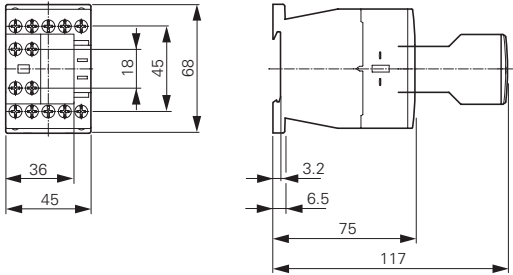

DILMP32 DILMP45

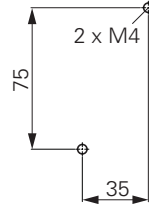
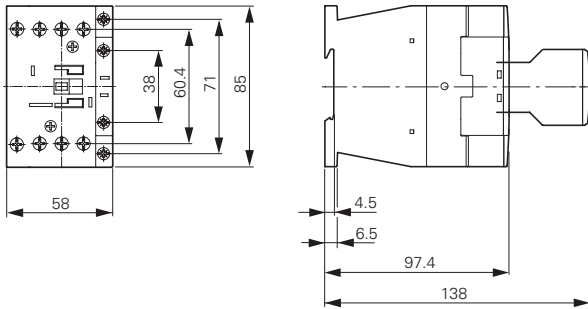

Distance at side to grounded parts: 6 mm

Contactors

DILMP63 DILMP80

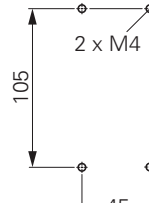
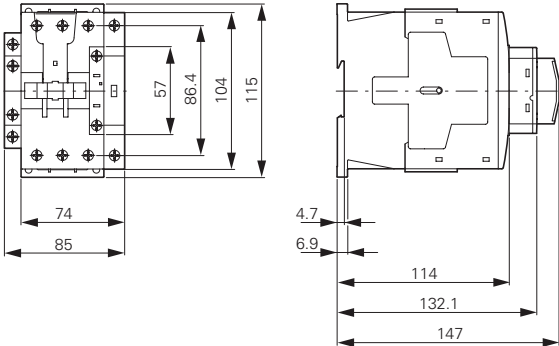

Distance at side to grounded parts: 6 mm

DILMP125 DILMP160 DILMP200

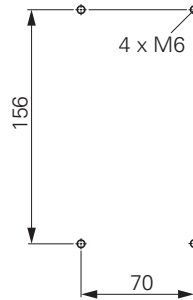
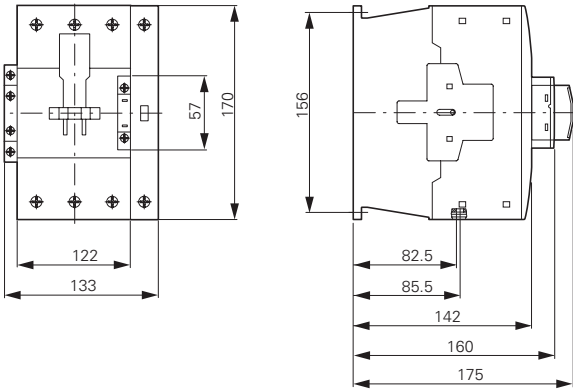

Clearance at side to earthed parts: 10 mm

Motor suppressor module

DILM12-XMSM

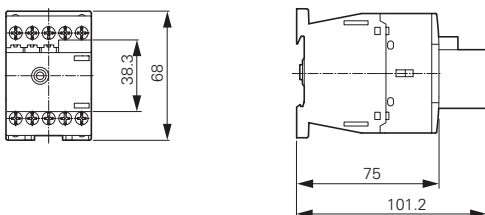

1.1

Contactors

Complete units for currents greater than 170 A

1 Complete units

DILM185A...DILM500
DILM250-S...DILM570-S

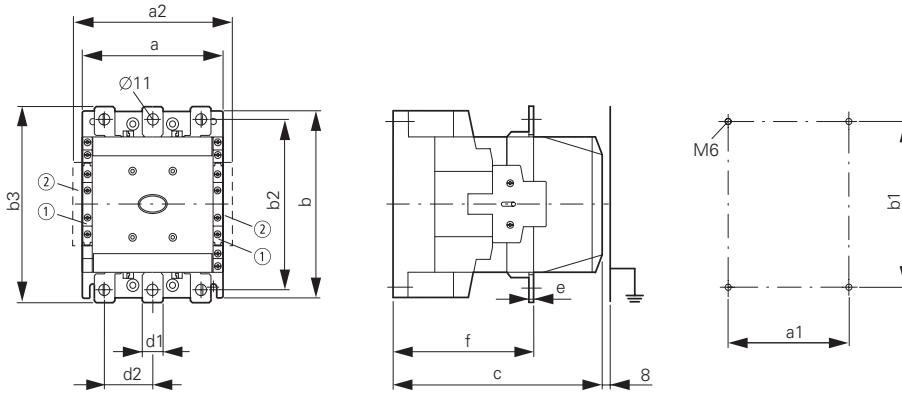

- ① DILM1000-XHI...-SI
- ② DILM1000-XHI11-SA

| Part no. | a | a1 | a2 | b | b1 | b2 | b3 | d1 | d2 | e | c | f |
|----------|-----|-----|-----|-----|-----|-----|-----|----|----|---|-----|-----|
| DILM185A | 140 | 120 | 160 | 180 | 160 | 165 | 190 | 20 | 41 | 5 | 158 | 83 |
| DILM225A | 140 | 120 | 160 | 180 | 160 | 165 | 190 | 20 | 41 | 5 | 158 | 83 |
| DILM250 | 140 | 120 | 160 | 180 | 160 | 164 | 189 | 25 | 48 | 5 | 208 | 140 |
| DILM300A | 140 | 120 | 160 | 180 | 160 | 164 | 189 | 25 | 48 | 5 | 208 | 140 |
| DILM400 | 160 | 130 | 180 | 200 | 180 | 184 | 209 | 25 | 48 | 6 | 216 | 140 |
| DILM500 | 160 | 130 | 180 | 200 | 180 | 189 | 219 | 38 | 57 | 6 | 216 | 140 |
| DILM570 | 160 | 130 | 180 | 200 | 180 | 189 | 219 | 38 | 57 | 6 | 216 | 140 |

DILM580...DILM1000

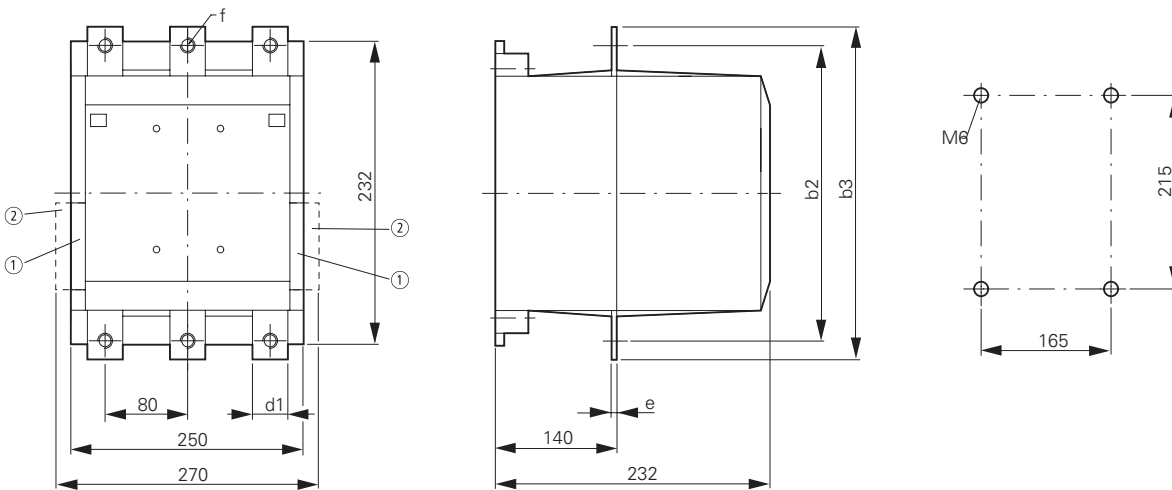

- ① DILM820-XHI...-SI
- ② DILM820-XHI11-SA

| Part no. | b2 | b3 | d1 | e | f |
|----------|-----|-----|----|----|------|
| DILM580 | 256 | 296 | 45 | 6 | 13.5 |
| DILM650 | 256 | 296 | 45 | 6 | 13.5 |
| DILM750 | 256 | 296 | 45 | 6 | 13.5 |
| DILM820 | 256 | 296 | 45 | 6 | 13.5 |
| DILM1000 | 256 | 296 | 45 | 10 | 13.5 |

AC-1 contactors greater than 1000 A

DILH1400

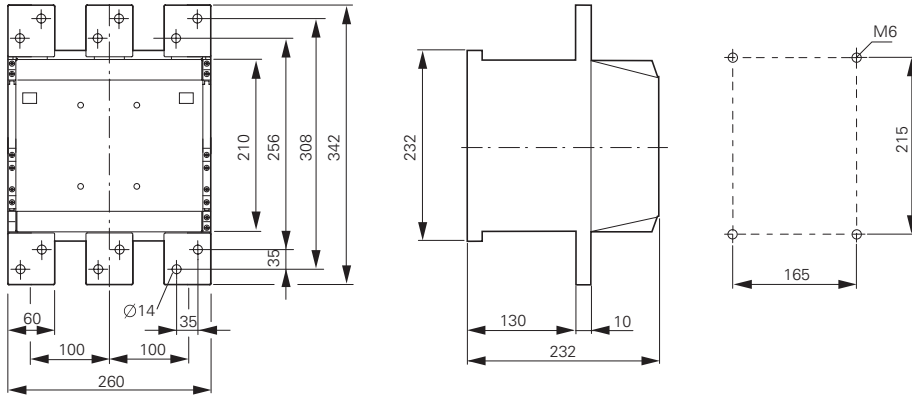

DILM1600

DILH2000

DILH2200

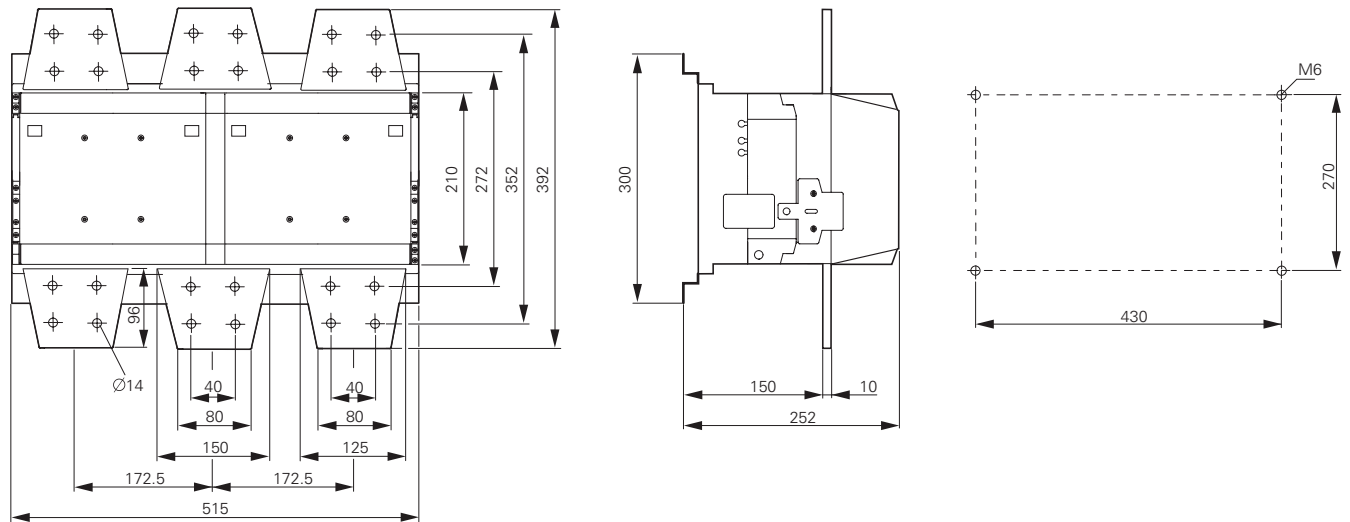

DILH2600

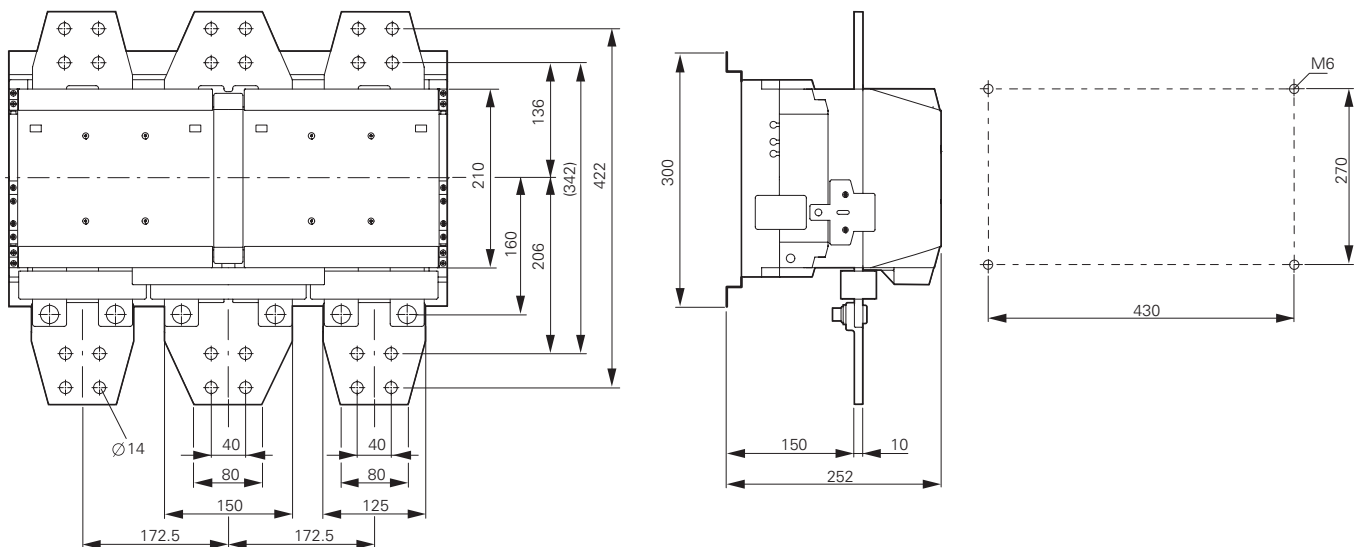

1.1

Contactors

Capacitor contactors, lamp contactors, contactor monitoring devices, SWD contactor modules

1 Contactor for capacitors

DILK...

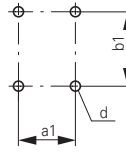
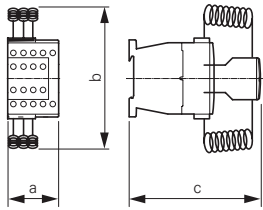

| Part no. | a | b | c | a1 | b1 | d |
|----------|----|-----|-----|----|-----|--------|
| DILK12 | 45 | 135 | 138 | 35 | 75 | 2 x M4 |
| DILK20 | 45 | 135 | 138 | 35 | 75 | 2 x M4 |
| DILK25 | 45 | 135 | 138 | 35 | 75 | 2 x M4 |
| DILK33 | 55 | 190 | 147 | 45 | 105 | 2 x M4 |
| DILK50 | 55 | 190 | 147 | 45 | 105 | 2 x M4 |

Illumination contactors

DILL...

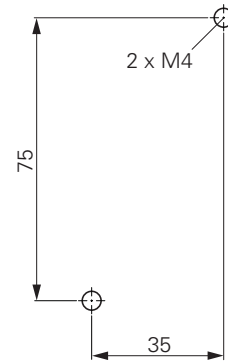
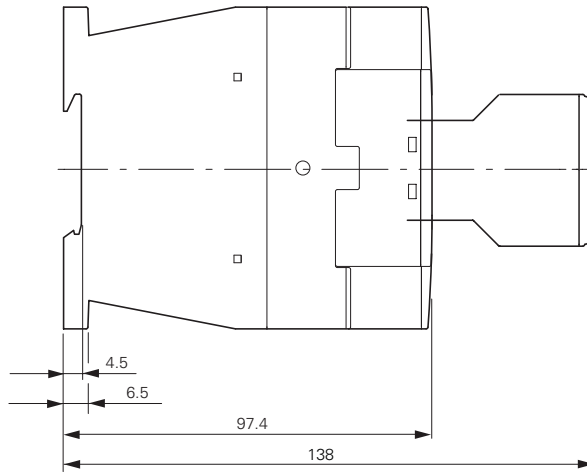
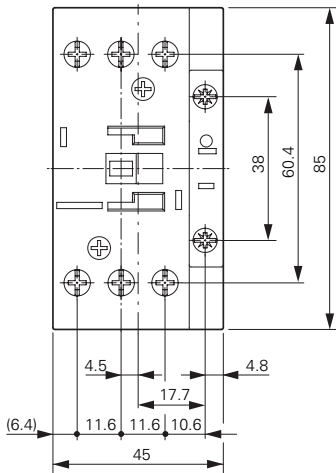

Clearance at side to grounded parts: 6 mm

Contactor monitoring devices

CMD(...)

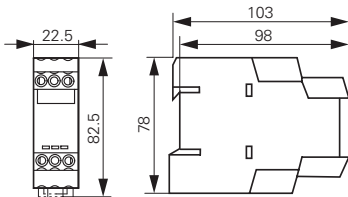

SWD contactor modules

DIL-SWD-32...

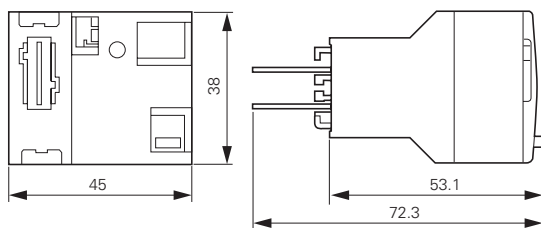

Star-delta contactors

SDAINLM12...SDAINLM115

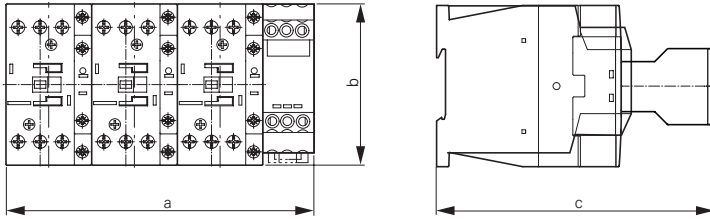

| Part no. | a | b | c |
|-----------------|-----|-----|-----|
| SDAINLM12...22 | 158 | 68 | 117 |
| SDAINLM30...55 | 158 | 85 | 138 |
| SDAINLM70...115 | 188 | 115 | 147 |

SDAINLM140...SDAINLM260

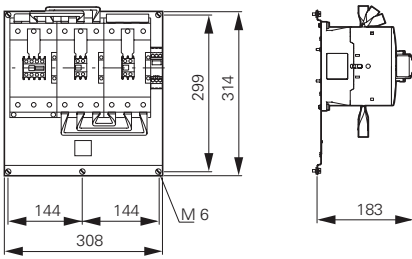

Reversing contactors

DIULM7...DIULM65

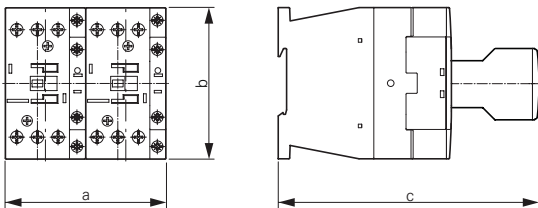

| Part no. | a | b | c |
|--------------------|-----|-----|-----|
| DIULM7/21...12/21 | 90 | 68 | 117 |
| DIULM17/21...32/21 | 90 | 85 | 138 |
| DIULM40/11...65/11 | 110 | 115 | 147 |

DIULM80...DIULM150

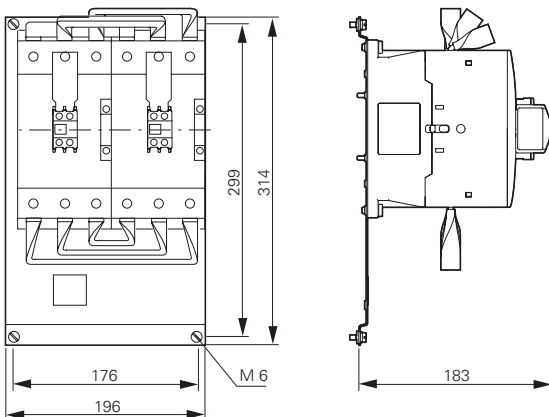

1.1 Contactors

Accessories

1 Three-phase commoning links

DILM12-XDSB...

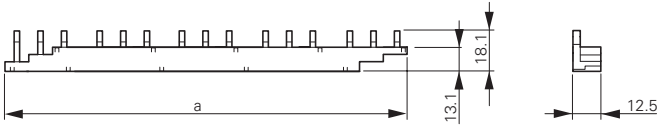

| Part no. | a |
|----------------|-----|
| DILM12-XDSB0/3 | 112 |
| DILM12-XDSB0/4 | 157 |
| DILM12-XDSB0/5 | 202 |

Electronic timer modules

DILM...XTE

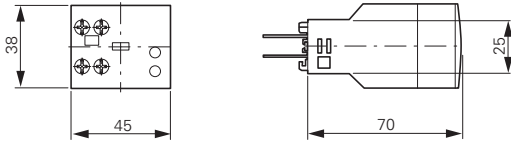

Amplifier module

ETS4-VS3

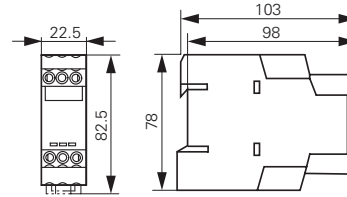

Wiring set for motor feeder plug

DILM12-XMCE

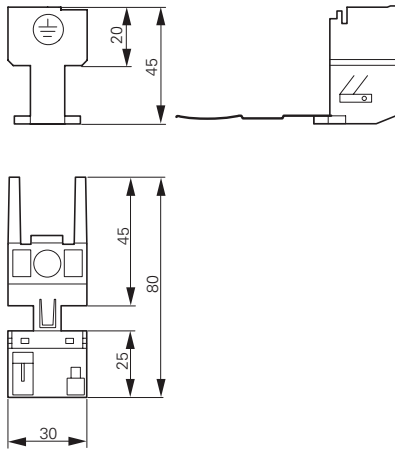

DILM12-XMCP/T

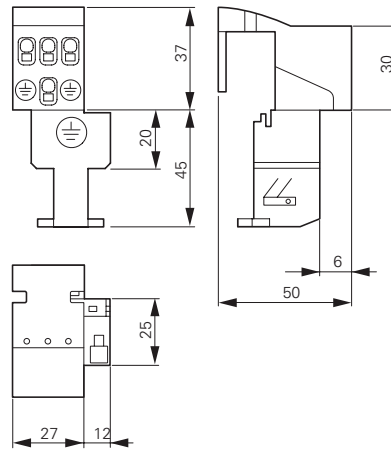

DILM12-XMCP/E

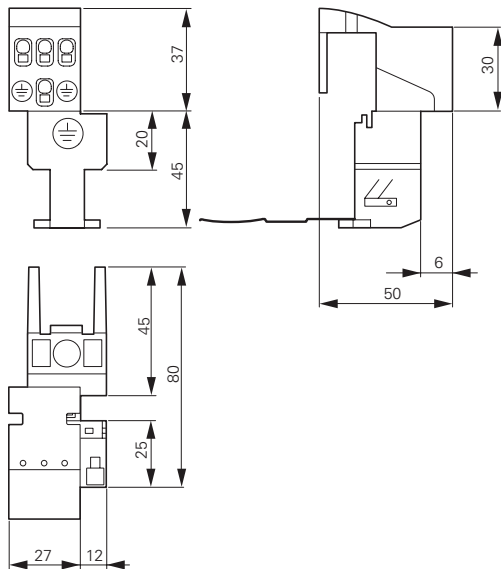

Contactors with terminal shrouds

DILM250...DILM1000 + DILM...-XHB

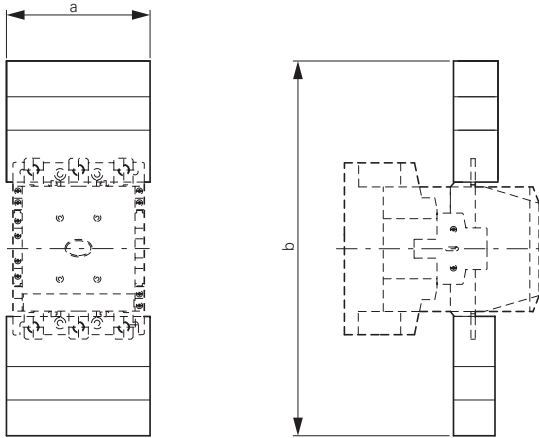

| for part no. | a | b |
|-------------------|-----|-----|
| DILM250, DILM300A | 150 | 384 |
| DILM400 | 150 | 404 |
| DILM500 | 174 | 426 |
| DILM580...1000 | 236 | 506 |

DILM250 + Z5-.../FF250

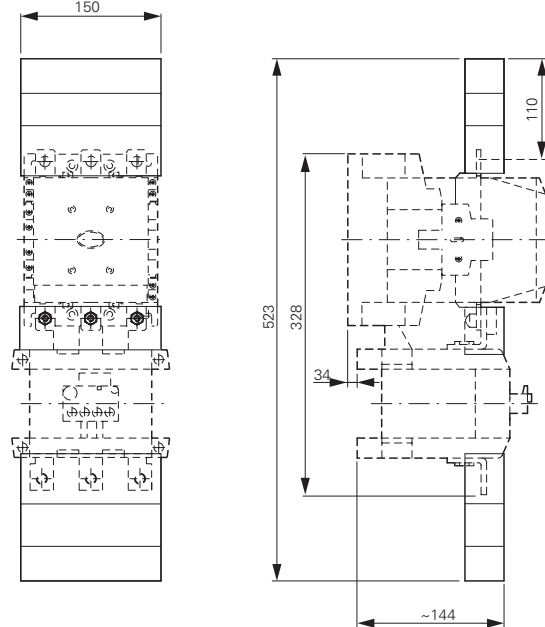

DILM185A...DILM225A + DILM225A-XHB

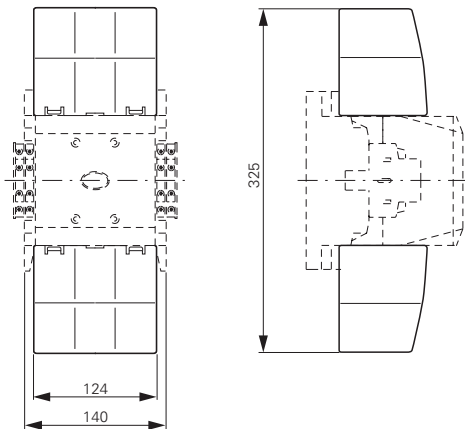

Contactor with star-point bridge and terminal shroud

DILM...XS1

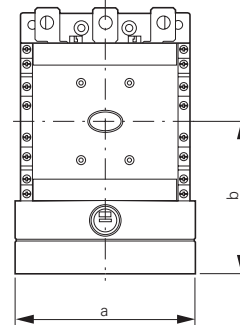

| for part no. | a | b |
|---------------|-----|-----|
| DILM185...250 | 150 | 127 |
| DILM300...400 | 150 | 137 |
| DILM500 | 176 | 146 |

Mechanical interlock

DILM500-XMV

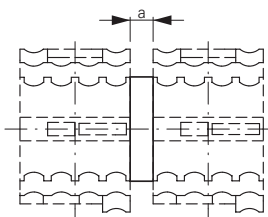

| for part no. | a |
|---------------|----|
| DILM185...500 | 15 |

DILM820-XMV

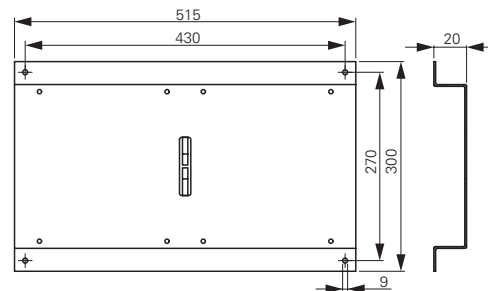



Overload relay

Motor protection is a central task of electrical equipment for machinery. From cost-effective bimetal solutions to demanding full motor protection with cross-linkage - we offer the right solution for each application.

ATEX 

Bimetal relay - overload relay up to 630 A

- Direct mounting on contactor saves mounting time.
- ATEX approval for the protection of EEx e motors up to 250 A.
- Comprehensive motor protection through phase failure sensitivity.
- Integrated test pushbutton facilitates high safety → Page 6.



ZEB electronic overload relay - overload relay up to 1500 A

- ATEX approval for protection of EEx e motors up to 1500 A.
- Adjustable tripping classes.
- Phase failure and unbalance protection.
- Optional earth fault detection.
- Additional current setting range (5:1) → Page 14.

EMT6 thermistor overload relay for machine protection

- Overload protection through direct evaluation of winding temperature.
- Quick detection of operating state through LED display.
- Suitable for overload monitoring of motors in EEx e range.
- Wide range power supply reduces amount of types → Page 19.



Technical overview

| | |
|---|---|
| Bimetal relay ZE, ZB, Z5 | 2 |
| Overload relay ZW7 | 2 |
| Electronic overload relays ZEB | 4 |
| EMT6 thermistor overload relay for machine protection | 4 |

Ordering

| | |
|--|----|
| Bimetal relays for mini-contactor relays | 6 |
| Bimetal relays up to 150 A | 8 |
| Bimetal relay greater than 150 A | 12 |
| Overload relays | 12 |
| Bimetal relay accessories | 21 |
| ZEB electronic overload relay | 14 |

Ordering

| | |
|---|----|
| EMT6 thermistor overload relay for machine protection | 19 |
|---|----|

Engineering

| | |
|---|----|
| EMT6 thermistor overload relay for machine protection | 20 |
| Selection criteria ZE, ZB, Z5, ZW7 | 23 |
| Characteristic curve ZB, Z5, ZW7 | 23 |
| UL/CSA short-circuit strength ZE, ZB, Z5 | 24 |

Technical data

| | |
|---|----|
| Bimetal relay for mini-contactor relays | 25 |
| Bimetal relays up to 150A | 25 |
| Overload relays greater than 150 A | 26 |
| Overload relays | 26 |
| ZEB electronic overload relay | 28 |
| EMT6 thermistor overload relay for machine protection | 29 |

Dimensions

| | |
|---|----|
| Bimetal relays for mini-contactor relays | 30 |
| Bimetal relays up to 150A | 30 |
| Bimetal relays greater than 150 A | 32 |
| Overload relay | 32 |
| ZEB electronic overload relay | 33 |
| EMT6 thermistor overload relay for machine protection | 35 |

1.2

Overload relays

Overload relays, CT-operated overload relays

1 Technical overview

Overload relays, CT-operated overload relays

Setting ranges (A)
(note max. current of the contactor)



DILEM

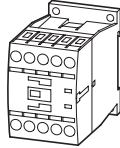

DILM7 DILM12
DILM9 DILM15

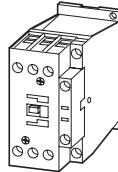

DILM17 DILM32
DILM25 DILM38

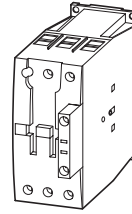

DILM40 DILM65
DILM50 DILM72

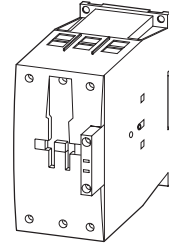

DILM80 DILM150
DILM95 DILM170
DILM115

Overload relays

ZE
0.1-12

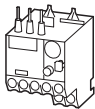

ZB12
0.1-16

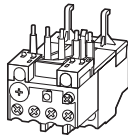

ZB32
0.1-38

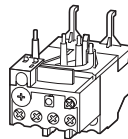

ZB65
6-75

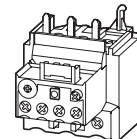

ZB150
35-175

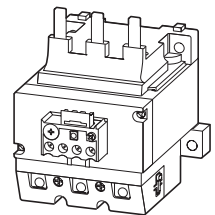

Z5-.../FF225A
70-250

Z5-.../FF250
50-300

Current transformer-operated overload relay

ZW7-...
42-630

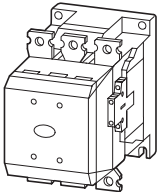

DILM185A
DILM225A

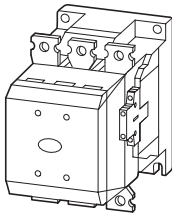

DILM250
DILM300

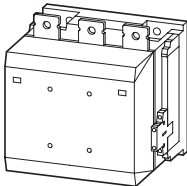

DILM400 DILM580
DILM500

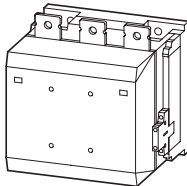

DILM650

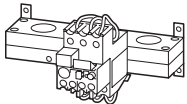
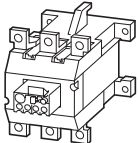
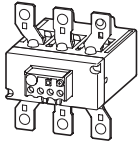

1.2

Overload relays

Electronic overload relays, thermistor overload relay for machine protection

1 Electronic overload relays, thermistor overload relay for machine protection

Setting ranges (A)
(note max. current of the contactor)



DILEM

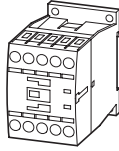

**DILM7 DILM12
DILM9 DILM15**

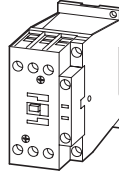

**DILM17 DILM32
DILM25 DILM38**

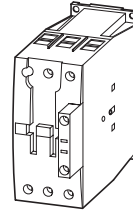

**DILM40 DILM65
DILM50 DILM72**

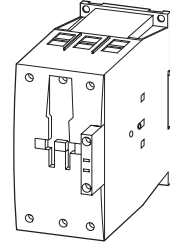

**DILM80 DILM150
DILM95 DILM170
DILM115**

Electronic overload relays

ZEB12
0.33-20

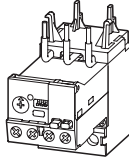

ZEB32
0.33-45

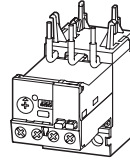

ZEB65
9-100

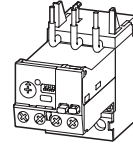

ZEB150
20-100

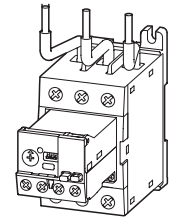

ZEB32-5-(GF)/KK combined with

ZEB-XCT300
60-300

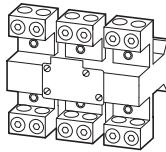

ZEB-XCT600
120-600

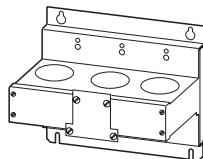

ZEB-XCT1000
200-1000

ZEB-XCT1500
300-1500

Thermistor overload relay for machine protection

EMT6((DB)K)

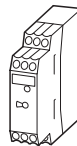

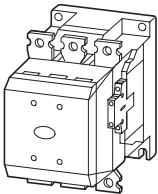

DILM185A
DILM225A

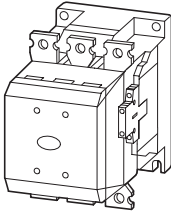

DILM250
DILM300

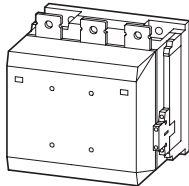

DILM400
DILM500

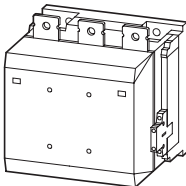

DILM580
DILM650

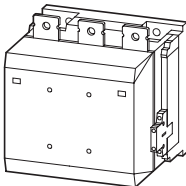

DILM750
DILM820

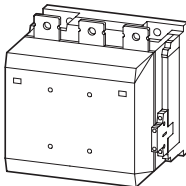

DILM1000

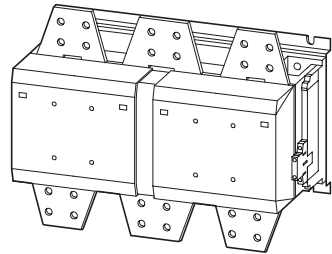

DILM1600



1.2

Overload relays

Bimetal relays for mini-contactor relays

1 Ordering

ZE overload relays for mini contactor relays

- Phase failure sensitivity to IEC/EN 60947, VDE 0660 Part 102
- Test/off pushbutton
- Reset pushbutton manual/auto
- Trip-free release
- Direct mounting

| Setting range of overload releases | Circuit symbol | Auxiliary contact | | For use with | Short-circuit protection | |
|------------------------------------|----------------|---|------|-----------------------------------|-------------------------------------|-------------------------------------|
| | | N/O = normally open contact NC = normally closed contact | | | Type "1" coordination gG/gL A | Type "2" coordination gG/gL A |
| I_r A | | | | | | |
| 0.1 – 0.16 | | 1 N/O | 1 NC | DILEM DIULEM/21/MV SDAINLEM | 20 | 0.5 |
| 0.16 – 0.24 | | 1 N/O | 1 NC | | 20 | 1 |
| 0.24 – 0.4 | | 1 N/O | 1 NC | | 20 | 2 |
| 0.4 – 0.6 | | 1 N/O | 1 NC | | 20 | 2 |
| 0.6 – 1 | | 1 N/O | 1 NC | | 20 | 4 |
| 1 – 1.6 | | 1 N/O | 1 NC | | 20 | 6 |
| 1.6 – 2.4 | | 1 N/O | 1 NC | | 20 | 6 |
| 2.4 – 4 | | 1 N/O | 1 NC | | 20 | 10 |
| 4 – 6 | | 1 N/O | 1 NC | | 20 | 10 |
| 6 – 9 | | 1 N/O | 1 NC | | 20 | 10 |
| 9 – 12 | | 1 N/O | 1 NC | | 20 | 10 |

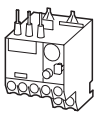



Information relevant for export to North America



| | |
|----------------------|---|
| Product Standards | UL 508; CSA-C22.2 No.14; IEC/EN 60947-4-1; CE marking |
| UL File No. | E29184 |
| UL CCN | NKCR |
| CSA File No. | 12528 |
| CSA Class No. | 3211-03 |
| NA Certification | UL Listed, CSA certified |
| Suitable for | Branch circuits |
| Max. Voltage Rating | 600 V AC |
| Degree of Protection | IEC: IP20, UL/CSA Type: - |
| See also | → Page 24 |

| Part no. Article no. | Price See price list | Std. pack | Notes |
|-------------------------|-------------------------|-----------|-------|
|-------------------------|-------------------------|-----------|-------|

| | | | |
|--------------------------|---|-------|---|
| ZE-0.16 014263 |  | 1 Off | Overload release: tripping class 10 A Short-circuit protection: With direct mounting, observe the maximum permissible fuse of the contactor. |
| ZE-0.24 014285 | | | |
| ZE-0.4 014300 | | | Suitable for protection of EEx e motors |
| ZE-0.6 014333 | | |  II (2) GD PTB 01 ATEX 3331 |
| ZE-1.0 014376 | | | Observe manual AWB2300-1425D/GB. |
| ZE-1.6 014432 | | | |
| ZE-2.4 014479 | | | |
| ZE-4 014518 | | | |
| ZE-6 014565 | | | |
| ZE-9 014708 | | | |
| ZE-12 014752 | | | |

With side-by-side mounting, there must be a minimum clearance of 5 mm between overload relays.

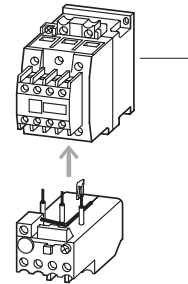

1 Contactor → Chapter 1.1
 Accessories → Page 21
 Manual → Page 21

1.2

Overload relays

Overload relays up to 150A

1

ZB12, ZB32

Setting range of overload releases

Circuit symbol

Auxiliary contact

For use with

Short-circuit protection

I_r

A



N/O = normally open contact
NC = normally closed contact

Contactors

Soft starters

Type "1" coordination

gG/gL

A



Type "2" coordination

gG/gL

A



ZB12 overload relay

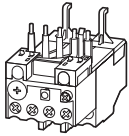

| Setting range of overload releases | Circuit symbol | Auxiliary contact | For use with | Soft starters | Type "1" coordination | Type "2" coordination |
|------------------------------------|----------------|-------------------|--|--|-----------------------|-----------------------|
| 0.1 – 0.16 | | 1 N/O 1 NC | DILM7, DILM9, DILM12, DILM15, DIULM7, DIULM9, DIULM12, SDAINLM12, SDAINLM16, SDAINLM22 | – | 25 | 0.5 |
| 0.16 – 0.24 | | 1 N/O 1 NC | – | – | 25 | 1 |
| 0.24 – 0.4 | | 1 N/O 1 NC | – | – | 25 | 2 |
| 0.4 – 0.6 | | 1 N/O 1 NC | – | – | 25 | 4 |
| 0.6 – 1 | | 1 N/O 1 NC | – | – | 25 | 4 |
| 1 – 1.6 | | 1 N/O 1 NC | – | – | 25 | 6 |
| 1.6 – 2.4 | | 1 N/O 1 NC | – | – | 25 | 10 |
| 2.4 – 4 | | 1 N/O 1 NC | – | DS7-34...SX004... | 25 | 16 |
| 4 – 6 | | 1 N/O 1 NC | – | DS7-34...SX005... | 25 | 20 |
| 6 – 10 | | 1 N/O 1 NC | – | DS7-34...SX007... DS7-34...SX009... | 50 | 25 |
| 9 – 12 | | 1 N/O 1 NC | – | DS7-34...SX012... | 50 | 25 |
| 12 – 16 | | 1 N/O 1 NC | – | – | 50 | 25 |

ZB32 overload relay

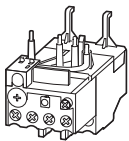

| Setting range of overload releases | Circuit symbol | Auxiliary contact | For use with | Soft starters | Type "1" coordination | Type "2" coordination |
|------------------------------------|----------------|-------------------|---|-------------------|-----------------------|-----------------------|
| 0.1 – 0.16 | | 1 N/O 1 NC | DILM17, DILM25, DILM32, DILM38, DILMF8, DILMF11, DILMF14, DILMF17, DILMF25, DILMF32, DIULM17, DIULM25, DIULM32, SDAINLM30, SDAINLM45, SDAINLM55 | – | 25 | 0.5 |
| 0.16 – 0.24 | | 1 N/O 1 NC | – | – | 25 | 1 |
| 0.24 – 0.4 | | 1 N/O 1 NC | – | – | 25 | 2 |
| 0.4 – 0.6 | | 1 N/O 1 NC | – | – | 25 | 4 |
| 0.6 – 1 | | 1 N/O 1 NC | – | – | 25 | 4 |
| 1 – 1.6 | | 1 N/O 1 NC | – | – | 25 | 6 |
| 1.6 – 2.4 | | 1 N/O 1 NC | – | – | 25 | 10 |
| 2.4 – 4 | | 1 N/O 1 NC | – | – | 25 | 16 |
| 4 – 6 | | 1 N/O 1 NC | – | – | 25 | 20 |
| 6 – 10 | | 1 N/O 1 NC | – | – | 50 | 25 |
| 10 – 16 | | 1 N/O 1 NC | – | DS7-34...SX016... | 63 | 35 |
| 16 – 24 | | 1 N/O 1 NC | – | DS7-34...SX024... | 100 | 35 |
| 24 – 32 | | 1 N/O 1 NC | – | DS7-34...SX032... | 125 | 63 |
| 32 – 38 | | 1 N/O 1 NC | – | – | 125 | 63 |

Information relevant for export to North America



Product Standards
UL File No.
UL CCN
CSA File No.
CSA Class No.

UL 508; CSA-C22.2 No.14; IEC/EN 60947-4-1; CE marking
E29184
NKCR
12528
3211-03

NA Certification
Suitable for
Max. Voltage Rating
Degree of Protection
See also



UL Listed, CSA certified
Branch circuits
600 V AC
IEC: IP20, UL/CSA Type: -
→ Page 24

Part no.
Article no.

Price
See price list

Std. pack

Notes

| | | |
|----------------------------|---|--|
| ZB12-0,16 278431 |  | <p>1 Off</p> <p>Overload release: tripping class 10 A Short-circuit protection: With direct mounting, observe the maximum permissible fuse of the contactor.</p> <p>Suitable for protection of EEx e motors.</p> <p> II (2) GD PTB 04 ATEX 3022</p> <p>Observe manual AWB2300-1527D/GB.</p> <ul style="list-style-type: none"> • Phase failure sensitivity to IEC/EN 60947, VDE 0660 Part 102 • Test/off pushbutton • Reset pushbutton manual/auto • Trip-free release • Direct mounting |
| ZB12-0,24 278432 | | |
| ZB12-0,4 278433 | | |
| ZB12-0,6 278434 | | |
| ZB12-1 278435 | | |
| ZB12-1,6 278436 | | |
| ZB12-2,4 278437 | | |
| ZB12-4 278438 | | |
| ZB12-6 278439 | | |
| ZB12-10 278440 | | |
| ZB12-12 278441 | | |
| ZB12-16 290168 | | |
| ZB32-0,16 278442 | | |
| ZB32-0,24 278443 | | |
| ZB32-0,4 278444 | | |
| ZB32-0,6 278445 | | |
| ZB32-1 278446 | | |
| ZB32-1,6 278447 | | |
| ZB32-2,4 278448 | | |
| ZB32-4 278449 | | |
| ZB32-6 278450 | | |
| ZB32-10 278451 | | |
| ZB32-16 278452 | | |
| ZB32-24 278453 | | |
| ZB32-32 278454 | | |
| ZB32-38 112474 | | |

Fitted directly to the contactor

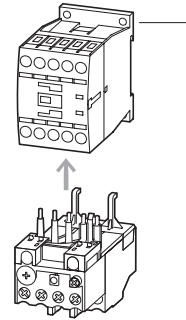

1 Contactor → Chapter 1.1
Accessories → Page 21
Manual → Page 21

Fitted directly to the contactor

Separate mounting

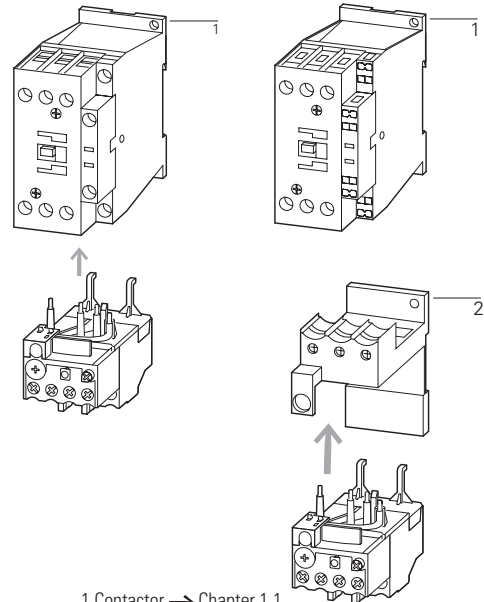

1 Contactor → Chapter 1.1
2 Base → Page 21
Manual → Page 21

1.2

Overload relays

Overload relays up to 150A

1

ZB65, ZB150

Setting range of overload releases

Circuit symbol

Auxiliary contact

For use with

Short-circuit protection

I_r
A



N/O = normally open contact
NC = normally closed contact

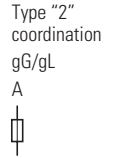
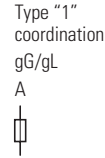

ZB65 overload relay

- Phase failure sensitivity to IEC/EN 60947, VDE 0660 Part 102
- Test/off pushbutton
- Reset pushbutton manual/auto
- Trip-free release
- Direct mounting

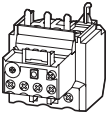

6 – 10

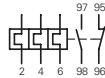

1 N/O 1 NC

DILM40, DILM50, DILM65,

50

25

10 – 16

1 N/O 1 NC

DILM72, DILMF40, DILMF50, DILMF65,

63

35

16 – 24

1 N/O 1 NC

DIULM40, DIULM50, DIULM65,

63

50

24 – 40

1 N/O 1 NC

SDAINLM70, SDAINLM90, SDAINLM115

125

63

40 – 57

1 N/O 1 NC

160

80

50 – 65

1 N/O 1 NC

160

100

65 – 75

1 N/O 1 NC

250

160

ZB150 overload relay

- Phase failure sensitivity to IEC/EN 60947, VDE 0660 Part 102
- Test/off pushbutton
- Reset pushbutton manual/auto
- Trip-free release
- Direct mounting

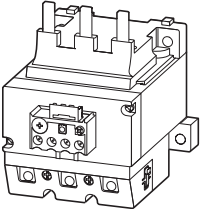

35 – 50

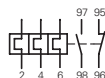

1 N/O 1 NC

DILM80, DILM95, DILM115, DILM150,

160

125

50 – 70

1 N/O 1 NC

DILM170, DILMF80, DILMF95, DILMF115,

250

160

70 – 100

1 N/O 1 NC

DILMF150, DIULM80, DIULM95,

315

200

95 – 125

1 N/O 1 NC

DIULM115, DIULM150, SDAINLM140,

315

250

120 – 150

1 N/O 1 NC

SDAINLM165, SDAINLM200, SDAINLM260

315

250

145 – 175

1 N/O 1 NC

315

250

ZB150 overload relay

- Phase failure sensitivity to IEC/EN 60947, VDE 0660 Part 102
- Test/off pushbutton
- Reset pushbutton manual/auto
- Trip-free release
- Separate mounting

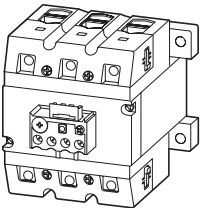

35 – 50

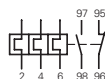

1 N/O 1 NC

DILM80, DILM95, DILM115, DILM150,

160

125

50 – 70

1 N/O 1 NC

DILM170, DILMF80, DILMF95, DILMF115,

250

160

70 – 100

1 N/O 1 NC

DILMF150, DIULM80, DIULM95,

315

200

95 – 125

1 N/O 1 NC

DIULM115, DIULM150, SDAINLM140,

315

250

120 – 150

1 N/O 1 NC

SDAINLM165, SDAINLM200, SDAINLM260

315

250

145 – 175

1 N/O 1 NC

400

315

Information relevant for export to North America



Product Standards
UL File No.
UL CCN
CSA File No.
CSA Class No.
NA Certification
Suitable for
Max. Voltage Rating
Degree of Protection
See also





UL 508; CSA-C22.2 No.14; IEC/EN 60947-4-1; CE marking
E29184
NKCR
12528
3211-03
UL Listed, CSA certified
Branch circuits
600 V AC
IEC: IP00, UL/CSA Type: -
→ Page 24

Part no.
Article no.

Price
See price list

Std. pack



Notes

| | | |
|----------------------------|---|---|
| ZB65-10 278455 | 1 Off | Overload release: tripping class 10 A Short-circuit protection: With direct mounting, observe the maximum permissible fuse of the contactor. |
| ZB65-16 278456 |  | |
| ZB65-24 278457 | | Suitable for protection of EExe motors. |
| ZB65-40 278458 | |  II (2) GD PTB 04 ATEX 3022 |
| ZB65-57 278459 | | Observe manual AWB2300-1545D/GB. |
| ZB65-65 278460 | | |
| ZB65-75 108792 | | |
| ZB150-50 278462 | 1 Off | Overload release: tripping class 10 A Short-circuit protection: With direct mounting, observe the maximum permissible fuse of the contactor. |
| ZB150-70 278463 |  | |
| ZB150-100 278464 | | Suitable for protection of EEx e motors. |
| ZB150-125 278465 | |  II (2) GD PTB 04 ATEX 3022 |
| ZB150-150 278466 | | Observe manual AWB2300-1545D/GB. |
| ZB150-175 107316 | | |

Fitted directly to the contactor

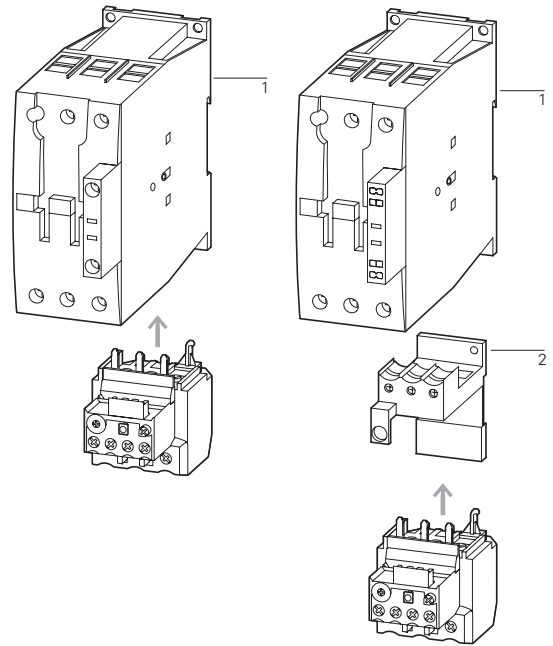
Separate mounting



| | | |
|-------------------------------|---|---|
| ZB150-50/KK 278468 | 1 Off | Overload release: tripping class 10 A Short-circuit protection: With direct mounting, observe the maximum permissible fuse of the contactor. |
| ZB150-70/KK 278469 |  | |
| ZB150-100/KK 278470 | | Suitable for protection of EEx e motors. |
| ZB150-125/KK 278471 | |  II (2) GD PTB 04 ATEX 3022 |
| ZB150-150/KK 278472 | | Observe manual AWB2300-1545D/GB. |
| ZB150-175/KK 107317 | | |

1 Contactor → Chapter 1.1
2 Base → Page 21
Manual → Page 21

1.2

Overload relays

Overload relays greater than 150 A, CT-operated overload relays

1

Z5, ZW7

Setting range of overload releases

Circuit symbol

Auxiliary contacts

For use with

Short-circuit protection

N/O = normally open contact
NC = normally closed contact

Type "1" coordination
gG/gL

Type "2" coordination
gG/gL



Z5 overload relays greater than 150A

- Phase failure sensitivity to IEC/EN 60947, VDE 0660 Part 102
- Test/off pushbutton
- Reset pushbutton manual/auto
- Trip-free release

Direct mounting
Separate mounting

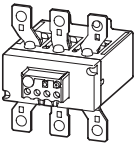

50 – 70

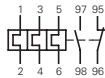

1 N/O 1 NC

DILM185A
DILM225A

250

160

70 – 100

1 N/O 1 NC

250

160

95 – 125

1 N/O 1 NC

315

200

120 – 160

1 N/O 1 NC

315

200

160 – 220

1 N/O 1 NC

400

250

200 – 250

1 N/O 1 NC

400

250

500

400

Z5 overload relays greater than 150A

- Phase failure sensitivity to IEC/EN 60947, VDE 0660 Part 102
- Test/off pushbutton
- Reset pushbutton manual/auto
- Trip-free release

Direct mounting
Separate mounting

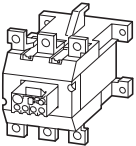

70 – 100

1 N/O 1 NC

DILM250A

250

160

70 – 100

1 N/O 1 NC

250

160

95 – 125

1 N/O 1 NC

315

200

120 – 160

1 N/O 1 NC

315

200

160 – 220

1 N/O 1 NC

315

250

200 – 250

1 N/O 1 NC

400

250

500

315

200 – 300

1 N/O 1 NC

DILM300A

500

400

500

400

ZW7 current transformer-operated overload relays

- Test/off button
- Reset pushbutton manual/auto
- Trip-free release
- Protection with heavy starting duty

Separate mounting

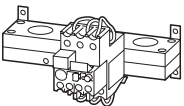

42 – 63

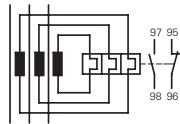

1 N/O 1 NC

–

–

–

60 – 90

1 N/O 1 NC

–

–

–

85 – 125

1 N/O 1 NC

–

–

–

110 – 160

1 N/O 1 NC

–

–

–

160 – 240

1 N/O 1 NC

–

–

–

190 – 290

1 N/O 1 NC

–

–

–

270 – 400

1 N/O 1 NC

–

–

–

360 – 540

1 N/O 1 NC

–

–

–



420 – 630

1 N/O 1 NC

–

–

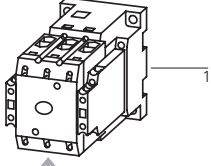
–

| Part no. Article no. | Price See price list | Std. pack | Notes | Information relevant for export to North America |
|--------------------------------|-------------------------|---|--|---|
| Z5-70/FF225A 139572 | | 1 Off | Overload release: tripping class 10 A | Product Standards UL 508; CSA-C22.2 No.14; IEC/EN 60947-4-1; CE marking |
| Z5-100/FF225A 139573 | |  | Short-circuit protection: With direct mounting, observe the maximum permissible fuse of the contactor. | NA Certification Suitable for Branch circuits |
| Z5-125/FF225A 139574 | | | | Max. Voltage Rating 600 V AC |
| Z5-160/FF225A 139575 | | | Z5-.../FF225A for protecting EEx electric motors in preparation. | Degree of Protection IEC: IP00, UL/CSA Type: - → Page 24 |
| Z5-220/FF225A 139576 | | | Fitted directly to the contactor | |
| Z5-250/FF225A 139577 | | |  | |
| Z5-70/FF250 210070 | | | | Product Standards UL 508; CSA-C22.2 No.14; IEC/EN 60947-4-1; CE marking |
| Z5-100/FF250 210071 | | | | UL File No. E29184 |
| Z5-125/FF250 210072 | | | | UL CCN NKCR |
| Z5-160/FF250 210073 | | | | CSA File No. 12528 |
| Z5-220/FF250 210074 | | | | CSA Class No. 3211-03 |
| Z5-250/FF250 210075 | | | | NA Certification UL Listed, CSA certified |
| Z5-300/FF250 139578 | | | | Suitable for Branch circuits |
| | | | 1 Contactor → Chapter 1.1 Accessories → Page 22 | Max. Voltage Rating 600 V AC |
| | | |  | Degree of Protection IEC: IP00, UL/CSA Type: - → Page 24 |
| ZW7-63 000245 | | 1 Off | The main current characteristic values are defined by the main current wiring being used. | Product Standards UL 508; CSA-C22.2 No.14; IEC/EN 60947-4-1; CE marking |
| ZW7-90 002618 | |  | Adjustment for smaller rated motor currents → Page 23 | NA Certification Request filed for UL and CSA Branch circuits |
| ZW7-125 004991 | | | | Suitable for Branch circuits |
| ZW7-160 007364 | | | | Max. Voltage Rating 600 V AC |
| ZW7-240 009737 | | | | Degree of Protection IEC: IP00, UL/CSA Type: - |
| ZW7-290 052448 | | | | |
| ZW7-400 045329 | | | | |
| ZW7-540 047702 | | | | |
| ZW7-630 050075 | | 1 Off | | |

1.2 Electronic overload relays to 1500 A

Basic devices

1

ZEB12, ZEB32

Ground fault detection

Setting range of overload releases



Circuit symbol

Auxiliary contact

N/O = normally open contact
NC = normally closed contact

For use with

ZEB12 electronic overload relay

- Phase-failure sensitivity
- Test/off pushbutton
- Reset button
- Manual/Auto reset selectable
- Protection with heavy starting duty (Class 5-30)

Direct mounting

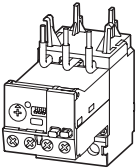

| Ground fault detection | Setting range of overload releases | Circuit symbol | Auxiliary contact | For use with | |
|------------------------|------------------------------------|----------------|-------------------|--------------|------------------------------------|
| Without | 0.33 – 1.65 | | 1 N/O | 1 NC | DILM7 DILM9 DILM12 DILM15 |
| Without | 1 – 5 | | 1 N/O | 1 NC | DIULM7 DIULM9 DIULM12 |
| Without | 4 – 20 | | 1 N/O | 1 NC | SDAINLM16 SDAINLM22 |
| With | 0.33 – 1.65 | | 1 N/O | 1 NC | |
| With | 1 – 5 | | 1 N/O | 1 NC | |
| With | 4 – 20 | | 1 N/O | 1 NC | |

ZEB32 electronic overload relay

- Phase-failure sensitivity
- Test/off pushbutton
- Reset button
- Manual/Auto reset selectable
- Protection with heavy starting duty (Class 5-30)

Direct mounting

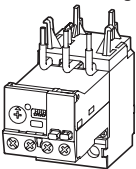

| | | | | | |
|---------|-------------|-------|-------|------|--------------------------------------|
| Without | 0.33 – 1.65 | | 1 N/O | 1 NC | DILM17 DILM25 DILM32 DILM38 |
| Without | 1 – 5 | | 1 N/O | 1 NC | DIULM17 DIULM25 DIULM32 |
| Without | 4 – 20 | | 1 N/O | 1 NC | SDAINLM30 SDAINLM45 SDAINLM55 |
| Without | 9 – 45 | | 1 N/O | 1 NC | |
| With | 0.33 – 1.65 | | 1 N/O | 1 NC | |
| With | 1 – 5 | | 1 N/O | 1 NC | |
| With | 4 – 20 | 1 N/O | 1 NC | | |
| With | 9 – 45 | 1 N/O | 1 NC | | |

ZEB32 electronic overload relay

- Phase-failure sensitivity
- Test/off pushbutton
- Reset button
- Manual/Auto reset selectable
- Protection with heavy starting duty (Class 5-30)

Separate mounting

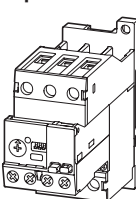





| | | | | | |
|---------|-------------|-------|-------|------|--------------------------------------|
| Without | 0.33 – 1.65 | | 1 N/O | 1 NC | DILM17 DILM25 DILM32 DILM38 |
| Without | 1 – 5 | | 1 N/O | 1 NC | DIULM17 DIULM25 DIULM32 |
| Without | 4 – 20 | | 1 N/O | 1 NC | SDAINLM30 SDAINLM45 SDAINLM55 |
| Without | 9 – 45 | | 1 N/O | 1 NC | |
| With | 0.33 – 1.65 | | 1 N/O | 1 NC | |
| With | 1 – 5 | | 1 N/O | 1 NC | |
| With | 4 – 20 | 1 N/O | 1 NC | | |
| With | 9 – 45 | 1 N/O | 1 NC | | |

Information relevant for export to North America

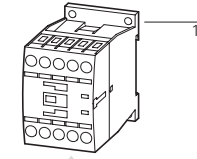
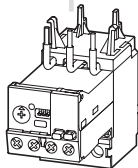

Product Standards
NA Certification
Suitable for
Max. Voltage Rating
Degree of Protection

UL 508; CSA-C22.2 No. 14; IEC/EN 60947-4-1; CE marking
Request filed for UL and CSA
Branch circuits
600 V AC
IEC: IP20, UL/CSA Type: -

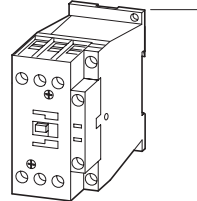
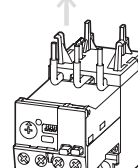
| Part no. Article no. | Price See price list | Std. pack | Notes | |
|-----------------------------------|-------------------------|---|--|---|
| ZEB12-1,65 136480 | | 1 Off | Suitable for protection of EEx e motors. | Fitted directly to the contactor |
| ZEB12-5 136481 | |  |  II (2) GD PTB ATEX starting 08/2010 |  <p>1 Contactor → Chapter 1.1 Accessories → Page 18</p> |
| ZEB12-20 136482 | | | Observe manual AWB2320-1633D/GB. | |
| ZEB12-1,65-GF 136483 | | | Switchgear and cable dimensioning according to CLASS | |
| ZEB12-5-GF 136484 | | | → Page 18 | |
| ZEB12-20-GF 136485 | | | | |
| ZEB32-1,65 136486 | | 1 Off | Suitable for protection of EEx e motors. | Fitted directly to the contactor |
| ZEB32-5 136487 | |  |  II (2) GD PTB ATEX starting 08/2010 |  <p>1 Contactor → Chapter 1.1 Accessories → Page 18</p> |
| ZEB32-20 136488 | | | Observe manual AWB2320-1633D/GB. | |
| ZEB32-45 136489 | | | Switchgear and cable dimensioning according to CLASS | |
| ZEB32-1,65-GF 136490 | | | → Page 18 | |
| ZEB32-5-GF 136491 | | | | |
| ZEB32-20-GF 136492 | | | | |
| ZEB32-45-GF 136493 | | | | |
| ZEB32-1,65/KK 136494 | | 1 Off | Suitable for protection of EEx e motors. | |
| ZEB32-5/KK 136495 | |  |  II (2) GD PTB ATEX starting 08/2010 | |
| ZEB32-20/KK 136496 | | | Observe manual AWB2320-1633D/GB. | |
| ZEB32-45/KK 136497 | | | Switchgear and cable dimensioning according to CLASS | |
| ZEB32-1,65-GF/KK 136498 | | | → Page 18 | |
| ZEB32-5-GF/KK 136499 | | | | |
| ZEB32-20-GF/KK 136500 | | | | |
| ZEB32-45-GF/KK 136501 | | | | |

1.2

Electronic overload relays to 1500 A

Basic devices

1

ZEB65, ZEB150

Ground fault detection

Setting range of overload releases

I_r
A



Circuit symbol

Auxiliary contact

N/O = normally open contact
NC = normally closed contact

For use with

ZEB65 electronic overload relay

- Phase-failure sensitivity
- Test/off pushbutton
- Reset button
- Manual/Auto reset selectable
- Protection with heavy starting duty (Class 5-30)

Direct mounting

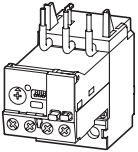

| Without | 9 – 45 | | 1 N/O | 1 NC | DILM40 DILM50 DILM65 DILM72 DIULM40 DIULM50 DIULM65 |
|---------|----------|--|-------|------|---|
| With | 9 – 45 | | 1 N/O | 1 NC | |
| Without | 20 – 100 | | 1 N/O | 1 NC | SDAINLM70 SDAINLM90 SDAINLM115 |
| With | 20 – 100 | | 1 N/O | 1 NC | |

ZEB150 electronic overload relay

- Phase-failure sensitivity
- Test/off pushbutton
- Reset button
- Manual/Auto reset selectable
- Protection with heavy starting duty (Class 5-30)

Direct mounting

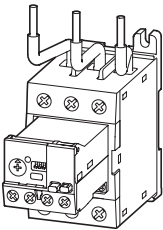

| Without | 20 – 100 | | 1 N/O | 1 NC | DILM80 DILM95 DILM115 DILM150 DIULM80 DIULM95 DIULM115 DIULM150 |
|---------|----------|--|-------|------|--|
| With | 20 – 100 | | 1 N/O | 1 NC | SDAINLM140 SDAINLM165 SDAINLM200 SDAINLM260 |

ZEB150 electronic overload relay

- Phase-failure sensitivity
- Test/off pushbutton
- Reset button
- Manual/Auto reset selectable
- Protection with heavy starting duty (Class 5-30)

Separate mounting

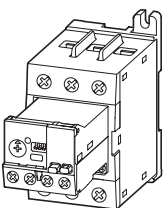









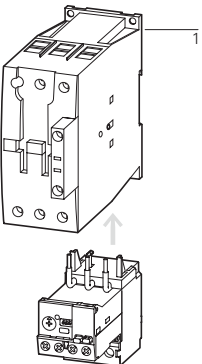

| Without | 20 – 100 | | 1 N/O | 1 NC | DILM80 DILM95 DILM115 DILM150 DIULM80 DIULM95 DIULM115 DIULM150 |
|---------|----------|--|-------|------|--|
| With | 20 – 100 | | 1 N/O | 1 NC | SDAINLM140 SDAINLM165 SDAINLM200 SDAINLM260 |

Information relevant for export to North America

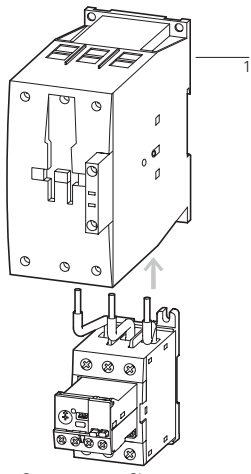

Product Standards
NA Certification
Suitable for
Max. Voltage Rating
Degree of Protection



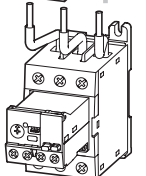







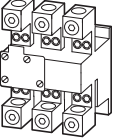

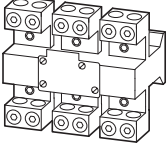

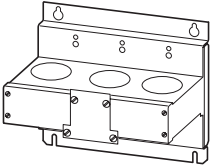
UL 508; CSA-C22.2 No.14; IEC/EN 60947-4-1; CE marking
Request filed for UL and CSA
Branch circuits
600 V AC
IEC: IP20, UL/CSA Type: -

| Part no. Article no. | Price See price list | Std. pack | Notes | |
|-----------------------------------|-------------------------|---|--|--|
| ZEB65-45 136502 | | 1 Off | Suitable for protection of EEx e motors. | Fitted directly to the contactor |
| ZEB65-45-GF 136503 | |   |  II (2) GD PTB ATEX starting 08/2010 |  <p>1 Contactor → Chapter 1.1 Accessories → Page 18</p> |
| ZEB65-100 136504 | | | Observe manual AWB2320-1633D/GB. | |
| ZEB65-100-GF 136505 | | | Switchgear and cable dimensioning according to CLASS → Page 18 | |
| ZEB150-100 136506 | | 1 Off | Suitable for protection of EEx e motors. | Fitted directly to the contactor |
| ZEB150-100-GF 136507 | |   |  II (2) GD PTB ATEX starting 08/2010 |  <p>1 Contactor → Chapter 1.1 Accessories → Page 18</p> |
| | | | Observe manual AWB2320-1633D/GB. | |
| | | | Switchgear and cable dimensioning according to CLASS → Page 18 | |
| ZEB150-100/KK 136508 | | 1 Off | Suitable for protection of EEx e motors. | |
| ZEB150-100-GF/KK 136509 | |   |  II (2) GD PTB ATEX starting 08/2010 |  <p>1 Contactor → Chapter 1.1 Accessories → Page 18</p> |
| | | | Observe manual AWB2320-1633D/GB. | |
| | | | Switchgear and cable dimensioning according to CLASS → Page 18 | |

1.2 Electronic overload relays to 1500 A

Accessories

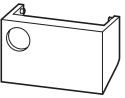
1 ZEB-XCT...

| | Setting range of overload releases | Language | Can be used with | Part no. Article no. | Price See price list | Std. pack |
|--|------------------------------------|--------------------|-----------------------------------|--|----------------------|--|
| | I_r A | | | | | |
| Current sensors | | | | | | |
|  | 60 – 300 | – | ZEB32-5-GF/KK ZEB32-5/KK | ZEB-XCT300 ¹⁾ 136511 | | 1 off   |
|  | 120 – 600 | – | ZEB32-5-GF/KK ZEB32-5/KK | ZEB-XCT600 ¹⁾ 136512 | | 1 off   |
|  | 200 – 1000 | – | ZEB32-5-GF/KK ZEB32-5/KK | ZEB-XCT1000 ¹⁾ 136517 | | 1 off   |
| | 300 – 1500 | – | | ZEB-XCT1500 ¹⁾ 136513 | | 1 off   |
| Sealable shroud | | | | | | |
| Cover to prevent adjustment of motor current (tamper-proof) | | | | | | |
|  | – | – | – | ZEB-XSC ²⁾ 136514 | | 1 off   |
| Reset adapter | | | | | | |
| Cover to prevent adjustment of motor current (tamper-proof) | | | | | | |
|  | – | – | – | ZEB-XRB ²⁾ 136515 | | 1 off   |
| Documentation | | | | | | |
| ZEB electronic overload relay Overload monitoring of EEx e motors | | | | | | |
| | – | Deutsch English | ZEB12 ZEB32 ZEB65 ZEB150 | AWB2320-1633DE/EN 136516 | | 1 off |

1)

Information relevant for export to North America



Product Standards UL 508; CSA-C22.2 No.14;
IEC/EN 60947-4-1; CE marking
NA Certification Request filed for UL and CSA
Suitable for Branch circuits
Max. Voltage Rating 600 V AC
Degree of Protection IEC: IP00, UL/CSA Type: -

2)

Information relevant for export to North America



Product Standards UL 508; CSA-C22.2 No.14;
IEC/EN 60947-4-1; CE marking
NA Certification Request filed for UL and CSA
Max. Voltage Rating 600 V AC
Degree of Protection IEC: IP20, UL/CSA Type: -

Switchgear and cable sizing corresponding to the respective starting inertia (CLASS) for ZEB

Switchgear is designed according to "CLASS 10" requirements for both normal and overload operation conditions. In order for the switchgear (circuit-breaker and contactor) and the cables not to be overloaded with long tripping times, they must be oversized accordingly. The rated operational current, I_e , for switchgear and cables can be calculated with the following current factor taking the tripping class into account:

| Tripping class | Class 5 | Class 10 | Class 15 | Class 20 | Class 25 | Class 30 | Class 35 | Class 40 |
|---|---------|----------|----------|----------|----------|----------|----------|----------|
| Current factor of rated operational current I_e | 1.00 | 1.00 | 1.22 | 1.41 | 1.58 | 1.73 | 1.89 | 2.00 |

Ordering

EMT6

| Function | Rated operational current | Conventional thermal current | Rated control voltage | Part no. Article no. | Price See price list | Std. pack | Notes |
|----------|---------------------------|------------------------------|-----------------------|----------------------|----------------------|-----------|-------|
| | AC-15 240 V | AC-14 400 V | | | | | |
| | I_e A | I_e A | I_{th} A | U_s V | | | |

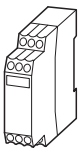

EMT6 thermistor machine protection overload relays

| | | | | | | | |
|---|---|---|---|---------------------------------------|---|-------|---|
| Without automatic reset Mains and fault LED display | 3 | 3 | 6 | 24 - 240 V 50/60 Hz, 24 - 240 V DC | EMT6 ^{1) 2)} 066166 | 1 off | II (2) G |
| | | | | 230 V 50/60 Hz | EMT6(230V) ^{1) 2)} 066400 | | II (2) GD only for EMT6-K |
| Without automatic reset Mains and fault LED display Tripped in the event of a short-circuit in the sensor-cable | 3 | 3 | 6 | 24 - 240 V 50/60 Hz, 24 - 240 V DC | EMT6-K ²⁾ 269470 | | PTB 02 ATEX 3162 |
| Selector switch with/without automatic reset For manual or remote resetting Test button Mains and fault LED display | 3 | 3 | 6 | 24 - 240 V 50/60 Hz, 24 - 240 V DC | EMT6-DB ^{1) 2)} 066167 | | Observe the manual AWB 2327-1446 → Page 19 Can be snap fitted on a top-hat rail to IEC/EN 60715. Device clearance ≧ 3 mm. |
| | | | | 230 V 50/60 Hz | EMT6-DB(230V) ^{1) 2)} 066401 | | |
| Selector switch with/without automatic reset For manual or remote resetting Test button Mains and fault LED display Trip with short-circuit in the sensor cable | 3 | 3 | 6 | 24 - 240 V 50/60 Hz, 24 - 240 V DC | EMT6-KDB ²⁾ 269471 | | |
| All-in-one device Selector switch with/without automatic reset Trip with short-circuit in the sensor cable Zero-voltage safe For manual or remote resetting Test button Short-circuit detection and retention can be deactivated Mains and fault LED display | 3 | 3 | 6 | 24 - 240 V 50/60 Hz, 24 - 240 V DC | EMT6-DBK ²⁾ 066168 | | |

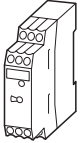
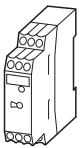

Accessories

Screw adapters for screw fixing

| | | | | | | | |
|--|--|--|--|--|--------------------------------------|--------|---|
| | | | | | CS-TE ³⁾ 095853 | 10 off | – |
| | | | | | | | |

Documentation

EMT6 thermistor overload relay Overload monitoring of machines in the EEx e area

| | | | | | | | |
|---------|--|--|--|--|---------------------------------|-------|--|
| German | | | | | AWB2327-1446D 264853 | 1 off | |
| English | | | | | AWB2327-1446GB 267010 | 1 off | |

Notes

¹⁾ For EMT6, EMT6(230V), EMT6-DB and EMT6-DB(230V) applies:
Provide additional short-circuit protection in the sensor circuit with a current monitoring relay.

²⁾

Information relevant for export to North America

| | |
|----------------------|--|
| | |
| Product Standards | UL 508; CSA-C22.2 No.14; IEC/EN 60947-4-1; CE marking |
| UL File No. | E29184 |
| UL CCN | NKCR |
| CSA File No. | 12528 |
| CSA Class No. | 3211-03 |
| NA Certification | UL Listed, CSA certified |
| Max. Voltage Rating | 600 V AC |
| Degree of Protection | IEC: IP20, UL/CSA Type: - |

³⁾

Information relevant for export to North America

| | |
|--|-----------------------------------|
| | |
| | UL/CSA certification not required |

1.2 Overload relays for machine protection

Selection aid

1 Engineering

Terminal marking according to EN 50005

EMT6(-K), EMT6(-K)DB, EMT6-DBK
Auto

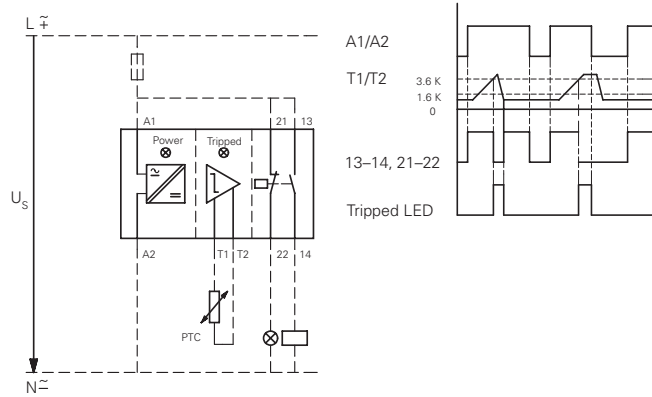

EMT6(-K)DB, EMT6-DBK
Manual

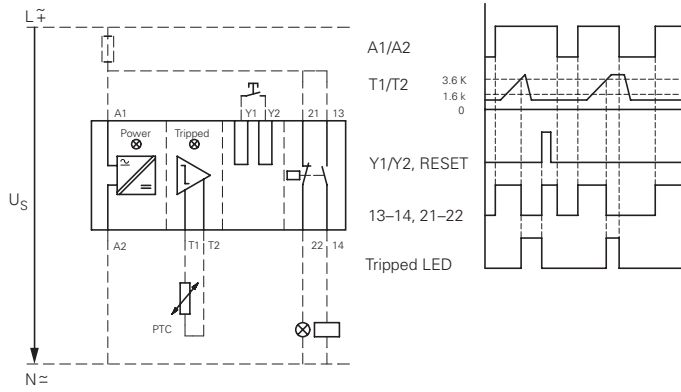

EMT6-DBK

Zero-voltage safe operation

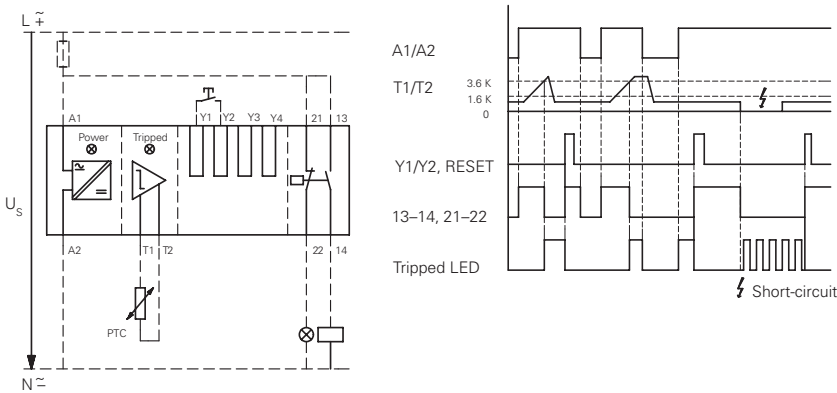

LED display

- Supply voltage present
- Device has tripped
- Device has tripped/short-circuit in the sensor circuit

Sensor circuit

At $R_K \leq 250 \Omega$ per sensor; at $R_K \leq 100 \Omega$ per sensor: 9 sensors in the winding (provided by user), max. cable length to sensor 250 m (not shielded); Total PTC thermistor resistance $\sum R_K \leq 1500 \Omega$

Sensor circuit characteristic values at U_S and $+20^\circ\text{C}$

| | EMT6... | |
|------------------------|--------------------------|------------------------|
| R_{T1-T2} | U_{T1-T2} V DC max. | I_{T1-T2} mA max. |
| T1, T2 short-circuited | - | 1.9 |
| 4 k Ω | 3 | 0.8 |
| T1-T2 open | 5.1 | - |





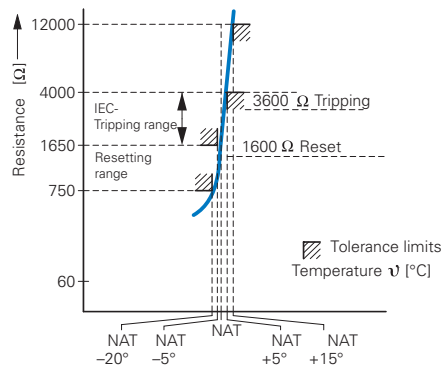











Functions that can be disconnected on the EMT6-DBK:

| Function | Disconnection by link |
|--------------------------|---------------------------------|
| Short-circuit monitoring | Y ₁ - Y ₃ |
| Zero-voltage safety | Y ₁ - Y ₄ |



Ordering

ZB, Z5, ZW7

| | For use with | Part no. Article no. | Price See price list | Std. pack | Notes | Information relevant for export to North America |
|---|---|-----------------------------------|----------------------------|---|--|---|
| | | | | | |   |
| Documentation Overload relays Overload monitoring of EEx e motors | ZE... | AWB2300-1425D 258704 | | 1 off | German | |
| | ZB12... ZB32... | AWB2300-1527D/GB 284910 | | 1 off | German/English | |
| | ZB65... ZB150... | AWB2300-1545D/GB 102065 | | 1 off | German/English | |
| Bases For separate mounting | ZB32 | ZB32-XEZ 278473 | | 5 off   | Can be snap fitted on a top-hat rail to IEC/EN 60715 or can be screw fitted. | Product Standards UL 508; CSA-C22.2 No.14; IEC/EN 60947-4-1; CE marking E29184 |
| | ZB65 | ZB65-XEZ 278474 | | 2 off   | For ZB32-38, use BK25/3-PKZ0 additionally. | UL File No. UL CCN CSA File No. CSA Class No. NA Certification Max. Voltage Rating Degree of Protection 600 V AC IEC: IP00, UL/CSA Type: - |
| Pushbuttons For enclosed Overload relay Mounting diameter: 22.3 mm External reset button, IP65 | ZW7... ZE Z5 ZB12 ZB32 ZB65 ZB150 | M22-DZ-B 254833 | | 10 off   | Button plate, blue | Product Standards UL 508; CSA-C22.2 No.14; IEC/EN 60947-4-1; CE marking E29184 |
| | ZW7... ZE Z5 ZB12 ZB32 ZB65 ZB150 | M22-DZ-B-GB14 254834 | | 10 off   | Button plate, blue RESET | UL File No. UL CCN CSA File No. CSA Class No. NA Certification NKCR 12528 3211-03 UL Listed, CSA certified |
| Pushbuttons For enclosed Overload relay Mounting diameter: 22.3 mm Off button, IP65 | ZW7... ZE Z5 ZB12 ZB32 ZB65 ZB150 | M22-DZ-X 254835 | | 10 off   | Without button plate, add button plate. | Product Standards UL 508; CSA-C22.2 No.14; IEC/EN 60947-4-1; CE marking E29184 |
| | ZW7... ZE Z5 ZB12 ZB32 ZB65 ZB150 | M22-DZ-X-GB14 254836 | | 10 off   | Without button plate, add button plate. | UL File No. UL CCN CSA File No. CSA Class No. NA Certification NKCR 12528 3211-03 UL Listed, CSA certified |
| Pushbuttons For enclosed Overload relay Mounting diameter: 22.3 mm Button plates | M22-DZ-X | M22-XD-R 216423 | | 10 off   | Button plate, red | UL/CSA certification not required |
| | M22-DZ-X | M22-XD-R-X0 218153 | | | Red button plate with white circle | |
| | M22-DZ-X | M22-XD-R-GB0 218194 | | | Button plate red STOP | |

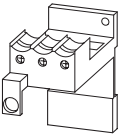

1.2 Overload relays

Accessories

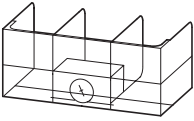
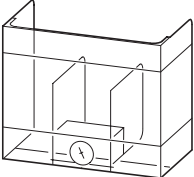
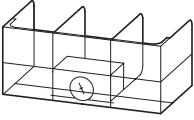

1

Z5..., K-B..., KS-B...

| | For use with | Part no. Article no. | Price See price list | Std. pack | Notes | | |
|---|---|----------------------------------|-------------------------|-----------|----------------------------------|----------------------------------|----------------------------------|
| Covers  | Direct mounting Z5-.../FF225 to DILM185A DILM225A | Z5/FF225A-XHB-Z 139579 | | 1 off | Fitted directly to the contactor | | |
| | | | | | DILM400-XHB | | |
| | | | | | DILM185A/225A | | |
| | | | | | Z5/FF225A-XHB-Z | | |
| Covers  | Z5-.../FF225A Z5-.../FF250 | Z5/FF250-XHB 215217 | | 1 off | Separate mounting | | |
| | | | | | Z5/FF250-XHB | Fitted directly to the contactor | Fitted directly to the contactor |
| | | | | | Z5-.../FF250/FF225A | DILM400-XHB | DILM400-XHB |
| | | | | | Z5/FF250-XHB | DILM250/300A | DILM185A/225A |
| Covers  | Direct mounting Z5-.../FF250 to DILM250 DILM300A | Z5/FF250-XHB-Z 215218 | | 1 off | Fitted directly to the contactor | | |
| | | | | | DILM400-XHB | | |
| | | | | | DILM250/300A | | |
| | | | | | Z5/FF250-XHB-Z | | |

Box terminals kit

Consisting of 3 individual clamps

| | For use with | For connection of copper flat strip max. W x H mm | Part no. Article no. | Price See price list | Std. pack | Notes |
|---|--------------|---|------------------------------|-------------------------|-----------|--|
| With protective cover  | Z5-.../FF250 | 24 x 26 | K-B-DIL6AM 064062 | | 1 off | When using box terminals the protective covers must be used. |
| With control circuit terminal and protective cover  | Z5-.../FF250 | 24 x 26 | KS-B-DIL6AM 064063 | | 1 off | When using box terminals the protective covers must be used. |

Engineering

Protection of single-phase and DC current motors:

1 pole

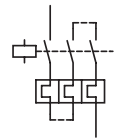

2 pole

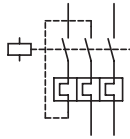

Mounting position:

ZE

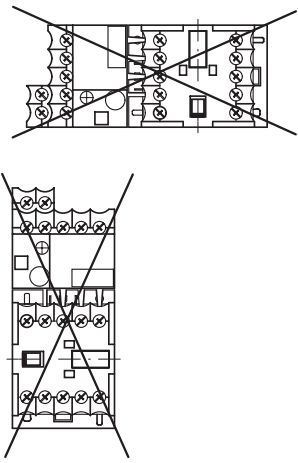

ZB12, ZB32, ZB65, ZB150, Z5

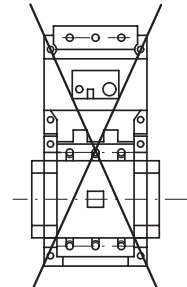

Tripping characteristics

These tripping characteristics are mean values of the spread at 20 °C ambient temperature in a cold state. They show the tripping times in relation to the response current. When the devices are at operational temperature the tripping time of the overload relay drops to approx. 25% of the value shown. Specific characteristics for each individual setting range can be found in the manual on → Page 21

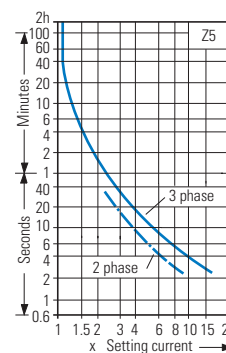
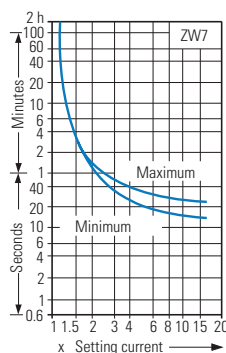
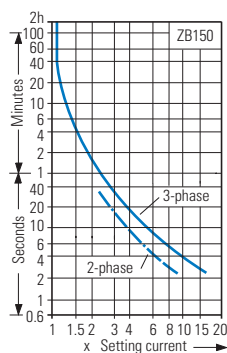
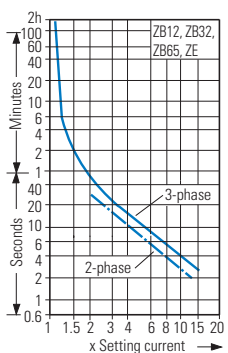

Adaption of ZW7 to smaller rated motor currents

| Number of loops | ZW7 -63 | -90 | -125 | -160 | -240 | -290 | -400 | -540 | -630 |
|-----------------|--|---------|-----------|-----------|---------|-----------|----------|---------|-----------|
| | Rated motor current I_N [A] | | | | | | | | |
| 1 | 42-63 | 60-90 | 85-125 | 110-160 | 160-240 | 190-290 | 270-400 | 360-540 | 420-630 |
| 2 | 21-31,5 | 30-45 | 42,5-62,5 | 55-80 | 80-120 | 95-145 | 135-200 | 180-270 | 210-315 |
| 3 | 14-21 | 20-30 | 28,3-41,7 | 36,7-53,3 | 53,3-80 | 63,3-96,7 | 90-133,3 | 120-180 | 140-210 |
| 4 | 10,5-15,8 | 15-22,5 | 21,3-31,3 | 27,5-40 | 40-60 | 47,5-72,5 | 67,5-100 | 90-135 | 105-157,5 |
| 5 | 8,4-12,6 | 12-18 | 17-25 | 22-32 | 32-48 | 38-58 | 54-80 | 72-108 | 84-126 |

1.2

Overload relays UL/CSA-short-circuit strength

1

ZE, ZB, Z5

Overload relay short-circuit strength



UL508, CSA-C22,2 No. 14/SCCR values

| | Fuse acc. to NEC, CEC | | CB | |
|---------------|-----------------------|-----|---------|----|
| | A | kA | A | kA |
| | 600V AC | | 480V AC | |
| ZE-0,16 | 1 | 5 | 15 | 5 |
| ZE-0,24 | 1 | 5 | 15 | 5 |
| ZE-0,4 | 1 | 5 | 15 | 5 |
| ZE-0,6 | 1 | 5 | 15 | 5 |
| ZE-1,0 | 3 | 5 | 15 | 5 |
| ZE-1,6 | 6 | 5 | 15 | 5 |
| ZE-2,4 | 6 | 5 | 15 | 5 |
| ZE-4 | 15 | 5 | 15 | 5 |
| ZE-6 | 20 | 5 | 15 | 5 |
| ZE-9 | 35 | 5 | 15 | 5 |
| ZE-12 | 45 | 5 | - | - |
| | 600V AC | | | |
| ZB12(32)-0,16 | 1 CLASS J/CC | 100 | - | - |
| ZB12(32)-0,24 | 1 CLASS J/CC | 100 | - | - |
| ZB12(32)-0,4 | 1 CLASS J/CC | 100 | - | - |
| ZB12(32)-0,6 | 1 CLASS J/CC | 100 | - | - |
| ZB-12(32)-1,0 | 1 CLASS J/CC | 100 | - | - |
| ZB-12(32)-1,6 | 3 CLASS J/CC | 100 | - | - |
| ZB-12(32)-2,4 | 3 CLASS J/CC | 100 | - | - |
| ZB-12(32)-4 | 6 CLASS J/CC | 100 | - | - |
| ZB-12(32)-6 | 10 CLASS J/CC | 100 | - | - |
| ZB-12(32)-10 | 15 CLASS J/CC | 100 | - | - |
| ZB12-12 | 15 CLASS J/CC | 100 | - | - |
| ZB12-16 | 30 CLASS J/CC | 100 | - | - |
| ZB32-16 | 35 CLASS J | 100 | - | - |
| ZB32-24 | 45 CLASS J | 100 | - | - |
| ZB32-32 | 60 CLASS J | 100 | - | - |
| | 600V AC | | 600V AC | |
| ZB65-10 | 15 CLASS J | 100 | 40 | 5 |
| ZB65-16 | 35 CLASS J | 100 | 60 | 5 |
| ZB65-24 | 45 CLASS J | 100 | 90 | 5 |
| ZB65-40 | 60 CLASS J | 100 | 125 | 5 |
| ZB65-57 | 110 CLASS J | 100 | 150 | 10 |
| ZB65-65 | 125 CLASS J | 100 | 150 | 10 |
| ZB65-75 | 125 CLASS J | 100 | 150 | 10 |

| | Fuse acc. to NEC, CEC | | CB | |
|---------------|-----------------------|-----|----------|----|
| | A | kA | A | kA |
| | 600V AC | | 600 V AC | |
| ZB150-50 | 225 | 5 | 200 | 5 |
| ZB150-70 | 250 | 10 | 250 | 10 |
| ZB150-100 | 400 CLASS J | 10 | 400 | 10 |
| ZB150-125 | 500 CLASS J | 10 | 500 | 10 |
| ZB150-150 | 600 CLASS J | 10 | 600 | 10 |
| ZB150-175 | 600 CLASS J | 10 | 600 | 10 |
| ZB150-50(KK) | 110 CLASS J | 100 | 200 | 5 |
| ZB150-70(KK) | 125 CLASS J | 100 | 250 | 10 |
| ZB150-100(KK) | 200 CLASS J | 100 | 400 | 10 |
| ZB150-125(KK) | 250 CLASS J | 100 | 500 | 10 |
| ZB150-150(KK) | 300 CLASS J | 100 | 600 | 10 |
| ZB150-175(KK) | 300 CLASS J | 100 | 600 | 10 |
| | 600V AC | | 600V AC | |
| Z5-70/... | 250 | 10 | 250 | 10 |
| Z5-100/... | 400 CLASS J | 10 | 400 | 10 |
| Z5-125/... | 500 CLASS J | 10 | 500 | 10 |
| Z5-160/... | 600 CLASS J | 10 | 600 | 10 |
| Z5-220/... | 800 CLASS J | 10 | 800 | 10 |
| Z5-250/... | 700 CLASS J | 10 | 600 | 10 |
| Z5-70/... | 125 CLASS J | 100 | - | - |
| Z5-100/... | 200 CLASS J | 100 | - | - |
| Z5-125/... | 250 CLASS J | 100 | - | - |
| Z5-160/... | 300 CLASS J | 100 | - | - |

Technical data

ZE, ZB

| | | | ZE | ZB12, ZB32 | ZB65 | ZB150(KK) |
|--|-----------------|------|--|--|--|--------------------------------|
| General | | | | | | |
| Standards | | | IEC/EN 60947, VDE 0660, UL, CSA | | | |
| Climatic proofing | | | Damp heat, constant, to IEC 60068-2-78 Damp heat, cyclic, to IEC 60068-2-30 | | | |
| Ambient temperature | | | | | | |
| Open ¹⁾ | °C | | -25...50 | -25...55 | -25...55 | -25...55 |
| Enclosed ¹⁾ | °C | | -25...40 | -25...40 | -25...40 | -25...40 |
| Temperature compensation | | | Continuous | | | |
| Mounting position | | | → Page 23 | | | |
| Weight | kg | | 0.07 | 0.15 | 0.25 | 1.64 |
| Mechanical shock resistance half-sinusoidal shock, 10 ms to IEC 60068-2-27 | g | | 10 | 10 | 10 | 10 |
| Protection type | | | IP20 | IP20 | IP00 | IP00 |
| Protection against direct contact when actuated from front (EN 50274) | | | Finger- and back-of-hand proof | | | |
| Main contacts | | | | | | |
| Rated impulse withstand voltage | U_{imp} | V AC | 6000 | 6000 | 6000 | 8000 |
| Overtoltage category/pollution degree | | | III/3 | III/3 | III/3 | III/3 |
| Rated insulation voltage | | | | | | |
| AC | U_i | V AC | 690 | 690 | 690 | 1000 |
| Rated operating voltage | U_e | V AC | 690 | 690 | 690 | 1000 |
| Safe isolation according to EN 61140 | | | | | | |
| Between auxiliary contacts and main contacts | | V AC | 300 | 440 | 440 | 440 |
| Between the main contacts | | V AC | 300 | 440 | 440 | 440 |
| Overload relay setting range | A | | 0.1...12 | 0.1...38 | 6...75 | 25...175 |
| Temperature compensation residual error > 40 °C | %/K | | ≅ 0.25 | ≅ 0.25 | ≅ 0.25 | ≅ 0.25 |
| Short-circuit protection rating maximum fuse | | | → Page 6 | → Page 8 | → Page 10 | → Page 10 |
| Current heat loss (3 conductors) | | | | | | |
| Lower value of setting range | W | | 2.5 | 2.5 | 3 | 16 |
| Upper value of setting range | W | | 6 | 6 | 7.5 | 18 |
| Terminal capacity | | | | | | |
| Solid | mm ² | | 2 x (0.75 - 2.5) | 2 x (1 - 6) ⁵⁾ | 2 x (1 - 16) ⁴⁾ | 2 x (4 - 16) |
| Flexible with ferrule | mm ² | | 2 x (0.5 - 1.5) | 2 x (1 - 4) ⁵⁾ 2 x (1 - 6) ³⁾ | 1 x (1...25) ²⁾ 2 x (1...10) ²⁾ | 1 x (4 - 70) 2 x (4 - 50) |
| Stranded | mm ² | | – | – | 1 x (16...25) | 1 x (16...50) 2 x (16...50) |
| Solid or stranded | AWG | | 18 - 14 | 14 - 8 ⁵⁾ | 14 - 2 | 3/0 |
| Busbar | Width | mm | – | – | – | – |
| Terminal screw | | | M3.5 | M4 | M6 | M10 |
| Tightening torque | Nm | | 1.2 | 1.8 ⁵⁾ | 3.5 | 10 |
| Tools | | | | | | |
| Pozi driv screwdriver | Size | | 2 | 2 | 2 | – |
| Flat-blade screwdriver | mm | | 0.8 x 5.5 | 1 x 6 | 1 x 6 | – |
| Hexagon socket | SW | mm | – | – | – | 5 |

Notes

- ¹⁾ Ambient temperature: Operating range to IEC/EN 60947, PTB: -5°C to +55°C
- ²⁾ Use identical cross-section when using two conductors
- ³⁾ 6 mm flexible with ferrules to DIN 46228
- ⁴⁾ With ZB65-XEZ max 1 x (1... 16)
- ⁵⁾ ZB32-38: solid and flexible with ferrule, 2.5 - 25 mm², 3 Nm tightening torque. AWG10-b, 27 lb-in tightening torque for solid or stranded conductors.

1.2

Overload relays

Overload relays, CT-operated overload relays

1 Z5, ZW7

| | | Z5-.../FF225A(250) | | ZW7 |
|--|--|--|----------------------------|---|
| General | | | | |
| Standards | | IEC/EN 60947, VDE 0660, UL, CSA | | IEC/EN 60947, VDE 0660, UL, CSA |
| Climatic proofing | | Damp heat, constant, to IEC 60068-2-78 Damp heat, cyclic, to IEC 60068-2-30 | | |
| Ambient temperature | | | | |
| Open ¹⁾ | °C | -25...50 | | -25...50 |
| Enclosed ¹⁾ | °C | -25...40 | | -25...40 |
| Temperature compensation | | Continuous | | Continuous |
| Mounting position | | → Page 23 | | Any |
| Weight | kg | 1.55 | | 0.8 |
| Mechanical shock resistance half-sinusoidal shock, 10 ms to IEC 60068-2-27 | g | 10 | | 10 |
| Protection type | | IP00 | | IP00 |
| Protection against direct contact when actuated from front (EN 50274) | | With terminal cover | | Finger- and back-of-hand proof |
| Main contacts | | | | |
| Rated impulse withstand voltage | U_{imp} | V AC | 8000 | 6000 |
| Overvoltage category/pollution degree | | | III/3 | III/3 |
| Rated insulation voltage | | | | |
| AC | U_i | V AC | 1000 | 690 |
| Rated operating voltage | U_e | V AC | 1000 | 690 |
| Safe isolation according to EN 61140 | | | | |
| Between auxiliary contacts and main contacts | | V AC | 440 | 440 |
| Between the main contacts | | V AC | 440 | 440 |
| Overload relay setting range | | A | 50...300 | 42...630 |
| Temperature compensation residual error > 40 °C | | %/K | ≤ 0.25 | – |
| Short-circuit protection rating maximum fuse | | | → Page 12 | With overload relay in conjunction with a transformer as required for the contactor |
| Current heat loss (3 conductors) | | | | |
| Lower value of setting range | | W | 16 | 3 |
| Upper value of setting range | | W | 28 | 10 |
| Terminal capacity | | | | |
| Flexible with ferrule | | mm ² | 95 | – |
| Stranded with ferrule | | mm ² | 120 | – |
| Solid or stranded | | AWG | 250 MCM | – |
| Flat conductor. | Number of segments x width x thickness | mm | 6 x 16 x 0.8 ²⁾ | – |
| Busbar | Width | mm | 20 x 3 | – |
| Push-through opening | ∅ | mm | – | 27 |
| Terminal screw | | | M8 x 25 | – |
| Tightening torque | | Nm | 24 | – |
| Tools | | | | |
| Hexagonal socket | | SW | mm | 13 |

Notes

¹⁾ Ambient temperature: Operating range to IEC/EN 60947, PTB: -5°C to +50°C

²⁾ Fixing with box terminals

ZE, ZB, Z5, ZW7

| | | | ZE | ZB12, ZB32 | ZB65 | ZB150(KK) | Z5-.../FF225 Z5-.../FF250 | ZW7 |
|--|-----------|-----------------|------------------|--|--|--|--|--|
| Auxiliary and control circuits | | | | | | | | |
| Rated impulse withstand voltage | U_{imp} | V | 6000 | 6000 | 6000 | 6000 | 6000 | 6000 |
| Overvoltage category/Pollution degree | | | III/3 | III/3 | III/3 | III/3 | III/3 | III/3 |
| Terminal capacity | | | | | | | | |
| Solid | | mm ² | 2 x (0.75 - 2.5) | 2 x (0.75 - 4) | 2 x (0.75 - 4) | 2 x (0.75 - 4) | 2 x (0.75 - 4) | 2 x (0.75 - 4) |
| Flexible with ferrule | | mm ² | 2 x (0.5 - 1.5) | 2 x (0.75 - 2.5) | 2 x (0.75 - 2.5) | 2 x (0.75 - 2.5) | 2 x (0.75 - 2.5) | 2 x (0.75 - 2.5) |
| Solid or stranded | | AWG | 2 x (18 - 12) | 2 x (18 - 12) | 2 x (18 - 12) | 2 x (18 - 12) | 2 x (18 - 12) | 2 x (18 - 12) |
| Terminal screw | | | M3.5 | M3.5 | M3.5 | M3.5 | M3.5 | M3.5 |
| Tightening torque | | Nm | 0.8 - 1.2 | 0.8 - 1.2 | 0.8 - 1.2 | 0.8 - 1.2 | 0.8 - 1.2 | 0.8 - 1.2 |
| Tools | | | | | | | | |
| Pozidriv screwdriver | | Size | 2 | 2 | 2 | 2 | 2 | 2 |
| Flat-blade screwdriver | | mm | 0.8 x 5.5 | 1 x 6 | 1 x 6 | 1 x 6 | 1 x 6 | 1 x 6 |
| Auxiliary circuit rated insulation voltage | U_i | V AC | 690 | 500 | 500 | 500 | 500 | 500 |
| Rated operating voltage | U_e | V AC | 500 | 500 | 500 | 500 | 500 | 500 |
| Safe isolation according to EN 61140 | | | | | | | | |
| Between the auxiliary contacts | | V AC | 300 | 240 | 240 | 240 | 240 | 240 |
| Conventional thermal current | I_{th} | A | 6 | 6 | 6 | 6 | 6 | 6 |
| Rated operational current | | | | | | | | |
| AC-15 | | | | | | | | |
| N/O | | | | | | | | |
| 120 V | I_e | A | 1.5 | 1.5 | 1.5 | 1.5 | 1.5 | 1.5 |
| 240 V | I_e | A | 1.5 | 1.5 | 1.5 | 1.5 | 1.5 | 1.5 |
| 415 V | I_e | A | 0.5 | 0.5 | 0.5 | 0.5 | 0.5 | 0.5 |
| 500 V | I_e | A | 0.3 | 0.5 | 0.5 | 0.5 | 0.5 | 0.5 |
| NC | | | | | | | | |
| 120 V | I_e | A | 1.5 | 1.5 | 1.5 | 1.5 | 1.5 | 1.5 |
| 240 V | I_e | A | 1.5 | 1.5 | 1.5 | 1.5 | 1.5 | 1.5 |
| 415 V | I_e | A | 0.7 | 0.9 | 0.9 | 0.9 | 0.9 | 0.9 |
| 500 V | I_e | A | 0.5 | 0.8 | 0.8 | 0.8 | 0.8 | 0.8 |
| DC-13 L/R ≤ 15 ms ¹⁾ | | | | | | | | |
| 24 V | I_e | A | 0.9 | 0.9 | 0.9 | 0.9 | 0.9 | 0.9 |
| 60 V | I_e | A | 0.75 | 0.75 ³⁾ | 0.75 ³⁾ | 0.75 ³⁾ | 0.75 ³⁾ | 0.75 ³⁾ |
| 110 V | I_e | A | 0.4 | 0.4 | 0.4 | 0.4 | 0.4 | 0.4 |
| 220 V | I_e | A | 0.2 | 0.2 | 0.2 | 0.2 | 0.2 | 0.2 |
| General Use | | | | | | | | |
| AC operated | | V | 240 600 | – | – | – | – | – |
| AC operated | | A | 1.5 0.6 | – | – | – | – | – |
| DC operated | | V | – | – | – | – | – | – |
| DC operated | | A | – | – | – | – | – | – |
| Pilot Duty | | | | | | | | |
| AC operated | | | D300 | B300 ⁴⁾ B600 ⁵⁾ | B300 ⁴⁾ B600 ⁵⁾ | B300 ⁴⁾ B600 ⁵⁾ | B300 ⁴⁾ B600 ⁵⁾ | B300 ⁴⁾ B600 ⁵⁾ |
| DC operated | | | R300 | R300 | R300 | R300 | R300 | R300 |
| Short-circuit rating without welding | | | | | | | | |
| Max. fuse ²⁾ | | A gG/gL | 4 | 6 | 6 | 6 | 6 | 6 |

Notes

- ¹⁾ Making and breaking conditions to DC-13, time constant as stated
- ²⁾ See transparent overlay "Fuses" for time/current characteristics (please enquire)
- ³⁾ Rated operational current DC-13, 60 V: N/O auxiliary contact 0.6 A
- ⁴⁾ With opposite polarity
- ⁵⁾ With same polarity

1.2 Electronic overload relays to 1500 A

ZEB

1

| | | | | ZEB12, ZEB32 | ZEB65-45 | ZEB65-100 | ZEB150 |
|--|--|------|------------------|------------------|------------------|------------------|------------------|
| General | | | | | | | |
| Standards | IEC/EN 60947, VDE 0660, UL, CSA | | | | | | |
| Climatic proofing | Damp heat, constant, to IEC 60068-2-78 Damp heat, cyclic, to IEC 60068-2-30 | | | | | | |
| Ambient temperature | | | | | | | |
| Open | °C | | -25...65 | -25...65 | -25...65 | -25...65 | -25...65 |
| Enclosed | °C | | -25...65 | -25...40 | -25...40 | -25...40 | -25...40 |
| Temperature compensation | Continuous | | | | | | |
| Mounting position | Any | | | | | | |
| Mechanical shock resistance half-sinusoidal shock, 10 ms to IEC 60068-2-27 | g | | 15 | 15 | 15 | 15 | 15 |
| Protection type | IP20 | | | | | | |
| Protection against direct contact when actuated from front (EN 50274) | Finger- and back-of-hand proof | | | | | | |
| Main contacts | | | | | | | |
| Rated impulse withstand voltage | U_{imp} | V AC | 6000 | 6000 | 6000 | 6000 | 6000 |
| Overvoltage category/pollution degree | III / 3 | | | | | | |
| Rated insulation voltage | | | | | | | |
| AC | U_i | V AC | 690 | 690 | 690 | 690 | 690 |
| Rated operating voltage | U_e | V AC | 690 | 690 | 690 | 690 | 690 |
| Safe isolation according to EN 61140 | | | | | | | |
| Between auxiliary contacts and main contacts | V AC | | 600 | 600 | 600 | 600 | 600 |
| Between the main contacts | V AC | | 600 | 600 | 600 | 600 | 600 |
| Overload relay setting range | A | | 0.3...45 | 9...45 | 20...100 | 20...100 | 20...100 |
| Terminal capacity | | | | | | | |
| Solid | mm ² | | 1 x 2.5 - 16 | 1 x 2.5 - 16 | 1 x 6 - 50 | 1 x 6 - 50 | 1 x 6 - 50 |
| Solid or stranded | AWG | | 1 x 14 - 4 | 1 x 14 - 4 | 1 x 10 - 1 | 1 x 10 - 1 | 1 x 10 - 1 |
| Auxiliary and control circuits | | | | | | | |
| Rated impulse withstand voltage | U_{imp} | V | 6000 | 6000 | 6000 | 6000 | 6000 |
| Overvoltage category/pollution degree | III / 3 | | | | | | |
| Terminal capacity | | | | | | | |
| Solid | mm ² | | 2 x (0.75 - 4) | 2 x (0.75 - 4) | 2 x (0.75 - 4) | 2 x (0.75 - 4) | 2 x (0.75 - 4) |
| Flexible with ferrule | mm ² | | 2 x (0.75 - 2.5) | 2 x (0.75 - 2.5) | 2 x (0.75 - 2.5) | 2 x (0.75 - 2.5) | 2 x (0.75 - 2.5) |
| Solid or stranded | AWG | | 2 x (18 - 12) | 2 x (18 - 12) | 2 x (18 - 12) | 2 x (18 - 12) | 2 x (18 - 12) |
| Terminal screw | | | M3.5 | M3.5 | M3.5 | M3.5 | M3.5 |
| Terminal screw | Nm | | 0.8 - 1.2 | 0.8 - 1.2 | 0.8 - 1.2 | 0.8 - 1.2 | 0.8 - 1.2 |
| Tightening torque | lb-in | | 7 - 10.6 | 7 - 10.6 | 7 - 10.6 | 7 - 10.6 | 7 - 10.6 |
| Tools | | | | | | | |
| Pozidriv screwdriver | Size | | 2 | 2 | 2 | 2 | 2 |
| Flat-blade screwdriver | mm | | 1 x 6 | 1 x 6 | 1 x 6 | 1 x 6 | 1 x 6 |
| Auxiliary circuit rated insulation voltage | U_i | V AC | 500 | 500 | 500 | 500 | 500 |
| Rated operating voltage | U_e | V AC | 500 | 500 | 500 | 500 | 500 |
| Safe isolation according to EN 61140 | | | | | | | |
| Between the auxiliary contacts | V AC | | 240 | 240 | 240 | 240 | 240 |
| Conventional thermal current | I_{th} | A | 5 | 5 | 5 | 5 | 5 |
| Rated operational current | | | | | | | |
| AC-15 | | | | | | | |
| N/O | | | | | | | |
| 120 V | I_e | A | 1.5 | 1.5 | 1.5 | 1.5 | 1.5 |
| 240 V | I_e | A | 1.5 | 1.5 | 1.5 | 1.5 | 1.5 |
| 415 V | I_e | A | 0.5 | 0.5 | 0.5 | 0.5 | 0.5 |
| 500 V | I_e | A | 0.5 | 0.5 | 0.5 | 0.5 | 0.5 |
| NC | | | | | | | |
| 120 V | I_e | A | 1.5 | 1.5 | 1.5 | 1.5 | 1.5 |
| 240 V | I_e | A | 1.5 | 1.5 | 1.5 | 1.5 | 1.5 |
| 415 V | I_e | A | 0.9 | 0.9 | 0.9 | 0.9 | 0.9 |
| 500 V | I_e | A | 0.8 | 0.8 | 0.8 | 0.8 | 0.8 |
| DC-13 L/R ≤ 15 ms | | | | | | | |
| 24 V | I_e | A | 0.9 | 0.9 | 0.9 | 0.9 | 0.9 |
| 60 V | I_e | A | 0.75 | 0.75 | 0.75 | 0.75 | 0.75 |
| 110 V | I_e | A | 0 | 0 | 0.4 | 0.4 | 0.4 |
| 220 V | I_e | A | 0.2 | 0.2 | 0.2 | 0.2 | 0.2 |
| Short-circuit rating without welding | | | | | | | |
| Max. fuse | A gG/gL | | 6 | 6 | 6 | 6 | 6 |

EMT6

EMT6

1

| General | | | |
|---|-----------------|----------|---|
| Standards | | | IEC/EN 60947, VDE 0660, EN 55011 |
| Climatic proofing | | | Damp heat, constant, to IEC 60068-2-78; Damp heat, cyclic, to IEC 60068-2-30 |
| Ambient temperature | | | |
| Open | °C | | -25...60 |
| Enclosed | °C | | -25...45 |
| Storage | °C | | -45 - 60 |
| Mounting position | | | Any |
| Weight | kg | | 0.15 |
| Shock resistance half-sinusoidal shock 10 ms to IEC 60068-2-27 | g | | 10 |
| Protection type | | | IP20 |
| Protection against direct contact when actuated from front (EN 50274) | | | Finger- and back-of-hand proof |
| Safe isolation according to EN 61140 | | | |
| Between the contacts | V AC | | 250 |
| Between contacts and supply voltage | V AC | | 250 |
| Auxiliary and control circuits | | | |
| Rated impulse withstand voltage | U_{imp} | V AC | 6000 |
| Overtoltage category/pollution degree | | | III/3 |
| Auxiliary and control circuit terminal capacity | | | |
| Solid | mm ² | | 1 x 2.5 2 x (0.5 - 1.5) |
| Flexible with ferrule | mm ² | | 1 x 2.5 2 x (0.5 - 1.5) |
| Solid or stranded | AWG | | 20 - 14 |
| Terminal screw | | | M3.5 |
| Tightening torque | Nm | | 1.2 |
| Tools | | | |
| Pozidriv screwdriver | Size | | 2 |
| Flat-blade screwdriver | mm | | 1 x 6 |
| Auxiliary circuit | | | |
| Rated insulation voltage | U_i | V | 400 |
| Rated operational current | | | |
| AC-14 | | | |
| N/O | | | |
| 415 V | I_e | A | 3 |
| NC | | | |
| 415 V | I_e | A | 3 |
| AC-15 | | | |
| N/O | | | |
| 240 V | I_e | A | 3 |
| 415 V | I_e | A | 1 |
| NC | | | |
| 240 V | I_e | A | 3 |
| 415 V | I_e | A | 1 |
| Max. short-circuit protective device | | | |
| Fuse | gG/gL | | 6 |
| Control circuit | | | |
| Rated insulation voltage | U_i | V | 240 |
| Rated operational voltage | U_e | V | 240 ¹⁾ |
| Voltage tolerance | | x U_e | 0.85 - 1.1 |
| Power consumption | | | |
| AC | | VA | 3.5 |
| DC | | W | 2 |
| Trip at approx. | | Ω | \cong 3600 |
| Reset at approx. | | Ω | \cong 1600 |

Notes

¹⁾ EMT6(-DB)230V: $U_e = 230$ V

1.2

Overload relays

Overload relays

1 Dimensions

Overload relays

ZE-...

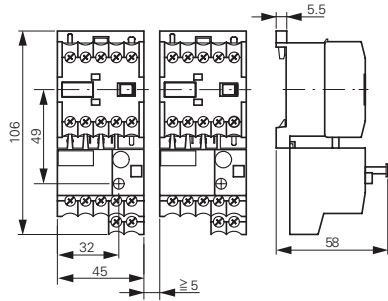

Base

ZB32-XEZ

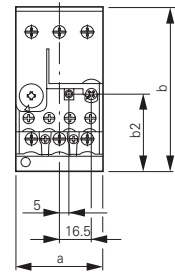

ZB65-XEZ

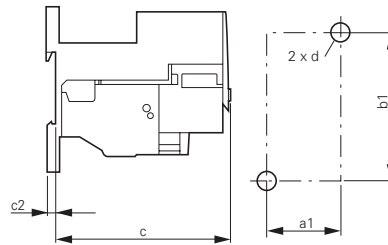

| | ZB32 | ZB65 |
|----|------|------|
| a | 45 | 60 |
| b | 85 | 86 |
| c | 90.5 | 112 |
| c2 | 3.8 | 4.7 |
| a1 | 35 | 50 |
| b1 | 75 | 75 |
| b2 | 40.5 | 47 |
| d | M4 | M5 |

ZB12

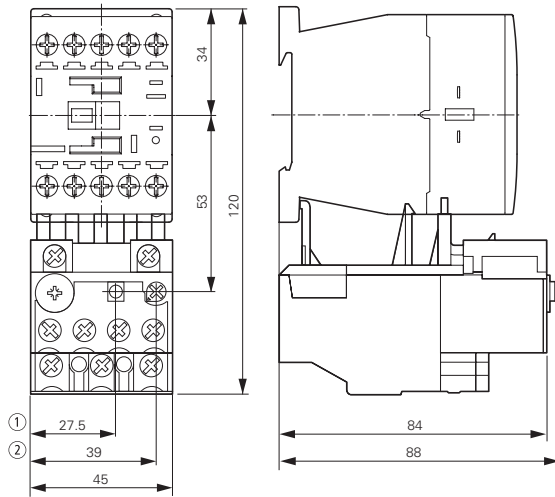

- ① OFF
- ② Reset/ON

ZB32

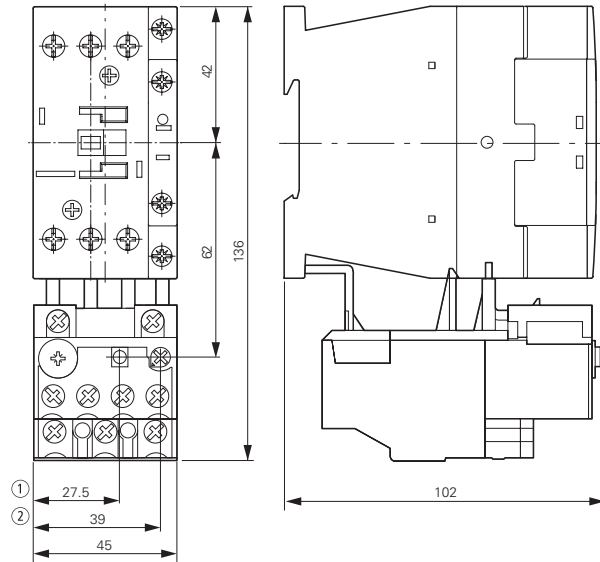

ZB32-38

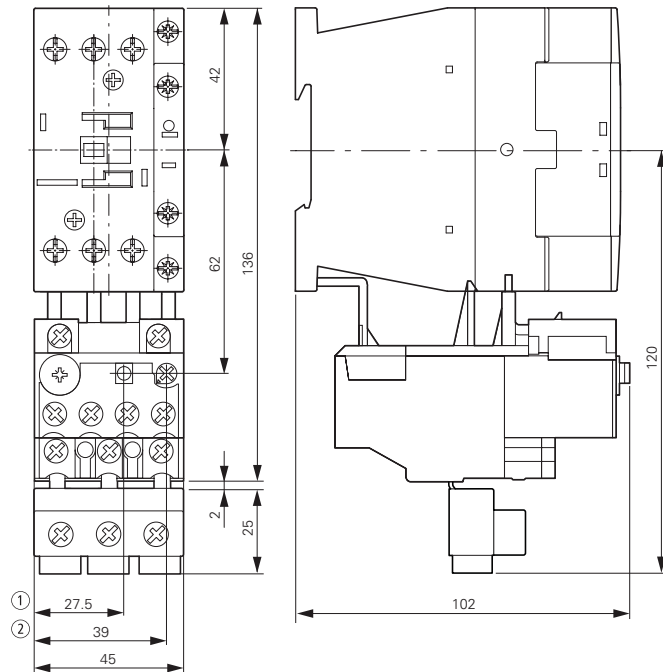

- ① OFF
- ② Reset/ON

Overload relays

ZB65

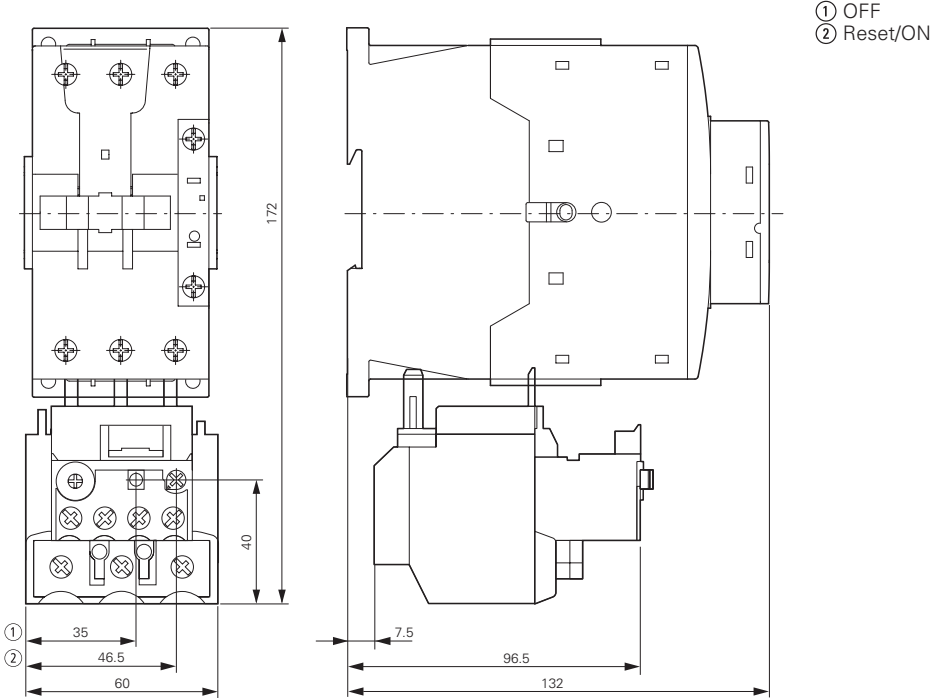

ZB150

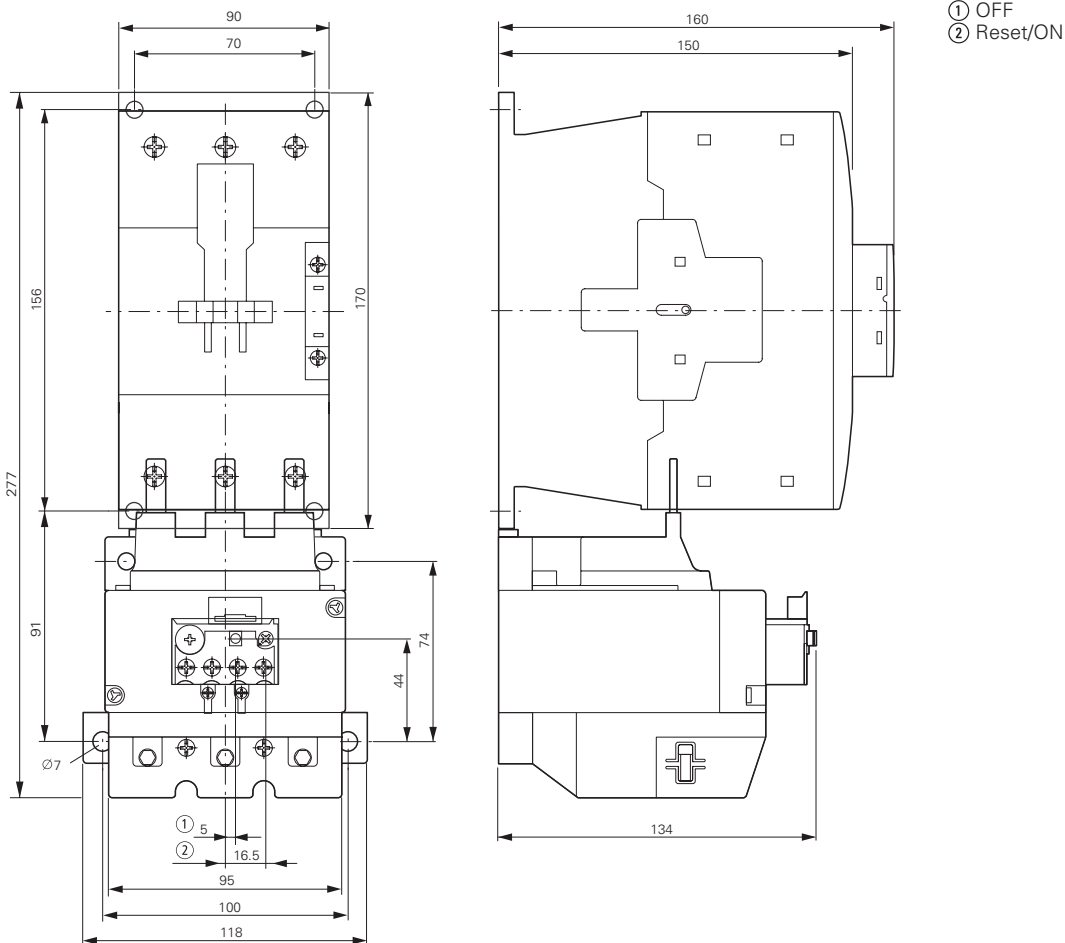

1.2

Overload relays

Overload relays, CT-operated overload relays

1 Overload relays

ZB150-50/KK

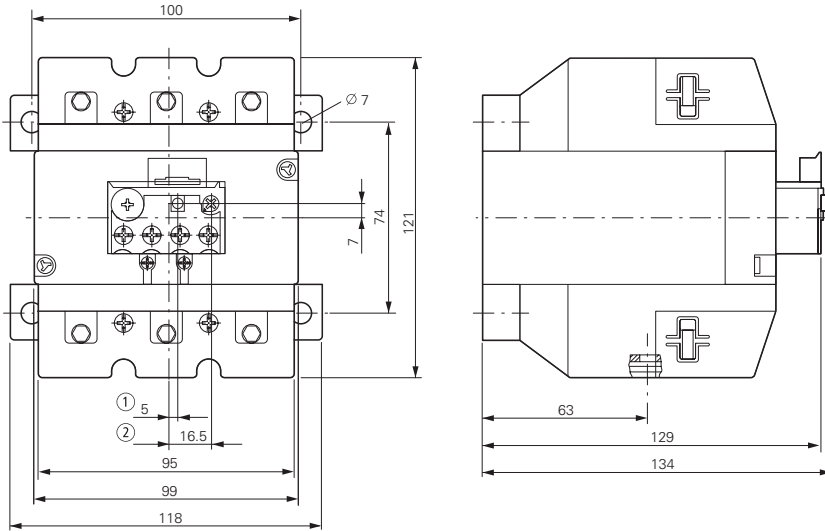

- ① OFF
- ② Reset/ON

Z5 overload relays greater than 150A

Z5.../FF250

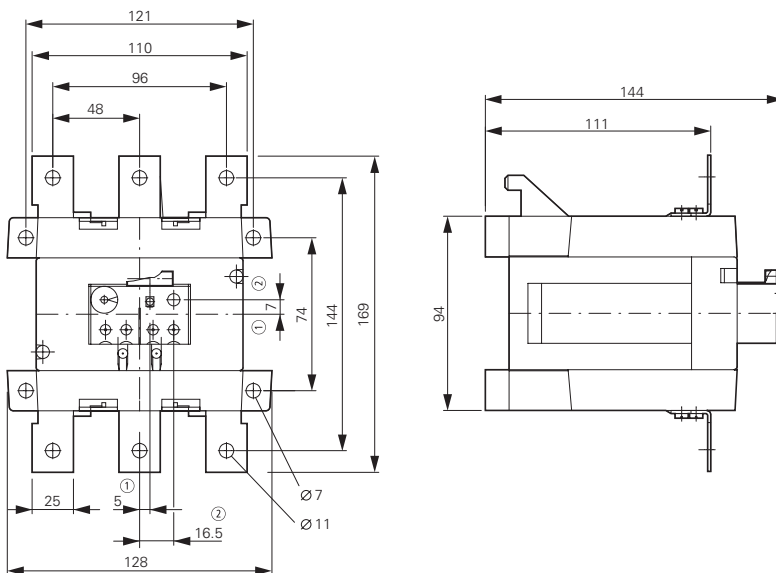

- ① OFF
- ② Reset/ON

Current transformer-operated overload relays

ZW7-...

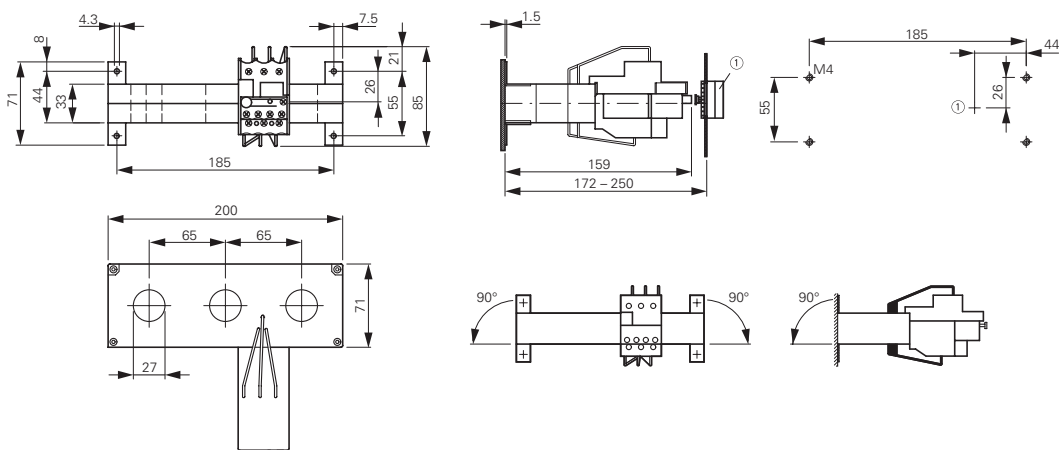

- ① Reset/ON

Electronic overload relays

ZEB12

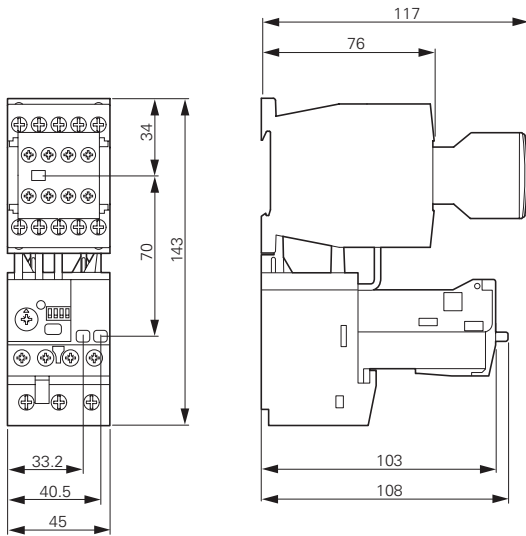

ZEB32

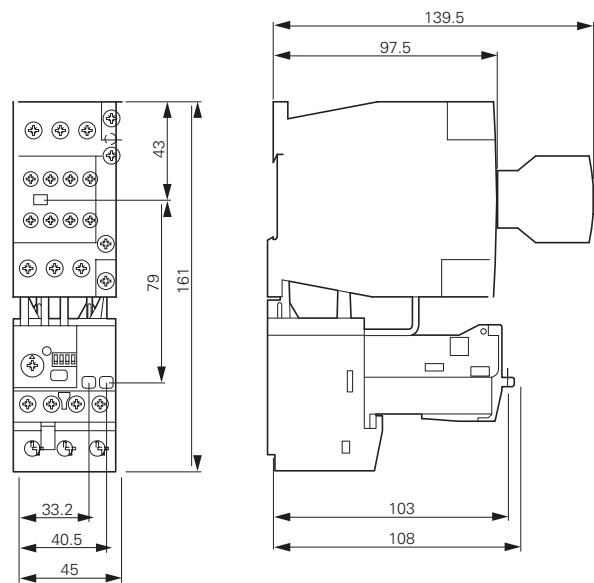

ZEB65-45

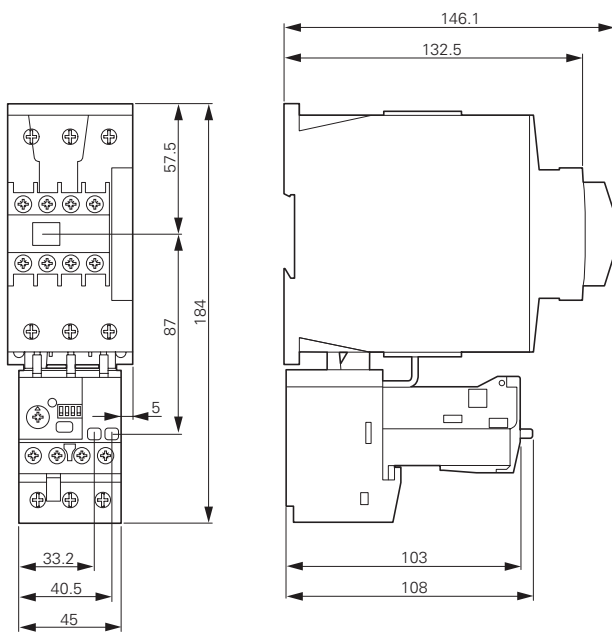

ZEB65-100

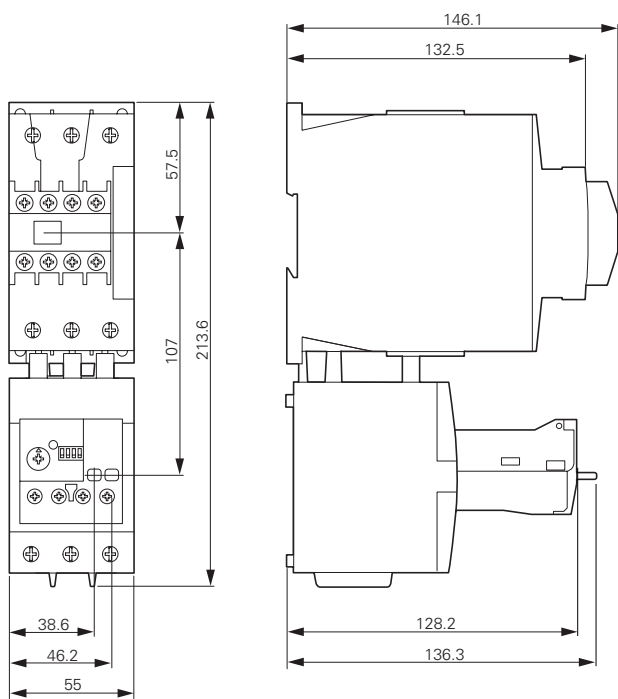

1.2

Overload relays

Electronic overload relays

1 Electronic overload relays

ZEB150-100

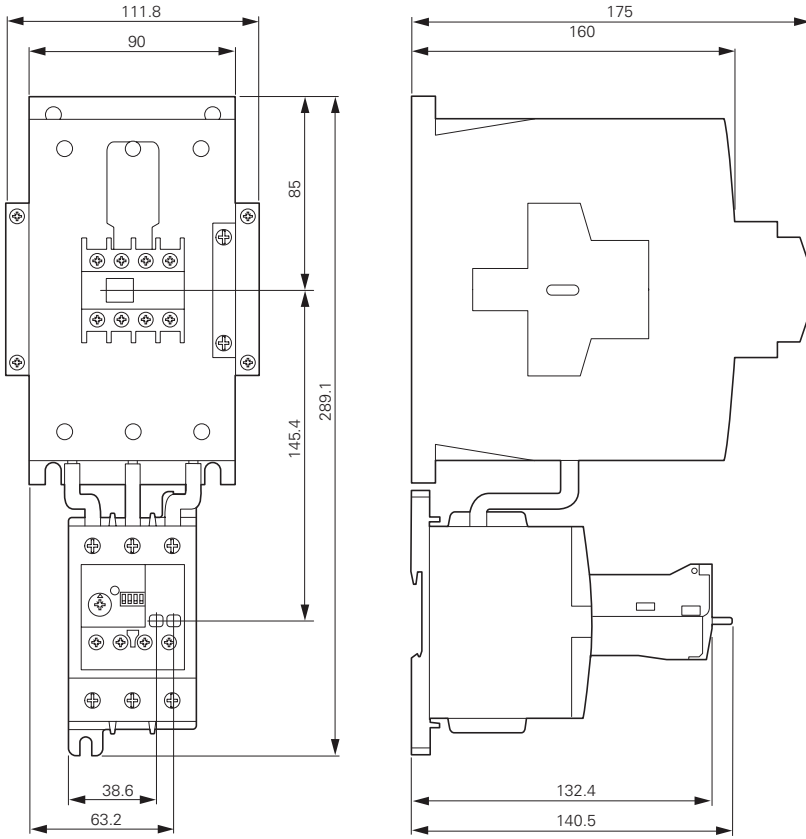

ZEB150-100/KK

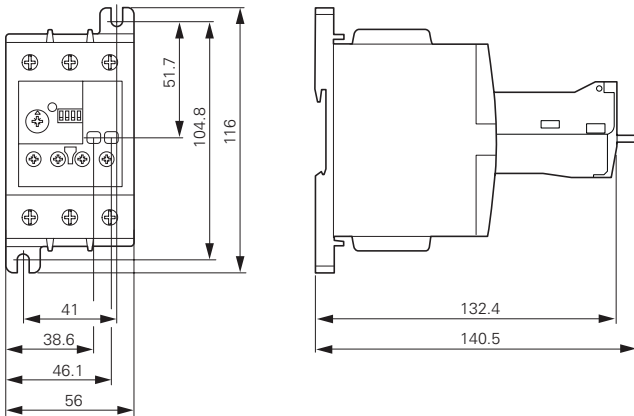

Current sensors

ZEB-XCT300

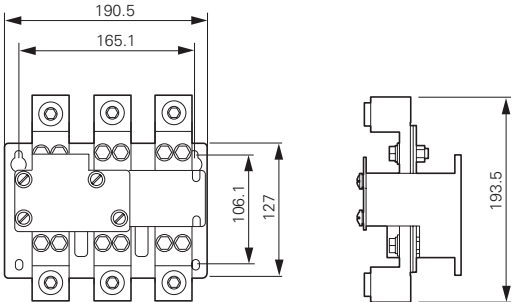

ZEB-XCT600

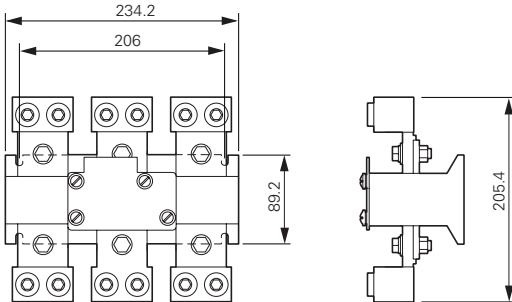

ZEB-XCT1000
ZEB-XCT1500

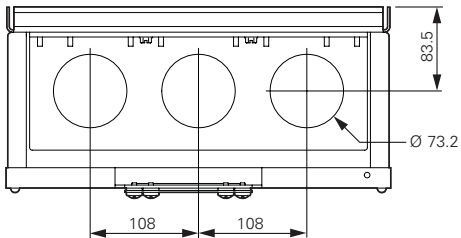
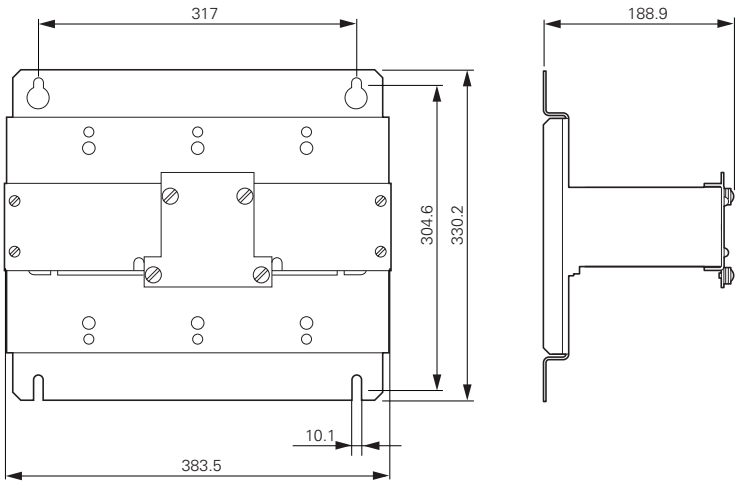

EMT6 thermistor overload relays for machine protection

EMT6...

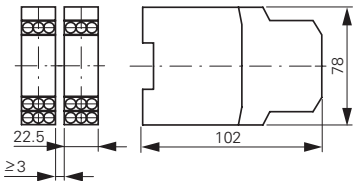

External reset button

M22-DZ-B
M22-DZ-X

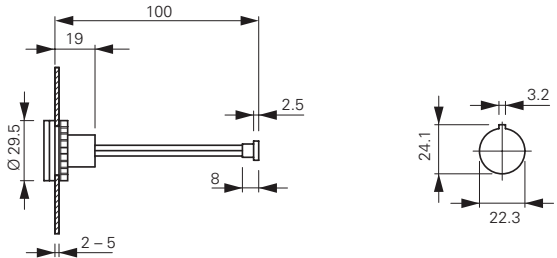

C441 overload and monitoring relay



C441 overload and monitoring relay

| | |
|---|----|
| Features and benefits | 38 |
| Catalog number selection | 41 |
| Product selection | 42 |
| Accessories | 43 |
| Technical data and specifications | 48 |
| Dimensions | 60 |

1

C441 overload and monitoring relay

Product description

Eaton’s Motor Insight, the first product in the Intelligent Power Control Solutions family, is a highly configurable motor, load and line protection device with power monitoring, diagnostics and flexible communications allowing the customer to save energy, optimize their maintenance schedules and configure greater system protection, thus reducing overall costs and downtime.

Motor Insight is available in either a line-powered or 120 Vac control powered design, capable of monitoring voltages up to 660 Vac. Each of these units is available in a 1–9 amp or a 5–90 amp FLA model. With external CTs, Motor Insight can protect motors up to 540 amps FLA. Available add-on accessories include communication modules for Modbus RTU, DeviceNet, PROFIBUS, Modbus TCP, EtherNet/IP and HTTP web services all with I/O options. For ease-of-use and operator safety, Motor Insight offers a remote display that mounts easily with two 30 mm knockouts.

1.2

C441 overload and monitoring relay

Features and benefits

1 Features and Benefits

Features

Size/Range

- Broad FLA range of 1–540A
- Selectable trip class (5–30)
- Four operating voltage options
 - Line-powered from 240 Vac, 480 Vac, 600 Vac
 - Control-powered from 120 Vac

Motor Control

- Two output relays
 - One B300 Form C fault relay and one B300 ground fault shunt relay
 - Other relay configurations are available, including one Form A and one Form B SPST (fault and auxiliary relays) allowing programmable isolated relay behavior and unique voltages
- One external remote reset terminal
- Trip status indicator

Motor Protection

- Thermal overload
- Jam protection
- Current imbalance
- Current phase loss
- Ground fault
- Phase reversal

Load Protection

- Under current
- Low power (kW)
- High power (kW)

Standards and Certifications

- cULus listed NKCR, NKCR7, 508
- UL® 1053 applicable sections for ground fault detection
- CSA® certified (Class 3211-02)
- CE
- NEMA®

Benefits

Reliability and Improved Uptime

- Advanced diagnostics allows for quick and accurate identification of the root source of a motor, pump or power quality fault; reducing troubleshooting time and the loss of productivity, reducing repeat faults due to misdiagnosis, and increasing process output and profitability
- Provides superior protection of motors and pumps before catastrophic failure occurs
- Increases profitability with greater process uptime and throughput, reduced costs per repair, reduced energy consumption and extended equipment life
- Adjustments to overload configuration can be made at any time

Safety

- IP20 rated terminal blocks
- Terminal blocks are set back from the display to reduce operator shock hazard
- Remote display (optional) does not require that the operator open the panel to configure the device

Flexibility

- Communications modules
 - Offered in a variety of configurations
 - External snap-on modules provide support for multiple communications protocols
- Advanced power, voltage and current monitoring capabilities
- Communications modules and remote display can be used simultaneously
- Highly configurable fault and reset characteristics for numerous applications
- Fully programmable isolated fault and auxiliary relays

Ease of Use

- Bright LED display with easy-to-understand setting and references
- Powered from line voltage or 120 Vac control power
- Remote display powered from base unit
- Full word descriptions and units on user interface

- IEC EN 60947-4-1
- RoHS
- CCC



Advanced Overload Education

| Description | Definition | Source | Result | Motor Insight Protection |
|---|--|---|--|---|
| Motor Protection | | | | |
| Thermal overload | Overload is a condition in which current draw to a motor exceeds 115% of the full load amperage rating over a period of time for an inductive motor. | <p>An increase in the load or torque that is being driven by the motor.</p> <p>A low voltage supply to the motor would cause the current to go high to maintain the power needed.</p> <p>A poor power factor would cause above normal current draw.</p> | Increase in current draw. Current leads to heat and insulation breakdown, which can cause system failure. Additionally, an increase in current can increase power consumption and waste valuable energy. | <p>Thermal trip behavior is defined by UL, CSA and IEC standards.</p> <p>Trip class is settable from 5–30 by 1</p> <p>Provides power factor monitoring and low voltage protection features.</p> |
| Jam | Jam is similar to thermal overload in that it is a current draw on the motor above normal operating conditions. | Mechanical stall, interference, jam or seizure of the motor or motor load. | The motor attempts to drive the load, which has more resistive force due to the mechanical interference. In order to drive the load, the motor draws an abnormal amount of current, which can lead to insulation breakdown and system failure. | <p>Provides a configurable Jam setting that is active during “motor run state” to avoid nuisance trips.</p> <p>Trip Threshold 150–400% of FLA.</p> <p>Trip Delay 1–20 seconds.</p> |
| Ground fault | A line to ground fault. | A current leakage path to ground. | An undetected ground fault can burn through multiple insulation windings, ultimately leading to motor failure. | <p>Motor Insight has ground fault protection capability down to 0.15 amps estimated from the existing three-phase CTs using the residual current method. That is, the three-phase current signals should sum to zero unless a ground fault (GF) condition is present. In the case of a GF, Motor Insight can alarm, trip the starter, or trip an alternative relay that can be used to shunt trip a breaker or light up a warning light. GF current can also be monitored in real-time through the advanced monitoring capabilities.</p> <p>Note: GF settable thresholds vary with motor FLA. 0.15 amps may not be available in all cases.</p> |
| Imbalanced phases (voltage and current) | Uneven voltage or currents between phases in a three-phase system. | When a three-phase load is powered with a poor quality line, the voltage per phase may be imbalanced. | Imbalanced voltage causes large imbalanced currents and as a result this can lead to motor stator windings being overloaded, causing excessive heating, reduced motor efficiency and reduced insulation life. | Provides two protection settings that address this problem. The user can choose to set current imbalance thresholds or voltage imbalance thresholds, each of which can trip the starter. Additionally, both of these may be monitored through Motor Insight’s advanced monitoring capabilities, allowing the customer to notice in real-time when and where a condition is present. |
| Phase loss—current (single-phasing) | One of the three-phase current is not present. | Multiple causes, loose wire, improper wiring, grounded phase, open fuse, and so on. | Single-phasing can lead to unwanted motor vibrations in addition to the results of imbalanced phases as listed above. | Fixed protective setting that takes the starter offline if a phase drops below 60% of the other two phases. |
| Phase rotation (phase-reversal) | Improper wiring, leading to phases being connected to the motor improperly. | A miswired motor. Inadvertent phase-reversal by the utility. | Phase-reversal can cause unwanted directional rotation of a motor. In the event that the load attached to the motor can only be driven in one direction, the result could be significant mechanical failure and/or injury to an operator. | Configurable phase protection, allowing the user to define the phase sequencing intended for that application. If no phase sequence is required, the user has the ability to disable this feature. |
| Frequency variance | When line frequency is inconsistent. | Malfunctioning alternator speed regulator, or poor line quality caused by an overload of a supply powered by individual sources. | Variations in frequency can cause increases in losses, decreasing the efficiency of the motor. In addition, this can result in interference with synchronous devices. | Advanced monitoring capabilities allow the user to monitor frequency in real-time. |

1.2

C441 overload and monitoring relay

Features and benefits

1 Advanced Overload Education, continued

| Description | Definition | Source | Result | Motor Insight Protection |
|----------------------------|---|---|---|--|
| Load Protection | | | | |
| Under current or low power | Average rms current provided to the motor falls below normal operating conditions. | Under current is usually associated with a portion of the user's load disappearing. Examples of this would be a broken belt, a dry-pump (low suction head) or a dead-headed centrifugal pump. | If under current goes undetected, a mechanical failure can and has occurred. In the case of a pump, running a pump dry or running a pump in a dead-headed condition can cause excessive heating, damaging expensive seals and breaking down desired fluid properties. | Motor Insight has two protection settings to detect this: under current and low power. Low power is a more consistent way of ensuring detection as power is linear with motor load, where as current is not. An unloaded motor may draw 50% of its rated current, but the power draw will be less than 10% of rated power due to a low power factor. |
| High power | The motor load is drawing more power than it should at normal operating conditions. | This is typical of batch processing applications where several ingredients flow into a mixer. When a substance's consistency changes and viscosity increases from what is expected, the motor may use more power to blend the mixture. Out-of-tolerance conditions can be detected using the High Power and Low Power settings. | If a high-power fault goes undetected, the result may be a batch of material that does not meet specification. | Monitors the three-phase real power. If the real power value is estimated above the set threshold for the set length of time, a fault is detected and the overload will trip the starter. Additionally, power can be monitored in real-time. |
| Line Protection | | | | |
| Over voltage | When the line voltage to the motor exceeds the specified rating. | Poor line quality. | An over voltage condition leads to a lower than rated current draw and a poor power factor. A trip limit of 110% of rated voltage is recommended. Over voltage can also lead to exceeding insulation ratings. | Monitors the maximum rms value of the three-phase voltages. If the rms value rises above the set threshold for the set length of time, a fault is detected and the overload can trip the starter or send and display an alarm of the condition. All line-related faults have an "alarm-no-trip" mode. |
| Under voltage | When the line voltage to the motor is below the specified rating. | Poor line quality. | An under voltage condition leads to excessive current draw. This increases the heating of the motor windings and can shorten insulation life. A trip limit set to 90% of rated voltage is recommended. | Monitors the minimum rms value of the three-phase voltages. If the rms value drops below the set threshold for the set length of time, a fault is detected and the overload can trip the starter or send and display an alarm of the condition. All line-related faults have an "alarm-no-trip" mode. |
| Power-up delay | Allows for starting motors and loads in a deliberate fashion. | When there is a power failure, or power cycle, multiple loads come online simultaneously. | Multiple loads starting simultaneously can cause sags affecting the operation of devices that may prevent successful startup. If power is lost to a motor driving a pump, it may be necessary to delay a restart to allow the pump to come to a complete stop to prevent starting a motor during backspin. | Configurable to delay closing the fault relay on power-up. For each Motor Insight controlling a motor, a different setting can be programmed, helping to maintain the integrity of your line power. |

Catalog Number Selection

Motor Insight Overload Relays

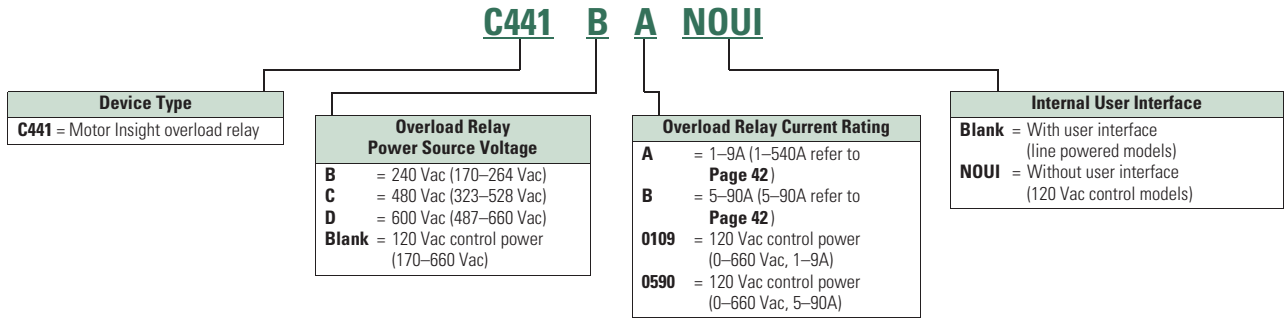

Motor Insight Overload Relays—Communications Modules and Accessory Types

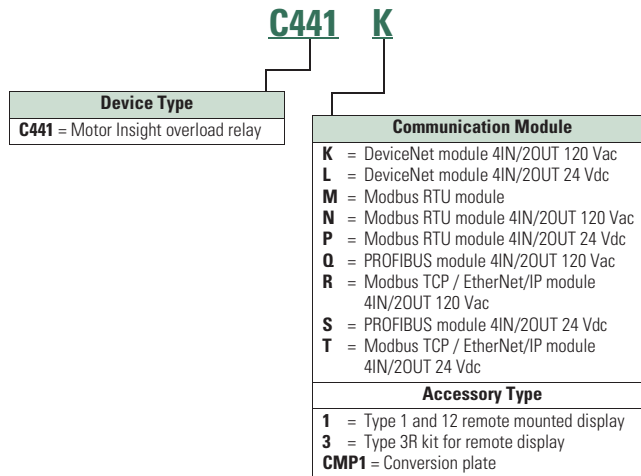

1.2

C441 overload and monitoring relay

Product selection

1 Product Selection

Motor Insight



Motor Insight

| Power Source | Monitoring Range | Current Range | Catalog Number |
|--------------------|------------------|---------------|---------------------|
| 240 Vac (170–264) | 170–264 Vac | 1–9A | C441BA |
| | | 5–90A | C441BB |
| 480 Vac (323–528) | 323–528 Vac | 1–9A | C441CA |
| | | 5–90A | C441CB |
| 600 Vac (489–660) | 489–660 Vac | 1–9A | C441DA |
| | | 5–90A | C441DB |
| 120 Vac (93.5–132) | 170–660 Vac | 1–9A | C4410109NOUI |
| | | 5–90A | C4410590NOUI |

Motor Insight CT Multiplier and Wire Wrap Schedule

| Catalog Number ^① | Motor FLA | Number of Loops | Number of Conductors Through CT Primary | CT Multiplier Setting | External CT Kit Catalog Number ^② |
|--------------------------------|-----------|-----------------|---|-----------------------|---|
| Current Range: 5–90A | | | | | |
| C441_B and C4410590NOUI | 5–22.5A | 3 | 4 | 4 | — |
| | 6.67–30A | 2 | 3 | 3 | — |
| | 10–45A | 1 | 2 | 2 | — |
| | 20–90A | 0 | 1 | 1 | — |
| Current Range: 1–9A | | | | | |
| C441_A and C4410109NOUI | 1–5A | 1 | 2 | 2 | — |
| | 2–9A | 0 | 1 | 1 | — |
| | 60–135A | 0 | 1 | 150–(150:5) | C441CTKIT150 |
| | 120–270A | 0 | 1 | 300–(300:5) | C441CTKIT300 |
| | 240–540A | 0 | 1 | 600–(600:5) | C441CTKIT600 |

Notes

① Underscore indicates Operating Voltage Code required.
Operating Voltage Codes:

| Code | Voltage |
|----------------------|-----------------------|
| B | 240 Vac |
| C | 480 Vac |
| D | 600 Vac |
| <empty> | 120 Vac Control Power |

② Any manufacturer's CTs may be used.

Accessories

Modbus Communication Module

The Motor Insight Modbus Communication Module is a side-mounted device providing Modbus communication capability to the Motor Insight overload relay.

The Modbus Communication Module with I/O provides communication, monitoring and control for the Motor Insight overload relay.

Features and Benefits

- The Modbus communication module is capable of baud rates up to 115K
- The Modbus address and baud rate configuration can be easily changed using the Motor Insight user interface (C441M only)
- Modbus address and baud rate are set via convenient DIP switches (C441N and C441P); LEDs are provided to display Modbus traffic
- Configuration with common Modbus configuration tools
- Terminals
 - Unique locking mechanism provides for easy removal of the terminal block with the field wiring installed
 - Each terminal is marked for ease of wiring and troubleshooting
- Selectable I/O assemblies
 - 4IN/2OUT
 - Signal types include 24 Vdc I/O and 120 Vac I/O
- Each I/O module is optically isolated between the field I/O and the network adapter to protect the I/O and communication circuits from possible damage due to transients and ground loops
- Input Module features a user-definable input debounce, which limits the effects of transients and electrical noise
- Output Module supports a user-definable safe state for loss of communication; hold last state, ON or OFF

Modbus Communication Module

| | Description | I/O | Catalog Number |
|-------------------------------|--------------------------------------|---------|----------------|
| Modbus Module | Modbus Communication Module | None | C441M |
| Modbus with I/O Module | Modbus Communication Module 4IN/2OUT | 120 Vac | C441N |
| | Modbus Communication Module 4IN/2OUT | 24 Vdc | C441P |



1.2 C441 overload and monitoring relay

Product selection

1 DeviceNet Communication Modules

The DeviceNet Communication Module provides monitoring and control for the Motor Insight overload relay from a single DeviceNet node. These modules also offer convenient I/O in two voltage options, 24 Vdc and 120 Vac.

Features and Benefits

- Communication to DeviceNet uses only one DeviceNet MAC ID
- Configuration
 - DeviceNet MAC ID and Baud rate are set via convenient DIP switches with an option to set from the network
 - Advanced configuration available using common DeviceNet tools
- Terminals
 - Unique locking mechanism provides for easy removal of the terminal block with the field wiring installed
 - Each terminal is marked for ease of wiring and troubleshooting
- Selectable I/O assemblies
 - 4IN/2OUT
 - Signal types include 24 Vdc I/O and 120 Vac I/O
 - Each I/O module is optically isolated between the field I/O and the network adapter to protect the I/O and communication circuits from possible damage due to transients and ground loops
- Input Module features a user-definable input debounce, which limits the effects of transients and electrical noise
- Output Module supports a user-definable safe state for loss of communication; hold last state, ON or OFF
- Combined status LED

DeviceNet Module



DeviceNet Modules

| Description | I/O | Catalog Number |
|--------------------------------|---------|----------------|
| DeviceNet Communication Module | 120 Vac | C441K |
| DeviceNet Communication Module | 24 Vdc | C441L |

PROFIBUS Communication Module

The Motor Insight PROFIBUS Communication Module is a side-mounted device providing PROFIBUS communication capability to the Motor Insight overload relay.

The PROFIBUS Communication Module with I/O provides communication, monitoring and control for the Motor Insight overload relay.

Features and Benefits

- The PROFIBUS communication module is capable of baud rates up to 12 Mb
- PROFIBUS address is set via convenient DIP switches (C441Q and C441S); LEDs are provided to display PROFIBUS status
- Intuitive configuration with common PROFIBUS configuration tools
- Terminals
 - Unique locking mechanism provides for easy removal of the terminal block with the field wiring installed
 - Each terminal is marked for ease of wiring and troubleshooting
- Selectable I/O assemblies
 - 4IN/2OUT
 - Signal types include 24 Vdc I/O and 120 Vac I/O
- Each I/O module is optically isolated between the field I/O and the network adapter to protect the I/O and communication circuits from possible damage due to transients and ground loops
- Input Module features a user-definable input debounce, which limits the effects of transients and electrical noise
- Output Module supports a user-definable safe state for loss of communication; hold last state, ON or OFF

PROFIBUS with I/O Module



PROFIBUS Communication Module

| Description | I/O | Catalog Number |
|--|---------|----------------|
| PROFIBUS Communication Module 4IN/2OUT | 120 Vac | C441S |
| PROFIBUS Communication Module 4IN/2OUT | 24 Vdc | C441Q |

1.2 C441 overload and monitoring relay

Accessories

1 Ethernet Communication Module

The Motor Insight Ethernet Communication Module is a side-mounted device providing both Modbus TCP and EtherNet/IP communication capabilities with built-in HTTP web services to the Motor Insight overload relay.

The Ethernet Communication Module with I/O provides communication, monitoring and control for the Motor Insight overload relay.

Features and Benefits

- Supports Modbus TCP or EtherNet/IP in a single device
- Contains internal embedded switch which provides two Ethernet ports allowing linear or ring network configurations
- Embedded web services allow for simple configuration and monitoring through Internet Explorer
- IP Address is set via convenient DIP Switches located on the device
- Terminals
 - Unique locking mechanism provides for easy removal of the terminal block with the field wiring installed
 - Each terminal is marked for ease of wiring and troubleshooting
- Selectable I/O assemblies
 - 4IN/2OUT
 - Signal types include 24 Vdc I/O and 120 Vac I/O
- Each I/O module is optically isolated between the field I/O and the network adapter to protect the I/O and communication circuits from possible damage due to transients and ground loops
- Input Module features a user-definable input debounce, which limits the effects of transients and electrical noise
- Output Module supports a user-definable safe state for loss of communication; hold last state, ON or OFF

Ethernet with I/O Module



Ethernet Communication Module

| Description | I/O | Catalog Number |
|--|---------|----------------|
| Modbus TCP / EtherNet/IP Communication Module 4IN/2OUT | 120 Vac | C441R |
| Modbus TCP / EtherNet/IP Communication Module 4IN/2OUT | 24 Vdc | C441T |

Type 3R Kit with Remote Display Mounted Inside

Motor Insight offers several accessories for the customer's ease of use and safety:

- Types 1 and 12 remote display
- Type 3R remote display kit
- Mounting plate adapter

Features and Benefits

- Remote display unit:
 - Same user interface as the overload relay
 - Enhanced operator safety—operator can configure the overload without opening the enclosure door
- Type 3R kit mounts with standard 30 mm holes
- Mounting plate for retrofit in existing installations

Type 3R Kit with Remote Display Mounted Inside

| | Description | Catalog Number |
|--|---|----------------|
| | Remote display Types 1 and 12 (UL 508) | C4411 |
| | Type 3R kit for remote display (UL 508) | C4413 |
| | Conversion plate (not shown) | C441CMP1 |

Communication Cables

The Remote Display requires a communication cable to connect to the Motor Insight overload relay:

Communication Cable Lengths

| Length in Inches (meters) | Catalog Number |
|---------------------------|----------------|
| 9.8 (0.25) | D77E-QPIP25 |
| 39.4 (1.0) | D77E-QPIP100 |
| 78.7 (2.0) | D77E-QPIP200 |
| 118.1 (3.0) | D77E-QPIP300 |

Current Transformer Kits

| Description | Catalog Number |
|---|----------------|
| Three 150:5 CTs to be used with Motor Insight | C441CTKIT150 |
| Three 300:5 CTs to be used with Motor Insight | C441CTKIT300 |
| Three 600:5 CTs to be used with Motor Insight | C441CTKIT600 |

1 Technical Data and Specifications

Motor Insight

| Description | Specification C441B_ | C441C_ | C441D_ | C441_ _ _ _NOUI | | |
|---|---|---|---|---|---|--|
| Electrical Ratings | | | | | | |
| Feature | Range | | | | | |
| Operating voltage (three-phase) and frequency | 170–264 Vac 50/60 Hz | 323–528 Vac 50/60 Hz | 489–660 Vac 50/60 Hz | 170–660 Vac 50/60 Hz | | |
| Trip Class | | | | | | |
| 5–30 | Selectable | Selectable | Selectable | Selectable | | |
| FLA Range | | | | | | |
| C441_A and C4410109NOUI | 1–9A | Up to 540A with external CTs Refer to Page 42 for CT multiplier and wire wrap schedule. | Up to 540A with external CTs Refer to Page 42 for CT multiplier and wire wrap schedule. | Up to 540A with external CTs Refer to Page 42 for CT multiplier and wire wrap schedule. | | |
| C441_B and C4410590NOUI | 5–90A | | | | | |
| Monitoring Capabilities | | | | | | |
| Feature | Value | | | | | |
| Current | Per phase rms (1A, 1B, 1C), 2% accuracy Average rms, 2% accuracy Imbalance percent (0–100%) Ground fault current, 10% accuracy | Per phase rms (1A, 1B, 1C), 2% accuracy Average rms, 2% accuracy Imbalance percent (0–100%) Ground fault current, 10% accuracy | Per phase rms (1A, 1B, 1C), 2% accuracy Average rms, 2% accuracy Imbalance percent (0–100%) Ground fault current, 10% accuracy | Per phase rms (1A, 1B, 1C), 2% accuracy Average rms, 2% accuracy Imbalance percent (0–100%) Ground fault current, 10% accuracy | Per phase rms (1A, 1B, 1C), 2% accuracy Average rms, 2% accuracy Imbalance percent (0–100%) Ground fault current, 10% accuracy | |
| Voltage | Per phase rms (1A, 1B, 1C), 2% accuracy Average rms, 2% accuracy Imbalance percent (0–100%) | Per phase rms (1A, 1B, 1C), 2% accuracy Average rms, 2% accuracy Imbalance percent (0–100%) | Per phase rms (1A, 1B, 1C), 2% accuracy Average rms, 2% accuracy Imbalance percent (0–100%) | Per phase rms (1A, 1B, 1C), 2% accuracy Average rms, 2% accuracy Imbalance percent (0–100%) | Per phase rms (1A, 1B, 1C), 2% accuracy Average rms, 2% accuracy Imbalance percent (0–100%) | |
| Power | Motor kW, 5% accuracy Motor power factor, inductive 0–1.0, 1% accuracy | Motor kW, 5% accuracy Motor power factor, inductive 0–1.0, 1% accuracy | Motor kW, 5% accuracy Motor power factor, inductive 0–1.0, 1% accuracy | Motor kW, 5% accuracy Motor power factor, inductive 0–1.0, 1% accuracy | Motor kW, 5% accuracy Motor power factor, inductive 0–1.0, 1% accuracy | |
| Thermal capacity | 0% cold, 100% trip | 0% cold, 100% trip | 0% cold, 100% trip | 0% cold, 100% trip | 0% cold, 100% trip | |
| Motor run hours | 0–65,535 hours | 0–65,535 hours | 0–65,535 hours | 0–65,535 hours | 0–65,535 hours | |
| Frequency | 47–63 Hz, 1% accuracy | 47–63 Hz, 1% accuracy | 47–63 Hz, 1% accuracy | 47–63 Hz, 1% accuracy | 47–63 Hz, 1% accuracy | |
| Motor Protection | | | | | | |
| Thermal overload setting | 1.05 x FLA: Does not trip 1.15 x FLA: Overload trip | 1.05 x FLA: Does not trip 1.15 x FLA: Overload trip | 1.05 x FLA: Does not trip 1.15 x FLA: Overload trip | 1.05 x FLA: Does not trip 1.15 x FLA: Overload trip | 1.05 x FLA: Does not trip 1.15 x FLA: Overload trip | |
| Feature | Range | | | | Fault Delay Setting | |
| Jam | 150–400% of motor FLA, OFF | 150–400% of motor FLA, OFF | 150–400% of motor FLA, OFF | 50–400% of motor FLA, OFF | 1–20 seconds | |
| Current imbalance | 1–30%, OFF | 1–30%, OFF | 1–30%, OFF | 1–30%, OFF | 1–20 seconds | |
| Current phase loss | Fixed threshold 60% | Fixed threshold 60% | Fixed threshold 60% | Fixed threshold 60% | 1–20 seconds | |
| Ground fault current | | | | | | |
| C441_A and C4410109NOUI 1–9A | 0.3–2.0A with one pass through the CTs ^① | 0.3–2.0A with one pass through the CTs ^① | 0.3–2.0A with one pass through the CTs ^① | 0.3–2.0A with one pass through the CTs ^① | <150%, 1–60 seconds >150%, 2 seconds >250%, 1 second | |
| C441_B and C4410590NOUI 5–90A | 3.0–20A with one pass through the CTs ^① | 3.0–20A with one pass through the CTs ^① | 3.0–20A with one pass through the CTs ^① | 3.0–20A with one pass through the CTs ^① | <150%, 1–60 seconds >150%, 2 seconds >250%, 1 second | |
| Phase reversal | OFF = Ignore, 1 = ACB, 2 = ABC | OFF = Ignore, 1 = ACB, 2 = ABC | OFF = Ignore, 1 = ACB, 2 = ABC | OFF = Ignore, 1 = ACB, 2 = ABC | | |
| Fault reset delay | 2–500 minutes, auto ^② | 2–500 minutes, auto ^② | 2–500 minutes, auto ^② | 2–500 minutes, auto ^② | | |
| Fault reset attempts | 0–4 restarts allowed or automatic reset ^② | 0–4 restarts allowed or automatic reset ^② | 0–4 restarts allowed or automatic reset ^② | 0–4 restarts allowed or automatic reset ^② | | |

Notes

^① Lower levels are achievable with multiple passes.

^② Motor fault reset characteristics can be programmed as a group or for motor overloads only. Reference the user manual for more detailed information.

Motor Insight, continued

| Description | Specification C441B_ | C441C_ | C441D_ | C441_ _ _ _NOUI | |
|---|--|--|--|--|--|
| Load Protection | | | | | |
| Feature | Range | | | | Fault Delay Setting |
| Under current | 50–90% of motor FLA | 50–90% of motor FLA | 50–90% of motor FLA | 50–90% of motor FLA | 1–60 seconds |
| Low power (kW) | 20–80% of rated kW | 20–80% of rated kW | 20–80% of rated kW | 20–80% of rated kW | 1–60 seconds |
| High power (kW) | 50–110% of rated kW | 50–110% of rated kW | 50–110% of rated kW | 50–110% of rated kW | 1–60 seconds |
| Load reset delay | 2–500 minutes, auto | 2–500 minutes, auto | 2–500 minutes, auto | 2–500 minutes, auto | |
| Load reset attempts | 0–4, auto | 0–4, auto | 0–4, auto | 0–4, auto | |
| Supply Protection | | | | | |
| Feature | Range | | | | Fault Delay Setting |
| Over voltage | 170–264 Vac | 323–528 Vac | 489–660 Vac | 0–660 Vac | 1–20 seconds |
| Under voltage | 170–264 Vac | 323–528 Vac | 489–660 Vac | 0–660 Vac | 1–20 seconds |
| Voltage imbalance | 1–20% imbalance | 1–20% imbalance | 1–20% imbalance | 1–20% imbalance | 1–20% imbalance |
| Restart delay setting | 1–500 seconds | 1–500 seconds | 1–500 seconds | 1–500 seconds | 1–500 seconds |
| Electrical/EMC | | | | | |
| Radiated emissions IEC 60947-4-1—Table 15, EN 55011 (CISPR 11) Group 1, Class A | 30–1000 mHz | 30–1000 mHz | 30–1000 mHz | 30–1000 mHz | 30–1000 mHz |
| Conducted emissions IEC 60947-4-1—Table 14, EN 55011 (CISPR 11) Group 1, Class A | 0.15–30 mHz | 0.15–30 mHz | 0.15–30 mHz | 0.15–30 mHz | 0.15–30 mHz |
| ESD immunity IEC 60947-4-1 (Table 13) | ±8 kV air, ±4 kV contact | ±8 kV air, ±4 kV contact | ±8 kV air, ±4 kV contact | ±8 kV air, ±4 kV contact | ±8 kV air, ±4 kV contact |
| Radiated immunity IEC 60947-4-1 | 10 V/m 80–1000 mHz 80% amplitude modulated 1 kHz sine wave | 10 V/m 80–1000 mHz 80% amplitude modulated 1 kHz sine wave | 10 V/m 80–1000 mHz 80% amplitude modulated 1 kHz sine wave | 10 V/m 80–1000 mHz 80% amplitude modulated 1 kHz sine wave | 10 V/m 80–1000 mHz 80% amplitude modulated 1 kHz sine wave |
| Conducted immunity IEC 60947-4-1 | 140 dBuV (10V rms) 150 kHz–80 mHz | 140 dBuV (10V rms) 150 kHz–80 mHz | 140 dBuV (10V rms) 150 kHz–80 mHz | 140 dBuV (10V rms) 150 kHz–80 mHz | 140 dBuV (10V rms) 150 kHz–80 mHz |
| Fast transient immunity IEC 60947-4-1 (Table 13) IEC 61000-4-4 | ±2 kV using direct method | ±2 kV using direct method | ±2 kV using direct method | ±2 kV using direct method | ±2 kV using direct method |
| Surge immunity IEC 60947-4-1 (Table 13) IEC 61000-4-4 | Three-phase power inputs: ±2 kV line-to-line (DM) ±4 kV line-to-ground (CM) IEC 61000-4-5 Class 3 User IO and communication lines: ±1 kV line-to-line (DM) ±2 kV line-to-ground (CM) | Three-phase power inputs: ±2 kV line-to-line (DM) ±4 kV line-to-ground (CM) IEC 61000-4-5 Class 3 User IO and communication lines: ±1 kV line-to-line (DM) ±2 kV line-to-ground (CM) | Three-phase power inputs: ±2 kV line-to-line (DM) ±4 kV line-to-ground (CM) IEC 61000-4-5 Class 3 User IO and communication lines: ±1 kV line-to-line (DM) ±2 kV line-to-ground (CM) | Three-phase power inputs: ±2 kV line-to-line (DM) ±4 kV line-to-ground (CM) IEC 61000-4-5 Class 3 User IO and communication lines: ±1 kV line-to-line (DM) ±2 kV line-to-ground (CM) | Three-phase power inputs: ±2 kV line-to-line (DM) ±4 kV line-to-ground (CM) IEC 61000-4-5 Class 3 User IO and communication lines: ±1 kV line-to-line (DM) ±2 kV line-to-ground (CM) |
| Voltage variations immunity IEC 60947-4-1 | 30% dip, at 100 ms 60% dip at 10 ms >95% interrupt at 5 ms | 30% dip, at 100 ms 60% dip at 10 ms >95% interrupt at 5 ms | 30% dip, at 100 ms 60% dip at 10 ms >95% interrupt at 5 ms | 30% dip, at 100 ms 60% dip at 10 ms >95% interrupt at 5 ms | 30% dip, at 100 ms 60% dip at 10 ms >95% interrupt at 5 ms |
| Electromagnetic field IEC 60947-4-1 (Table 13) IEC 61000-4-3 | 10 V/m | 10 V/m | 10 V/m | 10 V/m | 10 V/m |
| Ground fault | UL 508, UL 1053 Sections 21 and 27 | UL 508, UL 1053 Sections 21 and 27 | UL 508, UL 1053 Sections 21 and 27 | UL 508, UL 1053 Sections 21 and 27 | UL 508, UL 1053 Sections 21 and 27 |

1.2

C441 overload and monitoring relay

Technical data and specifications

1 Motor Insight, continued

| Description | Specification C441B_ | C441C_ | C441D_ | C441_ _ _ _NOUI |
|--|--|--|--|---|
| Environmental Ratings | | | | |
| Feature | Range | | | |
| Ambient temperature (operating) | −4° to 122°F (−20° to 50°C) | −4° to 122°F (−20° to 50°C) | −4° to 122°F (−20° to 50°C) | −4° to 122°F (−20° to 50°C) |
| Ambient temperature (storage) | −40° to 85°C | −40° to 85°C | −40° to 85°C | −40° to 85°C |
| Operating humidity | 5% to 95% noncondensing | 5% to 95% noncondensing | 5% to 95% noncondensing | 5% to 95% noncondensing |
| Altitude (no derating) | 2000m | 2000m | 2000m | 2000m |
| Shock (IEC 60068-2-27) | 15G any direction | 15G any direction | 15G any direction | 15G any direction |
| Vibration (IEC 60068-2-6) | 3G any direction | 3G any direction | 3G any direction | 3G any direction |
| Pollution degree per IEC 60947-1 | 3 | 3 | 3 | 3 |
| Ingress protection | IP20 | IP20 | IP20 | IP20 |
| Capacity | | | | |
| Input, auxiliary contact and external reset terminals | | | | |
| Terminal capacity | 18–12 AWG | 18–12 AWG | 18–12 AWG | 18–12 AWG |
| Tightening torque | 5.3 lb-in (0.6 Nm) | 5.3 lb-in (0.6 Nm) | 5.3 lb-in (0.6 Nm) | 5.3 lb-in (0.6 Nm) |
| Voltages | | | | |
| Monitoring voltage | 170–264 Vac 50/60Hz | 323–528 Vac 50/60Hz | 489–660 Vac 60Hz | 0–660 Vac 50/60Hz |
| Insulation voltage U _i (three-phase voltage) | 600 Vac | 600 Vac | 600 Vac | 600 Vac |
| Insulation voltage U _i (control) | 240 Vac | 240 Vac | 240 Vac | 240 Vac |
| Impulse withstand U _{imp} (main/control) | 6 kV | 6 kV | 6 kV | 6 kV |
| Expected Life | | | | |
| Mechanical/electrical | 10 years | 10 years | 10 years | 10 years |
| Output Contact Ratings | | | | |
| Two output relays One Form C SPDT (fault relay) One Form A SPST (ground fault relay) | B300 pilot duty 5A thermal continuous current 30A make 3.00A break at 120 Vac and 15A make 1.50A break at 240 Vac | B300 pilot duty 5A thermal continuous current 30A make 3.00A break at 120 Vac and 15A make 1.50A break at 240 Vac | B300 pilot duty 5A thermal continuous current 30A make 3.00A break at 120 Vac and 15A make 1.50A break at 240 Vac | B300 pilot duty 5A thermal continuous current 30A make 3.00A break at 120 Vac and 30A make 1.50A break at 240 Vac ^① |
| C441_ _ _ _NOUI models: One Form A SPST One Form B SPST | | | | |
| External remote reset terminal | Isolated 120 Vac digital input IEC 61131-2 Section 5 Type 1 | Isolated 120 Vac digital input IEC 61131-2 Section 5 Type 1 | Isolated 120 Vac digital input IEC 61131-2 Section 5 Type 1 | Isolated 120 Vac digital input IEC 61131-2 Section 5 Type 1 |
| Indications | | | | |
| Trip | Fault | Fault | Fault | Fault |
| Reset | Ready | Ready | Ready | Ready |
| Autoreset | Trip faulted/Ready flashing | Trip faulted/Ready flashing | Trip faulted/Ready flashing | Trip faulted/Ready flashing |
| Power Consumption | | | | |
| Maximum | 5W | 5W | 5W | 5W |
| Options | | | | |
| Remote display | Type 1, 12 and Type 3R kit | Type 1, 12 and Type 3R kit | Type 1, 12 and Type 3R kit | Type 1, 12 and Type 3R kit |
| Communications modules | Modbus, DeviceNet and PROFIBUS with I/O | Modbus, DeviceNet and PROFIBUS with I/O | Modbus, DeviceNet and PROFIBUS with I/O | Modbus, DeviceNet and PROFIBUS with I/O |

Note

① In this model, there are two isolated relays: one Form A and one Form B SPST. One is the fault relay, and one is a programmable auxiliary relay.

Motor Insight Short Circuit Ratings (North America CSA and UL)

1

| Overload FLA Range | Maximum Operating Voltage | Standard-Fault Short Circuit Data | | | Maximum Thermal-Magnetic Circuit Breaker | Maximum Withstand Rating | Maximum Fuse (RK5) | Eaton Thermal-Magnetic Circuit Breaker | Catalog Number |
|-----------------------|---------------------------------|-----------------------------------|-----------------------|--|--|--------------------------------|-----------------------|--|-------------------|
| | | Withstand Rating | Maximum Fuse (RK5) | Maximum Thermal-Magnetic Circuit Breaker | | | | | |
| 1-9A | 264 Vac | 5000A at 240 Vac | 35A | 35A | 100 kA at 240 Vac | 35A | — | C441BA | |
| | | | | | 100 kA at 240 Vac | — | FDC3035L | | |
| 1-9A | 528 Vac | 5000A at 480 Vac | 35A | 35A | 100 kA at 480 Vac | 35A | — | C441CA | |
| | | | | | 100 kA at 480 Vac | — | FDC3035L | | |
| 1-9A | 660 Vac | 5000A at 600 Vac | 35A | 35A | 100 kA at 600 Vac | 35A | — | C441DA | |
| | | | | | 35 kA at 600 Vac | — | FDC3035L | | |
| 1-9A | 660 Vac | 5000A at 600 Vac | 35A | 35A | 100 kA at 240 Vac | 35A | — | C4410109NOUI | |
| | | | | | 100 kA at 240 Vac | — | FDC3035L | | |
| | | | | | 100 kA at 480 Vac | 35A | — | | |
| | | | | | 100 kA at 480 Vac | — | FDC3035L | | |
| | | | | | 100 kA at 600 Vac | 35A | — | | |
| 35 kA at 600 Vac | — | FDC3035L | | | | | | | |
| 5-90A | 264 Vac | 10,000A at 240 Vac | 350A | 350A | 100 kA at 240 Vac | 350A | — | C441BB | |
| | | | | | 100 kA at 240 Vac | — | KDC3350 | | |
| 5-90A | 528 Vac | 10,000A at 480 Vac | 350A | 350A | 100 kA at 480 Vac | 350A | — | C441CB | |
| | | | | | 100 kA at 480 Vac | — | KDC3350 | | |
| 5-90A | 660 Vac | 10,000A at 600 Vac | 350A | 350A | 100 kA at 600 Vac | 350A | — | C441DB | |
| | | | | | 65 kA at 600 Vac | — | KDC3350 | | |
| 5-90A | 660 Vac | 10,000A at 600 Vac | 350A | 350A | 100 kA at 240 Vac | 350A | — | C4410590NOUI | |
| | | | | | 100 kA at 240 Vac | — | KDC3350 | | |
| | | | | | 100 kA at 480 Vac | 350A | — | | |
| | | | | | 100 kA at 480 Vac | — | KDC3350 | | |
| | | | | | 100 kA at 600 Vac | 350A | — | | |
| 35 kA at 600 Vac | — | KDC3350 | | | | | | | |

1.2 C441 overload and monitoring relay

Technical data and specifications

1 Line Powered Models

Terminal Connection Diagram

Use 75C CU wire only

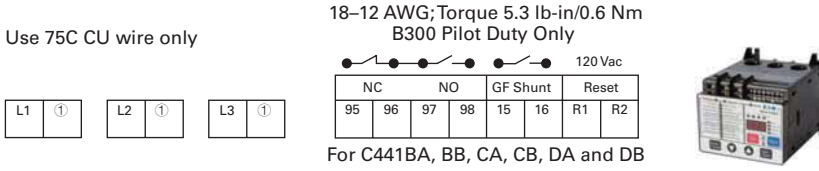

Terminal Connection Specifications

| Name | Designation | Input | Description |
|--------------|----------------------------------|--------------|--|
| Line voltage | L1, L2, L3 | Line voltage | Three-phase line voltage input L1, L2, L3 connections must correspond to the respective CT1, CT2, CT3 current leads |
| Fault relay | 95/96 96/97 (common) 97/98 | B300 UL 508 | Form C contact: 95/96 Contact opens when the unit is faulted or unpowered 97/98 Contact closes when the unit is faulted or unpowered |
| GF shunt | 15 16 | B300 UL 508 | Form A contact: Contact closes when a ground fault is active |
| Reset input | R1, R2 | 120 Vac | Fault reset input IEC 61131-2 Type 1 |

Control Powered Models

Terminal Connection Diagram

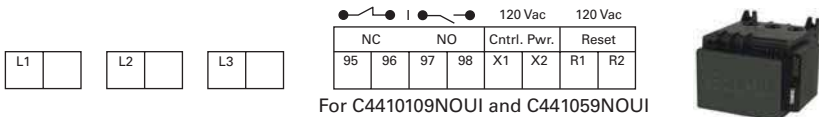

Terminal Connection Specifications

| Name | Designation | Input | Description |
|---------------|--|-----------------------------------|---|
| Line voltage | L1, L2, L3 | Line voltage | Three-phase line voltage input L1, L2, L3 connections must correspond to the respective CT1, CT2, CT3 current leads Terminal provided for wiring control power transformer (9A maximum capacity) |
| Control power | X1, X2 | 110–120 Vac 50–60Hz (+10/–15%) | Control power option for C441____NOUI |
| Fault relay | 95/96 For C441____NOUI, the fault relay and auxiliary relay are isolated and do not share a common. By default they will behave like a Form C, but they can be programmed to act independently from one another. 96/97 (isolated) 97/98 | B300 UL 508 | Form C contact: 95/96 Contact opens when the unit is faulted or unpowered 97/98 Contact closes when the unit is faulted or unpowered Can be programmed to act independently of the 95/96 only in the C441____NOUI models |
| GF shunt | 97/98 | B300 UL 508 | Form A contact: Contact closes when a ground fault is active Separate GF control can still be achieved by programming auxiliary relay 97/98 to act independently of the 95/96 relay |
| Reset input | R1, R2 | 120 Vac | Fault reset input IEC 61131-2 Type 1 |

Note

① No motor loads, 9A maximum.

Modbus Communication Modules

| Description | Specification | |
|---|--|-----------------|
| Electrical/EMC | | |
| Radiated emissions IEC 60947-4-1—Table 15, EN 55011 (CISPR 11) Group 1, Class A | 30–1000 mHz | |
| Conducted emissions IEC 60947-4-1—Table 14, EN 55011 (CISPR 11) Group 1, Class A | 0.15–30 mHz | |
| ESD immunity IEC 60947-4-1 (Table 13) IEC 61000-4-2 | ±8 kV air, ±4 kV contact | |
| Radiated immunity IEC 60947-4-1 | 10 V/m 80–1000 mHz 80% amplitude modulated 1 kHz sine wave | |
| Conducted immunity IEC 60947-4-1 | 140 dBuV (10V rms) 150 kHz–80 mHz | |
| Fast transient immunity IEC 60947-4-1 (Table 13) IEC 61000-4-4 | ±2 kV using direct method | |
| Surge immunity IEC 60947-4-1 (Table 13) IEC 61000-4-5 Class 3 | User IO and communication lines ^① : ±1 kV line-to-line (DM) ±2 kV line-to-ground (CM) | |
| Electromagnetic field ¹ IEC 60947-4-1 (Table 13) IEC 61000-4-3 | 10 V/m | |
| Environmental Ratings | | |
| Ambient temperature (operating) | –20° to 50°C | |
| Ambient temperature (storage) | –40° to 85°C | |
| Operating humidity | 5 to 95% noncondensing | |
| Altitude (no derating) | 2000m | |
| Shock (IEC 60068-2-27) | 15G any direction | |
| Vibration (IEC 60068-2-6) | 3G any direction | |
| Pollution degree per IEC 60947-1 | 3 | |
| Degree of protection | IP20 | |
| Over voltage category per UL 508 | III | |
| C441P 24 Vdc Input | | |
| Nominal input voltage | 24 Vdc | |
| Operating voltage | 18–30 Vdc | |
| Number of inputs | 4 | |
| Signal delay | 5 ms (programmable to 65 sec) | |
| OFF-state voltage | < 6 Vdc | |
| ON-state voltage | > 18 Vdc | |
| Nominal input current | 5 mA | |
| Isolation | 1500V | |
| Terminal screw torque | 7–9 in-lb | |
| 24 Vdc source current | 50 mA | |
| Operating Voltage Range—DC Input Modules | | |
| OFF State | Transition Region | ON State |
| 0–6 Vdc | 6–18 Vdc | 18–30 Vdc |
| C441N 120 Vac Input | | |
| Nominal input voltage | 120 Vac | |
| Operating voltage | 80–140 Vac | |
| Number of inputs | 4 | |
| OFF-state voltage | < 30 Vac | |
| ON-state voltage | > 80 Vac | |
| Nominal input current | 15 mA | |
| Signal delay | 1/2 cycle | |
| Isolation | 1500V | |
| Terminal screw torque | 7–9 in-lb | |

Note

^① Relates to C441M only.

1.2

C441 overload and monitoring relay

Technical data and specifications

1

Modbus Communication Modules, continued

| Description | Specification |
|--|---|
| Operating Voltage Range— AC Input Modules | |
| OFF State | Transition Region ON State |
| 0–30 Vac | 30–80 Vac 80–140 Vac |
| Output Modules | |
| Nominal voltage | 120 Vac 24 Vdc |
| Number of outputs | (2) 1NO Form A 1NO/NC Form C |
| Relay OFF time | 3 ms |
| Relay ON time | 7 ms |
| Max. current per point ^① | 5A (B300 rated) |
| Electrical life | 100,000 cycles |
| Mechanical life | 1,000,000 cycles |

DeviceNet Communication Modules

| Description | Specification |
|---|---|
| Electrical/EMC | |
| Radiated emissions IEC 60947-4-1—Table 15, EN 55011 (CISPIR 11) Group 1, Class A | 30–1000 mHz |
| Conducted emissions IEC 60947-4-1—Table 14, EN 55011 (CISPIR 11) Group 1, Class A | 0.15–30 mHz |
| ESD immunity IEC 60947-4-1 (Table 13) IEC 61000-4-2 | ±8 kV air, ±4 kV contact |
| Radiated immunity IEC 60947-4-1 | 10 V/m 80–1000 mHz 80% amplitude modulated 1 kHz sine wave |
| Conducted immunity IEC 60947-4-1 | 140 dBuV (10V rms) 150 kHz–80 mHz |
| Fast transient immunity IEC 60947-4-1 (Table 13) IEC 61000-4-4 | ±2 kV using direct method |
| Surge immunity IEC 60947-4-1 (Table 13) IEC 61000-4-5 Class 2 | User I/O and communication lines: ±1 kV line-to-line (DM) ±2 kV line-to-ground (CM) |
| Electromagnetic field IEC 60947-4-1 Table 13, IEC 61000-4-3 | 10 V/m |
| Environmental Ratings | |
| Ambient temperature (operating) | –20° to 50°C |
| Ambient temperature (storage) | –40° to 85°C |
| Operating humidity | 5–95% noncondensing |
| Altitude (no derating) | 2000m |
| Shock (IEC 60068-2-27) | 15G any direction |
| Vibration (IEC 60068-2-6) | 3G any direction |
| Pollution degree per IEC 60947-1 | 3 |
| Degree of protection | IP20 |
| DeviceNet | |
| DeviceNet connections | Group 2, polling, bit strobe, explicit, no UCMM |
| DeviceNet baud rate | 125K, 250K, 500K |

Note

^① Resistive current at 55°C ambient.

DeviceNet Communication Modules, continued

| Description | Specification | |
|---|---------------------------------|-----------------|
| C441L 24 Vdc Input | | |
| Nominal input voltage | 24 Vdc | |
| Operating voltage | 18–30 Vdc | |
| Number of inputs | 4 | |
| Signal delay | 5 ms (programmable to 65 sec) | |
| OFF-state voltage | < 6 Vdc | |
| ON-state voltage | > 18 Vdc | |
| Nominal input current | 5 mA | |
| Isolation | 250V | |
| Terminal screw torque | 7–9 in-lb | |
| 24V source current | 50 mA | |
| Operating Voltage Range—DC Input Modules | | |
| OFF State | Transition Region | ON State |
| 0–6 Vdc | 6–18 Vdc | 18–30 Vdc |
| C441K 120 Vac Input | | |
| Nominal input voltage | 120 Vac | |
| Operating voltage | 80–140 Vac | |
| Number of inputs | 4 | |
| OFF-state voltage | < 30 Vac | |
| ON-state voltage | > 80 Vac | |
| Nominal input current | 15 mA | |
| Signal delay | 1/2 cycle | |
| Isolation | 250V | |
| Terminal screw torque | 7–9 in-lb | |
| Operating Voltage Range—AC Input Modules | | |
| OFF State | Transition Region | ON State |
| 0–30 Vac | 30–80 Vac | 80–140 Vac |
| Output Modules | | |
| Nominal voltage | 120 Vac 24 Vdc | |
| Number of outputs | (2) 1NO Form A 1NO/NC Form C | |
| Relay OFF time | 3 ms | |
| Relay ON time | 7 ms | |
| Max. current per point ^① | 5A (B300 rated) | |
| Electrical life | 100,000 cycles | |
| Mechanical life | 1,000,000 cycles | |

Note

^① Resistive current at 55°C ambient.

1.2

C441 overload and monitoring relay

Technical data and specifications

1

PROFIBUS Communication Modules

| Description | Specification |
|---|---|
| Electrical/EMC | |
| Radiated emissions IEC 60947-4-1—Table 15, EN 55011 (CISPIR 11) Group 1, Class A | 30–1000 mHz |
| Conducted emissions IEC 60947-4-1—Table 14, EN 55011 (CISPIR 11) Group 1, Class A | 0.15–30 mHz |
| ESD immunity IEC 60947-4-1 (Table 13) IEC 61000-4-2 | ±8 kV air, ±4 kV contact |
| Radiated immunity IEC 60947-4-1 Table 13, IEC 61000-4-3 | 10 V/m 80–1000 mHz 80% amplitude modulated 1 kHz sine wave |
| Conducted immunity IEC 60947-4-1 | 140 dBuV (10V rms) 150 kHz–80 mHz |
| Fast transient immunity IEC 60947-4-1 (Table 13) IEC 61000-4-4 | ±2 kV using direct method |
| Surge immunity IEC 60947-4-1 (Table 13) IEC 61000-4-5 Class 2 | User I/O and communication lines: ±1 kV line-to-line (DM) ±2 kV line-to-ground (CM) |
| Environmental Ratings | |
| Ambient temperature (operating) | –20° to 50°C |
| Ambient temperature (storage) | –40° to 85°C |
| Operating humidity | 5–95% noncondensing |
| Altitude (no derating) | 2000m |
| Shock (IEC 60068-2-27) | 15G any direction |
| Vibration (IEC 60068-2-6) | 3G any direction |
| Pollution degree per IEC 60947-1 | 3 |
| Degree of protection | IP20 |
| PROFIBUS | |
| PROFIBUS connections | Group 2, polling, bit strobe, explicit, no UCMM |
| PROFIBUS baud rate | 9.6K, 19.2K, 45.45K, 93.75K, 187.5K, 500K, 1.5M, 3M, 6M, 12M |
| C441Q 24 Vdc Input | |
| Nominal input voltage | 24 Vdc |
| Operating voltage | 18–30 Vdc |
| Number of inputs | 4 |
| Signal delay | 5 ms (programmable to 65 sec) |
| OFF-state voltage | <6 Vdc |
| ON-state voltage | >10 Vdc |
| Nominal input current | 5 mA |
| Isolation | 1500V |
| Terminal screw torque | 7–9 in-lb |
| 24V source current | 50 mA |

PROFIBUS Communication Modules, continued

| Description | Specification |
|---|---|
| Operating Voltage Range—DC Input Modules | |
| OFF State | Transition Region ON State |
| 0–6 Vdc | 6–18 Vdc 18–30 Vdc |
| C441S 120 Vac Input | |
| Nominal input voltage | 120 Vac |
| Operating voltage | 80–140 Vac |
| Number of inputs | 4 |
| OFF-state voltage | < 20 Vac |
| ON-state voltage | > 70 Vac |
| Nominal input current | 15 mA |
| Signal delay | 1/2 cycle |
| Isolation | 1500V |
| Terminal screw torque | 7–9 in-lb |
| Operating Voltage Range—AC Input Modules | |
| OFF State | Transition Region ON State |
| 0–30 Vac | 30–80 Vac 80–140 Vac |
| Output Modules | |
| Nominal voltage | 120 Vac 24 Vdc |
| Number of outputs | (2) 1NO Form A 1NO/NC Form C |
| Relay OFF time | 3 ms |
| Relay ON time | 7 ms |
| Max. current per point ^① | 5A (B300 rated) |
| Electrical life | 100,000 cycles |
| Mechanical life | 1,000,000 cycles |

Note

^① Resistive current at 55°C ambient.

1.2

C441 overload and monitoring relay

Technical data and specifications

1 Ethernet (Modbus TCP / EtherNet/IP) Communication Modules

| Description | Specification |
|---|--|
| Electrical/EMC | |
| Radiated emissions IEC 60947-4-1, Table 15, EN 55011 (CISPR 11) Group 1, Class A | 30–1000 mHz |
| Conducted emissions IEC 60947-4-1, Table 15, EN 55011 (CISPR 11) Group 1, Class A | 0.15–30 mHz |
| ESD immunity IEC 60947-4-1 (Table 13) IEC 61000-4-2 | ±8 kV air, ±4 kV contact |
| Radiated immunity IEC 60947-4-1 (Table 13) IEC 61000-4-3 | 10 V/m 80–1000 mHz 80% amplitude modulated 1 kHz sine wave |
| Conducted immunity IEC 60947-4-1 | 140 dBuV (10V rms) 150 kHz to 80 mHz |
| Fast transient immunity IEC 60947-4-1 (Table 13) IEC 61000-4-4 | ±2 kV using direct method |
| Surge immunity IEC 60947-4-1 (Table 13) IEC 61000-4-5 Class 2 | User IO and communication lines: ±1 kV line-to-line (DM) ±2 kV line-to-ground (CM) |
| Environmental Ratings | |
| Ambient temperature (operating) | –20° to 50°C |
| Ambient temperature (storage) | –40° to 85°C |
| Operating humidity | 5–95% noncondensing |
| Altitude (no derating) | 2000m |
| Shock (IEC 60068-2-27) | 15G any direction |
| Vibration (IEC 60068-2-6) | 3G any direction |
| Pollution degree per IEC 60947-1 | 3 |
| Degree of protection | IP20 |
| Ethernet | |
| Ethernet connections | Integrated two-port switch with dual RJ45 Ethernet connections |
| Ethernet type | Ethernet 10/100 Mbps, AutoMDX, Auto Negotiation |
| C441T 24 Vdc Input | |
| Nominal input voltage | 24 Vdc |
| Operating voltage | 18–30 Vdc |
| Number of inputs | 4 |
| Signal delay | 5 ms (programmable to 65 sec) |
| OFF-state voltage | <6 Vdc |
| ON-state voltage | >18 Vdc |
| Nominal input current | 5 mA |
| Isolation | 1500V |
| Terminal screw torque | 7–9 in-lb |
| 24V source current | 50 mA |

Ethernet (Modbus TCP / EtherNet/IP) Communication Modules, continued

| Description | Specification | |
|---|---------------------------------|-----------------|
| Operating Voltage Range—DC Input Modules | | |
| OFF State | Transition Region | ON State |
| 0–6 Vdc | 6–18 Vdc | 18–30 Vdc |
| C441R 120 Vac Input | | |
| Nominal input voltage | 120 Vac | |
| Operating voltage | 80–140 Vac | |
| Number of inputs | 4 | |
| OFF-state voltage | < 30 Vac | |
| ON-state voltage | > 80 Vac | |
| Nominal input current | 15 mA | |
| Signal delay | 1/2 cycle | |
| Isolation | 1500V | |
| Terminal screw torque | 7–9 in-lb | |
| Operating Voltage Range—AC Input Modules | | |
| OFF State | Transition Region | ON State |
| 0–30 Vac | 30–80 Vac | 80–140 Vac |
| Nominal voltage | 120 Vac 24 Vdc | |
| Number of outputs | (2) 1NO Form A 1NO/NC Form C | |
| Relay OFF time | 3 ms | |
| Relay ON time | 7 ms | |
| Maximum current per point ^① | 5A (B300 rated) | |
| Electrical life | 100,000 cycles | |
| Mechanical life | 1,000,000 cycles | |

Note

^① Resistive current at 55°C ambient.

1.2 C441 overload and monitoring relay

Dimensions

1 Dimensions

Approximate Dimensions in mm

Motor Insight Overload Relay

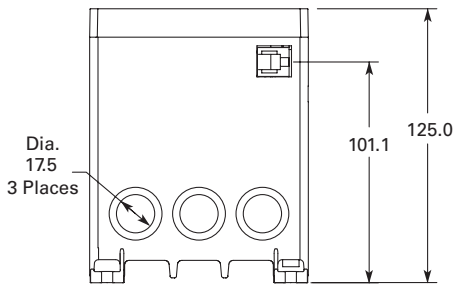
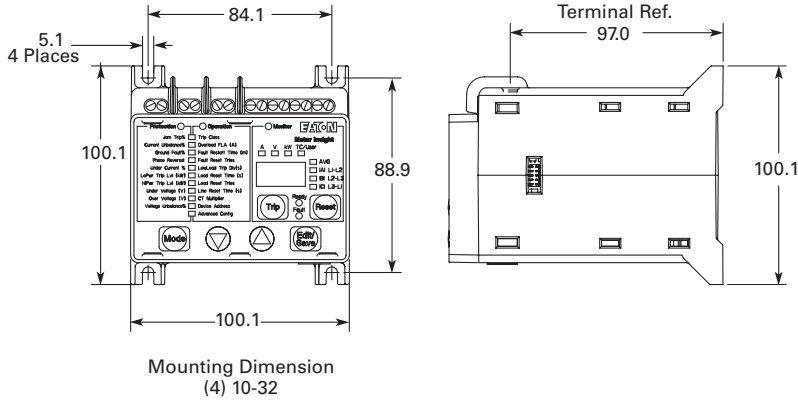

Motor Insight with Mounted DeviceNet, PROFIBUS or Modbus with I/O Communication Module

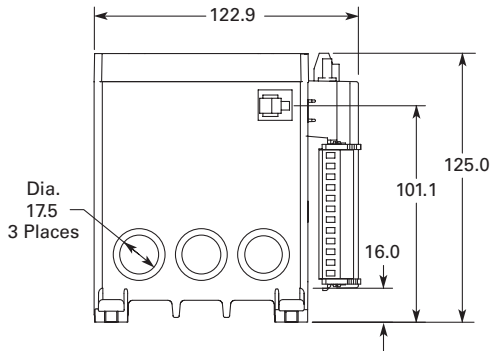
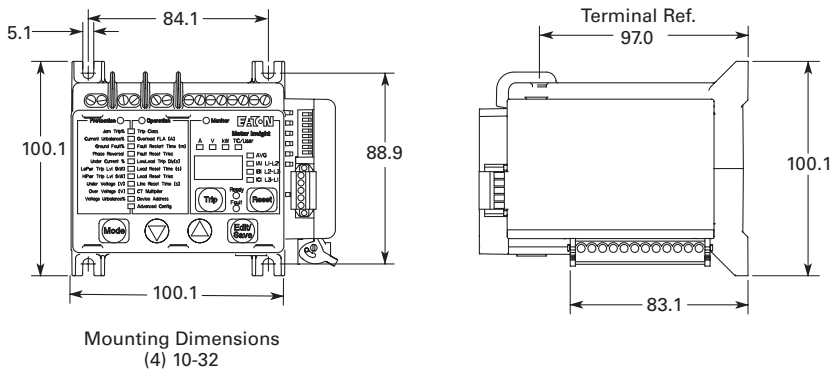

Approximate Dimensions in mm

Motor Insight with Mounted Modbus Communication Module

1

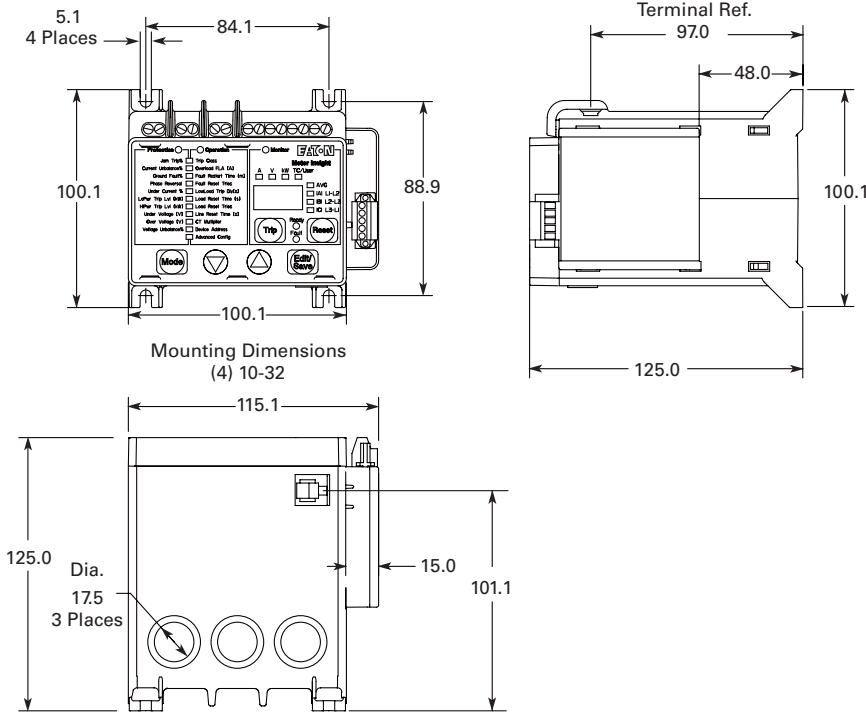

Motor Insight Remote Display

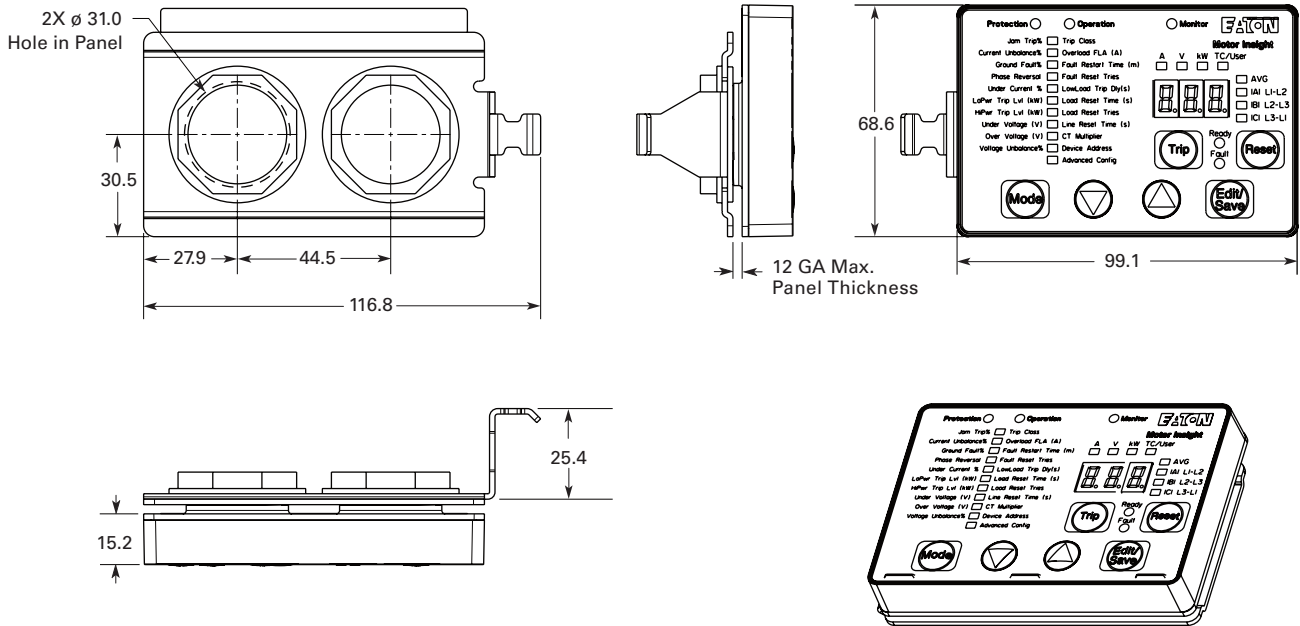

1.2 C441 overload and monitoring relay

Dimensions

1 Approximate Dimensions in mm

Motor Insight Cover Assembly

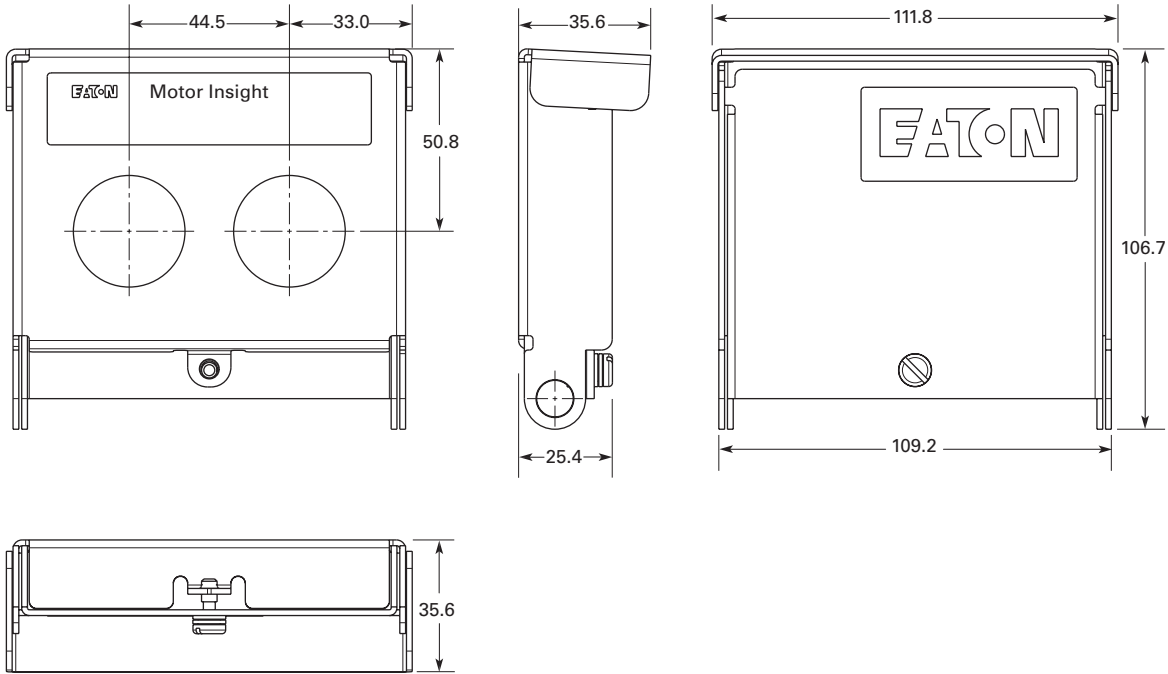

Motor Insight Conversion Plate

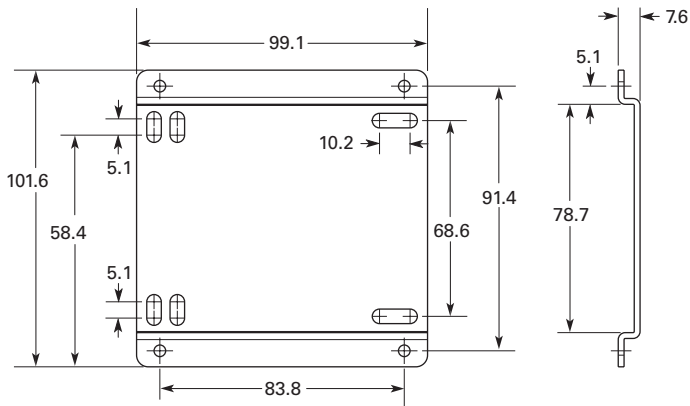



PKZ and PKE motor-protective circuit-breakers

Machinery and installation downtimes should be kept as short as possible. The PKZ fuseless motor-protective circuit-breakers combine short-circuit and overload protection in one device, allowing fast restart readiness. PKZM01, PKZM0, PKZM4 and PKE have the same accessories. Combines easily with DILM contactors and DS7 soft starters. Connecting PKE to SmartWire-DT® facilitates high data transparency.



PKZM01 (up to 16 A) motor-protective circuit-breaker with pushbuttons

- Motor-protective circuit-breaker in housing for protection types IP40 and IP65.
- Integrated EMERGENCY STOP and EMERGENCY OFF pushbuttons reduce wiring.

PKZM0 (up to 32 A) and PKZM4 (up to 65 A) motor-protective circuit-breakers with rotary handle

- Short-circuit proof up to at least 50 kA for easy engineering
- Trip-indicating auxiliary contact enables remote diagnosis
- High safety through application as main switch or repair and maintenance switch
- ATEX approval for protection of EEx e motors up to 65 A



PKE (up to 65 A) motor-protective circuit-breakers with electronic wide-range overload protection

- High flexibility through plug-in trip block
- Wide current setting ranges enable only five trip blocks up to 65 A
- Precise and extremely long-term stable characteristic curves
- Individual supply through integrated current converter
- ATEX approval for protection of EEx e motors up to 65 A
- Adjustable tripping classes

DC string circuit-breakers PKZ-SOL and DC switch-disconnectors P-SOL (up to 63 A) for installations

- High string circuit-breaker flexibility due to wide current setting range
- Enclosed switch-disconnector for external mounting (IP65)
- Remote shutdown through optional secondary voltage and shunt trip
- Voltage up to 1000 V DC
- TÜV certified

**Motor-protective circuit-breaker
PKZM01, PKZM0, PKZM4, PKE**



**DC string circuit-breaker PKZ-SOL,
DC switch-disconnectors P-SOL, SOL**



System overview

PKZM01, PKZM0, PKZM4, PKE motor-protective circuit-breakers 2

Ordering

Motor-protective circuit-breakers 3
 Motor-protective circuit-breakers for starter combinations 6
 Transformer-protective circuit-breakers 6
 PKE electronic motor-protective circuit-breaker 8
 Standard auxiliary contacts 10
 Auxiliary contacts, shunt releases, undervoltage release 12

Engineering

Accessories for motor-protective circuit-breakers in enclosures 14

Ordering

Insulated enclosures 16
 Accessories 20
 Busbar adapters 22
 Wiring sets 25
 Motor feeder plugs, three-phase commoning links 26
 Actuating voltages 29

Engineering

Motor-protective circuit-breakers 30
 Characteristic curves 30
 Switching capacity 32

Technical data

Motor-protective circuit-breakers 36
 Auxiliary contacts 38

Dimensions

PKZM01, PKZM0 motor-protective circuit-breaker 39
 Accessories 40
 PKZM4 motor-protective circuit-breaker 45
 Accessories 46

Description

DC switches P-SOL, PKZ-SOL, SOL 47

Ordering

DC switch-disconnector SOL, ready-to-install 48
 DC switch-disconnector P-SOL, open 49
 DC string circuit-breaker PKZ-SOL 49

Engineering

Circuit P-SOL, PKZ-SOL Interior circuit SOL 50
 Characteristic curves 51

Technical data

DC switch-disconnectors P-SOL, SOL 52
 DC string circuit-breaker PKZ-SOL 53

Dimensions

DC switches P-SOL, PKZ-SOL, SOL 54

1.3

Motor-protective circuit-breakers PKZM01, PKZM0, PKZM4, PKE

Motor-protective circuit-breaker

1 System overview

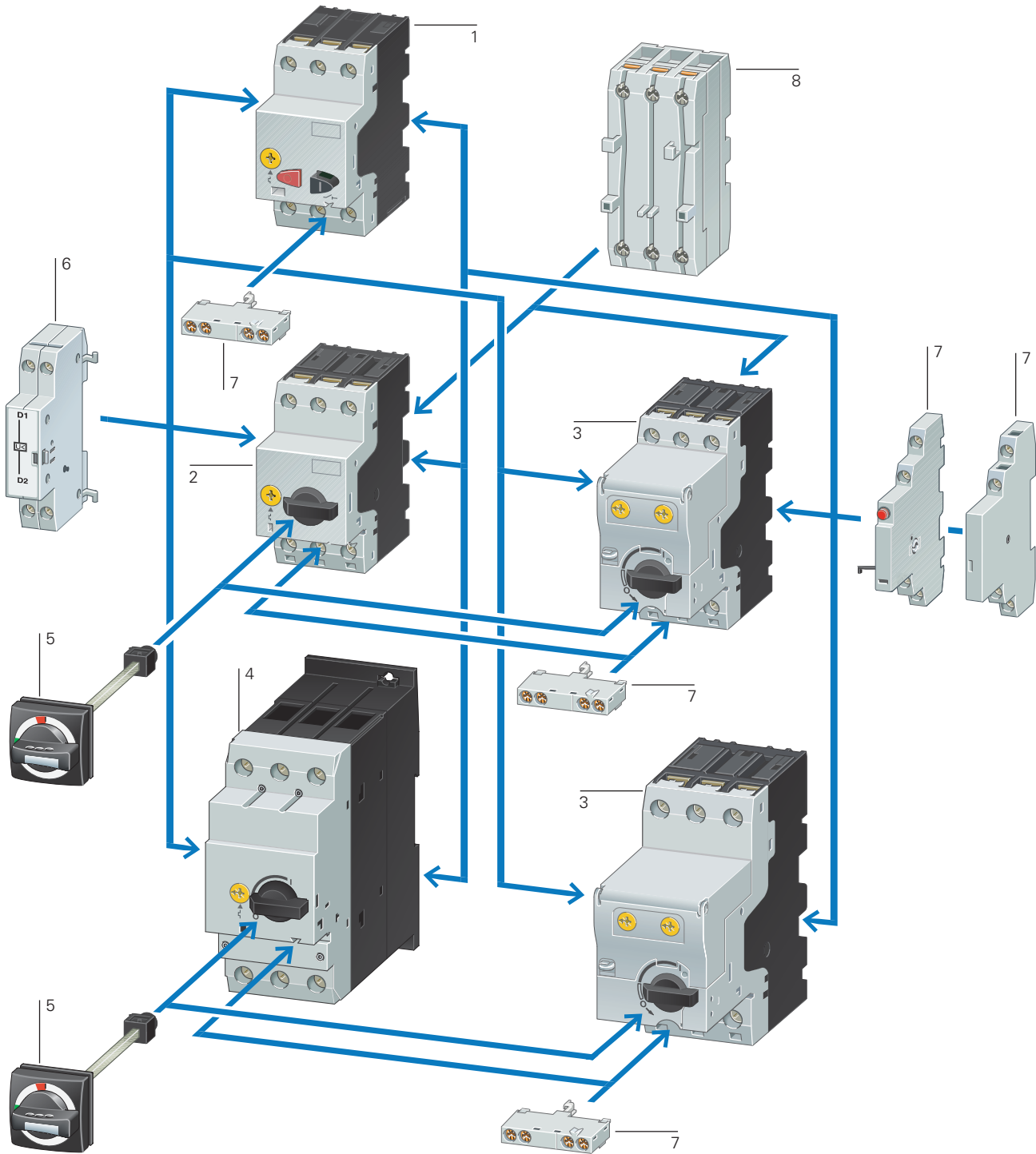

Basic devices

| | |
|---|---|
| Motor-protective circuit-breaker PKZM01 | 1 |
| → Page 3 | |
| Motor-protective circuit-breaker PKZM0 | 2 |
| → Page 4 | |

| | |
|--|---|
| Motor-protective circuit-breaker with wide-range overload protection | 3 |
| → Page 8 | |
| Motor-protective circuit-breaker PKZM4 | 4 |
| → Page 4 | |

Add-on functions

| | |
|-----------------------------|---|
| Standard auxiliary contacts | 7 |
| → Page 10 | |
| Shunt release | 6 |
| → Page 29 | |
| Current limiters | 8 |
| → Page 12 | |

Mounting accessories

| | |
|----------------------------|---|
| Door coupling handles IP65 | 5 |
| → Page 20 | |
| Insulated enclosure | |
| → Page 16 | |
| Mounting/wiring | |
| → Page 22 | |

Ordering

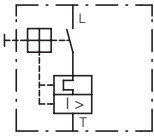
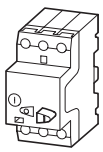

PKZM01

Max. motor rating
AC-3

| | | |
|-------|-------|-------|
| 220 V | 380 V | 440 V |
| 230 V | 400 V | |
| 240 V | 415 V | |

Rated uninter-
rupted
current

Setting range

Overload
releases

Short-
circuit
releases

| | | | | | |
|----|----|----|-------|-------|----------|
| P | P | P | I_u | I_r | I_{rm} |
| kW | kW | kW | A | A | A |

Screw terminals

Part no.
Article no.

Price
See price
list

Std. pack

**Information relevant for export to
North America**



Motor-protective circuit-breakers, type "1"; and type "2" coordination

| Max. motor rating (kW) | Max. motor rating (kW) | Max. motor rating (kW) | Rated uninter-rupted current (A) | Overload releases (A) | Short-circuit releases (A) | Part no. / Article no. | Std. pack | Information relevant for export to North America |
|------------------------|------------------------|------------------------|----------------------------------|-----------------------|----------------------------|------------------------------|-----------|---|
| - | - | - | 0.16 | 0.1...0.16 | 2.2 | PKZM01-0.16 278475 | 1 off | Product Standards UL 508; CSA-C22.2 No.14; IEC60947-4-1; CE marking |
| - | 0.06 | 0.06 | 0.25 | 0.16...0.25 | 3.5 | PKZM01-0.25 278476 | 1 off | UL File No. UL CCN E36332 |
| 0.06 | 0.09 | 0.12 | 0.4 | 0.25...0.4 | 5.6 | PKZM01-0.4 278477 | 1 off | CSA File No. NLRV 12528 |
| 0.09 | 0.12 | 0.18 | 0.63 | 0.4...0.63 | 8.8 | PKZM01-0.63 278478 | 1 off | CSA Class No. 3211-05 UL Listed, CSA certified |
| 0.12 | 0.25 | 0.25 | 1 | 0.63...1 | 14 | PKZM01-1 278479 | 1 off | NA Certification UL Listed, CSA certified Branch circuits, or suitable for group installations → Page 34 |
| 0.25 | 0.55 | 0.55 | 1.6 | 1...1.6 | 22 | PKZM01-1.6 278480 | 1 off | Suitable for |
| 0.37 | 0.75 | 1.1 | 2.5 | 1.6...2.5 | 35 | PKZM01-2.5 278481 | 1 off | See also |
| 0.75 | 1.5 | 1.5 | 4 | 2.5...4 | 56 | PKZM01-4 278482 | 1 off | |
| 1.1 | 2.2 | 3 | 6.3 | 4...6.3 | 88 | PKZM01-6.3 278483 | 1 off | |
| 2.2 | 4 | 4 | 10 | 6.3...10 | 140 | PKZM01-10 278484 | 1 off | |
| 3 | 5.5 | 5.5 | 12 | 8...12 | 168 | PKZM01-12 278485 | 1 off | |
| 4 | 7.5 | 9 | 16 | 10...16 | 224 | PKZM01-16 283390 | 1 off | |
| 5.5 | 9 | 11 | 20 | 16...20 | 280 | PKZM01-20 283383 | 1 off | Product Standards UL 508; CSA-C22.2 No.14; IEC/EN 60947-4-1; CE marking |
| 5.5 | 12.5 | 12.5 | 25 | 20...25 | 350 | PKZM01-25 288893 | 1 off | UL File No. UL CCN E36332 NLRV 12528 3211-05 UL Listed, CSA certified |

Notes

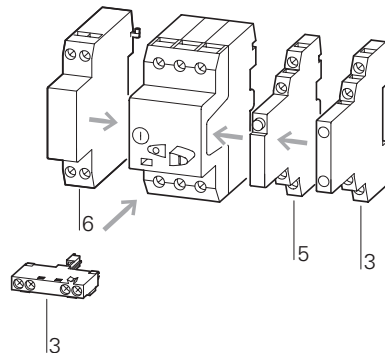

Accessories

- 3 Standard auxiliary contacts
- 5 Trip-indicating auxiliary contact
- 6 Shunt release, undervoltage release

Page

- 10
- 12
- 29

Phase failure sensitivity to IEC/EN 60947-4-1, VDE 0660 Part 102.

Can be snap-fitted to IEC/EN 60715 top-hat rail with 7.5 or 15 mm height

1.3

Motor-protective circuit-breakers PKZM01, PKZM0, PKZM4, PKE

Motor-protective circuit-breaker

1

Circuit diagrams

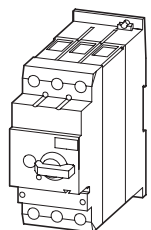
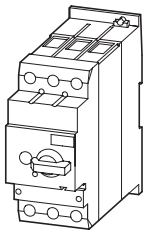
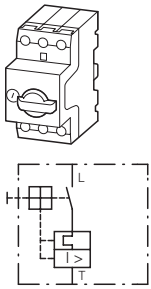

PKZM0, PKZM4

| Max. motor rating AC-3 | | | | | Rated uninter-rupted current | Setting range | | Part no. Article no. | Price See price list | Screw terminals | Screw terminals on feed side, spring-loaded terminals on output side |
|---|-------|-------|-------|-------|------------------------------|-------------------|------------------------|------------------------------|----------------------|--------------------------------|--|
| 220 V | 380 V | 440 V | 500 V | 660 V | | Overload releases | Short-circuit releases | | | | |
| 230 V | 400 V | | | 690 V | I_u | I_r | I_m | Part no. Article no. | Price See price list | | |
| 240 V | 415 V | | | | A | A | A | | | | |
| P kW | P kW | P kW | P kW | P kW | | | | | | | |
| Motor-protective circuit-breakers, type "1" and type "2" coordination¹⁾ | | | | | | | | | | | |
| - | - | - | - | 0.06 | 0.16 | 0.1...0.16 | 2.2 | PKZM0-0.16 072730 | | PKZM0-0.16-SC 229828 | |
| - | 0.06 | 0.06 | 0.06 | 0.12 | 0.25 | 0.16...0.25 | 3.5 | PKZM0-0.25 072731 | | PKZM0-0.25-SC 229829 | |
| 0.06 | 0.09 | 0.12 | 0.12 | 0.18 | 0.4 | 0.25...0.4 | 5.6 | PKZM0-0.4 072732 | | PKZM0-0.4-SC 229830 | |
| 0.09 | 0.12 | 0.18 | 0.25 | 0.25 | 0.63 | 0.4...0.63 | 8.8 | PKZM0-0.63 072733 | | PKZM0-0.63-SC 229831 | |
| 0.12 | 0.25 | 0.25 | 0.37 | 0.55 | 1 | 0.63...1 | 14 | PKZM0-1 072734 | | PKZM0-1-SC 229832 | |
| 0.25 | 0.55 | 0.55 | 0.75 | 1.1 | 1.6 | 1...1.6 | 22 | PKZM0-1.6 072735 | | PKZM0-1.6-SC 229833 | |
| 0.37 | 0.75 | 1.1 | 1.1 | 1.5 | 2.5 | 1.6...2.5 | 35 | PKZM0-2.5 072736 | | PKZM0-2.5-SC 229834 | |
| 0.75 | 1.5 | 1.5 | 2.2 | 3 | 4 | 2.5...4 | 56 | PKZM0-4 072737 | | PKZM0-4-SC 229835 | |
| 1.1 | 2.2 | 3 | 3 | 4 | 6.3 | 4...6.3 | 88 | PKZM0-6.3 072738 | | PKZM0-6.3-SC 229836 | |
| 2.2 | 4 | 4 | 4 | 7.5 | 10 | 6.3...10 | 140 | PKZM0-10 072739 | | PKZM0-10-SC 229837 | |
| 3 | 5.5 | 5.5 | 5.5 | 11 | 12 | 8...12 | 168 | PKZM0-12 278486 | | PKZM0-12-SC 278487 | |
| 4 | 7.5 | 9 | 9 | 12.5 | 16 | 10...16 | 224 | PKZM0-16 046938 | | PKZM0-16-SC 229838 | |
| 5.5 | 9 | 11 | 12.5 | 15 | 20 | 16...20 | 280 | PKZM0-20 046988 | | | |
| 5.5 | 12.5 | 12.5 | 15 | 22 | 25 | 20...25 | 350 | PKZM0-25 046989 | | | |
| 7.5 | 15 | 15 | 22 | 30 | 32 | 25...32 | 448 | PKZM0-32 278489 | | | |
| Motor-protective circuit-breakers, type "1" and type "2" coordination¹⁾ | | | | | | | | | | | |
| 4 | 7.5 | 9 | 9 | 12.5 | 16 | 10...16 | 224 | PKZM4-16 222350 | | | |
| 5.5 | 12.5 | 12.5 | 15 | 22 | 25 | 16...25 | 350 | PKZM4-25 222352 | | | |
| 7.5 | 15 | 17.5 | 22 | 22 | 32 | 25...32 | 448 | PKZM4-32 222353 | | | |
| 11 | 20 | 22 | 24 | 30 | 40 | 32...40 | 560 | PKZM4-40 222354 | | | |
| 14 | 25 | 30 | 30 | 45 | 50 | 40...50 | 700 | PKZM4-50 222355 | | | |
| 17 | 30 | 37 | 37 | 55 | 58 | 50...58 | 812 | PKZM4-58 222394 | | | |
| 18.5 | 34 | 37 | 45 | 55 | 65 | 55...65 | 882 | PKZM4-63 222413 | | | |
| Circuit-breakers²⁾ | | | | | | | | | | | |
| For line and cable protection | | | | | | | | | | | |
| - | - | - | - | - | 16 | 10...16 | 224 | PKZM4-16-CB 132591 | | | |
| - | - | - | - | - | 25 | 16...25 | 350 | PKZM4-25-CB 132592 | | | |
| - | - | - | - | - | 32 | 25...32 | 448 | PKZM4-32-CB 132593 | | | |

Spring-loaded terminals

Part no. **Price** **Std. pack** **Notes**
 Article no. See price list

Information relevant for export to North America



| | |
|-------------------------------|-----------|
| PKZM0-0,16-C 229669 | 1 off |
| PKZM0-0,25-C 229670 | |
| PKZM0-0,4-C 229671 | |
| PKZM0-0,63-C 229672 | |
| PKZM0-1-C 229673 | |
| PKZM0-1,6-C 229674 | |
| PKZM0-2,5-C 229675 | |
| PKZM0-4-C 229676 | |
| PKZM0-6,3-C 229677 | |
| PKZM0-10-C 229678 | |
| PKZM0-12-C 278488 | |
| PKZM0-16-C 229679 | |

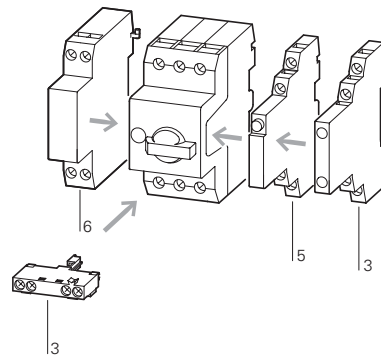

Accessories

| Accessories | Page |
|--|------|
| 3 Standard auxiliary contacts | → 10 |
| 5 Trip-indicating auxiliary contact | → 12 |
| 6 Shunt release, undervoltage release | → 29 |
| Phase failure sensitivity to IEC/EN 60947-4-1, VDE 0660 Part 102. Can be snap-fit to IEC/EN 60715 top-hat rail with 7.5 or 15 mm height | |
| PTB 02 ATEX 3151, see manual | → 21 |

1)
 Product Standards UL 508; CSA-C22.2 No.14; IEC60947-4-1; CE marking
 UL File No. E36332
 UL CCN NLRV
 CSA File No. 12528
 CSA Class No. 3211-05
 NA Certification UL Listed, CSA certified
 Suitable for Branch circuit: Manual type E if used with terminal, or suitable for group installations
 See also → Page 34

1 off

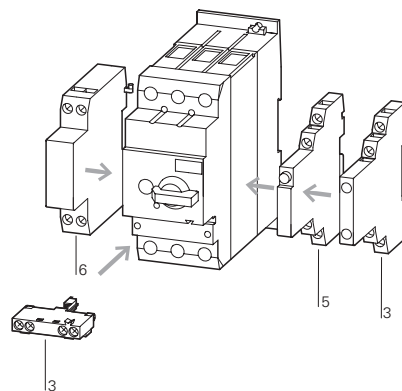

| Accessories | Page |
|--|------|
| 3 Standard auxiliary contacts | → 10 |
| 5 Trip-indicating auxiliary contact | → 12 |
| 6 Shunt release, undervoltage release | → 29 |
| Only motor-protective circuit-breaker: Phase failure sensitivity to IEC/EN 60947-4-1, VDE 0660 Part 102 Can be snap-fitted to IEC/EN 60715 top-hat rail with 7.5 or 15 mm height | |
| PTB 02 ATEX 3153, see manual | → 21 |

1 off

Not usable as a main switch
 Phase failure sensitivity to IEC/EN 60947-4-1, VDE 0660 Part 102.
 Switching capacity of SCCR
 65 kA (480 Y/277 V)
 22 kA (600 Y/347 V)

2)
 Product Standards UL 489; CSA-C22.2 No.5-09; IEC 60947-4-1; CE marking
 NA Certification Request filed for UL and CSA
 Specially designed for NA Yes
 Suitable for Feeder and branch circuit as BCPD

1.3

Motor-protective circuit-breakers PKZM01, PKZM0, PKZM4, PKE

Motor-protective circuit-breaker for starter combinations and transformers

1

PKZM0

| Max. motor rating AC-3 | | | | | Rated uninterrupted current I_u | Setting range | | Screw terminals Part no. Article no. | Price See price list | Std. pack |
|---------------------------|-------------------------|---------|---------|----------------|--|-------------------------------|------------------------------------|--|----------------------------|--------------|
| 220 V 230 V 240 V | 380 V 400 V 415 V | 440 V | 500 V | 660 V 690 V | | Overload releases I_r | Short-circuit releases I_m | | | |
| P kW | P kW | P kW | P kW | P kW | A | A | A | | | |
| | | | | 0.06 | 0.16 | | 2.2 | PKM0-0,16 072720 | | 1 off |
| | 0.06 | 0.06 | 0.06 | 0.12 | 0.25 | | 3.5 | PKM0-0,25 072721 | | 1 off |
| 0.06 | 0.09 | 0.12 | 0.12 | 0.18 | 0.4 | | 5.6 | PKM0-0,4 072722 | | 1 off |
| 0.09 | 0.12 | 0.18 | 0.25 | 0.25 | 0.63 | | 8.8 | PKM0-0,63 072723 | | 1 off |
| 0.12 | 0.25 | 0.25 | 0.38 | 0.55 | 1 | | 14 | PKM0-1 072724 | | 1 off |
| 0.25 | 0.37 | 0.55 | 0.75 | 1.1 | 1.6 | | 22 | PKM0-1,6 072725 | | 1 off |
| 0.37 | 0.75 | 1.1 | 1.1 | 1.5 | 2.5 | | 35 | PKM0-2,5 072726 | | 1 off |
| 0.75 | 1.5 | 1.5 | 2.2 | 3 | 4 | | 56 | PKM0-4 072727 | | 1 off |
| 1.1 | 2.2 | 3 | 3 | 4 | 6.3 | | 88 | PKM0-6,3 072728 | | 1 off |
| 2.2 | 4 | 4 | 4 | 7.5 | 10 | | 140 | PKM0-10 072729 | | 1 off |
| 3 | 5.5 | 5.5 | 5.5 | 11 | 12 | | 168 | PKM0-12 278490 | | 1 off |
| 4 | 7.5 | 9 | 9 | 12.5 | 16 | | 224 | PKM0-16 044502 | | 1 off |
| 5.5 | 9 | 11 | 12.5 | 15 | 20 | | 280 | PKM0-20 203594 | | 1 off |
| 5.5 | 12.5 | 12.5 | 15 | 22 | 25 | | 350 | PKM0-25 044503 | | 1 off |
| 7.5 | 15 | 15 | 22 | 30 | 32 | | 448 | PKM0-32 278491 | | 1 off |
| | | | | 0.16 | 0.16 | 0.1...0.16 | 2.4 | PKZM0-0,16-T 088907 | | 1 off |
| | | | | 0.25 | 0.25 | 0.16...0.25 | 4.25 | PKZM0-0,25-T 088908 | | 1 off |
| | | | | 0.4 | 0.4 | 0.25...0.4 | 6.8 | PKZM0-0,4-T 088909 | | 1 off |
| | | | | 0.63 | 0.63 | 0.4...0.63 | 12 | PKZM0-0,63-T 088910 | | 1 off |
| | | | | 1 | 1 | 0.63...1 | 20 | PKZM0-1-T 088911 | | 1 off |
| | | | | 1.6 | 1.6 | 1...1.6 | 32 | PKZM0-1,6-T 088912 | | 1 off |
| | | | | 2.5 | 2.5 | 1.6...2.5 | 50 | PKZM0-2,5-T 088913 | | 1 off |
| | | | | 4 | 4 | 2.5...4 | 84 | PKZM0-4-T 088914 | | 1 off |
| | | | | 6.3 | 6.3 | 4...6.3 | 141 | PKZM0-6,3-T 088915 | | 1 off |
| | | | | 10 | 10 | 6.3...10 | 224 | PKZM0-10-T 088916 | | 1 off |
| | | | | 12 | 12 | 8...12 | 224 | PKZM0-12-T 278492 | | 1 off |
| | | | | 16 | 16 | 10...16 | 280 | PKZM0-16-T 088917 | | 1 off |
| | | | | 20 | 20 | 16...20 | 350 | PKZM0-20-T 088918 | | 1 off |
| | | | | 25 | 25 | 20...25 | 437 | PKZM0-25-T 278493 | | 1 off |

Motor-protective circuit-breakers for starter combinations
Short-circuit protective breakers without overload function

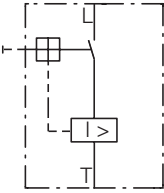
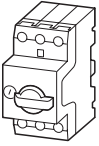

Transformer-protective circuit-breakers

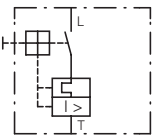
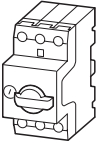

Notes

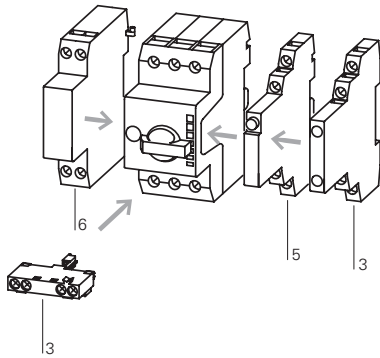

When using the PKM0 as short-circuit protection for motors with heavy starting duty, a device must be selected whose rated operational current I_e is higher by the following factors:

- CLASS 5 = 1.0
- CLASS 10 = 1.0
- CLASS 15 = 1.22
- CLASS 20 = 1.41
- CLASS 25 = 1.58
- CLASS 30 = 1.73
- CLASS 35 = 1.89
- CLASS 40 = 2.0

Accessories

- 3 Standard auxiliary contacts
- 5 Trip-indicating auxiliary contact
- 6 Shunt release, undervoltage release
- Additional accessories

Page

- 10
- 12
- 29
- 46

Can be snap-fitted to IEC/EN 60715 top-hat rail with 7.5 or 15 mm height

Assignment of the short-circuit protective breakers and contactors in "Fuseless motor-starter combinations" section.

An appropriate overload relay must be fitted to protect motors against overload.

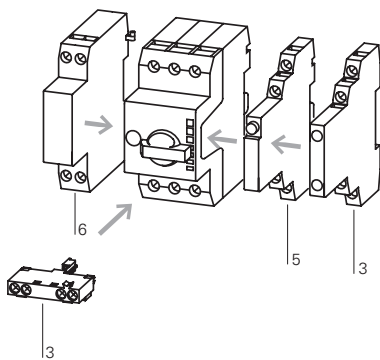

Accessories

- 3 Standard auxiliary contacts
- 5 Trip-indicating auxiliary contact
- 6 Shunt release, undervoltage release

Page

- 10
- 12
- 29

For the protection of transformers with a high inrush current

Can be snap-fitted to IEC/EN 60715 top-hat rail with 7.5 or 15 mm height

Phase failure sensitivity to IEC/EN 60947-4-1, VDE 0660 Part 102.













1.3

Motor-protective circuit-breakers PKZM01, PKZM0, PKZM4, PKE

Motor-protective circuit-breaker

PKE

1

| Motor rating P kW | Motor full-load current AC-3 | | | | | Setting range Overload releases | Basic device Part no. Article no. | See price list | Std. pack |
|-------------------------|---------------------------------|-------------------------|-------|-------|----------------|------------------------------------|---|---|-----------|
| | 220 V 230 V 240 V | 380 V 400 V 415 V | 440 V | 500 V | 660 V 690 V | | | | |
| 0.06 | 0.37 | – | – | – | – | 0.3...1.2 A | PKE12 121721 | 1off   | |
| 0.09 | 0.54 | 0.31 | – | – | – | | | | |
| 0.12 | 0.72 | 0.41 | 0.37 | 0.33 | – | | | | |
| 0.18 | 1.04 | 0.6 | 0.54 | 0.48 | 0.35 | | | | |
| 0.25 | – | 0.8 | 0.76 | 0.7 | 0.5 | | | | |
| 0.37 | – | 1.1 | 1.02 | 0.9 | 0.7 | | | | |
| 0.55 | – | – | – | – | 0.9 | | | | |
| 0.75 | – | – | – | – | 1.1 | | | | |
| 0.18 | 1.04 | – | – | – | – | 1...4 A | PKE12 121721 | 1off   | |
| 0.25 | 1.4 | – | – | – | – | | | | |
| 0.37 | 2 | 1.1 | 1.02 | – | – | | | | |
| 0.55 | 2.7 | 1.5 | 1.39 | 1.2 | – | | | | |
| 0.75 | 3.2 | 1.9 | 1.68 | 1.5 | 1.1 | | | | |
| 1.1 | – | 2.6 | 2.41 | 2.1 | 1.5 | | | | |
| 1.5 | – | 3.6 | 3.28 | 2.9 | 2.1 | | | | |
| 2.2 | – | – | – | 4 | 2.9 | | | | |
| 3 | – | – | – | – | 3.8 | | | | |
| 0.75 | 3.2 | – | – | – | – | 3...12 A | PKE12 121721 | 1off   | |
| 1.1 | 4.6 | – | – | – | – | | | | |
| 1.5 | 6.3 | 3.6 | 3.3 | – | – | | | | |
| 2.2 | 8.7 | 5 | 4.6 | 4 | – | | | | |
| 3 | 11.5 | 6.6 | 6 | 5.3 | 3.8 | | | | |
| 4 | – | 8.5 | 7.7 | 6.8 | 4.9 | | | | |
| 5.5 | – | 11.3 | 10.2 | 9 | 6.5 | | | | |
| 7.5 | – | – | – | – | 8.8 | | | | |
| 2.2 | 8.7 | – | – | – | – | 8...32 A | PKE32 121722 | 1off   | |
| 3 | 11.5 | – | – | – | – | | | | |
| 4 | 14.8 | 8.5 | – | – | – | | | | |
| 5.5 | 19.6 | 11.3 | 10.2 | 9 | – | | | | |
| 7.5 | 26.4 | 15.2 | 13.8 | 12.1 | 8.8 | | | | |
| 11 | – | 21.7 | 19.8 | 17.4 | 12.6 | | | | |
| 15 | – | 29.3 | 26.6 | 23.4 | 17 | | | | |
| 18.5 | – | – | – | 28.9 | 20.9 | | | | |
| 22 | – | – | – | – | 23.8 | | | | |
| 30 | – | – | – | – | 32 | | | | |
| 5.5 | 19.6 | – | – | – | – | 16...65 A | PKE65 138258 | 1off   | |
| 7.5 | 26.4 | – | – | – | – | | | | |
| 11 | 38 | 21.7 | 19.7 | 17.4 | – | | | | |
| 15 | 51 | 29.3 | 26.6 | 23.4 | 17 | | | | |
| 18.5 | 63 | 36 | 32.9 | 28.9 | 20.9 | | | | |
| 22 | – | 41 | 37.4 | 33 | 23.8 | | | | |
| 30 | – | 55 | 50.3 | 44 | 32 | | | | |
| 37 | – | – | 61.4 | 54 | 39 | | | | |
| 45 | – | – | – | 65 | 47 | | | | |
| 55 | – | – | – | – | 58 | | | | |
| 2.2 | 8.7 | – | – | – | – | 8...32 A | PKE65 138258 | 1off   | |
| 3 | 11.5 | – | – | – | – | | | | |
| 4 | 14.8 | 8.5 | – | – | – | | | | |
| 5.5 | 19.6 | 11.3 | 10.2 | 9 | – | | | | |
| 7.5 | 26.4 | 15.2 | 13.8 | 12.1 | 8.8 | | | | |
| 11 | – | 21.7 | 19.8 | 17.4 | 12.6 | | | | |
| 15 | – | 29.3 | 26.6 | 23.4 | 17 | | | | |
| 18.5 | – | – | – | 28.9 | 20.9 | | | | |
| 22 | – | – | – | – | 23.8 | | | | |
| 30 | – | – | – | – | 32 | | | | |

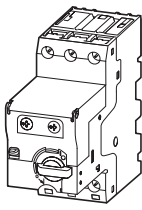
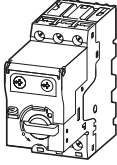

Notes Select switchgear and cables according to Class as shown in the table on Chapter 1.2 (Page 22)
 1) For communications, module PKE-SWD-32 for contactors is required in addition, → See catalog

Motor-protective circuit-breakers PKZM01, PKZM0, PKZM4, PKE

Motor-protective circuit-breaker

1.3

1

| Trip module Standard | | | | Trip module Expanded ¹⁾ | | | Motor-protective circuit-breakers Standard Complete device | | | |
|----------------------|------------------------------|------------------------------|-----------|------------------------------------|-------------------------------|------------------------------|--|--------------------------------|------------------------------|-----------|
| usable for | Part no. Article no. | See price list | Std. pack | usable for | Part no. Article no. | See price list | Std. pack | Part no. Article no. | See price list | Std. pack |
| | PKE12 | | 1off | PKE12 | PKE-XTUA-1,2 121727 | | 1off | PKE12/XTU-1,2 121731 | | 1off |
| | | Start of delivery 07/2010 | | | | Start of delivery 07/2010 | | | Start of delivery 07/2010 | |
| | PKE12 | | 1off | PKE12 | PKE-XTUA-4 121728 | | 1off | PKE12/XTU-4 121732 | | 1off |
| | | Start of delivery 05/2010 | | | | Start of delivery 05/2010 | | | | |
| | PKE12 PKE32 | | 1off | PKE12 PKE32 | PKE-XTUA-12 121729 | | 1off | PKE12/XTU-12 121733 | | 1off |
| | | Start of delivery 05/2010 | | | | Start of delivery 05/2010 | | | | |
| | PKE32 | | 1off | PKE32 | PKE-XTUA-32 121730 | | 1off | PKE32/XTU-32 121734 | | 1off |
| | | Start of delivery 05/2010 | | | | Start of delivery 05/2010 | | | | |
| | PKE65 | | 1off | PKE65 | PKE-XTUA-65 138260 | | 1off | PKE65/XTU-65 138516 | | 1off |
| | | Start of delivery 10/2010 | | | | Start of delivery 10/2010 | | | Start of delivery 10/2010 | |
| | PKE65 | | 1off | PKE65 | PKE-XTUWA-32 138262 | | 1off | PKE65/XTUW-32 138517 | | 1 off |
| | | Start of delivery 10/2010 | | | | Start of delivery 10/2010 | | | Start of delivery 10/2010 | |

Information relevant for export to North America

Product Standards
NA Certification

UL 508; CSA-C22.2 No. 14; IEC60947-4-1; CE marking
Request filed for UL and CSA











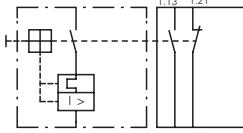

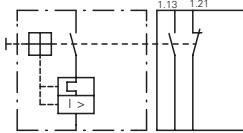

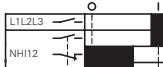
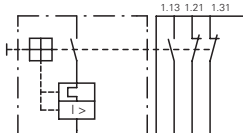
1.3

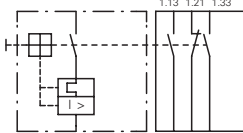
Motor-protective circuit-breakers PKZM01, PKZM0, PKZM4, PKE Standard auxiliary contacts

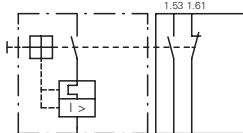
1

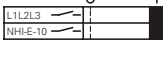
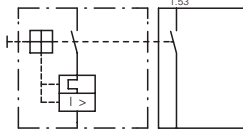
NHI...-PKZ0... Standard auxiliary contacts

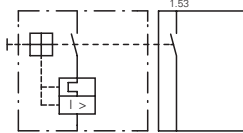
For motor-protective circuit-breakers

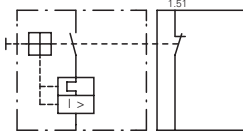
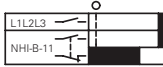
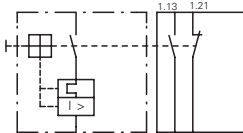
| Contact configuration | Contact sequence | Circuit diagrams | Connection method | For use with | Part no. Article no. | Price | Std. pack |
|---|------------------|--|-------------------------|---|----------------------------------|----------------|---|
| N/O = normally open contact NC = normally closed contact | | | | | | See price list | |
| 1 N/O | 1 NC |   | Screw terminals | PKZM01 PKZM0 PKZM4 PKZM0-T PKM0 PKE 1) | NHI11-PKZ0 072896 | | 5 off  |
| 1 N/O | 1 NC |   | Spring-loaded terminals | PKZM01 PKZM0 PKZM4 PKZM0-T PKM0 PKE 1) | NHI11-PKZ0-C 229680 | | 5 off  |
| 1 N/O | 2 NC |   | Screw terminals | PKZM01 PKZM0 PKZM4 PKZM0-T PKM0 PKE 1) | NHI12-PKZ0 072895 | | 5 off  |
| 2 N/O | 1 NC |   | Screw terminals | PKZM01 PKZM0 PKZM4 PKZM0-T PKM0 PKE 1) | NHI21-PKZ0 072894 | | 5 off  |
| 1 N/O | 1 NC |   | Screw terminals | PKZM01 PKZM0 PKZM4 PKZM0-T PKM0 PKE 1) | NHI-E-11-PKZ0 082882 | | 5 off  |
| 1 N/O | - |   | Screw terminals | PKZM01 PKZM0 PKZM4 PKZM0-T PKM0 PKE 1) | NHI-E-10-PKZ0 082884 | | 5 off  |
| 1 N/O | - |   | Spring-loaded terminals | PKZM01 PKZM0 PKZM4 PKZM0-T PKM0 PKE 1) | NHI-E-10-PKZ0-C 229681 | | 5 off  |
| - | 1 NC |   | Spring-loaded terminals | PKZM01 PKZM0 PKZM4 PKZM0-T PKM0 PKE 1) | NHI-E-01-PKZ0-C 229682 | | 5 off |
| 1 N/O | 1 NC |   | Screw terminals | PKZM01 PKZM0 PKZM4 PKZM0-T PKM0 PKE 1) | NHI-B-11-PKZ0 208277 | | 5 off |

Notes

1) Only standard auxiliary contacts manufactured on or after CW 36/2009 are for use with PKE.

Notes

Can be fitted to the right side of: motor-protective circuit-breakers, transformer protective circuit breakers and motor-protective circuit-breakers for starter combinations

Can be combined with:
Trip-indicating auxiliary contact AGM, NHI-E...

Notes

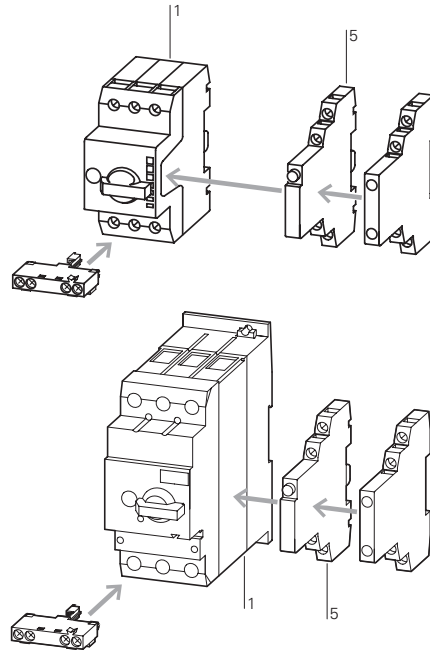

Information relevant for export to North America



| | |
|-------------------|--|
| Product Standards | UL 508; CSA-C22.2No.14; IEC 60947-4-1; CE marking |
| UL File No. | E36332 |
| UL CCN | NLRV |
| CSA File No. | 12528 |
| CSA Class No. | 3211-05 |
| NA Certification | UL Listed, CSA certified |

Can be fitted to motor-protective circuit-breakers, transformer-protective circuit-breakers and motor-protective circuit-breakers for starter combinations from serial number 01. 45 mm (PKZM0 and PKZM01) or 55 mm (PKZM4) widths of the motor-protective circuit-breakers remain unchanged.
NHI-E...-PKZ0-C not for use with MSC...-type motor starter combinations.

Accessories

- 1 Motor-protective circuit-breakers → 4
- 5 Trip-indicating auxiliary contact → 12
- Additional accessories → 20

1.3

Motor-protective circuit-breakers PKZM01, PKZM0, PKZM4, PKE Auxiliary contacts, undervoltage releases

1

AGM2...., VHI...

Contact configuration

N/O = normally open contact
NC = normally closed contact

Contact sequence

Circuit diagrams

For use with

Part no.
Article no.

Price
See price list

Std. pack

Trip indicators

For motor-protective circuit-breakers

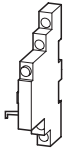

2 x 1 N/O

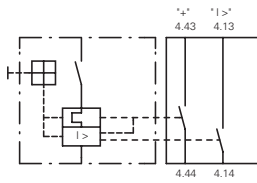
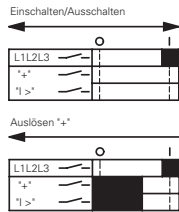

PKZM0
PKZM4
PKZM0-T
PKM0
PKZM01
PKE¹⁾

AGM2-10-PKZ0
072898

2 off

– 2 x 1 NC

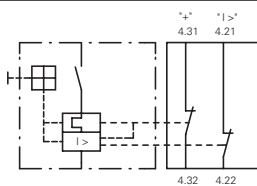
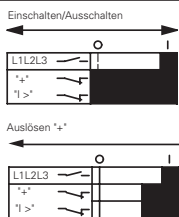

PKZM0
PKZM4
PKZM0-T
PKM0
PKZM01
PKE¹⁾

AGM2-01-PKZ0
072899

2 off

Early-make auxiliary contacts

For motor-protective circuit-breakers



2 N/O

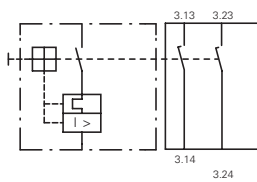

PKZM0
PKZM0-T
PKM0
PKZM4

VHI20-PKZ0
203595

2 off

2 N/O



PKZM01

VHI20-PKZ01
278495

5 off

Shunt release (for power circuit-breakers)

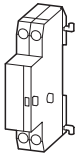

–

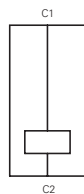

PKZM0
PKZM4
PKZM0-T
PKM0
PKZM01
PKE²⁾

A-PKZ0(230V50Hz)
073187

2 off

–

PKZM0
PKZM4
PKZM0-T
PKM0
PKZM01
PKE²⁾

A-PKZ0(24VDC)
073200

2 off

Undervoltage release

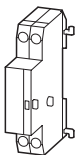

–

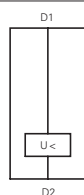

PKZM0
PKZM4
PKZM0-T
PKM0
PKZM01
PKE²⁾

U-PKZ0(230V50Hz)
073135

2 off

Current limiters

For increasing switching capacity of motor-protective circuit-breakers without auto-protection

–

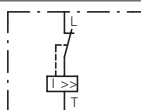

PKZM0
PKZM4
PKE

CL-PKZ0
082881

1 off

Notes

- ¹⁾ Only AGM2-...-PKZ0 manufactured on or after 06/2009 can be fitted.
- ²⁾ Only A(U)-PKZ0... with serial number 02 or higher can be fitted.

Notes

Can be fitted to the right side of motor-protective circuit-breakers

Can be combined with:
Standard auxiliary contacts
NHI11-PKZO
NHI12-PKZO
NHI21-PKZO
NHI-E-...

Separate indication of:
a) General trip indication (overload)
b) Short-circuit trip

Local short-circuit indication by red indicator, manually resettable.

Can be fitted to front of motor-protective circuit-breaker, 45 mm width of the motor-protective circuit-breaker remains unchanged.
For early energization of undervoltage release, e.g. in emergency switching off circuits to EN 60204.
VHI20-PKZO cannot be used in combination with PKZO-X(R).

Notes

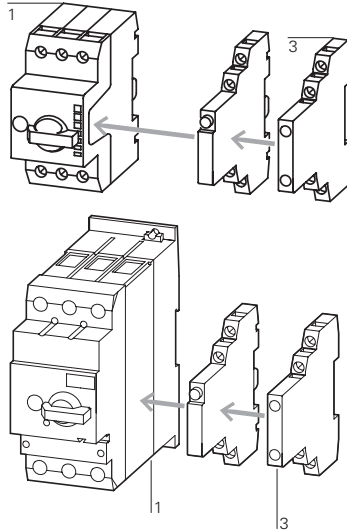

Accessories

- 1 Motor-protective circuit-breakers
- 3 Standard auxiliary contacts

Page

- 4
- 10

Information relevant for export to North America



| | |
|-------------------|--|
| Product Standards | UL 508; CSA-C22.2No.14; IEC60947-4-1; CE marking |
| UL File No. | E36332 |
| UL CCN | NLRV |
| CSA File No. | 12528 |
| CSA Class No. | 3211-05 |
| NA Certification | UL Listed, CSA certified |

Can be fitted to the left side of motor-protective circuit-breakers.
Cannot be combined with:
undervoltage release U-PKZO
DC: Intermittent operation 5 s

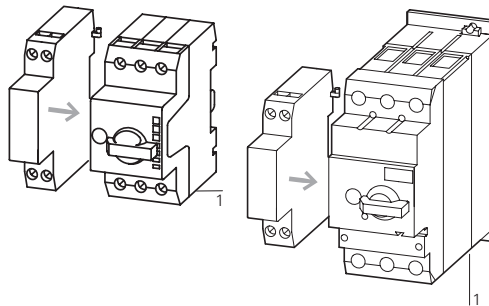

Accessories

- 1 Motor-protective circuit-breakers
- Further actuating voltages

Page

- 4
- 29

Can be fitted to the left side of motor-protective circuit-breakers.
Cannot be combined with:
A-PKZO shunt release
When combined with circuit-breaker, can be used as emergency switching off device to IEC/EN 60204.

Max. rated operating voltage $U_n = 690$ V, rated uninterrupted current $I_n = 63$ A
Can be used for individual and group protection.
For group protection and in combination with PKZM4, order additional BK25/3 incoming terminal if required.
Mounting next to or behind the motor-protective circuit-breaker.
PKZM4: 16 - 63 A: 100 kA/400 V
PKZM4: 16 - 63 A: 10 kA/690 V











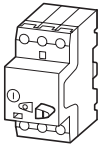

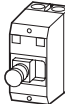
1.3

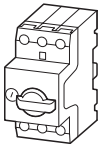
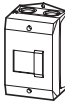
Motor-protective circuit-breakers PKZM01, PKZM0, PKZM4, PKE

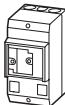
Accessories for motor-protective circuit-breakers in enclosures

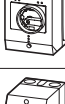
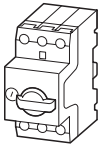





1 Engineering

PKZM01, PKZM

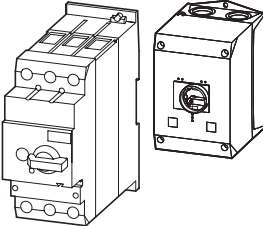
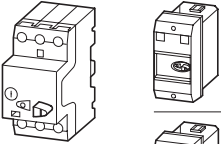
| Part no. | Enclosure | | Degree of protection | Handle color | Accessories | | | | | | | |
|---|---|--|----------------------|--------------|-------------|--------------|---------------|-------------|-----------------|------------------|--------|--|
| | Part no. | | | | NHI...-PKZ0 | AGM2...-PKZ0 | NHI-E...-PKZ0 | VHI...-PKZ0 | VHI...-PKZ01 | U-PKZ0 or A-PKZ0 | L-PKZ0 | |
| Surface mounting enclosure | | | | | | | | | | | | |
| Motor-protective circuit-breaker PKZM01 | | | | | | | | | | | | |
|  |  | CI-PKZ01 | IP40 | — | — | — | ● | — | — | ● | ● | |
| | | | | | — | — | — | — | ● | ● | ● | |
| | | | | | ● | — | ● | — | — | — | ● | |
| | | | | | ● | — | — | — | ● | — | ● | |
| |  | CI-PKZ01-G | IP65 | — | — | — | ● | — | — | ● | ● | |
| | | | | | — | — | — | — | ● | ● | ● | |
| | | | | | ● | — | ● | — | — | — | ● | |
| | | | | | ● | — | — | — | ● | — | ● | |
| |  | CI-PKZ01-PVT CI-PKZ01-PVS | IP65 | Red-yellow | — | — | ● | — | — | ● | ● | |
| | | | | | — | — | — | — | ● | ● | ● | |
| | | | | | — | — | — | — | ● | ● | ● | |
| |  | CI-PKZ01-SVB CI-PKZ01-SVB-V | IP65 | — | — | — | ● | — | — | ● | ● | |
| | | | | | — | — | — | — | ● ¹⁾ | ● | ● | |
| | | | | | — | — | — | — | — | ● | ● | |
| Motor-protective circuit-breaker PKZM0 | | | | | | | | | | | | |
|  |  | CI-K2-PKZ0 | IP41 | — | ● | — | ● | — | — | ● | ● | |
| | | | | | — | ● | ● | — | — | ● | ● | |
| | | | | | ● | — | ● | — | — | ● | ● | |
| | | | | | — | ● | ● | — | — | ● | ● | |
| |  | CI-K2-PKZ0-G | IP65 | Black | ● | — | ● | — | — | ● | ● | |
| | | | | | — | ● | ● | — | — | ● | ● | |
| | | | | | ● | — | ● | — | — | ● | ● | |
| | | | | | — | ● | ● | — | — | ● | ● | |
| |  | CI-K2-PKZ0-GR | IP65 | Red-yellow | ● | — | ● | — | — | ● | ● | |
| | | | | | — | ● | ● | — | — | ● | ● | |
| | | | | | — | ● | ● | — | — | ● | ● | |
| | | | | | — | — | ● | — | — | ● | ● | |
| |  | CI-PKZ0-M | IP40 | — | ● | — | ● | — | — | — | ● | |
| | | | | | — | — | ● | — | — | ● | ● | |
| | | | | | — | — | ● | — | — | — | ● | |
| | | | | | — | — | — | — | — | ● | ● | |
| |  | CI-PKZ0-GM | IP55 | Black | ● | — | ● | — | — | — | ● | |
| | | | | | — | — | ● | — | — | ● | ● | |
| | | | | | — | — | ● | — | — | — | ● | |
| | | | | | — | — | — | — | — | ● | ● | |
| |  | CI-PKZ0-GRM | IP55 | Red-yellow | ● | — | ● | — | — | — | ● | |
| | | | | | — | — | ● | — | — | — | ● | |
| | | | | | — | — | — | — | — | ● | ● | |
| | | | | | — | — | ● | — | — | — | ● | |
| Motor-protective circuit-breaker PKZM0 + early-make auxiliary contact VHI-PKZ0 | | | | | | | | | | | | |
|  |  | CI-K2-PKZ0-GV | IP65 | Black | ● | — | — | ● | — | ● | ● | |
| | | | | | — | ● | — | ● | — | ● | ● | |
| | | | | | ● | — | — | ● | — | ● | ● | |
| | | | | | — | ● | — | ● | — | ● | ● | |
| |  | CI-K2-PKZ0-GRV | IP65 | Red-yellow | ● | — | — | ● | — | ● | ● | |
| | | | | | — | ● | — | ● | — | ● | ● | |
| | | | | | — | — | — | ● | — | — | ● | |
| | | | | | — | — | — | ● | — | — | ● | |
| |  | CI-K2-PKZ0-GVM | IP55 | Black | ● | — | — | ● | — | — | ● | |
| | | | | | — | — | — | ● | — | — | ● | |
| | | | | | — | — | — | ● | — | — | ● | |
| | | | | | — | — | — | ● | — | — | ● | |
| |  | CI-K2-PKZ0-GRVM | IP55 | Red-yellow | ● | — | — | ● | — | — | ● | |
| | | | | | — | — | — | ● | — | — | ● | |
| | | | | | — | — | — | ● | — | — | ● | |
| | | | | | — | — | — | ● | — | — | ● | |

Notes The combination possibilities of circuit-breakers in an enclosure with accessory modules are identified by a ●
¹⁾ Always required

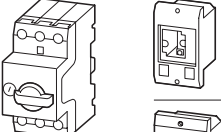
PKZM4, PKZM01, PKZM0

| Enclosure | | Accessories | | | | | | | | |
|---|------------------------------|----------------------|--------------|------------|--------------|--------------|------------|-----------------|------------------|--------|
| Part no. | Part no. | Degree of protection | Handle color | NHI..-PKZ0 | AGM2...-PKZ0 | NHI-E..-PKZ0 | VHI..-PKZ0 | VHI..-PKZ01 | U-PKZ0 or A-PKZ0 | L-PKZ0 |
| Surface mounting enclosure | | | | | | | | | | |
| Motor-protective circuit-breaker PKZM4 | | | | | | | | | | |
|  | CI-K4-PKZ4-G | IP65 | Black | ● | ● | ● | - | - | ● | ● |
| | CI-K4-PKZ4-GR | IP65 | Red-yellow | ● | ● | ● | - | - | ● | ● |
| Installation enclosure | | | | | | | | | | |
| Motor-protective circuit-breaker PKZM01 | | | | | | | | | | |
|  | E-PKZ01 | IP40 | - | - | - | ● | - | - | ● | ● |
| | | | | ● | - | ● | - | ● | ● | ● |
|  | E-PKZ01-G | IP65 | - | - | - | ● | - | - | ● | ● |
| | | | | ● | - | ● | - | ● | ● | ● |
|  | E-PKZ01-PVT E-PKZ01-PVS | IP65 | Red-yellow | - | - | ● | - | - | ● | ● |
| | | | | - | - | - | - | ● | ● | ● |
|  | E-PKZ01-SVB E-PKZ01-SVB-V | IP65 | - | - | - | ● | - | - | ● | ● |
| | | | | - | - | - | - | ● ¹⁾ | ● | ● |
| Motor-protective circuit-breaker PKZM0 | | | | | | | | | | |
|  | E-PKZ0 | IP40 | - | ● | - | - | - | - | - | ● |
| | | | | - | - | - | - | - | ● | ● |
|  | E-PKZ0-G | IP55 | Black | ● | - | ● | - | - | - | ● |
| | | | | - | - | ● | - | - | ● | ● |
| | E-PKZ1-GR | IP55 | Red-yellow | ● | - | ● | - | - | - | ● |
| | | | | - | - | ● | - | - | ● | ● |

Notes









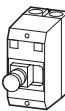
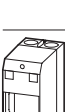

The combination possibilities of circuit-breakers in an enclosure with accessory modules are identified by a ●
¹⁾ Always required

1.3



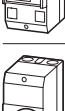
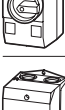

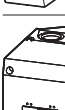























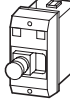

Motor-protective circuit-breakers PKZM01, PKZM0, PKZM4, PKE Insulated enclosure

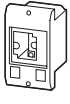
1

PKZM01, PKZM0, PKZM4

| | Degree of protection | For use with | Part no. Article no. | Price See price list | Std. pack | Notes |
|---|--------------------------------|---|---------------------------------|-------------------------|-----------|--|
| Insulated enclosures for surface mounting | | | | | | |
| For Motor-protective circuit-breaker PKZM01 | | | | | | |
|  | IP40 | PKZM01 +NHI-E or VHI-PKZ01 +U or A or NHI +L (2 off) | CI-PKZ01 281403 | | 1 off | Integrated terminal for PE(N) connection, two M25 cable entry knockouts at top and at bottom. |
|  | IP65 | | CI-PKZ01-G 281404 | | 1 off | |
|  | IP65 | PKZM01 +NHI-E or +U or A +L (2 off) | CI-PKZ01-SVB 281405 | | 1 off | |
|  | IP65 | | CI-PKZ01-SVB-V 281944 | | 1 off | |
|  | IP65 | | CI-PKZ01-PVT 281406 | | 1 off | |
|  | IP65 | | CI-PKZ01-PVS 281407 | | 1 off | |
|  | As insert | PKZM01 | CI-PKZ01-X 289934 | | 1 off | |
| For Motor-protective circuit-breakers PKZM0 | | | | | | |
|  | IP41 with vertical mounting | PKZM0-... +NHI or AGM +U or A +NHI-E +L-PKZ0 (2 off) | CI-K2-PKZ0 219653 | | 1 off | M25 metric cable entry knockout, top and bottom Cable push-through membrane top, bottom, in the back plate and as a control line entry. Insulated enclosure CI-K2 incl. N and PE terminal. |
|  | IP65 | | CI-K2-PKZ0-G 219654 | | 1 off | |
|  | IP65 | | CI-K2-PKZ0-GR 219655 | | 1 off | |
|  | IP40 | PKZM0-... +NHI or U or A +L-PKZ0 (2 off) | CI-PKZ0-M 267083 | | 1 off | Integrated terminal for PE(N) connection, two M25 cable entry knockouts at top and at bottom. |
|  | IP55 | PKZM0-... +NHI-E | CI-PKZ0-GM 260089 | | 1 off | |
|  | IP55 | +NHI or U or A +L-PKZ0 (2 off) | CI-PKZ0-GRM 260104 | | 1 off | |
| For Motor-protective circuit-breakers PKZM0 with early-make VHI auxiliary contacts | | | | | | |
|  | IP65 | PKZM0-... and VHI +NHI or AGM | CI-K2-PKZ0-GV 219657 | | 1 off | M25 metric cable entry knockout, top and bottom Cable push-through membrane top, bottom, in the back plate and as a control line entry. Insulated enclosure CI-K2 incl. N and PE terminal. |
|  | IP65 | +U or A +L (2 off) | CI-K2-PKZ0-GRV 219656 | | 1 off | |
| | IP55 | PKZM0-... and VHI +U or A (undervoltage or shunt release) +L-PKZ0 (2 off) | CI-PKZ0-GVM 263526 | | 1 off | Integrated terminal for PE(N) connection, two M25 cable entry knockouts at top and at bottom. |
| | IP55 | | CI-PKZ0-GRVM 263525 | | 1 off | |
| For Motor-protective circuit-breakers PKZM4 | | | | | | |
| | IP65 | PKZM4-... +VHI or NHI-E | CI-K4-PKZ4-G 225524 | | 1 off | Metric knockout: Top and bottom: M25/M32 In the back plate: M25/M32 Control cable entry: M20 CI-K4 insulated enclosure including insulated PE terminal |
| | IP65 | +NHI and AGM +U or A +L-PKZ0 (2 off) | CI-K4-PKZ4-GR 225525 | | 1 off | |

E-PKZ























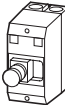

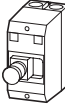



| | Degree of protection | For use with | Part no. Article no. | Price See price list | Std. pack | Information relevant for export to North America | |
|---|--|--------------|---|--------------------------------|--|---|---|
| | | | | | |   |   |
| Insulated enclosures for flush mounting | | | | | | | |
| For Motor-protective circuit-breaker PKZM01 | | | | | | | |
| Integrated terminal for PE(N) connection. | | | | | | | |
|  | | Front IP40 | PKZM01 +NHI or U or A +NHI-E or VHI +L (2 off) | E-PKZ01 281633 | 1 off   | Product Standards | UL 508; CSA-C22.2 No.14; IEC60947-4-1; CE marking |
| | With operating membrane | Front IP65 | | E-PKZ01-G 281634 | 1 off   | UL File No. UL CCN CSA File No. CSA Class No. NA Certification | E36332 NLRV 12528 3211-05 UL Listed, CSA certified |
|  | Lockable in Off position | Front IP65 | PKZM01 +U or A +NHI-E | E-PKZ01-SVB 281635 | 1 off   | | |
|  | Lockable in Off position, in combination with VHI-PKZ01 | Front IP65 | PKZM01 +U or A +NHI-E or VHI | E-PKZ01-SVB-V 281943 | 1 off   | | |
|  | With emergency switching off mushroom button, maintained | Front IP65 | | E-PKZ01-PVT 281636 | 1 off   | | |
|  | With emergency switching off mushroom button, with key-release | Front IP65 | | E-PKZ01-PVS 281637 | 1 off   | | |
|  | For extension with inserts C/E-PKZ01-X... unit | As insert | PKZM01 | E-PKZ01-X 289935 | 1 off | | |
| For Motor-protective circuit-breakers PKZM0 | | | | | | | |
| Integrated terminal for PE(N) connection. | | | | | | | |
|  | Cover with aperture dimensioned to accommodate front of breaker | Front IP40 | PKZM0-... +NHI or U or A +L-PKZ0 (2 parts) | E-PKZ0 072906 | 1 off   | Product Standards | UL 508; CSA-C22.2 No.14; IEC60947-4-1; CE marking |
| | With black-grey rotary knob | Front IP55 | PKZM0-... +NHI or U or A +NHI-E +L-PKZ0 (2 parts) | E-PKZ0-G 072907 | 1 off   | UL File No. UL CCN CSA File No. CSA Class No. NA Certification | E36332 NLRV 12528 3211-05 UL Listed, CSA certified |
|  | With red-yellow rotary knob, for use as emergency switching off device to EN 60204 | Front IP55 | | E-PKZ0-GR 072908 | 1 off   | Degree of Protection | UL 508; CSA-C22.2 No.14; IEC60947-4-1; CE marking |

1.3











Motor-protective circuit-breakers PKZM01, PKZM0, PKZM4, PKE Insulated enclosure

1

CI-PKZ

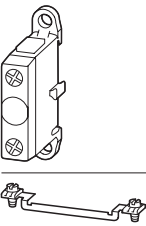
| | Degree of protection | For use with | Part no. Article no. | Price See price list | Std. pack | Information relevant for export to North America |
|---|--|---|------------------------------------|-------------------------|--|---|
| Insulated enclosures for surface mounting | | | | | | |
| For Motor-protective circuit-breaker PKZM01s | | | | | | |
| Integrated terminal for PE(N) connection. | | | | | | |
|  | IP41 | PKZM01 +NHI-E or VHI-PKZ01 +U or A or NHI +L (2 off) | CI-PKZ01-NA 281408 | | 1 off   | Product Standards UL 508; CSA-C22.2 No.14; IEC60947- 4-1; CE marking UL File No. UL CCN CSA File No. CSA Class No. NA Certification |
|  | With operating membrane IP65 | PKZM01 +NHI-E or VHI-PKZ01 +U or A or NHI +L (2 off) | CI-PKZ01-NA-G 281409 | | 1 off   | E36332 NLRV 12528 3211-05 UL Listed, CSA certified |
|  | Lockable in Off position IP65 | PKZM01 +NHI-E or VHI-PKZ01 +U or A +L (2 off) | CI-PKZ01-NA-SVB 281630 | | 1 off   | Specialty designed for NA ✓ Degree of Protection IEC: IP41, UL/CSA Type: - |
|  | Lockable in Off position, in combination with VHI-PKZ01 IP65 | PKZM01 +NHI-E +U or A +L (2 off) | CI-PKZ01-NA-SVB-V 281945 | | 1 off   | |
|  | With emergency switching off mushroom button, maintained IP65 | | CI-PKZ01-NA-PVT 281631 | | 1 off   | |
|  | With emergency switching off mushroom button, with key-release IP65 | | CI-PKZ01-NA-PVS 281632 | | 1 off   | |
| For Motor-protective circuit-breakers PKZM0 | | | | | | |
| Integrated N and PE terminals; lower section without knockouts | | | | | | |
|  | With black-grey rotary knob IP55 | PKZM0-... +NHI or U or A +NHI-E +L-PKZ0 (2 parts) | CI-K2-PKZ0-NA-G 262680 | | 1 off   | |
|  | With red-yellow rotary knob, for use as emergency switching off device to EN 60204 IP55 | | CI-K2-PKZ0-NA-GR 262681 | | 1 off   | |
| For Motor-protective circuit-breakers PKZM0 with early-make auxiliary contacts | | | | | | |
| Integrated N and PE terminals; lower section without knockouts | | | | | | |
|  | With black-grey rotary knob IP55 | PKZM0-... +VHI... + U... +L-PKZ0 (2 parts) | CI-K2-PKZ0-NA-GV 262682 | | 1 off   | |
|  | With red-yellow rotary knob, for use as emergency switching off device to EN 60204 IP55 | | CI-K2-PKZ0-NA-GRV 262683 | | 1 off   | |

SVB-PKZ, CL/EPKZ01

| | Degree of protection | For use with | Part no. Article no. | Price See price list | Std. pack | Information relevant for export to North America  |
|---|--|--------------|---|------------------------------------|---|--|
| Insulated enclosures, accessories | | | | | | |
| Padlocking feature | | | | | | |
| For up to 3 padlocks with 3 – 6 mm hasp thickness, for use as main switch to IEC/EN60204 | | | | | | |
|  | Lockable in the 0-position of the PKZM0 or Motor-protective circuit-breaker PKZM4. | – | CI-K2-PKZ0-G(R)(V) CI-PKZ0-G(R)(V)M | SVB-PKZ0-CI 035129 | 3 off  | Product Standards UL 508; CSA-C22.2 No.14; IEC60947-4-1; CE marking |
| | – | – | E-PKZ0-G(R) | SVB-PKZ0-E 035127 | 3 off  | UL File No. UL CCN CSA File No. CSA Class No. NA Certification E36332 NLRV 12528 3211-05 UL Listed, CSA certified |
| | – | – | CI-K4-PKZ4-G(R) | SVB-PKZ4-CI 225526 | 1 off | |
| Neutral terminal | | | | | | |
| For connection of a 5th conductor | | | | | | |
|  | Flexible, 1 - 4 mm ² | – | CI-K2-PKZ0-... | K-CI-K1/2 207451 | 20 off  | UL/CSA certification not required |
| | 63 A, flexible, 6 - 16 mm ² | – | CI-K4-PKZ4-G(R) | K25/1 096200 | 10 off | |
|  | – | – | E-PKZ0(-G)(-GR) E-PKZ01(-G) | N-PKZ0 082160 | 20 off | |
| Units for insulated enclosures for PKZ01 | | | | | | |
| Combinable with CI-PKZ01-X and E-PKZ01-X. | | | | | | |
|  | With operating membrane | Front IP65 | PKZM01 +NHI-E or VHI-PKZ01 +U or A or NHI +L (2 off) | CI/E-PKZ01-XG 289936 | 1 off | |
|  | Lockable in Off position | Front IP65 | PKZM01 +NHI-E +U or A +L (2 off) | CI/E-PKZ01-XSVB 289939 | 1 off | |
|  | With emergency switching off mushroom button, maintained | Front IP65 | PKZM01 +NHI-E or VHI-PKZ01 +U or A +L (2 off) | CI/E-PKZ01-XPVT 289937 | 1 off | |
| | With emergency switching off mushroom button, with key-release | Front IP65 | PKZM01 +NHI-E or VHI-PKZ01 +U or A +L (2 off) | CI/E-PKZ01-XPVS 289938 | 1 off | |
|  | Lockable in Off position, in combination with VHI-PKZ01 | Front IP65 | PKZM01 VHI-PKZ01 +U or A +L (2 off) | CI/E-PKZ01-XSVB-V 289980 | 1 off | |

1.3

Motor-protective circuit-breakers PKZM01, PKZM0, PKZM4, PKE Accessories

1

Accessories

Metric cable glands to EN 50262

- With lock nut and built-in strain relief
- IP68 up to 5 bar, halogen free

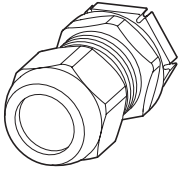

Metric diaphragm grommets



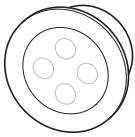

















- IP66
- With integral push-through diaphragm



| Cable entry | Drilling dimensions mm | External cable diameter mm | Part no. Article no. | Price See price list | Std. pack |
|-------------|---------------------------|-------------------------------|-------------------------|-------------------------|-----------|
| M20 | 20.5 | 6 - 13 | V-M20 206910 | | 20 off |
| M25 | 25.5 | 9 - 17 | V-M25 206911 | | 20 off |
| M32 | 32.5 | 13 - 21 | V-M32 206912 | | 10 off |
| M32 | 32.5 | 18 - 25 | V-M32G 226156 | | 10 off |
| M20 | 20.5 | 1 - 13 | KT-M20 207602 | | 100 off |
| M25 | 25.5 | 1 - 18 | KT-M25 207603 | | 100 off |
| M32 | 32.5 | 1 - 25 | KT-M32 207604 | | 100 off |

Door coupling handles
Degree of protection IP65, UL/CS Type 4X / Type12



| | For use with | Part no. Article no. | Price See price list | Std. pack | Notes |
|--|--------------|-------------------------|--|--|--|
| For use as main switch to IEC/EN 60204 | Black | PKZM0 PKZM4 | PKZ0-XH¹⁾ 106132 | 1 off   | Pluggable PKZ0-XAH extension shaft, can be cut to any required length for installation depths of 100...240 mm. Follower included in delivery. With ON/OFF switch position and "+" (tripped), lockable. With 3 padlocks, 4 – 8 mm hasp. Cannot be used in combination with VH20-PKZ0. |
| For use as a main switch with emergency switching off function to EN 60204 | Red-yellow | PKZM0 PKZM4 | PKZ0-XRH¹⁾ 106133 | 1 off   | |
| For use as a main switch to EN 60204 in MCC power distribution systems and with PKZM0 installed rotated by 90° | Black | PKZM0 PKZM4 | PKZ0-XH-MCC¹⁾ 106136 | 1 off   | |
| For use as a main switch with emergency switching off function to EN 60204 in MCC power distribution systems and with PKZM0 installed rotated by 90° | Red-yellow | PKZM0 PKZM4 | PKZ0-XRH-MCC¹⁾ 106137 | 1 off   | |
| For use as main switch to IEC/EN 60204 | Black | PKE | PKE-XH¹⁾ 142416 | 1 off   | |
| For use as a main switch with emergency switching off function to EN 60204 | Red-yellow | PKE | PKE-XRH¹⁾ 142417 | 1 off   | |
| For use as a main switch to EN 60204 in MCC power distribution systems and with PKE installed rotated by 90° | Black | PKE | PKE-XH-MCC¹⁾ 142418 | 1 off   | |
| For use as a main switch with emergency-switching off function to EN 60204 in MCC power distribution systems and with PKE installed rotated by 90° | Red-yellow | PKE | PKE-XRH-MCC¹⁾ 142419 | 1 off   | |
| For increasing the degree of protection of the PKZM4 to IP2X | – | PKZM4 | HB-PKZ4²⁾ 256581 | 1 off   | |
| – | – | PKZM0 PKZM4 | PKZ0-XAH¹⁾ 106134 | 1 off   | |

Information relevant for export to North America  

| | |
|---------------------------------|---|
| ¹⁾ Product Standards | UL 508; CSA-C22.2 No.14; IEC60947-4-1; CE marking |
| UL File No. | E36332 |
| UL CCN | NLRV |
| CSA File No. | 12528 |
| CSA Class No. | 3211-05 |
| NA Certification | UL Listed, CSA certified |
| Degree of Protection | IEC: IP65, UL/CSA Type: 4X, 12 |

| | |
|---------------------------------|---|
| ²⁾ Product Standards | UL 508; CSA-C22.2 No.14; IEC60947-4-1; CE marking |
| UL File No. | E36332 |
| UL CCN | NLRV |
| CSA File No. | 12528 |
| CSA Class No. | 3211-05 |
| NA Certification | UL Listed, CSA certified |

Accessories

Telescopic adapters With 45 mm top-hat rail to IEC/EN 60715 for compensation of the mounting depth of rear-mounted devices enclosures CI-K and cabinets

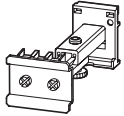

| Notes | Part no. Article no. | Price See price list | Std. pack | Information relevant for export to North America |
|--|-------------------------|-------------------------|-----------|---|
| Telescopic clip Stepless adjustment via scale from 75 – 115 mm. | M22-TA 226161 | | 1 off | Product Standards IEC/EN60947-5; UL 508; CSA-C22.2 No.14-05; CSA-C22.2 No.94-91; CE marking E29184 UL File No. UL CCN CSA File No. 012528 CSA Class No. 3211-03 NA Certification UL Listed, CSA certified |

Lockable rotary handle



| | | | | |
|---|------------------------------------|--------------------------|-----------|--|
| For locking motor-protective circuit-breakers PKZM0, PKZM4 and PKE as a main switch in compliance with EN 60204. Can be padlocked in the "0" position. Hasp thickness: 3 – 6.35 mm | Can not be combined with VHI-PKZ0. | AK-PKZ0 030851 | 5 off | Product Standards UL 508; CSA-C22.2 No.14; IEC/EN 60947-4-1; CE marking E36332 UL File No. NLRV UL CCN CSA File No. 12528 CSA Class No. 3211-05 NA Certification UL Listed, CSA certified |
|---|------------------------------------|--------------------------|-----------|--|

Holding facility

| | | | | |
|---|---|--------------------------|-------|--|
| To prevent tampering with the overload release and the test function, it can be sealed using industry standard sealing wire For use with motor-protective circuit-breakers PKZM0 and PKZM4 | – | PL-PKZ0 203599 | 5 off | |
|---|---|--------------------------|-------|--|

Mounting angle bracket



| | | | | |
|------------------------------------|---|----------------------------|------------|--|
| For screw fixing to mounting plate | – | PKE32-XMB 134837 | 20 off | Product Standards UL 508; CSA-C22.2 No.14; IEC/EN 60947-4-1; CE marking NA Certification Request filed for UL and CSA |
|------------------------------------|---|----------------------------|------------|--|

Documentation

| | | | | |
|---|----------------|------------------------------------|-------|--|
| Motor-protective circuit-breakers PKZM0, overload monitoring of EEx e motors | German/English | AWB1210-1458D/GB 266164 | 1 off | |
| Motor-protective circuit-breakers PKZM4, overload monitoring of EEx e motors | German/English | AWB1210-1457D/GB 266165 | 1 off | |
| Motor-protective circuit-breakers PKE, EEx electric motor overload monitoring | German/English | AWB1210-1631DE/EN 134836 | 1 off | |

Indicator lights with glow lamp



| For use with Color Voltage | Color | Voltage U_s V | Part no. Article no. | Price See price list | Std. pack |
|---|-------|-----------------------|----------------------------------|-------------------------|-----------|
| CI-K2-PKZ0-..., CI-K4-PKZ4, CI-PKZ0(1), E-PKZ0(1) | White | 110 - 230 | L-PKZ0(230V) 082151 | | 10 off |
| CI-K2-PKZ0-..., CI-K4-PKZ4, CI-PKZ0(1), E-PKZ0(1) | White | 230 - 400 | L-PKZ0(400V) 082152 | | 10 off |
| CI-K2-PKZ0-..., CI-K4-PKZ4, CI-PKZ0(1), E-PKZ0(1) | White | 415 - 500 | L-PKZ0(500V) 082153 | | 5 off |
| CI-K2-PKZ0-..., CI-K4-PKZ4, CI-PKZ0(1), E-PKZ0(1) | Green | 110 - 230 | L-PKZ0-GN(230V) 082154 | | 10 off |
| CI-K2-PKZ0-..., CI-K4-PKZ4, CI-PKZ0(1), E-PKZ0(1) | Green | 230 - 400 | L-PKZ0-GN(400V) 082155 | | 10 off |
| CI-K2-PKZ0-..., CI-K4-PKZ4, CI-PKZ0(1), E-PKZ0(1) | Green | 415 - 500 | L-PKZ0-GN(500V) 082156 | | 5 off |
| CI-K2-PKZ0-..., CI-K4-PKZ4, CI-PKZ0(1), E-PKZ0(1) | Red | 110 - 230 | L-PKZ0-RT(230V) 082157 | | 10 off |
| CI-K2-PKZ0-..., CI-K4-PKZ4, CI-PKZ0(1), E-PKZ0(1) | Red | 230 - 400 | L-PKZ0-RT(400V) 082158 | | 10 off |

1.3









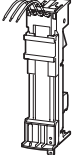

Motor-protective circuit-breakers PKZM01, PKZM0, PKZM4, PKE

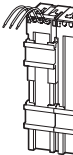
Busbar adapters

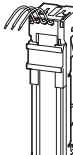
Busbar adapters for PKZ and PKE

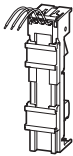
Approved to **UL508**.

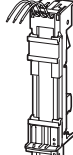
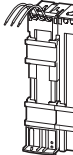
For fitting to flat copper busbars with 60mm between busbar centers, suitable for 5 mm and 10 mm busbar thickness.

| Rated operational voltage U_e V | Conductor cross-section | Adapter width mm | Mounting rails Number | For use with | Part no. Article no. | Price See price list | Std. pack | Notes | | | | |
|---|--|--|---|--|--|---|--|--|--|--|---|--|
| Rated operational current 16 A For starters with spring-loaded terminals  | 690 | AWG 14 (2.5 mm ²) | 45 | 2 | PKZM0-C + DILMC7 PKZM0-C + DILMC9 PKZM0-C + DILMC12 | BBA0C-16 101455 | 4 off   | According to UL 508: $I_e = 12$ A | | | | |
| | Rated operational current 25 A For reversing starters  | 690 | AWG 12 (4 mm ²) | 90 | 1 | PKZM0, PKE + 2 x DILM7-01 PKZM0, PKE + 2 x DILM9-01 PKZM0, PKE + 2 x DILM12-01 MSC-R-0,25-M7... - MSC-R-12-M12... | BBA0R-25 101453 | 2 off   | In combination with individual components PKZM0 and DILM, use reversing starter kit PKZM0-XRM12. Fully assembled and tested combination with MSC-R → Chapter 1.4 (Page 18) Only busbar adapters/wiring sets manufactured on or after CW35/2009 can be used for PKE. | | | |
| | | Can be used universally  | 690 | AWG 12 (4 mm ²) | 45 | 2 | — | BBA0-25/2TS 101481 | 4 off   | Mounting rails can be moved within 1.25 mm grid. | | |
| | | | For DOL starters  | 690 | AWG 12 (4 mm ²) | 45 | 1 | PKZM0, PKE + 2 x DILM17-01 PKZM0, PKE + 2 x DILM25-01 PKZM0, PKE + 2 x DILM25-01 PKZM0, PKE + 2 x DILM32-01 MSC-R-16-M17... MSC-R-32-M32... | BBA0-25 101451 | 4 off   | In combination with individual components PKZM0 and DILM, use DOL starter kit PKZM0-XRM12. Fully assembled and tested combination with MSC-D → Chapter 1.4 (Page 2) Only busbar adapters/wiring sets manufactured on or after CW35/2009 can be used for PKE. | |
| | | | | For soft starters  | 690 | AWG 12 (4 mm ²) | 45 | 1 | PKZM0, PKE + DS7...004N... PKZM0, PKE + DS7...007N... PKZM0, PKE + DS7...009N... PKZM0, PKE + DS7...012N... | BBA0L-25 142526 | 1 off | — |
| | | | | | Rated operational current 32 A For reversing starters  | 690 | AWG 10 (6 mm ²) | 90 | 3 | PKZM0, PKE + 2 x DILM17-01 PKZM0, PKE + 2 x DILM25-01 PKZM0, PKE + 2 x DILM32-01 MSC-R-16-M17... - MSC-R-32-M32... | BBA0R-32 101454 | 2 off   |

Information relevant for export to North America



Product Standards

UL File No.
UL CCN







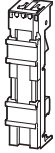

UL 508A; CSA-C22.2 No. 14;
IEC60439-1; CE marking
UL File No.E300273
NMTR, NMTRZ

CSA File No.

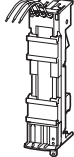
CSA Class No.
NA Certification
Max. Voltage Rating

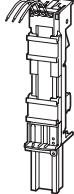
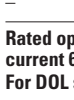
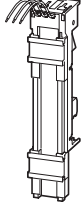
232140

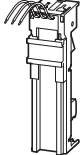
3211-37
UL Listed, CSA certified
600 V AC

| | Rated operational voltage U_e V | Conductor cross-section | Adapter width mm | Mounting rails Number | For use with | Part no. Article no. | Price See price list | Std. pack | Notes |
|--|---|--------------------------------|---------------------|--------------------------|---|---|-------------------------|--|---|
| Rated operational current 32 A Can be used universally.  | 690 | – | 45 | 2 | PKZM0..., PKE + DILM... | BBA0-32/2TS-C²⁾ 116708 | | 4 off  | Universal adapter 1-, 2- and 3-phase applications. Mounting rail can be moved within 1.25 mm grid. For conductor cross-sections, round conductors of up to 6 mm ² . Only busbaradapters/wiring sets manufactured on or after CW 35/2009 can be used for PKE. |
| For DOL starters.  | 690 | AWG 10 (6 mm ²) | 45 | 2 | PKZM0, PKE + DILM17 PKZM0, PKE + DILM25 PKZM0, PKE + DILM32 MSC-D-16-M17... - MSC-D-32-M32... | BBA0-32¹⁾ 101452 | | 4 off  | In combination with individual components PKZM0 and DILM wiring kit PKZM0-XM32DE can be used. Fully assembled and tested combination with MSC-D → Chapter 1.4 (Page 2) Only busbar adapters/wiring sets manufactured on or after CW35/2009 can be used for PKE. |
| For soft starters  | 690 | AWG 10 (6 mm ²) | 45 | 2 | PKZM0, PKE + DS7...016N... PKZM0, PKE + DS7...024N... PKZM0, PKE + DS7...032N... | BBA0L-32 142527 | | 1 off | – |
| For 160 mm adapter system with motor-protective circuit-breakers  | 690 | AWG 10 (6 mm ²) | 45 | 1 | PKZM0, PKE | BBA0K-32 142528 | | 1 off | – |
| Rated operational current 63 A For DOL starters.  | 690 | AWG 8 (10 mm ²) | 55 | 2 | PKZM4 + DILM17 PKZM4 + DILM25 PKZM4 + DILM32 PKZM4 + DILM40 PKZM4 + DILM50 PKZM4 + DILM65 | BBA4-63¹⁾ 101459 | | 4 off  | The following can be used to establish an electrical connection: For PKZM4 + DILM17 to DILM32: MVS-LB0-0M-G For PKZM4 + DILM40 to DILM65: PKZM4-XM65DE. |
| For motor-protective circuit-breakers  | 690 | AWG 8 (10 mm ²) | 54 | 1 | PKZM4 | BBA4-63¹⁾ 101457 | | 4 off  | – |

Information relevant for export to North America



1)
 Product Standards UL 508; CSA-C22.2 No.14; IEC60439-1; CE marking
 UL File No. E300273
 UL CCN NMTR, NMTR7
 CSA File No. 232140
 CSA Class No. 3211-37
 NA Certification UL Listed, CSA certified
 Max. Voltage Rating 600 V AC

2)
 Product Standards UL 508; CSA-C22.2 No.14; IEC60439-1; CE marking
 UL File No. E300273
 UL CCN NMTR, NMTR7
 NA Certification UL Listed, CSA certified
 Max. Voltage Rating 600 V AC











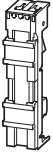





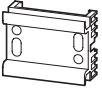

1.3

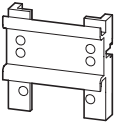
Motor-protective circuit-breakers PKZM01, PKZM0, PKZM4, PKE

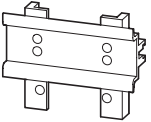
Busbar adapters

1

BBA, PKZM0-XM

| | Rated operational voltage U_e V | Conductor cross-section | Adapter width mm | Mounting rails Number | For use with | Part no. Article no. | Price See price list | Std. pack | Notes |
|--|---|-------------------------|---------------------|--------------------------|--------------|--|-------------------------|---|---|
| Without electrical contacts Empty module.  | – | – | 45 | 2 | – | BBA0/ZTS-L¹⁾ 101482 | | 4 off   | Mounting rails can be moved within a 1.25 mm grid. Can be used to mount reversing and star-delta starters. |
| | – | – | 54 | 2 | – | BBA4/ZTS-L¹⁾ 101483 | | 4 off   | Mounting rails can be moved within a 1.25 mm grid. Can be used to mount reversing and star-delta starters. |
| Side-mounted module, can be attached on both sides.  | – | – | 9 | – | – | BBA-XSM¹⁾ 101484 | | 10 off   | Can be grouped with busbar adapters in order to extend the mounting width. |
| Busbar adapters accessories Mounting rails  | – | – | 45 | – | BBA... | PKZM0-XMR²⁾ 239364 | | 10 off   | – |
| Busbar adapters accessories Mounting rails  | – | – | 54 | – | BBA... | PKZM0-XMR54²⁾ 113911 | | 10 off   | – |
| Busbar adapters accessories Mounting rails  | – | – | 72 | – | BBA... | PKZM0-XMR72²⁾ 113912 | | 10 off   | – |
| Connecting cable – | – | – | – | – | BBA... | BBA-XLT-6-130³⁾ 116902 | | 30 off   | – |
| | – | – | – | – | BBA... | BBA-XLT-16-142³⁾ 116903 | | 30 off   | – |

Information relevant for export to North America



1)

| | |
|---------------------|--|
| Product Standards | UL 508A; CSA-C22.2 No.14; IEC60439-1; CE marking |
| UL File No. | E300273 |
| UL CCN | NMTR, NMTR7 |
| CSA File No. | 232140 |
| CSA Class No. | 3211-37 |
| NA Certification | UL Listed, CSA certified |
| Max. Voltage Rating | 600 V AC |

2)

| | |
|-------------------|--|
| Product Standards | UL 508A; CSA-C22.2 No.14; IEC60947-4-1; CE marking |
| UL File No. | E300273 |
| UL CCN | NMTR, NMTR7 |
| CSA File No. | 232140 |
| CSA Class No. | 3211-37 |
| NA Certification | UL Listed, CSA certified |

3)

| | |
|-------------------|--|
| Product Standards | UL 508A; CSA-C22.2 No.14; IEC60439-1; CE marking |
| UL File No. | On request |
| UL CCN | On request |
| CSA File No. | On request |
| CSA Class No. | On request |
| NA Certification | UL Recognized, CSA certified |

Wiring set

For use with

Part no.
Article no.

Price
See price list

Std. pack

Notes

1

DOL starter

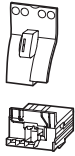

PKZM0, PKE + DILM7
PKZM0, PKE + DILM9
PKZM0, PKE + DILM12
PKZM0, PKE + DILM15
DS7-34...SX004...
DS7-34...SX007...
DS7-34...SX009...
DS7-34...SX012...

PKZM0-XDM12
283149

1 off

Consists of:

- Mechanical connection element for PKZM0 and contactor
- Main supply wiring between PKZM0 and contactor with tool-less plug connection
- Cable routing

As auxiliary contact, use DILA-XHIT... → Chapter 1.1 (Page 38)
Cannot be combined with NHI-E...PKZ0-C.
 $U_e \leq 415 V^1)$

DOL starter

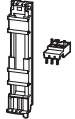

PKZM0, PKE + DILM17
PKZM0, PKE + DILM25
PKZM0, PKE + DILM32

PKZM0-XDM32
283153

1 off

Consists of:

- Top-hat rail adapter plates
- Power supply wiring between PKZ and contactor¹⁾

PKZM4 + DILM40
PKZM4 + DILM50
PKZM4 + DILM65

PKZM4-XDM65
101053

1 off

Reversing starters

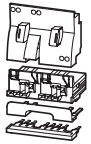

PKZM0, PKE + DILM7-01
PKZM0, PKE + DILM9-01
PKZM0, PKE + DILM12-01

PKZM0-XRM12
283185

1 off

Consists of:

- Mechanical connection element for PKZM0 and contactor
- Reversing starters main supply wiring with tool-less plug connection
- Control cables for electrical interlocking in tool-less plug connection:
 - K1M: A1 -K2M: 21
 - K1M: 21 -K2M: A1
 - K1M: A2 -K2M: A2
- Cable routing

As auxiliary contact DILA-XHIT...use → Chapter 1.1 (Page 38)
Can not be combined with AGM PKZ0.
 $U_e \leq 415 V^1)$

Reversing starters

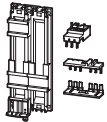

PKZM0, PKE + DILM17
PKZM0, PKE + DILM25
PKZM0, PKE + DILM32

PKZM0-XRM32
283189

1 off

Consists of:

- Top-hat rail adapter plates
- Reversing starters supply wiring¹⁾

Wiring kit



PKZM0, PKE + DILM17
PKZM0, PKE + DILM25
PKZM0, PKE + DILM32
DS7-34...SX016...
DS7-34...SX024...
DS7-34...SX032...

PKZM0-XM32DE
239349

5 off

• Main supply wiring between PKZM0 and contactor
• Use only in combination with busbar adapter or mounting rail adapter plate

PKZM4 + DILM40
PKZM4 + DILM50
PKZM4 + DILM65

PKZM4-XM65DE
101056

5 off

• Main current supply between PKZM4 and contactor

Top-hat rail adapter plates



PKZM0-XDM12
PKZM0-XRM12

PKZM0-XC45
283132

4 off

Consists of:

- 45 mm wide adapter plate
- Connection element for side-by-side positioning of further plates¹⁾

Top-hat rail adapter plates

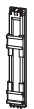

PKZM4 + DILM40
PKZM4 + DILM50
PKZM4 + DILM65

PKZM4-XC55/2
101054

4 off

Consists of:

- 55 mm wide adapter plate
- Connection cam for additional plates¹⁾
- For use with reversing and start-delta starters

Soft starters



PKZM0, PKE + DS7...004N...
PKZM0, PKE + DS7...007N...
PKZM0, PKE + DS7...009N...
PKZM0, PKE + DS7...012N...

PKZM0-XC45L
142529

1 off

Consists of:

- 45 mm wide adapter plate

Soft starters

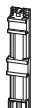

PKZM0, PKE + DS7...016N...
PKZM0, PKE + DS7...024N...
PKZM0, PKE + DS7...032N...

PKZM0-XC45L/2
142570

1 off

Consists of:

- 45 mm wide adapter plate

Notes

¹⁾ Use only busbar adapters/wiring sets manufactured on or after CW35/2009 for PKE.

Information relevant for export to North America

²⁾
Product Standards UL 508; CSA-C22.2 No.14; IEC60947-4-1;
CE marking
UL File No. E36332
UL CCN NLRV
CSA File No. 12528
CSA Class No. 3211-05
NA Certification UL Listed, CSA certified

³⁾
UL/CSA certification not required

⁴⁾
Product Standards UL 508; CSA-C22.2 No.14;
IEC60947-4-1; CE marking
UL File No. E300273
UL CCN NMTR, NMTR7
NA Certification UL Listed, CSA certified
Max. Voltage Rating 600 V AC

1.3

Motor-protective circuit-breakers PKZM01, PKZM0, PKZM4, PKE

Motor feeder plugs, three-phase commoning links

1

| Description | For use with | Part no. Article no. | Price See price list | Std. pack | Notes | Information relevant for export to North America |
|---|---|-------------------------|--|---------------------------------------|---|---|
| | PE module with contact plate | | | | | |
| DILM(C)7 DILM(C)9 DILM(C)12 DILM(C)15 | DILM12-XMCE 121764 | 5 off | 35 x 7.5 (15) mm mounting rail (as per DIN EN 60715) with PE function required. For connection of: PE 0.75 – 4 mm ² | Product Standards NA Certification | UL 508; CSA-C22.2 No. 14; IEC60947-4-1; CE marking Request filed for UL and CSA | |
| | Motor feeder plug with PE module and contact plate | | | | | |
| DILM(C)7 DILM(C)9 DILM(C)12 DILM(C)15 | DILM12-XMCP/E 121769 | 1 off | 35 x 7.5 (15) mm mounting rail (as per DIN EN 60715) with PE function required. For connection of: L1, L2, L3, PE 0.75 – 2.5 mm ² | Product Standards NA Certification | IEC/EN 60947-4-1; UL 508; CSA-C22.2 No. 14-05; CE marking Request filed for UL and CSA | |
| | Motor feeder plug with PE module without contact plate | | | | | |
| PKZM0/PKE + DILM(C)7 PKZM0/PKE + DILM(C)9 PKZM0/PKE + DILM(C)12 PKZM0/PKE + DILM(C)15 MSC-D(E)-...-M7... MSC-D(E)-...-M9... MSC-D(E)-...-M15... | DILM12-XMCP/T 121770 | 1 off | For connection of: L1, L2, L3, PE 0.75 – 2.5 mm ² | Product Standards NA Certification | IEC/EN 60947-4-1; UL 508; CSA-C22.2 No. 14-05; CE marking Request filed for UL and CSA | |

Three-phase commoning links, incoming unit via terminals 1, 3, and 5

Finger- and back-of-hand-proof, short-circuit proof, $U_e=690\text{ V}$, $I_n=63\text{ A}$
Can be extended through rotated installation

| Circuit-breakers Number | Length mm | Unit width mm | Part no. Article no. | Price See price list | Std. pack | Notes |
|---|--------------|------------------|-------------------------|---|------------|---|
| For PKZM0-... or PKE without side-mounted auxiliary contacts or voltage releases | | | | | | |
| | 2 | 90 | 45 | B3.0/2-PKZ0¹⁾ 063961 | 10 off | For parallel feeding of multiple motor-protective circuit-breakers on terminals 1, 3, and 5 |
| | 3 | 135 | 45 | B3.0/3-PKZ0¹⁾ 232289 | 10 off | |
| | 4 | 180 | 45 | B3.0/4-PKZ0¹⁾ 063960 | 10 off | |
| | 5 | 225 | 45 | B3.0/5-PKZ0¹⁾ 232290 | 10 off | |
| For motor-protective circuit-breakers with one auxiliary contact or trip-indicating auxiliary contact each fitted to right side | | | | | | |
| | 2 | 99 | 45 + 9 | B3.1/2-PKZ0¹⁾ 044945 | 10 off | For parallel feeding of multiple motor-protective circuit-breakers on terminals 1, 3, and 5 |
| | 3 | 153 | 45 + 9 | B3.1/3-PKZ0¹⁾ 044946 | 10 off | |
| | 4 | 207 | 45 + 9 | B3.1/4-PKZ0¹⁾ 044947 | 10 off | |
| | 5 | 261 | 45 + 9 | B3.1/5-PKZ0¹⁾ 044948 | 10 off | |
| For PKZM0-... or PKE with one auxiliary contact or trip-indicating auxiliary contact each fitted to right side, or one voltage release fitted on left side | | | | | | |
| | 2 | 108 | 45 + 18 | B3.2/2-PKZ0¹⁾ 063963 | 10 off | For parallel feeding of multiple motor-protective circuit-breakers on terminals 1, 3, and 5 |
| | 4 | 234 | 45 + 18 | B3.2/4-PKZ0¹⁾ 063959 | 10 off | |

Information relevant for export to North America



1)
Product Standards
UL File No.
UL CCN
CSA File No.
CSA Class No.
NA Certification

UL 508A; CSA-C22.2 No.14; IEC60947-4-1; CE marking
E36332
NLRV
98494
3211-06
UL Listed, CSA certified

HB3...PKZO, BK...I3-PKZ

| Circuit-breakers | For use with | Unit width | Part no. Article no. | Price See price list | Std. pack | Notes |
|------------------|--------------|------------|-------------------------|-------------------------|-----------|-------|
|------------------|--------------|------------|-------------------------|-------------------------|-----------|-------|

| Number | mm |
|--------|----|
|--------|----|

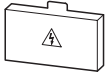

Shroud for unused terminals

Protection against direct contact.

For covering unused terminals on three-phase commoning link B3...-PKZO

| | | | | | | |
|---|---|---|---|--|------------|---|
| - | - | - | H-B3-PKZO¹⁾ 032721 | | 20 off | - |
|---|---|---|---|--|------------|---|

Incoming terminals

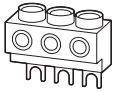

| | | | | | | |
|---|--------------|---|---|--|-----------|---|
| - | PKZM0 PKE | - | BK25/3-PKZO²⁾ 032720 | | 5 off | For three-phase commoning link, protected against accidental contact, $U_e = 690\text{ V}$, $I_u = 63\text{ A}$ For conductor cross-sections: 2.5 - 25 mm ² stranded 2.5 - 16 mm ² flexible with ferrule AWG 14 - 6, usable on terminals 1, 3, and 5 |
|---|--------------|---|---|--|-----------|---|

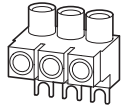

| | | | | | | |
|---|-------|---|---|--|-----------|--|
| - | PKZM0 | - | BK25/3-PKZO-E³⁾ 262518 | | 5 off | For three-phase commoning link, protected against accidental contact, $U_e = 690\text{ V}$, $I_u = 60\text{ A}$ For conductor cross-sections: 2.5 - 25 mm ² stranded 2.5 - 16 mm ² flexible with ferrule AWG 14 - 6 For assembly of Type E starters. |
|---|-------|---|---|--|-----------|--|

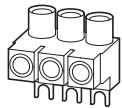

| | | | | | | |
|---|-------|---|---|--|-----------|--|
| - | PKZM4 | - | BK50/3-PKZ4-E⁴⁾ 272165 | | 1 off | Can be combined with three-phase commoning link B3...PKZ4. $I_u = 120\text{ A}$. For assembly of Type E starters. |
|---|-------|---|---|--|-----------|--|

Information relevant for export to North America



1)

| | |
|-------------------|--|
| Product Standards | UL 508; CSA-C22.2 No.14; IEC60947-4-1; CE marking |
| UL File No. | E36332 |
| UL CCN | NLRV |
| CSA File No. | 98494 |
| CSA Class No. | 3211-06 |
| NA Certification | UL Listed, CSA certified |

2)

| | |
|-------------------|--|
| Product Standards | UL 508; CSA-C22.2 No.14; IEC60947-4-1; CE marking |
| UL File No. | E36332 |
| UL CCN | NLRV |
| CSA File No. | 12528 |
| CSA Class No. | 3211-05 |
| NA Certification | UL Listed, CSA certified |

3)

| | |
|--|--|
| Product Standards | UL 508; CSA-C22.2 No.14; IEC60947-4-1; CE marking |
| UL File No. | E36332 |
| UL CCN | NLRV |
| CSA File No. | 98494 |
| CSA Class No. | 3211-06 |
| NA Certification | UL Listed, CSA certified |
| Specially designed for NA Suitable for | ✓ PKZM0/PKE, line terminal required for Type E/F applications |

4)

| | |
|--|--|
| Product Standards | UL 508; CSA-C22.2 No.14; IEC60947-4-1; CE marking |
| UL File No. | E36332 |
| UL CCN | NLRV |
| CSA File No. | 12528 |
| CSA Class No. | 3211-06 |
| NA Certification | UL Listed, CSA certified |
| Specially designed for NA Suitable for | ✓ PKZM4/PKE, line terminal required for Type E/F applications |

1.3

Motor-protective circuit-breakers PKZM01, PKZM0, PKZM4, PKE Three-phase commoning links

1

Three-phase commoning links

Finger- and back-of-hand-proof, short-circuit proof $U_p=690\text{ V}$, $I_p=128\text{ A}$

| Circuit-breakers | Length | Unit width | Part no. | Price | Std. pack |
|------------------|--------|------------|-------------|----------------|-----------|
| Number | mm | mm | Article no. | See price list | |

Information relevant for export to North America



For PKZM4 without side-mounted auxiliary contacts or voltage releases

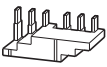

| | | | | | |
|---|-----|----|------------------------------|-------|--|
| 2 | 110 | 55 | B3.0/2-PKZ4 220220 | 1 off | |
|---|-----|----|------------------------------|-------|--|



| | | | | | |
|---|-----|----|------------------------------|-------|--|
| 3 | 165 | 55 | B3.0/3-PKZ4 220221 | 1 off | |
|---|-----|----|------------------------------|-------|--|

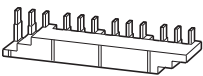

| | | | | | |
|---|-----|----|------------------------------|-------|--|
| 4 | 220 | 55 | B3.0/4-PKZ4 220222 | 1 off | |
|---|-----|----|------------------------------|-------|--|

For PKZM4 with one auxiliary contact or trip-indicating auxiliary contact each fitted on the right side



| | | | | | |
|---|-----|--------|------------------------------|-------|--|
| 2 | 119 | 55 + 9 | B3.1/2-PKZ4 220223 | 1 off | |
|---|-----|--------|------------------------------|-------|--|

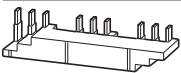

| | | | | | |
|---|-----|--------|------------------------------|-------|--|
| 3 | 183 | 55 + 9 | B3.1/3-PKZ4 220224 | 1 off | |
|---|-----|--------|------------------------------|-------|--|

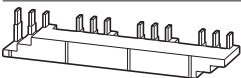

| | | | | | |
|---|-----|--------|------------------------------|-------|--|
| 4 | 247 | 55 + 9 | B3.1/4-PKZ4 220225 | 1 off | |
|---|-----|--------|------------------------------|-------|--|

For PKZM4 with one auxiliary contact or trip-indicating auxiliary contact each fitted to right side, or one voltage release fitted to left side



| | | | | | |
|---|-----|---------|------------------------------|-------|--|
| 2 | 128 | 55 + 18 | B3.2/2-PKZ4 220226 | 1 off | |
|---|-----|---------|------------------------------|-------|--|

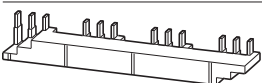

| | | | | | |
|---|-----|---------|------------------------------|-------|--|
| 4 | 274 | 55 + 18 | B3.2/4-PKZ4 220227 | 1 off | |
|---|-----|---------|------------------------------|-------|--|



Shroud for unused terminals

Protection against direct contact.
To cover unused terminals on three-phase commoning link

| Circuit-breakers | Length | Unit width | Part no. | Price | Std. pack |
|------------------|--------|------------|-------------|----------------|-----------|
| Number | mm | mm | Article no. | See price list | |

























































Information relevant for export to North America



| | | | | | |
|---|---|---|----------------------------|--------|--|
| – | – | – | H-B3-PKZ4 220228 | 10 off | |
|---|---|---|----------------------------|--------|--|

Product Standards UL 508; CSA-C22.2 No.14; IEC60947-4-1; CE marking
UL File No. E36332
UL CCN NLRV
CSA File No. 12528
CSA Class No. 3211-06
NA Certification UL Listed, CSA certified

A-PKZO, U-PKZO

| Actuating voltage | Part no. Article no. | Price See price list | Std. pack | Part no. Article no. | Price See price list | Std. pack | Notes |
|--|--|-------------------------|--|--|-------------------------|--|--|
| Shunt release, undervoltage release | | | | | | | |
| AC | | | | | | | |
| Standard voltage | | | | | | | |
| 24 V 50 Hz | A-PKZO(24V50Hz)¹⁾ 073181 | | 2 off   | U-PKZO(24V50Hz)¹⁾ 073129 | | 2 off   | |
| 110 V 50 Hz | A-PKZO(110V50Hz)¹⁾ 073184 | | 2 off   | U-PKZO(110V50Hz)¹⁾ 073132 | | 2 off   | |
| 220 V 50 Hz | A-PKZO(220V50Hz)¹⁾ 073186 | | 2 off   | U-PKZO(220V50Hz)¹⁾ 073134 | | 2 off   | |
| 230 V 50 Hz | A-PKZO(230V50Hz)¹⁾ 073187 | | 2 off   | U-PKZO(230V50Hz)¹⁾ 073135 | | 2 off   | Only A(U)-PKZO... with serial number 02 or higher can be fitted |
| 240 V 50 Hz | A-PKZO(240V50Hz)¹⁾ 073188 | | 2 off   | U-PKZO(240V50Hz)¹⁾ 073136 | | 2 off   | |
| 380 V 50 Hz | A-PKZO(380V50Hz)¹⁾ 073189 | | 2 off   | U-PKZO(380V50Hz)¹⁾ 073137 | | 2 off   | |
| 400 V 50 Hz | A-PKZO(400V50Hz)¹⁾ 073190 | | 2 off   | U-PKZO(400V50Hz)¹⁾ 073138 | | 2 off   | |
| 415 V 50 Hz | A-PKZO(415V50Hz)¹⁾ 073191 | | 2 off   | U-PKZO(415V50Hz)¹⁾ 073139 | | 2 off   | |
| 120 V 60 Hz | A-PKZO(120V60Hz)¹⁾ 073195 | | 2 off   | U-PKZO(120V60Hz)¹⁾ 073143 | | 2 off   | |
| 240 V 60 Hz | A-PKZO(240V60Hz)¹⁾ 073198 | | 2 off   | U-PKZO(240V60Hz)¹⁾ 073146 | | 2 off   | |
| 440 V 60 Hz | A-PKZO(440V60Hz)¹⁾ 082164 | | 2 off   | U-PKZO(440V60Hz)¹⁾ 082161 | | 2 off   | |
| 480 V 60 Hz | A-PKZO(480V60Hz)¹⁾ 073199 | | 2 off   | U-PKZO(480V60Hz)¹⁾ 073147 | | 2 off   | |
| Non-standard voltages not covered by above standard voltages | | | | | | | |
| ... V 50 Hz (24 - 500 V) | A-PKZO(*V50Hz)¹⁾ 982165 | | 2 off   | U-PKZO(*V50Hz) 982162 | | | The part number for ordering consists of the basic part number and the actuating voltage. For non-standard voltages, specify the required actuating voltage within the indicated range (... - ... V). Minimum order quantity is 10 units |
| ... V 60 Hz (24 - 600 V) | A-PKZO(*V60Hz)¹⁾ 982166 | | 2 off   | U-PKZO(*V60Hz) 982163 | | | |
| DC | | | | | | | |
| Standard voltage | | | | | | | |
| 24 V DC | A-PKZO(24VDC)¹⁾ 073200 | | 2 off   | | | | PKE can be fitted only with A(U)-PKZO... with serial number 02 or higher. |
| 110 V DC | A-PKZO(110VDC)¹⁾ 073203 | | 2 off   | | | | |

Information relevant for export to North America



1)

| | |
|-------------------|---|
| Product Standards | UL 508; CSA-C22.2 No.14; IEC60947-4-1; CE marking |
| UL File No. | E36332 |
| UL CCN | NLRV |
| CSA File No. | 12528 |
| CSA Class No. | 3211-05 |
| NA Certification | UL Listed, CSA certified |

1.3 Motor-protective circuit-breakers PKZM01, PKZM0, PKZM4, PKE

1 Engineering

1- and 2-pole-connected PKZM0, PKZM4 with AC and DC



2-pole-connected PKZM0(1) and PKZM4 with CL-PKZ0

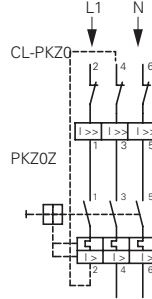

Protection of PVC-insulated cables against thermal overload on short-circuits

The table specifies which minimum conductor cross-sections are protected by motor-protective circuit-breaker PKZ(M) up to their rated conditional short-circuit current I_q .

| Min. cross-section protected 380 – 415 V, 50 Hz, Cu mm ² | Device Part no. |
|--|--------------------|
| 4 | PKZM0-0,16 |
| 2.5 | PKZM0-6.3 |
| 1.5 | PKZM0-10 |
| 1 | PKZM0-12 |
| 0.75 | PKZM0-16 |
| | PKZM0-20 |
| | PKZM0-25 |
| | PKZM0-32 |
| | PKZM4-16 |
| | PKZM4-25 |
| | PKZM4-32 |
| | PKZM4-40 |
| | PKZM4-50 |
| | PKZM4-58 |
| | PKZM4-63 |

PKZM0-...T tripping characteristics (not for PKM0-...), PKZM01

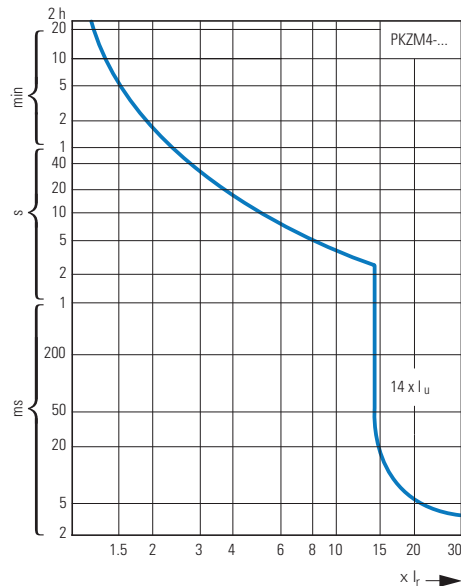
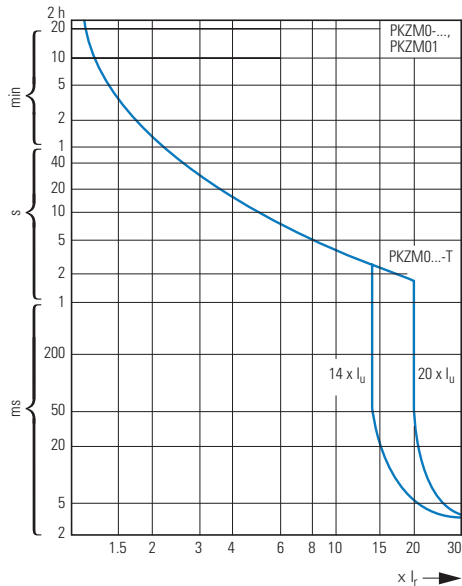

Tripping characteristic curves, wide-range circuit-breaker PKE

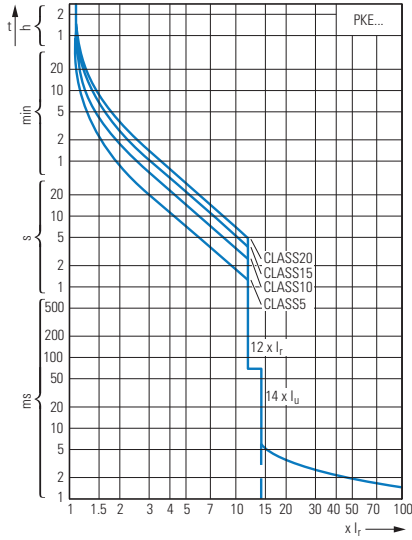

Let-through characteristics, motor-protective circuit-breaker, transformer-protective circuit-breakers, circuit-breaker for starter combinations

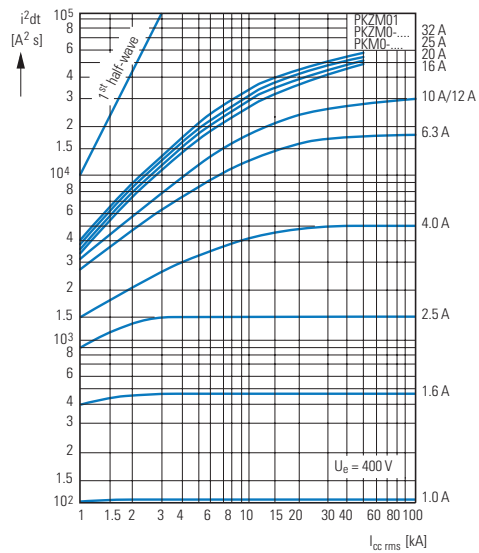
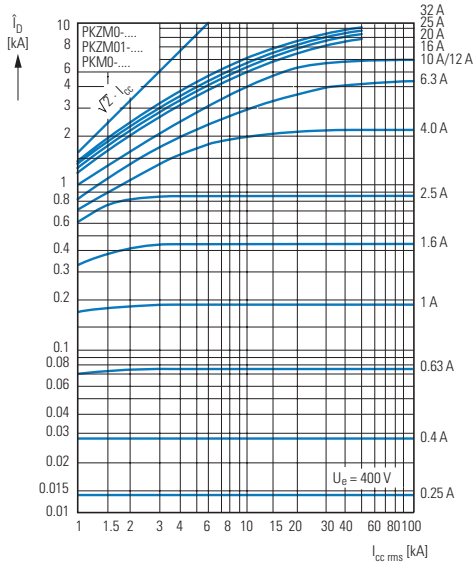

Motor-protective circuit-breaker let-through characteristics

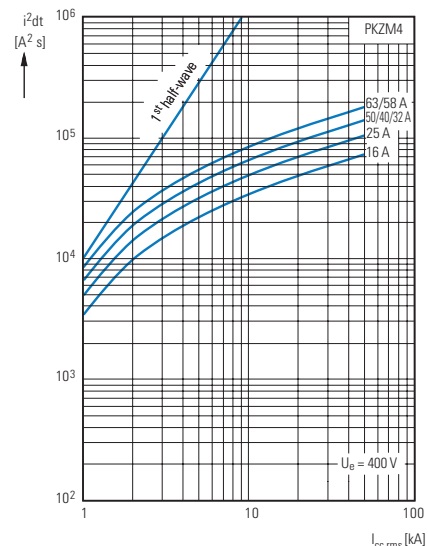
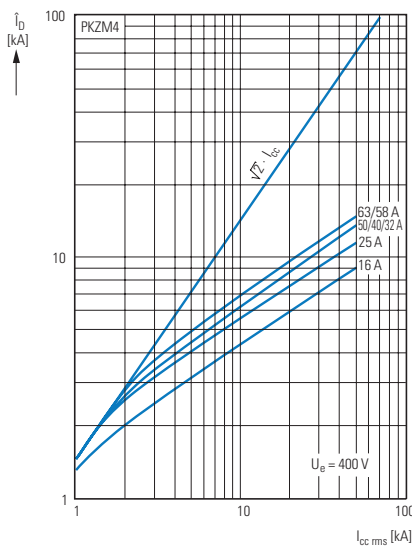

1.3

Motor-protective circuit-breakers PKZM01, PKZM0, PKZM4, PKE Switching capacity

Circuit-breaker switching capacity from serial no. 04

1

Rated uninterrupted current I_u

Rated conditional short-circuit current I_q IEC/EN 60947-4-1

Rated ultimate short-circuit breaking capacity I_{cu}
Rated breaking capacity I_{cs} } IEC/EN 60947-2

| | 230 V | | | | 400 V | | | | 440 V | | | | 500 V | | | | 690 V | | | |
|------------|-------------|----------------|----------------|-----------------|-------------|----------------|----------------|-----------------|-------------|----------------|----------------|-----------------|-------------|----------------|----------------|-----------------|-------------|----------------|----------------|-----------------|
| I_u A | I_q kA | I_{cu} kA | I_{cs} kA | A ¹⁾ | I_q kA | I_{cu} kA | I_{cs} kA | A ¹⁾ | I_q kA | I_{cu} kA | I_{cs} kA | A ¹⁾ | I_q kA | I_{cu} kA | I_{cs} kA | A ¹⁾ | I_q kA | I_{cu} kA | I_{cs} kA | A ¹⁾ |

PKZM0, PKZM0...-T, PKM0 with type "1" and "2" coordination

| | | | | | | | | | | | | | | | | | | | | |
|----------|-----|-----|-----|----|-----|-----|-----|----|----|----|----|----|----|----|----|----|---|---|---|----|
| 0.16 – 1 | 150 | 150 | 150 | N | 150 | 150 | 150 | N | | | | N | | | | N | | | | N |
| 1.6 | 150 | 150 | 150 | N | 150 | 150 | 150 | N | | | | N | | | | N | | | | N |
| 2.5 | 150 | 150 | 150 | N | 150 | 150 | 150 | N | | | | N | | | | N | 5 | 5 | 5 | 50 |
| 4 | 150 | 150 | 150 | N | 150 | 150 | 150 | N | | | | N | | | | N | 3 | 3 | 3 | 50 |
| 6.3 | 150 | 150 | 150 | N | 150 | 150 | 150 | N | | | | N | 42 | 42 | 11 | 50 | 3 | 3 | 2 | 50 |
| 10 | 150 | 150 | 150 | N | 150 | 150 | 150 | N | 42 | 42 | 12 | 50 | 42 | 42 | 11 | 50 | 3 | 3 | 2 | 50 |
| 12 | 50 | 50 | 13 | 50 | 50 | 50 | 13 | 50 | 15 | 15 | 12 | 50 | 15 | 15 | 8 | 50 | 3 | 3 | 2 | 50 |
| 16 | 50 | 50 | 13 | 50 | 50 | 50 | 13 | 50 | 15 | 15 | 12 | 50 | 15 | 15 | 8 | 50 | 3 | 3 | 2 | 50 |
| 20 | 50 | 50 | 13 | 50 | 50 | 50 | 13 | 50 | 10 | 10 | 13 | 50 | 6 | 6 | 3 | 50 | 3 | 3 | 1 | 50 |
| 25 | 50 | 50 | 13 | 50 | 50 | 50 | 13 | 50 | 10 | 10 | 13 | 50 | 6 | 6 | 3 | 50 | 3 | 3 | 1 | 50 |
| 32 | 50 | 50 | 13 | 50 | 50 | 50 | 13 | 50 | 10 | 10 | 13 | 50 | 6 | 6 | 3 | 50 | 3 | 3 | 1 | 50 |

PKZM0 (PKZM0...-T, PKM0) + CL-PKZ0

| | | | | | | | | | | | | | | | | | | | | | |
|----------|--|--|--|---|--|--|--|---|--|--|--|---|----|----|----|---|----|----|-----|-----|---|
| 0.16 – 1 | | | | N | | | | N | | | | N | | | | N | | | | 20 | N |
| 1.6 | | | | N | | | | N | | | | N | | | | N | | | | 20 | N |
| 2.5 | | | | N | | | | N | | | | N | | | | N | 20 | 20 | 20 | 20 | N |
| 4 | | | | N | | | | N | | | | N | | | | N | 20 | 20 | 20 | 20 | N |
| 6.3 | | | | N | | | | N | | | | N | | | 50 | N | 20 | 20 | 20 | 20 | N |
| 10 | | | | N | | | | N | | | | N | | | 20 | N | 20 | 20 | 20 | 20 | N |
| 12 | | | | N | | | | N | | | | N | | | 20 | N | 5 | 5 | 2.5 | 2.5 | N |
| 16 | | | | N | | | | N | | | | N | | | 20 | N | 5 | 5 | 2.5 | 2.5 | N |
| 20 | | | | N | | | | N | | | | N | 10 | 10 | 10 | N | 5 | 5 | 2.5 | 2.5 | N |
| 25 | | | | N | | | | N | | | | N | 10 | 10 | 10 | N | 5 | 5 | 2.5 | 2.5 | N |
| 32 | | | | N | | | | N | | | | N | 10 | 10 | 10 | N | 5 | 5 | 2.5 | 2.5 | N |

PKZM0 (PKZM0...-T, PKM0) + 2 CL-PKZ0

| | | | | | | | | | | | | | | | | | | | | | |
|----------|--|--|--|---|--|--|--|---|--|--|--|---|----|----|----|---|----|----|-----|-----|---|
| 0.16 – 1 | | | | N | | | | N | | | | N | | | | N | | | | 20 | N |
| 1.6 | | | | N | | | | N | | | | N | | | | N | | | | 20 | N |
| 2.5 | | | | N | | | | N | | | | N | | | | N | 40 | 40 | 20 | 20 | N |
| 4 | | | | N | | | | N | | | | N | | | | N | 40 | 40 | 20 | 20 | N |
| 6.3 | | | | N | | | | N | | | | N | | | 50 | N | 20 | 20 | 20 | 20 | N |
| 10 | | | | N | | | | N | | | | N | | | 40 | N | 20 | 20 | 20 | 20 | N |
| 12 | | | | N | | | | N | | | | N | | | 40 | N | 10 | 10 | 2.5 | 2.5 | N |
| 16 | | | | N | | | | N | | | | N | | | 40 | N | 10 | 10 | 2.5 | 2.5 | N |
| 20 | | | | N | | | | N | | | | N | 20 | 20 | 20 | N | 10 | 10 | 2.5 | 2.5 | N |
| 25 | | | | N | | | | N | | | | N | 20 | 20 | 20 | N | 10 | 10 | 2.5 | 2.5 | N |
| 32 | | | | N | | | | N | | | | N | 20 | 20 | 20 | N | 10 | 10 | 2.5 | 2.5 | N |

Notes

■ No upstream protective device required, as it is the auto-protected range (100/150 kA)

N Not necessary

¹⁾ Required back-up fuse if the short-circuit current exceeds the device's rated conditional short-circuit current ($I_{cc} > I_q$).

Circuit-breaker switching capacity

Rated uninterrupted current I_u

Rated conditional short-circuit current I_q IEC/EN 60947-4-1

Rated maximum short-circuit breaking capacity I_{cu}
 Rated breaking capacity I_{cs} } IEC/EN 60947-2

| I_u A | 230 V | | | | 400 V | | | | 440 V ²⁾ | | | | 500 V ²⁾ | | | | 690 V ²⁾ | | | |
|--|-------------|----------------|----------------|-----------------|-------------|----------------|----------------|-----------------|---------------------|----------------|----------------|-----------------|---------------------|----------------|----------------|-----------------|---------------------|----------------|----------------|-----------------|
| | I_q kA | I_{cu} kA | I_{cs} kA | A ¹⁾ | I_q kA | I_{cu} kA | I_{cs} kA | A ¹⁾ | I_q kA | I_{cu} kA | I_{cs} kA | A ¹⁾ | I_q kA | I_{cu} kA | I_{cs} kA | A ¹⁾ | I_q kA | I_{cu} kA | I_{cs} kA | A ¹⁾ |
| PKZM01 with type "1" and "2" coordination | | | | | | | | | | | | | | | | | | | | |
| 0.16 – 1 | 50 | 50 | 50 | 50 | 50 | 50 | 50 | 50 | 50 | 50 | 50 | 50 | 50 | 50 | 50 | 50 | 50 | 50 | 50 | 50 |
| 1.6 | 50 | 50 | 50 | 50 | 50 | 50 | 50 | 50 | 50 | 50 | 50 | 50 | 50 | 50 | 50 | 50 | 50 | 50 | 50 | 50 |
| 2.5 | 50 | 50 | 50 | 50 | 50 | 50 | 50 | 50 | 50 | 50 | 50 | 50 | 50 | 50 | 50 | 50 | 50 | 50 | 50 | 50 |
| 4 | 50 | 50 | 50 | 50 | 50 | 50 | 50 | 50 | 50 | 50 | 50 | 50 | 50 | 50 | 50 | 50 | 50 | 50 | 50 | 50 |
| 6.3 | 50 | 50 | 50 | 50 | 50 | 50 | 50 | 50 | 50 | 50 | 50 | 50 | 50 | 50 | 50 | 50 | 50 | 50 | 50 | 50 |
| 10 | 50 | 50 | 50 | 50 | 50 | 50 | 50 | 50 | 42 | 42 | 10 | 50 | 50 | 50 | 50 | 50 | 50 | 50 | 50 | 50 |
| 12 | 50 | 50 | 10 | 50 | 50 | 50 | 10 | 50 | 15 | 15 | 10 | 50 | 50 | 50 | 50 | 50 | 50 | 50 | 50 | 50 |
| 16 | 50 | 50 | 10 | 50 | 50 | 50 | 10 | 50 | 15 | 15 | 10 | 50 | 50 | 50 | 50 | 50 | 50 | 50 | 50 | 50 |
| 20, 25 | 50 | 50 | 10 | 50 | 50 | 50 | 10 | 50 | 10 | 10 | 3 | 50 | 50 | 50 | 50 | 50 | 50 | 50 | 50 | 50 |
| PKZM4 with type "1" and "2" coordination | | | | | | | | | | | | | | | | | | | | |
| 16 | 150 | 150 | 25 | N | 150 | 150 | 25 | N | 45 | 45 | 25 | 100 | 15 | 15 | 100 | 8 | 8 | 2.5 | 100 | |
| 25 | 150 | 150 | 25 | N | 150 | 150 | 25 | N | 45 | 45 | 25 | 100 | 15 | 15 | 100 | 8 | 8 | 2.5 | 100 | |
| 32 | 50 | 50 | 25 | 100 | 50 | 50 | 25 | 100 | 45 | 45 | 25 | 100 | 15 | 15 | 100 | 5 | 5 | 2.5 | 100 | |
| 40 | 50 | 50 | 25 | 100 | 50 | 50 | 25 | 100 | 45 | 45 | 25 | 100 | 15 | 15 | 100 | 5 | 5 | 2.5 | 100 | |
| 50 | 50 | 50 | 25 | 100 | 50 | 50 | 25 | 100 | 45 | 45 | 25 | 100 | 15 | 15 | 100 | 5 | 5 | 2.5 | 100 | |
| 58 | 50 | 50 | 25 | 160 | 50 | 50 | 25 | 160 | 45 | 45 | 25 | 160 | 15 | 15 | 160 | 5 | 5 | 2.5 | 160 | |
| 63 | 50 | 50 | 25 | 160 | 50 | 50 | 25 | 160 | 45 | 45 | 25 | 160 | 15 | 15 | 160 | 5 | 5 | 2.5 | 160 | |
| PKE12...²⁾ with type of coordination „1“ and | | | | | | | | | | | | | | | | | | | | |
| 0.3 - 1.2 | 100 | | | 50 | 100 | | | 50 | 50 | | | 50 | 10 | | | 50 | 3 | | | 50 |
| 1 - 4 | 100 | | | 50 | 100 | | | 50 | 50 | | | 50 | 10 | | | 50 | 3 | | | 50 |
| 3 - 12 | 100 | | | 50 | 100 | | | 50 | 15 | | | 50 | 10 | | | 50 | 3 | | | 50 |
| PKE32...²⁾ with type of coordination „1“ and | | | | | | | | | | | | | | | | | | | | |
| 3 - 12 | 100 | | | 50 | 100 | | | 50 | 15 | | | 50 | 6 | | | 50 | 3 | | | 50 |
| 8 - 32 | 100 | | | 50 | 100 | | | 50 | 25 | | | 50 | 6 | | | 50 | 3 | | | 50 |

Notes

- No upstream protective device required, as it is the auto-protected range (150 kA)
- N Not necessary

- ¹⁾ Fuse (A gG/gL) for increasing the switching capacity of the motor-protective circuit-breaker to 100 kA
- ²⁾ Please enquire for additional information regarding voltages >400 V and device combinations with CL-PKZ0.

Motor-protective circuit-breaker internal resistances

| | Impedance | Heat dissipation (3 pole at operating temperature) | Rated uninterrupted current I_u | | Impedance | Heat dissipation (3 pole at operating temperature) | Rated uninterrupted current I_u |
|------------|-----------|--|-----------------------------------|----------|-----------|--|-----------------------------------|
| | Ω | W | A | | Ω | W | A |
| PKZM0-0.16 | 78 | 6 | 0.16 | PKZM4-16 | 0.029 | 22 | 16 |
| PKZM0-0.25 | 32 | 6 | 0.25 | PKZM4-25 | 0.012 | 22 | 25 |
| PKZM0-0.4 | 13 | 6 | 0.4 | PKZM4-32 | 0.007 | 22 | 32 |
| PKZM0-0.63 | 5 | 6 | 0.63 | PKZM4-40 | 0.005 | 22 | 40 |
| PKZM0-1 | 2 | 6 | 1 | PKZM4-50 | 0.003 | 22 | 50 |
| PKZM0-1.6 | 0.8 | 6 | 1.6 | PKZM4-58 | 0.002 | 22 | 58 |
| PKZM0-2.5 | 0.32 | 6 | 2.5 | PKZM4-63 | 0.002 | 22 | 65 |
| PKZM0-4 | 0.13 | 6 | 4 | | | | |
| PKZM0-6.3 | 0.050 | 6 | 6.3 | | | | |
| PKZM0-10 | 0.020 | 6 | 10 | | | | |
| PKZM0-12 | 0.014 | 6 | 12 | | | | |
| PKZM0-16 | 0.008 | 6 | 16 | | | | |
| PKZM0-20 | 0.005 | 6 | 20 | | | | |
| PKZM0-25 | 0.003 | 6 | 25 | | | | |
| PKZM0-32 | 0.002 | 6 | 32 | | | | |

1.3

Motor-protective circuit-breakers PKZM01, PKZM0, PKZM4, PKE

Motor-protective circuit-breakers PKZM

1 Approvals for world markets

PKZM01, PKZM0, PKZM4

Rating data for approved types¹⁾
UL 508/CSA C 22.2 No. 14

| | Maximum motor rating | | | | Setting ranges | | Maximum protective device to UL/CSA | | | | | |
|--|---|-------|-------|-------|-------------------|------------------------|-------------------------------------|---------------------|---------|-------------------------|---------|-----|
| | Three-phase current | | | | Overload releases | Short-circuit releases | Group protection ²⁾ | | | | | |
| | 200 V | 230 V | 460 V | 575 V | | | Up to max. short-circuit current | Maximum fuse rating | | Maximum circuit breaker | | |
| | HP | HP | HP | HP | A | A | 600 V | with CL | with CL | with CL | with CL | |
| Motor-protective circuit-breakers PKZM01 | "Manual Motor Starter with thermal and magnetic trip" | | | | | | | | | | | |
| PKZM01-0,16 | 3) | | | | 0.1 – 0.16 | 2.2 | 50 | 600 | | 600 | | |
| PKZM01-0.25 | | | | | 0.16 – 0.25 | 3.4 | 50 | 600 | | 600 | | |
| PKZM01-0.4 | | | | | 0.25 – 0.4 | 5.6 | 50 | 600 | | 600 | | |
| PKZM01-0,63 | | | | | 0.4 – 0.63 | 8.8 | 50 | 600 | | 600 | | |
| PKZM01-1 | | | | | 0.63 – 1 | 14 | 50 | 600 | | 600 | | |
| PKZM01-1,6 | | | | | 1 – 1.6 | 22 | 50 | 600 | | 600 | | |
| PKZM01-2.5 | ½ | ½ | 1 | 1½ | 1.6 – 2.5 | 35 | 50 | 600 | | 600 | | |
| PKZM01-4 | ¾ | ¾ | 2 | 3 | 2.5 – 4 | 56 | 50 | 600 | | 600 | | |
| PKZM01-6,3 | 1 | 1½ | 3 | 5 | 4 – 6.3 | 88 | 50 | 600 | | 600 | | |
| PKZM01-10 | 3 | 3 | 7½ | 10 | 6.3 – 11 | 140 | 22 | 50 | 150 | 600 | 125 | 600 |
| PKZM01-12 | 3 | 3 | 7½ | 10 | 9 – 12 | 168 | 18 | 50 | 150 | 600 | 125 | 600 |
| PKZM01-16 | 3 | 5 | 10 | 10 | 10 – 16 | 224 | 10 | 50 | 150 | 600 | 125 | 600 |
| PKZM01-20 | 5 | - | - | 15 | 16 – 20 | 280 | 10 | 18 | 150 | 600 | 125 | 600 |
| PKZM01-25 | - | 7½ | 15 | 20 | 20 – 25 | 350 | 10 | 18 | 150 | 600 | 125 | 600 |
| Motor-protective circuit-breakers PKZM01 | "Manual Motor Starter with thermal and magnetic trip" | | | | | | | | | | | |
| PKZM0-0,16 | 3) | | | | 0.1 – 0.16 | 2.2 | 50 | 600 | | 600 | | |
| PKZM0-0.25 | | | | | 0.16 – 0.25 | 3.4 | 50 | 600 | | 600 | | |
| PKZM0-0.4 | | | | | 0.25 – 0.4 | 5.6 | 50 | 600 | | 600 | | |
| PKZM0-0.63 | | | | | 0.4 – 0.63 | 8.8 | 50 | 600 | | 600 | | |
| PKZM0-1 | | | | | 0.63 – 1 | 14 | 50 | 600 | | 600 | | |
| PKZM0-1.6 | | | | | 1 – 1.6 | 22 | 50 | 600 | | 600 | | |
| PKZM0-2.5 | ½ | ½ | 1 | 1½ | 1.6 – 2.5 | 35 | 50 | 600 | | 600 | | |
| PKZM0-4 | ¾ | ¾ | 2 | 3 | 2.5 – 4 | 56 | 50 | 600 | | 600 | | |
| PKZM0-6.3 | 1 | 1½ | 3 | 5 | 4 – 6.3 | 88 | 50 | 600 | | 600 | | |
| PKZM0-10 | 3 | 3 | 7½ | 10 | 6.3 – 11 | 140 | 22 | 50 | 150 | 600 | 125 | 600 |
| PKZM0-12 | 3 | 3 | 7½ | 10 | 9 – 12 | 168 | 18 | 50 | 150 | 600 | 125 | 600 |
| PKZM0-16 | 3 | 5 | 10 | 10 | 10 – 16 | 224 | 10 | 50 | 150 | 600 | 125 | 600 |
| PKZM0-20 | 5 | - | - | 15 | 16 – 20 | 280 | 10 | 18 | 150 | 600 | 125 | 600 |
| PKZM0-25 | - | 7½ | 15 | 20 | 20 – 25 | 350 | 10 | 18 | 150 | 600 | 125 | 600 |
| PKZM0-32 | 7½ | 10 | 20 | 25 | 24 – 32 | 448 | 10 | 18 | 150 | 600 | 125 | 600 |
| Motor-protective circuit-breakers PKZM4 | | | | | | | | | | | | |
| PKZM4-16 | 3 | 5 | 10 | 15 | 10 – 16 | 224 | 50 | 600 | | 600 | | |
| PKZM4-25 | 7½ | 7½ | 20 | 25 | 16 – 25 | 350 | 50 | 600 | | 600 | | |
| PKZM4-32 | 10 | 10 | 25 | 30 | 25 – 34 | 448 | 50 | 600 | | 600 | | |
| PKZM4-40 | 10 | 15 | 30 | 40 | 32 – 42 | 560 | 50 | 600 | | 600 | | |
| PKZM4-50 | 10 | 15 | 30 | 40 | 40 – 52 | 700 | 10 | 600 | | 600 | | |
| PKZM4-58 | 15 | 15 | 40 | 50 | 50 – 56 | 812 | 10 | 600 | | 600 | | |
| PKZM4-63 | 15 | 15 | 40 | 50 | 52 – 58 | 882 | 10 | 600 | | 600 | | |

Notes

Service factor (SF)

Set value I_r , on the current scale, depending on the load factor

$$SF = 1.15 \rightarrow I_r = 1 \times I_{n\text{ mot}}$$

$$SF = 1 \rightarrow I_r = 0.9 \times I_{n\text{ mot}}$$

¹⁾ Devices for world markets IEC Δ UL/CSA

²⁾ Caution: Changed requirements for group protection

³⁾ Calculate motor output in this range according to rated operational current. Specified values as per NEC Table 430 – 150

PKZM

Rating data for approved types¹⁾

UL 508/CSA C 22.2 No. 14

| | | For use with | Pilot Duty | General Use | |
|--------------------------------------|----------------|--------------------|--------------|----------------------------------|--|
| Accessories | | | | | |
| Standard auxiliary contacts | NHI11-PKZO | PKZM0(-T) PKZM4 | A 600, Q 300 | 5 A – 600 V AC 1 A – 250 V DC | – |
| | NHI12-PKZO | | | | |
| | NHI21-PKZO | | | | |
| | NHI2-11S-PKZO | | | | |
| | NHI-E-11-PKZO | | | | |
| Early-make auxiliary contacts | NHI-E-10-PKZO | | E150 | 0.5 A – 250 V AC | – |
| | VHI20-PKZO | PKZM0(-T) | E150 | 0.5 A – 250 V AC | – |
| Trip indicators | VHI20-PKZO1 | PKZM01 | E150 | 0.5 A – 250 V AC | – |
| | AGM2-10-PKZO | PKZM0(-T) PKZM4 | A 600, Q 300 | 5 A – 600 V AC 1 A – 250 V DC | – |
| AGM2-01-PKZO | | | | | |
| Shunt release | A-PKZO(...) | PKZM0(-T) PKZM4 | – | – | Actuating voltages and ordering information → Products for the German market |
| | U-PKZO(...) | | | | |
| Auxiliary contact for contact module | HI11-S/EZ-PKZO | PKZM0 | A 600, Q 300 | 5 A – 600 V AC 1 A – 250 V DC | – |

Notes

¹⁾ Devices for world markets IEC Δ UL/CSA

PKZM

Motor-protective circuit-breakers PKZM0(4) used as "Manual self-protected Motor Starters" – UL 508 Type E

| Maximum motor output | | | | Setting ranges | | Interrupting Capacity = Short Circuit Current (SCCR) | | | Components | |
|----------------------|-------|-------|-------|-------------------|------------------------|--|------------------------------|------------------------------|-------------------|----------------------|
| AC | | | | Overload releases | Short-circuit releases | 240 V | 480Y/ 277 V ²⁾ | 600Y/ 347 V ²⁾ | Motor Protector | Accessories |
| 200 V | 230 V | 460 V | 575 V | [A] | [A] | [kA] | [kA] | [kA] | Part no. | Part no. |
| 208 V | 240 V | 480 V | 600 V | | | | | | | |
| 1 ¹⁾ | | | | 0.1 – 0.16 | 2.2 | 65 | 65 | 50 | PKZM0-0.16 | BK25/3-PKZO-E |
| | | | | 0.16 – 0.25 | 3.4 | 65 | 65 | 50 | PKZM0-0.25 | BK25/3-PKZO-E |
| | | | | 0.25 – 0.4 | 5.6 | 65 | 65 | 50 | PKZM0-0.4 | BK25/3-PKZO-E |
| | | | | 0.4 – 0.63 | 8.8 | 65 | 65 | 50 | PKZM0-0.63 | BK25/3-PKZO-E |
| | | | | 0.63 – 1 | 14 | 65 | 65 | 50 | PKZM0-1 | BK25/3-PKZO-E |
| | | | | 1 – 1.6 | 22 | 65 | 65 | 50 | PKZM0-1.6 | BK25/3-PKZO-E |
| ½ | ½ | 1 | 1½ | 1.6 – 2,5 | 35 | 65 | 65 | 50 | PKZM0-2.5 | BK25/3-PKZO-E |
| ¾ | ¾ | 2 | 3 | 2.5 – 4 | 56 | 65 | 65 | 50 | PKZM0-4 | BK25/3-PKZO-E |
| 1 | 1½ | 3 | 5 | 4 – 6.3 | 88 | 65 | 65 | 50 | PKZM0-6.3 | BK25/3-PKZO-E |
| 3 | 3 | 7½ | 10 | 6.3 – 11 | 140 | 65 | 65 | 50 | PKZM0-10 | BK25/3-PKZO-E |
| 3 | 3 | 7½ | – | 9 – 12 | 168 | 65 | 65 | – | PKZM0-12 | BK25/3-PKZO-E |
| 3 | 5 | 10 | – | 10 – 16 | 224 | 42 | 42 | – | PKZM0-16 | BK25/3-PKZO-E |
| 5 | – | – | – | 16 – 20 | 280 | 18 | 18 | – | PKZM0-20 | BK25/3-PKZO-E |
| – | 7½ | 15 | – | 20 – 25 | 350 | 18 | 18 | – | PKZM0-25 | BK25/3-PKZO-E |
| 7½ | 10 | 20 | – | 24 – 32 | 448 | 18 | 18 | – | PKZM0-32 | BK25/3-PKZO-E |
| 3 | 5 | 10 | 10 | 10 – 16 | 224 | 65 | 65 | 25 | PKZM4-16 | BK50/3-PKZ4-E |
| 5 | 7½ | 15 | 20 | 16 – 27 | 350 | 65 | 65 | 25 | PKZM4-25 | BK50/3-PKZ4-E |
| 7½ | 10 | 20 | 30 | 24 – 34 | 448 | 65 | 65 | 25 | PKZM4-32 | BK50/3-PKZ4-E |
| 10 | – | 30 | 30 | 32 – 40 | 560 | 65 | 65 | 25 | PKZM4-40 | BK50/3-PKZ4-E |
| – | 15 | 30 | – | 40 – 52 | 700 | 65 | 65 | – | PKZM4-50 | BK50/3-PKZ4-E |
| – | – | 40 | – | 50 – 56 | 812 | 65 | 65 | – | PKZM4-58 | BK50/3-PKZ4-E |
| – | – | 40 | – | 52 – 58 | 882 | 65 | – | – | PKZM4-63 | BK50/3-PKZ4-E |

Notes

¹⁾ Calculate motor power in this range according to the rated current. Stated values to NEC Table 430 -150

²⁾ Suitable for networks with grounded star-point

1.3

Motor-protective circuit-breakers PKZM01, PKZM0, PKZM4, PKE

Motor-protective circuit-breaker

1 Technical data

PKZM, PKE

| | | | PKZM01... | PKZM0-... ¹⁾ |
|--|----------------------|------------------------------------|--|--|
| General | | | | |
| Standards | | | IEC/EN 60947, VDE 0660, UL 508, CSA C 22.2 No. 14 | |
| Climatic proofing | | | Damp heat, constant, to IEC 60068-2-78 Damp heat, cyclic, to IEC 60068-2-30 | |
| Ambient temperature | Storage | °C | -25...80 | -25...80 |
| | Open | °C | -25...55 | -25...55 |
| | Encapsulated | °C | -25...40 | -25...40 |
| Built-in position | | | | |
| Direction of incoming supply | | | Any | Any |
| Degree of protection | Device | | IP20 | IP20 |
| | Terminals | | IP00 | IP00 |
| Contact protection to EN 50274 | | | Finger- and back-of-hand proof | |
| Shock resistance, half-sinusoidal shock, 10 ms to IEC 60068-2-27 | | g | 25 | 25 |
| Installation altitude | | m | max. 2000 | max. 2000 |
| Terminal capacity, screw terminals | Solid | mm ² | 1 x (1 - 6) 2 x (1 - 6) | 1 x (1 - 6) 2 x (1 - 6) |
| | | Flexible with ferrule to DIN 46228 | mm ² | 1 x (1 - 6) 2 x (1 - 6) |
| | Solid or stranded | AWG | 18 - 10 | 18 - 10 |
| Terminal capacity, spring-loaded terminals | Solid | mm ² | – | 1 x (1...2.5) 2 x (1...2.5) |
| | | Flexible with ferrule to DIN 46228 | mm ² | – |
| | Solid or stranded | AWG | – | 18...14 |
| Terminal screw tightening torque | Main conductors | Nm | 1.7 | 1.7 |
| | Auxiliary conductors | Nm | 1 | 1 |
| Main contacts | | | | |
| Rated impulse withstand voltage | U_{imp} | V AC | 6000 | 6000 |
| Overvoltage category/pollution degree | | | III/3 | III/3 |
| Rated operational voltage | U_e | V AC | 690 | 690 |
| Rated uninterrupted current = rated operational current | $I_u = I_e$ | A | 16 or current setting of the overcurrent release | 32 or current setting of the overcurrent release |
| Rated frequency | | Hz | 40 - 60 | 40 - 60 |
| Heat dissipation (3 pole at operating temperature) | | W | 6 | 6 |
| Lifespan, mechanical | Operations | x 10 ⁶ | 0.05 | 0.1 |
| Lifespan, electrical (AC-3 at 400 V) | Operations | x 10 ⁶ | 0.05 | 0.1 |
| Maximum operating frequency | Operations/h | Ops/h | 25 | 40 |
| Short-circuit rating | | | | |
| AC | | | → Page 33 | → Page 32 |
| DC | | kA | 60 | 60 (up to PKZM0-16) 40 (PKZM0-20 to PKZM0-32) |
| Motor switching capacity | | | | |
| AC-3 up to 690 V | | A | 16 | 32 |
| DC-5 (up to 250 V) | | A | 16 (3 contacts in series) | 25 (3 contacts in series) |
| Trip blocks | | | | |
| Temperature compensation | | | | |
| To IEC/EN 60947, VDE 0660 | | °C | -5...40 | -5...40 |
| Operating range | | °C | -25...55 | -25...55 |
| Temperature compensation residual error for T > 40 °C | | %/K | ≤ 0.25 | ≤ 0.25 |
| Setting range of overload releases | | x I_u | 0.6 - 1 | 0.6 - 1 |
| Short-circuit releases tolerance | | % | ± 20 | ± 20 |
| Phase-failure sensitivity | | | IEC/EN 60947-4-1, VDE 0660 Part 102 | IEC/EN 60947-4-1, VDE 0660 Part 102 |

Notes ¹⁾ Tested according to IEC/EN 60947-1 (isolating characteristics) and IEC/EN 60947-2

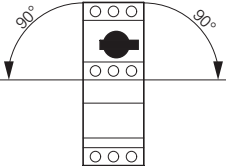
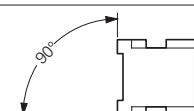
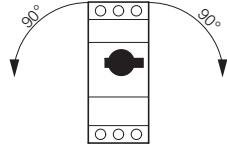
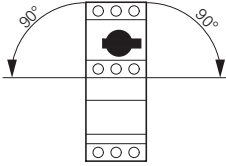
| PKM0-... | PKZM0-...-T | PKZM4 | PKE |
|---|---|---|--|
| IEC/EN 60947, VDE 0660, UL 508, CSA C 22.2 No. 14 | | | |
| Damp heat, constant, to IEC 60068-2-78 | | | |
| Damp heat, cyclic, to IEC 60068-2-30 | | | |
| -25...80 | -25...80 | -25...70 | -25...80 |
| -25...55 | -25...55 | -25...55 | -25...55 |
| -25...40 | -25...40 | -25...40 | -25...40 |
|  |  |  |  |
| Any | Any | Any | Any |
| IP20 | IP20 | IP20 | IP20 |
| IP00 | IP00 | IP00 | IP00 |
| Finger- and back-of-hand proof | | | |
| 25 | 25 | 15 | 25 |
| max. 2000 | max. 2000 | max. 2000 | max. 2000 |
| 1 x (1 - 6) | 1 x (1 - 6) | 1 x (1 - 50) | 1 x (1 - 6) |
| 2 x (1 - 6) | 2 x (1 - 6) | 2 x (1 - 35) | 2 x (1 - 6) |
| 1 x (1 - 6) | 1 x (1 - 6) | 1 x (1 - 35) | 1 x (1 - 6) |
| 2 x (1 - 6) | 2 x (1 - 6) | 2 x (1 - 35) | 2 x (1 - 6) |
| 18 - 10 | 18 - 10 | 14 - 2 | 18 - 10 |
| 1 x (1...2.5) | - | - | 1 x (1...2.5) |
| 2 x (1...2.5) | - | - | 2 x (1...2.5) |
| 1 x (1...2.5) | - | - | 1 x (1...2.5) |
| 2 x (1...2.5) | - | - | 2 x (1...2.5) |
| 18...14 | - | - | 18...14 |
| 1.7 | 1.7 | 3.3 | 1.7 |
| 1 | 1 | 1 | 1 |
| 6000 | 6000 | 6000 | 6000 |
| III/3 | III/3 | III/3 | III/3 |
| 690 | 690 | 690 | 690 |
| 32 or current setting of the overcurrent release | 25 or current setting of the overcurrent release | 65 Open 63 enclosed | 32 A or set current of the overcurrent release |
| 40 - 60 | 40 - 60 | 40 - 60 | 40 - 60 |
| 6 | 6 | 22 | 6 |
| 0.1 | 0.1 | 0.03 | 0.05 |
| 0.1 | 0.1 | 0.03 | 0.05 |
| 40 | 40 | 40 | 60 |
| → Page 32 | → Page 32 | → Page 33 | → Page 33 |
| 60 (up to PKM0-16) 40 (PKM0-20 to PKM0-32) | 60 (up to PKZM0-16) 40 (PKZM0-20 to PKZM0-32) | 60 | - |
| 32 | 25 | 65 | 32 |
| 25 (3 contacts in series) | 25 (3 contacts in series) | 63 (3 contacts in series) | - |
| -5...40 | -5...40 | -5...40 | -5...40 |
| -25...55 | -25...55 | -25...55 | -25...55 |
| ≅ 0.25 | ≅ 0.25 | ≅ 0.25 | 0.25 - 1 |
| ± 20 | ± 20 | ± 20 | ± 20 |
| - | IEC/EN 60947-1-1, VDE 0660 Part 102 | IEC/EN 60947-4-1, VDE 0660 Part 102 | Yes |

1.3

Motor-protective circuit-breakers PKZM01, PKZM0, PKZM4, PKE Auxiliary contacts

1 NHI...PKZ, AGM, U-PKZ, A-PKZ

| | | | NHI...PKZ0 | NHI-E...PKZ0 | VHI...PKZ0 | AGM | |
|--|----------------------|-------------------|---------------|---|------------|------------|-------------|
| Auxiliary contacts | | | | | | | |
| Rated impulse withstand voltage | U_{imp} | V AC | 6000 | 4000 | 4000 | 6000 | |
| Overvoltage category/pollution degree | | | III/3 | III/3 | III/3 | III/3 | |
| Rated operating voltage | | | | | | | |
| | U_e | V AC | 500 | 440 | 440 | 500 | |
| | U_e | V DC | 250 | 250 | 250 | 250 | |
| Safe isolation according to EN 61140 | | | | | | | |
| | | V AC | 690 | 690 | 690 | 690 | |
| Rated operational current | | | | | | | |
| AC-15 | | | | | | | |
| | 220 - 240 V | I_e | A | 3.5 | 1 | 1 | 3.5 |
| | 380 - 415 V | I_e | A | 2 | – | – | 2 |
| | 440 - 500 V | I_e | A | 1 | – | – | 1 |
| DC-13 L/R \leq 100 ms | | | | | | | |
| | 24 V | I_e | A | 2 | 2 | 2 | 2 |
| | 60 V | I_e | A | 1.5 | – | – | 1.5 |
| | 110 V | I_e | A | 1 | – | – | 1 |
| | 220 V | I_e | A | 0.25 | – | – | 0.25 |
| Durability | | | | | | | |
| | Lifespan, mechanical | Operations | $\times 10^6$ | > 0.1 | > 0.1 | > 0.1 | > 0.01 |
| | Lifespan, electrical | Operations | $\times 10^6$ | > 0.05 | > 0.1 | > 0.1 | > 0.05 |
| Control circuit reliability (at $U_e = 24$ V DC, $U_{min} = 17$ V, $I_{min} = 5.4$ mA) | | Fault probability | λ | < 10^{-8} < 1 failure in 1×10^8 operations | | | |
| Interlocked opposing contacts | | | | Yes | – | – | – |
| Short-circuit rating without welding | | | | | | | |
| | Fuseless | | | FAZ-B4/1-HI | – | – | FAZ-B4/1-HI |
| | Fuse | A gG/gL | 10 | 10 | 10 | 10 | |
| Terminal capacity | | | | | | | |
| Solid or flexible conductor with ferrule | | mm ² | 0.75 - 2.5 | 0.75 - 1.5 | 0.75 - 1.5 | 0.75 - 2.5 | |
| Solid or stranded | | AWG | 18 - 14 | 18 - 16 | 18 - 16 | 18 - 14 | |

NHI...PKZ, AGM, U-PKZ, A-PKZ

| | | | Undervoltage release U-PKZ... | Shunt release A-PKZ... |
|---|--|-----------------|--------------------------------------|--------------------------------------|
| General | | | | |
| Terminal capacity | | | | |
| | Solid or flexible conductor with ferrule | mm ² | 1 x (0.75 - 2.5) 2 x (0.75 - 2.5) | 1 x (0.75 - 2.5) 2 x (0.75 - 2.5) |
| | Solid or stranded | AWG | 1 x (18 - 14) 2 x (18 - 14) | 1 x (18 - 14) 2 x (18 - 14) |
| Main contacts | | | | |
| Rated operating voltage | U_e | V AC | 42 - 480 | 42 - 480 |
| Rated operating voltage | U_e | V DC | 24 - 250 | 24 - 250 |
| Pick-up-/drop-out voltage | | | | |
| Pick-up voltage | $x U_s$ | | 0.85 - 1.1 | |
| Drop-out voltage | $x U_s$ | | 0.7 - 0.35 | |
| Operating range | | | | |
| AC voltage | | $x U_s$ | | 0.7...1.1 |
| DC voltage (intermittent operation 5 s) | | $x U_s$ | | 0.7...1.1 |
| Power consumption | | | | |
| AC voltage | | | | |
| | AC pick-up rating | Pick-up | VA | 5 |
| | AC consumption when closed | Holding | VA | 3 |
| DC voltage | | | | |
| | DC pick-up rating | Pick-up | W | – |
| | DC consumption when closed | Holding | W | – |

Dimensions

Motor-protective circuit-breaker

PKZM01 ...

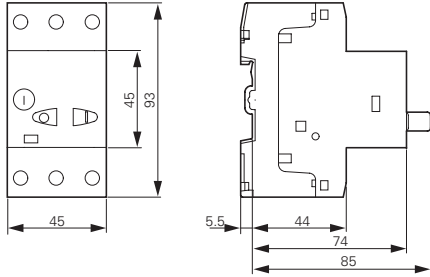

Motor-protective circuit-breaker Transformer-protective circuit-breakers Motor-protective circuit-breaker with standard auxiliary contacts

PKZM0...(+NHI-E...-PKZ0)
PKZM0...-T(+NHI-E...-PKZ0)
PKM0...(+NHI-E...-PKZ0)

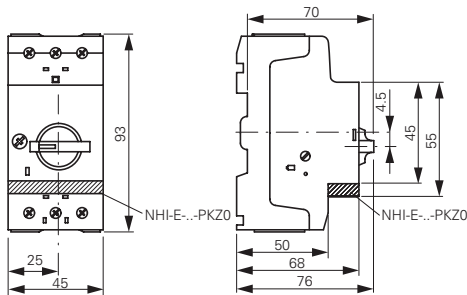

Motor-protective circuit-breakers with lockable rotary handles

PKZM0...+AK-PKZ0

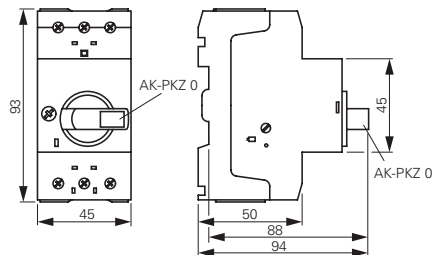

Current limiters

CL-PKZ...

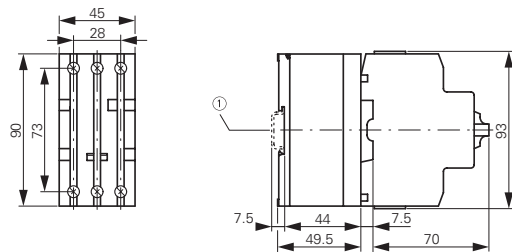

① Top-hat rail IEC/EN 60715

Motor-protective circuit-breakers with early-make auxiliary contacts

PKZM0...+VHI...-PKZ0

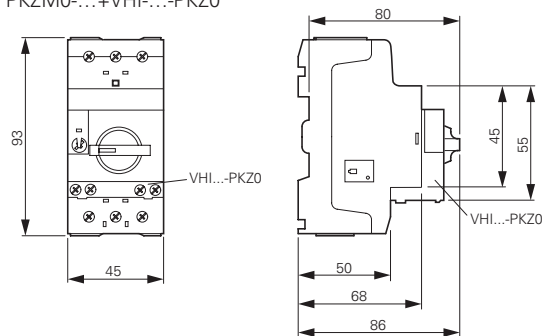

Standard auxiliary contacts

NHI...-PKZ0

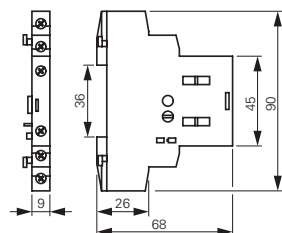

Trip indicators

AGM2...-PKZ0

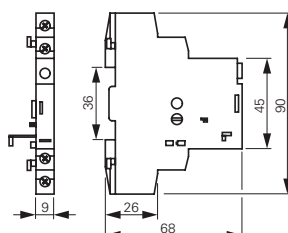

Shunt release Undervoltage release

A-PKZ0...

U-PKZ0...

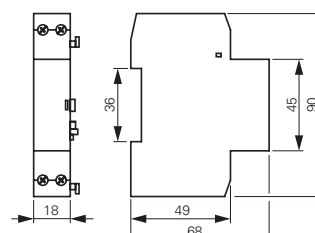

1.3

Motor-protective circuit-breakers PKZM01, PKZM0, PKZM4, PKE

Busbar adapters

1

BBA0-25
BBA0-25/2TS
BBA0/2TS-L
BBA0-32
BBA0-32/2TS-C
BBA0C-16

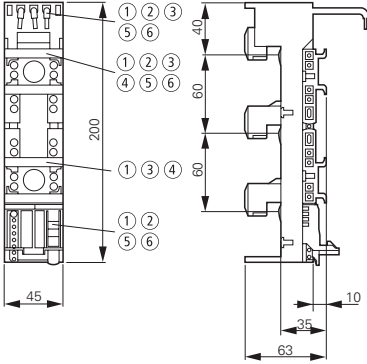

- ① BBA0-32/2TS-C
- ② BBA0-25/2TS
- ③ BBA0C-16
- ④ BBA0/2TS-L
- ⑤ BBA0-25
- ⑥ BBA0-32

BBA2-63
BBA2-63/2TS

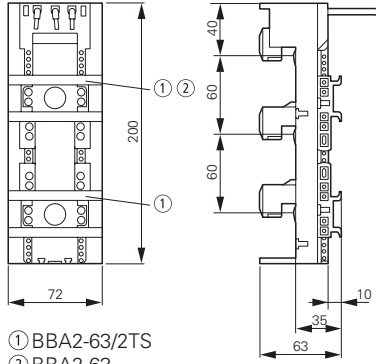

- ① BBA2-63/2TS
- ② BBA2-63

BBA4/2TS-L
BBA4L-63

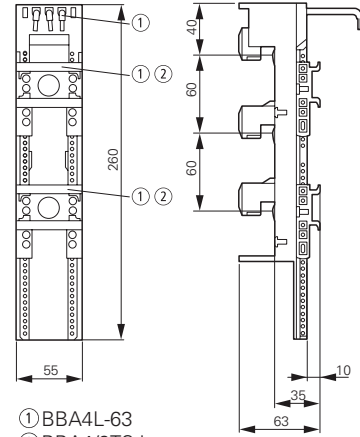

- ① BBA4L-63
- ② BBA4/2TS-L

BBA4-63

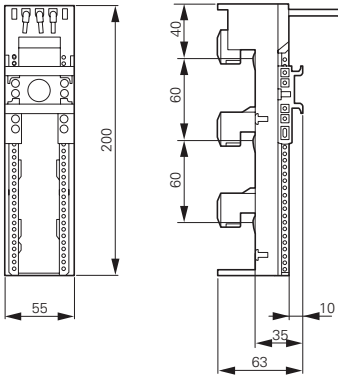

BBA2-80/2TS-S

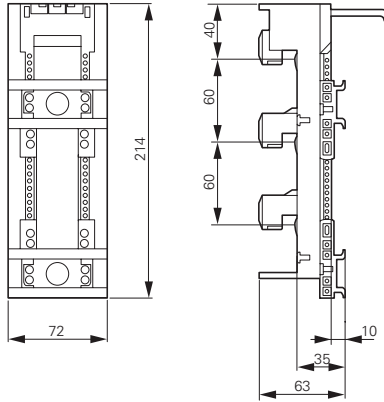

BBA2L-63

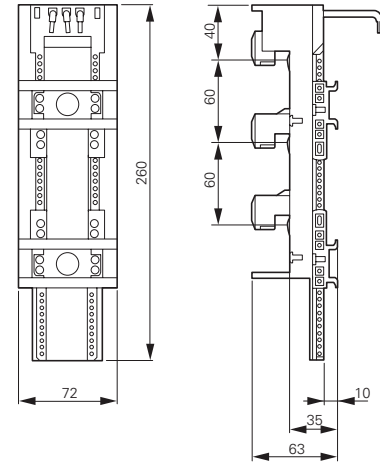

BBA0L-25
BBA0L-32

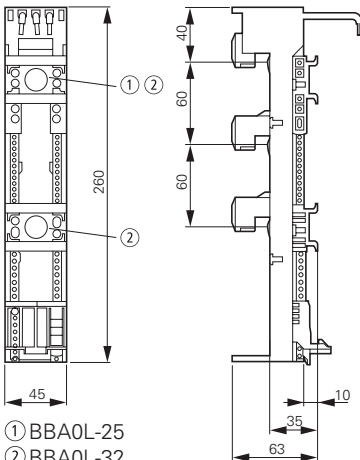

- ① BBA0L-25
- ② BBA0L-32

BBA0K-32

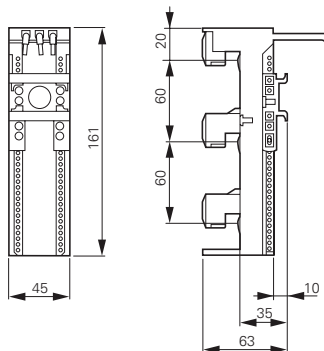

PKZM0-XC45L
PKZM0-XC45L-2

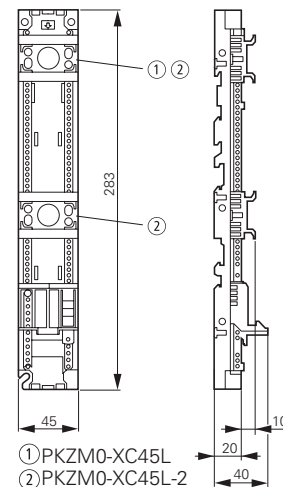

- ① PKZM0-XC45L
- ② PKZM0-XC45L-2

Insulated enclosures for surface mounting

CI-PKZ0-M

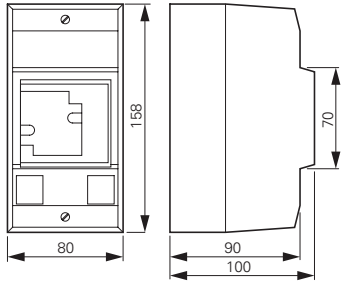

CI-PKZ10G...M

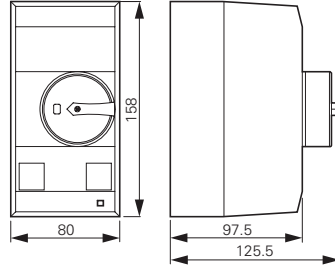

CI-PKZ0...M
+ SVB-PKZ0-CI

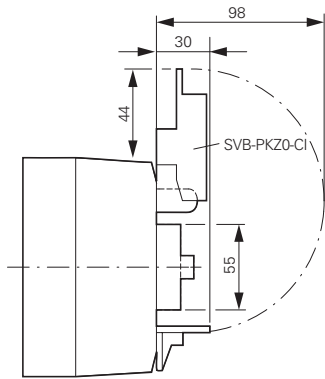

Drilling dimensions
CI-PKZ0...M

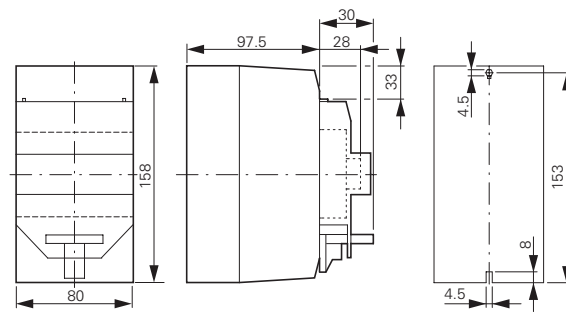

CI-K2-PKZ0

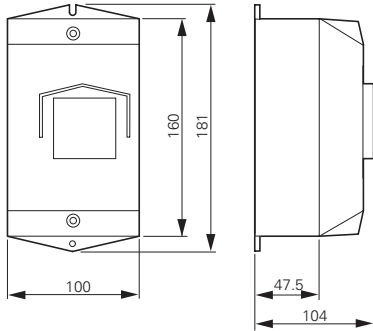

CI-K2-PKZ0G(R)(V)

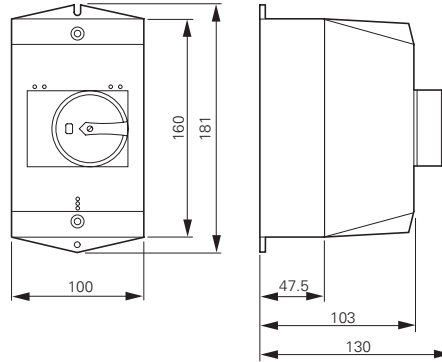

CI-K2-PKZ0-G(R)(V)
+ SVB-PKZ0-CI

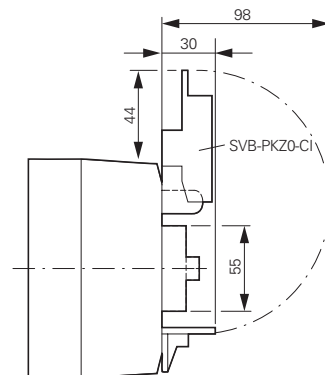

Drilling dimensions
CI-K2-PKZ0...

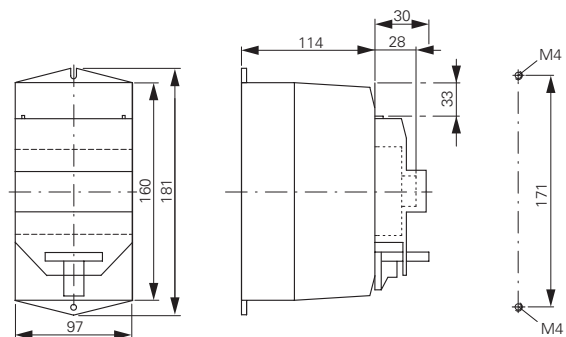

1.3

Motor-protective circuit-breakers PKZM01, PKZM0, PKZM4, PKE

Accessories

Door coupling handles

PKZ0-X(R)H...

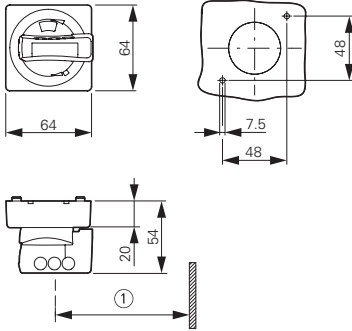

Mounting depth: 100 to 240 mm
from the top edge of the top-hat rail
to the front edge of the cabinet
door/cover
Distance between switch axis and
cover hinge: at least 100 mm

① At least 100 mm from cover hinge

Insulated enclosures for flush mounting

E-PKZ0 E-PKZ0-G...

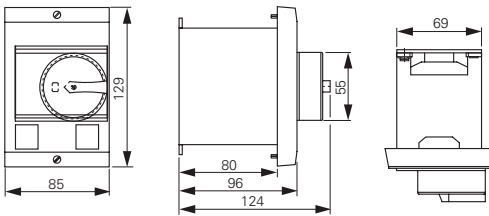

Mounting aperture E-PKZ0...

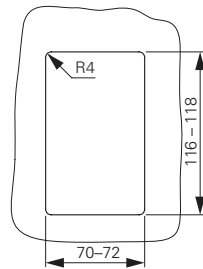

E-PKZ0-G... + SVB-PKZ0-E

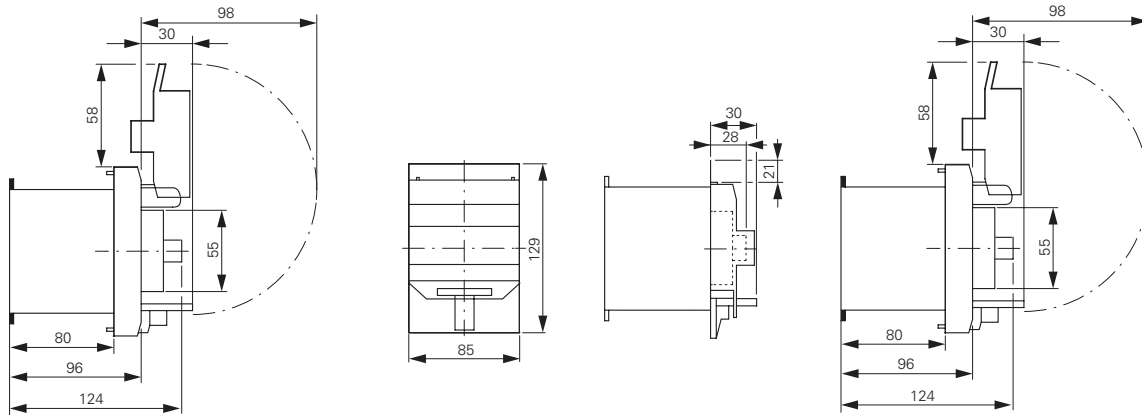

Insulated enclosures for surface mounting

CI23E...

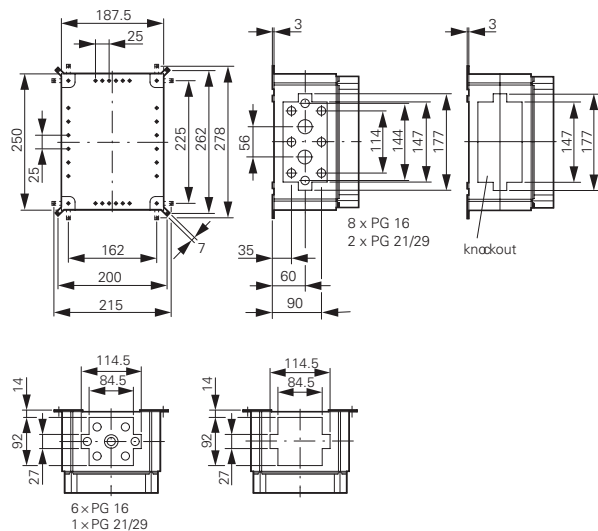

Mounting plates

M3-CI23

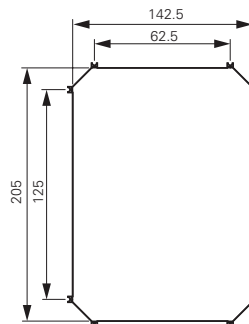

Insulated enclosures for surface mounting

CI-PKZ01
CI-PKZ01-G

CI-PKZ01-PVT
CI-PKZ01-PVS

CI-PKZ01-SVB
CI-PKZ01-SVB-V

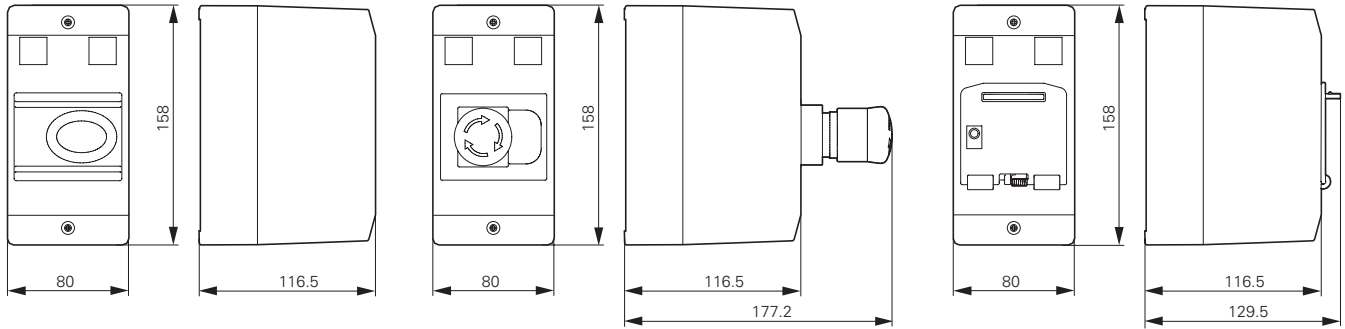

Insulated enclosures for flush mounting

E-PKZ01
E-PKZ01-G

E-PKZ01-PVT
E-PKZ01-PVS

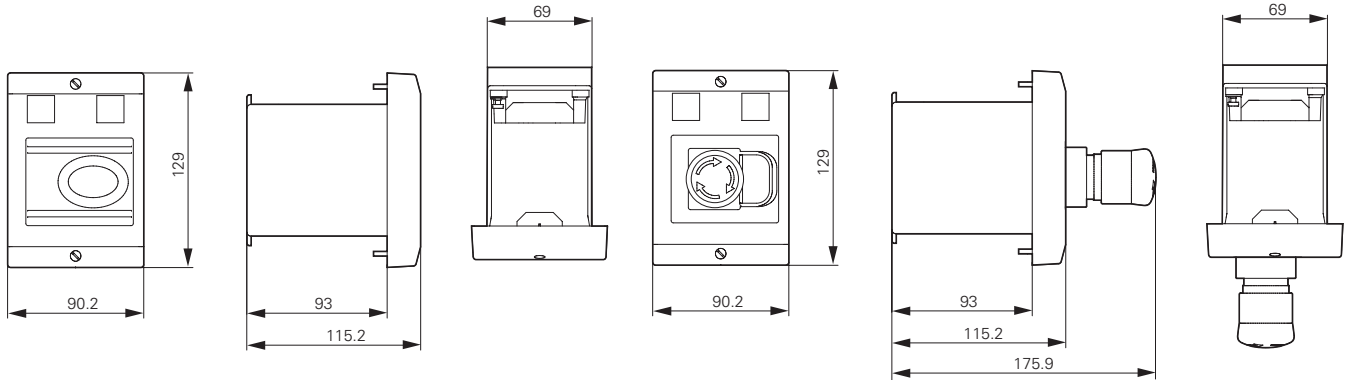

E-PKZ01-SVB
E-PKZ01-SVB-V

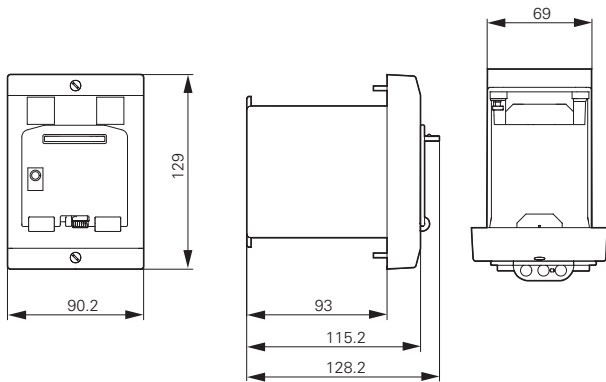

1.3

Motor-protective circuit-breakers PKZM01, PKZM0, PKZM4, PKE

Accessories

Motor-protective circuit-breaker

PKZM4-...

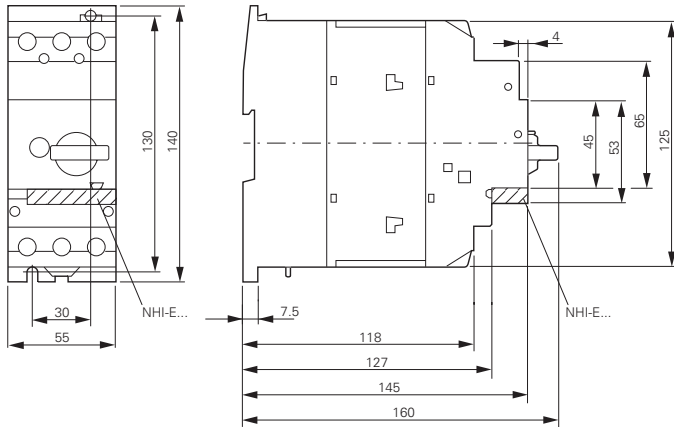

Standard auxiliary contacts

NHI...-PKZ...

NHI...-PKZ0

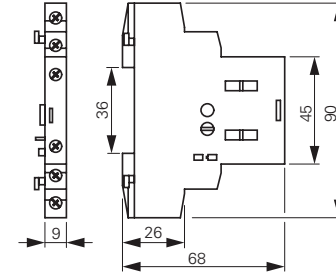

Motor-protective circuit-breakers with lockable cover

PKZM4-... +AK-PKZ0

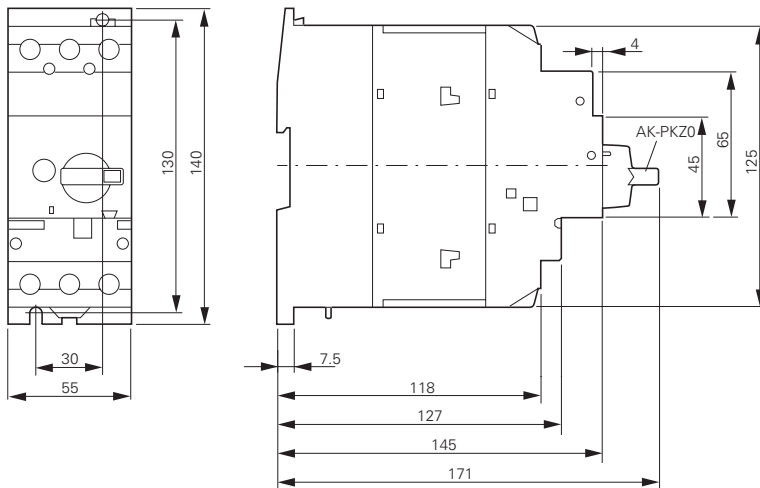

Trip indicators

AGM2...-PKZ...

AGM2...-PKZ0

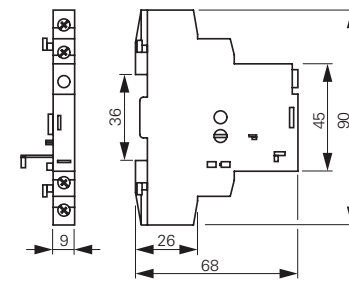

PKE Motor-protective circuit-breakers

PKE12, PKE32

PKE65

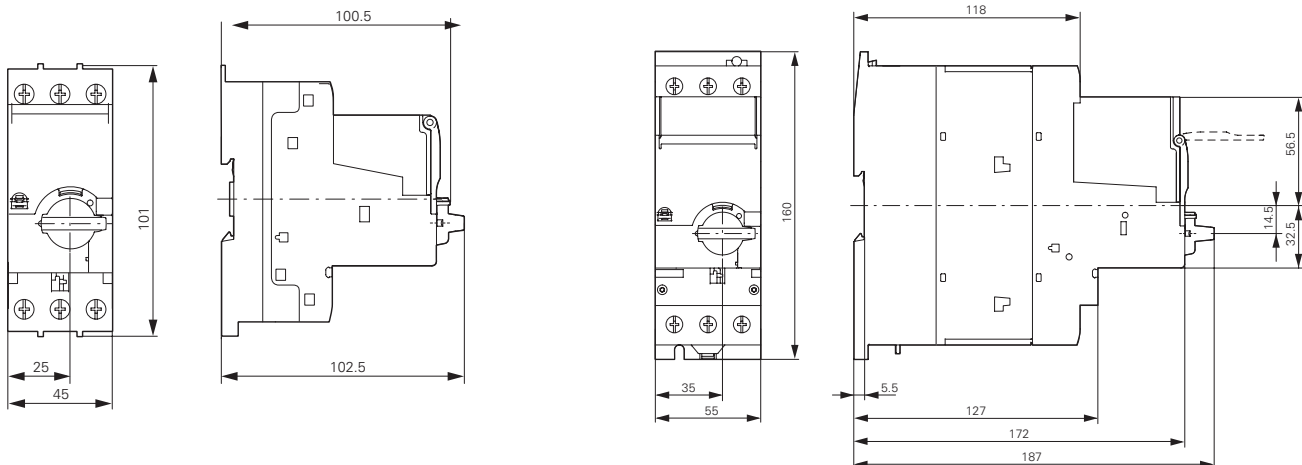

Three-phase commoning links

B3.0/4-PKZ4

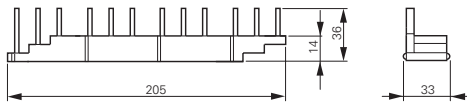

B3.2/4-PKZ4

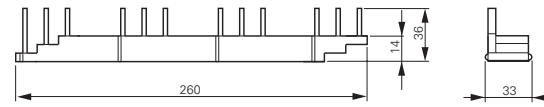

B3.0/3-PKZ4

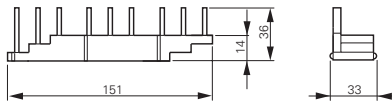

B3.2/2-PKZ4

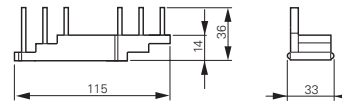

B3.0/2-PKZ4

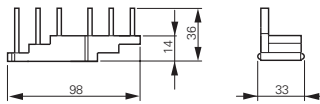

B3.0/3-PKZ4

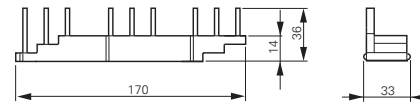

B3.1/4-PKZ4

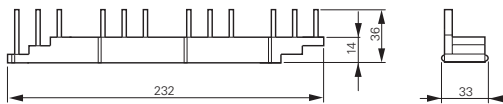

B3.1/2-PKZ4

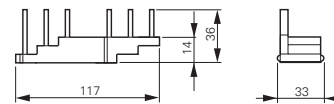

Three-phase commoning links

B3.0/4-PKZ0

B3.0/2-PKZ0

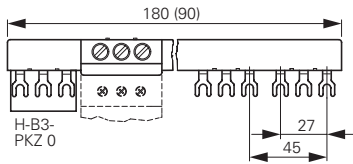

Three-phase commoning links

B3.2/4-PKZ0

B3.2/2-PKZ0

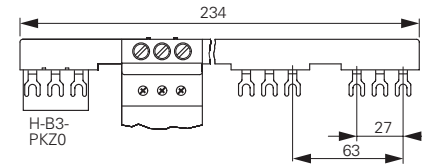

Three-phase commoning links

B3.1/5-PKZ0

B3.1/3-PKZ0

B3.1/4-PKZ0

B3.1/2-PKZ0

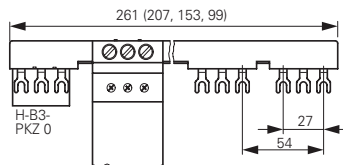

Incoming terminals

BK25/3-PKZ0

Overlapping mounting to extend the three-phase commoning link

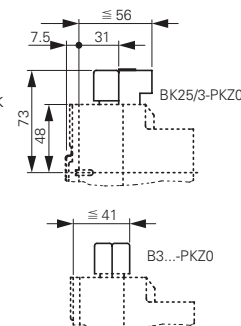

Motor plug DILM12-XMCP/T

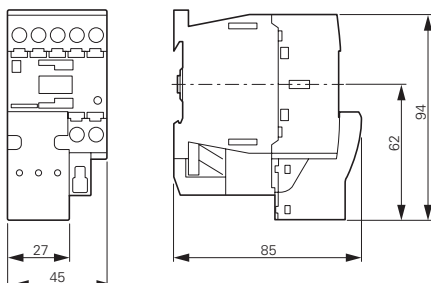

1.3

Motor-protective circuit-breakers PKZM01, PKZM0, PKZM4, PKE Accessories

1 Insulated enclosures for surface mounting

CI-K4-PKZ4-G(R)
+SVB-PKZ4-CI

CI-K4-PKZ4-G

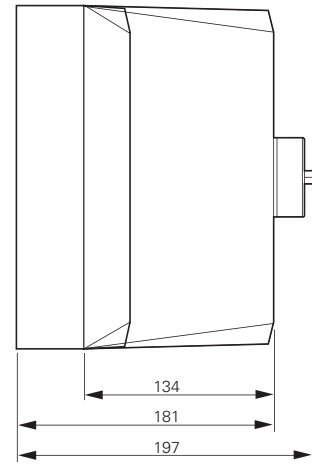
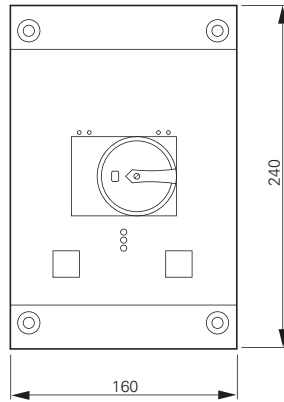
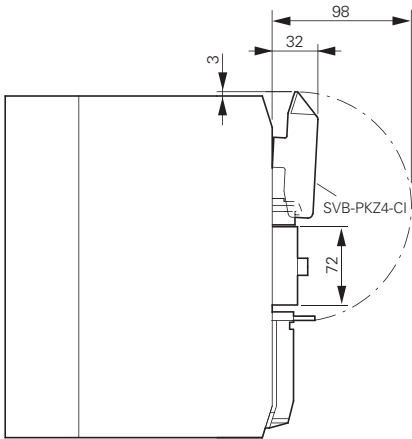

Drilling dimensions
CI-K4-PKZ4-G(R)

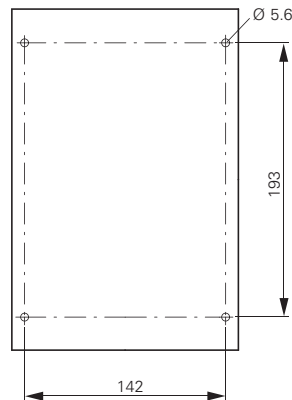
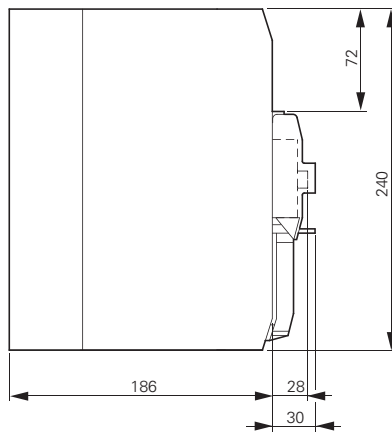
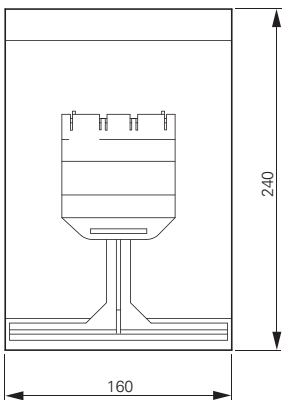

Description

P-SOL, PKZ-SOL, SOL

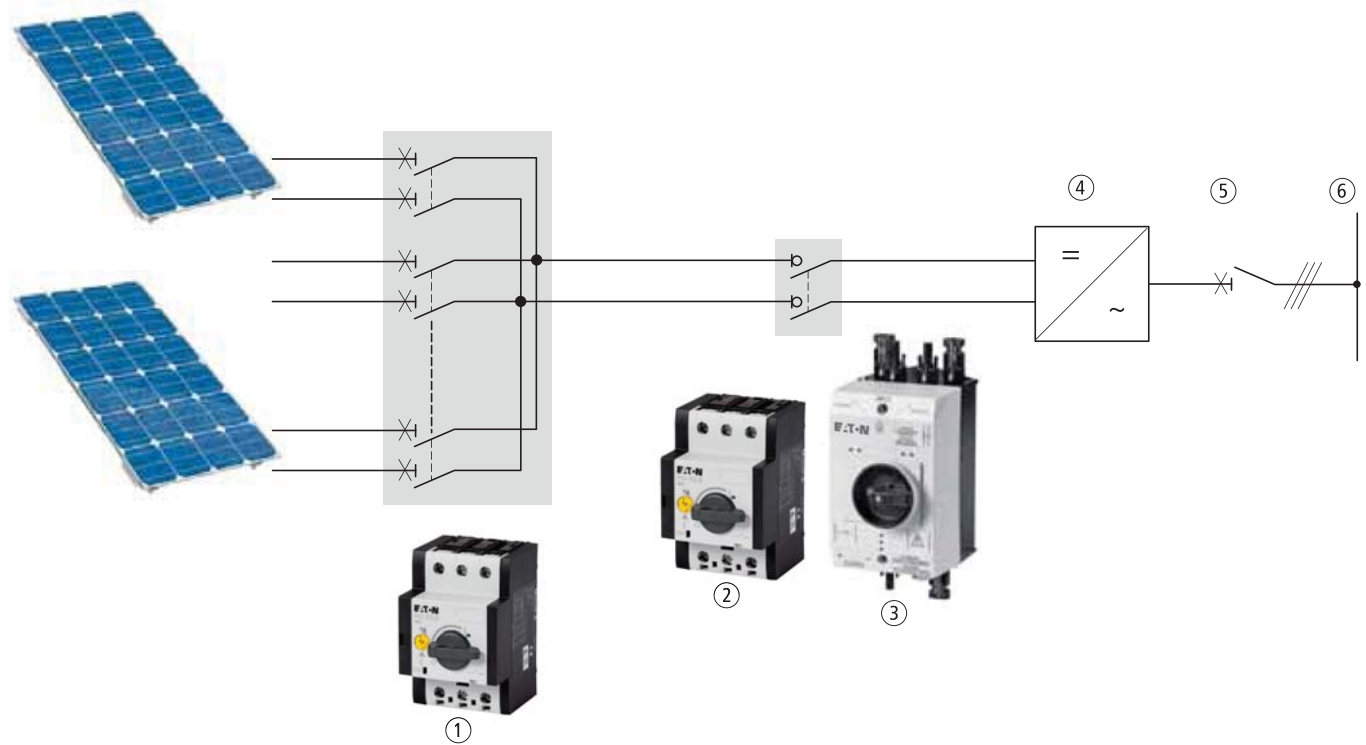

- ① DC string circuit-breaker PKZ-SOL
- ② DC switch-disconnector P-SOL
- ③ Ready-to-install DC switch-disconnector SOL
- ④ Inverter module
- ⑤ AC main switch
- ⑥ Network

Photovoltaics description

Photovoltaic systems convert sunlight directly into electrical energy using solar cells. Photovoltaics represent a renewable source of energy that can be used on private and public buildings, as well as in large-scale power stations. These systems can be independent from the power grid or can be connected to it. Photovoltaic systems that are connected to the grid feed the generated power directly into the mains network. This eliminates the need for temporary storage. These systems consist of solar cells, one or more inverters, and a protective device for automatic cutoff in the event of a grid fault. Because of this, photovoltaic systems that are connected to the grid require extremely reliable and safe individual components.

Features

DC string circuit-breakers

- Protect PV modules from fault currents, prevent (in larger systems, for instance) intact modules from feeding power back into a module with a short-circuit.
- Are ready for operation immediately after tripping and after the trip cause has been fixed.
- Open and for installation in customized generator terminal boxes.
- Tripping currents are adjustable within a wide range of limits.
- Optional shunt releases A-PKZO and undervoltage releases U-PKZO enable remote shutdown, e.g for the fire department. Optional auxiliary contact NHIE-PKZO signals switching state.
- When installed in an enclosure, suitable for voltages of up to 900 VDC.

DC switch-disconnectors

- Required, according to standard VDE 0100-712 (June 2006), between the PV module and inverter.
- Enclosed and open (for installation in enclosure) switch-disconnectors for voltages of up to 1,000 VDC.
- Usable as a separate switching point as required in VDI Guideline VDI 6012, e.g. by de-energizing an inverter in a completely safe manner.

- Two-pole switching, making it suitable for non-earthed systems as well.
- TÜV-certified.
- Open switch-disconnectors P-SOL are designed for installation in customer-specific enclosures or inverters.
- Mounting on 35 mm top-hat rails, their terminals enable a connection to all popular cable types.
- Separate rotary handles and shaft extensions allow for flexible installation.
- An auxiliary switching block can be mounted in order to provide switching state feedback.
- A shunt release or undervoltage release is available for remote tripping.
- Switch-disconnectors SOL with enclosure are ready for installation. Models for 2 and 4 or 4 and 8 strings and for the most popular connector types, such as MC3, MC4, and metric screw connectors, allow for easy integration into various system concepts.
- Enclosure provides degree of protection IP65, making outdoor mounting possible.
- Lockable mechanism provides safety when maintenance is required.
- Pressure-equalizing element prevents the formation of condensed water, preventing failures caused by voltage sparkovers























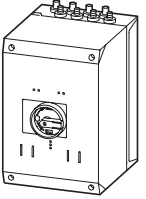

1.3

DC string circuit-breakers, DC switch-disconnectors

DC switch-disconnectors, ready to install

1 Ordering

DC switch-disconnector, ready-to-install

| Inputs Number of strings | Connection type | Outputs | | Max. rated operational current DC-21A I_e A | Part no. Article no. | Price See price list | Std. pack |
|--|-----------------|---------------------|-----------------|--|-------------------------|-----------------------------|---|
| | | Number of strings | Connection type | | | | |
| Rated operational voltage U_e 1000 V | | | | | | | |
| Degree of protection IP65 | | | | | | | |
| Protection class 2 | | | | | | | |
| 2 pole | | | | | | | |
|  | 2 | MC3 | 1 | MC3 | 20 | SOL20/2MC3 120913 | 1 off   |
| | 4 | MC3 | 1 | MC3 | 20 | SOL20/4MC3 120914 | 1 off   |
| | 2 | MC4 | 1 | MC4 | 20 | SOL20/2MC4 120915 | 1 off   |
| | 4 | MC4 | 1 | MC4 | 20 | SOL20/4MC4 120916 | 1 off   |
|  | 2 | Screw connector M12 | 1 | Screw connector M16 | 20 | SOL20/2MV 120919 | 1 off   |
| | 2 | MC3 | 1 | MC3 | 30 | SOL30/2MC3 120920 | 1 off   |
| | 4 | MC3 | 1 | MC3 | 30 | SOL30/4MC3 120921 | 1 off   |
| | 2 | MC4 | 1 | MC4 | 30 | SOL30/2MC4 120922 | 1 off   |
|  | 4 | MC4 | 1 | MC4 | 30 | SOL30/4MC4 120923 | 1 off   |
| | 2 | Screw connector M12 | 1 | Screw connector M16 | 30 | SOL30/2MV 120926 | 1 off   |
| | 4 | MC3 | 1 | Screw connector M20 | 63 | SOL60/4MC3 120927 | 1 off   |
| | 8 | MC3 | 1 | Screw connector M20 | 63 | SOL60/8MC3 120928 | 1 off   |
| | 4 | MC4 | 1 | Screw connector M20 | 63 | SOL60/4MC4 120929 | 1 off   |
| | 8 | MC4 | 1 | Screw connector M20 | 63 | SOL60/8MC4 120930 | 1 off   |
| | 4 | Screw connector M12 | 1 | Screw connector M20 | 63 | SOL60/4MV 120933 | 1 off   |

Information relevant for export to North America



NA Certification Request filed for UL and CSA

P-SOL, PKZ-SOL

Max. rated operational current
DC-21A

Permissible solar module
short-circuit currents

Part no.
Article no.

Price
See price list

Std. pack

I_e
A



DC switch-disconnector, open
Rated operating voltage U_e 1000 V
Protection class II
2 pole

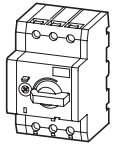

20

P-SOL20
120934

1 off

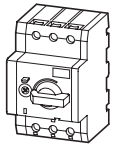

30

P-SOL30
120935

1 off

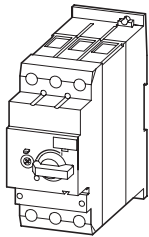

63

P-SOL60
120936

1 off

DC string circuit-breakers
Rated operating voltage U_e 900 V
Protection class II
2 pole

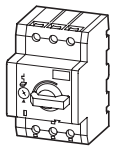

12

5 - 9

PKZ-SOL12
120937

1 off

20

9 - 15

PKZ-SOL20
120938

1 off

30

15 - 22

PKZ-SOL30
120939

1 off

40

22 - 30

PKZ-SOL40¹⁾
120940

1 off

50

29 - 38

PKZ-SOL50¹⁾
120941

1 off

60

38 - 47

PKZ-SOL60¹⁾
120942

1 off

Notes

¹⁾ Availability from November 2010

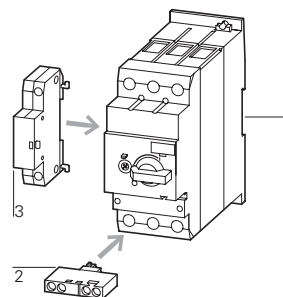
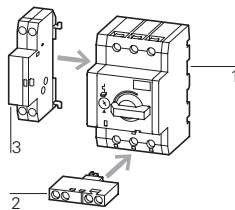

Accessories

2 Auxiliary contacts NHI-E

Page

→ 10

3 Shunt releases A-PKZ0

→ 29

3 Undervoltage releases U-PKZ0

→ 29

Information relevant for export to North America



NA Certification Request filed for UL and CSA

1.3

DC string circuit-breakers, DC switch-disconnectors

1 Engineering

P-SOL and PKZ-SOL wiring

Switch-disconnector P-SOL

Non-earthed grid

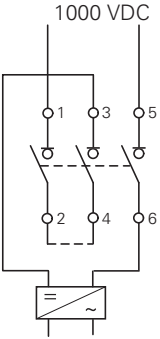

Earthed grid

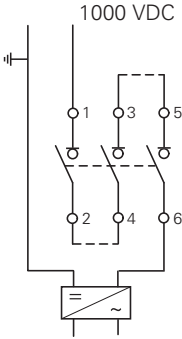

String circuit-breaker PKZ-SOL

Non-earthed grid

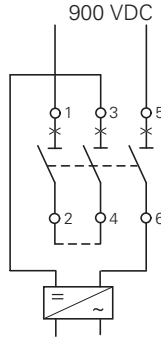

Earthed grid

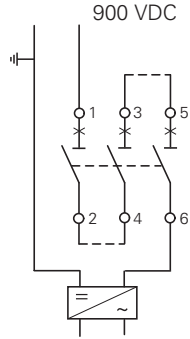

SOL internal circuit

SOL20/2MC3
SOL20/2MC4
SOL30/2MC3
SOL30/2MC4

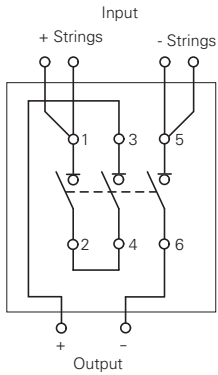

SOL20/2MV
SOL30/2MV

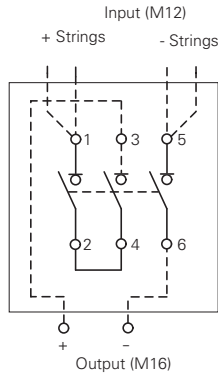

SOL20/4MC3
SOL20/4MC4
SOL30/4MC3
SOL30/4MC4

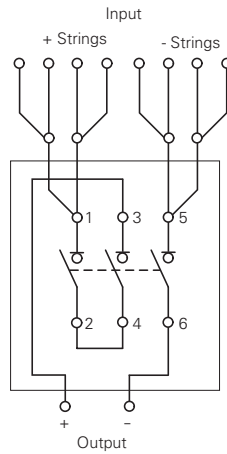

SOL60/4MC3
SOL60/4MC4

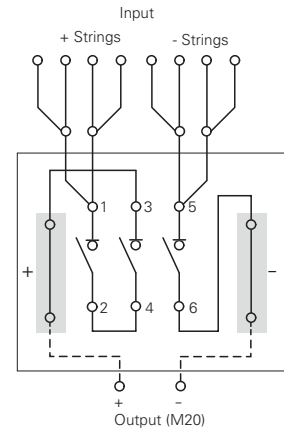

SOL60/4MV

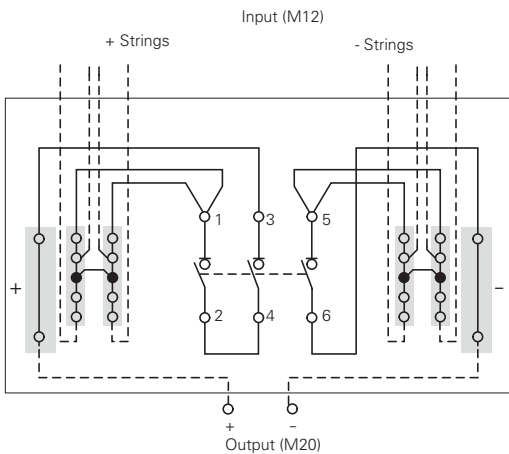

SOL60/8MC3
SOL60/8MC4

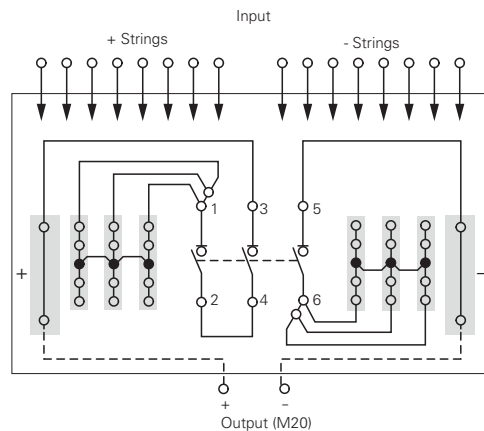

Tripping characteristics

Tripping characteristics
DC string circuit-breaker PKZ-SOL

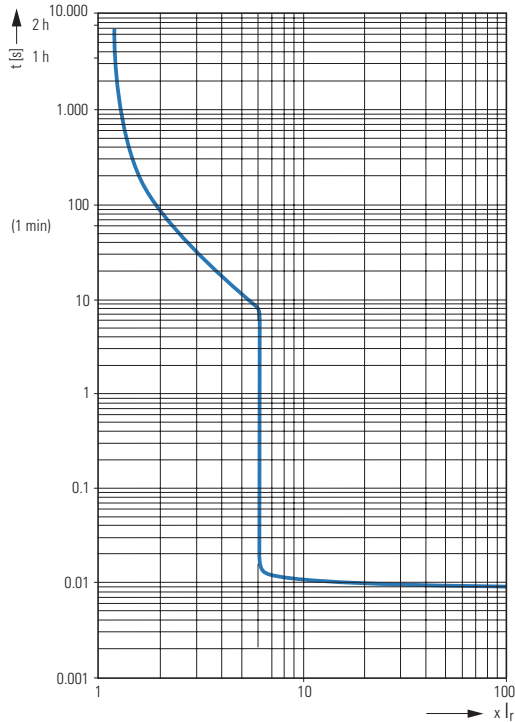

Characteristic curve set value - short-circuit current

As specified in the IEC 62548-1 draft for the protection of photovoltaic modules, the tripping current of the circuit-

breaker must lie between 1.4 and 2 times the value of the photovoltaic module's short-circuit current. Since only the current values of the installed overload release can be plotted on the setting scale for the

circuit-breaker¹⁾, the correlation between the protective device's tripping current and the photovoltaic module's short-circuit current must be specified for each point of the scale in a suitable form.

Setting aid for string circuit-breaker PKZ-SOL

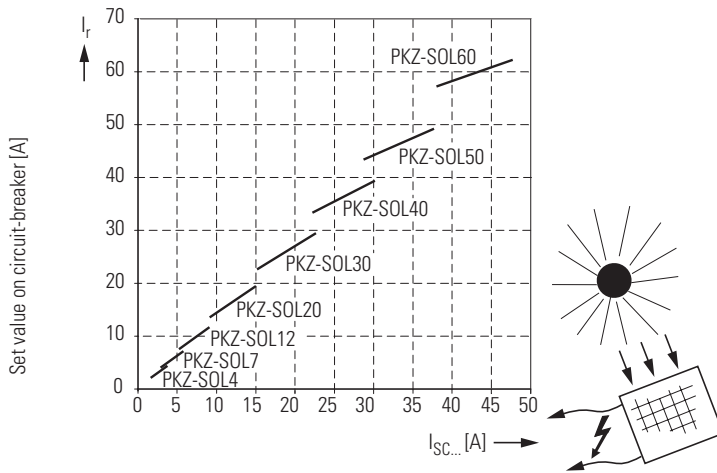

Short-circuit current in solar module [A]

¹⁾ Standard IEC/EN 60947-2 (Section 4.7.3) prohibits directly specifying the photovoltaic short-circuit current on the circuit-breaker's setting scale, meaning that only the current set value of the operating current can be plotted there.

1.3

DC string circuit-breakers, DC switch-disconnectors

DC switch-disconnectors

Technical data

1 P-SOL, SOL

| | | SOL20 | | SOL30 | | SOL60 | |
|---|--------------|--|-------------|-------------|--|-------|-------------|
| Rated operational current I_e at DC-21A | A | 20 | 30 | 63 | | | |
| Number of poles | | 2 | 2 | 2 | | | |
| Rated operational voltage U_e | V DC | 1000 | 1000 | 1000 | | | |
| Isolating characteristics | | Yes | Yes | Yes | | | |
| Standards | | IEC/EN 60 947-3 UL 508, TÜV certificate | | | | | |
| Lifespan mechanical | Operations | 100,000 | 100,000 | 100,000 | | | 30,000 |
| Lifespan electrical | Operations | 100,000 | 100,000 | 100,000 | | | 30,000 |
| Max. operating frequency, mechanical | Ops/h | 120 | 120 | 120 | | | 120 |
| Climatic proofing | | Damp heat, constant, to IEC 60 068-2-78 Damp heat, cyclic, to IEC 60 068-2-30 | | | | | |
| Ambient temperature | min./max. °C | -25 ... +60 | -25 ... +60 | -25 ... +60 | | | -25 ... +60 |
| Mounting position | | Any | Any | Any | | | Any |
| Degree of protection | IP | 65 | 65 | 65 | | | 65 |
| Dimensions | | | | | | | |
| Width | mm | 100 | 100 | 160 | | | |
| Height | mm | 215 | 215 | 305 | | | |
| Depth | mm | 130 | 130 | 210 | | | |
| Weight | kg | 0.42 | 0.42 | 2.2 | | | |
| Lockable in OFF position | | Yes | Yes | Yes | | | |
| Rated short-time withstand current I_{cw} , 1 s to EN 60947-3 | kA | 0.24 | 0.36 | 0.72 | | | |
| Rated short-circuit making capacity to EN 60947-3 | I_{cm} kA | 0.32 | 0.32 | 0.6 | | | |
| Internal resistance | mΩ | 8 | 7 | 4 | | | |

P-SOL, SOL

| | | P-SOL20 | | P-SOL30 | | P-SOL60 | |
|---|-----------------|--|-------------|-------------------------|--|---------|-------------|
| Rated operational current at DC-21A | I_e A | 20 | 30 | 63 | | | |
| Number of poles | | 2 | 2 | 2 | | | |
| Rated operational voltage | U_e V DC | 1000 | 1000 | 1000 | | | |
| Isolating characteristics | | Yes | Yes | Yes | | | |
| Standards | | IEC/EN 60 947-3 UL 508, TÜV certificate | | | | | |
| Lifespan mechanical | Operations | 100,000 | 100,000 | 100,000 | | | 30,000 |
| Lifespan electrical | Operations | 100,000 | 100,000 | 100,000 | | | 30,000 |
| Max. operating frequency, mechanical | Ops/h | 120 | 120 | 120 | | | 120 |
| Climatic proofing | | Damp heat, constant, to IEC 60 068-2-78 Damp heat, cyclic, to IEC 60 068-2-30 | | | | | |
| Ambient temperature | | | | | | | |
| Open | min./max. °C | -25 ... +60 | -25 ... +60 | -25 ... +60 | | | -25 ... +60 |
| Mounting position | | Any | Any | Any | | | Any |
| Dimensions | | | | | | | |
| Width | mm | 58 | 58 | 55 | | | |
| Height | mm | 93 | 93 | 140 | | | |
| Depth | mm | 76 | 76 | 160 | | | |
| Mounting | | | | | | | |
| Top-hat rail | | 35 mm | 35 mm | 35 mm | | | |
| Screw mounting | | – | – | 2 x M4 x 18 30 x 130 | | | |
| Weight | kg | 0.32 | 0.32 | 1.25 | | | |
| Terminals | | | | | | | |
| Flexible with ferrule | mm ² | 1 x (1-6) | 1 x (1-6) | 1 x (1-35) | | | |
| | mm ² | 2 x (1-6) | 2 x (1-6) | 2 x (1-35) | | | |
| solid/stranded | AWG | 18 - 14 | 18 - 14 | 14 - 2 | | | |
| Rated short-time withstand current I_{cw} , 1 s to EN 60947-3 | kA | 0.24 | 0.36 | 0.72 | | | |
| Rated short-circuit making capacity to EN 60947-3 | I_{cm} kA | 0.32 | 0.32 | 0.6 | | | |
| Internal resistance | mΩ | 6 | 5 | 3 | | | |

PKZ-SOL

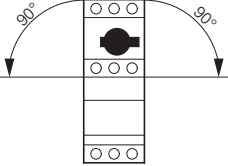
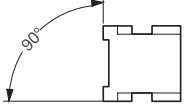
| | | | PKZ-SOL12 | PKZ-SOL20 | PKZ-SOL30 | PKZ-SOL40 | PKZ-SOL50 | PKZ-SOL60 |
|--|-----------------|------|---|-------------|-------------|---|-------------------------|-------------------------|
| Rated operational current at DC-21A/750VDC | I_e | A | 12 | 20 | 30 | 40 | 50 | 63 |
| Number of poles | | | 2 | 2 | 2 | 2 | 2 | 2 |
| Rated operational voltage | U_e | V DC | 900 | 900 | 900 | 900 | 900 | 900 |
| Thermal tripping | | | 1.05 ... 1.3 x I_e | | | | | |
| Electromagnetic tripping | | | 6 x I_e | | | | | |
| Standards | | | IEC/EN 60 947-2 UL 508, TÜV certificate | | | | | |
| Climatic proofing | | | Damp heat, constant, to IEC 60 068-2-78 Damp heat, cyclic, to IEC 60 068-2-30 | | | | | |
| Ambient temperature | | | | | | | | |
| Open | min./max. | °C | -25 ... +60 | -25 ... +60 | -25 ... +60 | -25 ... +60 | -25 ... +60 | -25 ... +60 |
| Mounting position | | |  | | |  | | |
| | | | PKZ-SOL12 to PKZ-SOL60 | | | PKZ-SOL12 to PKZ-SOL30 | | |
| Dimensions | | | | | | | | |
| Width | mm | | 58 | 58 | 58 | 55 | 55 | 55 |
| Height | mm | | 93 | 93 | 93 | 140 | 140 | 140 |
| Depth | mm | | 76 | 76 | 76 | 160 | 160 | 160 |
| Mounting | | | | | | | | |
| Top-hat rail | | | 35 mm | 35 mm | 35 mm | 35 mm | 35 mm | 35 mm |
| Screw mounting | | | – | – | – | 2 x M4 x 18 30 x 130 | 2 x M4 x 18 30 x 130 | 2 x M4 x 18 30 x 130 |
| Weight | kg | | 0.32 | 0.32 | 0.32 | 1.25 | 1.25 | 1.25 |
| Terminals | | | | | | | | |
| flexible with ferrule | mm ² | | 1 x (1-6) | 1 x (1-6) | 1 x (1-6) | 1 x (1-35) | 1 x (1-35) | 1 x (1-35) |
| | mm ² | | 2 x (1-6) | 2 x (1-6) | 2 x (1-6) | 2 x (1-35) | 2 x (1-35) | 2 x (1-35) |
| solid/stranded | AWG | | 18 - 14 | 18 - 14 | 18 - 14 | 14 - 2 | 14 - 2 | 14 - 2 |
| Internal resistance | mΩ | | 31 | 12 | 7 | – | – | – |

1

1.3

DC switch-disconnectors, DC string circuit-breakers

DC string circuit-breakers, open

1 Dimensions

P-SOL, PKZ-SOL, SOL

P-SOL20
P-SOL30
PKZ-SOL12
PKZ-SOL20
PKZ-SOL30

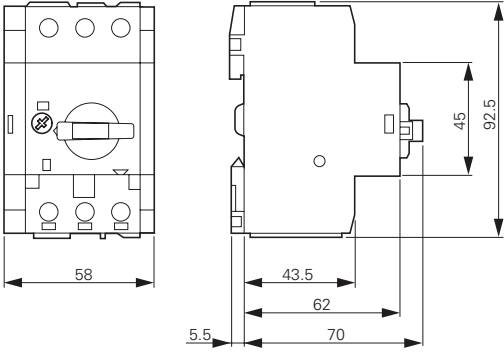

P-SOL60
PKZ-SOL40
PKZ-SOL50
PKZ-SOL60

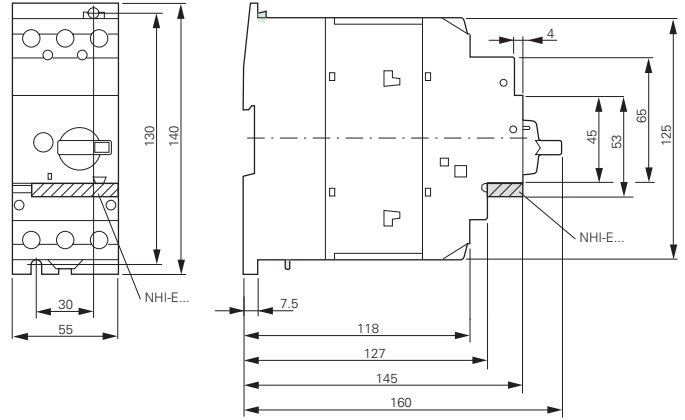

SOL

SOL20
SOL30

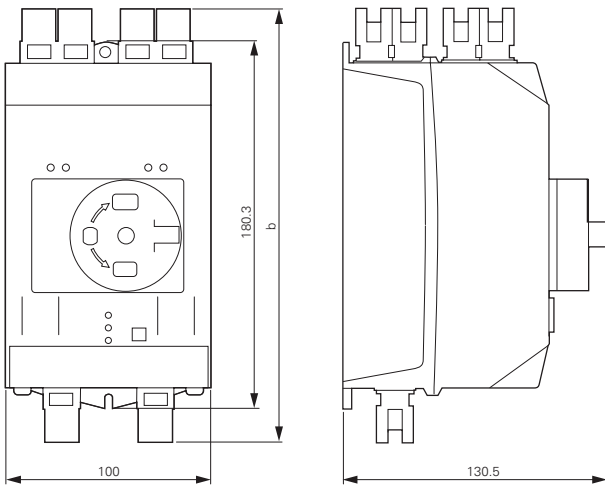

SOL60

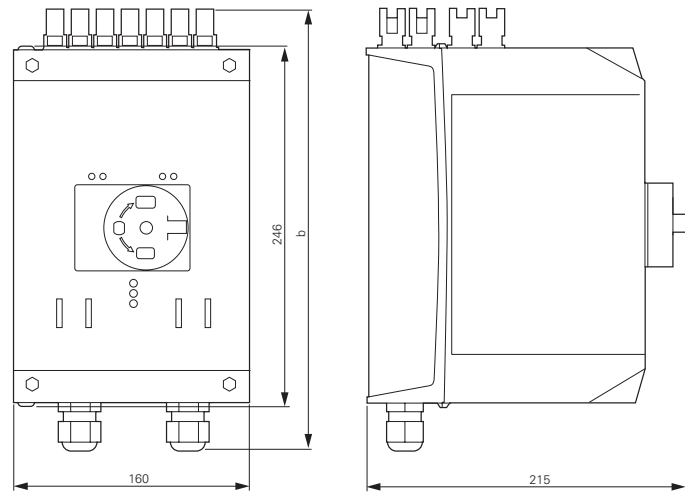

| Connection type | b mm |
|-----------------|---------|
| MC3 | 195 |
| MC4 | 234 |
| MV | 224 |

| Connection type | b mm |
|-----------------|---------|
| MC3 | 275 |
| MC4 | 314 |
| MV | 304 |



Motor-starter combinations

Combining a motor protective circuit breaker or circuit breaker with a contactor results in a motor starter according to coordination type "1" or "2". Both types of coordination safely control short-circuit by switching it off. Coordination type "2" starters offer a high degree of operational continuity: after the cause of the short circuit has been removed, they can be switched back on immediately.

Motor-starter combination - motor starter up to 1400 A

- Highest safety through proven combination in coordination type "1" or "2"
- Approved combinations for export to North America

DOL starter and reversing starter MSC... – motor starter with motor-protective circuit-breaker PKZM0 up to 32A

- Mounted starters minimize wiring time
- Plug & Play with starters on busbar adapters
- Attractive design for high-quality installations
- Direct field bus connection through SmartWire-DT® communication system via plug-in type protective module

DOL starter and reversing starter MSC-DE... – motor starter with electric motor-protective circuit-breaker PKE up to 32A

- Increased safety through separate contact systems between switching and safety devices
- Direct field bus connection through SmartWire-DT® communication system via plug-in type protective module
- Direct reading of motor current and state, transfer to subordinate control system through SmartWire-DT®

Conditions for fulfilling type of coordination

- Coordination type: "1": Secure switching off of the entered short-circuit current I_q
- No danger to personnel or installations in case of short-circuit
- For further operation without repair and partial renewal, switch does not need to be suitable
- Damage to the switch or individual components approved
- Coordination type: "2": Secure switching off of the entered short-circuit current I_q
- No danger to personnel or installations in case of short-circuit
- Switch remains suitable for further operation
- No damage to switch, except to welds of protective contacts, when these can be easily separated without significant deformation





Ordering

| | |
|-------------------------------|----|
| Direct-on-line starters MSC-D | |
| MSC-D complete units | 2 |
| MSC-US complete units | 4 |
| MSC-DEA complete units | 6 |
| Modules PKZM0/PKZM4 + DILM | 8 |
| Modules NZMN/NZMH + DILM | 12 |
| Modules PKM0 + DILM + ZB | 16 |
| Modules NZMN + DILM + ZB | 16 |

Ordering

| | |
|----------------------------|----|
| Reversing starter MSC-R | |
| MSC-R complete units | 18 |
| Modules PKZM0/PKZM4 + DILM | 20 |
| Modules NZMN/NZMH + DILM | 22 |

Ordering

| | |
|---|----|
| Starter on busbar adapter | |
| DOL starter complete units MSC-D/BBA | 24 |
| Reversing starters complete units MSC-R/BBA | 26 |

Ordering

| | |
|---|----|
| Starter for North America | |
| Modules type F starter combinations | 28 |
| Modules DILEM/DILM + ZE/ZB/Z5/ZW7 | 29 |
| Modules NZMH-...-CNA + DILM + ZB/Z5/ZW7 | 30 |

System overview, description

| | |
|---------------------------------|----|
| Connection system SmartWire-DT® | 31 |
|---------------------------------|----|

Ordering

| | |
|---------------------------------|----|
| Connection system SmartWire-DT® | 32 |
| Accessories | 33 |

Engineering

| | |
|---------------------------------|----|
| Connection system SmartWire-DT® | 34 |
|---------------------------------|----|

Technical data

| | |
|---------------------------------|----|
| Connection system SmartWire-DT® | 35 |
| DOL starters MSC-D, MSC-DE(A) | 39 |
| Reversing starter MSC-R | 39 |

Dimensions

| | |
|---------------------------------|----|
| Direct-on-line starter MSC-D | |
| MSC-D complete units | 39 |
| MSC-D/BBA complete units | 39 |
| MSC-DE(A) complete units | 40 |
| Reversing starter MSC-R | |
| MSC-R complete units | 40 |
| MSC-R/BBA complete units | 40 |
| Connection system SmartWire-DT® | 41 |

1.4

Motor-starter combinations

Complete units

Ordering

1

MSC-D: PKZM0, DILM

| Motor data | | | | Setting range | | Motor starters actuating voltage 230 V 50 Hz | Part no. Article no. | Price See price list | Std. pack |
|-------------------------|---------------------------------|-----------------------------|--------------------------|------------------|--------------------------|---|-------------------------|----------------------------|--------------|
| Motor rating | Rated operational current | Rated short-circuit current | | Overload trip | Short-circuit release | | | | |
| AC-3 | AC-3 | 380 - 415 V | 380 - 415 V | | | | | | |
| 380 V 400 V 415 V | 400 V | Type "1" coordination | Type "2" coordination | | | | | | |
| P kW | I_b A | I_q kA | I_q kA | I_r A | I_{rm} A | | | | |
| 0.06 | 0.21 | 150 | 50 | 0.16 - 0.25 | 3.5 | MSC-D-0.25-M7(230V50Hz)¹⁾ 281925 | | 1 off | |
| 0.09 | 0.31 | 150 | 50 | 0.25 - 0.4 | 5.6 | MSC-D-0.4-M7(230V50Hz)¹⁾ 281926 | | 1 off | |
| 0.12 0.18 | 0.41 0.6 | 150 | 50 | 0.4 - 0.63 | 8.82 | MSC-D-0.63-M7(230V50Hz)¹⁾ 281927 | | 1 off | |
| 0.25 | 0.8 | 150 | 50 | 0.63 - 1 | 14 | MSC-D-1-M7(230V50Hz)¹⁾ 281929 | | 1 off | |
| 0.37 0.55 | 1.1 1.5 | 150 | 50 | 1 - 1.6 | 22.4 | MSC-D-1.6-M7(230V50Hz)¹⁾ 283140 | | 1 off | |
| 0.75 | 1.9 | 150 | 50 | 1.6 - 2.5 | 35 | MSC-D-2.5-M7(230V50Hz)¹⁾ 283142 | | 1 off | |
| 1.1 1.5 | 2.6 3.6 | 150 | 50 | 2.5 - 4 | 56 | MSC-D-4-M7(230V50Hz)¹⁾ 283143 | | 1 off | |
| 2.2 | 5 | 150 | 50 | 4 - 6.3 | 88.2 | MSC-D-6.3-M7(230V50Hz)¹⁾ 283145 | | 1 off | |
| 3 | 6.6 | 150 | – | 6.3 - 10 | 140 | MSC-D-10-M7(230V50Hz) 283146 | | 1 off | |
| 4 | 8.5 | 150 | – | 6.3 - 10 | 140 | MSC-D-10-M9(230V50Hz) 283147 | | 1 off | |
| 5.5 | 11.3 | 50 | – | 8 - 12 | 168 | MSC-D-12-M12(230V50Hz) 283148 | | 1 off | |
| 7.5 | 15.2 | 50 | – | 10 - 16 | 224 | MSC-D-16-M15(230V50Hz) 100414 | | 1 off | |
| 3 | 6.6 | 50 | 50 | 6.3 - 10 | 140 | MSC-D-10-M17(230V50Hz) 101045 | | 1 off | |
| 4 | 8.5 | 50 | 50 | 6.3 - 10 | 140 | MSC-D-10-M17(230V50Hz) 101045 | | 1 off | |
| 5.5 | 11.3 | 50 | 50 | 8 - 12 | 168 | MSC-D-12-M17(230V50Hz) 101046 | | 1 off | |
| 7.5 | 15.2 | 50 | 50 | 10 - 16 | 224 | MSC-D-16-M17(230V50Hz)¹⁾ 283150 | | 1 off | |
| 11 | 21.7 | 50 | 50 | 20 - 25 | 350 | MSC-D-25-M25(230V50Hz)¹⁾ 283151 | | 1 off | |
| 15 | 29.3 | 50 | 50 | 25 - 32 | 448 | MSC-D-32-M32(230V50Hz)¹⁾ 283152 | | 1 off | |

Complete units MSC-D

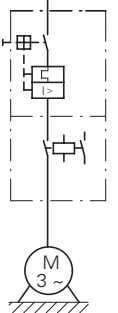
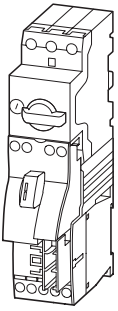

Complete units MSC-D

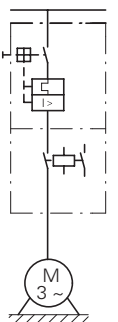
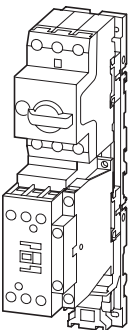

| Motor starters actuating voltage 24 V DC | Std. pack | Motor protective circuit breaker | Contactor | DOL starter wiring set | Notes | | | | | | | | | | | | |
|---|----------------------------|--|----------------|---------------------------|---|----------------------------|-------------|----------------------|---------------|-----------------|-------------------------|---------------------|---------------|----------------------------|-------------------------|------------------|-------------------------|
| Part no. Article no. | Price See price list | Type | Type | Type | | | | | | | | | | | | | |
| MSC-D-0.25-M7(24VDC) ¹⁾ 283154 | 1 off | PKZM0-0,25 | DILM7-10(...) | PKZM0-XDM12 | <p>The DOL starters (complete devices) consist of a motor protective circuit breaker PKZM0 and a contactor DILM. With the adapterless top-hat rail mounting of starters up to 15 A, only the motor-protective circuit-breaker on the top-hat rail requires an adapter. The contactors are provided with mechanical support via a mechanical connection element.</p> <p>Control wire guide with max. 6 conductors with up to 2.5 mm external diameter or 4 conductors up to 3.5 mm external diameter.</p> <p>From 16 A, the motor protective circuit breaker and contactors are mounted on the top-hat rail adapter plate. The connection of the main circuit between PKZ and contactor is established with electrical contact modules. When using auxiliary contacts DILA - XHIT... → Chapter 1.1 (Page 38) the electrical plugs can be pulled without having to remove the front mounting auxiliary contact.</p> <p>Cannot be combined with NHI-E-...-PKZ0-C standard auxiliary contact with spring-loaded terminal.</p> | | | | | | | | | | | | |
| MSC-D-0.4-M7(24VDC) ¹⁾ 283155 | 1 off | PKZM0-0,4 | DILM7-10(...) | PKZM0-XDM12 | | | | | | | | | | | | | |
| MSC-D-0.63-M7(24VDC) ¹⁾ 283156 | 1 off | PKZM0-0,63 | DILM7-10(...) | PKZM0-XDM12 | | | | | | | | | | | | | |
| MSC-D-1-M7(24VDC) ¹⁾ 283158 | 1 off | PKZM0-1 | DILM7-10(...) | PKZM0-XDM12 | | | | | | | | | | | | | |
| MSC-D-1.6-M7(24VDC) ¹⁾ 283159 | 1 off | PKZM0-1,6 | DILM7-10(...) | PKZM0-XDM12 | | | | | | | | | | | | | |
| MSC-D-2.5-M7(24VDC) ¹⁾ 283161 | 1 off | PKZM0-2,5 | DILM7-10(...) | PKZM0-XDM12 | | | | | | | | | | | | | |
| MSC-D-4-M7(24VDC) ¹⁾ 283162 | 1 off | PKZM0-4 | DILM7-10(...) | PKZM0-XDM12 | | | | | | | | | | | | | |
| MSC-D-6.3-M7(24VDC) ¹⁾ 283164 | 1 off | PKZM0-6,3 | DILM7-10(...) | PKZM0-XDM12 | | | | | | | | | | | | | |
| MSC-D-10-M7(24VDC) 283165 | 1 off | PKZM0-10 | DILM7-10(...) | PKZM0-XDM12 | | | | | | | | | | | | | |
| MSC-D-10-M9(24VDC) 283166 | 1 off | PKZM0-10 | DILM9-10(...) | PKZM0-XDM12 | | | | | | | | | | | | | |
| MSC-D-12-M12(24VDC) 283167 | 1 off | PKZM0-12 | DILM12-10(...) | PKZM0-XDM12 | <table border="0"> <tr> <td>Further information</td> <td>Page</td> </tr> <tr> <td>Technical data PKZM0</td> <td>→ Chapter 1.3</td> </tr> <tr> <td>Accessories PKZ</td> <td>→ Chapter 1.3 (Page 10)</td> </tr> <tr> <td>Technical data DILM</td> <td>→ Chapter 1.1</td> </tr> <tr> <td>Further actuating voltages</td> <td>→ Chapter 1.1 (Page 69)</td> </tr> <tr> <td>DILM accessories</td> <td>→ Chapter 1.1 (Page 50)</td> </tr> </table> | Further information | Page | Technical data PKZM0 | → Chapter 1.3 | Accessories PKZ | → Chapter 1.3 (Page 10) | Technical data DILM | → Chapter 1.1 | Further actuating voltages | → Chapter 1.1 (Page 69) | DILM accessories | → Chapter 1.1 (Page 50) |
| Further information | Page | | | | | | | | | | | | | | | | |
| Technical data PKZM0 | → Chapter 1.3 | | | | | | | | | | | | | | | | |
| Accessories PKZ | → Chapter 1.3 (Page 10) | | | | | | | | | | | | | | | | |
| Technical data DILM | → Chapter 1.1 | | | | | | | | | | | | | | | | |
| Further actuating voltages | → Chapter 1.1 (Page 69) | | | | | | | | | | | | | | | | |
| DILM accessories | → Chapter 1.1 (Page 50) | | | | | | | | | | | | | | | | |
| MSC-D-10-M17(24VDC) 101047 | 1 off | PKZM0-10 | DILM17-10(...) | PKZM0-XDM32 | | | | | | | | | | | | | |
| MSC-D-12-M17(24VDC) 101048 | 1 off | PKZM0-12 | DILM17-10(...) | PKZM0-XDM32 | | | | | | | | | | | | | |
| MSC-D-16-M17(24VDC) 283168 | 1 off | PKZM0-16 | DILM17-10(...) | PKZM0-XDM32 | | | | | | | | | | | | | |
| MSC-D-25-M25(24VDC) 283169 | 1 off | PKZM0-25 | DILM25-10(...) | PKZM0-XDM32 | | | | | | | | | | | | | |
| MSC-D-32-M32(24VDC) 283170 | 1 off | PKZM0-32 | DILM32-10(...) | PKZM0-XDM32 | | | | | | | | | | | | | |

¹⁾ To assemble Type F starters that conform with UL508, incoming terminals BK25/3-PKZ0-E and, if necessary, three-phase terminal blocks B3.../...-PKZ0 can be added to motor starter combinations. Type F starter → Page 28

1.4

Motor-starter combinations

Complete units 400/415 V

1

MSC-DE: PKE, DILM

| Motor data | | | Setting range | | | Motor starters actuating voltage 230 V 50 Hz | Std. pack |
|---------------------------------------|---|------------------------------------|------------------|------------------------------|------------------------------|--|----------------------------|
| Rated operational power AC-3 | Rated operational current AC-3 | Rated short- circuit current | Overload trip | Short- circuit release | Type of coordina- tion | Part no. Article no. | Price See price list |
| 380 V 400 V 415 V | 400 V | 380 - 415 V | | | | | |
| P kW | I_e A | I_q kA | I_r A | I_{rm} A | | | |
| 0.06 | 0.21 | 100 | 0.3 - 1.2 | 16.8 | "1" | MSC-DE-1.2-M7(230V50Hz) 121735 | 1 off |
| 0.09 | 0.31 | 100 | 0.3 - 1.2 | 16.8 | "1" | MSC-DE-1.2-M7(230V50Hz) 121735 | 1 off |
| 0.12 | 0.41 | 100 | 0.3 - 1.2 | 16.8 | "1" | MSC-DE-1.2-M7(230V50Hz) 121735 | 1 off |
| 0.18 | 0.6 | 100 | 0.3 - 1.2 | 16.8 | "1" | MSC-DE-1.2-M7(230V50Hz) 121735 | 1 off |
| 0.25 | 0.8 | 100 | 0.3 - 1.2 | 16.8 | "1" | MSC-DE-1.2-M7(230V50Hz) 121735 | 1 off |
| 0.37 | 1.1 | 100 | 0.3 - 1.2 | 16.8 | "1" | MSC-DE-1.2-M7(230V50Hz) 121735 | 1 off |
| 0.55 | 1.5 | 100 | 1 - 4 | 56 | "1" | MSC-DE-4-M7(230V50Hz) 121737 | 1 off |
| 0.75 | 1.9 | 100 | 1 - 4 | 56 | "1" | MSC-DE-4-M7(230V50Hz) 121737 | 1 off |
| 1.1 | 2.6 | 100 | 1 - 4 | 56 | "1" | MSC-DE-4-M7(230V50Hz) 121737 | 1 off |
| 1.5 | 3.6 | 100 | 1 - 4 | 56 | "1" | MSC-DE-4-M7(230V50Hz) 121737 | 1 off |
| 2.2 | 5 | 100 | 3 - 12 | 168 | "1" | MSC-DE-12-M7(230V50Hz) 121739 | 1 off |
| 3 | 6.6 | 100 | 3 - 12 | 168 | "1" | MSC-DE-12-M7(230V50Hz) 121739 | 1 off |
| 4 | 8.5 | 100 | 3 - 12 | 168 | "1" | MSC-DE-12-M9(230V50Hz) 121741 | 1 off |
| 5.5 | 11.3 | 100 | 3 - 12 | 168 | "1" | MSC-DE-12-M12(230V50Hz) 121743 | 1 off |
| 2.2 | 5 | 100 | 3 - 12 | 168 | "1", "2" | MSC-DE-12-M17(230V50Hz) 121745 | 1 off |
| 3 | 6.6 | 100 | 3 - 12 | 168 | "1", "2" | MSC-DE-12-M17(230V50Hz) 121745 | 1 off |
| 4 | 8.5 | 100 | 3 - 12 | 168 | "1", "2" | MSC-DE-12-M17(230V50Hz) 121745 | 1 off |
| 5.5 | 11.3 | 100 | 3 - 12 | 168 | "1", "2" | MSC-DE-12-M17(230V50Hz) 121745 | 1 off |
| 7.5 | 16.7 | 100 | 8 - 32 | 448 | "1", "2" | MSC-DE-32-M17(230V50Hz) 121747 | 1 off |
| 11 | 21.7 | 100 | 8 - 32 | 448 | "1", "2" | MSC-DE-32-M25(230V50Hz) 121749 | 1 off |
| 15 | 29.3 | 100 | 8 - 32 | 448 | "1", "2" | MSC-DE-32-M32(230V50Hz) 121751 | 1 off |

Complete units MSC-US

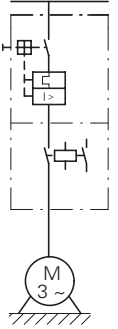
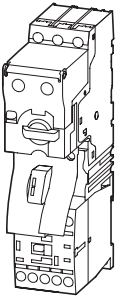

Complete units MSC-US

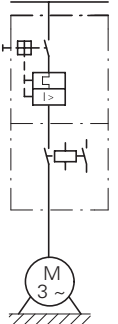
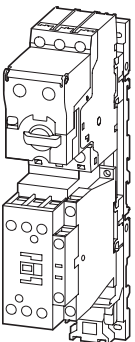

| Motor starters actuating voltage 24 V DC | Std. pack | Motor protective circuit breaker | Contactor | DOL starter wiring set | Notes |
|--|----------------------------|--|----------------|---------------------------|--|
| Part no. Article no. | Price See price list | Type | Type | Type | |
| MSC-DE-1.2-M7(24VDC) 121736 | 1 off | PKE12/XTU-1.2 | DILM7-10(...) | PKZM0-XDM12 | <p>The DOL starters (complete devices) consist of a PKE motor protective circuit breaker and a DILM contactor. With the adapterless top-hat rail mounting of starters up to 15 A, only the motor protective circuit breaker on the top-hat rail requires an adapter. The contactors are provided with mechanical support via a mechanical connection element. Control wire guide with max. 6 conductors with up to 2.5 mm external diameter or 4 conductors up to 3.5 mm external diameter. From 16 A, the motor protective circuit breaker and contactor are mounted on the top-hat rail adapter plate. The connection of the main circuit between PKE and contactor is established with electrical contact modules. When using auxiliary contacts DILA-XHIT... → Chapter 1.1 (Page 38) the electrical plugs can be pulled without having to remove the front mounting auxiliary contact. Cannot be combined with standard auxiliary contact NHI-E....-PKZ0-C with spring-loaded terminals.</p> |
| MSC-DE-1.2-M7(24VDC) 121736 | 1 off | PKE12/XTU-1.2 | DILM7-10(...) | PKZM0-XDM12 | |
| MSC-DE-1.2-M7(24VDC) 121736 | 1 off | PKE12/XTU-1.2 | DILM7-10(...) | PKZM0-XDM12 | |
| MSC-DE-1.2-M7(24VDC) 121736 | 1 off | PKE12/XTU-1.2 | DILM7-10(...) | PKZM0-XDM12 | |
| MSC-DE-1.2-M7(24VDC) 121736 | 1 off | PKE12/XTU-1.2 | DILM7-10(...) | PKZM0-XDM12 | |
| MSC-DE-1.2-M7(24VDC) 121736 | 1 off | PKE12/XTU-1.2 | DILM7-10(...) | PKZM0-XDM12 | |
| MSC-DE-4-M7(24VDC) 121738 | 1 off | PKE12/XTU-4 | DILM7-10(...) | PKZM0-XDM12 | |
| MSC-DE-4-M7(24VDC) 121738 | 1 off | PKE12/XTU-4 | DILM7-10(...) | PKZM0-XDM12 | |
| MSC-DE-4-M7(24VDC) 121738 | 1 off | PKE12/XTU-4 | DILM7-10(...) | PKZM0-XDM12 | |
| MSC-DE-4-M7(24VDC) 121738 | 1 off | PKE12/XTU-4 | DILM7-10(...) | PKZM0-XDM12 | |
| MSC-DE-12-M7(24VDC) 121740 | 1 off | PKE12/XTU-12 | DILM7-10(...) | PKZM0-XDM12 | <p>Further information</p> <p>Technical data PKE → Chapter 1.3</p> <p>Accessories PKE → Chapter 1.3 (Page 10)</p> <p>Technical data DILM → Chapter 1.1</p> <p>Further actuating voltages → Chapter 1.1 (Page 69)</p> <p>DILM accessories → Chapter 1.1 (Page 50)</p> |
| MSC-DE-12-M7(24VDC) 121740 | 1 off | PKE12/XTU-12 | DILM7-10(...) | PKZM0-XDM12 | |
| MSC-DE-12-M9(24VDC) 121742 | 1 off | PKE12/XTU-12 | DILM9-10(...) | PKZM0-XDM12 | |
| MSC-DE-12-M12(24VDC) 121744 | 1 off | PKE12/XTU-12 | DILM12-10(...) | PKZM0-XDM12 | |
| MSC-DE-12-M17(24VDC) 121746 | 1 off | PKE12/XTU-12 | DILM17-10(...) | PKZM0-XDM32 | |
| MSC-DE-12-M17(24VDC) 121746 | 1 off | PKE12/XTU-12 | DILM17-10(...) | PKZM0-XDM32 | |
| MSC-DE-12-M17(24VDC) 121746 | 1 off | PKE12/XTU-12 | DILM17-10(...) | PKZM0-XDM32 | |
| MSC-DE-12-M17(24VDC) 121746 | 1 off | PKE12/XTU-12 | DILM17-10(...) | PKZM0-XDM32 | |
| MSC-DE-32-M17(24VDC) 121748 | 1 off | PKE32/XTU-32 | DILM17-10(...) | PKZM0-XDM32 | |
| MSC-DE-32-M25(24VDC) 121750 | 1 off | PKE32/XTU-32 | DILM25-10(...) | PKZM0-XDM32 | |
| MSC-DE-32-M32(24VDC) 121752 | 1 off | PKE32/XTU-32 | DILM32-10(...) | PKZM0-XDM32 | |

1.4

Motor-starter combinations

Complete units 400/415 V



1

MSC-DEA: PKE, DILM

Motor data

Setting range

| Rated operational power AC-3 380 V 400 V 415 V | Rated operational current AC-3 400 V | Rated short-circuit current 380 - 415 V | Overload trip | Short-circuit release | Type of coordination |
|--|--|--|---------------|-----------------------|----------------------|
|--|--|--|---------------|-----------------------|----------------------|

| P kW | I_e A | I_q kA | I_r A  | I_{rm} A  | |
|---------|------------|-------------|---|---|----------|
| 0.06 | 0.21 | 100 | 0.3 - 1.2 | 16.8 | "1" |
| 0.09 | 0.31 | 100 | 0.3 - 1.2 | 16.8 | "1" |
| 0.12 | 0.41 | 100 | 0.3 - 1.2 | 16.8 | "1" |
| 0.18 | 0.6 | 100 | 0.3 - 1.2 | 16.8 | "1" |
| 0.25 | 0.8 | 100 | 0.3 - 1.2 | 16.8 | "1" |
| 0.37 | 1.1 | 100 | 0.3 - 1.2 | 16.8 | "1" |
| 0.55 | 1.5 | 100 | 1 - 4 | 56 | "1" |
| 0.75 | 1.9 | 100 | 1 - 4 | 56 | "1" |
| 1.1 | 2.6 | 100 | 1 - 4 | 56 | "1" |
| 1.5 | 3.6 | 100 | 1 - 4 | 56 | "1" |
| 2.2 | 5 | 100 | 3 - 12 | 168 | "1" |
| 3 | 6.6 | 100 | 3 - 12 | 168 | "1" |
| 4 | 8.5 | 100 | 3 - 12 | 168 | "1" |
| 5.5 | 11.3 | 100 | 3 - 12 | 168 | "1" |
| 2.2 | 5 | 100 | 3 - 12 | 168 | "1", "2" |
| 3 | 6.6 | 100 | 3 - 12 | 168 | "1", "2" |
| 4 | 8.5 | 100 | 3 - 12 | 168 | "1", "2" |
| 5.5 | 11.3 | 100 | 3 - 12 | 168 | "1", "2" |
| 7.5 | 16.7 | 100 | 8 - 32 | 448 | "1", "2" |
| 11 | 21.7 | 100 | 8 - 32 | 448 | "1", "2" |
| 15 | 29.3 | 100 | 8 - 32 | 448 | "1", "2" |

Complete devices MSD-DEA

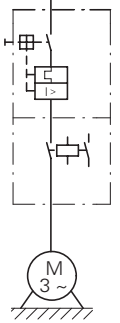
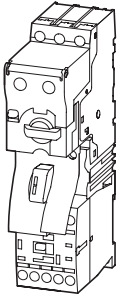

Complete devices MSD-DEA

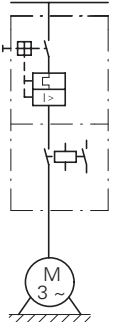
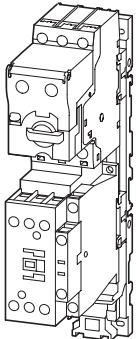

| Motor starters actuating voltage 24 V DC | Std. pack | Motor protective circuit breaker | Contactor | DOL starter wiring set | Notes | | | | | | | | | | | | |
|--|----------------------------|--|----------------|---------------------------|--|----------------------------|-------------|--------------------|---------------|-----------------|-------------------------|---------------------|---------------|----------------------------|-------------------------|------------------|-------------------------|
| Part no. Article no. | Price See price list | Type | Type | Type | | | | | | | | | | | | | |
| MSC-DEA-1.2-M7(24VDC) 121753 | 1 off | PKE12/XTUA-1.2 | DILM7-10(...) | PKZM0-XDM12 | <p>The DOL starters (complete devices) consist of a PKE motor protective circuit breaker and a DILM contactor. With the adapterless top-hat rail mounting of starters up to 15 A, only the motor protective circuit breaker on the top-hat rail requires an adapter. The contactors are provided with mechanical support via a mechanical connection element. Control wire guide with max. 6 conductors with up to 2.5 mm external diameter or 4 conductors up to 3.5 mm external diameter. From 16 A, the motor protective circuit breaker and contactor are mounted on the top-hat rail adapter plate. The connection of the main circuit between PKE and contactor is established with electrical contact modules. When using auxiliary contacts DILA - XHIT... → Chapter 1.1 (Page 38) the electrical plugs can be pulled without having to remove the front mounting auxiliary contact. Cannot be combined with standard auxiliary contact NHI-E-...-PKZO-C with spring-loaded terminals. The DOL starters MSC-DEA... are prepared for communication via SmartWire-DT®. For this the SWD-PKE communication must be added.</p> <table border="0"> <tr> <td>Further information</td> <td>Page</td> </tr> <tr> <td>Technical data PKE</td> <td>→ Chapter 1.3</td> </tr> <tr> <td>Accessories PKE</td> <td>→ Chapter 1.3 (Page 10)</td> </tr> <tr> <td>Technical data DILM</td> <td>→ Chapter 1.1</td> </tr> <tr> <td>Further actuating voltages</td> <td>→ Chapter 1.1 (Page 69)</td> </tr> <tr> <td>DILM accessories</td> <td>→ Chapter 1.1 (Page 50)</td> </tr> </table> | Further information | Page | Technical data PKE | → Chapter 1.3 | Accessories PKE | → Chapter 1.3 (Page 10) | Technical data DILM | → Chapter 1.1 | Further actuating voltages | → Chapter 1.1 (Page 69) | DILM accessories | → Chapter 1.1 (Page 50) |
| Further information | Page | | | | | | | | | | | | | | | | |
| Technical data PKE | → Chapter 1.3 | | | | | | | | | | | | | | | | |
| Accessories PKE | → Chapter 1.3 (Page 10) | | | | | | | | | | | | | | | | |
| Technical data DILM | → Chapter 1.1 | | | | | | | | | | | | | | | | |
| Further actuating voltages | → Chapter 1.1 (Page 69) | | | | | | | | | | | | | | | | |
| DILM accessories | → Chapter 1.1 (Page 50) | | | | | | | | | | | | | | | | |
| MSC-DEA-1.2-M7(24VDC) 121753 | 1 off | PKE12/XTUA-1.2 | DILM7-10(...) | PKZM0-XDM12 | | | | | | | | | | | | | |
| MSC-DEA-1.2-M7(24VDC) 121753 | 1 off | PKE12/XTUA-1.2 | DILM7-10(...) | PKZM0-XDM12 | | | | | | | | | | | | | |
| MSC-DEA-1.2-M7(24VDC) 121753 | 1 off | PKE12/XTUA-1.2 | DILM7-10(...) | PKZM0-XDM12 | | | | | | | | | | | | | |
| MSC-DEA-1.2-M7(24VDC) 121753 | 1 off | PKE12/XTUA-1.2 | DILM7-10(...) | PKZM0-XDM12 | | | | | | | | | | | | | |
| MSC-DEA-1.2-M7(24VDC) 121753 | 1 off | PKE12/XTUA-1.2 | DILM7-10(...) | PKZM0-XDM12 | | | | | | | | | | | | | |
| MSC-DEA-4-M7(24VDC) 121754 | 1 off | PKE12/XTUA-4 | DILM7-10(...) | PKZM0-XDM12 | | | | | | | | | | | | | |
| MSC-DEA-4-M7(24VDC) 121754 | 1 off | PKE12/XTUA-4 | DILM7-10(...) | PKZM0-XDM12 | | | | | | | | | | | | | |
| MSC-DEA-4-M7(24VDC) 121754 | 1 off | PKE12/XTUA-4 | DILM7-10(...) | PKZM0-XDM12 | | | | | | | | | | | | | |
| MSC-DEA-4-M7(24VDC) 121754 | 1 off | PKE12/XTUA-4 | DILM7-10(...) | PKZM0-XDM12 | | | | | | | | | | | | | |
| MSC-DEA-12-M7(24VDC) 121755 | 1 off | PKE12/XTUA-12 | DILM7-10(...) | PKZM0-XDM12 | | | | | | | | | | | | | |
| MSC-DEA-12-M7(24VDC) 121755 | 1 off | PKE12/XTUA-12 | DILM7-10(...) | PKZM0-XDM12 | | | | | | | | | | | | | |
| MSC-DEA-12-M9(24VDC) 121756 | 1 off | PKE12/XTUA-12 | DILM9-10(...) | PKZM0-XDM12 | | | | | | | | | | | | | |
| MSC-DEA-12-M12(24VDC) 121757 | 1 off | PKE12/XTUA-12 | DILM12-10(...) | PKZM0-XDM12 | | | | | | | | | | | | | |
| MSC-DEA-12-M17(24VDC) 121758 | 1 off | PKE12/XTUA-12 | DILM17-10(...) | PKZM0-XDM32 | | | | | | | | | | | | | |
| MSC-DEA-12-M17(24VDC) 121758 | 1 off | PKE12/XTUA-12 | DILM17-10(...) | PKZM0-XDM32 | | | | | | | | | | | | | |
| MSC-DEA-12-M17(24VDC) 121758 | 1 off | PKE12/XTUA-12 | DILM17-10(...) | PKZM0-XDM32 | | | | | | | | | | | | | |
| MSC-DEA-12-M17(24VDC) 121758 | 1 off | PKE12/XTUA-12 | DILM17-10(...) | PKZM0-XDM32 | | | | | | | | | | | | | |
| MSC-DEA-32-M17(24VDC) 121759 | 1 off | PKE32/XTUA-32 | DILM17-10(...) | PKZM0-XDM32 | | | | | | | | | | | | | |
| MSC-DEA-32-M25(24VDC) 121760 | 1 off | PKE32/XTUA-32 | DILM25-10(...) | PKZM0-XDM32 | | | | | | | | | | | | | |
| MSC-DEA-32-M32(24VDC) 121761 | 1 off | PKE32/XTUA-32 | DILM32-10(...) | PKZM0-XDM32 | | | | | | | | | | | | | |

1.4



Motor-starter combinations Modules

1

PKZM, DILM

Motor data

Setting range

| Rated operational power | Rated operational current | 380 - 415 V | | Overload trip | Short-circuit release |
|-------------------------|---------------------------|-----------------------|-----------------------|---|---|
| AC-3 | AC-3 | Type "1" coordination | Type "2" coordination | | |
| 380 V 400 V 415 V | 400 V | | | I_r | I_m |
| P | I_e | I_q | I_q | A  | A  |
| kW | A | kA | kA | | |
| 0.06 | 0.21 | 150 | 50 | 0.16 - 0.25 | 3.5 |
| 0.09 | 0.31 | 150 | 50 | 0.25 - 0.4 | 5.6 |
| 0.12 | 0.41 | 150 | 50 | 0.4 - 0.63 | 8.82 |
| 0.18 | 0.6 | 150 | 50 | 0.4 - 0.63 | 8.82 |
| 0.25 | 0.8 | 150 | 50 | 0.63 - 1 | 14 |
| 0.37 | 1.1 | 150 | 50 | 1 - 1.6 | 22.4 |
| 0.55 | 1.5 | 150 | 50 | 1 - 1.6 | 22.4 |
| 0.75 | 1.9 | 150 | 50 | 1.6 - 2.5 | 35 |
| 1.1 | 2.6 | 150 | 50 | 2.5 - 4 | 56 |
| 1.5 | 3.6 | 150 | 50 | 2.5 - 4 | 56 |
| 2.2 | 5 | 150 | 50 | 4 - 6.3 | 88.2 |
| 3 | 6.6 | 150 | 50 | 6.3 - 10 | 140 |
| 4 | 8.5 | 150 | 50 | 6.3 - 10 | 140 |
| 5.5 | 11.3 | 50 | 50 | 8 - 12 | 168 |
| 7.5 | 15.2 | 50 | 50 | 10 - 16 | 224 |
| 11 | 21.7 | 50 | 50 | 20 - 25 | 350 |
| 15 | 29.3 | 50 | 50 | 25 - 32 | 448 |
| 5.5 | 11.3 | 50 | 50 | 10 - 16 | 224 |
| 7.5 | 15.2 | 50 | 50 | 10 - 16 | 224 |
| 11 | 21.7 | 50 | 50 | 20 - 25 | 350 |
| 15 | 29.3 | 50 | 50 | 25 - 32 | 448 |
| 18.5 | 36 | 50 | 50 | 32 - 40 | 560 |
| 22 | 41 | 50 | 50 | 40 - 50 | 700 |
| 30 | 55 | 50 | 50 | 50 - 58 | 812 |
| 34 | 63 | 50 | 50 | 55 - 65 | 882 |

Modules PKZM0 and DILM

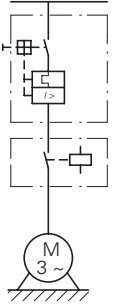
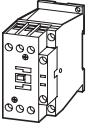
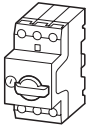

Modules PKZM4 and DILM

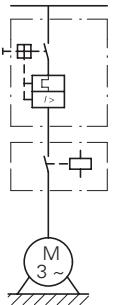
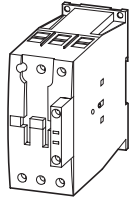
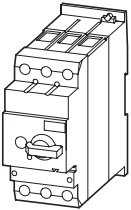

| Motor protective circuit breaker | Contactor | Contactor | Notes | |
|----------------------------------|-----------------------|-----------------------|--|--|
| Type | Type | Type | | |
| | Type "1" coordination | Type "2" coordination | | |
| PKZM0-0,25 | DILM7-...(…) | DILM7-...(…) | <p>The motor-starter combinations consist of the motor protective circuit breaker or a circuit breaker and a contactor. They conform with IEC/EN 60947-4-1 or VDE 0660 Part 102.</p> <p>I_q = conditional rated current</p> <p>Further information</p> <p>Technical data PKZM0</p> <p>Accessories PKZ</p> <p>Technical data DILM</p> <p>Further actuating voltages</p> <p>DILM accessories</p> | |
| PKZM0-0,4 | DILM7-...(…) | DILM7-...(…) | | |
| PKZM0-0,63 | DILM7-...(…) | DILM7-...(…) | | |
| PKZM0-0,63 | DILM7-...(…) | DILM7-...(…) | | |
| PKZM0-1 | DILM7-...(…) | DILM7-...(…) | | |
| PKZM0-1,6 | DILM7-...(…) | DILM7-...(…) | | |
| PKZM0-1,6 | DILM7-...(…) | DILM7-...(…) | | |
| PKZM0-2,5 | DILM7-...(…) | DILM7-...(…) | | |
| PKZM0-4 | DILM7-...(…) | DILM7-...(…) | | |
| PKZM0-4 | DILM7-...(…) | DILM7-...(…) | | |
| PKZM0-6,3 | DILM7-...(…) | DILM7-...(…) | <p>Page</p> <p>→ Chapter 1.3</p> <p>→ Chapter 1.3 (Page 10)</p> <p>→ Chapter 1.1</p> <p>→ Chapter 1.1 (Page 69)</p> <p>→ Chapter 1.1 (Page 50)</p> | |
| PKZM0-10 | DILM7-...(…) | DILM17-...(…) | | |
| PKZM0-10 | DILM9-...(…) | DILM17-...(…) | | |
| PKZM0-12 | DILM12-...(…) | DILM17-...(…) | | |
| PKZM0-16 | DILM15-...(…) | DILM17-...(…) | | |
| PKZM0-25 | DILM25-...(…) | DILM25-...(…) | | |
| PKZM0-32 | DILM32-...(…) | DILM32-...(…) | | |
| PKZM4-16 | DILM17-...(…) | DILM17-...(…) | | <p>The motor-starter combinations consist of the motor protective circuit breaker or a circuit breaker and a contactor. They conform with IEC/EN 60947-4-1 or VDE 0660 Part 102.</p> <p>I_q = conditional rated current</p> <p>Further information</p> <p>Technical data PKZM4</p> <p>Accessories PKZ</p> <p>Technical data DILM</p> <p>Further actuating voltages</p> <p>DILM accessories</p> |
| PKZM4-16 | DILM17-...(…) | DILM17-...(…) | | |
| PKZM4-25 | DILM25-...(…) | DILM25-...(…) | | |
| PKZM4-32 | DILM32-...(…) | DILM32-...(…) | | |
| PKZM4-40 | DILM40(…) | DILM40(…) | | |
| PKZM4-50 | DILM50(…) | DILM50(…) | | |
| PKZM4-58 | DILM65(…) | DILM65(…) | | |
| PKZM4-63 | DILM65(…) | DILM65(…) | | |
| | | | <p>Page</p> <p>→ Chapter 1.3</p> <p>→ Chapter 1.3 (Page 10)</p> <p>→ Chapter 1.1</p> <p>→ Chapter 1.1 (Page 70)</p> <p>→ Chapter 1.1 (Page 50)</p> | |
| | | | | |

1.4

Motor-starter combinations Modules

1



PKZM, DILM

Motor data

| Rated operational power | Rated operational current | Rated short-circuit current | |
|-------------------------|---------------------------|-----------------------------|-----------------------|
| AC-3 | AC-3 | 500 V | 500 V |
| 500 V | 500 V | Type "1" coordination | Type "2" coordination |

Setting range

| Overload trip | Short-circuit release |
|---------------|-----------------------|
|---------------|-----------------------|

| P kW | I_e A | I_q kA | I_q kA | I_r A  | I_{rm} A  |
|---------|------------|-------------|-------------|--|---|
| 0.06 | 0.17 | 100 | 50 | 0.16 - 0.25 | 3.5 |
| 0.09 | 0.25 | 100 | 50 | 0.25 - 0.4 | 5.6 |
| 0.12 | 0.33 | 100 | 50 | 0.25 - 0.4 | 5.6 |
| 0.18 | 0.48 | 100 | 50 | 0.4 - 0.63 | 8.8 |
| 0.25 | 0.7 | 100 | 50 | 0.63 - 1 | 14 |
| 0.37 | 0.9 | 100 | 50 | 0.63 - 1 | 14 |
| 0.55 | 1.2 | 100 | 50 | 1 - 1.6 | 22 |
| 0.75 | 1.5 | 100 | 50 | 1 - 1.6 | 22 |
| 1.1 | 2.1 | 100 | 50 | 1.6 - 2.5 | 35 |
| 1.5 | 2.9 | 100 | 50 | 2.5 - 4 | 56 |
| 2.2 | 4 | 42 | 18 | 4 - 6.3 | 88 |
| 2.2 | 4 | — | 50 | 4 - 6.3 | 88 |
| 3 | 5.3 | 42 | 18 | 4 - 6.3 | 88 |
| 3 | 5.3 | — | 50 | 4 - 6.3 | 88 |
| 4 | 6.8 | 42 | 18 | 6.3 - 10 | 140 |
| 4 | 6.8 | — | 50 | 6.3 - 10 | 140 |
| 5.5 | 9 | 42 | 18 | 6.3 - 10 | 140 |
| 5.5 | 9 | — | 50 | 6.3 - 10 | 140 |
| 6.5 | 10.6 | 42 | 18 | 8 - 12 | 168 |
| 6.5 | 10.6 | — | 50 | 8 - 12 | 168 |
| 7.5 | 12.1 | 15 | 18 | 10 - 16 | 224 |
| 7.5 | 12.1 | — | 50 | 10 - 16 | 224 |
| 11 | 17.4 | 6 | — | 16 - 20 | 280 |
| 11 | 17.4 | 15 | — | 16 - 20 | 280 |
| 15 | 23.4 | 6 | — | 20 - 25 | 350 |
| 15 | 23.4 | 15 | — | 20 - 25 | 350 |
| 18.5 | 28.9 | 6 | — | 25 - 32 | 448 |
| 18.5 | 28.9 | 15 | — | 25 - 32 | 448 |
| 11 | 17.4 | 50 | 50 | 16 - 25 | 350 |
| 15 | 23.4 | 50 | 50 | 16 - 25 | 350 |
| 18.5 | 28.9 | 50 | 50 | 25 - 32 | 448 |
| 22 | 33 | 50 | 50 | 32 - 40 | 560 |
| 30 | 44 | 50 | 50 | 40 - 50 | 700 |
| 37 | 54 | 50 | 50 | 50 - 58 | 812 |
| 45 | 65 | 50 | 50 | 55 - 65 | 882 |

Modules PKZM0 and DILM

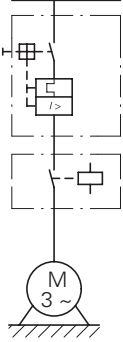
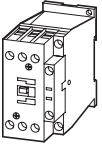
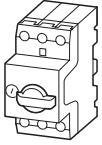

Modules PKZM4 and DILM

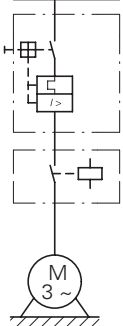
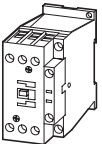
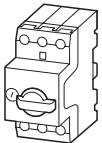

| Motor protective circuit breaker | Contactor Type "1" coordination | Contactor Type "2" coordination | Current limiter | Notes | |
|----------------------------------|------------------------------------|------------------------------------|-----------------|---|---|
| Type | Type | Type | Type | | |
| PKZM0-0,25 | DILM7-...(…) | DILM7-...(…) | – | The motor-starter combinations consist of the motor protective circuit breaker or a circuit breaker and a contactor. They conform with IEC/EN 60947-4-1 or VDE 0660 Part 102. I _q = rated conditional short-circuit current. | |
| PKZM0-0,4 | DILM7-...(…) | DILM7-...(…) | – | | |
| PKZM0-0,4 | DILM7-...(…) | DILM7-...(…) | – | | |
| PKZM0-0,63 | DILM7-...(…) | DILM7-...(…) | – | | |
| PKZM0-1 | DILM7-...(…) | DILM7-...(…) | – | | |
| PKZM0-1 | DILM7-...(…) | DILM7-...(…) | – | | |
| PKZM0-1,6 | DILM7-...(…) | DILM7-...(…) | – | | |
| PKZM0-1,6 | DILM7-...(…) | DILM7-...(…) | – | | |
| PKZM0-2,5 | DILM7-...(…) | DILM17-...(…) | – | | |
| PKZM0-4 | DILM7-...(…) | DILM17-...(…) | – | | |
| PKZM0-6,3 | DILM7-...(…) | DILM17-...(…) | – | Further information Technical data PKZM... PKZM accessories... Technical data DILM Further actuating voltages DILM accessories | |
| PKZM0-6,3 | – | DILM17-...(…) | CL-PKZ0 | | |
| PKZM0-6,3 | DILM7-...(…) | DILM17-...(…) | – | | |
| PKZM0-6,3 | – | DILM17-...(…) | CL-PKZ0 | | |
| PKZM0-10 | DILM9-...(…) | DILM17-...(…) | – | | |
| PKZM0-10 | – | DILM17-...(…) | CL-PKZ0 | | |
| PKZM0-10 | DILM9-...(…) | DILM17-...(…) | – | | |
| PKZM0-10 | – | DILM17-...(…) | CL-PKZ0 | | |
| PKZM0-12 | DILM12-...(…) | DILM17-...(…) | – | | |
| PKZM0-12 | – | DILM17-...(…) | CL-PKZ0 | | |
| PKZM0-16 | DILM17-...(…) | DILM17-...(…) | – | Further information Technical data PKZM... PKZM accessories... Technical data DILM Further actuating voltages DILM accessories | |
| PKZM0-16 | – | DILM17-...(…) | CL-PKZ0 | | |
| PKZM0-20 | DILM25-...(…) | – | – | | |
| PKZM0-20 | DILM25-...(…) | – | CL-PKZ0 | | |
| PKZM0-25 | DILM25-...(…) | – | – | | |
| PKZM0-25 | DILM25-...(…) | – | CL-PKZ0 | | |
| PKZM0-32 | DILM32-...(…) | – | – | | |
| PKZM0-32 | DILM32-...(…) | – | CL-PKZ0 | | |
| PKZM4-25 | DILM40(…) | DILM40(…) | – | | The motor-starter combinations consist of the motor protective circuit breaker or a circuit breaker and a contactor. They conform with IEC/EN 60947-4-1 or VDE 0660 Part 102. I _q = rated conditional short-circuit current. |
| PKZM4-25 | DILM40(…) | DILM40(…) | – | | |
| PKZM4-32 | DILM40(…) | DILM40(…) | – | | |
| PKZM4-40 | DILM40(…) | DILM40(…) | – | | |
| PKZM4-50 | DILM50(…) | DILM50(…) | – | | |
| PKZM4-58 | DILM65(…) | DILM65(…) | – | | |
| PKZM4-63 | DILM65(…) | DILM65(…) | – | | |
| | | | | | |
| | | | | | |
| | | | | | |

1.4

Motor-starter combinations Modules

1

NZMN, NZMH, DILM

Motor data

| Rated operational power AC-3 | Rated operational current AC-3 | Rated short-circuit current |
|---------------------------------|-----------------------------------|-----------------------------|
| 380 V 400 V 415 V | 400 V | 400/415 V |
| P kW | I_e A | I_q kA |

Setting range

| Overload trip | Short-circuit release |
|---------------|-----------------------|
|---------------|-----------------------|



Modules NZMN and DILM

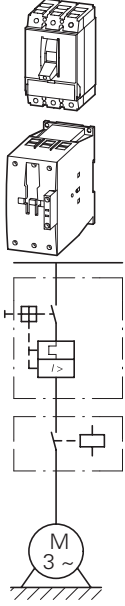

| | | | | |
|------|-----|----|------------|--------------|
| 18.5 | 36 | 50 | 32 - 40 | 320 - 560 |
| 22 | 41 | 50 | 40 - 50 | 400 - 700 |
| 30 | 55 | 50 | 50 - 63 | 504 - 882 |
| 37 | 68 | 50 | 63 - 80 | 640 - 1120 |
| 45 | 81 | 50 | 80 - 100 | 800 - 1250 |
| 55 | 99 | 50 | 80 - 100 | 800 - 1250 |
| 75 | 134 | 50 | 125 - 160 | 1280 - 2240 |
| 90 | 161 | 50 | 160 - 200 | 1600 - 2500 |
| 110 | 196 | 50 | 160 - 200 | 1600 - 2500 |
| 132 | 231 | 50 | 175 - 350 | 350 - 4900 |
| 160 | 279 | 50 | 175 - 350 | 350 - 4900 |
| 200 | 349 | 50 | 175 - 350 | 350 - 4900 |
| 250 | 437 | 50 | 225 - 450 | 450 - 6300 |
| 315 | 544 | 50 | 275 - 550 | 550 - 7700 |
| 400 | 683 | 50 | 438 - 875 | 875 - 12250 |
| 450 | 750 | 50 | 438 - 875 | 875 - 12250 |
| 500 | 820 | 50 | 438 - 875 | 875 - 12250 |
| 560 | 947 | 50 | 700 - 1400 | 1400 - 19600 |

Modules NZMH and DILM

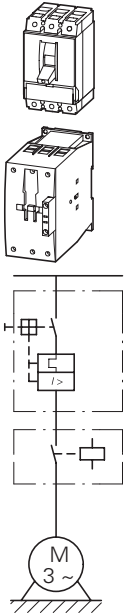

| | | | | |
|-----|-----|-----|-----------|-------------|
| 22 | 41 | 100 | 40 - 50 | 400 - 700 |
| 30 | 55 | 100 | 50 - 63 | 504 - 882 |
| 37 | 68 | 100 | 63 - 80 | 640 - 1120 |
| 45 | 81 | 100 | 80 - 100 | 800 - 1250 |
| 55 | 100 | 100 | 100 - 125 | 1000 - 1750 |
| 75 | 134 | 100 | 125 - 160 | 1280 - 2240 |
| 30 | 55 | 100 | 45 - 90 | 90 - 1260 |
| 37 | 68 | 100 | 45 - 90 | 90 - 1260 |
| 45 | 81 | 100 | 45 - 90 | 90 - 1260 |
| 55 | 100 | 100 | 70 - 140 | 140 - 1960 |
| 75 | 134 | 100 | 70 - 140 | 140 - 1960 |
| 90 | 161 | 100 | 110 - 120 | 220 - 3080 |
| 110 | 196 | 100 | 110 - 120 | 220 - 3080 |
| 132 | 231 | 100 | 175 - 350 | 350 - 4900 |
| 160 | 279 | 100 | 175 - 350 | 350 - 4900 |
| 200 | 349 | 100 | 175 - 350 | 350 - 4900 |

Notes

| | | |
|------------------------|-----------------------|-----------------------|
| Circuit-breaker | Contactor | Contactor |
| | Type "1" coordination | Type "2" coordination |

| | | |
|-------------|-------------|-------------|
| Type | Type | Type |
|-------------|-------------|-------------|

| | | |
|--------------|------------------|------------------|
| NZMN1-M40 | DILM40(...) | DILM80(...) |
| NZMN1-M50 | DILM50(...) | DILM80(...) |
| NZMN1-M63 | DILM65(...) | DILM80(...) |
| NZMN1-M80 | DILM80(...) | DILM80(...) |
| NZMN1-M100 | DILM95(...) | DILM95(...) |
| NZMN1-M100 | DILM115(...) | DILM115(...) |
| NZMN2-M160 | DILM150(...) | DILM150(...) |
| NZMN2-M200 | DILM185A/22(...) | DILM185A/22(...) |
| NZMN2-M200 | DILM225A/22(...) | DILM225A/22(...) |
| NZMN3-ME350 | DILM250/22(...) | DILM250/22(...) |
| NZMN3-ME350 | DILM300A/22(...) | DILM300A/22(...) |
| NZMN3-ME350 | DILM400/22(...) | DILM400/22(...) |
| NZMN3-ME450 | DILM500/22(...) | DILM500/22(...) |
| NZMN4-ME550 | DILM580/22(...) | – |
| NZMN4-ME875 | DILM650/22(...) | – |
| NZMN4-ME875 | DILM750/22(...) | – |
| NZMN4-ME875 | DILM820/22(...) | – |
| NZMN4-ME1400 | DILM1000/22(...) | – |

The motor-starter combinations consist of the motor protective circuit breaker or a circuit breaker and a contactor. They conform with IEC/EN 60947-4-1 or VDE 0660 Part 102.
I_q = conditional rated current

| | | |
|-------------|------------------|------------------|
| NZMH2-M50 | DILM80(...) | DILM80(...) |
| NZMH2-M63 | DILM80(...) | DILM80(...) |
| NZMH2-M80 | DILM80(...) | DILM80(...) |
| NZMH2-M100 | DILM95(...) | DILM95(...) |
| NZMH2-M125 | DILM115(...) | DILM115(...) |
| NZMH2-M160 | DILM150(...) | DILM150(...) |
| NZMH2-ME90 | DILM80(...) | DILM80(...) |
| NZMH2-ME90 | DILM80(...) | DILM80(...) |
| NZMH2-ME90 | DILM95(...) | DILM95(...) |
| NZMH2-ME140 | DILM115(...) | DILM115(...) |
| NZMH2-ME140 | DILM150(...) | DILM150(...) |
| NZMH2-ME220 | DILM185A/22(...) | DILM185A/22(...) |
| NZMH2-ME220 | DILM225A/22(...) | DILM225A/22(...) |
| NZMH3-ME350 | DILM250/22(...) | DILM250/22(...) |
| NZMH3-ME350 | DILM300A/22(...) | DILM300A/22(...) |
| NZMH3-ME350 | DILM400/22(...) | DILM400/22(...) |

The motor-starter combinations consist of the motor protective circuit breaker or a circuit breaker and a contactor. They conform with IEC/EN 60947-4-1 or VDE 0660 Part 102.
I_q = conditional rated current

1.4 Motor-starter combinations

Modules

1 Modules NZMH and DILM

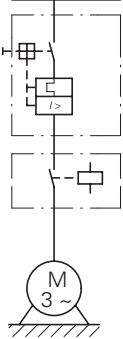
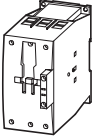
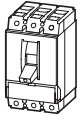



NZMH, DILM

Motor data

| Rated operational power AC-3 | Rated operational current | | Rated short-circuit current |
|---------------------------------|---------------------------|-------|-----------------------------|
| 500 V 525 V | 500 V | 525 V | 500/525 V |

Setting range

| Overload trip | Short-circuit release |
|---------------|-----------------------|
|---------------|-----------------------|

| P kW | I_e A | I_e A | I_q kA | I_r A  | I_{rm} A  |
|---------|------------|------------|-------------|--|---|
| 11 | 17.4 | 17 | 50 | 16 - 20 | 350 - 350 |
| 15 | 23.4 | 22.5 | 50 | 20 - 25 | 350 - 350 |
| 18.5 | 28.9 | 28 | 50 | 25 - 32 | 320 - 448 |
| 22 | 33 | 32 | 50 | 32 - 40 | 320 - 560 |
| 30 | 44 | 43 | 50 | 40 - 50 | 400 - 700 |
| 37 | 54 | 54 | 50 | 50 - 63 | 504 - 882 |
| 45 | 65 | 64 | 50 | 63 - 80 | 640 - 1120 |
| 55 | 79 | 78 | 50 | 63 - 80 | 640 - 1120 |
| 75 | 107 | 106 | 50 | 100 - 125 | 1000 - 1750 |
| 90 | 129 | 127 | 50 | 125 - 160 | 1280 - 2240 |
| 30 | 44 | 43 | 50 | 45 - 90 | 90 - 1260 |
| 37 | 54 | 54 | 50 | 45 - 90 | 90 - 1260 |
| 45 | 65 | 64 | 50 | 45 - 90 | 90 - 1260 |
| 55 | 79 | 78 | 50 | 45 - 90 | 90 - 1260 |
| 75 | 107 | 106 | 50 | 70 - 140 | 140 - 1960 |
| 90 | 129 | 127 | 50 | 70 - 140 | 140 - 1960 |



| Circuit-breaker | Contactor | Contactor | Notes |
|-----------------|-----------------------|-----------------------|--|
| | Type "1" coordination | Type "2" coordination | |
| Type | Type | Type | |
| NZMH2-M20 | DILM40(...) | DILM80(...) | The motor-starter combinations consist of the motor protective circuit breaker or a circuit breaker and a contactor. They conform with IEC/EN 60947-4-1 or VDE 0660 Part 102. I_q = conditional rated current |
| NZMH2-M25 | DILM40(...) | DILM80(...) | |
| NZMH2-M32 | DILM40(...) | DILM80(...) | |
| NZMH2-M40 | DILM40(...) | DILM80(...) | |
| NZMH2-M50 | DILM80(...) | DILM80(...) | |
| NZMH2-M63 | DILM80(...) | DILM80(...) | |
| NZMH2-M80 | DILM80(...) | DILM80(...) | |
| NZMH2-M80 | DILM80(...) | DILM80(...) | |
| NZMH2-M125 | DILM115(...) | DILM115(...) | |
| NZMH2-M160 | DILM150(...) | DILM150(...) | |
| NZMH2-ME90 | DILM80(...) | DILM80(...) | |
| NZMH2-ME90 | DILM80(...) | DILM80(...) | |
| NZMH2-ME90 | DILM80(...) | DILM80(...) | |
| NZMH2-ME140 | DILM115(...) | DILM115(...) | |
| NZMH2-ME140 | DILM150(...) | DILM150(...) | |

1.4 Motor-starter combinations

Modules

1

PKZM0, DILM, ZB; NZMN1, DILM, ZB

| Motor data | | | Setting range | | Basic unit |
|-------------------------|---------------------------|-----------------------------|--|---|------------|
| Rated operational power | Rated operational current | Rated short-circuit current | Overload trip | Short-circuit release | |
| AC-3 | AC-3 | | | | |
| 380 V 400 V 415 V | 400 V | 380 - 415 V | | | |
| P | I_e | I_q | I_r | I_{rm} | Type |
| kW | A | kA | A  | A  | |
| 0.06 | 0.21 | 100 | 0.16 - 0.24 | 3.5 | PKM0-0,25 |
| 0.09 | 0.31 | 100 | 0.24 - 0.4 | 5.6 | PKM0-0,4 |
| 0.12 | 0.41 | 100 | 0.4 - 0.6 | 8.82 | PKM0-0,63 |
| 0.18 | 0.6 | 100 | 0.4 - 0.6 | 8.82 | PKM0-0,63 |
| 0.25 | 0.8 | 100 | 0.6 - 1 | 14 | PKM0-1 |
| 0.37 | 1.1 | 100 | 1 - 1.6 | 22.4 | PKM0-1,6 |
| 0.55 | 1.5 | 100 | 1 - 1.6 | 22.4 | PKM0-1,6 |
| 0.75 | 1.9 | 100 | 1.6 - 2.4 | 35 | PKM0-2,5 |
| 1.1 | 2.6 | 100 | 2.4 - 4 | 56 | PKM0-4 |
| 1.5 | 3.6 | 100 | 2.4 - 4 | 56 | PKM0-4 |
| 2.2 | 5 | 100 | 4 - 6 | 88.2 | PKM0-6,3 |
| 3 | 6.6 | 100 | 6 - 10 | 140 | PKM0-10 |
| 4 | 8.5 | 100 | 6 - 10 | 140 | PKM0-10 |
| 5.5 | 11.3 | 50 | 8 - 12 | 168 | PKM0-12 |
| 5.5 | 11.3 | 50 | 10 - 16 | 168 | PKM0-12 |
| 7.5 | 15.2 | 50 | 10 - 16 | 224 | PKM0-16 |
| 11 | 21.7 | 50 | 16 - 24 | 350 | PKM0-25 |
| 15 | 29.3 | 50 | 20 - 32 | 448 | PKM0-32 |
| 18.5 | 36 | 50 | 24 - 40 | 320 - 560 | NZMN1-S40 |
| 18.5 | 36 | 50 | 3 - 65 | 320 - 560 | NZMN1-S40 |
| 22 | 41 | 50 | 40 - 57 | 400 - 700 | NZMN1-S50 |
| 22 | 41 | 50 | 3 - 65 | 400 - 700 | NZMN1-S50 |
| 30 | 55 | 50 | 40 - 57 | 504 - 882 | NZMN1-S63 |
| 30 | 55 | 50 | 3 - 65 | 504 - 882 | NZMN1-S63 |
| 37 | 68 | 50 | 50 - 70 | 640 - 1120 | NZMN1-S80 |
| 37 | 68 | 50 | 10 - 145 | 640 - 1120 | NZMN1-S80 |
| 45 | 81 | 50 | 70 - 100 | 800 - 1250 | NZMN1-S100 |
| 45 | 81 | 50 | 10 - 145 | 800 - 1250 | NZMN1-S100 |
| 55 | 99 | 50 | 70 - 100 | 800 - 1250 | NZMN1-S100 |
| 55 | 99 | 50 | 10 - 145 | 800 - 1250 | NZMN1-S100 |

Modules PKM0, DILM and ZB with and without automatic reset

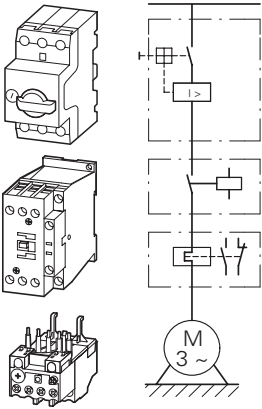

Modules NZMN1, DILM and Z...

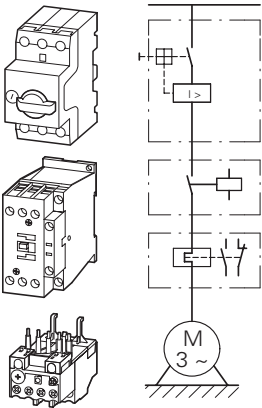

| Contactor | Overload relay | Contactor | Overload relay | Current sensor | Notes |
|-----------------------|-----------------------|-----------------------|-----------------------|----------------|--|
| Type "1" coordination | Type "1" coordination | Type "2" coordination | Type "2" coordination | | |
| Type | Type | Type | Type | Type | |
| DILM7-...(…) | ZB12-0,24 | DILM7-...(…) | ZB12-0,24 | – | <p>The motor-starter combinations consist of the motor protective circuit breaker (without overload function), a contactor and overload relay modules.</p> <p>They conform with IEC/EN 60947-4-1 or VDE 0660 Part 102.</p> <p>I_g = conditional rated current</p> <p>The combinations can be operated with or without manual reset. In the Manual position, the combination is blocked against automatic restarting and must be reset locally. In the Auto position, the combination automatically switches on again after the bimetallic elements have cooled down.</p> |
| DILM7-...(…) | ZB12-0,4 | DILM7-...(…) | ZB12-0,4 | – | |
| DILM7-...(…) | ZB12-0,6 | DILM7-...(…) | ZB12-0,6 | – | |
| DILM7-...(…) | ZB12-0,6 | DILM7-...(…) | ZB12-0,6 | – | |
| DILM7-...(…) | ZB12-1 | DILM7-...(…) | ZB12-1 | – | |
| DILM7-...(…) | ZB12-1,6 | DILM7-...(…) | ZB12-1,6 | – | |
| DILM7-...(…) | ZB12-1,6 | DILM7-...(…) | ZB12-1,6 | – | |
| DILM7-...(…) | ZB12-2,4 | DILM7-...(…) | ZB12-2,4 | – | |
| DILM7-...(…) | ZB12-4 | DILM7-...(…) | ZB12-4 | – | |
| DILM7-...(…) | ZB12-4 | DILM7-...(…) | ZB12-4 | – | |
| DILM7-...(…) | ZB12-6 | DILM17-...(…) | ZB32-6 | – | |
| DILM9-...(…) | ZB12-10 | DILM17-...(…) | ZB32-10 | – | |
| DILM9-...(…) | ZB12-10 | DILM17-...(…) | ZB32-10 | – | |
| DILM12-...(…) | ZB12-12 | – | – | – | |
| – | – | DILM17-...(…) | ZB32-16 | – | |
| DILM17-...(…) | ZB32-16 | DILM17-...(…) | ZB32-16 | – | |
| DILM25-...(…) | ZB32-24 | DILM25-...(…) | ZB32-24 | – | |
| DILM32-...(…) | ZB32-32 | DILM32-...(…) | ZB32-32 | – | |
| DILM40(…) | ZB65-40 | – | – | – | <p>The motor-starter combinations consist of the circuit-breaker (without overload function), contactor and overload relay module.</p> <p>They conform with IEC/EN 60947-4-1 or VDE 0660 Part 102.</p> <p>I_g = conditional rated current</p> <p>The combinations can be operated with or without manual reset. In the Manual position, the combination is blocked against automatic restarting and must be reset locally. In the Auto position, the combination automatically switches on again after the bimetallic elements have cooled down.</p> <p>Maximum tripping tolerance CLASS10.</p> |
| – | – | DILM40(…) | – | – | |
| DILM50(…) | ZB65-57 | – | – | – | |
| – | – | DILM50(…) | – | – | |
| DILM65(…) | ZB65-57 | – | – | – | |
| – | – | DILM65(…) | – | – | |
| DILM80(…) | ZB150-70 | – | – | – | |
| – | – | DILM80(…) | – | – | |
| DILM95(…) | ZB150-100 | – | – | – | |
| – | – | DILM95(…) | – | – | |
| DILM115(…) | ZB150-100 | – | – | – | |
| – | – | DILM115(…) | – | – | |
| – | – | – | – | – | |
| – | – | – | – | – | |
| | | | | | <p>Further information</p> <p>Technical data PKZMO → Chapter 1.3</p> <p>Accessories PKZ → Chapter 1.3 (Page 10)</p> <p>Technical data DILM → Chapter 1.1</p> <p>Further actuating voltages → Chapter 1.1 (Page 69)</p> <p>DIL accessories → Chapter 1.1 (Page 52)</p> <p>Technical data ZB... → Chapter 1.2</p> <p>Accessories ZB... → Chapter 1.2 (Page 21)</p> |
| | | | | | <p>Further information</p> <p>Technical data NZMN1 → See catalog</p> <p>Accessories NZM1 → See catalog</p> <p>Technical data DILM → Chapter 1.1</p> <p>Further actuating voltages → Chapter 1.1 (Page 71)</p> <p>DIL accessories → Chapter 1.1 (Page 50)</p> <p>Technical data ZB... → Chapter 1.2</p> <p>Accessories ZB... → Chapter 1.2 (Page 21)</p> |

1.4 Motor-starter combinations

Complete units



1

MSC-R: PKZM0, DILM

Motor data

| Rated operational power AC-3 | Rated operational current AC-3 | Rated short-circuit current 380 - 415 V | |
|---------------------------------|-----------------------------------|--|-------------------------------|
| 380 V 400 V 415 V | 400 V | Type "1" coordina- tion | Type "2" coordina- tion |
| P kW | I_e A | I_q kA | I_q kA |

Setting range

| Overload trip | Short-circuit releases |
|--|---|
| I_r A  | I_{rm} A  |

Motor starters actuating voltage 230 V 50 Hz

Part no.
Article no.

Price
See price
list

Complete units MSC-R

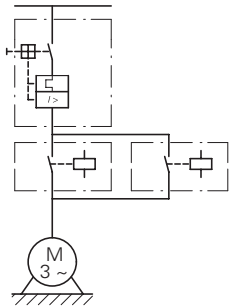
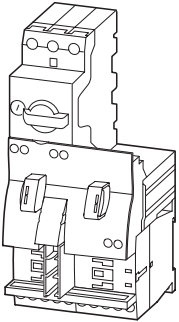

| | | | | | | |
|--------------|-------------|-----|----|-------------|------|--|
| 0.06 | 0.21 | 150 | 50 | 0.16 - 0.25 | 3.5 | MSC-R-0.25-M7(230V50Hz) 283171 |
| 0.09 | 0.31 | 150 | 50 | 0.25 - 0.4 | 5.6 | MSC-R-0.4-M7(230V50Hz) 283172 |
| 0.12 0.18 | 0.41 0.6 | 150 | 50 | 0.4 - 0.63 | 8.82 | MSC-R-0.63-M7(230V50Hz) 283173 |
| 0.25 | 0.8 | 150 | 50 | 0.63 - 1 | 14 | MSC-R-1-M7(230V50Hz) 283175 |
| 0.37 0.55 | 1.1 1.5 | 150 | 50 | 1 - 1.6 | 22.4 | MSC-R-1.6-M7(230V50Hz) 283176 |
| 0.75 | 1.9 | 150 | 50 | 1.6 - 2.5 | 35 | MSC-R-2.5-M7(230V50Hz) 283178 |
| 1.1 1.5 | 2.6 3.6 | 150 | 50 | 2.5 - 4 | 56 | MSC-R-4-M7(230V50Hz) 283179 |
| 2.2 | 5 | 150 | 50 | 4 - 6.3 | 88.2 | MSC-R-6.3-M7(230V50Hz) 283181 |
| 3 | 6.6 | 150 | - | 6.3 - 10 | 140 | MSC-R-10-M7(230V50Hz) 283182 |
| 4 | 8.5 | 150 | - | 6.3 - 10 | 140 | MSC-R-10-M9(230V50Hz) 283183 |
| 5.5 | 11.3 | 50 | - | 8 - 12 | 168 | MSC-R-12-M12(230V50Hz) 283184 |

Complete units MSC-R

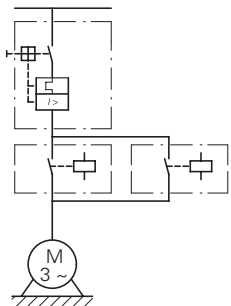
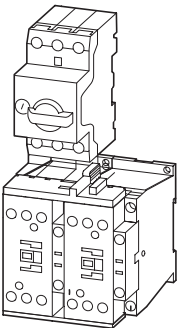

| | | | | | | |
|-----|------|----|----|----------|-----|---|
| 3 | 6.6 | 50 | 50 | 6.3 - 10 | 140 | MSC-R-10-M17(230V50Hz) 101049 |
| 4 | 11.3 | 50 | 50 | 8 - 12 | 168 | MSC-R-12-M17(230V50Hz) 101050 |
| 7.5 | 15.2 | 50 | 50 | 10 - 16 | 224 | MSC-R-16-M17(230V50Hz) 283186 |
| 11 | 21.7 | 50 | 50 | 20 - 25 | 350 | MSC-R-25-M25(230V50Hz) 283187 |
| 15 | 29.3 | 50 | 50 | 25 - 32 | 448 | MSC-R-32-M32(230V50Hz) 283188 |

| Motor starters actuating voltage 24 V DC | Price See price list | Std. pack | Motor protective circuit breaker | Contactors | Reversing starter wiring set | Notes |
|--|----------------------------|-----------|-------------------------------------|----------------|---------------------------------|--|
| Part no. Article no. | | | Type | Type | Type | |
| MSC-R-0.25-M7(24VDC) 283190 | | 1 off | PKZM0-0,25 | DILM7-01(...) | PKZM0-XRM12 | <p>The reversing starters (complete devices) consist of a PKZM0 motor protective circuit breaker and two contactors DILM.</p> <p>With the adapterless top-hat rail mounting of starters up to 12 A, only the motor-protective circuit-breaker on the top-hat rail requires an adapter. The contactors are provided with mechanical support via a mechanical connection element.</p> <p>Control wire guide with max. 6 conductors with up to 2.5 mm external diameter or 4 conductors up to 3.5 mm external diameter.</p> <p>From 16 A, the motor protective circuit breaker and contactors are mounted on the top-hat rail adapter plate. The connection of the main circuit between PKZ and contactor is established with electrical contact modules. Complete units with mechanical interlock, starters up to 12 A also with electrical interlock.</p> <p>When using auxiliary contacts DILA - XHIT ... → Chapter 1.1 (Page 38) the electrical plugs can be pulled without having to remove the front mounting auxiliary contact.</p> <p>Cannot be combined with standard auxiliary contact NHI-E...-PKZ0-C with spring-loaded terminal.</p> |
| MSC-R-0.4-M7(24VDC) 283191 | | 1 off | PKZM0-0,4 | DILM7-01(...) | PKZM0-XRM12 | |
| MSC-R-0.63-M7(24VDC) 283192 | | 1 off | PKZM0-0,63 | DILM7-01(...) | PKZM0-XRM12 | |
| MSC-R-1-M7(24VDC) 283194 | | 1 off | PKZM0-1 | DILM7-01(...) | PKZM0-XRM12 | |
| MSC-R-1.6-M7(24VDC) 283195 | | 1 off | PKZM0-1,6 | DILM7-01(...) | PKZM0-XRM12 | |
| MSC-R-2.5-M7(24VDC) 283197 | | 1 off | PKZM0-2,5 | DILM7-01(...) | PKZM0-XRM12 | |
| MSC-R-4-M7(24VDC) 283198 | | 1 off | PKZM0-4 | DILM7-01(...) | PKZM0-XRM12 | |
| MSC-R-6.3-M7(24VDC) 283200 | | 1 off | PKZM0-6,3 | DILM7-01(...) | PKZM0-XRM12 | |
| MSC-R-10-M7(24VDC) 283201 | | 1 off | PKZM0-10 | DILM7-01(...) | PKZM0-XRM12 | |
| MSC-R-10-M9(24VDC) 283202 | | 1 off | PKZM0-10 | DILM9-01(...) | PKZM0-XRM12 | |
| MSC-R-12-M12(24VDC) 283203 | | 1 off | PKZM0-12 | DILM12-01(...) | PKZM0-XRM12 | |
| MSC-R-10-M17(24VDC) 101051 | | 1 off | PKZM0-10 | DILM17-01(...) | PKZM0-XRM32 | <p>Further information</p> <p>Technical data PKZM0</p> <p>Accessories PKZ</p> <p>Technical data DILM</p> <p>Further actuation voltages</p> <p>DILM accessories</p> |
| MSC-R-12-M17(24VDC) 101052 | | 1 off | PKZM0-12 | DILM17-01(...) | PKZM0-XRM32 | |
| MSC-R-16-M17(24VDC) 283204 | | 1 off | PKZM0-16 | DILM17-01(...) | PKZM0-XRM32 | |
| MSC-R-25-M25(24VDC) 283205 | | 1 off | PKZM0-25 | DILM25-01(...) | PKZM0-XRM32 | |
| MSC-R-32-M32(24VDC) 283206 | | 1 off | PKZM0-32 | DILM32-01(...) | PKZM0-XRM32 | |
| | | | | | | |

| Further information | Page |
|----------------------------|-------------------------|
| Technical data PKZM0 | → Chapter 1.3 |
| Accessories PKZ | → Chapter 1.3 (Page 10) |
| Technical data DILM | → Chapter 1.1 |
| Further actuation voltages | → Chapter 1.1 (Page 69) |
| DILM accessories | → Chapter 1.1 (Page 50) |

1.4 Motor-starter combinations

Modules

1

PKZM, DILM

Motor data

| Rated operational power | Rated operational current | Rated short-circuit current | |
|-------------------------|---------------------------|-----------------------------|-----------------------|
| 400 V | AC-3 | 380 - 415 V | 380 - 415 V |
| | 400 V | Type "1" coordination | Type "2" coordination |

Setting range

| Overload trip | Short-circuit release |
|---------------|-----------------------|
|---------------|-----------------------|

| P kW | I_e A | I_q kA | I_q kA | I_r A | I_{rm} A |
|---------|------------|-------------|-------------|-------------|---------------|
| 0.06 | 0.21 | 150 | 50 | 0.16 - 0.25 | 3.5 |
| 0.09 | 0.31 | 150 | 50 | 0.25 - 0.4 | 5.6 |
| 0.12 | 0.41 | 150 | 50 | 0.4 - 0.63 | 8.82 |
| 0.18 | 0.6 | 150 | 50 | 0.4 - 0.63 | 8.82 |
| 0.25 | 0.8 | 150 | 50 | 0.63 - 1 | 14 |
| 0.37 | 1.1 | 150 | 50 | 1 - 1.6 | 22.4 |
| 0.55 | 1.5 | 150 | 50 | 1 - 1.6 | 22.4 |
| 0.75 | 1.9 | 150 | 50 | 1.6 - 2.5 | 35 |
| 1.1 | 2.6 | 150 | 50 | 2.5 - 4 | 56 |
| 1.5 | 3.6 | 150 | 50 | 2.5 - 4 | 56 |
| 2.2 | 5 | 150 | 50 | 4 - 6.3 | 88.2 |
| 3 | 6.6 | 150 | 50 | 6.3 - 10 | 140 |
| 4 | 8.5 | 150 | 50 | 6.3 - 10 | 140 |
| 5.5 | 11.3 | 50 | 50 | 8 - 12 | 168 |
| 7.5 | 15.2 | 50 | 50 | 10 - 16 | 224 |
| 11 | 21.7 | 50 | 50 | 20 - 25 | 350 |
| 15 | 29.3 | 50 | 50 | 25 - 32 | 448 |

Modules PKZM0 and DILM

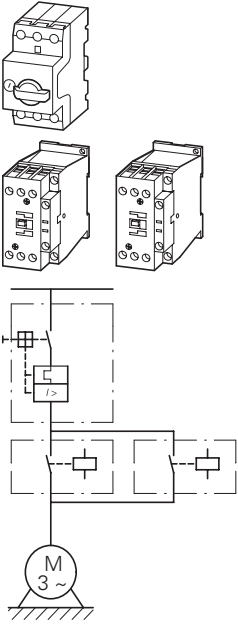

Modules PKZM4 and DILM

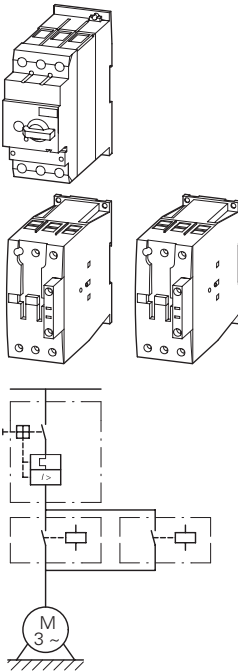

| | | | | | |
|------|------|----|----|---------|-----|
| 5.5 | 11.3 | 50 | 50 | 10 - 16 | 224 |
| 7.5 | 15.2 | 50 | 50 | 10 - 16 | 224 |
| 11 | 21.7 | 50 | 50 | 20 - 25 | 350 |
| 15 | 29.3 | 50 | 50 | 25 - 32 | 448 |
| 18.5 | 36 | 50 | 50 | 32 - 40 | 560 |
| 22 | 41 | 50 | 50 | 40 - 50 | 700 |
| 30 | 55 | 50 | 50 | 50 - 58 | 812 |
| 34 | 63 | 50 | 50 | 55 - 65 | 882 |

| Motor protective circuit breaker | Contactor | Contactor | Notes |
|----------------------------------|-----------------------|-----------------------|--|
| | Type "1" coordination | Type "2" coordination | |
| Type | Type | Type | |
| PKZM0-0,25 | 2 x DILM7-...(...) | 2 x DILM7-...(...) | <p>The motor-starter combinations consist of the motor protective circuit breaker or a circuit breaker and a contactor. They conform with IEC/EN 60947-4-1 or VDE 0660 Part 102. I_q = conditional rated current</p> <p>Further information</p> <ul style="list-style-type: none"> Technical data PKZM0 Accessories PKZ Technical data DILM Other operating voltages DILM accessories <p>Page</p> <ul style="list-style-type: none"> → Chapter 1.3 → Chapter 1.3 (Page 10) → Chapter 1.1 → Chapter 1.1 (Page 69) → Chapter 1.1 (Page 50) |
| PKZM0-0,4 | 2 x DILM7-...(...) | 2 x DILM7-...(...) | |
| PKZM0-0,63 | 2 x DILM7-...(...) | 2 x DILM7-...(...) | |
| PKZM0-0,63 | 2 x DILM7-...(...) | 2 x DILM7-...(...) | |
| PKZM0-1 | 2 x DILM7-...(...) | 2 x DILM7-...(...) | |
| PKZM0-1,6 | 2 x DILM7-...(...) | 2 x DILM7-...(...) | |
| PKZM0-1,6 | 2 x DILM7-...(...) | 2 x DILM7-...(...) | |
| PKZM0-2,5 | 2 x DILM7-...(...) | 2 x DILM7-...(...) | |
| PKZM0-4 | 2 x DILM7-...(...) | 2 x DILM7-...(...) | |
| PKZM0-4 | 2 x DILM7-...(...) | 2 x DILM7-...(...) | |
| PKZM0-6,3 | 2 x DILM7-...(...) | 2 x DILM7-...(...) | |
| PKZM0-10 | 2 x DILM9-...(...) | 2 x DILM17-...(...) | |
| PKZM0-10 | 2 x DILM9-...(...) | 2 x DILM17-...(...) | |
| PKZM0-12 | 2 x DILM12-...(...) | 2 x DILM17-...(...) | |
| PKZM0-16 | 2 x DILM17-...(...) | 2 x DILM17-...(...) | |
| PKZM0-25 | 2 x DILM25-...(...) | 2 x DILM25-...(...) | |
| PKZM0-32 | 2 x DILM32-...(...) | 2 x DILM32-...(...) | |
| PKZM4-16 | 2 x DILM17-...(...) | 2 x DILM17-...(...) | |
| PKZM4-16 | 2 x DILM17-...(...) | 2 x DILM17-...(...) | |
| PKZM4-25 | 2 x DILM25-...(...) | 2 x DILM25-...(...) | |
| PKZM4-32 | 2 x DILM32-...(...) | 2 x DILM32-...(...) | |
| PKZM4-40 | 2 x DILM40(...) | 2 x DILM40(...) | |
| PKZM4-50 | 2 x DILM50(...) | 2 x DILM50(...) | |
| PKZM4-58 | 2 x DILM65(...) | 2 x DILM65(...) | |
| PKZM4-63 | 2 x DILM65(...) | 2 x DILM65(...) | |

1.4 Motor-starter combinations

Modules



1

NZMN, NZMH, DILM

Motor data

| Rated operational power | Rated operational current | Rated short-circuit current |
|-------------------------|---------------------------|-----------------------------|
| AC-3 | AC-3 | |
| 380 V 400 V 415 V | 400 V | 400/415 V |
| P kW | I_e A | I_q kA |

Setting range

| Overload trip | Short-circuit release |
|--|---|
| I_r A  | I_{rm} A  |

Modules NZMN and DILM

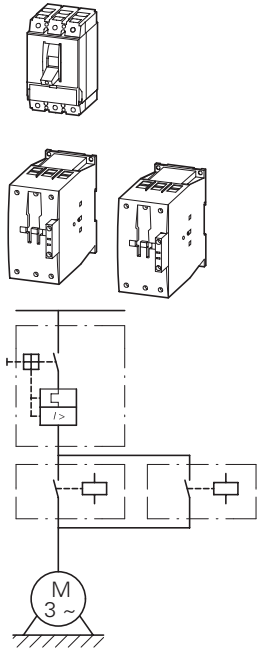

| | | | | |
|------|------|----|------------|--------------|
| 15 | 29.3 | 50 | 25 - 32 | 320 - 448 |
| 18.5 | 36 | 50 | 32 - 40 | 320 - 560 |
| 22 | 41 | 50 | 40 - 50 | 400 - 700 |
| 30 | 55 | 50 | 50 - 63 | 504 - 882 |
| 37 | 68 | 50 | 63 - 80 | 640 - 1120 |
| 45 | 81 | 50 | 80 - 100 | 800 - 1250 |
| 55 | 99 | 50 | 80 - 100 | 800 - 1250 |
| 75 | 134 | 50 | 125 - 160 | 1280 - 2240 |
| 90 | 161 | 50 | 160 - 200 | 1600 - 2500 |
| 110 | 196 | 50 | 160 - 200 | 1600 - 2500 |
| 132 | 231 | 50 | 175 - 350 | 350 - 4900 |
| 160 | 279 | 50 | 175 - 350 | 350 - 4900 |
| 200 | 349 | 50 | 175 - 350 | 350 - 4900 |
| 250 | 437 | 50 | 225 - 450 | 450 - 6300 |
| 315 | 544 | 50 | 275 - 550 | 550 - 7700 |
| 400 | 683 | 50 | 438 - 875 | 875 - 12250 |
| 450 | 750 | 50 | 438 - 875 | 875 - 12250 |
| 500 | 820 | 50 | 438 - 875 | 875 - 12250 |
| 560 | 947 | 50 | 700 - 1400 | 1400 - 19600 |

Modules NZMH and DILM

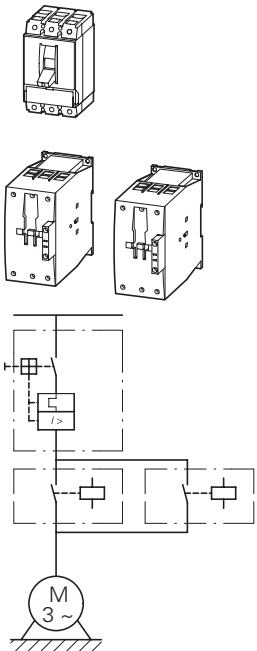

| | | | | |
|-----|-----|-----|-----------|-------------|
| 22 | 41 | 100 | 40 - 50 | 400 - 700 |
| 30 | 55 | 100 | 50 - 63 | 504 - 882 |
| 37 | 68 | 100 | 63 - 80 | 640 - 1120 |
| 55 | 81 | 100 | 80 - 100 | 800 - 1250 |
| 55 | 100 | 100 | 100 - 125 | 1000 - 1750 |
| 75 | 134 | 100 | 125 - 160 | 1280 - 2240 |
| 30 | 55 | 100 | 45 - 90 | 90 - 1260 |
| 37 | 68 | 100 | 45 - 90 | 90 - 1260 |
| 45 | 81 | 100 | 45 - 90 | 90 - 1260 |
| 55 | 100 | 100 | 70 - 140 | 140 - 1960 |
| 75 | 134 | 100 | 70 - 140 | 140 - 1960 |
| 90 | 161 | 100 | 110 - 120 | 220 - 3080 |
| 110 | 196 | 100 | 110 - 120 | 220 - 3080 |
| 132 | 231 | 100 | 175 - 350 | 350 - 4900 |
| 160 | 279 | 100 | 175 - 350 | 350 - 4900 |
| 200 | 349 | 100 | 175 - 350 | 350 - 4900 |

| Circuit-breaker | Contactor | Contactor | Notes |
|-----------------|-----------------------|-----------------------|-------|
| | Type "1" coordination | Type "2" coordination | |

| Type | Type | Type | |
|--------------|----------------------|----------------------|--|
| NZMN1-M32 | 2 x DILM40(...) | 2 x DILM80(...) | The motor starter combinations consist of the motor protective circuit-breaker and a contactor. They comply with IEC/EN 60947-4-1 and VDE 0660 Part 102. I_q = conditional rated current. |
| NZMN1-M40 | 2 x DILM40(...) | 2 x DILM80(...) | |
| NZMN1-M50 | 2 x DILM50(...) | 2 x DILM80(...) | |
| NZMN1-M63 | 2 x DILM65(...) | 2 x DILM80(...) | |
| NZMN1-M80 | 2 x DILM80(...) | 2 x DILM80(...) | |
| NZMN1-M100 | 2 x DILM95(...) | 2 x DILM95(...) | |
| NZMN1-M100 | 2 x DILM115(...) | 2 x DILM115(...) | |
| NZMN2-M160 | 2 x DILM150(...) | 2 x DILM150(...) | |
| NZMN2-M200 | 2 x DILM185A/22(...) | 2 x DILM185A/22(...) | |
| NZMN2-M200 | 2 x DILM225A/22(...) | 2 x DILM225A/22(...) | |
| NZMN3-ME350 | 2 x DILM250/22(...) | 2 x DILM250/22(...) | |
| NZMN3-ME350 | 2 x DILM300A/22(...) | 2 x DILM300A/22(...) | |
| NZMN3-ME350 | 2 x DILM400/22(...) | 2 x DILM400/22(...) | |
| NZMN3-ME450 | 2 x DILM500/22(...) | 2 x DILM500/22(...) | |
| NZMN4-ME550 | 2 x DILM580/22(...) | 2 x – | |
| NZMN4-ME875 | 2 x DILM650/22(...) | 2 x – | |
| NZMN4-ME875 | 2 x DILM750/22(...) | 2 x – | |
| NZMN4-ME875 | 2 x DILM820/22(...) | 2 x – | |
| NZMN4-ME1400 | 2 x DILM1000/22(...) | 2 x – | |
| NZMH2-M50 | 2 x DILM80(...) | 2 x DILM80(...) | The motor-starter combinations consist of the motor protective circuit breaker or a circuit breaker and a contactor. They conform with IEC/EN 60947-4-1 or VDE 0660 Part 102. I_q = rated conditional short-circuit current. |
| NZMH2-M63 | 2 x DILM80(...) | 2 x DILM80(...) | |
| NZMH2-M80 | 2 x DILM80(...) | 2 x DILM80(...) | |
| NZMH2-M100 | 2 x DILM95(...) | 2 x DILM95(...) | |
| NZMH2-M125 | 2 x DILM115(...) | 2 x DILM115(...) | |
| NZMH2-M160 | 2 x DILM150(...) | 2 x DILM150(...) | |
| NZMH2-ME90 | 2 x DILM80(...) | 2 x DILM80(...) | |
| NZMH2-ME90 | 2 x DILM80(...) | 2 x DILM80(...) | |
| NZMH2-ME90 | 2 x DILM95(...) | 2 x DILM95(...) | |
| NZMH2-ME140 | 2 x DILM115(...) | 2 x DILM115(...) | |
| NZMH2-ME140 | 2 x DILM150(...) | 2 x DILM150(...) | |
| NZMH2-ME220 | 2 x DILM185A/22(...) | 2 x DILM185A/22(...) | |
| NZMH2-ME220 | 2 x DILM225A/22(...) | 2 x DILM225A/22(...) | |
| NZMH3-ME350 | 2 x DILM250/22(...) | 2 x DILM250/22(...) | |
| NZMH3-ME350 | 2 x DILM300A/22(...) | 2 x DILM300A/22(...) | |
| NZMH3-ME350 | 2 x DILM400/22(...) | 2 x DILM400/22(...) | |

1.4

Motor-starter combinations

DOL starters

1

MSC-D.../BBA

Motor data

| Motor rating | Rated operational current | Rated short-circuit current | |
|-------------------------|---------------------------|-----------------------------|-----------------------|
| AC-3 | AC-3 | 380 - 415 V | 380 - 415 V |
| 380 V 400 V 415 V | 400 V | Type "1" coordination | Type "2" coordination |

| P kW | I _e A | I _q kA | I _q kA |
|---------|---------------------|----------------------|----------------------|
|---------|---------------------|----------------------|----------------------|

Setting range

| Overload trip | Short-circuit release |
|---------------|-----------------------|
|---------------|-----------------------|



Motor starters actuating voltage 230 V 50 Hz

Part no.
Article no.

Price
See price list

Std.
pack

Complete devices PKZ and DIL on BBA

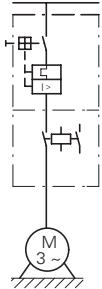
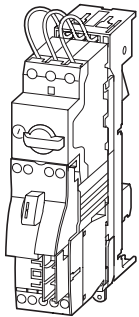

Complete devices PKZ and DIL on BBA

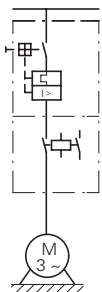
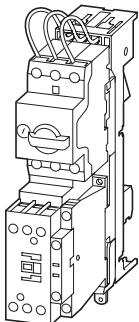

| | | | | | | | |
|--------------|-------------|-----|----|-------------|------|---|-------|
| 0.06 | 0.21 | 100 | 50 | 0.16 - 0.25 | 3.5 | MSC-D-0.25-M7(230V50Hz)/BBA¹⁾ 102737 | 1 off |
| 0.09 | 0.31 | 100 | 50 | 0.25 - 0.4 | 5.6 | MSC-D-0.4-M7(230V50Hz)/BBA¹⁾ 102738 | 1 off |
| 0.12 0.18 | 0.41 0.6 | 100 | 50 | 0.4 - 0.63 | 8.82 | MSC-D-0.63-M7(230V50Hz)/BBA¹⁾ 102739 | 1 off |
| 0.25 | 0.8 | 100 | 50 | 0.63 - 1 | 14 | MSC-D-1-M7(230V50Hz)/BBA¹⁾ 102950 | 1 off |
| 0.37 0.55 | 1.1 1.5 | 100 | 50 | 1 - 1.6 | 22.4 | MSC-D-1.6-M7(230V50Hz)/BBA¹⁾ 102951 | 1 off |
| 0.75 | 1.9 | 100 | 50 | 1.6 - 2.5 | 35 | MSC-D-2.5-M7(230V50Hz)/BBA¹⁾ 102952 | 1 off |
| 1.1 1.5 | 2.6 3.6 | 100 | 50 | 2.5 - 4 | 56 | MSC-D-4-M7(230V50Hz)/BBA¹⁾ 102953 | 1 off |
| 2.2 | 5 | 100 | 50 | 4 - 6.3 | 88.2 | MSC-D-6.3-M7(230V50Hz)/BBA¹⁾ 102954 | 1 off |
| 3 | 6.6 | 100 | — | 6.3 - 10 | 140 | MSC-D-10-M7(230V50Hz)/BBA 102955 | 1 off |
| 4 | 8.5 | 100 | — | 6.3 - 10 | 140 | MSC-D-10-M9(230V50Hz)/BBA 102956 | 1 off |
| 5.5 | 11.3 | 100 | — | 8 - 12 | 168 | MSC-D-12-M12(230V50Hz)/BBA 102957 | 1 off |
| 7.5 | 15.2 | 50 | — | 10 - 16 | 224 | MSC-D-16-M15(230V50Hz)/BBA 102958 | 1 off |
| 3 | 6.6 | 100 | 50 | 6.3 - 10 | 140 | MSC-D-10-M17(230V50Hz)/BBA 102959 | 1 off |
| 4 | 8.5 | 100 | 50 | 8 - 12 | 168 | MSC-D-12-M17(230V50Hz)/BBA 102960 | 1 off |
| 5.5 | 11.3 | 100 | 50 | 8 - 12 | 168 | MSC-D-12-M17(230V50Hz)/BBA 102960 | 1 off |
| 7.5 | 15.2 | 50 | 50 | 10 - 16 | 224 | MSC-D-16-M17(230V50Hz)/BBA¹⁾ 102961 | 1 off |
| 11 | 21.7 | 50 | 50 | 20 - 25 | 350 | MSC-D-25-M25(230V50Hz)/BBA¹⁾ 102962 | 1 off |
| 15 | 29.3 | 50 | 50 | 25 - 32 | 448 | MSC-D-32-M32(230V50Hz)/BBA¹⁾ 102963 | 1 off |

| Motor starters actuating voltage 24 V DC Part no. Article no. | Price See price list | Std. pack | Motor protective circuit breaker | Contactor | DOL starter wiring set Mechanical con- nection module and electrical contact module | Busbar adapter | Notes |
|---|----------------------------|--------------|---|----------------|--|-------------------|--|
| | | | Type | Type | Type | Type | |
| MSC-D-0.25-M7(24VDC)/BBA ¹⁾ 102964 | | 1 off | PKZM0-0,25 | DILM7-10(...) | PKZM0-XDM12 | BBA0-25 | The DOL starters (complete devices) consist of a motor protective circuit breaker PKZM0 and a contactor DILM. These combinations are mounted on busbars. The connection of the main circuit between PKZ and contactor is established with electrical contact modules. Cannot be combined with standard auxiliary contact NHI-E-...-PKZ0-C with spring-loaded terminal. |
| MSC-D-0.4-M7(24VDC)/BBA ¹⁾ 102965 | | 1 off | PKZM0-0,4 | DILM7-10(...) | PKZM0-XDM12 | BBA0-25 | |
| MSC-D-0.63-M7(24VDC)/BBA ¹⁾ 102966 | | 1 off | PKZM0-0,63 | DILM7-10(...) | PKZM0-XDM12 | BBA0-25 | |
| MSC-D-1-M7(24VDC)/BBA ¹⁾ 102967 | | 1 off | PKZM0-1 | DILM7-10(...) | PKZM0-XDM12 | BBA0-25 | |
| MSC-D-1.6-M7(24VDC)/BBA ¹⁾ 102968 | | 1 off | PKZM0-1,6 | DILM7-10(...) | PKZM0-XDM12 | BBA0-25 | |
| MSC-D-2.5-M7(24VDC)/BBA ¹⁾ 102969 | | 1 off | PKZM0-2,5 | DILM7-10(...) | PKZM0-XDM12 | BBA0-25 | |
| MSC-D-4-M7(24VDC)/BBA ¹⁾ 102970 | | 1 off | PKZM0-4 | DILM7-10(...) | PKZM0-XDM12 | BBA0-25 | |
| MSC-D-6.3-M7(24VDC)/BBA 102971 | | 1 off | PKZM0-6,3 | DILM7-10(...) | PKZM0-XDM12 | BBA0-25 | |
| MSC-D-10-M7(24VDC)/BBA 102972 | | 1 off | PKZM0-10 | DILM7-10(...) | PKZM0-XDM12 | BBA0-25 | |
| MSC-D-10-M9(24VDC)/BBA 102973 | | 1 off | PKZM0-10 | DILM9-10(...) | PKZM0-XDM12 | BBA0-25 | |
| MSC-D-12-M12(24VDC)/BBA 102974 | | 1 off | PKZM0-12 | DILM12-10(...) | PKZM0-XDM12 | BBA0-25 | |
| MSC-D-16-M15(24VDC)/BBA 102975 | | 1 off | PKZM0-16 | DILM15-10(...) | PKZM0-XDM12 | BBA0-25 | |
| MSC-D-10-M17(24VDC)/BBA 102976 | | 1 off | PKZM0-10 | DILM17-10(...) | PKZM0-XM32DE | BBA0-32 | Further information Technical data PKZM0 Accessories PKZ Technical data DILM DILM accessories ¹⁾ To assemble Type F starters that conform with UL508, incoming terminals BK25/3-PKZ0-E and, if necessary, three-phase terminal blocks B3.../...-PKZ0 can be added to motor starter combinations. Type F starter → Page 28 |
| MSC-D-12-M17(24VDC)/BBA 102977 | | 1 off | PKZM0-12 | DILM17-10(...) | PKZM0-XM32DE | BBA0-32 | |
| MSC-D-16-M17(24VDC)/BBA 102978 | | 1 off | PKZM0-16 | DILM17-10(...) | PKZM0-XM32DE | BBA0-32 | |
| MSC-D-25-M25(24VDC)/BBA 102979 | | 1 off | PKZM0-25 | DILM25-10(...) | PKZM0-XM32DE | BBA0-32 | |
| MSC-D-32-M32(24VDC)/BBA 102980 | | 1 off | PKZM0-32 | DILM32-10(...) | PKZM0-XM32DE | BBA0-32 | |

1.4 Motor-starter combinations



Reversing starters

1

MSC-R.../BBA

**Motor starters
actuating voltage
230 V 50 Hz**

Price
See price
list

| Motor data | | | | Setting range | | Part no. Article no. |
|-------------------------|---------------------------|-------------------------------|-------------------------------|---|---|--|
| Motor rating | Rated operational current | Rated short-circuit current | | Overload trip | Short-circuit release | |
| AC-3 | AC-3 | 380 - 415 V | | 380 - 415 V | | |
| 380 V 400 V 415 V | 400 V | Type "1" coordina- tion | Type "2" coordina- tion | | | |
| P kW | I_e A | I_q kA | I_q kA | I_r A | I_m A | |
| | | | |  |  | |
| 0.06 | 0.21 | 100 | 50 | 0.16 - 0.25 | 3.5 | MSC-R-0.25-M7(230V50Hz)/BBA 102981 |
| 0.09 | 0.31 | 100 | 50 | 0.25 - 0.4 | 5.6 | MSC-R-0.4-M7(230V50Hz)/BBA 102982 |
| 0.12 0.18 | 0.41 0.6 | 100 | 50 | 0.4 - 0.63 | 8.82 | MSC-R-0.63-M7(230V50Hz)/BBA 102983 |
| 0.25 | 0.8 | 100 | 50 | 0.63 - 1 | 14 | MSC-R-1-M7(230V50Hz)/BBA 102984 |
| 0.37 0.55 | 1.1 1.5 | 100 | 50 | 1 - 1.6 | 22.4 | MSC-R-1.6-M7(230V50Hz)/BBA 102985 |
| 0.75 | 1.9 | 100 | 50 | 1.6 - 2.5 | 35 | MSC-R-2.5-M7(230V50Hz)/BBA 102986 |
| 1.1 1.5 | 2.6 3.6 | 100 | 50 | 2.5 - 4 | 56 | MSC-R-4-M7(230V50Hz)/BBA 102987 |
| 2.2 | 5 | 100 | 50 | 4 - 6.3 | 88.2 | MSC-R-6.3-M7(230V50Hz)/BBA 102988 |
| 3 | 6.6 | 100 | – | 6.3 - 10 | 140 | MSC-R-10-M7(230V50Hz)/BBA 102989 |
| 4 | 8.5 | 100 | – | 6.3 - 10 | 140 | MSC-R-10-M9(230V50Hz)/BBA 102990 |
| 5.5 | 11.3 | 100 | – | 8 - 12 | 168 | MSC-R-12-M12(230V50Hz)/BBA 102991 |
| 3 | 6.6 | 100 | 50 | 6.3 - 10 | 140 | MSC-R-10-M17(230V50Hz)/BBA 102992 |
| 4 | 8.5 | 100 | 50 | 8 - 12 | 168 | MSC-R-12-M17(230V50Hz)/BBA 102993 |
| 5.5 | 11.3 | 100 | 50 | 8 - 12 | 168 | MSC-R-12-M17(230V50Hz)/BBA 102993 |
| 7.5 | 15.2 | 50 | 50 | 10 - 16 | 224 | MSC-R-16-M17(230V50Hz)/BBA 102994 |
| 11 | 21.7 | 50 | 50 | 20 - 25 | 350 | MSC-R-25-M25(230V50Hz)/BBA 102995 |
| 15 | 29.3 | 50 | 50 | 25 - 32 | 448 | MSC-R-32-M32(230V50Hz)/BBA 102996 |

Complete devices PKZ and DILM on BBA for reversing starters

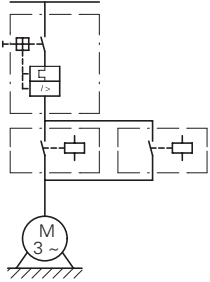
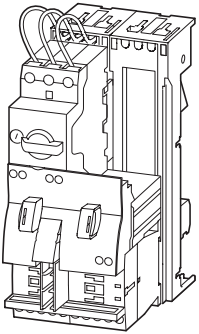

Complete devices PKZ and DILM on BBA for reversing starters

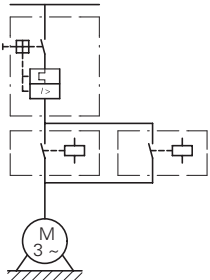
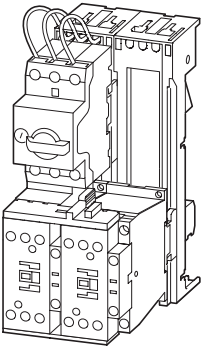

| Motor starters actuating voltage 24 V DC | Price See price list | Std. pack | Motor protective circuit breaker | Contactor | Wiring set Reversing starters | Busbar adapter | Notes |
|--|----------------------------|--------------|---|----------------|--|-------------------|---|
| Part no. Article no. | | | | | Mechanical con- nection module, electrical contact module and reversing connec- tor | | |
| Type | Type | Type | Type | Type | Type | Type | |
| MSC-R-0.25-M7(24VDC)/BBA 102997 | 1 off | PKZM0-0,25 | 2 x | DILM7-01(...) | PKZM0-XRM12 | BBA0R-25 | The reversing starters (complete devices) consist of a PKZM0 motor protective circuit breaker and two contactors DILM. These combinations are mounted on bus-bars. The connection of the main circuit between PKZ and contactor is established with electrical contact modules. Complete units with mechanical interlock, starters up to 12 A also with electrical interlock. |
| MSC-R-0.4-M7(24VDC)/BBA 102998 | 1 off | PKZM0-0,4 | 2 x | DILM7-01(...) | PKZM0-XRM12 | BBA0R-25 | |
| MSC-R-0.63-M7(24VDC)/BBA 102999 | 1 off | PKZM0-0,63 | 2 x | DILM7-01(...) | PKZM0-XRM12 | BBA0R-25 | |
| MSC-R-1-M7(24VDC)/BBA 103000 | 1 off | PKZM0-1 | 2 x | DILM7-01(...) | PKZM0-XRM12 | BBA0R-25 | |
| MSC-R-1.6-M7(24VDC)/BBA 103001 | 1 off | PKZM0-1,6 | 2 x | DILM7-01(...) | PKZM0-XRM12 | BBA0R-25 | |
| MSC-R-2.5-M7(24VDC)/BBA 103002 | 1 off | PKZM0-2,5 | 2 x | DILM7-01(...) | PKZM0-XRM12 | BBA0R-25 | |
| MSC-R-4-M7(24VDC)/BBA 103003 | 1 off | PKZM0-4 | 2 x | DILM7-01(...) | PKZM0-XRM12 | BBA0R-25 | |
| MSC-R-6.3-M7(24VDC)/BBA 103004 | 1 off | PKZM0-6,3 | 2 x | DILM7-01(...) | PKZM0-XRM12 | BBA0R-25 | |
| MSC-R-10-M7(24VDC)/BBA 103005 | 1 off | PKZM0-10 | 2 x | DILM7-01(...) | PKZM0-XRM12 | BBA0R-25 | |
| MSC-R-10-M9(24VDC)/BBA 103006 | 1 off | PKZM0-10 | 2 x | DILM9-01(...) | PKZM0-XRM12 | BBA0R-25 | |
| MSC-R-12-M12(24VDC)/BBA 103007 | 1 off | PKZM0-12 | 2 x | DILM12-01(...) | PKZM0-XRM12 | BBA0R-25 | |
| MSC-R-10-M17(24VDC)/BBA 103008 | 1 off | PKZM0-10 | 2 x | DILM17-01(...) | PKZM0-XM32DE+ DILM32-XRL | BBA0R-32 | |
| MSC-R-12-M17(24VDC)/BBA 103009 | 1 off | PKZM0-12 | 2 x | DILM17-01(...) | PKZM0-XM32DE+ DILM32-XRL | BBA0R-32 | |
| MSC-R-16-M17(24VDC)/BBA 103010 | 1 off | PKZM0-16 | 2 x | DILM17-01(...) | PKZM0-XM32DE+ DILM32-XRL | BBA0R-32 | |
| MSC-R-25-M25(24VDC)/BBA 103011 | 1 off | PKZM0-25 | 2 x | DILM25-01(...) | PKZM0-XM32DE+ DILM32-XRL | BBA0R-32 | |
| MSC-R-32-M32(24VDC)/BBA 103012 | 1 off | PKZM0-32 | 2 x | DILM32-01(...) | PKZM0-XM32DE+ DILM32-XRL | BBA0R-32 | |



| Further information | Page |
|----------------------|-------------------------|
| Technical data PKZM0 | → Chapter 1.3 |
| Accessories PKZ | → Chapter 1.3 (Page 10) |
| Technical data DILM | → Chapter 1.1 |
| DILM accessories | → Chapter 1.1 (Page 50) |

1.4

Motor-starter combinations

Type F starter combinations

1 PKZMO, DILM, BK...

| Maximum motor rating | | | | Setting range | | Rated short-circuit breaking capacity I_{cn} | | | Extension terminal | Motor protective circuit breaker | Contactor |
|------------------------|-------|-------|-------|---------------|---|--|---|-------|--------------------|----------------------------------|-----------|
| Alternating current HP | | | | Overload trip | Short-circuit release | 240 V | 480 V | 600 V | Type | Type | Type |
| 200 V | 230 V | 460 V | 575 V | | | 277 V ²⁾ | 347 V ²⁾ | | | | |
| 208 V | 240 V | 480 V | 600 V | | | | | | | | |
| HP | HP | HP | HP | I_r A |  | I_{m1} A |  | kA | kA | kA | |

Modules PKZMO, DIL, BK

| | | | | | | | | | | | |
|----|----|----|----|-------------|-----|----|----|----|---------------|------------|----------------|
| 1) | | | | 0.1 - 0.16 | 2.2 | 65 | 65 | 50 | BK25/3-PKZ0 | PKZMO-0,16 | DILEM...(...) |
| | | | | 0.1 - 0.16 | 2.2 | 65 | 65 | 50 | BK25/3-PKZ0 | PKZMO-0,16 | DILM7...(...) |
| | | | | 0.16 - 0.25 | 3.4 | 65 | 65 | 50 | BK25/3-PKZ0 | PKZMO-0,25 | DILEM...(...) |
| | | | | 0.16 - 0.25 | 3.4 | 65 | 65 | 50 | BK25/3-PKZ0 | PKZMO-0,25 | DILM7...(...) |
| | | | | 0.25 - 0.4 | 5.6 | 65 | 65 | 50 | BK25/3-PKZ0 | PKZMO-0,4 | DILEM...(...) |
| | | | | 0.25 - 0.4 | 5.6 | 65 | 65 | 50 | BK25/3-PKZ0 | PKZMO-0,4 | DILM7...(...) |
| | | | | 0.4 - 0.63 | 8.8 | 65 | 65 | 50 | BK25/3-PKZ0 | PKZMO-0,63 | DILEM...(...) |
| | | | | 0.4 - 0.63 | 8.8 | 65 | 65 | 50 | BK25/3-PKZ0 | PKZMO-0,63 | DILM7...(...) |
| | ½ | ½ | | 0.63 - 1 | 14 | 65 | 65 | 50 | BK25/3-PKZ0 | PKZMO-1 | DILEM...(...) |
| | ½ | ½ | | 0.63 - 1 | 14 | 65 | 65 | 50 | BK25/3-PKZ0 | PKZMO-1 | DILM7...(...) |
| | ¾ | 1 | | 1 - 1.6 | 22 | 65 | 65 | 50 | BK25/3-PKZ0 | PKZMO-1,6 | DILEM...(...) |
| | ¾ | 1 | | 1 - 1.6 | 22 | 65 | 65 | 50 | BK25/3-PKZ0 | PKZMO-1,6 | DILM7...(...) |
| ½ | ½ | 1 | 1½ | 1.6 - 2.5 | 35 | 65 | 65 | 50 | BK25/3-PKZ0 | PKZMO-2,5 | DILEM...(...) |
| ½ | ½ | 1 | 1½ | 1.6 - 2.5 | 35 | 65 | 65 | 50 | BK25/3-PKZ0 | PKZMO-2,5 | DILM7...(...) |
| 1 | 1 | 2 | 3 | 2.5 - 4 | 56 | 65 | 65 | 50 | BK25/3-PKZ0 | PKZMO-4 | DILEM...(...) |
| 1 | 1 | 2 | 3 | 2.5 - 4 | 56 | 65 | 65 | 50 | BK25/3-PKZ0 | PKZMO-4 | DILM7...(...) |
| 1½ | 1½ | 3 | 5 | 4 - 6.3 | 88 | 65 | 65 | 50 | BK25/3-PKZ0 | PKZMO-6,3 | DILEM...(...) |
| 1½ | 1½ | 3 | 5 | 4 - 6.3 | 88 | 65 | 65 | 50 | BK25/3-PKZ0 | PKZMO-6,3 | DILM7...(...) |
| 3 | 3 | 7½ | 10 | 6.3 - 11 | 140 | 65 | 65 | 50 | BK25/3-PKZ0 | PKZMO-10 | DILM9...(...) |
| 3 | 3 | 7½ | – | 9 - 12 | 168 | 65 | 65 | 50 | BK25/3-PKZ0 | PKZMO-12 | DILM12...(...) |
| 3 | 5 | 10 | – | 10 - 16 | 224 | 50 | 50 | – | BK50/3-PKZ4-E | PKZMO-16 | DILM17...(...) |
| 3 | 5 | 10 | – | 10 - 16 | 224 | 18 | 18 | – | BK50/3-PKZ4-E | PKZMO-16 | DILM17...(...) |
| 5 | 5 | 10 | – | 16 - 20 | 280 | 18 | 18 | – | BK50/3-PKZ4-E | PKZMO-20 | DILM25...(...) |
| 5 | 7½ | 15 | – | 20 - 25 | 350 | 18 | 18 | – | BK50/3-PKZ4-E | PKZMO-25 | DILM25...(...) |
| 7½ | 10 | 20 | – | 25 - 32 | 448 | 18 | 18 | – | BK50/3-PKZ4-E | PKZMO-32 | DILM32...(...) |

Modules PKZM4, DIL, BK

| | | | | | | | | | | | |
|----|----|----|----|---------|-----|----|----|----|---------------|----------|----------------|
| 3 | 5 | 10 | 15 | 10 - 16 | 224 | 65 | 65 | 50 | BK50/3-PKZ4-E | PKZM4-16 | DILM17...(...) |
| 5 | 7½ | 15 | 20 | 16 - 27 | 350 | 65 | 65 | 50 | BK50/3-PKZ4-E | PKZM4-25 | DILM25...(...) |
| 7½ | 10 | 25 | 30 | 24 - 34 | 448 | 65 | 65 | 50 | BK50/3-PKZ4-E | PKZM4-32 | DILM32...(...) |
| 10 | 15 | 30 | 30 | 32 - 40 | 560 | 65 | 65 | 50 | BK50/3-PKZ4-E | PKZM4-40 | DILM40(...) |
| 10 | 15 | 30 | – | 40 - 52 | 700 | 65 | 65 | – | BK50/3-PKZ4-E | PKZM4-50 | DILM50(...) |
| 15 | 15 | 40 | – | 50 - 56 | 812 | 65 | 65 | – | BK50/3-PKZ4-E | PKZM4-58 | DILM65(...) |
| 15 | 15 | 40 | – | 52 - 58 | 882 | 65 | 65 | – | BK50/3-PKZ4-E | PKZM4-63 | DILM65(...) |

Notes

Device for world markets Δ IEC UL/CSA

Service factor (SF)

Set value I_r on the current scale, depending on the load factor

SF=1.15 $\rightarrow I_r = 1 \times I_{n \text{ mot}}$

SF=1.0 $\rightarrow I_r = 0.9 \times I_{n \text{ mot}}$

1) Calculate motor power in this range according to the rated operational current. Stated values to NEC Table 430 - 150.

2) Suitable for networks with grounded star-point

Type F starter combinations do not need an upstream protective device.

For use in Canada, the switch must be fitted with an AK-PKZ0.

DILM, ZE, ZB, Z5, ZW7

Rating data for approved types¹⁾

| Maximum motor rating | | | | Max. rated motor current | Contactor | Overload relay | Maximum short-circuit protective device for North America | |
|------------------------|----------------------|----------------------|----------------------|--------------------------|-----------|----------------|---|-------------------------------|
| Alternating current HP | | | | | | | Fuse CEC or NEC | Circuit-breaker ²⁾ |
| 200 V 208 V HP | 230 V 240 V HP | 460 V 480 V HP | 575 V 600 V HP | A | Type | Type | Continuous current | Short-circuit release |

Modules DIL, Z

| | | | | | | | | | |
|-----|-----|-----|-----|------|------------------|---------------|-------------|------|-------|
| – | – | ½ | ½ | 1 | DILEM-...(...) | ZE-1.0 | 3 | 15 | – |
| – | – | ¾ | 1 | 1.4 | DILEM-...(...) | ZE-1.6 | 6 | 15 | – |
| ½ | ½ | 1 | 1½ | 2.3 | DILEM-...(...) | ZE-2.4 | 6 | 15 | – |
| – | 1 | 2 | 3 | 3.9 | DILEM-...(...) | ZE-4 | 15 | 15 | – |
| 1½ | 1½ | 3 | – | 6 | DILEM-...(...) | ZE-6 | 20 | 15 | – |
| – | 2 | – | – | 6.8 | DILEM-...(...) | ZE-9 | 35 | 15 | – |
| 2 | 2 | 5 | 5 | 7.8 | DILEM-...(...) | ZE-9 | 35 | 15 | – |
| 2 | 3 | 5 | 5 | 9.6 | DILEM-...(...) | ZE-12 | 45 | – | – |
| – | – | ½ | ½ | 1 | DILM7...(...) | ZB12-1 | 3 | 25 | 200 |
| – | – | ¾ | 1 | 1.4 | DILM7...(...) | ZB12-1,6 | 6 | 25 | 200 |
| ½ | ½ | 1 | 1½ | 2.3 | DILM7...(...) | ZB12-2,4 | 6 | 25 | 200 |
| 1 | 1 | 2 | 3 | 3.9 | DILM7...(...) | ZB12-4 | 15 | 25 | 200 |
| 1½ | ½ | 3 | – | 6 | DILM7...(...) | ZB12-6 | 20 | 25 | 200 |
| – | – | – | 7½ | 9 | DILM9...(...) | ZB12-10 | 25 | 25 | 200 |
| – | 3 | 5 | 7½ | 9.6 | DILM12...(...) | ZE-12 | 25 | 25 | 200 |
| – | – | 7½ | 10 | 11 | DILM12...(...) | ZB12-12 | 45 | 25 | 200 |
| – | 5 | 10 | – | 15.2 | DILM15...(...) | ZB12-16 | 60 | 40 | 320 |
| – | – | ½ | ½ | 1 | DILM17...(...) | ZB32-1 | 3 | 25 | 200 |
| – | – | ¾ | 1 | 1.4 | DILM17...(...) | Z78447 | 6 | 25 | 200 |
| ½ | ½ | 1 | 1½ | 2.3 | DILM17...(...) | ZB32-2,4 | 6 | 25 | 200 |
| 1 | 1 | 2 | 3 | 3.9 | DILM17...(...) | ZB32-4 | 15 | 25 | 200 |
| ½ | 1½ | 3 | – | 6 | DILM17...(...) | ZB32-6 | 20 | 25 | 200 |
| – | 3 | 5 | 7½ | 9.6 | DILM17...(...) | ZB32-10 | 25 | 25 | 200 |
| – | – | 7½ | 10 | 11 | DILM17...(...) | ZB32-16 | 40 | 30 | 320 |
| – | 5 | 10 | – | 15.2 | DILM17...(...) | ZB32-16 | 40 | 30 | 320 |
| – | 7½ | 15 | 20 | 22 | DILM25...(...) | ZB32-24 | 90 | 100 | 1200 |
| – | 10 | 20 | 25 | 32.2 | DILM32...(...) | ZB32-32 | 125 | 125 | 1200 |
| – | 3 | 5 | 7½ | 9.6 | DILM40(...) | ZB65-10 | 40 | 40 | 380 |
| – | 5 | 10 | 10 | 15.2 | DILM40(...) | ZB65-16 | 60 | 60 | 760 |
| – | 7½ | 20 | 25 | 32.2 | DILM40(...) | ZB65-24 | 90 | 90 | 1200 |
| – | 10 | 20 | 30 | 34 | DILM40(...) | ZB65-40 | 125 | 125 | 1200 |
| – | 20 | 40 | 50 | 54 | DILM50(...) | ZB65-57 | 200 | 150 | 2000 |
| – | 20 | 50 | 50 | 63 | DILM65(...) | ZB65-65 | 200 | 160 | 2000 |
| – | 25 | 50 | 60 | 68 | DILM80(...) | ZB150-70 | 250 | 250 | 2500 |
| – | 30 | 75 | 100 | 99 | DILM95(...) | ZB150-100 | 400 | 400 | 3200 |
| – | 40 | 100 | 100 | 124 | DILM115(...) | ZB150-125 | 500 | 500 | 4000 |
| – | 60 | 125 | 125 | 156 | DILM150(...) | ZB150-150 | 600 | 600 | 4800 |
| 50 | 60 | 125 | 150 | 156 | DILM185A/22(...) | Z5-160/FF225A | 600 CLASS J | 600 | 7200 |
| 60 | 75 | 150 | 200 | 192 | DILM225A/22(...) | Z5-220/FF225A | 800 CLASS J | 800 | 16000 |
| 75 | 100 | 200 | 250 | 248 | DILM250/22(...) | Z5-250/FF250 | 700 CLASS J | 600 | – |
| 100 | 125 | 250 | 300 | 312 | DILM300A/22(...) | ZW7-400 | 1000 | 1000 | – |
| 125 | 150 | 300 | 400 | 382 | DILM400/22(...) | ZW7-400 | 1000 | 1000 | – |
| 150 | 200 | 400 | 500 | 480 | DILM500/22(...) | ZW7-540 | 1000 | 600 | – |

Notes

¹⁾ Devices for world markets IEC ≙ UL/CSA

²⁾ Circuit-breaker -> See catalog

1.4 Motor-starter combinations

Function blocks

1 NZMH...S...CNA, DILM..., ZB, Z5, ZW7

Rating data for approved types

Maximum motor rating
Alternating current HP

Max. rated motor current

Rated short-circuit breaking capacity

Setting range

Overload trip

Short-circuit releases

Circuit-breaker

Contactor

Overload relay

Minimum enclosure volume

200 V 230 V 460 V 575 V
208 V 240 V 480 V 600 V

480 V 600 Y 600 V
347 V¹⁾

Type

Type

Type

HP HP HP HP A kA kA kA A A cm³



Module NZMH...S...CNA, DILM, Z

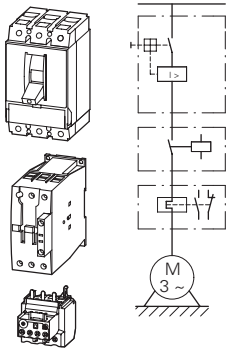

| HP | HP | HP | HP | A | kA | kA | kA | A | A | Type | Type | Type | cm ³ |
|-----|-----|-----|-----|------|-----|----|----|-----------|-------------|-----------------|---------------|--------------|-----------------|
| – | – | – | ½ | 0.9 | 100 | 50 | – | 0.6 - 1 | 12.8 - 22.5 | NZMH2-S1.6-CNA | DILM17-...(…) | ZB32-1 | 81.5 |
| – | – | ½ | ¾ | 1.3 | 100 | 50 | – | 1 - 1.6 | 12.8 - 22.5 | NZMH2-S1.6-CNA | DILM17-...(…) | ZB32-1,6 | 81.5 |
| – | – | ¾ | – | 1.6 | 100 | 50 | – | 1 - 1.6 | 19.2 - 33.6 | NZMH2-S2.4-CNA | DILM17-...(…) | ZB32-1,6 | 81.5 |
| – | – | 1 | 1 | 2.1 | 100 | 50 | – | 1.6 - 2.4 | 19.2 - 33.6 | NZMH2-S2.4-CNA | DILM17-...(…) | ZB32-2,4 | 81.5 |
| – | ½ | – | 1½ | 2.4 | 100 | 50 | – | 1.6 - 2.4 | 32 - 56 | NZMH2-S5-CNA | DILM17-...(…) | ZB32-2,4 | 81.5 |
| ¾ | ¾ | 2 | 3 | 3.9 | 100 | 50 | – | 2.4 - 4 | 32 - 56 | NZMH2-S5-CNA | DILM17-...(…) | ZB32-4 | 81.5 |
| – | 1 | – | – | 4.2 | 100 | 50 | – | 4 - 6 | 32 - 56 | NZMH2-S5-CNA | DILM17-...(…) | ZB32-6 | 81.5 |
| 1 | 1½ | 3 | – | 6 | 100 | 50 | – | 4 - 6 | 48 - 84 | NZMH2-S8-CNA | DILM17-...(…) | ZB32-6 | 81.5 |
| 1½ | 2 | – | 5 | 6.9 | 100 | 50 | – | 6 - 10 | 48 - 84 | NZMH2-S8-CNA | DILM17-...(…) | ZB32-10 | 81.5 |
| 2 | 3 | 5 | 7½ | 9.6 | 100 | 50 | – | 6 - 10 | 80 - 140 | NZMH2-S12-CNA | DILM17-...(…) | ZB32-10 | 81.5 |
| 3 | 5 | 10 | 10 | 15.2 | 100 | 50 | – | 10 - 16 | 128 - 224 | NZMH2-S18-CNA | DILM17-...(…) | ZB32-16 | 81.5 |
| 5 | – | – | 15 | 17.5 | 100 | 50 | – | 16 - 24 | 200 - 350 | NZMH2-S26-CNA | DILM17-...(…) | ZB32-24 | 81.5 |
| – | 7½ | 15 | 20 | 22 | 100 | 50 | – | 16 - 24 | 200 - 350 | NZMH2-S26-CNA | DILM25-...(…) | ZB32-24 | 81.5 |
| 7½ | – | – | – | 25.3 | 100 | 50 | – | 24 - 32 | 256 - 448 | NZMH2-S33-CNA | DILM25-...(…) | ZB32-32 | 81.5 |
| – | 10 | 20 | 25 | 28 | 100 | 50 | – | 24 - 32 | 256 - 448 | NZMH2-S33-CNA | DILM32-...(…) | ZB32-32 | 81.5 |
| 10 | – | – | – | 32.2 | 100 | 50 | – | 24 - 32 | 320 - 560 | NZMH2-S40-CNA | DILM32-...(…) | ZB32-32 | 81.5 |
| – | – | 25 | 30 | 34 | 100 | 50 | – | 32 - 40 | 320 - 560 | NZMH2-S40-CNA | DILM40(…) | ZB65-40 | 81.5 |
| – | – | 30 | – | 40 | 100 | 50 | – | 32 - 40 | 400 - 700 | NZMH2-S50-CNA | DILM40(…) | ZB65-40 | 81.5 |
| – | 15 | – | 40 | 42 | 100 | 50 | – | 40 - 57 | 400 - 700 | NZMH2-S50-CNA | DILM40(…) | ZB65-57 | 81.5 |
| 15 | 20 | 40 | 50 | 54 | 100 | 50 | – | 40 - 57 | 504 - 882 | NZMH2-S63-CNA | DILM50(…) | ZB65-57 | 81.5 |
| 20 | – | 50 | 60 | 65 | 100 | 50 | – | 57 - 65 | 640 - 1120 | NZMH2-S80-CNA | DILM65(…) | ZB65-65 | 81.5 |
| – | 25 | – | – | 68 | 100 | 50 | – | 50 - 70 | 640 - 1120 | NZMH2-S80-CNA | DILM80(…) | ZB150-70 | 163 |
| 25 | 30 | 60 | 75 | 80 | 100 | 50 | – | 70 - 100 | 800 - 1400 | NZMH2-S100-CNA | DILM80(…) | ZB150-100 | 163 |
| – | 40 | 75 | 100 | 104 | 100 | 50 | – | 70 - 100 | 1000 - 1750 | NZMH2-S125-CNA | DILM95(…) | ZB150-100 | 163 |
| 30 | – | – | – | 92 | 100 | 50 | – | 70 - 100 | 1000 - 1750 | NZMH2-S125-CNA | DILM115(…) | ZB150-100 | 163 |
| 40 | – | 100 | 125 | 125 | 100 | 50 | – | 100 - 125 | 1280 - 2240 | NZMH2-S160-CNA | DILM115(…) | ZB150-125 | 163 |
| – | 50 | – | – | 130 | 100 | 50 | – | 125 - 150 | 1280 - 2240 | NZMH2-S160-CNA | DILM115(…) | ZB150-150 | 163 |
| – | – | 125 | – | 156 | 100 | 50 | – | 125 - 150 | 1600 - 2500 | NZMH2-S200-CNA | DILM150(…) | ZB150-150 | 265 |
| 50 | 60 | – | 150 | 154 | 100 | 50 | – | 120 - 160 | 1600 - 2500 | NZMH2-S200-CNA | DILM185/22(…) | Z5-160/FF250 | 265 |
| 60 | 75 | 150 | 200 | 192 | 100 | 50 | – | 160 - 220 | 220 - 3080 | NZMH2-SE220-CNA | DILM225/22(…) | Z5-220/FF250 | 265 |
| 75 | 100 | 200 | 250 | 248 | 100 | 50 | 50 | 160 - 220 | 350 - 4900 | NZMH3-SE350-CNA | DILM250/22(…) | Z5-220/FF250 | 306 |
| 100 | – | – | 300 | 289 | 100 | 50 | 50 | 190 - 290 | 350 - 4900 | NZMH3-SE350-CNA | DILM300/22(…) | ZW7-290 | 306 |
| – | 125 | 250 | – | 302 | 100 | 50 | 50 | 270 - 400 | 450 - 6300 | NZMH3-SE450-CNA | DILM300/22(…) | ZW7-400 | 306 |
| 125 | 150 | 300 | 400 | 382 | 100 | 50 | 50 | 270 - 400 | 450 - 6300 | NZMH3-SE450-CNA | DILM400/22(…) | ZW7-400 | 306 |

Notes ¹⁾ Suitable for networks with grounded star-point

Description

SWIRE...

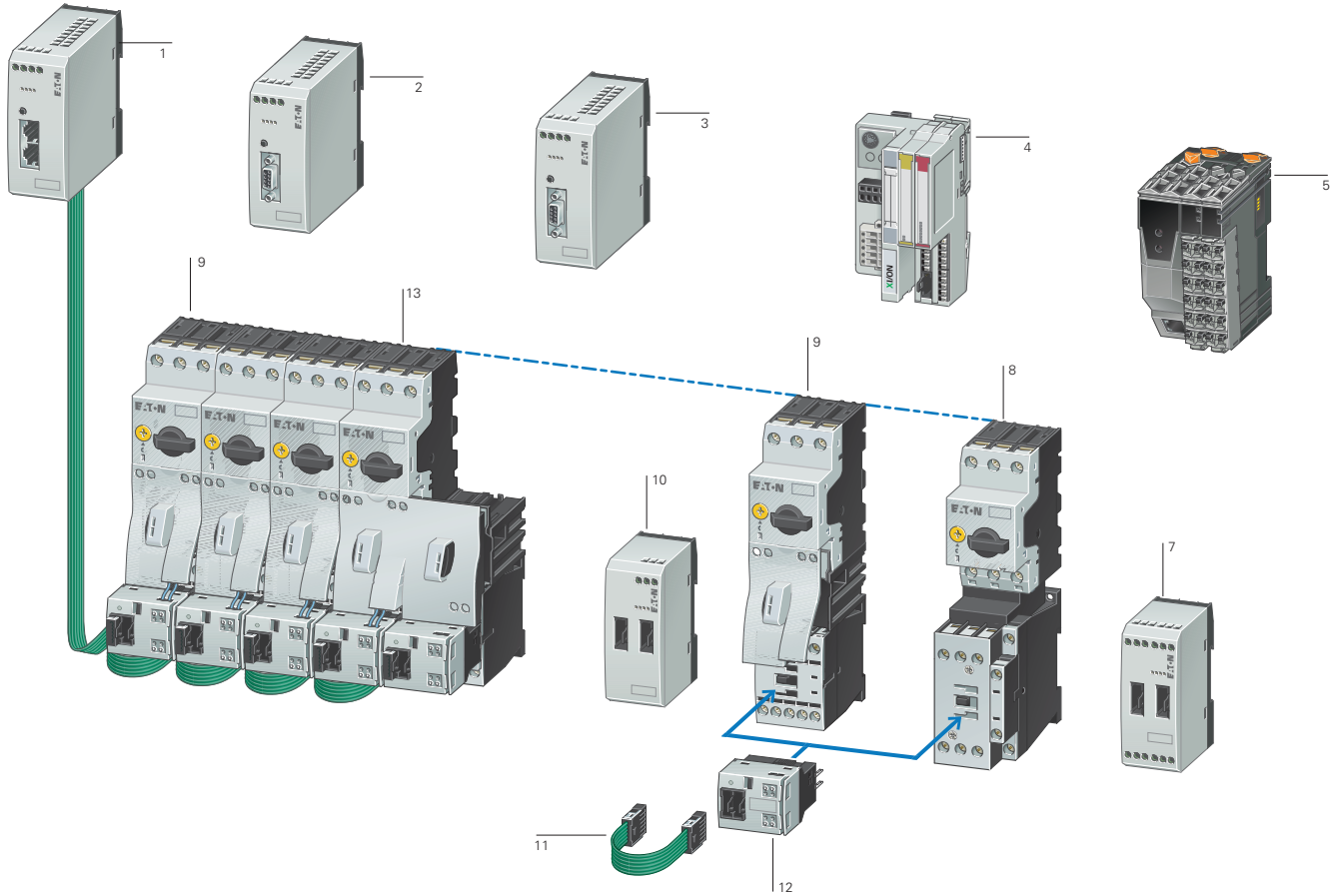

- 1 Gateway easy NET/CAN open
- 2 Gateway PROFIBUS-DP
- 3 Gateway MODBUS
- 4 Coupling unit XI/ON with SmartWire-DT® Interface card MicroInnovation AG, www.microinnovation.com
- 5 Interface module B & R CS1011 for X20 system, www.br-automation.com
- 6 SmartWire-DT® I/O module
- 7 DOL starter MSC-D up to 32 A
- 8 DOL starter MSC-D up to 15.5 A
- 9 SmartWire-DT® power module
- 10 Connection cable
- 11 SmartWire-DT® module for DILM
- 12 Reversing starter MSC-R up to 12 A

System description

With the SmartWire-DT® connection system, switchgear can be connected to a programmable logic controller without the need for complex control wiring. Plug-in SmartWire-DT® cards for DILM and a preassembled connection cable replace the control wiring, dramatically reducing wiring complexity and completely eliminating wiring errors. SmartWire-DT® also cuts the time needed for installation, commissioning and troubleshooting. The PLC's inputs and outputs are replaced by the SmartWire-DT® module for DILM, and no control wiring terminals are required. Connection to the various fieldbus systems is through third-party gateways or interface modules.

Features

- Gateway
 - Connects the SmartWire-DT® cards with the fieldbus
 - Supports the fieldbus standards PROFIBUS-DP, MODBUS, CANopen and easy-NET
 - Supplies the control voltage for the motor starter or contactor
 - Supplies the supply voltage for the SmartWire-DT® connection system
 - Configuration button for automatic addressing of the SmartWire-DT® modules for DILM
 - Supports max. 16 SmartWire-DT® modules for DILM
- Interface of third-party manufacturers, e.g. for the XI/ON I/O system, X20 system CS1011 interface module
 - Connection to the field buses PROFIBUS-DP, MODBUS, CANopen and DeviceNET
- SmartWire-DT® module for DILM
 - Pluggable on contactors
 - Suitable for contactors DILM7 to DILM32 (24 V DC), DILMC7 to DILMC32 (24 V DC), DILMP20 (24 V DC) or motor starter MSC... (24 V DC)
 - Use the standard switchgear of the xStart range
 - Suitable for DOL and reversing starters
 - The accessories of the contactor series can be used
- Suitable for contactor combinations with PKZ or with Z relays
- Integrated switch position monitoring of the contactors
- Integrated mechanical switch position display
- Actuation of the contactors
- Scanning of a potential-free contact, e.g. NHI-E-10-PKZO
- Electrical interlocking, e.g. possible with reversing starters
- LED for status and diagnostic display
- Connection to gateway or interface from third party devices
- SmartWire-DT® I/O module
 - 4 digital inputs for connection of potential-free contacts
 - Power supply for the digital inputs comes from the device
 - 2 relay outputs 250 V AC
- SmartWire-DT® power module
 - Supply of the 24 V DC control voltage for actuation of contactors DILM
 - Assembly of Emergency Off groups
 - Increases the control voltage power in the SmartWire-DT® line
- Safety engineering
 - Emergency switching off disconnection as per IEC/EN 954-1, Switching Category 3
 - Central switch off of control voltage at the gateway or SmartWire-DT® power module
 - Combination with safety-relevant switchgear possible

1.4

Connection system SmartWire-DT®

1 Ordering

SWIRE-...

| Description | Part no. Article no. | Price See price list | Std. pack | Notes |
|-------------|-------------------------|-------------------------|-----------|-------|
|-------------|-------------------------|-------------------------|-----------|-------|

Gateway

PROFIBUS-DP



Gateway with integrated supply for the SmartWire-DT® module and control voltage for the switchgear.

- Connection to PROFIBUS-DP as slave.
- Transmission rate: 9.6 Kbits/s to 12 MBit/s.
- 9 pole SUB-D socket.
- Address range 1...126.
- Connection to SmartWire-DT® module as master.
- Supports 16 SmartWire-DT® modules.

SWIRE-GW-DP
107027

1 off

MODBUS



Gateway with integrated supply for the SmartWire-DT® module and control voltage for the switchgear.

- Connection to MODBUS-RTU as slave.
- Transmission rate: 9.6 to 57.6 Kbits/s.
- 9 pole SUB-D socket RS232/RS485.
- Address range 1...31.
- Connection to SmartWire-DT® module as master.
- Supports 16 SmartWire-DT® modules.

SWIRE-GW-MB
118562

1 off

Modules

SmartWire-DT® module for DILM

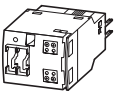

SmartWire-DT® module to assemble on the contactors DILM(C)7...DILM(C)38, DILA..., DILMP20

- One module is necessary per contactor.
- Connection to SmartWire-DT® gateway as slave.
- Max. 16 SmartWire-DT® modules per line.
- 1 digital input for floating contact.
- Signaling contactor switch position.

SWIRE-DIL
107028

5 off

- Take account of the max. current consumption of the contactor coils per SmartWire-DT® line.
- Length of connection cable at the input and the electrical interlock < 2.8 m.
- The A2 connection of the contactors must not be linked.
- Electrical interlocking only possible via the terminals on the module for DILM.
- Wiring sets DILM 12-XRL and PKZM0-XRM12 cannot be used.
- Connection terminals for electrical interlocking are not suitable for safety technology.

SmartWire-DT® power module



Power module for supplying the control voltage.

- Connection on SmartWire-DT® gateway as interactive station (no address).

SWIRE-PF
107029

1 off

Max. 4 power modules per SmartWire-DT® line.

SmartWire-DT® I/O mod-ule



4 digital inputs
2 digital relay outputs

SWIRE-4DI-2DO-R
107030

1 off























Max. 4 SmartWire-DT® I/O modules per line.

Information relevant for export to North America



| | |
|-------------------|---|
| Product Standards | IEC/EN 60947-4-1; UL 508; CSA-C22.2 No.14-05; |
| | CE marking |
| UL File No. | E29184 |
| UL CCN | NKCR |
| CSA File No. | 012528 |
| CSA Class No. | 2252-01 |
| NA Certification | UL Listed, CSA certified |

SWIRE-...

| Description | Part no. Article no. | Price See price list | Std. pack | Notes |
|--|---------------------------------|-------------------------|---|---|
| Accessory | | | | |
| SmartWire-DT® connection cable ¹⁾ | | | | |
| Length: 85 mm | SWIRE-CAB-008 107032 | | 25 off   | Cable lengths: Engineering → 34 |
| Length: 110 mm | SWIRE-CAB-011 107033 | | 25 off   | |
| Length: 150 mm | SWIRE-CAB-015 107034 | | 5 off   | |
| Length: 250 mm | SWIRE-CAB-025 107035 | | 5 off   | |
| Length: 500 mm | SWIRE-CAB-050 112027 | | 1 off   | |
| Length: 1000 mm | SWIRE-CAB-100 107036 | | 1 off   | |
| Length: 2000 mm | SWIRE-CAB-200 107037 | | 1 off   | |
| Termination connector ¹⁾ | | | | |
| – Termination plug for last SmartWire-DT® card, 6 pole, no electrical function. | SWIRE-CAB-000 107031 | | 25 off   | – |
| Data cable ¹⁾ | | | | |
| – 6-core, ribbon cable, length: 100 m. | SWIRE-CAB-100M 107038 | | 1 off   | Preassembly of cable only possible with special tool. |
| Plug ¹⁾ | | | | |
| – 6-pin plug for ribbon cable. | SWIRE-CAB-CON 107039 | | 50 off   | For use with SWIRE-CAB-100M. |
| NHI-E with cable ¹⁾ | | | | |
| – NHI-E-10-PKZO with connection cable AWG18 blue, for connection to SmartWire-DT® module for DILM. | NHI-E-10L-PKZO 107040 | | 5 off | – |
| Plug-in reversing bridge ²⁾ | | | | |
| – For assembling reversing starters with tool-less plug connection | DILM12-XR 110099 | | 20 off   | For use with DILM7...DILM15, without A2 link. |

Information relevant for export to North America



1)
 Product Standards IEC/EN 60947-4-1; UL 508; CSA-C22.2 No.14-05; CE marking
 UL File No. E29184
 UL CCN NKCR
 CSA File No. 012528
 CSA Class No. 2252-01
 NA Certification UL Listed, CSA certified

2)
 Product Standards IEC/EN 60947-4-1; UL 508; CSA-C22.2 No.14-05; CE marking
 UL File No. E36332
 UL CCN NLRV
 CSA File No. 012528
 CSA Class No. 3211-05
 NA Certification UL Listed, CSA certified

1.4 Connection system SmartWire-DT®

1 Engineering

SWIRE-... Cable lengths

For connection between motor starters and contactors DILM, the cable lengths depend on the combination and assembly of the devices.

| Applications | PKZ accessories | from | to | Cable length |
|---------------------------|----------------------------------|--------------|--------------|--------------|
| Contactors DILM | None (45 grid) | DILM7-...15 | DILM7-...15 | 85 mm |
| | | DILM17-...38 | DILM17-...38 | 85 mm |
| | | DILM7-...38 | DILM17-...38 | 110 mm |
| | | DILM17-...38 | DILM7-...15 | 110 mm |
| | PKZM0 with U-/A.../NHI.../AGM... | DILM7-...15 | DILM7-...15 | 110 mm |
| | | DILM17-...32 | DILM17-...32 | 110 mm |
| | | DILM7-...15 | DILM17-...32 | 110 mm |
| | | DILM17-...32 | DILM7-...15 | 110 mm |
| Motor starters MSC | None (45 grid) | DILM7-...15 | DILM7-...15 | 85 mm |
| | | DILM17-...32 | DILM17-...32 | 85 mm |
| | | DILM7-...15 | DILM17-...32 | 110 mm |
| | | DILM17-...32 | DILM7-...15 | 110 mm |
| | PKZM0 with U-/A.../NHI.../AGM... | DILM7-...15 | DILM7-...15 | 110 mm |
| | | DILM17-...32 | DILM17-...32 | 110 mm |
| | | DILM7-...15 | DILM17-...32 | 150 mm |
| | | DILM17-...32 | DILM7-...15 | 150 mm |

SWIRE-... Cable lengths

The cable lengths for connecting SmartWire-DT® devices depend on the combination and assembly of the devices.

| Applications | Cable length |
|--|--------------|
| Connection from power module to SWIRE-DIL with mounting beside PKZ | 250 mm |
| Connection from power module to SWIRE-DIL with mounting beside DILM | 150 mm |
| Connection from gateway to SWIRE-DIL with mounting beside PKZ | 250 mm |
| Connection from coupling unit to SWIRE-DIL with mounting beside DILM | 250 mm |

SWIRE-... Magnet systems

The number of motor starters or contactors DILM that can be connected is dependant on the power consumption of the magnet systems per SmartWire-DT® line. To increase the number of SmartWire-DT® modules that can be connected, power modules can be used.

| 24 V DC | | DILM7 | DILM9 | DILM12 | DILM15 | DILM17 | DILM25 | DILM32/38 |
|---------------|---|-------|-------|--------|-------------|-------------|-------------|-------------|
| Pick-up power | W | 3 | 3 | 4.5 | 12 at 24 V | 12 at 24 V | 12 at 24 V | 12 at 24 V |
| Holding power | W | 3 | 3 | 4.5 | 0.5 at 24 V | 0.5 at 24 V | 0.5 at 24 V | 0.5 at 24 V |

Technical data

SWIRE-...

| | | SWIRE-GW-DP | SWIRE-PF | SWIRE-DIL |
|--|-----------------|---|--------------|-------------------------------------|
| General | | | | |
| Standards | | | | |
| General | | IEC/EN 60947 EN 55011 EN 55022 IEC/EN 61000-4 IEC/EN 60068-2-27 | | |
| Profibus-DP | | IEC 61158 | – | – |
| Mounting | | Top-hat rail IEC/EN 60715 (35mm) or screw fixing with fixing brackets ZB4-101-GF1 (accessories) | | on DILM7...DILM38 |
| Dimensions (w x d x h) | mm | 35 x 90 x 109 | 35 x 90 x 74 | 45 x 44 x 81 |
| Weight | kg | 0.15 | 0.1 | 0.04 |
| Terminal capacity | | | | |
| Solid | mm ² | 0.34...1.5 | 0.34...1.5 | 0.34...1.5 |
| Flexible with ferrule | mm ² | 0.34...1.5 | 0.34...1.5 | 0.34...1.5 |
| Solid or stranded | AWG | 22...16 | 22...16 | 22...16 |
| Flat-blade screwdriver | mm | 3.5 x 0.8 | 3.5 x 0.8 | 3.5 x 0.8 |
| Max. tightening torque | Nm | 0.6 | 0.6 | 0.5 |
| Ambient climatic conditions | | | | |
| Ambient temperature | Operation | °C | -25 - +55 | -25 - +55 |
| | Storage | °C | -25 - +70 | -25 - +70 |
| Condensation | | Prevent condensation by means of suitable measures | | |
| Relative humidity, non-condensing (IEC/EN 60068-2-30) | % | 5 - 95 | 5 - 95 | 5 - 95 |
| Air pressure (in operation) | hPa | 795 - 1080 | 795 - 1080 | 795 - 1080 |
| Ambient mechanical conditions | | | | |
| Protection type (IEC/EN 60529) | | IP20 | IP20 | IP20 |
| Pollution degree | | 2 | 2 | 2 |
| Mounting position | | Vertical | Vertical | As per DILM7 to DILM38 |
| Electromagnetic compatibility (EMC) | | | | |
| Electrostatic discharge (IEC EN 61000-4-2, Level 3, ESD) | | | | |
| Air discharge | kV | 8 | 8 | 8 |
| Contact discharge | kV | – | – | – |
| Electromagnetic fields (IEC/EN 61000-4-3, RFI) | V/m | 10 | 10 | 10 |
| Radio interference suppression (EN 55011, EN 55022) | | Class A | Class A | Class A |
| Burst pulses(IEC/EN 61000-4-4, level 3) | | | | |
| Supply cables | kV | 2 | 2 | 2 |
| Signal cables | kV | 2 | 2 | 2 |
| High-energy pulses (surge) (IEC/EN 61000-4-5, level 2) | kV | 0.5 (supply cables, symmetrical) | | |
| Emitted RFI (IEC/EN 61000-4-6) | V | 10 | 10 | 10 |
| Insulation resistance | | | | |
| Clearances and creepage distances | | EN 50178, EN 60947-1, UL 508, CSA C22.2 No 142 | | |
| Insulation resistance | | EN 50178, EN 60947-1 | | |
| Supply voltage, gateway electronics and SmartWire-DT® station electronics | | | | |
| U_{gateway} | | | | |
| Rated operational voltage U _{gateway} | V DC | 24, -15 %, +20 % | – | – |
| Permissible range | | 20.4...28.8 | 20.4...28.8 | Supply from gateway or power module |
| Ripple | % | ≅ 5 | – | – |
| Maximum coupling unit power consumption at 24 V DC | mA | 500 (typically 100 for gateway + typically 25 per SmartWire-DT® module) | – | – |
| Voltage dips (IEC/EN 61131-2) | ms | 10 | – | – |
| Heat dissipation at 24 V DC | W | Normally 6 | Normally 1 | Normally 0.6 |
| Protection against polarity reversal | | Yes | – | – |
| Short-circuit protection, SmartWire-DT® side | | Yes | – | – |

1.4 Connection system SmartWire-DT®

SWIRE-...

1

| | | SWIRE-GW-DP | SWIRE-PF | SWIRE-DIL |
|--|-------|---|---|---|
| General | | | | |
| Supply voltage U_{AUX} (supply voltage for switching SmartWire-DT® elements, e.g. contactor coils) | | | | |
| Rated operational voltage U_{AUX} | V DC | 24, -15 %, +20 % (Derating from > 40 °C) | 24, -15 %, +20 % (Derating from > 40 °C) | Supply from gateway or power module |
| Permissible range | V DC | 20.4...28.8, at 45 °C: 21...28.8, at 50 °C: 21.6...28.8, at 55 °C: 22.2...27.6 | 20.4...28.8, at 45 °C: 21...28.8, at 50 °C: 21.6...28.8, at 55 °C: 22.2...27.6 | Supply from gateway or power module |
| Input current U_{AUX} at 24 V DC | A | Normally 3 | Normally 3 | – |
| Ripple | % | ≅ 5 | ≅ 5 | – |
| Voltage dips (IEC/EN 61131-2) | ms | 10 | 10 | – |
| Protection against polarity reversal | | | | |
| Short-circuit protection, SmartWire-DT® side | | No, external fuse 3 A or FAZ-Z3 | No, external fuse 3 A or FAZ-Z3 | – |
| LED indicators | | | | |
| Operational | | Ready: green | – | Ready: green |
| Power supply, SmartWire-DT® contactors | | U_{AUX} : green | U_{AUX} : green | – |
| PROFIBUS-DP status | | PROFIBUS-DP: green | – | – |
| SmartWire-DT® status | | SmartWire-DT®: green | – | above Ready |
| Output status | | – | – | – |
| Connection floating contacts | | | | |
| Number | | – | – | 1 |
| Rated voltage (internal supply) | U_e | V DC | – | 17 |
| Input current at "1" signal, typically | | mA | – | 5 |
| Potential isolation | | – | – | No |
| Max. cable length | | m | – | < 2.8 |
| PROFIBUS-DP | | | | |
| Terminal type | | SUB-D 9-pole, socket | – | – |
| Station address | | 1 ... 125 | – | – |
| Address setting | | DIP switches | – | – |
| Potential isolation | | | | |
| From U_{AUX} power supply | | Yes | – | – |
| From $U_{Gateway}$ power supply | | Yes | – | – |
| To SmartWire-DT® | | Yes | – | – |
| Function | | PROFIBUS-DP slave | – | – |
| Bus protocol | | PROFIBUS-DP | – | – |
| Bus Terminating Resistors | | can be connected via plug | – | – |
| Baud rate | | Automatic, up to 12 Mbits/s | – | – |
| SmartWire-DT® | | | | |
| Terminal type | | Plug, 6-pole | Plug, 6-pole | Plug, 6-pole |
| Data/power cable | | 6-core ribbon cable | 6-core ribbon cable | 6-core ribbon cable |
| Maximum cable length, SmartWire-DT® system | m | Max. 4 | Max. 4 | Max. 4 |
| Bus termination | | No | Plug connectors | Plug connectors |
| Station address | | Automatic assignment | None | 1...16 |
| Station | | max. 126 PROFIBUS stations | Max. 4 SmartWire-DT® cards per line | Max. 16 SmartWire-DT® cards per line |
| Address setting | | None | None | automatically via SmartWire-DT® |
| Potential isolation | | | | |
| From U_{AUX} power supply | | No | No | No |
| From $U_{Gateway}$ power supply | | No | No | No |
| Function | | SmartWire-DT® master | no SmartWire-DT® station | SmartWire-DT® slave |
| Data transfer time, SmartWire-DT® system | | | | |
| Write switch | | – | – | Normally 20 ms for all stations |
| Read status information | | – | – | Normally 10 ms per station |

SWIRE-...

1

| | | SWIRE-4DI-2DO-R | SWIRE-GW-MB |
|---|-----------------|---|--|
| General | | | |
| Standards | | | |
| General | | IEC/EN 60947, EN 55011, EN 55022, IEC/EN 61000-4, IEC/EN 60068-2-27 | |
| Mounting | | Tophat rail IEC/EN 60715 (35 mm) or screw fixing with fixing brackets ZB4-101-GF1 (accessories) | |
| Dimensions (w x d x h) | mm | 35 x 90 x 74 | 35 x 90 x 109 |
| Weight | kg | 0.12 | 0.15 |
| Terminal capacity | | | |
| Solid | mm ² | 0.5...1.5 | 0.5...1.5 |
| Flexible with ferrule | mm ² | 0.5...1.5 | 0.5...1.5 |
| Solid or stranded | AWG | 22...16 | 22...16 |
| Flat-blade screwdriver | mm | 3.5 x 0.8 | 3.5 x 0.8 |
| Max. tightening torque | Nm | 0.6 | 0.6 |
| Ambient climatic conditions | | | |
| Ambient temperature | Operation | °C | -25 - +55 |
| | Storage | °C | -25 - +70 |
| Condensation | | Prevent condensation by means of suitable measures | |
| Relative humidity, non-condensing (IEC/EN 60068-2-30) | % | 5 - 95 | 5 - 95 |
| Air pressure (in operation) | hPa | 795 - 1080 | 795 - 1080 |
| Ambient mechanical conditions | | | |
| Protection type (IEC/EN 60529, EN50178, VBG 4) | | IP20 | IP20 |
| Pollution degree | | 2 | 2 |
| Mounting position | | Vertical | Vertical |
| Electromagnetic compatibility (EMC) | | | |
| Electrostatic discharge (IEC/EN 61000-4-2, Level 3, ESD) | | | |
| Air discharge | kV | 8 | 8 |
| Contact discharge | kV | – | – |
| Electromagnetic fields (IEC/EN 61000-4-3, RFI) | V/m | 10 | 10 |
| Radio interference suppression (EN 55011, EN 55022) | | Class A | Class A |
| Burst pulses (IEC/EN 61000-4-4, level 3) | | | |
| Supply cables | kV | 2 | 2 |
| Signal cables | kV | – | 2 |
| power pulses (surge) (IEC/EN 61000-4-5, level 2) | kV | 0.5 (supply cables, symmetrical) | |
| Emitted RFI (IEC/EN 61000-4-6) | V | 10 | 10 |
| Insulation resistance | | | |
| Clearances and creepage distances | | EN 50178, EN 60947-1, UL 508, CSA C22.2 No 142 | |
| Insulation resistance | | EN 50178, EN 60947-1 | |
| Supply voltage, gateway electronics and SmartWire-DT® station electronics U_{gateway} | | | |
| Rated operational voltage U _{gateway} | V DC | – | 24, -15 %, +20 % |
| Permissible range | | Supply from gateway or power module 20.4...28.8 | |
| Ripple | % | – | ≅ 5 |
| Maximum gateway current consumption at 24 V DC | mA | – | 500 (normally 100 coupling unit + normally 25 per SmartWire-DT® card) |
| Voltage dips (IEC/EN 61131-2) | ms | – | 10 |
| Heat dissipation at 24 V DC | W | – | Normally 6 |
| Protection against polarity reversal | | | Yes |
| Short-circuit protection, SmartWire-DT® side | | – | Yes |
| Power supply U_{AUX} (power supply for switching the SmartWire-DT® slaves, e.g. contactor coils) | | | |
| Rated operational voltage U _{AUX} | V DC | – | 24, -15 %, +20 % (Derating from > 40 °C) |
| Permissible range | V DC | – | 20.4...28.8, at 45 °C: 21...28.8, at 50 °C: 21.6...28.8, at 55 °C: 22.2...27.6 |
| Input current U _{AUX} at 24 V DC | A | – | Normally 3 |
| Ripple | % | – | ≅ 5 |
| Voltage dips (IEC/EN 61131-2) | ms | – | 10 |
| Protection against polarity reversal | | | Yes |
| Voltage | U _s | V | – |
| Short-circuit protection, SmartWire-DT® side | | – | No, external 3 A fuse or FAZ-Z3 |

1.4 Connection system SmartWire-DT®

SWIRE-...

1

| | SWIRE-4DI-2DO-R | | | SWIRE-GW-MB |
|--|------------------|--------|--|---|
| LED indicators | | | | |
| Operational | | | | Ready: green |
| Power supply, SmartWire-DT® contactors | | | | U _{Aux} : green |
| MODBUS status | | | | MODBUS: yellow |
| SmartWire-DT® status | | | | SmartWire-DT®: green |
| Output status | | | | Q1, Q2: green |
| Connection floating contacts | | | | |
| Number | | | 4 | – |
| Rated voltage (internal supply) | U _e | V DC | 17 | – |
| Input current at "1" signal, typically | | mA | 5 | – |
| Potential isolation | | | – | Yes |
| Max. cable length | | m | < 2.8 | – |
| MODBUS | | | | |
| Terminal type | | | – | SUB-D, 9 pole, socket RS232/RS485 |
| Station address | | | – | 1 ... 31 |
| Address setting | | | – | DIP switches |
| Potential isolation | | | | |
| From U _{AUX} power supply | | | – | Yes |
| From U _{Gateway} power supply | | | – | Yes |
| To SmartWire-DT® | | | – | Yes |
| Function | | | – | MODBUS-RTU Slave |
| Bus protocol | | | – | MODBUS-RTU |
| Bus Terminating Resistors | | | – | can be connected via plug |
| Baud rate | | | – | Adjustable up to 57.6 (9.6/19.2/38.4) kbit/s |
| SmartWire-DT® | | | | |
| Terminal type | | | Plug, 6-pole | Plug, 6-pole |
| Data/power cable | | | 6-core ribbon cable | 6-core ribbon cable |
| Maximum cable length, SmartWire-DT® system | | m | Max. 4 | Max. 4 |
| Bus termination | | | Plug connectors | No |
| Station address | | | 1...16 | Automatic assignment |
| Station | | | Max. 4 SmartWire-DT® modules per line. | Max. 16 |
| Address setting | | | automatically via SmartWire-DT® | None |
| Potential isolation | | | | |
| From U _{AUX} power supply | | | No | No |
| From U _{Gateway} power supply | | | No | No |
| Function | | | SmartWire-DT® slave | SmartWire-DT® master |
| Data transfer time, SmartWire-DT® system | | | | |
| Write switch | | | Normally 20 ms for all stations | – |
| Read status information | | | Normally 10 ms per station | – |
| Relay outputs | | | | |
| Rated impulse withstand voltage | U _{imp} | V AC | 4000 | – |
| Overvoltage category/pollution degree | | | III/3 | – |
| Rated insulation voltage | U _i | V | 250 | – |
| Rated operating voltage | U _e | V | 250 | – |
| Making capacity | | A | 30 | – |
| Breaking capacity | 380/400 V | A | 10 | – |
| Rated operational current | | | | |
| AC-15, 250 V | I _e | A | 3 | – |
| DC-12, 30 V | I _e | A | 3 | – |
| Conventional thermal current | I _{th} | A | 6 | 6 |
| Short-circuit rating without welding | | | | |
| max.fuse | | AgG/gL | 10 | – |

MSC-D, MSC-R, MSC-DE(A)

MSC-D, MSC-R, MSC-DE(A)

1

| | | | | |
|-------------------------------|---|---|------|-----------|
| General | Standards | IEC/EN 60947-4-1, VDE 0660 UL 508 (please enquire) CSA C 22.2 No. 14 (please enquire) | | |
| | Mounting position | | | |
| Main contacts | Rated impulse withstand voltage | U_{imp} | V AC | 6000 |
| | Overvoltage category/pollution degree | | | III/3 |
| | Rated operating voltage | U_e | V | 230 - 415 |
| Further technical data | Motor protective circuit breaker | PKZM0, PKE → Chapter 1.3 | | |
| | Contactors DILM | → Chapter 1.1 | | |

Dimensions

DOL starters

MSC-D-...-M7[...15]...

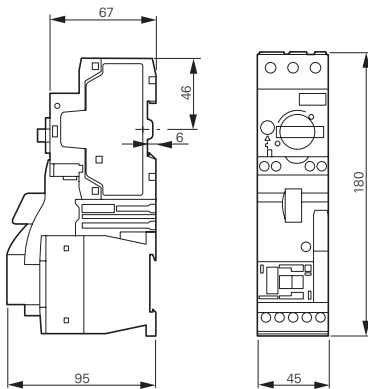

MSC-D-...-M17[...32]...

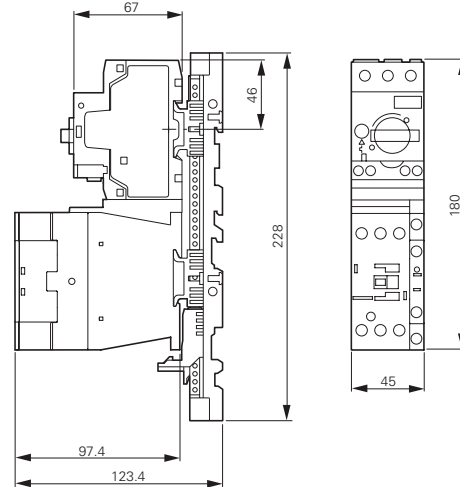

MSC-D-...-M7[...15]BBA...

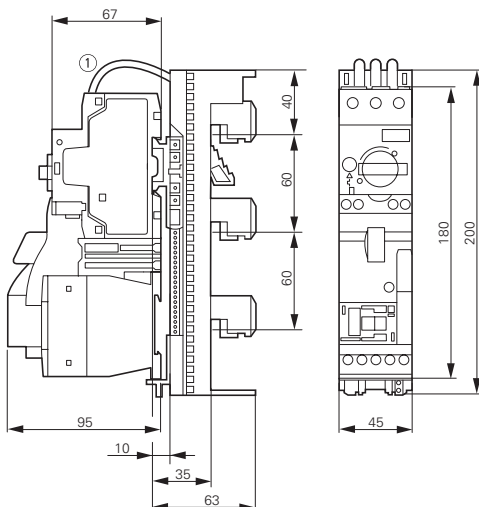

MSC-D-...-M17[...32]BBA...

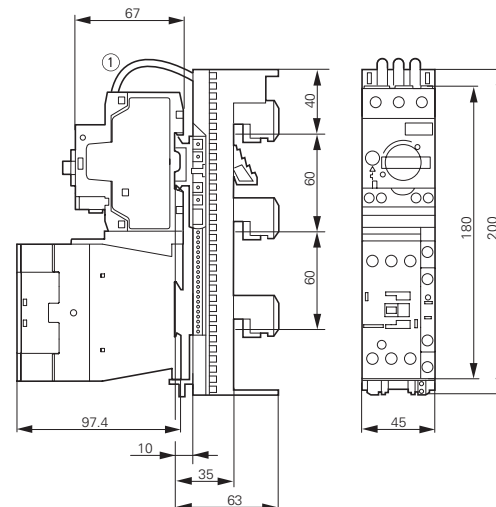

1.4 Motor-starter combinations

DOL starters, reversing starters

Reversing starters

1

MSC-R-...-M7[...12]...

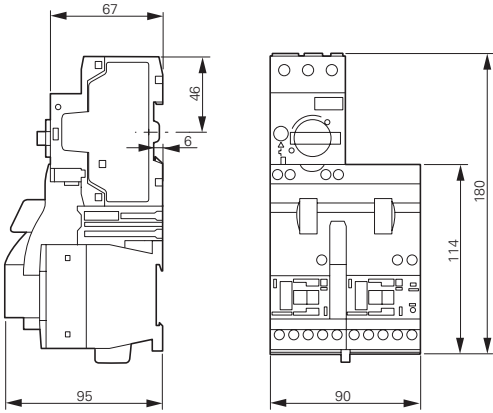

MSC-R-...-M17[...32]...

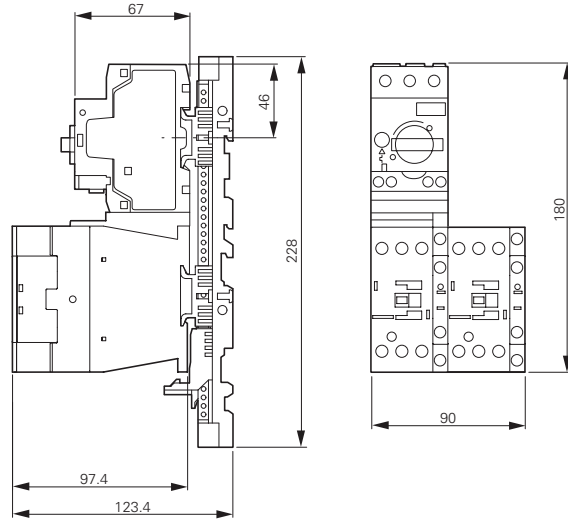

MSC-R-...-M7[...12]BBA...

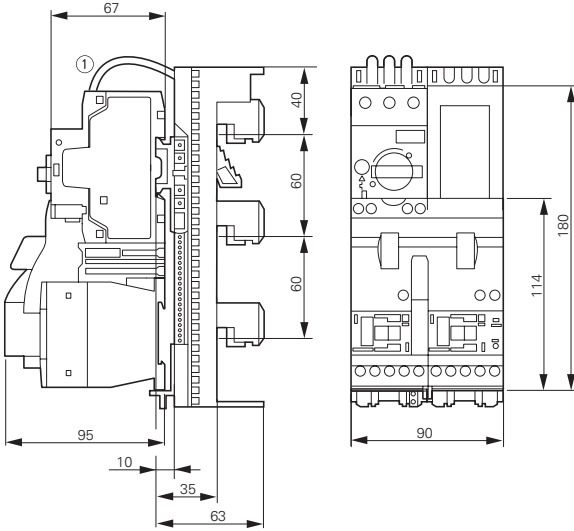

MSC-R-...-M17[...32]BBA...

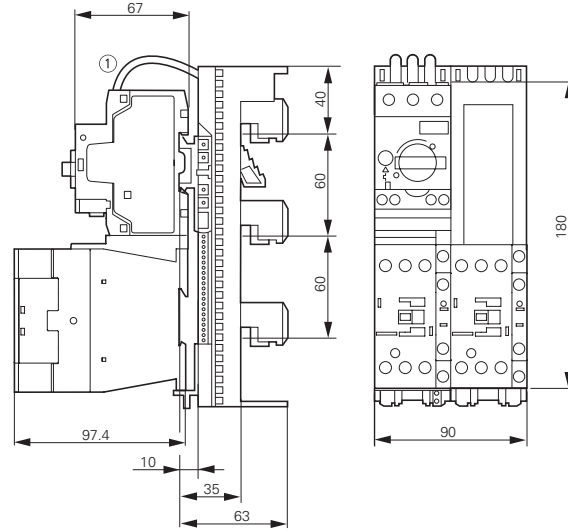

DOL starters

MSC-DE(A)-...-M7[...12]...

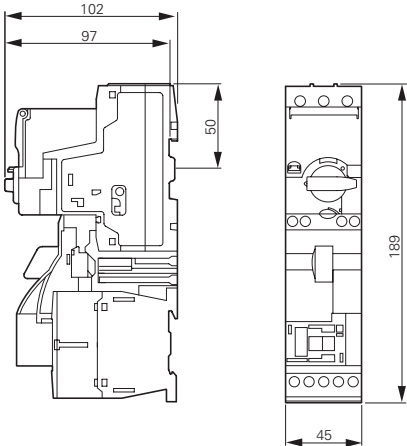

MSC-DE(A)-...-M7[...12]...

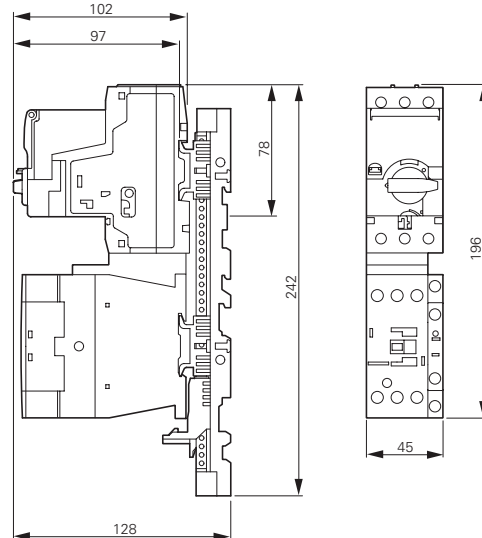

Modules

SWIRE-DIL

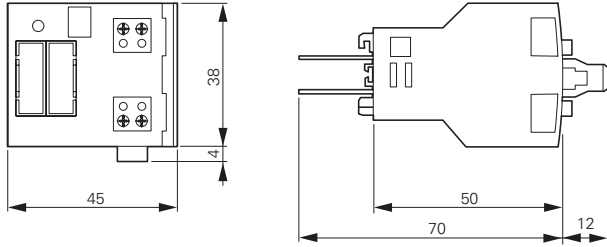

SWIRE-PF, SWIRE-4DI-2DO-R

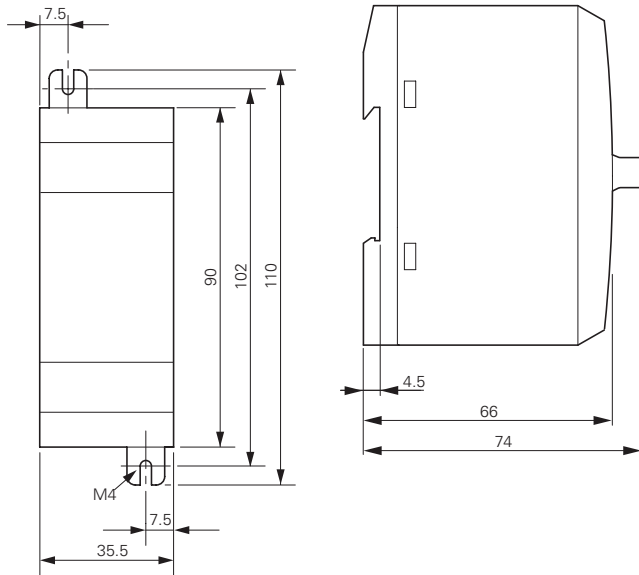

Gateways

SWIRE-GW-DP..., SWIRE-GW-MB

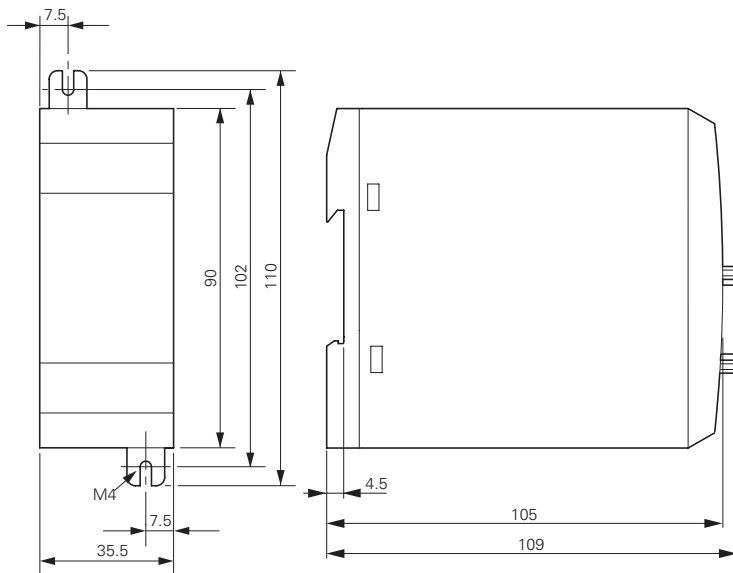

Control relays XTRG



System overview

Control relays XTRG 1

Product selection

Basic devices XTRG 2

Auxiliary contact modules, Actuating voltages / Accessories 3

Technical data

Control relays XTRG 4

Control relays XTRG

Product description

Part of the E Line family of controls, the XTRG control relay offers space savings, enhanced reliability and more efficient use of materials. Rated to operate thermal currents up to 10A, AC voltages up to 660V or DC voltages up to 250V, the XTRG contactor relay offers optimum performance in a compact package.

Features

- 10A Control relay
- 690V Insulation rating
- 660VAC or 250VDC Operational voltage
- Up to 5 sets of normally open or normally closed contacts with add-on blocks
- All common AC control voltages
- DIN rail or panel mount options
- Unique 27mm design

System overview

Control relays are used to remotely switch small loads or in complex control schemes. The XTRG relay can be integrated with contactors from the E Line family of motor controls to create compact, efficient control panels for a multitude of applications.

Standards and certifications

- GB 14048
- IEC/EN 60947
- CCC
- CE

Accessory overview

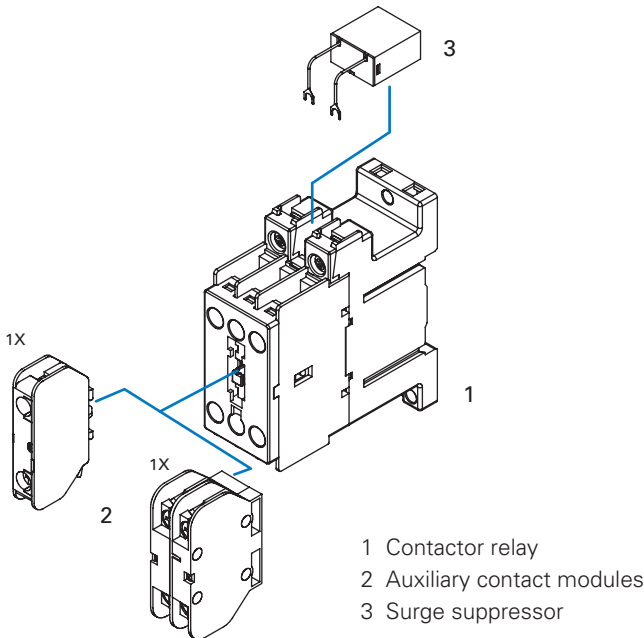

2.1

Control relays XTRG

Product selection

XTRG

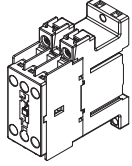

2

Control relays

| Connection type | Contact | | Rated operational current AC-15 I _e (A) | | Conventional thermal current, open, 40°C I _{th} (A) | Circuit symbol | Can be combined with auxiliary contact module | AC operation | Standard package |
|-----------------|-------------------|---------------------|--|-------|--|----------------|---|------------------------------|------------------|
| | N/O=Normally open | N/C=Normally closed | 220V | 380 V | | | | Part no. Article no. | |
| | | | 230V | 400 V | | | | Actuating voltage 220V 50HZ | |
| Screw terminals | 3 N/O | - | 4 | 1.9 | 10 | | XTCGXFAC10 XTCGXFAC.. | XTRG10B30DT 168044 | 1 piece |
| Screw terminals | 2 N/O | 1 N/C | 4 | 1.9 | 10 | | XTCGXFAC10 XTCGXFAC.. | XTRG10B21DT 167927 | 1 piece |
| Screw terminals | 1 N/O | 2 N/C | 4 | 1.9 | 10 | | XTCGXFAC10 XTCGXFAC.. | XTRG10B12DT 167968 | 1 piece |
| Screw terminals | - | 3 N/C | 4 | 1.9 | 10 | | XTCGXFAC10 XTCGXFAC.. | XTRG10B03DT 167978 | 1 piece |

Actuating voltages

| Coil Voltage | 3NO | 2NO/1NC | 1NO/2NC | 3NC |
|--------------|------------------------------|------------------------------|------------------------------|------------------------------|
| 24VAC 50Hz | XTRG10B30B5 168040 | XTRG10B21B5 167923 | XTRG10B12B5 167933 | XTRG10B03B5 167974 |
| 36VAC 50Hz | XTRG10B30DS 168041 | XTRG10B21DS 167924 | XTRG10B12DS 167934 | XTRG10B03DS 167975 |
| 48VAC 50Hz | XTRG10B30C5 168042 | XTRG10B21C5 167925 | XTRG10B12C5 167966 | XTRG10B03C5 167976 |
| 110VAC 50Hz | XTRG10B30E5 168043 | XTRG10B21E5 167926 | XTRG10B12E5 167967 | XTRG10B03E5 167977 |
| 220VAC 50Hz | XTRG10B30DT 168044 | XTRG10B21DT 167927 | XTRG10B12DT 167968 | XTRG10B03DT 167978 |
| 380VAC 50Hz | XTRG10B30DU 168047 | XTRG10B21DU 167930 | XTRG10B12DU 167971 | XTRG10B03DU 167936 |
| 24V 50/60Hz | XTRG10B30B2 177675 | XTRG10B21B2 177687 | XTRG10B12B2 177693 | XTRG10B03B2 177681 |
| 36V 50/60Hz | XTRG10B30DV 177676 | XTRG10B21DV 177688 | XTRG10B12DV 177694 | XTRG10B03DV 177682 |
| 48V 50/60Hz | XTRG10B30C2 177677 | XTRG10B21C2 177689 | XTRG10B12C2 177695 | XTRG10B03C2 177683 |
| 110V 50/60Hz | XTRG10B30E2 177678 | XTRG10B21E2 177690 | XTRG10B12E2 177696 | XTRG10B03E2 177684 |
| 220V 50/60Hz | XTRG10B30AO 177679 | XTRG10B21AO 177691 | XTRG10B12AO 177697 | XTRG10B03AO 177685 |
| 380V 50/60Hz | XTRG10B30AR 177680 | XTRG10B21AR 177692 | XTRG10B12AR 177698 | XTRG10B03AR 177686 |
| 24V DC | XTRG10B30B0 178153 | XTRG10B21B0 178152 | XTRG10B12B0 178154 | XTRG10B03B0 178151 |

Auxiliary contact, top mounting

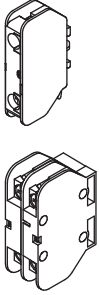

Auxiliary contact modules

| Connection type | | Conventional thermal current open, 40°C $I_{th} = I_e$ AC-1 A | Contact N/O=Normally open N/C=Normal closed | | Circuit symbol | Can be combined with control relay | Part no. Article no. | Standard package |
|-----------------|--------|--|---|-------|----------------|------------------------------------|-----------------------------|------------------|
| Screw terminals | 1 pole | 10 | 1 N/O | - | | XTRG10B.. | XTCGXFAC10 167939 | 1 piece |
| Screw terminals | 1 pole | 10 | - | 1 N/C | | XTRG10B.. | XTCGXFAC01 167940 | 1 piece |
| Screw terminals | 2 pole | 10 | 2 N/O | - | | XTRG10B.. | XTCGXFAC20 167941 | 1 piece |
| Screw terminals | 2 pole | 10 | 1 N/O | 1 N/C | | XTRG10B.. | XTCGXFAC11 167942 | 1 piece |
| Screw terminals | 2 pole | 10 | - | 2 N/C | | XTRG10B.. | XTCGXFAC02 167943 | 1 piece |

Coil surge suppressor

| Coil voltage | RC | Varistor |
|--------------|-----------------------------|-----------------------------|
| 24-48V | XTCGXRSCN2 167946 | XTCGXVSCN2 167949 |
| 110-220V | XTCGXRSCDV 167947 | XTCGXVSCDV 167950 |
| 380-440V | XTCGXRSCCM 167948 | XTCGXVSCCM 167951 |

2.1

Control relays XTRG

Technical data

General

2

| | | | XTRG10B.. | XTCGXFAC.. |
|------------------------------------|--------------|-------------------|--|------------|
| Standards | | | IEC/EN 60947, GB 14048 | |
| Mechanical lifespan | | | | |
| AC operated | Operations | x 10 ⁶ | 10 | 10 |
| Maximum operating frequency | | | | |
| Maximum operating frequency | Operations/h | | 3600 | 3600 |
| Climatic proofing | | | Damp heat, constant, to IEC 60068-2-78 Damp heat, cyclic, to IEC 60068-2-30 | |
| Ambient temperature | | | | |
| Operation | | °C | -25-55 | -25-55 |
| Storage | | °C | -40-80 | -40-80 |
| Protection type | | | IP20 | IP20 |
| Weight approximate weight | | kg | 0.17 | 0.02 |

Contacts





| | | | XTRG10B.. | XTCGXFAC.. |
|--|------------------|-------------------|-----------|------------|
| Rated impulse withstand voltage | U _{imp} | VAC | 6000 | 6000 |
| Overvoltage category/degree of pollution | | | III/3 | III/3 |
| Rated insulation voltage | U _i | VAC | 690 | 690 |
| Rated operational voltage | U _e | VAC | 660 | 660 |
| Rated operational current | | | | |
| AC-15 | | | | |
| 120V | I _e | A | 6 | 6 |
| 240V | I _e | A | 4 | 4 |
| 380V | I _e | A | 1.9 | 1.9 |
| 480V | I _e | A | 1.5 | |
| 500V | I _e | A | 1.4 | |
| 600V | I _e | A | 1.2 | |
| DC-13 | | | | |
| 125V | I _e | A | 0.55 | 0.55 |
| 250V | I _e | A | 0.27 | 0.27 |
| Conventional thermal current | I _{th} | A | 10 | 10 |
| Electrical lifespan | | | | |
| at U _e =230V, AC-15, 3A | Operations | x 10 ⁶ | 1 | 1 |

Magnet system



| | | | XTRG10B.. |
|---|--------------|---------|------------------|
| Voltage tolerance | Pick-up | $x U_c$ | 0.85-1.1 |
| Power consumption of coil in a cold state and 1.0 xUc (50Hz) | Pick-up | VA | 30 |
| | Sealing | VA | 6 |
| | Sealing | W | 2 |
| | Sealing | W | 2 |
| Power consumption of coil in a cold state and 1.0 xUc (50/60Hz) | 50Hz Pick-up | VA | 35 |
| | 50Hz Sealing | VA | 6.5 |
| | 50Hz Sealing | W | 2.3 |
| Power consumption of coil in a cold state and 1.0 xUc (50/60Hz) | 60Hz Pick-up | VA | 30 |
| | 60Hz Sealing | VA | 6 |
| | 60Hz Sealing | W | 2.1 |
| Power consumption of coil in a cold state and 1.0 xUc (24VDC) | Pick-up | VA | 12 |
| | Sealing | W | 3 |

Terminals

XTRG10B..

|  |  mm ² |  mm ² | Nm |
|--|--|--|-----|
|  | 0.75-2.5 | 0.75-2.5 | 0.8 |
|  | 0.75-2.5 | 0.75-2.5 | |

XTCGXFAC..

| A1 / A2 / Aux | mm ² | Nm |
|--|-----------------|-----|
|  | 0.75-2.5 | 0.8 |
|  | | |

2.1

Contactors XTCG

Contents

Contactors XTCG

2



System overview

Contactors XTCG 6

Product selection

Basic devices XTCG 7
 Auxiliary contact modules 7
 Accessories 8

Technical data

Contactors XTCG 10
 Auxiliary contact modules 11

Contactors XTCG

Product description

The XTCG is the flagship of the E Line family of motor controls. The XTCG contactor offers space savings, enhanced reliability and more efficient use of materials. Boasting AC-3 ratings up to 95A @ 400V and with a maximum operating voltage of 660V, XTCG offers tremendous performance in a small package.

Features

- Technologically advanced contact design
- 690V insulation rating
- Operating voltage up to 660VAC
- Up to (3) add on auxiliary contact modules
- All common AC control voltages
- DIN rail or panel mount options
- Unique space saving design

System overview

3 phase contactors are used to start motors or control industrial loads. The E Line family of contactors allows the starting of motors up to 45kW, and when combined with an XTOD overload relay or PKZC motor protective circuit breaker offers a complete package of protection and control for long life and reliable operation.

Standards and certifications

- GB 14048
- IEC/EN 60947
- CCC
- CE

Accessory overview

7-12A Frame

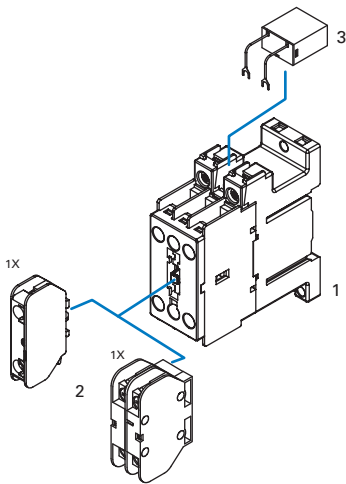

18-38A Frame

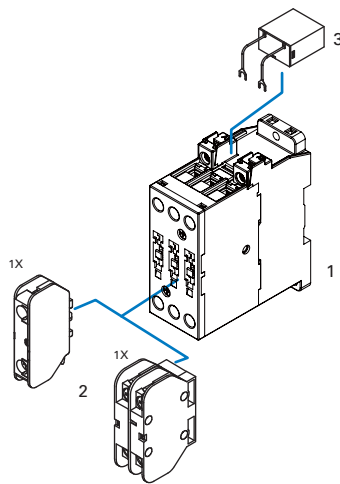

40-95A Frame

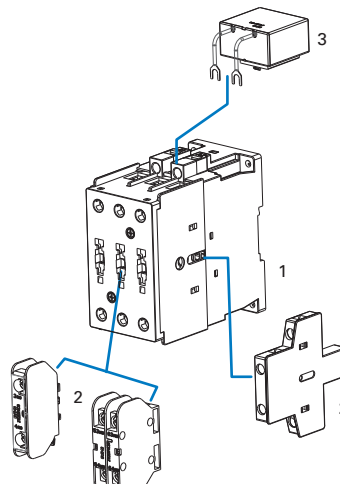

With mechanical interlock

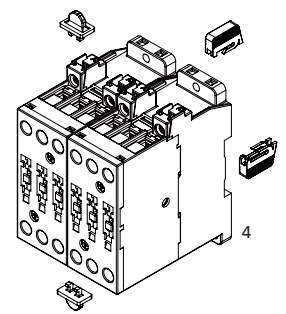

- 1 Contactor relay
- 2 Auxiliary contact modules
- 3 Surge suppressor
- 4 Interlocking kit

XTCC



3-pole contactors

| Connection type | Rated operational current AC-3 I _e (A) 380V | Max motor rating for 3-phase motors, 50-60Hz AC-3 P kW | | | Conventional thermal current, open, 40 °C I _{th} = I _e AC-1(A) | Circuit symbol | AC operation Part no. Article no. Actuating voltage 220V 50Hz | Standard package |
|-----------------|--|--|------|-------|--|----------------|---|------------------|
| | | 220V | 380V | 660V* | | | | |
| Screw terminals | 7 | 2.2 | 3 | 3.5 | 20 | | XTCC007B00DT 167984 | 1 piece |
| Screw terminals | 9 | 2.5 | 4 | 4.5 | 20 | | XTCC009B00DT 167994 | 1 piece |
| Screw terminals | 12 | 3.5 | 5.5 | 5.5 | 20 | | XTCC012B00DT 168004 | 1 piece |
| Screw terminals | 18 | 5 | 7.5 | 7.5 | 25 | | XTCC018C00DT 168014 | 1 piece |
| Screw terminals | 25 | 7.5 | 11 | 11 | 35 | | XTCC025C00DT 168024 | 1 piece |
| Screw terminals | 32 | 10 | 15 | 15 | 40 | | XTCC032C00DT 168034 | 1 piece |
| Screw terminals | 38 | 11 | 18.5 | 22 | 40 | | XTCC038C00DT 174459 | 1 piece |
| Screw terminals | 40 | 12.5 | 18.5 | 22 | 60 | | XTCC040D00DT 172214 | 1 piece |
| Screw terminals | 50 | 15.5 | 22 | 30 | 70 | | XTCC050D00DT 172224 | 1 piece |
| Screw terminals | 65 | 20 | 30 | 37 | 80 | | XTCC065D00DT 172234 | 1 piece |
| Bolts terminals | 80 | 25 | 37 | 37 | 110 | | XTCC080E00DT 172244 | 1 piece |
| Bolts terminals | 95 | 30 | 45 | 45 | 120 | | XTCC095E00DT 172254 | 1 piece |

* 40-95A is 690V.

Auxiliary contact modules

| Connection type | Poles | Conventional thermal current open, 40 °C I _{th} = I _e AC-1 A | Contact | | Circuit symbol | Can be combined with control relay | Part no. Article no. | Standard package |
|-----------------|--------|--|-------------------|-------------------|----------------|--|-----------------------------|------------------|
| | | | N/O=Normally open | N/C=Normal closed | | | | |
| Screw terminals | 1 pole | 10 | 1 N/O | - | | XTCC007B00.. XTCC009B00.. | XTCCXFAC10 167939 | 1 piece |
| | 1 pole | 10 | - | 1 N/C | | XTCC012B00.. XTCC018C00.. | XTCCXFAC01 167940 | 1 piece |
| | 2 pole | 10 | 2 N/O | - | | XTCC025C00.. XTCC032C00.. | XTCCXFAC20 167941 | 1 piece |
| | 2 pole | 10 | 1 N/O | 1 N/C | | XTCC040D00.. XTCC050D00.. | XTCCXFAC11 167942 | 1 piece |
| | 2 pole | 10 | - | 2 N/C | | XTCC065D00.. XTCC080E00.. XTCC095E00.. | XTCCXFAC02 167943 | 1 piece |
| Screw terminals | 2 pole | 10 | 1 N/O | 1 N/C | | XTCC040D00.. XTCC050D00.. XTCC065D00.. XTCC080E00.. XTCC095E00.. | XTCCXSAE11 172260 | 1 piece |

Top mounting

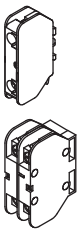

Side mounting



2.1

Contactors XTCG Product Selection

Actuating voltages

2

| Coil voltage | 7A | 9A | 12A | 18A | 25A | 32A | 38A |
|----------------|-------------------------------|-------------------------------|-------------------------------|-------------------------------|-------------------------------|-------------------------------|-------------------------------|
| 24VAC 50Hz | XTCG007B00B5 167980 | XTCG009B00B5 167990 | XTCG012B00B5 168000 | XTCG018C00B5 168010 | XTCG025C00B5 168020 | XTCG032C00B5 168030 | XTCG038C00B5 174455 |
| 36VAC 50Hz | XTCG007B00DS 167981 | XTCG009B00DS 167991 | XTCG012B00DS 168001 | XTCG018C00DS 168011 | XTCG025C00DS 168021 | XTCG032C00DS 168031 | XTCG038C00DS 174456 |
| 48VAC 50Hz | XTCG007B00C5 167982 | XTCG009B00C5 167992 | XTCG012B00C5 168002 | XTCG018C00C5 168012 | XTCG025C00C5 168022 | XTCG032C00C5 168032 | XTCG038C00C5 174457 |
| 110VAC 50Hz | XTCG007B00E5 167983 | XTCG009B00E5 167993 | XTCG012B00E5 168003 | XTCG018C00E5 168013 | XTCG025C00E5 168023 | XTCG032C00E5 168033 | XTCG038C00E5 174458 |
| 220VAC 50Hz | XTCG007B00DT 167984 | XTCG009B00DT 167994 | XTCG012B00DT 168004 | XTCG018C00DT 168014 | XTCG025C00DT 168024 | XTCG032C00DT 168034 | XTCG038C00DT 174459 |
| 380VAC 50Hz | XTCG007B00DU 167987 | XTCG009B00DU 167997 | XTCG012B00DU 168007 | XTCG018C00DU 168017 | XTCG025C00DU 168027 | XTCG032C00DU 168037 | XTCG038C00DU 174462 |
| 24VAC 50/60Hz | XTCG007B00B2 177208 | XTCG009B00B2 177214 | XTCG012B00B2 177220 | XTCG018C00B2 177226 | XTCG025C00B2 177232 | XTCG032C00B2 177238 | XTCG038C00B2 177639 |
| 36VAC 50/60Hz | XTCG007B00DV 177242 | XTCG009B00DV 177243 | XTCG012B00DV 177244 | XTCG018C00DV 177245 | XTCG025C00DV 177246 | XTCG032C00DV 177247 | XTCG038C00DV 177640 |
| 48VAC 50/60Hz | XTCG007B00C2 177209 | XTCG009B00C2 177215 | XTCG012B00C2 177221 | XTCG018C00C2 177227 | XTCG025C00C2 177233 | XTCG032C00C2 177192 | XTCG038C00C2 177641 |
| 110VAC 50/60Hz | XTCG007B00E2 177210 | XTCG009B00E2 177216 | XTCG012B00E2 177222 | XTCG018C00E2 177228 | XTCG025C00E2 177234 | XTCG032C00E2 177193 | XTCG038C00E2 177642 |
| 220VAC 50/60Hz | XTCG007B00AO 177205 | XTCG009B00AO 177211 | XTCG012B00AO 177217 | XTCG018C00AO 177223 | XTCG025C00AO 177229 | XTCG032C00AO 177235 | XTCG038C00AO 177643 |
| 380VAC 50/60Hz | XTCG007B00AR 177206 | XTCG009B00AR 177212 | XTCG012B00AR 177218 | XTCG018C00AR 177224 | XTCG025C00AR 177230 | XTCG032C00AR 177236 | XTCG038C00AR 177644 |
| 24VDC | XTCG007B00B0 177207 | XTCG009B00B0 177213 | XTCG012B00B0 177219 | XTCG018C00B0 177225 | XTCG025C00B0 177231 | XTCG032C00B0 177237 | XTCG038C00B0 177194 |

| 40A | 50A | 65A | 80A | 95A |
|-------------------------------|-------------------------------|-------------------------------|-------------------------------|-------------------------------|
| XTCG040D00B5 172210 | XTCG050D00B5 172220 | XTCG065D00B5 172230 | XTCG080E00B5 172240 | XTCG095E00B5 172250 |
| XTCG040D00DS 172211 | XTCG050D00DS 172221 | XTCG065D00DS 172231 | XTCG080E00DS 172241 | XTCG095E00DS 172251 |
| XTCG040D00C5 172212 | XTCG050D00C5 172222 | XTCG065D00C5 172232 | XTCG080E00C5 172242 | XTCG095E00C5 172252 |
| XTCG040D00E5 172213 | XTCG050D00E5 172223 | XTCG065D00E5 172233 | XTCG080E00E5 172243 | XTCG095E00E5 172253 |
| XTCG040D00DT 172214 | XTCG050D00DT 172224 | XTCG065D00DT 172234 | XTCG080E00DT 172244 | XTCG095E00DT 172254 |
| XTCG040D00DU 172217 | XTCG050D00DU 172227 | XTCG065D00DU 172237 | XTCG080E00DU 172247 | XTCG095E00DU 172257 |
| XTCG040D00B2 177645 | XTCG050D00B2 177651 | XTCG065D00B2 177657 | XTCG080E00B2 177663 | XTCG095E00B2 177669 |
| XTCG040D00DV 177646 | XTCG050D00DV 177652 | XTCG065D00DV 177658 | XTCG080E00DV 177664 | XTCG095E00DV 177670 |
| XTCG040D00C2 177647 | XTCG050D00C2 177653 | XTCG065D00C2 177659 | XTCG080E00C2 177665 | XTCG095E00C2 177671 |
| XTCG040D00E2 177648 | XTCG050D00E2 177654 | XTCG065D00E2 177660 | XTCG080E00E2 177666 | XTCG095E00E2 177672 |
| XTCG040D00AO 177649 | XTCG050D00AO 177655 | XTCG065D00AO 177661 | XTCG080E00AO 177667 | XTCG095E00AO 177673 |
| XTCG040D00AR 177650 | XTCG050D00AR 177656 | XTCG065D00AR 177662 | XTCG080E00AR 177668 | XTCG095E00AR 177674 |
| XTCG040D00B0 177195 | XTCG050D00B0 177196 | XTCG065D00B0 177197 | XTCG080E00B0 177198 | XTCG095E00B0 177199 |

2.1

Contactors XTCG

Technical data

General

2

| XT Basic device | | | CG007 | CG009 | CG012 | CG018 | CG025 | CG032 |
|---|--------------|--------------------------|--|-----------|-----------|-----------|-----------|-----------|
| Standards | | | IEC/EN 60947, GB 14048 | | | | | |
| Lifespan, mechanical | | | | | | | | |
| AC operated | Operations | x 10 ⁶ | 10 | 10 | 10 | 10 | 10 | 10 |
| Operating frequency | | | | | | | | |
| AC operated | Operations/h | | 3600 | 3600 | 3600 | 3600 | 3600 | 3600 |
| Climatic Proofing | | | Damp heat,constant,to IEC60068-2-78 Damp heat,cyclic,to IEC60068-2-30 | | | | | |
| Ambient temperature | | | | | | | | |
| Operation | | °C | -25-55 | -25-55 | -25-55 | -25-55 | -25-55 | -25-55 |
| Storage | | °C | -40-80 | -40-80 | -40-80 | -40-80 | -40-80 | -40-80 |
| Protection type | | | IP20 | IP20 | IP20 | IP20 | IP20 | IP20 |
| Weight | | | kg | 0.17 | 0.17 | 0.17 | 0.35 | 0.35 |
| Terminal capacity of main cable | | | | | | | | |
| Solid/stranded | | AWG | | | | | | |
| Terminal capacity of control circuit cable | | mm ² | 0.75-2.5 | 0.75-2.5 | 0.75-2.5 | 0.75-2.5 | 0.75-2.5 | 0.75-2.5 |
| Main cable connection screws / bolts | | | M3.5 | M3.5 | M3.5 | M5 | M5 | M5 |
| Tightening torque | | | Nm | 0.8 | 0.8 | 0.8 | 2 | 2 |
| Control circuit cable connection screws | | | M3.5 | M3.5 | M3.5 | M3.5 | M3.5 | M3.5 |
| Tightening torque | | | Nm | 0.8 | 0.8 | 0.8 | 0.8 | 0.8 |
| Main contacts | | | | | | | | |
| Rated impulse withstand voltage | | U _{imp} V AC | 6000 | 6000 | 6000 | 6000 | 6000 | 6000 |
| Overvoltage category / pollution degree | | | III/3 | III/3 | III/3 | III/3 | III/3 | III/3 |
| Rated insulation voltage | | U _i V AC | 690 | 690 | 690 | 690 | 690 | 690 |
| Rated operational voltage | | U _e V AC | 660 | 660 | 660 | 660 | 660 | 660 |
| Making capacity (cos φ to IEC/EN60947) | | 380V A | 70 | 90 | 120 | 180 | 250 | 320 |
| Breaking capacity (cos φ to IEC/EN60947) | | 380V A | 56 | 72 | 96 | 144 | 200 | 256 |
| Electrical lifespan | | | | | | | | |
| AC-3 | | Op. | 1,500,000 | 1,500,000 | 1,500,000 | 1,000,000 | 1,000,000 | 1,000,000 |
| AC-4 | | Op. | 100,000 | 100,000 | 100,000 | 100,000 | 100,000 | 100,000 |
| Magnet systems | | | | | | | | |
| Voltage tolerance AC operated | | Pick-up x U _c | 0.85-1.1 | 0.85-1.1 | 0.85-1.1 | 0.85-1.1 | 0.85-1.1 | 0.85-1.1 |
| Power consumption of coil in a cold state and 1.0 xU_c | | Pick-up VA | 30 | 30 | 30 | 80 | 80 | 80 |
| | | Sealing VA | 6 | 6 | 6 | 8.1 | 8.1 | 8.1 |
| | | Sealing W | 2 | 2 | 2 | 2.4 | 2.4 | 2.4 |
| Power consumption of coil in a cold state and 1.0 xU_c (50/60Hz) | | 50Hz Pick-up VA | 35 | 35 | 35 | 85 | 85 | 85 |
| | | 50Hz Sealing VA | 6.5 | 6.5 | 6.5 | 8.5 | 8.5 | 8.5 |
| | | 50Hz Sealing W | 2.3 | 2.3 | 2.3 | 2.6 | 2.6 | 2.6 |
| Power consumption of coil in a cold state and 1.0 xU_c (50/60Hz) | | 60Hz Pick-up VA | 30 | 30 | 30 | 80 | 80 | 80 |
| | | 60Hz Sealing VA | 6 | 6 | 6 | 8.1 | 8.1 | 8.1 |
| | | 60Hz Sealing W | 2.1 | 2.1 | 2.1 | 2.5 | 2.5 | 2.5 |
| Power consumption of coil in a cold state and 1.0 xU_c (24VDC) | | Pick-up VA | 12 | 12 | 12 | 12 | 12 | 12 |
| | | Sealing W | 3 | 3 | 3 | 3 | 3 | 3 |

| CG038 | CG040 | CG050 | CG065 | CG080 | CG095 |
|--|----------|----------|----------|----------|----------|
| IEC/EN 60947, GB 14048 | | | | | |
| 10 | 5 | 5 | 5 | 5 | 5 |
| 3600 | 3600 | 3600 | 3600 | 3600 | 3600 |
| Damp heat,constant,to IEC60068-2-78 Damp heat,cyclic,to IEC60068-2-30 | | | | | |
| -25~55 | -25~55 | -25~55 | -25~55 | -25~55 | -25~55 |
| -40~80 | -40~80 | -40~80 | -40~80 | -40~80 | -40~80 |
| IP20 | IP20 | IP20 | IP20 | IP20 | IP20 |
| 0.35 | 0.76 | 0.76 | 0.76 | 1.25 | 1.25 |
| 0.75-2.5 | 0.75-2.5 | 0.75-2.5 | 0.75-2.5 | 0.75-2.5 | 0.75-2.5 |
| M5 | M6 | M6 | M6 | M8 | M8 |
| 2 | 2.5 | 2.5 | 2.5 | 6 | 6 |
| M3.5 | M3.5 | M3.5 | M3.5 | M3.5 | M3.5 |
| 0.8 | 0.8 | 0.8 | 0.8 | 0.8 | 0.8 |
| 6000 | 6000 | 6000 | 6000 | 6000 | 6000 |
| III/3 | III/3 | III/3 | III/3 | III/3 | III/3 |
| 690 | 690 | 690 | 690 | 690 | 690 |
| 660 | 690 | 690 | 690 | 690 | 690 |
| 320 | 400 | 500 | 650 | 800 | 950 |
| 256 | 320 | 400 | 520 | 640 | 760 |
| 1,000,000 | 900,000 | 900,000 | 900,000 | 900,000 | 900,000 |
| 100,000 | | | | | |
| 0.85-1.1 | 0.85-1.1 | 0.85-1.1 | 0.85-1.1 | 0.85-1.1 | 0.85-1.1 |
| 80 | 190 | 190 | 190 | 300 | 300 |
| 8.1 | 20 | 20 | 20 | 26 | 26 |
| 2.4 | 4 | 4 | 4 | 6 | 6 |
| 85 | 220 | 220 | 220 | 350 | 350 |
| 8.5 | 21 | 21 | 21 | 34 | 34 |
| 2.6 | 6 | 6 | 6 | 9 | 9 |
| 80 | 200 | 200 | 200 | 300 | 300 |
| 8.1 | 20 | 20 | 20 | 26 | 26 |
| 2.5 | 5 | 5 | 5 | 8 | 8 |
| 12 | 65 | 65 | 65 | 90 | 90 |
| 3 | 4 | 4 | 4 | 5 | 5 |

2.1

Contactors XTCG



Technical data

Auxiliary contact



| | | | XTCGXFAC.. | XTCGXSAE11 |
|--|------------|---------------|------------|------------|
| Rated impulse withstand voltage | U_{imp} | VAC | 6000 | 6000 |
| Overvoltage category/degree of pollution | | | III/3 | III/3 |
| Rated insulation voltage | U_i | VAC | 690 | 690 |
| Rated operational voltage | U_e | VAC | 660 | 690 |
| Rated operational current | | | | |
| AC-15 | | | | |
| 120V | I_e | A | 6 | 6 |
| 240V | I_e | A | 4 | 4 |
| 380V | I_e | A | 1.9 | 1.9 |
| DC-13 | | | | |
| 125V | I_e | A | 0.55 | 0.55 |
| 250V | I_e | A | 0.27 | 0.27 |
| Conventional thermal current | I_{th} | A | 10 | 10 |
| Electrical lifespan | | | | |
| at $U_e=230V$, AC-15, 3A | Operations | $\times 10^6$ | 1 | 1 |

Terminals



7-12A

| | mm ² | mm ² | Nm | Aux Contact mm ² | Nm |
|---|-----------------|-----------------|-----|--------------------------------|-----|
|  | 0.75 - 2.5 | 0.75 - 2.5 | 0.8 | 0.75 - 2.5 | 0.8 |
|  | 0.75 - 2.5 | 0.75 - 2.5 | | | |



18-38A

| | mm ² | mm ² | Nm | Aux Contact mm ² | Nm |
|--|--------------------|--------------------|----|--------------------------------|-----|
|  | 1 - 6 (1 - 10)* | 1 - 6 (1 - 10)* | 2 | 0.75 - 2.5 | 0.8 |
|  | 1 - 4 (1 - 10)* | 1 - 4 (1 - 10)* | | | |

40-65A

| | mm ² | mm ² | Nm | Aux Contact mm ² | Nm |
|--|-----------------|-----------------|-----|--------------------------------|-----|
|  | 2.5 - 25 | 2.5 - 16 | 2.5 | 0.75 - 2.5 | 1.2 |
|  | 2.5 - 25 | 2.5 - 16 | | | |

80-95A

| | mm ² | mm ² | Nm | Aux Contact mm ² | Nm |
|--|-----------------|-----------------|----|--------------------------------|-----|
|  | 6 - 50 | 6 - 25 | 6 | 0.75 - 2.5 | 1.2 |
|  | 6 - 50 | 6 - 25 | | | |

* Only for XTCG032...

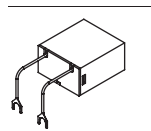

Coil surge suppressor (7-38A)

| Coil voltage | RC | Varistor |
|--------------|-----------------------------|-----------------------------|
| 24-48V | XTCGXRSCN2 167946 | XTCGXVSCN2 167949 |
| 110-220V | XTCGXRSCDV 167947 | XTCGXVSCDV 167950 |
| 380-440V | XTCGXRSCCM 167948 | XTCGXVSCCM 167951 |

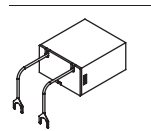

Coil surge suppressor (40-95A)

| Coil voltage | RC | Varistor |
|--------------|-----------------------------|-----------------------------|
| 24V | XTCGXRSEB5 174132 | XTCGXVSEB5 177204 |
| 36V | XTCGXRSEDS 174133 | XTCGXVSEDS 177239 |
| 48V | XTCGXRSEC5 174134 | XTCGXVSEC5 177201 |
| 110V | XTCGXRSEE5 174129 | XTCGXVSEE5 177203 |
| 220V | XTCGXRSEDT 174135 | XTCGXVSEDT 174142 |
| 380V | XTCGXRSEDU 174136 | XTCGXVSEDU 174143 |

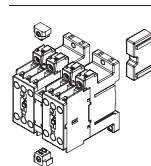

Mechanical interlock

| 7-12A | 18-38A | 40-65A | 80-95A |
|---------------------------|---------------------------|---------------------------|---------------------------|
| XTCGXMLB 167944 | XTCGXMLC 167945 | XTCGXMLD 172261 | XTCGXMLE 172262 |

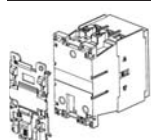

Din rail plate

| 80-95A |
|----------------------------|
| XTCGXMPPE 172908 |

Thermal overload relays XTOD/XTOG



System overview

Thermal overload relays XTOD/XTOG 13

Product selection

Thermal overload relays XTOD/XTOG 14

Technical data

Thermal overload relays XTOD/XTOG 16

Thermal overload relays XTOD/XTOG

Product description

XTOD/XTOG thermal overload relays offer precision motor protection with phase loss protection and ambient temperature compensation. The separate mount design allows for flexibility and the units can be mounted on DIN rail or directly on the panel adjacent the motor contactor.

XTOD... is for separate mounting; XTOG is for direct mounting.

Features

- Precision motor protection up to 97A
- Integral 1NO/1NC contact for contactor control and alarm signal
- Phase loss protection
- Ambient temperature compensation
- DIN rail or panel mount options

System overview

Thermal overload relays provide protective features for 1 or 3 phase motors. The relay monitors the operating current of the motor and switched the contactor off in the event of an overload situation. It also protects the motor from damage during phase loss.

Standards and certifications

- GB 14048
- IEC/EN 60947
- CCC
- CE































2.2

Thermal overload relays XTOD/XTOG











Product selection

Thermal overload relays

2

| For use with | | Setting range of overload releases I_r (A) | Circuit symbol | Auxiliary contact | | Part no. Article no. | Standard package |
|---|-------------------|---|---|---|------------------------------|------------------------------|------------------|
| | |  | | N/O =Normally open N/C =Normally closed | | | |
| XTOD..CC1S  | XTCG007 | Seperate mounting | 0.3~0.45 |  | 1 N/O 1 N/C | XTODP45CC1S 167952 | 1 piece |
| | XTCG009 | Seperate mounting | 0.45~0.67 |  | 1 N/O 1 N/C | XTODP67CC1S 167953 | 1 piece |
| | XTCG012 | | | | | | |
| | XTCG018 | Seperate mounting | 0.67~1.0 |  | 1 N/O 1 N/C | XTOD001CC1S 167954 | 1 piece |
| | XTCG025 | Seperate mounting | 1.0~1.5 |  | 1 N/O 1 N/C | XTOD1P5CC1S 167955 | 1 piece |
| | XTCG032 | | | | | | |
| | XTCG038 | Seperate mounting | 1.4~2.1 |  | 1 N/O 1 N/C | XTOD2P2CC1S 167956 | 1 piece |
| | | Seperate mounting | 1.8~2.7 |  | 1 N/O 1 N/C | XTOD2P7CC1S 167957 | 1 piece |
| | | Seperate mounting | 2.4~3.6 |  | 1 N/O 1 N/C | XTOD3P6CC1S 167958 | 1 piece |
| | | Seperate mounting | 3.5~5.0 |  | 1 N/O 1 N/C | XTOD005CC1S 167959 | 1 piece |
| | | Seperate mounting | 4.0~6.0 |  | 1 N/O 1 N/C | XTOD006CC1S 167960 | 1 piece |
| | | Seperate mounting | 5.5~8.5 |  | 1 N/O 1 N/C | XTOD8P5CC1S 167961 | 1 piece |
| | | Seperate mounting | 8.5~12.5 |  | 1 N/O 1 N/C | XTOD013CC1S 167962 | 1 piece |
| | | Seperate mounting | 12.5~18 |  | 1 N/O 1 N/C | XTOD018CC1S 167963 | 1 piece |
| | | Seperate mounting | 17~24 |  | 1 N/O 1 N/C | XTOD024CC1S 167964 | 1 piece |
| | Seperate mounting | 22~30 |  | 1 N/O 1 N/C | XTOD030CC1S 167965 | 1 piece | |
| XTOG...  | XTCG007 | Direct mounting | 0.1~0.16 |  | 1 N/O 1 N/C | XTOGP16BC1 173679 | 1 piece |
| | XTCG009 | | | | | | |
| | XTCG012 | Direct mounting | 0.16~0.24 |  | 1 N/O 1 N/C | XTOGP24BC1 173680 | 1 piece |
| | XTCG018 | Direct mounting | 0.24~0.4 |  | 1 N/O 1 N/C | XTOGP40BC1 173681 | 1 piece |
| | XTCG025 | | | | | | |
| | XTCG032 | Direct mounting | 0.4~0.6 |  | 1 N/O 1 N/C | XTOGP60BC1 173682 | 1 piece |
| | XTCG038 | Direct mounting | 0.6~1 |  | 1 N/O 1 N/C | XTOG001BC1 173683 | 1 piece |
| | | | | | | | |
| | | Direct mounting | 1~1.6 |  | 1 N/O 1 N/C | XTOG1P6BC1 173684 | 1 piece |
| | | Direct mounting | 1.6~2.4 |  | 1 N/O 1 N/C | XTOG2P4BC1 173685 | 1 piece |
| | | Direct mounting | 2.4~4 |  | 1 N/O 1 N/C | XTOG004BC1 173686 | 1 piece |
| | | Direct mounting | 4~6 |  | 1 N/O 1 N/C | XTOG006BC1 173687 | 1 piece |
| | | Direct mounting | 6~10 |  | 1 N/O 1 N/C | XTOG010BC1 173688 | 1 piece |
| | | Direct mounting | 9-12 |  | 1 N/O 1 N/C | XTOG012BC1 173689 | 1 piece |
| | | Direct mounting | 12~16 |  | 1 N/O 1 N/C | XTOG016CC1 173690 | 1 piece |
| | | Direct mounting | 16~24 |  | 1 N/O 1 N/C | XTOG024CC1 173691 | 1 piece |
| | | Direct mounting | 24~32 |  | 1 N/O 1 N/C | XTOG032CC1 173692 | 1 piece |

Thermal overload relays

| For use with | | Setting range of overload releases I_r (A) | Circuit symbol | Auxiliary contact | | Part no. Article no. | Standard package |
|---|---------|---|----------------|---|-------------|-----------------------------|------------------|
| | |  | | N/O = Normally open N/C = Normally closed | | | |
| XTOG...  | XTCG040 | Direct mounting | 17~25 |  | 1 N/O 1 N/C | XTOG025DC1 173693 | 1 piece |
| | XTCG050 | Direct mounting | 23~32 |  | 1 N/O 1 N/C | XTOG032DC1 173694 | 1 piece |
| | XTCG065 | | 30~40 |  | 1 N/O 1 N/C | XTOG040DC1 173695 | 1 piece |
| | XTCG080 | Direct mounting | 37~50 |  | 1 N/O 1 N/C | XTOG050DC1 173696 | 1 piece |
| | XTCG095 | | 48~65 |  | 1 N/O 1 N/C | XTOG065DC1 173697 | 1 piece |
| | | Direct mounting | 37~50 |  | 1 N/O 1 N/C | XTOG050EC1 173698 | 1 piece |
| | | Direct mounting | 48~65 |  | 1 N/O 1 N/C | XTOG065EC1 173699 | 1 piece |
| | | Direct mounting | 63~80 |  | 1 N/O 1 N/C | XTOG080EC1 173700 | 1 piece |
| | | Direct mounting | 77~97 |  | 1 N/O 1 N/C | XTOG097EC1 173701 | 1 piece |

2.2

Thermal overload relays XTOD/XTOG

Technical data

General

| | | XTOD/XTOG |
|-------------------|--|--|
| Standards | | IEC/EN 60947, GB 14048 |
| Climatic Proofing | | Damp heat, constant, to IEC60068-2-78 Damp heat, cyclic, to IEC60068-2-30 |

Ambient temperature

| | | |
|--------------------------|----|--------|
| Open | °C | -25-55 |
| Enclosed | °C | -25-40 |
| Temperature compensation | °C | -5-40 |
| Weight | kg | 0.15 |
| Protection type | | IP20 |

Main contacts

| | | XTOD/XTOG |
|---------------------------------------|-----------|-----------|
| Rated impulse withstand voltage | U_{imp} | VAC 6000 |
| Overvoltage category/pollution degree | | III/3 |

Rated insulation voltage

| | | |
|--------------------------------|-------|---------|
| AC | U_i | VAC 690 |
| Rated operational voltage | U_e | VAC 690 |
| Overload release setting range | A | 0.1-97 |

Terminal capacity

| | | |
|-----------------------|-----------------|------------------------|
| Solid | mm ² | 1 x (1-6) 2 x (1-6) |
| Flexible with ferrule | mm ² | 1 x (1-6) 2 x (1-6) |
| Solid/stranded | AWG | |
| Terminal screw | | M4 |
| Tightening torque | Nm | 1.2 |

Auxiliary and control circuits

| | | XTOD/XTOG |
|---------------------------------------|-----------|-----------|
| Rated impulse withstand voltage | U_{imp} | V 6000 |
| Overvoltage category/pollution degree | | III/3 |

Terminal capacity

| | | |
|-----------------------|-----------------|------------------------|
| Solid | mm ² | 1 x (1-6) 2 x (1-6) |
| Flexible with ferrule | mm ² | 1 x (1-6) 2 x (1-6) |
| Solid/stranded | AWG | |
| Terminal screw | | M3.5 |
| Tightening torque | Nm | 0.8 |

| | | |
|------------------------------|----------|---------|
| Rated insulation voltage | U_i | VAC 690 |
| Rated operational voltage | U_e | VAC 690 |
| Conventional thermal current | I_{th} | A 10 |
| Rated operational current | | |

AC-15

| | | |
|----------|-------|-------|
| 120V | I_e | A 6 |
| 220/240V | I_e | A 3 |
| 380V | I_e | A 1.9 |
| 480V | I_e | A 1.5 |
| 500V | I_e | A 1.4 |
| 600V | I_e | A 1.2 |

DC-13

| | | |
|------|-------|--------|
| 125V | I_e | A 0.55 |
| 250V | I_e | A 0.27 |

Contactors

7-12A Frame

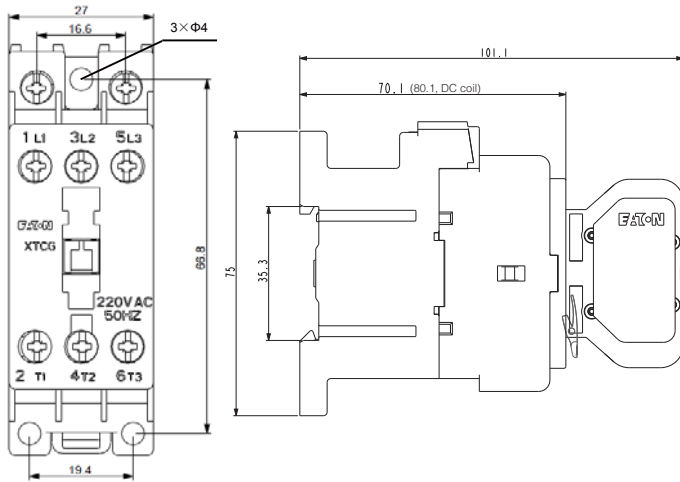

18-38A Frame

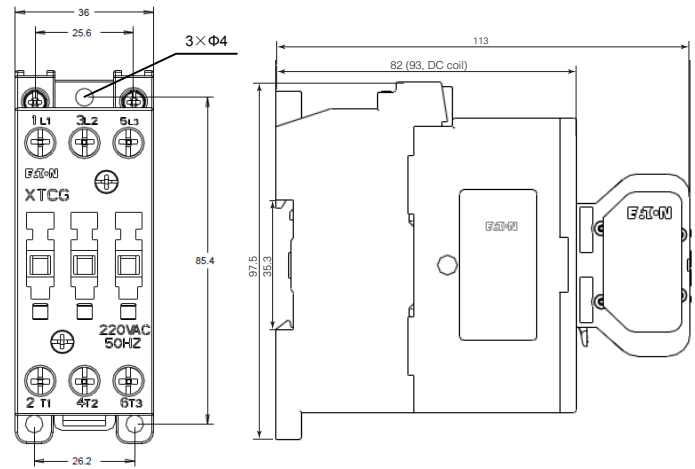

40-65A Frame

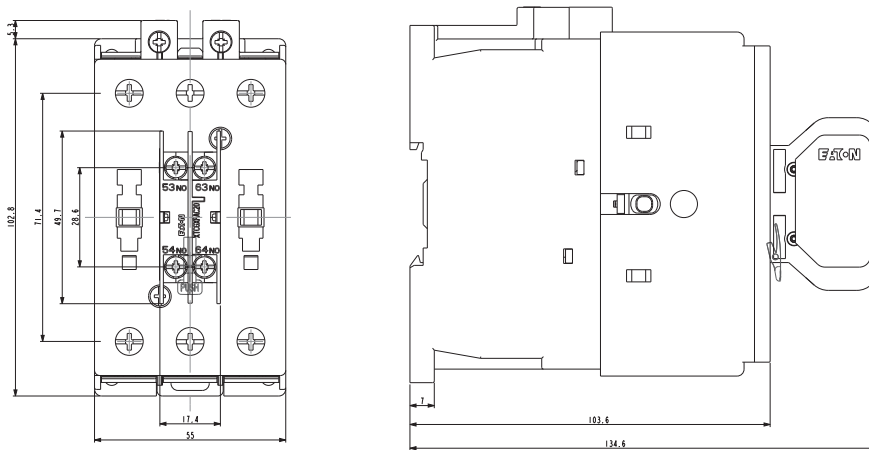

80-95A Frame

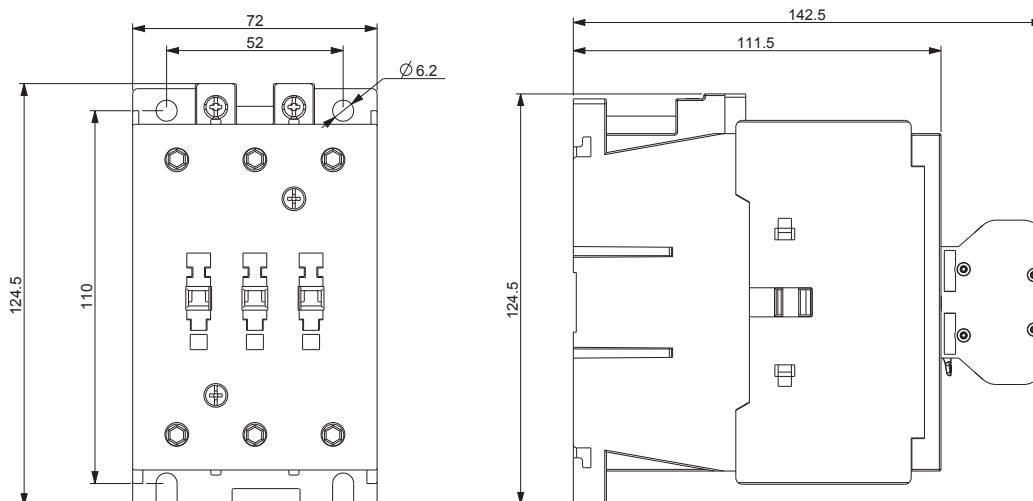

2.2

Dimensions

Thermal overload relay XTOD/XTOG

Thermal overload relay + mounting adapter

XTOD..CC1S

2

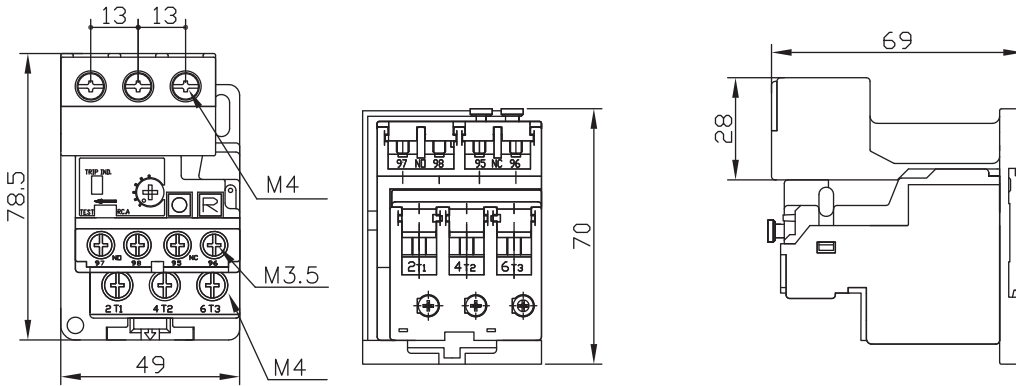

Thermal overload relays XTOG

17-65A

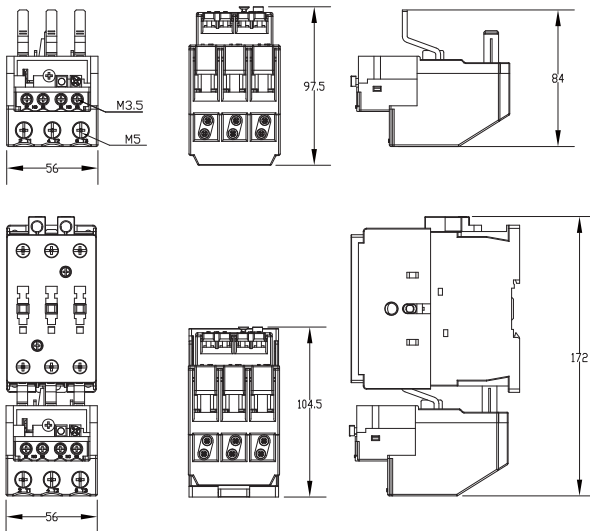

37-97A

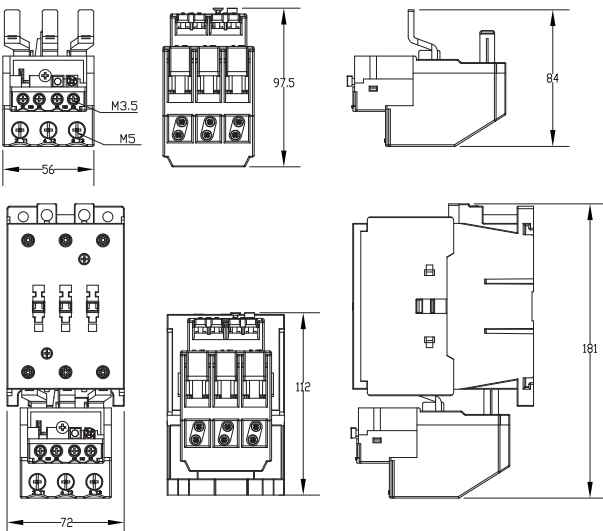

Auxiliary contact module

1 Pole

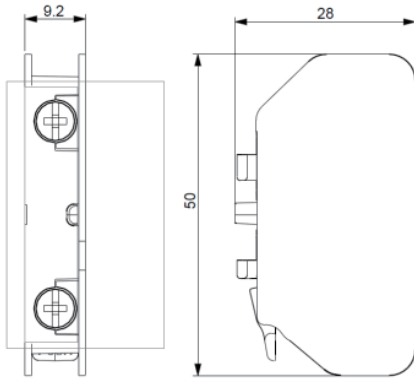

2 Pole

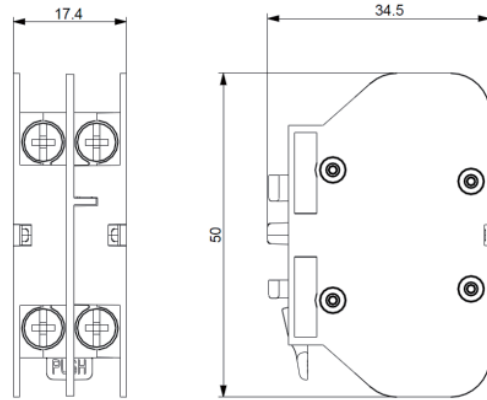

2

Side mounting contact module

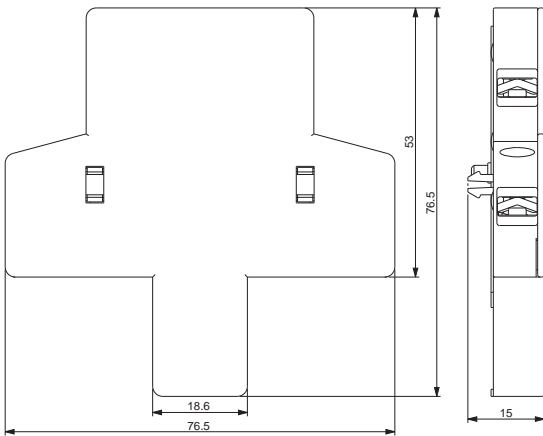

2.2

Dimensions

Control relay XTRG / Surge suppressor

Control Relay

2

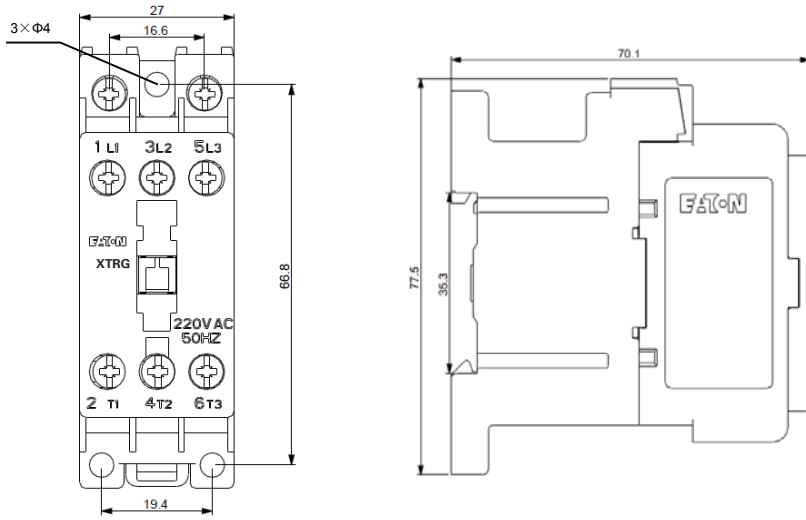

Surge suppressor

7-38A Surge suppressor

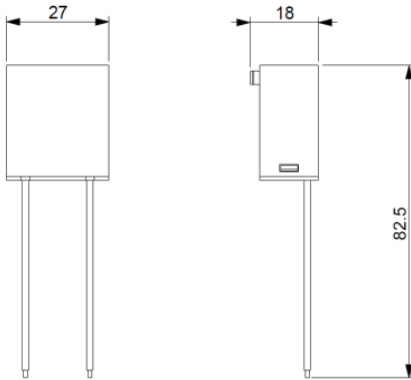

40-95A Surge suppressor

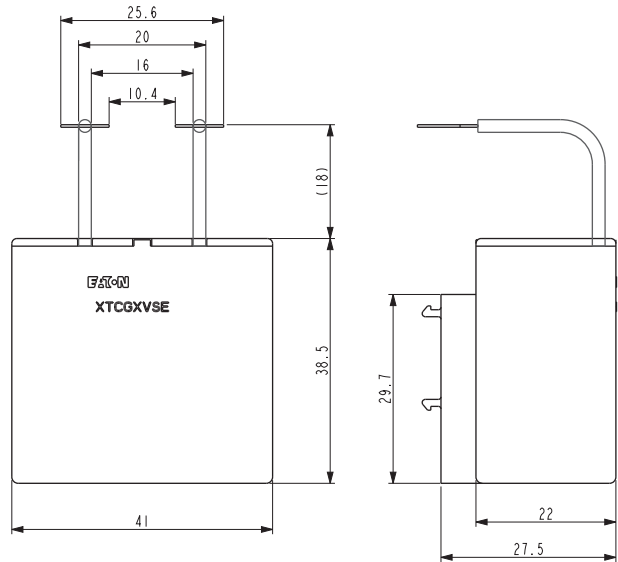

Mechanical interlock

7-12A Frame

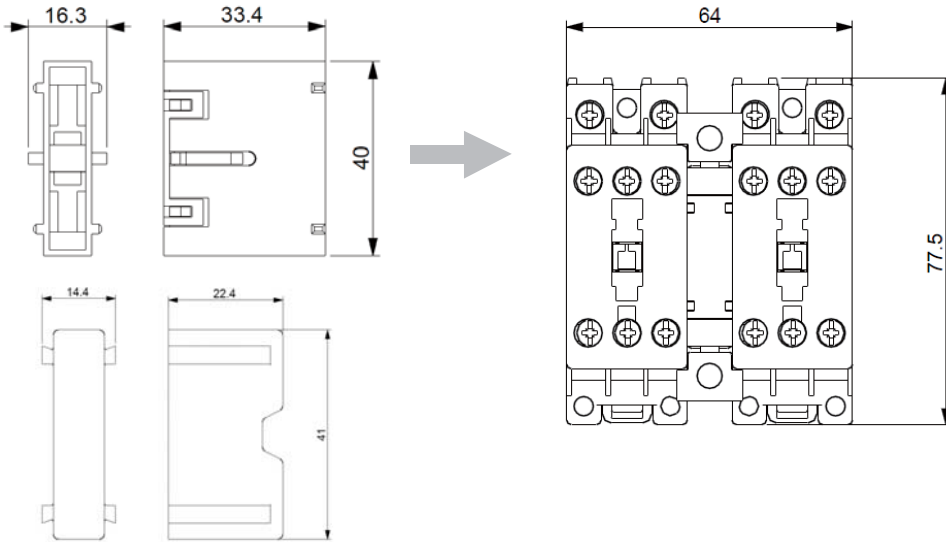

18-38A Frame

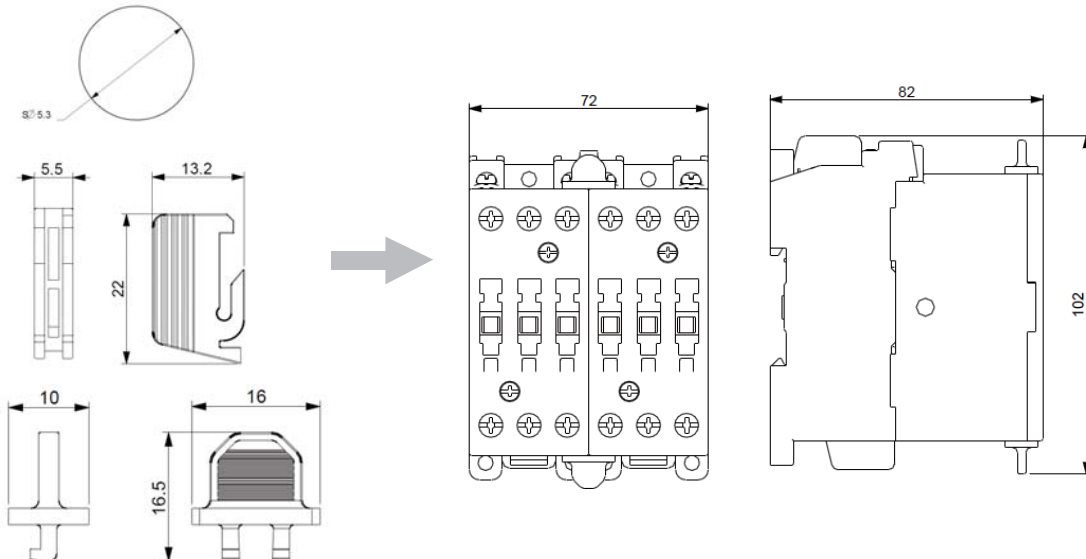

2.2

Dimensions Mechanical interlock

Mechanical interlock

40-65A Frame

2

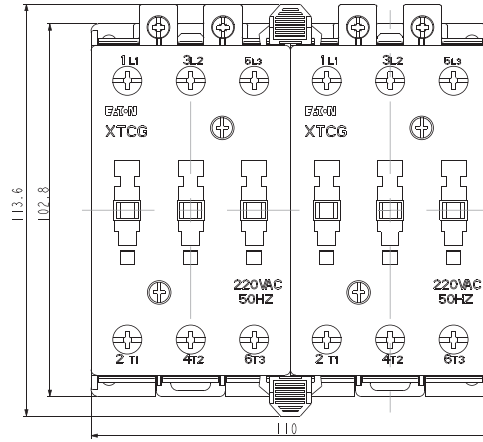
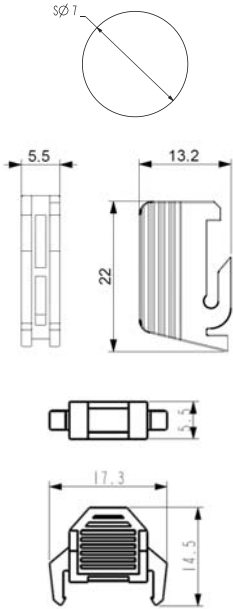

80-95A Frame

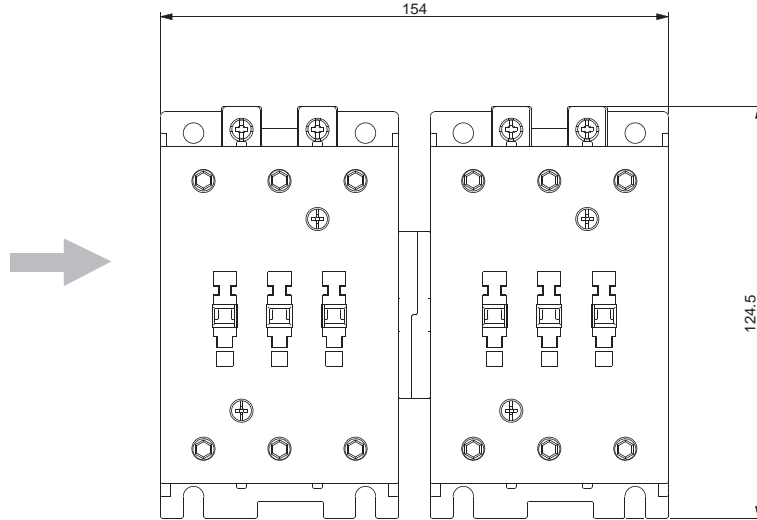
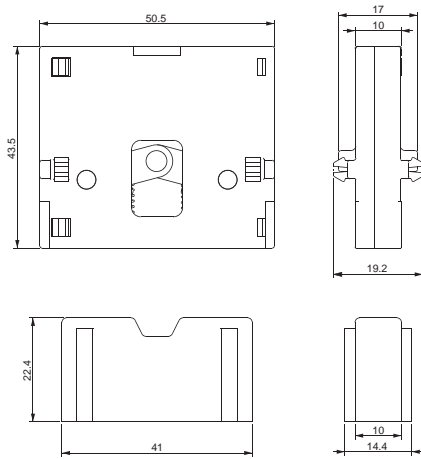

X-ON Electronics

Largest Supplier of Electrical and Electronic Components

Click to view similar products for [Industrial & Electrical Fuses](#) category:

Click to view products by [Eaton](#) manufacturer:

Other Similar products are found below :

[MTH-4](#) [MTH-8](#) [BCC-1-8/10](#) [BP/FNM-5](#) [BP/NON-30](#) [KTN-R-10](#) [LPS-RK-2SP](#) [ABU-15](#) [ABU-25](#) [ABU-3](#) [ABU-35](#) [ABU-50](#) [ABU-60](#)
[TCF40RN](#) [BCF-10](#) [3TX4431-0A](#) [BK-SC-20](#) [FNM-6-1-4](#) [FRN-R-6-1-4](#) [FRS-R-3-12](#) [KTK-1-1-2](#) [BBS-610](#) [FNM-6-10](#) [FNQ-R-1-1-4](#) [FRN-](#)
[R-30ID](#) [FRS-R-20ID](#) [CL03AB00M6](#) [CHSF-80](#) [BBS-1/10](#) [LDFJ350.X](#) [BAF-4](#) [KRP-C-1000SP](#) [TIA10](#) [MIC-20](#) [BBS-10](#) [BBS-4/10](#) [BBS-3/4](#)
[BBS-1/2](#) [C10G32](#) [C10M20](#) [JJN-100](#) [JJN-15](#) [JJS-2](#) [KRP-C-700SP](#) [KTK-7](#) [KTK-R-1-1/2](#) [KTK-R-9](#) [3RU1136-1KB0](#) [LP-CC-12](#) [LP-CC-25](#)