

## xStart series contactors



## xStart series overload relays



## Motor protective circuit breaker PKZ



## Motor-starter combinations



## E Line contactors



## E Line thermal overload relay



## xStart series

### 1.1 xStart series contactors

Mini contactor relays, contactor relay	1
Contactors DIL	1

### 1.2 xStart series overload relays

Bimetal relay ZE, ZB, Z5	2
Overload relay ZW7	2
Electronic overload relays ZEB	4
EMT6 thermistor overload relay for machine protection	4
C441 overload and monitoring relay	37

### 1.3 xStart series motor-protective circuit-breakers

Motor-protective circuit-breakers PKZ	3
Motor-protective circuit-breakers PKE	8
DC string circuit-breaker PKZ-SOL	47
DC switch-disconnectors P-SOL, SOL	47

### 1.4 Motor-starter combinations

Motor-starter combinations	1
----------------------------	---

## E Line series

### 2.1 E Line contactors

Control relays XTRG	1
Contactors XTCG	6

### 2.2 E Line thermal overload relay

Thermal overload relays XTOD/XTOG	13
-----------------------------------	----



# Mini contactor relays, contactor relay, contactors

Continual operation requires high operational reliability in the components used. The DILM contactor achieves the best lifespan values in AC-3 applications and is ideal for heavy AC-4 jogging.

## Mini contactor relay DILE..., contactor relays, contactors up to 12 A AC-3 at 400 V

- Compact dimensions for the highest packing densities
- Extended performance range up to 5.5 kW at 400 V

## AC and DC contactor system DILM..., contactor relays, 3 pole contactors up to 170 A AC-3 at 400 V, 4 pole contactors up to 200 A AC-1

- Easier engineering through identical construction sizes for AC- and DC-operated contactors
- Energy savings and higher packing density in control panel due to minimized heat dissipation
- High wiring security through doubled box terminals
- Less coupler relays: direct actuation from the PLC for contactors up to 32 A
- Easy engineering through integrated suppressor circuits for DC
- Uniform accessories for 3- and 4-pole contactors
- Mechanical interlock double conductor run mountable without additional separation gap
- Direct fieldbus connection through the communication system SmartWire-DT®, through plug-in type protective module

## High rated contactors - contactors up to 1600 A AC-3 at 400 V, contactors up to 2600 A AC-1

- Compact dimensions with high switching power
- Direct actuation from the PLC saves coupler relays
- Easy engineering through wide range coils
- Cost and energy savings for control panel ventilation due to reduced heat dissipation
- Long lifespan through vacuum technology from 580 A



### Eaton after sales service



Testing switching devices in compliance with regulations applicable to this technology  
→ See catalog



### SmartWire-DT®

The DIL product range offers contact elements which can be connected to the SmartWire-DT® communication system. → Protective modules, Page 62

	<b>Ordering</b>	
	Mini contactor relays DILER, DILEEM, DILEM	
	Mini contactor relays, contactors	2
	Auxiliary contact modules	6
	Accessories	8
	Actuating voltages	66
	DILA contactor relays	
	Contactor relays	10
	Auxiliary contact modules	12
	Actuating voltages	68
	<b>Technical overview</b>	
	Contactors DILM, DILH	14
	<b>System overview</b>	
	Contactors DILM, DILH	16
	<b>Ordering</b>	
	Contactors DILM, DILH	
	Basic devices up to 170 A	18
	Complete units up to 170 A	24
	Standard devices greater than 170 A	28
	Comfort devices greater than 170 A	30
	Basic devices up to 200 A, 4 pole	34
	Auxiliary contact modules	36
	<b>Engineering</b>	
	Auxiliary contact modules	40
	<b>Ordering</b>	
	DILK contactors for capacitors	41
	<b>Engineering</b>	
	Contactors for power factor correction	42
	<b>Ordering</b>	
	Star-delta combinations SDAINL	44
	<b>Engineering</b>	
	Star-delta combinations SDAINL	46
	<b>Ordering</b>	
	DIUL reversing combinations	48
	<b>Description</b>	
	CMD contactor monitoring device	64
	<b>Ordering</b>	
	CMD contactor monitoring device	64

	<b>Ordering</b>	
	DILM contactor relays, DILM, DILH contactors	
	suppressor circuit	50
	Accessories	52
	<b>Ordering</b>	
	Actuating voltages contactors DILM, DILH	
	Basic devices up to 170 A	69
	Basic devices up to 200 A, 4 pole	74
	Contactors up to 150 A	
	with electronic actuation	76
	Replacement coils	71
	Comfort devices greater than 170 A	77
	Standard devices greater than 170 A	77
	Electronic modules including coil	77
	Contactors for capacitors	77
	<b>Engineering</b>	
	Contact travel diagrams	78
	Enclosure	79
	UL/CSA-approved rating data	80
	UL/CSA special purpose ratings	81
	UL/CSA short circuit current rating	82
	Contactors for resistive loads	84
	Electrical life span	86
	Short-time loading	90
	Operating frequency	91
	Switching of DC current	92
	<b>Technical data</b>	
	Mini contactor relays, contactor relays	93
	Contactor monitoring device	96
	Basic devices up to 170 A	104
	Basic devices up to 200 A, 4 pole	120
	Comfort devices greater than 170 A	112
	Standard devices greater than 170 A	112
	Contactors for capacitors	123
	Contactors up to 150 A	
	with electronic actuation	126
	Lighting contactors	125
	Auxiliary contact modules	128
	Accessories	128
	<b>Dimensions</b>	
	Mini contactor relays	130
	Contactor relays	131
	Basic devices up to 170 A	131
	Basic devices up to 200 A, 4 pole	133
	Contactors larger than 170 A	134
	Contactors for capacitors	136
	Lighting contactors	136
	Contactor combinations	137
	Accessories	138

# 1.1

## Contactors

Mini contactors, relays

### 1 Ordering

#### Screw terminals



#### DILER mini contactor relays

Rated operational current AC-15		Conventional free air thermal current	Contact		Distinctive number	Circuit symbol	For use with
220 V	380 V		N/O = normally open contact	NC = normally closed contact			
230 V	400 V						
240 V	415 V						
$I_e$	$I_e$	$I_{th}$					
A	A		A				
6	3	10	4 N/O	–	40E		DILE...
			3 N/O	1 NC	31E		DILE...
			2 N/O	2 NC	22E		DILE...

#### Notes

Coil terminal marking as specified in EN 50005

Contact numbers to EN 50011

The following applies to DC-operated contactors:

- Integrated diode-resistor combination
- Coil rating 2.6 W

#### Information relevant for export to North America



Product Standards

IEC/EN 60947-4-1; UL508; CSA-C22.2 No.14-05;

CE marking

E29184

NKCR

012528

3211-03

UL Listed,

CSA certified

UL File No.

UL CCN

CSA File No.

CSA Class No.

NA Certification



AC operation		DC operation		Std. pack	Notes
Part no.	Price	Part no.	Price		
Article no.	See price list	Article no.	See price list		

<b>DILER-40(230V50Hz)</b> 051759	<b>DILER-40-G(24VDC)</b> 010223	5 off	
<b>DILER-31(230V50Hz)</b> 051768	<b>DILER-31-G(24VDC)</b> 010157		
<b>DILER-22(230V50Hz)</b> 051777	<b>DILER-22-G(24VDC)</b> 010042		

With screw terminals:

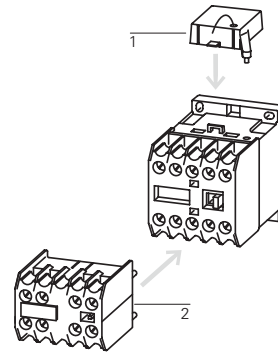

**Accessories**

- 1 Suppressor
- 2 Auxiliary contact modules
- Further actuating voltages

**Page**

- 8
- 6
- 66

# 1.1

## Contactors

Mini contactors, relays

1

### DILEM contactors

Rated operational current	Max. motor rating for three-phase motors, 50 - 60 Hz						Conventional thermal current $I_{th} = I_e$ AC-1 at 50 °C		Contact	Circuit symbol	For use with
	AC-3			AC-4			Open	Enclosed			
380 V 400 V $I_e$	220 V 230 V P	<b>380 V</b> <b>400 V</b> P	660 V 690 V P	220 V 230 V P	<b>380 V</b> <b>400 V</b> P	660 V 690 V P	$I_{th} = I_e$	$I_{th} = I_e$	N/O = normally open contact NC = normally closed contact		
<b>A</b>	kW	<b>kW</b>	kW	kW	<b>kW</b>	kW	A	A			
<b>6.6</b>	1.5	<b>3</b>	3	1.1	<b>2.2</b>	2.2	20	16	1 N/O –	...DILEM DILE...	
<b>6.6</b>	1.5	<b>3</b>	3	1.1	<b>2.2</b>	2.2	20	16	– 1 NC	DILE...	
<b>9</b>	2.2	<b>4</b>	4	1.5	<b>3</b>	3	20	16	1 N/O –	...DILEM DILE...	
<b>9</b>	2.2	<b>4</b>	4	1.5	<b>3</b>	3	20	16	– 1 NC	DILE...	
<b>12</b>	3.5	<b>5.5</b>	6.5	2	<b>3</b>	2.2	20	16	1 N/O –	...DILEM DILE...	
<b>12</b>	3.5	<b>5.5</b>	6.5	2	<b>3</b>	2.2	20	16	– 1 NC	DILE...	
<b>9</b>	2.2	<b>4</b>	4	1.5	<b>3</b>	3	20	16	– –	...DILEM DILE...	

3 pole with auxiliary contact  
Screw terminals

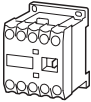

4 pole  
Screw terminals

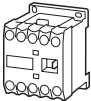

1)

#### Information relevant for export to North America



Product Standards IEC/EN 60947-4-1;  
UL 508; CSA-C22.2  
No.14-05; CE marking  
UL File No. E29096  
UL CC NLDX  
CSA File No. 012528  
CSA Class No. 3211-04  
NA Certification UL Listed, CSA certified  
See also → Page 80

2)

#### Information relevant for export to North America



Product Standards IEC/EN 60947-4-1;  
UL 508; CSA-C22.2 No.14-05; CE marking  
UL File No. E29096  
UL CCN NLDX  
CSA File No. 012528  
CSA Class No. 2411-03,3211-04  
NA Certification UL Listed, request filed for CSA

AC operation		DC operation		Std. pack	Notes
Part no. Article no.	Price See price list	Part no. Article no.	Price See price list		

<b>DILEEM-10(230V50Hz)</b> <sup>1)</sup> 051608	<b>DILEEM-10-G(24VDC)</b> <sup>1)</sup> 051643	5 off	
<b>DILEEM-01(230V50Hz)</b> <sup>1)</sup> 051633	<b>DILEEM-01-G(24VDC)</b> <sup>1)</sup> 051650		
<b>DILEM-10(230V50Hz)</b> <sup>1)</sup> 051786	<b>DILEM-10-G(24VDC)</b> <sup>1)</sup> 010213		
<b>DILEM-01(230V50Hz)</b> <sup>1)</sup> 051795	<b>DILEM-01-G(24VDC)</b> <sup>1)</sup> 010343		
<b>DILEM12-10(230V50Hz)</b> <sup>2)</sup> 127075	<b>DILEM12-10-G(24VDC)</b> <sup>2)</sup> 127132		
<b>DILEM12-01(230V50Hz)</b> <sup>2)</sup> 127091	<b>DILEM12-01-G(24VDC)</b> <sup>2)</sup> 127137		
<b>DILEM4(230V50Hz)</b> <sup>1)</sup> 051804	<b>DILEM4-G(24VDC)</b> <sup>1)</sup> 012701	5 off	

**With screw terminals:**

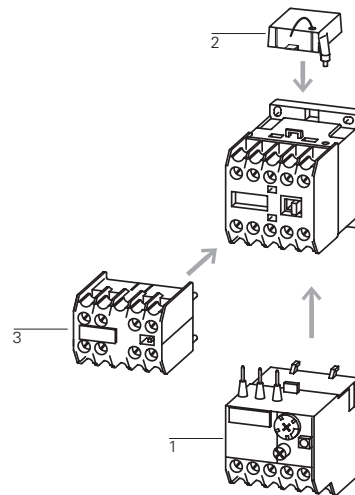

**Accessories**

- 1 Overload relay
- 2 Suppressor
- 3 Auxiliary contact module
- Enclosures totally insulated
- Further actuating voltages
- Accessories

**Page**

- Chapter 1.2
- 8
- 6
- 66
- 8

# 1.1

## Mini contactor relays

### Auxiliary contact modules

1

Screw terminals













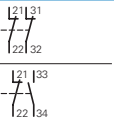







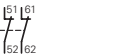

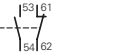





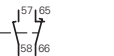

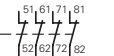

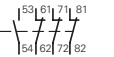

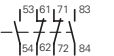
### DILE Auxiliary contact modules

	Contact				Rated operational current		Conventional thermal current $I_{th}$ A	Distinctive number/type of combinations with basic device		
	N/O = normally open contact	S <sub>F</sub> = NO early-make	NC = normally closed contact	Ö <sub>S</sub> = NC late-break	AC-15 220 V 230 V 240 V	380 V 400 V 415 V		DILER-40(-G)	DILER-31(-G)	DILER-22
2 pole	–	–	2 NC	–	4	2	10	–	–	–
	1 N/O	–	1 NC	–	4	2	10	–	–	–
4 pole	2 N/O	–	2 NC	–	4	2	10	–	–	–
2 pole	–	–	2 NC	–	4	2	10	42E	33	24
	1 N/O	–	1 NC	–	4	2	10	51E	42	33
	2 N/O	–	–	–	4	2	10	60E	51	42
	–	1 S <sub>F</sub>	–	1 Ö <sub>S</sub>	4	2	10	51	42	33
4 pole	–	–	4 NC	–	4	2	10	44E	35	26
	1 N/O	–	3 NC	–	4	2	10	53E	44	35
	2 N/O	–	2 NC	–	4	2	10	62E	53	44
	3 N/O	–	1 NC	–	4	2	10	71E	62	53
	4 N/O	–	–	–	4	2	10	80E	71	62
	1 N/O	1 S <sub>F</sub>	1 NC	1 Ö <sub>S</sub>	4	2	10	62	53	44

#### Information relevant for export to North America

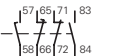

Product Standards	IEC/EN 60947-4-1; UL 508; CSA-C22.2 No.14-05; CE marking
UL File No.	E29184
UL CCN	NKCR
CSA File No.	012528
CSA Class No.	3211-03
NA Certification	UL Listed, CSA certified

Circuit symbol	Can be combined with contactor	Part no. Article no.	Price See price list	Std. pack	Notes	
		<b>02DILEM</b> 010064	5 off	 	With interlocked opposing contacts	<p>The following applies to ...DILEM auxiliary contacts:</p> <ul style="list-style-type: none"> <li>• Contacts to EN 50012</li> </ul> <p>The following applies to ...DILE auxiliary contacts:</p> <ul style="list-style-type: none"> <li>• Contacts to EN 50005</li> </ul> <p>Contacts according to EN50012 are to be preferred. Type E combinations comply with EN 50011 and are to be given preference.</p> <p>No interlocked opposing contacts in NO early-makes and NC late-breaks.</p>
		<b>11DILEM</b> 010080	5 off	 	With interlocked opposing contacts	
		<b>22DILEM</b> 010112	5 off	 	With interlocked opposing contacts	
		<b>02DILE</b> 010240	5 off	 	With interlocked opposing contacts	
		<b>11DILE</b> 010224	5 off	 	With interlocked opposing contacts	
		<b>20DILE</b> 010208	5 off	 	With interlocked opposing contacts	
		<b>11DDILE</b> 049824	5 off	 	–	
		<b>04DILE</b> 010256	5 off	 	With interlocked opposing contacts	
		<b>13DILE</b> 002397	5 off	 	With interlocked opposing contacts	
		<b>22DILE</b> 010288	5 off	 	With interlocked opposing contacts	
		<b>31DILE</b> 048912	5 off	 	With interlocked opposing contacts	
		<b>40DILE</b> 010304	5 off	 	With interlocked opposing contacts	
		<b>22DDILE</b> 049823	5 off	 	–	

# 1.1

## Mini contactor relays Accessories

### 1 VGDILE..., RCDILE..., MVDILE, BT480, P1DILEM

Actuating voltage $U_s$ V AC	Circuit symbol	For use with	Part no. Article no.	Price See price list	Std. pack	Information relevant for export to North America 
------------------------------------	----------------	--------------	-------------------------	-------------------------	-----------	--

#### Suppressor circuits

Varistor suppressor

	24 - 48 AC		DILE...	<b>VGDILE48</b> 010320	10 off 	Product Standards IEC/EN 60947-4-1; UL 508; CSA-C22.2 No.14-05; CE marking E29096 UL File No. UL CCN CSA File No. CSA Class No. NA Certification NLDX 012528 3211-03 UL Listed, CSA certified
	110 - 250 AC		<b>VGDILE250</b> 010336	10 off 		
	380 - 415 AC		<b>VGDILE415</b> 010463	10 off 		

RC-Suppressor

	24 - 48 AC		DILE...	<b>RCDILE48</b> 044264	10 off 	Product Standards IEC/EN 60947-4-1; UL 508; CSA-C22.2 No.14-05; CE marking E29184 UL File No. UL CCN CSA File No. NA Certification NKCR2 - UL Recognized
	110 - 250 AC		<b>RCDILE250</b> 046320	10 off 		

**Notes**  
For AC operated contactors 50 - 60 Hz.  
DC operated contactor relays have an integrated suppressor.  
Note drop-out delay.

### VGDILE..., RCDILE..., MVDILE, BT480, P1DILEM

For use with	Part no. Article no.	Price See price list	Std. pack	Information relevant for export to North America 
--------------	-------------------------	-------------------------	-----------	--

#### Mechanical interlocks

For mechanical connection of contactor and timing relays in combinations.  
0 mm distance between contactors.

	DILE... DILET...	<b>VODILE</b> 026634	50 off 	UL/CSA certification not required
--	---------------------	-------------------------	------------	-----------------------------------

#### Mechanical interlock

For contactors with the same or different magnet system.  
0 mm distance between contactors.  
Mechanical lifespan  $2.5 \times 10^6$  operations.  
Additional auxiliary contact modules possible.

	DILE...	<b>MVDILE</b> 010113	5 off 	Product Standards IEC/EN 60947-4-1; UL 508; CSA-C22.2 No.14-05; CE marking E29184 UL File No. UL CCN CSA File No. CSA Class No. NA Certification NKCR2 012528 3211-07 UL Recognized, CSA certified
--	---------	-------------------------	-----------	---

#### Paralleling link

For parallel connection of contacts

	DILE... DILE...	<b>BT480</b> <sup>1)</sup> 052785	100 off	Product Standards IEC/EN 60947-4-1; UL 508; CSA-C22.2 No.14-05; CE marking E29096 UL File No. UL CCN CSA File No. CSA Class No. NA Certification NLDX 012528 3211-07 UL Listed, CSA certified
Consisting of two four-pole paralleling links. 	DILEEM DILEM12 DILEM	<b>P1DILEM</b> <sup>2)</sup> 019095	5 off 	

**Notes**  
1) Not protected against accidental contact as specified in VDE 0106 Part 100.  
2) 4th pole can be broken off  
4 pole:  $I_{th} = 60$  A open  
3 pole:  $I_{th} = 50$  A open  
AC-1 current carrying capacity of the open contactor increases by a factor of 2.5  
Protected against accidental contact in accordance with VDE 0106 Part 100

## HDILE, ...DILEM, MVS

Contact sequence	For use with	Part no. Article no.	Price See price list	Std. pack	Information relevant for export to North America
------------------	--------------	-------------------------	-------------------------	-----------	--



### Sealable shrouds

Transparent  
Snap-fitting on contactor.  
Can be used with open installation or on service distribution board.  
Protection type: IP40 front  
Can be drilled to accommodate timing relay setting dials.

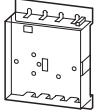

DILE... DILET...	<b>HDILE</b> 010482	1 off 	UL/CSA certification not required
---------------------	------------------------	-----------	-----------------------------------

### Start-point bridge



DILEEM DILEM12 DILEM	<b>SDILEM<sup>1)</sup></b> 220218	20 off
----------------------------	--------------------------------------	--------

### Reversing starter wiring kit

Main current wiring for reversing combinations

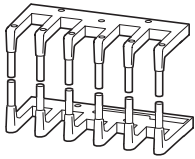

DILEEM (+MVDILEM) DILEM12 (+MVDILEM) DILEM (+MVDILEM)	<b>MVS-WB-EM<sup>2)</sup></b> 220209	1 off 	<b>Product Standards</b> IEC/EN 60947-4-1; UL 508; CSA-C22.2 No.14-05; CE marking <b>UL File No.</b> E36332 <b>UL CCN</b> NLRV7 <b>CSA File No.</b> 012528 <b>CSA Class No.</b> 3211-06 <b>NA Certification</b> UL Listed, CSA certified
---	---	-----------	---

### Star-delta wiring kit

Main current wiring for star-delta combination incl. star-point bridge

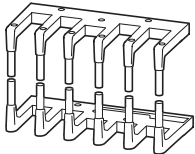

DILE(E)M (+MVDILEM) DILE(E)M12 (+MVDILEM) DILE(E)M star contactor	<b>MVS-SB-EM<sup>3)</sup></b> 220213	1 off 	<b>Product Standards</b> IEC/EN 60947-4-1; UL 508; CSA-C22.2 No.14-05; CE marking <b>UL File No.</b> E36332 <b>UL CCN</b> NLRV7 <b>CSA File No.</b> 012528 <b>CSA Class No.</b> 3211-06 <b>NA Certification</b> UL Listed, CSA certified
---	---	-----------	---

### Notes

- <sup>1)</sup> Protected against accidental contact in accordance with VDE 0106 Part 100
- <sup>2)</sup> The following control cables are integrated in addition to electrical interlock:
  - Q11: A1 - Q12: 21
  - Q11: 21 - Q12: A1
  - Q11: A2 - Q12: A2
 For use with overload relay separate mounting.
- <sup>3)</sup> The following control cables are integrated in addition to electrical interlock:
  - Q13: A1 - Q15: 21
  - Q13: 21 - Q15: A1
  - Q13: A2 - Q15: A2
 For use with overload relay separate mounting.



# 1.1

## Contactor relays

### Basic devices

1

#### DILA Basic devices with positively driven contacts

Contact		Rated operational current		Conventional thermal current	Distinctive number	Can be combined with auxiliary contact	Circuit symbol
N/O = normally open contact	NC = normally closed contact	AC-15		$I_{th}$			
		220 V	380 V	A			
		230 V	400 V				
		240 V	415 V				
		$I_e$	$I_e$				
		A	A				
<b>Screw terminals</b>							
4 N/O	–	4	4	16	40E	DILA-XHI(V)...	
3 N/O	1 NC	4	4	16	31E	DILA-XHI(V)...	
2 N/O	2 NC	4	4	16	22E	DILA-XHI(V)...	
<b>Spring-loaded terminals</b>							
4 N/O	–	4	4	16	40E	DILA-XHIC(V)...	
3 N/O	1 NC	4	4	16	31E	DILA-XHIC(V)...	
2 N/O	2 NC	4	4	16	22E	DILA-XHIC(V)...	

#### Screw terminals

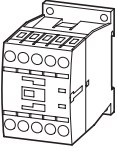

#### Spring-loaded terminals

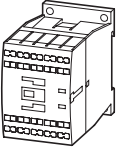

#### Notes

Contact numbers to EN 50011  
Coil terminal markings to EN 50005  
The following applies to DC-operated contactors:

- Integrated suppressor circuit

#### Information relevant for export to North America



Product Standards	IEC/EN 60947-4-1; UL 508; CSA-C22.2 No.14-05; CE marking
UL File No.	E29184
UL CCN	NKCR
CSA File No.	012528
CSA Class No.	3211-03
NA Certification	UL Listed, CSA certified

**AC operation**

**Part no.**  
Article no.

**Price**  
See price list

Std. pack

Circuit symbol

**DC operation**

**Part no.**  
Article no.

**Price**  
See price list

Std. pack

**Notes**

<b>DILA-40(230V50Hz)</b> 276329	1 off 		<b>DILA-40(24VDC)</b> 276344	1 off 
<b>DILA-31(230V50Hz)</b> 276364	1 off 		<b>DILA-31(24VDC)</b> 276379	
<b>DILA-22(230V50Hz)</b> 276399	1 off 		<b>DILA-22(24VDC)</b> 276414	

**With screw terminals:**

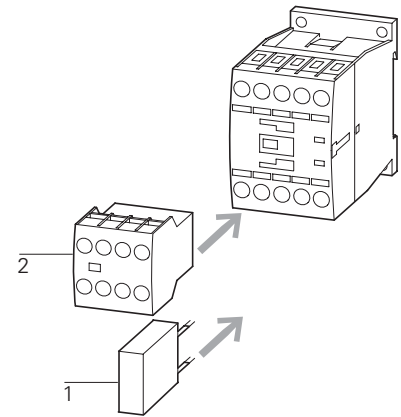

**Accessories**

- 1 Suppressor
- 2 Auxiliary contact modules
- Further actuating voltages

**Page**

- 50
- 36
- 68

<b>DILAC-40(230V50Hz)</b> 276441	1 off 		<b>DILAC-40(24VDC)</b> 276456	1 off 
<b>DILAC-31(230V50Hz)</b> 276473	1 off 		<b>DILAC-31(24VDC)</b> 276488	
<b>DILAC-22(230V50Hz)</b> 276505	1 off 		<b>DILAC-22(24VDC)</b> 276520	

**With spring-loaded terminals:**

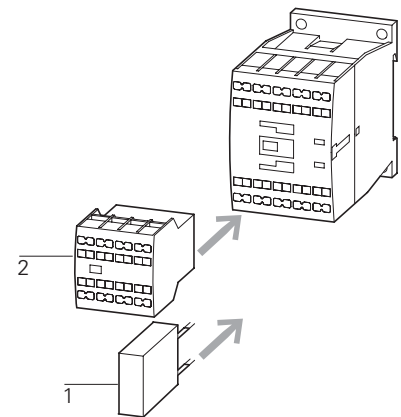

**Accessories**

- 1 Suppressor
- 2 Auxiliary contact modules
- Further actuating voltages

**Page**

- 50
- 36
- 68

### DILA...XHI... DILA auxiliary contact modules

Contact	Rated operational current	Conventional thermal current	Circuit symbol
N/O = normally open contact S <sub>F</sub> = NO early-make NC = normally closed contact Ö <sub>S</sub> = NC late-break	AC-15 220 V      380 V 230 V      400 V 240 V      415 V I <sub>e</sub> I <sub>e</sub> A              A	I <sub>th</sub> A	

#### Screw terminals



2 pole	–	–	2 NC	–	4	4	16	
	1 N/O	–	1 NC	–	4	4	16	
	2 N/O	–	–	–	4	4	16	
	–	1 S <sub>F</sub>	–	1 Ö <sub>S</sub>	4	4	16	

#### Screw terminals



4 pole	–	–	4 NC	–	4	4	16	
	1 N/O	–	3 NC	–	4	4	16	
	2 N/O	–	2 NC	–	4	4	16	
	3 N/O	–	1 NC	–	4	4	16	
	4 N/O	–	–	–	4	4	16	
	1 N/O	1 S <sub>F</sub>	1 NC	1 Ö <sub>S</sub>	4	4	16	

#### Spring-loaded terminals



2 pole	–	–	2 NC	–	4	4	16	
	1 N/O	–	1 NC	–	4	4	16	
	2 N/O	–	–	–	4	4	16	
	–	1 S <sub>F</sub>	–	1 Ö <sub>S</sub>	4	4	16	

#### Spring-loaded terminals











































4 pole	–	–	4 NC	–	4	4	16	
	1 N/O	–	3 NC	–	4	4	16	
	2 N/O	–	2 NC	–	4	4	16	
	3 N/O	–	1 NC	–	4	4	16	
	4 N/O	–	–	–	4	4	16	
	1 N/O	1 S <sub>F</sub>	1 NC	1 Ö <sub>S</sub>	4	4	16	

#### Information relevant for export to North America



Product Standards	IEC/EN 60947-4-1; UL 508; CSA-C22.2 No.14-05; CE marking
UL File No.	E29184
UL CCN	NKCR
CSA File No.	012528
CSA Class No.	3211-03
NA Certification	UL Listed, CSA certified

Distinctive number/type of combinations			Part no. Article no.	Price See price list	Std. pack	Description	Notes	
DILA(C)-40	DILA(C)-31	DILA(C)-22						
42E	33	24	<b>DILA-XHI02</b> 276420		5 off  	With interlocked opposing contacts	Type E combinations comply with EN 50011 and must be given preference. The other combinations comply with EN 50005 The DC operated contactor DILA(C)-22 must only be combined with 2 pole auxiliary contacts.	
51E	42	33	<b>DILA-XHI11</b> 276421		5 off  	With interlocked opposing contacts		
60E	51	42	<b>DILA-XHI20</b> 276422		5 off  	With interlocked opposing contacts		
51	42	33	<b>DILA-XHIV11</b> 276423		5 off  	–		
44E	35	26	<b>DILA-XHI04</b> 276424		5 off  	With interlocked opposing contacts		
53E	44	35	<b>DILA-XHI13</b> 276425		5 off  	With interlocked opposing contacts		
62E	53	44	<b>DILA-XHI22</b> 276426		5 off  	With interlocked opposing contacts		
71E	62	53	<b>DILA-XHI31</b> 276427		5 off  	With interlocked opposing contacts		
80E	71	62	<b>DILA-XHI40</b> 276428		5 off  	With interlocked opposing contacts		
62	53	44	<b>DILA-XHIV22</b> 276429		5 off  	–		
42E	33	24	<b>DILA-XHIC02</b> 276526		5 off  	With interlocked opposing contacts		Type E combinations comply with EN 50011 and must be given preference. The other combinations comply with EN 50005 The DC operated contactor DILA(C)-22 must only be combined with 2 pole auxiliary contacts.
51E	42	33	<b>DILA-XHIC11</b> 276527		5 off  	With interlocked opposing contacts		
60E	51	42	<b>DILA-XHIC20</b> 276528		5 off  	With interlocked opposing contacts		
51	42	33	<b>DILA-XHICV11</b> 276529		5 off  	–		
44E	35	26	<b>DILA-XHIC04</b> 276530		5 off  	With interlocked opposing contacts		
53E	44	35	<b>DILA-XHIC13</b> 276531		5 off  	With interlocked opposing contacts		
62E	53	44	<b>DILA-XHIC22</b> 276532		5 off  	With interlocked opposing contacts		
71E	62	53	<b>DILA-XHIC31</b> 276533		5 off  	With interlocked opposing contacts		
80E	71	62	<b>DILA-XHIC40</b> 276534		5 off  	With interlocked opposing contacts		
62	53	44	<b>DILA-XHICV22</b> 276535		5 off  	–		

# 1.1 Contactors

## 1 Technical overview

### DILM, DILE(E)M, DILMP

Contactors  
3 pole

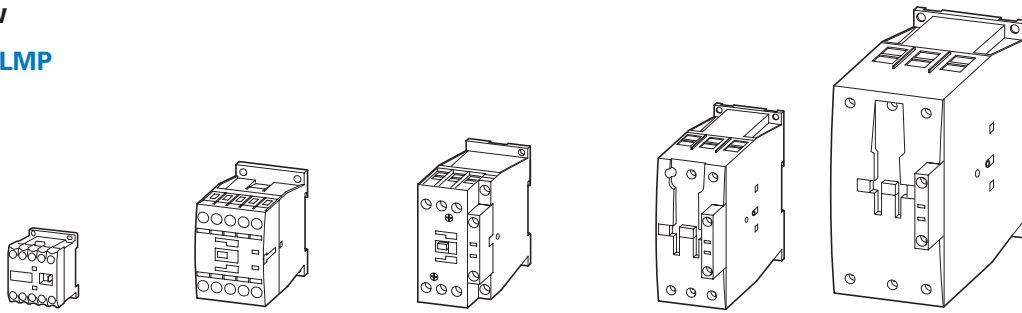

DIL	EEM	EM	EM12	M7	M9	M12	M15	M17	M25	M32	M38	M40	M50	M65	M80	M95	M115	M150	M170
Basic devices	→ 4			→ 18				→ 18				→ 20			→ 46				
Complete units		–		→ Page 24		–		→ Page 24				→ Page 26			→ Page 26				
Rated-operational voltage	kW	kW	kW	kW	kW	kW	kW	kW	kW	kW	kW	kW	kW	kW	kW	kW	kW	kW	kW

AC-3	Rated operational power for 3-phase motors 50–60 Hz																		
220 V – 230 V	1.5	2.2	3	2.2	2.5	3.5	4	5	7.5	10	11	12.5	15.5	20	25	30	37	48	52
<b>380 V – 400 V</b>	<b>3</b>	<b>4</b>	<b>5.5</b>	<b>3</b>	<b>4</b>	<b>5.5</b>	<b>7.5</b>	<b>7.5</b>	<b>11</b>	<b>15</b>	<b>18.5</b>	<b>18.5</b>	<b>22</b>	<b>30</b>	<b>37</b>	<b>45</b>	<b>55</b>	<b>75</b>	<b>90</b>
440 V	3.3	4.6	5.5	4.5	5.5	7.5	8.4	10.5	15.5	20	21	25	32	41	51	60	75	95	105
500 V	3	4	5.5	3.5	4.5	7	7.5	12	17.5	23	24	28	36	47	58	70	85	110	120
660 V/690 V	3	4	4	3.5	4.5	6.5	7	11	14	17	21	23	30	35	63	75	90	96	140
1000 V	–	–	–	–	–	–	–	–	–	–	–	–	–	–	–	–	–	–	–

AC-4	Rated operational power for 3-phase motors 50–60 Hz																		
220 V – 230 V	1.1	1.5	1.5	1	1.5	2	2	2.5	3.5	4	4	5	6	7	12	16	17	20	20
<b>380 V – 400 V</b>	<b>2.2</b>	<b>3</b>	<b>3</b>	<b>2.2</b>	<b>2.5</b>	<b>3</b>	<b>3</b>	<b>4.5</b>	<b>6</b>	<b>7</b>	<b>7</b>	<b>9</b>	<b>10</b>	<b>12</b>	<b>20</b>	<b>26</b>	<b>28</b>	<b>33</b>	<b>33</b>
440 V	2.4	3.3	3.3	2.4	3	3.6	3.6	5.5	7	8	8	10	12	14	25	32	35	41	41
500 V	2.2	3	3	2.5	2.8	3.5	3.5	6	8	9	9	11	13	16	29	36	40	47	47
660 V/690 V	2.2	3	3	2.9	3.6	4.4	4.4	6.5	8.5	10	10	12	14	17	26	35	43	48	48
1000 V	–	–	–	–	–	–	–	–	–	–	–	–	–	–	–	–	–	–	–

AC-1	Rated operational power under resistive load, 40 °C																		
220 V – 230 V	8	8	8	8	8	8	8	15	17	17	17	22	30	37	42	49	61	72	85
<b>380 V – 400 V</b>	<b>13</b>	<b>13</b>	<b>13</b>	<b>14</b>	<b>14</b>	<b>14</b>	<b>14</b>	<b>26</b>	<b>29</b>	<b>29</b>	<b>29</b>	<b>39</b>	<b>53</b>	<b>65</b>	<b>72</b>	<b>85</b>	<b>105</b>	<b>125</b>	<b>150</b>
400 V	15	15	15	16	16	16	16	30	34	34	34	45	58	71	80	94	116	138	170
500 V	18	18	18	19	19	19	19	34	38	38	38	51	66	81	90	107	132	156	194
660 V/690 V	23	23	23	25	25	25	25	45	51	51	51	68	91	111	125	148	182	216	268
1000 V	–	–	–	–	–	–	–	–	–	–	–	–	–	–	–	–	–	–	–
Conventional thermal Current	A	A	A	A	A	A	A	A	A	A	A	A	A	A	A	A	A	A	A
$I_{th} = I_e$ open at 40 °C	22	22	22	22	22	22	22	40	45	45	45	60	80	98	110	130	160	190	225

### DILM, DILE(E)M, DILMP

Contactors  
4 pole

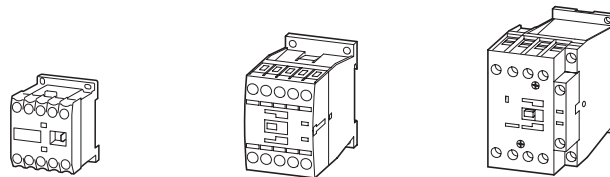

DIL	EM4	MP20	MP32
Rated operational voltage	→ 4	→ Page 34	→ Page 34
AC-1	Conventional free air thermal current $I_{th} = I_e$ open, at 40 °C		
up to 690 V	A	A	A
	22	22	32

**DILM, DILH, DILMP**

**Contactors**  
3 pole

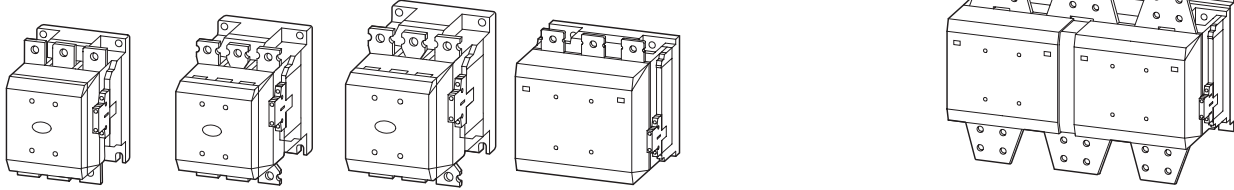

M185A	M225A	M250A	M300A	M400	M500	M580	M650	M750	M820	M1000	M1600	M1400	H2000	H2200	H2600
-	-	-	-	-	-	-	-	-	-	-	-	-	-	-	-
→ Page 30				→ Page 30				→ Page 30		→ Page 30		→ Page 32			
kW	kW	kW	kW	kW	kW	kW	kW	kW	kW	kW	kW	kW	kW	kW	kW

55	70	75	90	125	155	185	205	240	260	315	500	-	-	-	-
<b>90</b>	<b>110</b>	<b>132</b>	<b>160</b>	<b>200</b>	<b>250</b>	<b>315</b>	<b>355</b>	<b>400</b>	<b>450</b>	<b>560</b>	<b>900</b>	-	-	-	-
115	142	157	190	255	345	370	420	480	525	650	1000	-	-	-	-
132	160	180	215	290	360	420	470	550	600	730	1180	-	-	-	-
175	215	240	286	344	344	560	630	720	750	1000	1600	-	-	-	-
108	108	108	132	132	132	600	600	800	800	1000	1770	-	-	-	-

41	51	62	75	92	112	143	161	181	209	260	430	-	-	-	-
<b>75</b>	<b>90</b>	<b>110</b>	<b>132</b>	<b>160</b>	<b>200</b>	<b>250</b>	<b>280</b>	<b>315</b>	<b>355</b>	<b>450</b>	<b>750</b>	-	-	-	-
85	102	125	140	186	229	290	326	367	418	520	830	-	-	-	-
96	116	143	172	214	260	330	370	417	474	590	940	-	-	-	-
127	155	189	229	283	344	440	494	556	633	780	1300	-	-	-	-
108	108	108	132	132	132	509	509	678	678	1000	1650	-	-	-	-

121	139	155	177	221	310	354	376	398	443	443	717	620	886	1075	1269
<b>210</b>	<b>241</b>	<b>268</b>	<b>306</b>	<b>382</b>	<b>535</b>	<b>612</b>	<b>650</b>	<b>689</b>	<b>766</b>	<b>766</b>	<b>1247</b>	<b>1071</b>	<b>1531</b>	<b>1870</b>	<b>2207</b>
243	279	310	354	443	620	709	753	797	886	886	1371	1240	1773	2058	2427
277	317	352	403	503	705	806	856	906	1007	1007	1558	1410	2015	2338	2758
365	419	465	532	664	930	1064	1130	1196	1330	1330	2151	1861	2660	3227	3806
554	635	705	806	1007	1410	1612	1712	1813	2015	2015	2420	2417	3223	4676	5516

A	A	A	A	A	A	A	A	A	A	A	A	A	A	A	A
337	356	400	430	612	857	980	1041	1102	1225	1225	2200	1714	2450	2700	3185

**DILM, DILE(E)M, DILMP**

**Contactors**  
4 pole

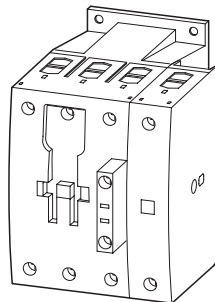
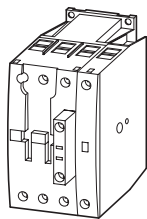

MP45	MP63	MP80	MP125	MP160	MP200
→ Page 34					
A	A	A	A	A	A
45	63	80	125	160	200

# 1.1 Contactors

## 1 System overview

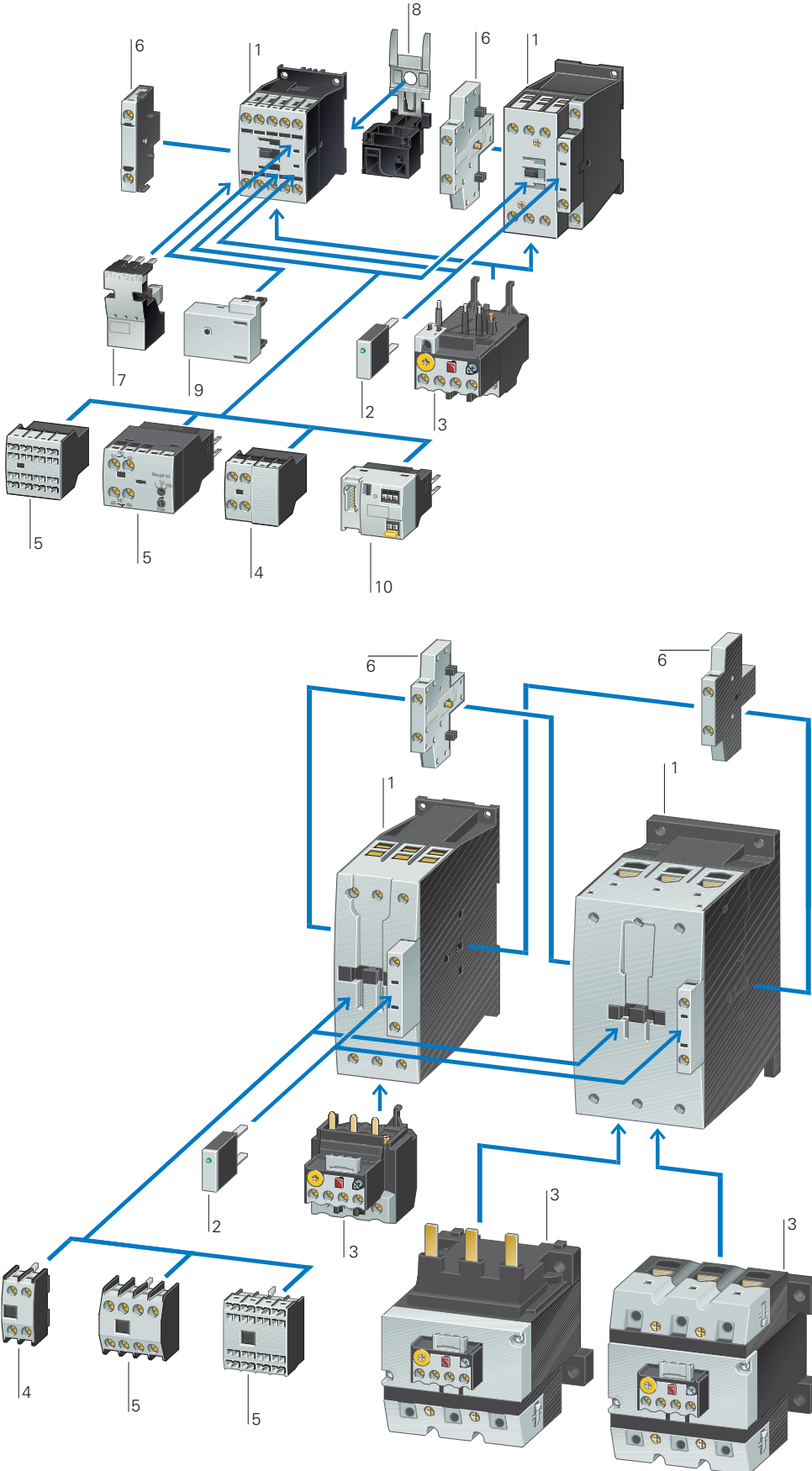

### DILM7...DILM170

#### Contactors up to 90 kW (AC-3/400V) 1

- 3 pole → Page 18
- 4 pole → Page 34

#### Suppressor circuits 2

- Page 50

#### Overload relays 3

- Chapter 1.2 (Page 8)

#### Auxiliary contact modules 4

- Page 36

#### Auxiliary contact modules 5

- Page 36

#### Auxiliary contact modules 6

- Page 39

#### Motor feeder plug 7

- Page 58

#### PE module with contact plate 8

- Page 58

#### Motor suppressor module 9

- Page 59

#### SmartWire-DT® contactor module 10

- Page 58



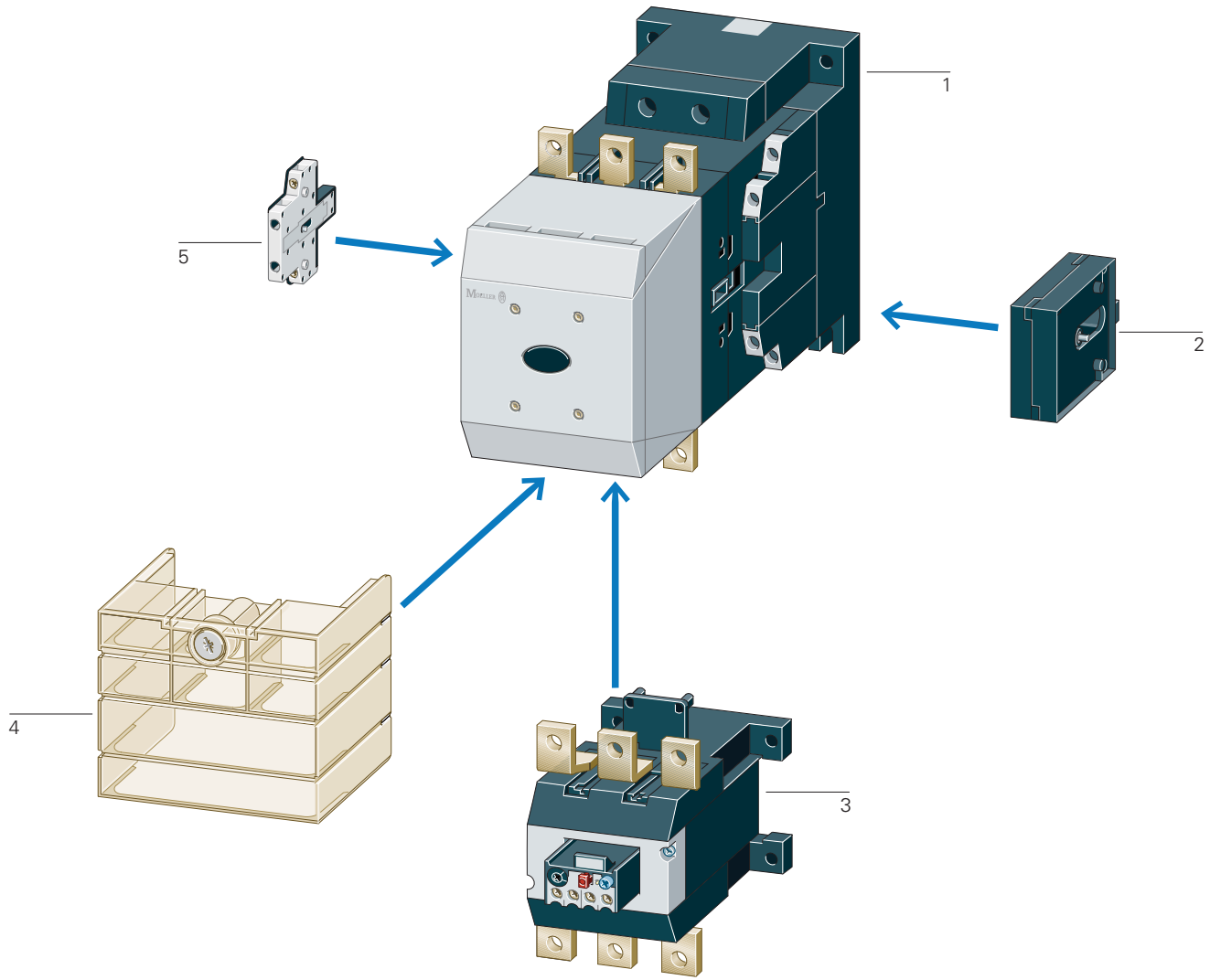

**DILM185... DILH2600**

**Contactors 90 – 900 kW  
(AC-3/400 V)  
Comfort series**

---

→ Page 30

**Standard range 90–250kW**

---

→ Page 28

**Mechanical interlock**

---

→ Page 52

**Overload relays**

---

→ Chapter 1.2 (Page 12)

**Terminal shroud**

---

→ Page 61

**Auxiliary contact modules**

---

→ Page 39

# 1.1

## Contactors

Basic devices up to 170 A

1

### DILM Basic device

Rated operational current

Max. motor rating for three-phase motors 50 - 60 Hz

Conventional thermal current  $I_{th} = I_e$  AC-1 at 60 °C

Contact configuration

Circuit symbol

AC-3	AC-3		AC-4		Open	$I_{th} = I_e$	A	Contact configuration	Circuit symbol	
	380 V 400 V	220 V 230 V	380 V 400 V	660 V 690 V						220 V 230 V
<b>7</b>	2.2	<b>3</b>	3.5	1	<b>2.2</b>	2.9	20	1 N/O	–	
<b>7</b>	2.2	<b>3</b>	3.5	1	<b>2.2</b>	2.9	20	–	1 NC	
<b>9</b>	2.5	<b>4</b>	4.5	1.5	<b>2.5</b>	3.6	20	1 N/O	–	
<b>9</b>	2.5	<b>4</b>	4.5	1.5	<b>2.5</b>	3.6	20	–	1 NC	
<b>12</b>	3.5	<b>5.5</b>	6.5	2	<b>3</b>	4.4	20	1 N/O	–	
<b>12</b>	3.5	<b>5.5</b>	6.5	2	<b>3</b>	4.4	20	–	1 NC	
<b>15.5</b>	4	<b>7.5</b>	7	2	<b>3</b>	4.4	20	1 N/O	–	
<b>15.5</b>	4	<b>7.5</b>	7	2	<b>3</b>	4.4	20	–	1 NC	
<b>18</b>	5	<b>7.5</b>	11	2.5	<b>4.5</b>	6.5	35	1 N/O	–	
<b>18</b>	5	<b>7.5</b>	11	2.5	<b>4.5</b>	6.5	35	–	1 NC	
<b>25</b>	7.5	<b>11</b>	14	3.5	<b>6</b>	8.5	40	1 N/O	–	
<b>25</b>	7.5	<b>11</b>	14	3.5	<b>6</b>	8.5	40	–	1 NC	
<b>32</b>	10	<b>15</b>	17	4	<b>7</b>	10	40	1 N/O	–	
<b>32</b>	10	<b>15</b>	17	4	<b>7</b>	10	40	–	1 NC	
<b>38</b>	11	<b>18.5</b>	21	4	<b>7</b>	10	40	1 N/O	–	
<b>38</b>	11	<b>18.5</b>	21	4	<b>7</b>	10	40	–	1 NC	

Screw terminals  
3 pole

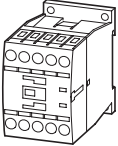

Screw terminals  
3 pole

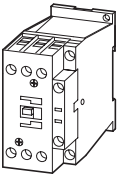

#### Information relevant for export to North America



Product Standards	IEC/EN 60947-4-1; UL 508; CSA-C22.2 No.14-05; CE marking
UL File No.	E29096
UL CCN	NLDX
CSA File No.	012528
CSA Class No.	2411-03, 3211-04
NA Certification	UL Listed, CSA certified
See also	→ Page 80

	<b>AC operation</b>	<b>DC operation</b>			
Can be combined with auxiliary contact	<b>Part no.</b> Article no.	<b>Part no.</b> Article no.	<b>Price</b> See price list	<b>Price</b> See price list	Std. pack

**Notes**

DILM32-XHI.. DILA-XHI(V)..	<b>DILM7-10(230V50Hz)</b> 276550	<b>DILM7-10(24VDC)</b> 276565			
DILA-XHI(V)..	<b>DILM7-01(230V50Hz)</b> 276585	<b>DILM7-01(24VDC)</b> 276600			
DILM32-XHI.. DILA-XHI(V)..	<b>DILM9-10(230V50Hz)</b> 276690	<b>DILM9-10(24VDC)</b> 276705			
DILA-XHI(V)..	<b>DILM9-01(230V50Hz)</b> 276725	<b>DILM9-01(24VDC)</b> 276740			
DILM32-XHI.. DILA-XHI(V)..	<b>DILM12-10(230V50Hz)</b> 276830	<b>DILM12-10(24VDC)</b> 276845			
DILA-XHI(V)..	<b>DILM12-01(230V50Hz)</b> 276865	<b>DILM12-01(24VDC)</b> 276880			
DILM32-XHI.. DILA-XHI(V)..	<b>DILM15-10(230V50Hz)<sup>1)</sup></b> 290058	<b>DILM15-10(24VDC)<sup>1)</sup></b> 290073			
DILA-XHI(V)..	<b>DILM15-01(230V50Hz)<sup>1)</sup></b> 290093	<b>DILM15-01(24VDC)<sup>1)</sup></b> 290108			
DILM32-XHI.. DILA-XHI(V).. DILM32-XHI11-S	<b>DILM17-10(230V50Hz)</b> 277004	<b>DILM17-10(RDC24)</b> 277018			
DILA-XHI(V).. DILM32-XHI11-S	<b>DILM17-01(230V50Hz)</b> 277036	<b>DILM17-01(RDC24)</b> 277050			
DILM32-XHI.. DILA-XHI(V).. DILM32-XHI11-S	<b>DILM25-10(230V50Hz)</b> 277132	<b>DILM25-10(RDC24)</b> 277146			
DILA-XHI(V).. DILM32-XHI11-S	<b>DILM25-01(230V50Hz)</b> 277164	<b>DILM25-01(RDC24)</b> 277178			
DILM32-XHI.. DILA-XHI(V).. DILM32-XHI11-S	<b>DILM32-10(230V50Hz)</b> 277260	<b>DILM32-10(RDC24)</b> 277274			
DILA-XHI(V).. DILM32-XHI11-S	<b>DILM32-01(230V50Hz)</b> 277292	<b>DILM32-01(RDC24)</b> 277306			
DILM32-XHI.. DILA-XHI(V).. DILM32-XHI11-S	<b>DILM38-10(230V50Hz)<sup>1)</sup></b> 112428	<b>DILM38-10(RDC24)<sup>1)</sup></b> 112442			
DILA-XHI(V).. DILM32-XHI11-S	<b>DILM38-01(230V50Hz)<sup>1)</sup></b> 112456	<b>DILM38-01(RDC24)<sup>1)</sup></b> 112470			

1 off 

Contacts to EN 50 012.  
For all DC operated contactors DILM7 - DILM15 the following applies:  

- Integrated varistor-suppressor circuit.

For DC operated contactors DILM17 - DILM170 the following applies:  

- Integrated suppressor circuit in actuating electronics

For AC operated contactors DILM115 - DILM170 the following applies:  

- Integrated suppressor circuit in actuating electronics
- With mirror contact.

<sup>1)</sup> Electrical lifespan → 87

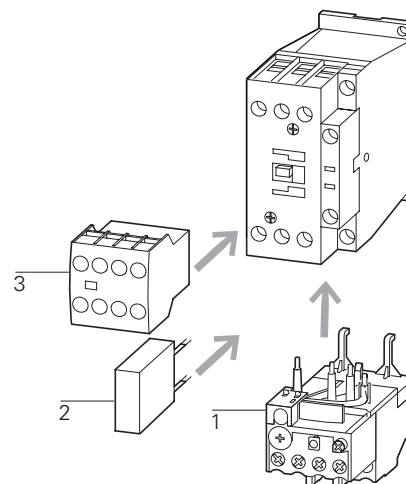

**Accessories**

1 Overload relay  
2 Suppressor  
3 Auxiliary contact module  
Further actuating voltages  
Accessories

**Page**

→ Chapter 1.2  
→ 50  
→ 36  
→ 69  
→ 52

# 1.1

## Contactors

Basic devices up to 170 A

1

### DILM Basic device

Rated operational current

Max. motor rating for three-phase motors 50 - 60 Hz

Conventional thermal current  $I_{th} = I_e$  AC-1 at 60 °C

Contact configuration

Circuit symbol

AC-3	AC-3		AC-4		AC-4		
<b>380 V</b>	220 V	<b>380 V</b>	660 V	220 V	<b>380 V</b>	660 V	Open
<b>400 V</b>	230 V	<b>400 V</b>	690 V	230 V	<b>400 V</b>	690 V	

N/O = normally open contact  
NC = normally closed contact

Screw terminals  
3 pole

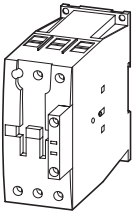

Screw terminals  
3 pole

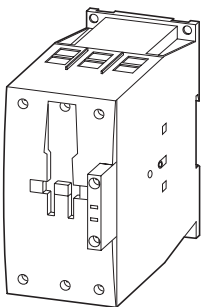

$I_e$ A	P kW	<b>P</b> kW	P kW	P kW	<b>P</b> kW	P kW	$I_{th} = I_e$ A			
<b>40</b>	12.5	<b>18.5</b>	23	5	<b>9</b>	12	50	—	—	
<b>50</b>	15.5	<b>22</b>	30	6	<b>10</b>	14	65	—	—	
<b>65</b>	20	<b>30</b>	35	7	<b>12</b>	17	80	—	—	
<b>72</b>	25	<b>37</b>	35	7	<b>12</b>	17	80	—	—	
<b>80</b>	25	<b>37</b>	63	12	<b>20</b>	26	90	—	—	
<b>95</b>	30	<b>45</b>	75	16	<b>26</b>	35	110	—	—	
<b>115</b>	37	<b>55</b>	90	17	<b>28</b>	43	130	—	—	
<b>150</b>	48	<b>75</b>	96	20	<b>33</b>	48	160	—	—	
<b>170</b>	52	<b>90</b>	140	20	<b>33</b>	48	185	—	—	

#### Information relevant for export to North America



Product Standards	IEC/EN 60947-4-1; UL 508; CSA-C22.2 No.14-05; CE marking
UL File No.	E29096
UL CCN	NLDX
CSA File No.	012528
CSA Class No.	2411-03, 3211-04
NA Certification	UL Listed, CSA certified
See also	→ Page 80

Can be combined with auxiliary contact	AC operation Part no. Article no.	Price See price list	DC operation Part no. Article no.	Price See price list	Std. pack	Notes
--	---	-------------------------	---	-------------------------	-----------	-------

DILM150-XHI(V).. DILM1000-XHI(V)..	<b>DILM40(230V50Hz)</b> 277766		<b>DILM40(RDC24)</b> 277780			
DILM150-XHI(V).. DILM1000-XHI(V)..	<b>DILM50(230V50Hz)</b> 277830		<b>DILM50(RDC24)</b> 277844			
DILM150-XHI(V).. DILM1000-XHI(V)..	<b>DILM65(230V50Hz)</b> 277894		<b>DILM65(RDC24)</b> 277908			
DILM150-XHI(V).. DILM1000-XHI(V)..	<b>DILM72(230V50Hz)<sup>1)</sup></b> 107670		<b>DILM72(RDC24)<sup>1)</sup></b> 107671			
DILM150-XHI(V).. DILM1000-XHI(V)..	<b>DILM80(230V50Hz)</b> 239402		<b>DILM80(RDC24)</b> 239416			
DILM150-XHI(V).. DILM1000-XHI(V)..	<b>DILM95(230V50Hz)</b> 239480		<b>DILM95(RDC24)</b> 239510			
DILM150-XHI(V).. DILM1000-XHI(V)..	<b>DILM115(RAC240)</b> 239548		<b>DILM115(RDC24)</b> 239555			
DILM150-XHI(V).. DILM1000-XHI(V)..	<b>DILM150(RAC240)</b> 239588		<b>DILM150(RDC24)</b> 239591			
DILM150-XHI(V).. DILM1000-XHI(V)..	<b>DILM170(RAC240)<sup>1)</sup></b> 107013		<b>DILM170(RDC24)<sup>1)</sup></b> 107016			

1 off 

Contacts to EN 50012.  
For all DC operated contactors DILM7 - DILM15 the following applies:  
 • Integrated varistor-suppressor circuit.  
 For DC operated contactors DILM17 - DILM170 the following applies:  
 • Integrated suppressor circuit in actuating electronics  
 For AC operated contactors DILM115 - DILM170 the following applies:  
 • Integrated suppressor circuit in actuating electronics  
 For DILM7-01 – DILM38-01 the following applies:  
 • With mirror contact.

<sup>1)</sup> Electrical lifespan → 87

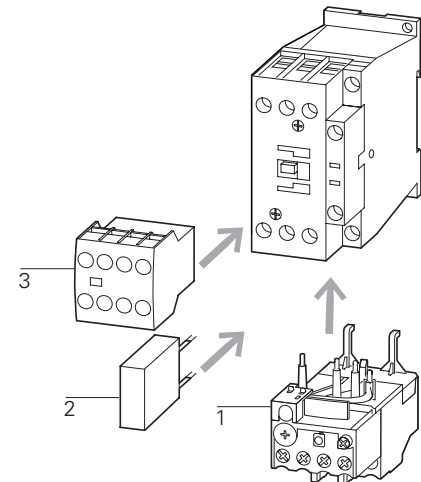

**Accessories**

- 1 Overload relay
- 2 Suppressor
- 3 Auxiliary contact module
- Further actuating voltages
- Accessories

**Page**

- Chapter 1.2
- 50
- 36
- 71
- 52

# 1.1

## Contactors

Basic devices up to 170 A

1

### DILM Basic device

Rated operational current	Max. motor rating for three-phase motors 50 - 60 Hz						Conventional thermal current $I_{th} = I_e$ AC-1 at 60 °C	Contact configuration	Circuit symbol	
	AC-3		AC-3		AC-4					
<b>380 V</b> <b>400 V</b>	220 V	<b>380 V</b>	660 V	220 V	<b>380 V</b>	660 V	Open	N/O = normally open contact NC = normally closed contact		
$I_e$ <b>A</b>	230 V	<b>400 V</b>	690 V	230 V	<b>400 V</b>	690 V				
	P	<b>P</b>	P	P	<b>P</b>	P	$I_{th} = I_e$ A			
	kW	<b>kW</b>	kW	kW	<b>kW</b>	kW				
<b>7</b>	2.2	<b>3</b>	3.5	1	<b>2.2</b>	2.9	20	1 N/O	–	
<b>7</b>	2.2	<b>3</b>	3.5	1	<b>2.2</b>	2.9	20	–	1 NC	
<b>9</b>	2.5	<b>4</b>	4.5	1.5	<b>2.5</b>	3.6	20	1 N/O	–	
<b>9</b>	2.5	<b>4</b>	4.5	1.5	<b>2.5</b>	3.6	20	–	1 NC	
<b>12</b>	3.5	<b>5.5</b>	6.5	2	<b>3</b>	4.4	20	1 N/O	–	
<b>12</b>	3.5	<b>5.5</b>	6.5	2	<b>3</b>	4.4	20	–	1 NC	
<b>15.5</b>	4	<b>7.5</b>	7	2	<b>3</b>	4.4	20	1 N/O	–	
<b>15.5</b>	4	<b>7.5</b>	7	2	<b>3</b>	4.4	20	–	1 NC	
<b>18</b>	5	<b>7.5</b>	11	2.5	<b>4.5</b>	6.5	35	1 N/O	–	
<b>18</b>	5	<b>7.5</b>	11	2.5	<b>4.5</b>	6.5	35	–	1 NC	
<b>25</b>	7.5	<b>11</b>	14	3.5	<b>6</b>	8.5	40	1 N/O	–	
<b>25</b>	7.5	<b>11</b>	14	3.5	<b>6</b>	8.5	40	–	1 NC	
<b>32</b>	10	<b>15</b>			<b>7</b>	10	40	1 N/O	–	
<b>32</b>	10	<b>15</b>			<b>7</b>	10	40	–	1 NC	
<b>40</b>	12.5	<b>18.5</b>			<b>9</b>	12	50	–	–	
<b>50</b>	15.5	<b>22</b>			<b>10</b>	14	65	–	–	
<b>65</b>	20	<b>30</b>			<b>12</b>	17	80	–	–	
<b>80</b>	25	<b>37</b>	63	12	<b>20</b>	26	90	–	–	
<b>95</b>	30	<b>45</b>	75	16	<b>26</b>	35	110	–	–	
<b>115</b>	37	<b>55</b>	90	17	<b>28</b>	43	130	–	–	
<b>150</b>	48	<b>75</b>	96	20	<b>33</b>	48	160	–	–	

#### Spring-loaded terminals 3 pole

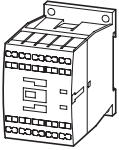

#### Spring-loaded terminals on auxiliary and control circuit terminals 3 pole

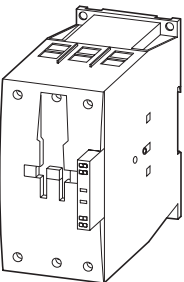
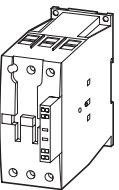
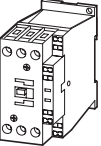

#### Information relevant for export to North America



Product Standards	IEC/EN 60947-4-1; UL 508; CSA-C22.2 No.14-05; CE marking
UL File No.	E29096
UL CCN	NLDX
CSA File No.	012528
CSA Class No.	2411-03, 3211-04
NA Certification	UL Listed, CSA certified
See also	→ Page 80

Can be combined with auxiliary contact

	AC operation	DC operation	Std. pack	Notes
	Part no. Article no.	Part no. Article no.		
	Price See price list	Price See price list		
DILM32-XHIC.. DILA-XHIC(V)..	<b>DILMC7-10(230V50Hz)</b> 277389	<b>DILMC7-10(24VDC)</b> 277404	1 off 	<p>Contacts to EN 50 012.</p> <p>For DILMC7 – DILMC15 the following applies:</p> <ul style="list-style-type: none"> <li>• Auxiliary coil, and main current terminals with spring-loaded terminals.</li> </ul> <p>For DILMC17 – DILMC150 the following applies:</p> <ul style="list-style-type: none"> <li>• Auxiliary connections, coil connections with spring-loaded connection terminals.</li> <li>• Main current connections with screw terminals.</li> </ul> <p>For DC operated contactors DILMC7 - DILMC15 the following applies:</p> <ul style="list-style-type: none"> <li>• Integrated varistor-suppressor circuit.</li> </ul> <p>For DC operated contactors DILMC17 - DILMC150 the following applies:</p> <ul style="list-style-type: none"> <li>• Integrated suppressor circuit in actuating electronics</li> </ul> <p>For AC operated contactors DILMC115 - DILMC150 the following applies:</p> <ul style="list-style-type: none"> <li>• Integrated suppressor circuit in actuating electronics</li> </ul> <p>For DILMC7-01 – DILMC32-01 the following applies:</p> <ul style="list-style-type: none"> <li>• With mirror contact.</li> </ul>
DILA-XHIC(V)..	<b>DILMC7-01(230V50Hz)</b> 277421	<b>DILMC7-01(24VDC)</b> 277436		
DILM32-XHIC.. DILA-XHIC(V)..	<b>DILMC9-10(230V50Hz)</b> 277453	<b>DILMC9-10(24VDC)</b> 277468		
DILA-XHIC(V)..	<b>DILMC9-01(230V50Hz)</b> 277485	<b>DILMC9-01(24VDC)</b> 277500		
DILM32-XHIC.. DILA-XHIC(V)..	<b>DILMC12-10(230V50Hz)</b> 277517	<b>DILMC12-10(24VDC)</b> 277532		
DILA-XHIC(V)..	<b>DILMC12-01(230V50Hz)</b> 277549	<b>DILMC12-01(24VDC)</b> 277564		
DILM32-XHIC... DILA-XHIC(V)...	<b>DILMC15-10(230V50Hz)</b> 293911	<b>DILMC15-10(24VDC)</b> 293926		
DILA-XHIC(V)...	<b>DILMC15-01(230V50Hz)</b> 293946	<b>DILMC15-01(24VDC)</b> 293961		
DILM32-XHIC.. DILA-XHIC(V)..	<b>DILMC17-10(230V50Hz)</b> 277581	<b>DILMC17-10(RDC24)</b> 277595		
DILA-XHIC(V)..	<b>DILMC17-01(230V50Hz)</b> 277611	<b>DILMC17-01(RDC24)</b> 277625		
DILM32-XHIC.. DILA-XHIC(V)..	<b>DILMC25-10(230V50Hz)</b> 277641	<b>DILMC25-10(RDC24)</b> 277655		
DILA-XHIC(V)..	<b>DILMC25-01(230V50Hz)</b> 277671	<b>DILMC25-01(RDC24)</b> 277685		
DILM32-XHIC.. DILA-XHIC(V)..	<b>DILMC32-10(230V50Hz)</b> 277701	<b>DILMC32-10(RDC24)</b> 277715		
DILA-XHIC(V)..	<b>DILMC32-01(230V50Hz)</b> 277731	<b>DILMC32-01(RDC24)</b> 277745		
DILM150-XHIC(V)..	<b>DILMC40(230V50Hz)</b> 277965	<b>DILMC40(RDC24)</b> 277979		
DILM1000-XHIC..	<b>DILMC50(230V50Hz)</b> 277995	<b>DILMC50(RDC24)</b> 278009		
	<b>DILMC65(230V50Hz)</b> 278025	<b>DILMC65(RDC24)</b> 278039		
	<b>DILMC80(230V50Hz)</b> 239618	<b>DILMC80(RDC24)</b> 239652		
	<b>DILMC95(230V50Hz)</b> 239685	<b>DILMC95(RDC24)</b> 239715		
	<b>DILMC115(RAC240)</b> 239736	<b>DILMC115(RDC24)</b> 239741		
	<b>DILMC150(RAC240)</b> 239751	<b>DILMC150(RDC24)</b> 239765		

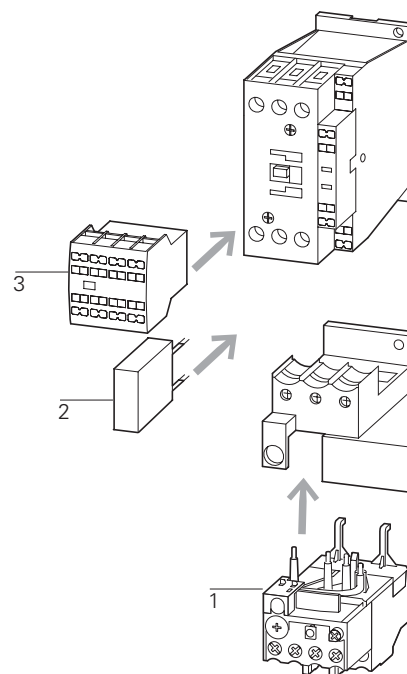

**Accessories**

- 1 Overload relay
- 2 Suppressor
- 3 Auxiliary contact module
- Further actuating voltages
- Accessories

**Page**

- Chapter 1.2
- 50
- 36
- 73
- 52



# 1.1

## Contactors

Complete device up to 170 A

1

### DILM complete device

Rated operational current AC-3	Max. motor rating for three-phase motors 50 - 60 Hz						Conventional free air thermal current $I_{th} = I_e$ AC-1 at 60 °C	Contact configuration: ⊕ = Safety function by positive opening according to IEC/EN 60947-5-1	Circuit symbol	
	AC-3			AC-4						
<b>380 V</b> <b>400 V</b>	220 V 230 V	<b>380 V</b> <b>400 V</b>	660 V 690 V	220 V 230 V	<b>380 V</b> <b>400 V</b>	660 V 690 V	Open $I_{th} = I_e$	N/O = normally open contact NC = normally closed contact		
$I_e$	P	<b>P</b>	P	P	<b>P</b>	P	A			
<b>A</b>	kW	<b>kW</b>	kW	kW	<b>kW</b>	kW				
<b>7</b>	2.2	<b>3</b>	3.5	1	<b>2.2</b>	2.9	20	2 N/O	1 NC	
<b>7</b>	2.2	<b>3</b>	3.5	1	<b>2.2</b>	2.9	20	2 N/O	1 NC	
<b>7</b>	2.2	<b>3</b>	3.5	1	<b>2.2</b>	2.9	20	3 N/O	2 NC	
<b>9</b>	2.5	<b>4</b>	4.5	1.5	<b>2.5</b>	3.6	20	2 N/O	1 NC	
<b>9</b>	2.5	<b>4</b>	4.5	1.5	<b>2.5</b>	3.6	20	2 N/O	1 NC	
<b>9</b>	2.5	<b>4</b>	4.5	1.5	<b>2.5</b>	3.6	20	3 N/O	2 NC	
<b>12</b>	3.5	<b>5.5</b>	6.5	2	<b>3</b>	4.4	20	2 N/O	1 NC	
<b>12</b>	3.5	<b>5.5</b>	6.5	2	<b>3</b>	4.4	20	2 N/O	1 NC	
<b>12</b>	3.5	<b>5.5</b>	6.5	2	<b>3</b>	4.4	20	3 N/O	2 NC	
<b>15.5</b>	4	<b>7.5</b>	7	2	<b>3</b>	4.4	20	2 N/O	2 NC	
<b>18</b>	5	<b>7.5</b>	11	2.5	<b>4.5</b>	6.5	35	2 N/O	1 NC	
<b>18</b>	5	<b>7.5</b>	11	2.5	<b>4.5</b>	6.5	35	2 N/O	1 NC	
<b>18</b>	5	<b>7.5</b>	11	2.5	<b>4.5</b>	6.5	35	3 N/O	2 NC	
<b>25</b>	7.5	<b>11</b>	14	3.5	<b>6</b>	8.5	40	2 N/O	1 NC	
<b>25</b>	7.5	<b>11</b>	14	3.5	<b>6</b>	8.5	40	2 N/O	1 NC	
<b>25</b>	7.5	<b>11</b>	14	3.5	<b>6</b>	8.5	40	3 N/O	2 NC	
<b>32</b>	10	<b>15</b>	17	4	<b>7</b>	10	40	2 N/O	1 NC	
<b>32</b>	10	<b>15</b>	17	4	<b>7</b>	10	40	2 N/O	1 NC	
<b>32</b>	10	<b>15</b>	17	4	<b>7</b>	10	40	3 N/O	2 NC	

#### Screw terminals

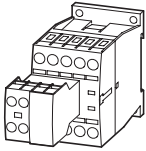

#### Screw terminals

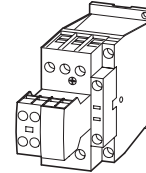

#### Information relevant for export to North America

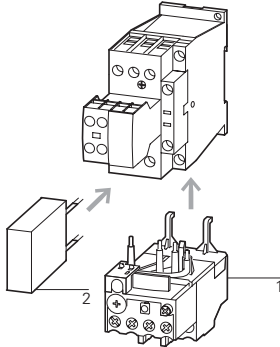

Product Standards	IEC/EN 60947-4-1; UL 508; CSA-C22.2 No.14-05; CE marking
UL File No.	E29096
UL CCN	NLDX
CSA File No.	012528
CSA Class No.	2411-03, 3211-04
NA Certification	UL Listed, CSA certified
See also	→ Page 80

AC operation		DC operation		Std. pack	Notes
Part no. Article no.	Price See price list	Part no. Article no.	Price See price list		
<b>DILM7-21(230V50Hz)</b> 276620		<b>DILM7-21(24VDC)</b> 276635		1 off 	 <p><b>Accessories</b></p> <p>1 Overload relay 2 Suppressor Accessories</p> <p><b>Page</b></p> <p>→ Chapter 1.2 → 50 → 52</p> <p>For all DC operated contactors DILM7 - DILM15 the following applies:</p> <ul style="list-style-type: none"> <li>• Integrated varistor suppressor circuit.</li> </ul> <p>For DC operated contactors DILM17 - DILM170 the following applies:</p> <ul style="list-style-type: none"> <li>• Integrated suppressor circuit in actuating electronics</li> </ul> <p>For AC operated contactors DILM115 - DILM170 the following applies:</p> <ul style="list-style-type: none"> <li>• Integrated suppressor circuit in actuating electronics</li> </ul> <p>For DILM7 - DILM150 the following applies:</p> <ul style="list-style-type: none"> <li>• With mirror contact.</li> </ul> <p>Contacts to EN 50012</p>
<b>DILM7-22(230V50Hz)</b> 106360		<b>DILM7-22(24VDC)</b> 106367			
<b>DILM7-32(230V50Hz)</b> 276655		<b>DILM7-32(24VDC)</b> 276670			
<b>DILM9-21(230V50Hz)</b> 276760		<b>DILM9-21(24VDC)</b> 276775			
<b>DILM9-22(230V50Hz)</b> 106361		<b>DILM9-22(24VDC)</b> 106368			
<b>DILM9-32(230V50Hz)</b> 276795		<b>DILM9-32(24VDC)</b> 276810			
<b>DILM12-21(230V50Hz)</b> 276900		<b>DILM12-21(24VDC)</b> 276915			
<b>DILM12-22(230V50Hz)</b> 106362		<b>DILM12-22(24VDC)</b> 106369			
<b>DILM12-32(230V50Hz)</b> 276935		<b>DILM12-32(24VDC)</b> 276950			
<b>DILM15-22(230V50Hz)</b> 106363		<b>DILM15-22(24VDC)</b> 106370			
<b>DILM17-21(230V50Hz)</b> 277068		<b>DILM17-21(RDC24)</b> 277082			
<b>DILM17-22(230V50Hz)</b> 106364		<b>DILM17-22(RDC24)</b> 106371			
<b>DILM17-32(230V50Hz)</b> 277100		<b>DILM17-32(RDC24)</b> 277114			
<b>DILM25-21(230V50Hz)</b> 277196		<b>DILM25-21(RDC24)</b> 277210			
<b>DILM25-22(230V50Hz)</b> 106365		<b>DILM25-22(RDC24)</b> 106372			
<b>DILM25-32(230V50Hz)</b> 277228		<b>DILM25-32(RDC24)</b> 277242			
<b>DILM32-21(230V50Hz)</b> 277324		<b>DILM32-21(RDC24)</b> 277338			
<b>DILM32-22(230V50Hz)</b> 106366		<b>DILM32-22(RDC24)</b> 106373			
<b>DILM32-32(230V50Hz)</b> 277356		<b>DILM32-32(RDC24)</b> 277370			

# 1.1

## Contactors

Complete device up to 170 A

1

### DILM complete device

Rated operational current AC-3	Max. motor rating for three-phase motors 50 - 60 Hz						Conventional free air thermal current $I_{th} = I_e$ AC-1 at 60 °C	Contact configuration: ☉ = Safety function by positive opening according to IEC/EN 60947-5-1	Circuit symbol	
	AC-3		AC-4							
<b>380 V</b> <b>400 V</b>	220 V 230 V	<b>380 V</b> <b>400 V</b>	660 V 690 V	220 V 230 V	<b>380 V</b> <b>400 V</b>	660 V 690 V	Open $I_{th} = I_e$	N/O = normally open contact NC = normally closed contact		
<b><math>I_e</math></b>	P	<b>P</b>	P	P	<b>P</b>	P	A			
<b>A</b>	kW	<b>kW</b>	kW	kW	<b>kW</b>	kW	A			
<b>40</b>	12.5	<b>18.5</b>	23	5	<b>9</b>	12	50	2 N/O	2 NC	
<b>50</b>	15.5	<b>22</b>	30	6	<b>10</b>	14	65	2 N/O	2 NC	
<b>65</b>	20	<b>30</b>	35	7	<b>12</b>	17	80	2 N/O	2 NC	
<b>80</b>	25	<b>37</b>	63	12	<b>20</b>	26	90	2 N/O	2 NC	
<b>95</b>	30	<b>45</b>	75	16	<b>26</b>	35	110	2 N/O	2 NC	
<b>115</b>	37	<b>55</b>	90	17	<b>28</b>	43	130	2 N/O	2 NC	
<b>150</b>	48	<b>75</b>	96	20	<b>34</b>	48	160	2 N/O	2 NC	

Screw terminals

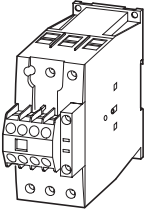

Screw terminals

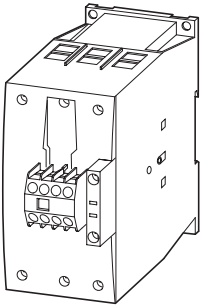

#### Information relevant for export to North America

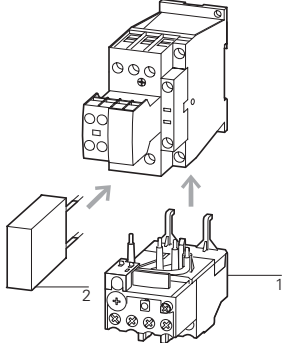

Product Standards	IEC/EN 60947-4-1; UL 508; CSA-C22.2 No.14-05; CE marking
UL File No.	E29096
UL CCN	NLDX
CSA File No.	012528
CSA Class No.	2411-03, 3211-04
NA Certification	UL Listed, CSA certified
See also	→ Page 80

AC operation		DC operation		Std. pack	Notes
Part no. Article no.	Price See price list	Part no. Article no.	Price See price list		
<b>DILM40-22(230V50Hz)</b> 277798		<b>DILM40-22(RDC24)</b> 277812		1 off 	
<b>DILM50-22(230V50Hz)</b> 277862		<b>DILM50-22(RDC24)</b> 277876			
<b>DILM65-22(230V50Hz)</b> 277926		<b>DILM65-22(RDC24)</b> 277940			
<b>DILM80-22(230V50Hz)</b> 239449		<b>DILM80-22(RDC24)</b> 239463			
<b>DILM95-22(230V50Hz)</b> 239527		<b>DILM95-22(RDC24)</b> 239541			
<b>DILM115-22(RAC240)</b> 239578		<b>DILM115-22(RDC24)</b> 239581			
<b>DILM150-22(RAC240)</b> 239598		<b>DILM150-22(RDC24)</b> 239601			

Accessories	Page
1 Overload relay	→ Chapter 1.2
2 Suppressor	→ 50
Accessories	→ 52

For DC operated contactors DILM17 - DILM170 the following applies:

- Integrated suppressor circuit in actuating electronics

For AC operated contactors DILM115 - DILM170 the following applies:

- Integrated suppressor circuit in actuating electronics

For DILM7 - DILM150 the following applies:

- With mirror contact.

Contacts to EN 50012

# 1.1

## Contactors DILM, DILH

Standard devices greater than 150 A

1

### DILM...S/22... Standard device for currents greater than 150 A

Rated operational current	Max. motor rating for three-phase motors 50 - 60 Hz						Conventional thermal current $I_{th} = I_e$ AC-1 at 40 °C Open $I_{th} = I_e$	Circuit symbol	For use with
	AC-3		AC-3		AC-4				
<b>380 V</b> <b>400 V</b>	220 V 230 V	<b>380 V</b> <b>400 V</b>	660 V 690 V	220 V 230 V	<b>380 V</b> <b>400 V</b>	660 V 690 V			
<b><math>I_e</math></b> <b>A</b>	P kW	<b>P</b> <b>kW</b>	P kW	P kW	<b>P</b> <b>kW</b>	P kW			
<b>250</b>	75	<b>132</b>	240	62	<b>110</b>	189	400		DILM820-XHI...
<b>300</b>	90	<b>160</b>	195	75	<b>132</b>	160	430		DILM820-XHI...
<b>400</b>	125	<b>200</b>	344	92	<b>160</b>	283	612		DILM820-XHI...
<b>500</b>	155	<b>250</b>	344	112	<b>200</b>	344	857		DILM820-XHI...
<b>580</b>	185	<b>315</b>	344	112	<b>200</b>	344	920		DILM820-XHI...

DILM complete device

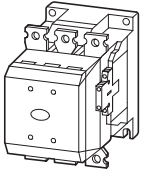

DILM complete device

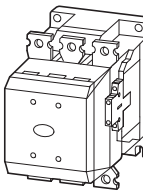

#### Notes

<sup>1)</sup> Availability from August 2010.  
Previous DILM300/22, see Online Catalog at <http://www.eaton.com/seasia-electrical>

For all contactors the following applies:

- 660 V, 690 V or 1000 V: do not reverse directly
- Integrated suppressor circuit in actuating electronics.

DILM...S contactors are actuated conventionally

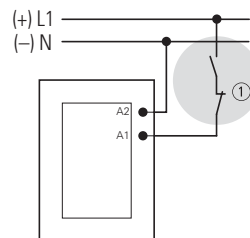





① Stopping in the event of an emergency (emergency switching off)

#### Accessories

Auxiliary contact modules  
Enclosures totally insulated  
Further actuating voltages

#### Page

→ 38  
→ 77

Part no. Article no.	Price See price list	Std. pack	Information relevant for export to North America	
<b>DILM250-S/22(220-240V50/60Hz)</b> 274190	1 off	1 off 	Product Standards UL File No. UL CCN CSA File No. CSA Class No. NA Certification	IEC/EN 60947-4-1; UL 508; CSA-C22.2 No.14-05; CE marking E29096 NLDX 1017510 3211-04 UL Listed, CSA certified
<b>DILM300A-S/22(220-240V50/60Hz)<sup>1)</sup></b> 139559	1 off	1 off 	Request filed for UL and CSA	
<b>DILM400-S/22(220-240V50/60Hz)</b> 274196	1 off	1 off 	Product Standards UL File No. UL CCN CSA File No. CSA Class No. NA Certification See also	IEC/EN 60947-4-1; UL 508; CSA-C22.2 No.14-05; CE marking E29096 NLDX 012528 3211-04 UL Listed, CSA certified
<b>DILM500-S/22(220-240V50/60Hz)</b> 274199	1 off	1 off 	See also	Additional approvals, → Page 82
<b>DILM570-S/22(220-240V50/60Hz)</b> 110744	1 off	1 off 		

# 1.1

## Contactors DILM, DILH

Comfort devices greater than 150 A

1

### DILM, DILH

Rated operational current

Max. motor rating for three-phase motors 50 - 60 Hz

Conventional thermal current  $I_{th} = I_e$   
AC-1 at 60 °C

Circuit symbol

AC-3 380 V 400 V $I_e$ A	AC-3			AC-4			Open $I_{th} = I_e$	A
	220 V 230 V	380 V 400 V	660 V 690 V	1000 V	220 V 230 V	380 V 400 V		
	P	<b>P</b>	P	P	P	<b>P</b>	P	P
	kW	<b>kW</b>	kW	kW	kW	<b>kW</b>	kW	kW

#### Contactors, comfort DILM

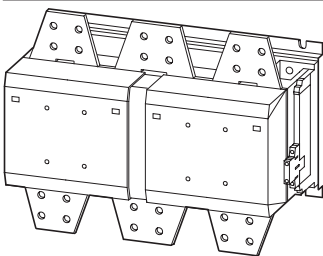
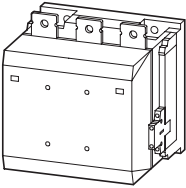
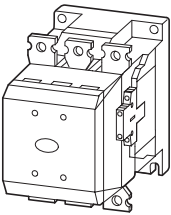
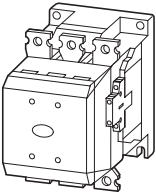
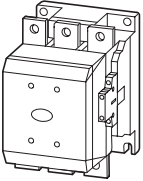

<b>185</b>	55	<b>90</b>	140	108	41	<b>75</b>	102	77	275	
<b>225</b>	70	<b>110</b>	150	108	51	<b>90</b>	110	77	315	
<b>250</b>	75	<b>132</b>	195	108	62	<b>110</b>	160	109	330	
<b>300</b>	90	<b>160</b>	195	132	75	<b>132</b>	160	109	350	
<b>400</b>	125	<b>200</b>	344	132	92	<b>160</b>	283	132	500	
<b>500</b>	155	<b>250</b>	344	132	112	<b>200</b>	344	132	700	
<b>580</b>	185	<b>315</b>	560	600	143	<b>250</b>	440	509	800	
<b>650</b>	205	<b>355</b>	630	600	161	<b>280</b>	494	509	850	
<b>750</b>	240	<b>400</b>	720	800	181	<b>315</b>	556	678	900	
<b>820</b>	260	<b>450</b>	750	800	209	<b>355</b>	633	678	1000	
<b>1000</b>	315	<b>560</b>	1000	1100	260	<b>450</b>	780	1000	1000	
<b>1600</b>	500	<b>900</b>	1600	1770	430	<b>750</b>	1300	1650	1800	

#### Notes

<sup>1)</sup> Availability from August 2010.

Previous DILM185/22 to DILM300/22, see Online Catalog at <http://www.eaton.com/seasia-electrical>

For all contactors the following applies:

- 660 V, 690 V or 1000 V: do not reverse directly
- Integrated suppressor circuit in actuating electronics.

When operating contactors DILM580 to DILM1600 behind a frequency inverter or mains with strong harmonic loads, the suppressor circuit on the load side must be removed.

During high-voltage tests, the suppressor circuit on the load-side for DILM580 to DILH2600 contactors must be disconnected (see instructional leaflet).

Control voltages

RA250  $\hat{=}$  110 V - 250 V AC/DC

RAW250  $\hat{=}$  230 V - 250 V AC/DC

#### Accessories

Auxiliary contact modules

Suppressor circuits on load side

Enclosures

Further actuating voltages

#### Page

→ 38

→ 61

**totally insulated**

→ 72



**Part no.**  
Article no.

**Price**  
See price list

**Std. pack**

**Notes**

**DILM185A/22(RAC240)<sup>1)</sup>**  
139537

1 off

**Conventional**  
A1/A2 are attached to power supply as normal

DILM 185 A, DILM 225 A

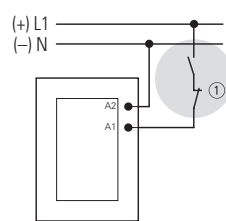

DILM250 to DILM1000, DILH1400

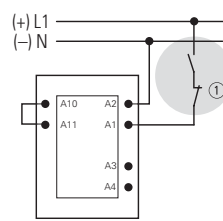

DILM1600 to DILH 2600

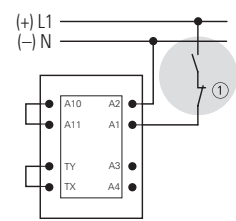

**DILM250/22(RA250)<sup>2)</sup>**  
208201

**DILM300A/22(RA250)<sup>1) 2)</sup>**  
139556

**Directly from the PLC**

A 24 V output from the PLC can be directly connected to the terminals A4/A24.

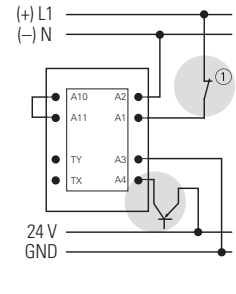
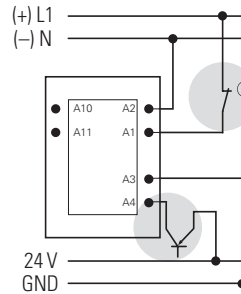
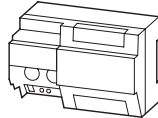

**DILM400/22(RA250)<sup>3)</sup>**  
208209

**DILM500/22(RA250)<sup>3)</sup>**  
208213

**From a low-power command device**

Low-power actuating devices such as PCB relays, pilot devices or position switches can be directly connected to A10/A11.

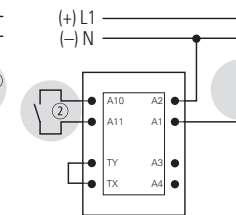
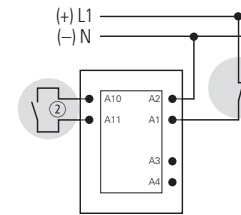

- ① Stopping in the event of an emergency (emergency switching off)
- ② Max. cable capacitance 6 nF

**Information relevant for export to North America**



- 1)  
NA Certification Request filed for UL and CSA
- 2)  
Product Standards IEC/EN 60947-4-1; UL 508; CSA-C22.2 No.14-05; CE marking  
UL File No. E29096  
UL CCN NLDX  
CSA File No. 1017510  
CSA Class No. 3211-04  
NA Certification UL Listed, CSA certified
- 3)  
Product Standards IEC/EN 60947-4-1; UL 508; CSA-C22.2 No.14-05; CE marking  
UL File No. E29096  
UL CCN NLDX  
CSA File No. 012528  
CSA Class No. 3211-04  
NA Certification UL Listed, CSA certified  
See also Additional approvals, → Page 82

# 1.1

## Contactors DILM, DILH Comfort devices greater than 150 A

1

### DILM, DILH

Conventional thermal current  $I_{th} = I_e$   
AC-1 at 60 °C  
Open  
 $I_{th} = I_e$   
A

Circuit symbol

**Part no.**  
Article no.

**Price**  
See price  
list

Std. pack

DILH comfort devices AC-1

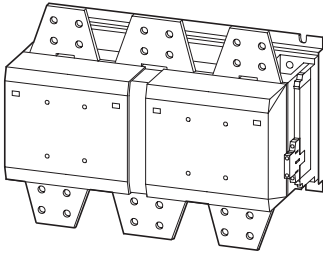

1400		<b>DILH1400/22(RAW250)<sup>1)</sup></b> 272441	1 off 
2000		<b>DILH2000/22(RAW250)<sup>1)</sup></b> 272442	1 off 
2200		<b>DILH2200/22(RAW250)<sup>1)</sup></b> 111793	1 off 
2600		<b>DILH2600/22(RAW250)<sup>2)</sup></b> 125945	1 off 

#### Notes

For all contactors the following applies:

- 660 V, 690 V or 1000 V: do not reverse directly
- Integrated suppressor circuit in actuating electronics.

When operating contactors DILM580 to DILM1600 behind a frequency inverter or mains with strong harmonic loads, the suppressor circuit on the load side must be removed.

During high-voltage tests, the suppressor circuit on the load-side for DILM580 to DILH2600 contactors must be disconnected (see instructional leaflet).

Control voltages

RAW250  $\pm$  230 V - 250 V AC/DC

#### Accessories

Auxiliary contact modules

Suppressor circuits on load side

Enclosures

**totally insulated**

#### Page

→ 38

→ 61

**Notes**

**Conventional**

A1/A2 are attached to power supply as normal

DILH1400

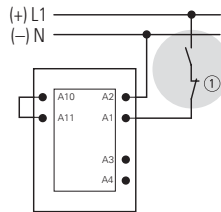

DILM1600 to DILH 2600

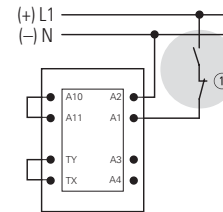

**Directly from the PLC**

A 24 V output from the PLC can be directly connected to the terminals A4/A24.

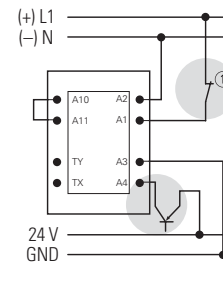
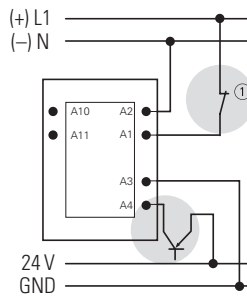

**From a low-power command device**

Low-power actuating devices such as PCB relays, pilot devices or position switches can be directly connected to A10/A11.

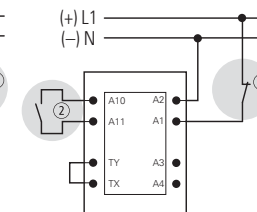
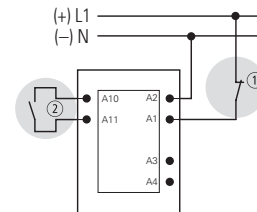

- ① Stopping in case of emergency (Emergency-stop)
- ② Max. cable capacitance 6 nF

**Information relevant for export to North America**



1)	
Product Standards	IEC/EN 60947-4-1; UL 508; CSA-C22.2 No.14-05; CE marking
UL File No.	E29096
UL CCN	NLDX
CSA File No.	012528
CSA Class No.	3211-04
NA Certification	UL Listed, CSA certified

2)	
NA Certification	Request filed for UL and CSA

# 1.1

## Leistungsschütze

Basic devices up to 200 A

1

### DILMP 4 pole

Rated operational current open

Conventional thermal current

Circuit symbol

For use with

AC-1

$I_{th} = I_e$  AC-1 at 50 °C

Open

40 °C      55 °C      70 °C

$I_{th} = I_e$

A	A	A	A
22	21	30	20

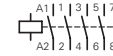

DILM32-XHI(C)...  
DILA-XHI(V)(C)...

Contactors up to 200 A  
4 pole

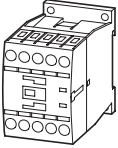

### Notes

<sup>1)</sup> DILM1000-XHI... can only be fitted on the left of DILMP.

Contacts to EN 50012.

For DC operated contactors DILMP20 the following applies:

- Integrated varistor suppressor circuit.

For DC operated contactors DILMP32 - DILMP200 the following applies:

- Integrated suppressor circuit in actuating electronics.

For AC operated contactors DILMP125 - DILMP200 the following applies:

- Integrated suppressor circuit in actuating electronics.

For DILMP32-01 and DILMP45-01 the following applies:

- With mirror contact.

**AC operation**

**Part no.**  
Article no.

**Price**  
See  
price  
list

Std. pack

**DC operation**

**Part no.**  
Article no.

**Price**  
See  
price list

Std. pack

**Notes**

**DILMP20(230V50Hz,240V60Hz)**  
276970

1 off 

**DILMP20(24VDC)**  
276985

1 off 

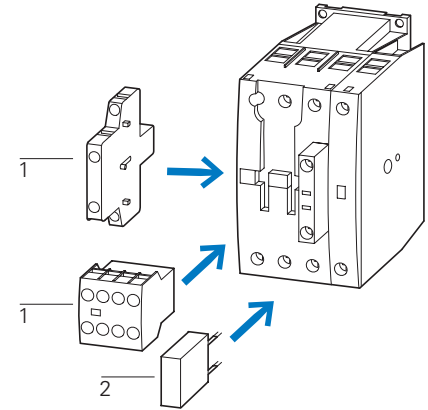

**Accessories**

- 1 Auxiliary contact module
- 2 Suppressor
- Further actuating voltages
- Accessories

- Page**
- 36
  - 50
  - 74
  - 52









































**Information relevant for export to North America**



Product Standards	IEC/EN 60947-4-1; UL 508; CSA-C22.2 No.14-05; CE marking
UL File No.	E29096
UL CCN	NLDX
CSA File No.	012528
CSA Class No.	2411-03, 3211-04
NA Certification	UL Listed, CSA certified
See also	→ Page 81

#### DILM, DILA Auxiliary contact modules

With interlocked opposing contacts, except ...XHI(C)V

Terminal type	Pole	Conventional thermal current $I_{th} = I_e$ AC-1 at 60 °C  Open $I_{th} = I_e$ A	Contact configuration	Circuit symbol	For use with	Part no. Article no.	Price See price list	Std. pack
 Top mounting auxiliary contacts Screw terminals	2 pole	16	1 N/O 1 NC		DILM(C)7-10... DILM(C)9-10...	<b>DILM32-XHI11</b> 277376		5 off 
	2 pole	16	— 1 NC		DILM(C)12-10... DILM(C)15-10... DILM(C)17-10... DILM(C)25-10... DILM(C)32-10... DILM38-...10 DILMP20... DILMP32-10... DILMP45-10... DILL...	<b>DILM32-XHI02</b> 277375		5 off 
 Top mounting auxiliary contacts Screw terminals	4 pole	16	2 N/O 2 NC			<b>DILM32-XHI22</b> 277377		5 off 
	4 pole	16	3 N/O 1 NC			<b>DILM32-XHI31</b> 106112		5 off 
 Top mounting auxiliary contacts Spring-loaded terminals	2 pole	16	1 N/O 1 NC			<b>DILM32-XHIC11</b> 277751		5 off 
	2 pole	16	— 2 NC			<b>DILM32-XHIC02</b> 277750		5 off 
 Top mounting auxiliary contacts Spring-loaded terminals	4 pole	16	2 N/O 2 NC			<b>DILM32-XHIC22</b> 277752		5 off 
 Top mounting auxiliary contacts Screw terminals	2 pole	16	1 N/O —		DILM(C)9... DILM(C)9... DILM(C)12... DILM(C)15... DILM(C)17... DILM(C)25... DILM(C)32... DILM38... DILMP20... DILMP32... DILMP45... DILL...	<b>DILA-XHI20</b> 276422		5 off 
	2 pole	16	1 N/O 1 NC			<b>DILA-XHI11</b> 276421		5 off 
	2 pole	16	— 2 NC			<b>DILA-XHI02</b> 276420		5 off 
	2 pole	16	1 S <sub>F</sub> 1 Ö <sub>S</sub>			<b>DILA-XHIV11</b> 276423		5 off 
 Top mounting auxiliary contacts Screw terminals	4 pole	16	4 N/O —			<b>DILA-XHI40</b> 276428		5 off 
	4 pole	16	3 N/O 1 NC			<b>DILA-XHI31</b> 276427		5 off 
	4 pole	16	2 N/O 2 NC			<b>DILA-XHI22</b> 276426		5 off 
	4 pole	16	1 N/O 3 NC			<b>DILA-XHI13</b> 276425		5 off 
	4 pole	16	— 4 NC			<b>DILA-XHI04</b> 276424		5 off 
	4 pole	16	1 N/O 1 NC 1 S <sub>F</sub> 1 Ö <sub>S</sub>			<b>DILA-XHIV22</b> 276429		5 off 

#### Notes



























- Auxiliary NC usable as mirror contact according to IEC/EN 60947-4-1, Annex F
- Interlocked opposing contacts according to IEC/EN 60947-5-1 Annex L, inside the auxiliary contact modules, also for the integrated auxiliary contacts of the DILM 7 - DILM32

#### Information relevant for export to North America

	Product Standards	IEC/EN 60947-4-1; UL 508; CSA-C22.2 No.14-05; CE marking
	UL File No.	E29184
	UL CCN	NKCR
	CSA File No.	012528
	CSA Class No.	3211-03
	NA Certification	UL Listed, CSA certified

**DILM, DILA**  
**Auxiliary contact modules**

With interlocked opposing contacts, except ...XHI(C)V



Terminal type	Pole	Conventional thermal current $I_{th} = I_e$ AC-1 at 60 °C  Open $I_{th} = I_e$ A	Contact configuration	Circuit symbol	For use with	Part no. Article no.	Price See price list	Std. pack
 <p>Top mounting auxiliary contacts Spring-loaded terminals</p>	2 pole	16	2 N/O	—	DILM(C)7... DILM(C)9... DILM(C)12... DILM(C)15... DILM(C)17... DILM(C)25... DILM(C)32... DILM38... DILMP20... DILMP32... DILMP45... DILL...	<b>DILA-XHIC20</b> 276528		5 off  
	2 pole	16	1 N/O	1 NC		<b>DILA-XHIC11</b> 276527		5 off  
	2 pole	16	—	2 NC		<b>DILA-XHIC02</b> 276526		5 off  
	2 pole	16	1 S <sub>F</sub>	1 Ö <sub>S</sub>		<b>DILA-XHICV11</b> 276529		5 off  
 <p>Top mounting auxiliary contacts Screw terminals</p>	2 pole	16	2 N/O	2 NC		<b>DILA-XHIR22<sup>1)</sup></b> 139580		5 off  
	2 pole	16	1 N/O	1 NC		<b>DILA-XHIR11</b> 110140		5 off  
 <p>Top mounting auxiliary contacts Spring-loaded terminals</p>	4 pole	16	4 N/O	—	DILM(C)9... DILM(C)9... DILM(C)12... DILM(C)15... DILM(C)17... DILM(C)25... DILM(C)32...	<b>DILA-XHIC40</b> 276534		5 off  
	4 pole	16	3 N/O	1 NC		<b>DILA-XHIC31</b> 276533		5 off  
	4 pole	16	2 N/O	2 NC		<b>DILA-XHIC22</b> 276532		5 off  
	4 pole	16	1 N/O	3 NC		<b>DILA-XHIC13</b> 276531		5 off  
	4 pole	16	—	4 NC		<b>DILA-XHIC04</b> 276530		5 off  
	4 pole	16	1 N/O 1 S <sub>F</sub>	1 NC 1 Ö <sub>S</sub>		<b>DILA-XHICV22</b> 276535		5 off  

**Notes**

- Auxiliary NC usable as mirror contact according to IEC/EN 60947-4-1, Annex F
- Interlocked opposing contacts according to IEC/EN 60947-5-1 Annex L, inside the auxiliary contact modules, also for the integrated auxiliary contacts of the DILM 7 - DILM32

<sup>1)</sup> 1 N/C + 1 N/O above microswitch for electronic applications



**Information relevant for export to North America**

 	Product Standards	IEC/EN 60947-4-1; UL 508; CSA-C22.2 No.14-05; CE marking
	UL File No.	E29184
	UL CCN	NKCR
	CSA File No.	012528
	CSA Class No.	3211-03
	NA Certification	UL Listed, CSA certified

<sup>1)</sup> NA Certification Request filed for UL and CSA

#### DILM Auxiliary contact modules

With interlocked opposing contacts

Connection type	Pole	conventional thermal current $I_{th} = I_e$ AC-1 at 60 °C Open $I_{th} = I_e$ A	Contact configuration N/O = normally open contact SF = N/O early make NC = normally closed contact ÖS = NC late-break	Circuit symbol	For use with	Part no. Article no.	Price See price list	Std. pack	Notes
	Screw terminals	2 pole	16	2 N/O –		DILM40... DILM50... DILM65... DILM72... DILM80... DILM95... DILM115... DILM150... DILM170... DILMP63... DILMP80... DILMP125... DILMP160... DILMP200...	<b>DILM150-XHI20</b> 277945	5 off 	Interlocked opposing contacts according to IEC/EN 60947-5-1 Annex L, inside the auxiliary contact modules Auxiliary NC usable as mirror contact according to IEC/EN 60947-4-1, Annex F
		2 pole	16	1 N/O 1 NC		<b>DILM150-XHI11</b> 277946	5 off 		
		2 pole	16	1 N/O 1 NC		<b>DILM150-XHIA11</b> 283463	5 off 		
		2 pole	16	– 2 NC		<b>DILM150-XHI02</b> 277947	5 off 		
	Screw terminals	4 pole	16	4 N/O –		<b>DILM150-XHI40</b> 277948	5 off 		
		4 pole	16	3 N/O 1 NC		<b>DILM150-XHI31</b> 277949	5 off 		
		4 pole	16	2 N/O 2 NC		<b>DILM150-XHI22</b> 277950	5 off 		
		4 pole	16	2 N/O 2 NC		<b>DILM150-XHIA22</b> 283464	5 off 		
		4 pole	16	1 N/O 3 NC		<b>DILM150-XHI13</b> 277951	5 off 		
		4 pole	16	– 4 NC		<b>DILM150-XHI04</b> 277952	5 off 		
		4 pole	16	1 N/O 1 NC 1 SF 1 ÖS		<b>DILM150-XHIV22</b> 277953	5 off 		
			Screw terminals	2 pole	16	2 N/O –			DILA-XHIT7... DILM9... DILM12... DILM15... DILL...
2 pole	16			1 N/O 1 NC		<b>DILA-XHIT11</b> 101043	5 off 		
2 pole	16			– 2 NC		<b>DILA-XHIT02</b> 101041	5 off 		
	Screw terminals	4 pole	16	2 N/O 2 NC		<b>DILA-XHIT22</b> 101044	5 off 		

**Notes** 1) Suitable for the combination with electrical wiringlinks in tool-less plug connection usable with:

- DILM12-XSL
- DILM12-XRL
- DILM12-XS1
- PKZM0-XDM12
- PKZM0-XRM12
- PKZM0-XSM12

- 1 PKZM0
- 2 DILM7 - DILM15
- 3 DILA-XHIT
- 4 PKZM0-XDM12

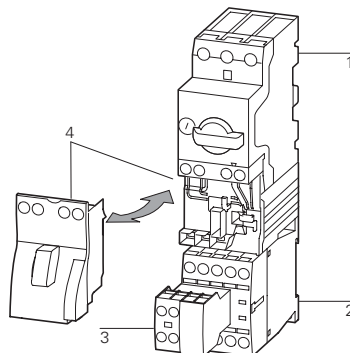

#### Information relevant for export to North America



Product Standards

IEC/EN 60947-4-1; UL 508;  
CSA-C22.2 No.14-05; CE marking

UL File No.

E29184

UL CCN

NKCR

CSA File No.

012528

CSA Class No.

3211-03

NA Certification

UL Listed, CSA certified



### DILM, DILA

Connection type	Pole	conventional thermal current $I_{th} = I_e$ AC-1 at 60 °C Open $I_{th} = I_e$ A	Contact configuration N/O = normally open contact SF = N/O early make NC = normally closed contact ÖS = NC late-break	Circuit symbol	For use with	Part no. Article no.	Price See price list	Std. pack	Notes
<b>Side-mounting auxiliary contacts</b> 	Screw terminals	1 pole	10	1 N/O –		DILM(C)7... DILM(C)9... DILM(C)12... DILM(C)15... DILMP20... DILA(C)...	<b>DILA-XHI10-S</b> 115948	1 off  	1) 
		1 pole	10	– 1 NC			<b>DILA-XHI01-S</b> 115949	1 off  	
	Spring-loaded terminals	1 pole	10	1 N/O –			<b>DILA-XHIC10-S</b> 115950	1 off  	
		1 pole	10	– 1 NC			<b>DILA-XHIC01-S</b> 115951	1 off  	
<b>Side-mounting auxiliary contacts</b> 	Screw terminals	2 pole	10	1 N/O 1 NC		DILM17... DILM25... DILM32... DILM38...	<b>DILM32-XHI11-S</b> 101371	1 off  	Can only be left on the contactor. Cannot be combined with mechanical interlock
<b>Side-mounting auxiliary contacts</b> 	Screw terminals	2 pole	10	1 N/O 1 NC		DILM250 - DILH2600	<b>DILM820-XHI11-SI</b> 208281	1 off  	1) 
		2 pole	10	1 N/O 1 NC			<b>DILM820-XHI11-SA</b> 208282	1 off  	
		2 pole	10	1 SF 1 ÖS			<b>DILM820-XHI11V-SI</b> 208283	1 off  	
<b>Side-mounting auxiliary contacts</b> 	Screw terminals	2 pole	10	1 N/O 1 NC		DILM40 - DILM225A DILMP63 - DILMP200	<b>DILM1000-XHI11-SI</b> 278425	1 off  	
		2 pole	10	1 SF 1 ÖS			<b>DILM1000-XHIV11-SI</b> 278426	1 off  	
		2 pole	10	1 N/O 1 NC			<b>DILM1000-XHI11-SA</b> 278427	1 off  	

**Notes**

- 1)
  - Interlocked opposing contacts according to IEC/EN 60947-5-1 Annex L, inside the auxiliary contact module, also for the integrated auxiliary contacts of the DILM7 – DILM32 (not NO early-make and NC late-break)
  - Auxiliary NC usable as mirror contact according to IEC/EN 60947-4-1, Annex F (no NC late-breaks)
  - No auxiliary contact is possible between 2 contactors with mechanical interlock.

**Information relevant for export to North America**

2)

Product Standards

UL File No.

UL CCN

CSA File No.

CSA Class No.

NA Certification

IEC/EN 60947-4-1; UL 508;  
CSA-C22.2 No.14-05; CE marking  
E29184  
NKCR  
012528  
3211-03,3211-04  
UL Listed, CSA certified

# 1.1

## Contactors

### Auxiliary contact modules

#### 1 Engineering

#### DILM, DILH

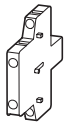

DILM1000-  
XHI(V)11-SI

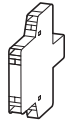

DILM820-  
XHI(V)11-SI

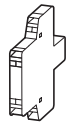

DILM1000-  
XHI(V)11-SA



DILM820-  
XHI(V)11-SA



DILM150-XHI20  
DILM150-XHI11  
DILM150-XHI02



DILM150-XHI40  
DILM150-XHI31  
DILM150-  
XHI(V)22  
DILM150-XHI13  
DILM150-XHI04



DILM150-  
XHIA11



DILM150-  
XHIA22

DILM40	2 x	-	-	-	-	-	1 x	-
... DILM72	-	-	2 x	-	1 x	-	-	-
	1 x	-	-	-	-	-	-	1 x
	-	-	1 x	-	-	1 x	-	-
DILM80	2 x	-	2 x	-	-	-	-	-
... DILM170	2 x	-	-	-	-	-	-	1 x
	2 x	-	-	-	-	-	1 x	-
	-	-	2 x	-	-	1 x	-	-
	-	-	2 x	-	1 x	-	-	-
DILM185A	2 x	-	2 x	-	-	-	-	-
DILM222A	2 x	-	-	-	-	-	-	-
DILM250 DILM1600	-	2 x	-	2 x	-	-	-	-
DILH1400	-	2 x	-	2 x	-	-	-	-
... DILH2600	-	-	-	-	-	-	-	-

#### Notes

#### Side mounting auxiliary contacts

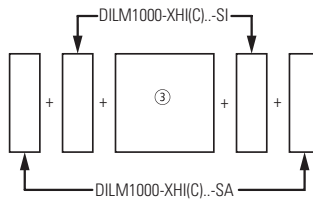
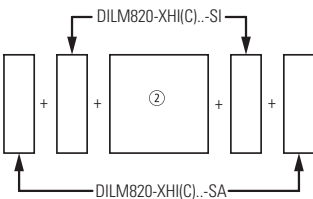
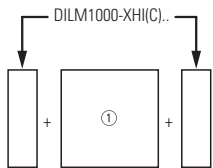

- ① DILM40 – DILM72
- ② DILM250 – DILH2600
- ③ DILM80-DILM225A

- Interlocked opposing contacts according to IEC/EN 60947-5-1 Annex L, inside the auxiliary contact module (not N/O early close and N/C late open)
- Auxiliary contacts can be used as mirror contacts according to IEC/EN 60947-4-1, Annex F (not N/C late open)
- No auxiliary contact is possible between two contactors with mechanical interlock.
- 2 auxiliary contacts DILM820-XHI11-SI are already built into the contactors DILM250 to DILH2600/22.
- 2 DILM1000-XHI11-SI auxiliary contacts are already installed in DILM185A and DILH225A contactors.

### Ordering

#### DILK

Three-phase capacitors  
50 – 60 Hz  
Open

Circuit symbol

**Part no.**  
Article no.

**Price**  
See price list

Std. pack

230 V	400 V	525 V	690 V
-------	-------	-------	-------

kvar	kvar	kvar	kvar
------	------	------	------

7.5	12.5	16.7	20
-----	------	------	----

11	20	25	33.3
----	----	----	------

15	25	33.3	40
----	----	------	----

20	33.3	40	55
----	------	----	----

25	50	65	85
----	----	----	----

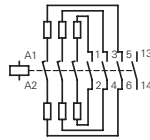
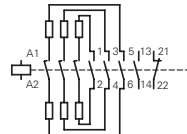

**DILK12-11(230V50Hz,240V60Hz)**  
293988 1 off

**DILK20-11(230V50Hz,240V60Hz)**  
294010 1 off

**DILK25-11(230V50Hz,240V60Hz)**  
294032 1 off

**DILK33-10(230V50Hz,240V60Hz)**  
294054 1 off

**DILK50-10(230V50Hz,240V60Hz)**  
294076 1 off

#### With series resistors Basic Units

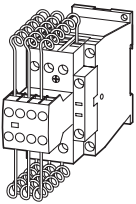

#### Notes

Weld-resistant for capacitors with inrush current peaks up to  $180 \times I_N$

With group compensation multi-stage capacitor banks are connected to the mains as required. This can cause, transient currents of up to  $180 \times I_e$  to flow between the capacitors.

The capacitors are pre-charged via the early-make auxiliary contacts and the fitted wire resistors, thereby reducing the inrush current. The main contacts then close after a time lag and carry the continuous current.

The contactors for capacitors are weld-resistant with inrush current peaks up to  $180 \times I_e$  due to their special contacts.

DILK... cannot be combined with other auxiliary contacts.

For the switching of reactive-power compensation equipment please see Engineering notes on power factor correction → page 33.

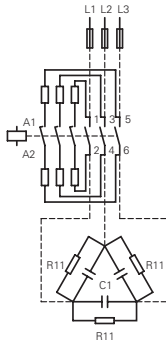

#### Accessories Page

Enclosures		
Accessories		→ 52
Further actuating voltages		→ 76

#### Information relevant for export to North America



Product Standards	IEC/EN 60947-4-1; UL 508; CSA-C22.2 No.14-05; CE marking
UL File No.	E29096
UL CCN	NLDX
CSA File No.	012528
CSA Class No.	3211-04
NA Certification	UL Listed, CSA certified
See also	Further approvals → Page 66

# 1.1

## Contactors

Contactors for power factor correction

### 1 Engineering

#### DILM, DILK

Part no.	Page	Switching power			
		230 V	400 V 420 V 440 V	525 V	690 V
Ordering data		kvar	kvar	kvar	kvar
<b>Individual compensation, open version</b>					
DILM7-...(…)	→ 18	1.5	3	3.5	5
DILM9-...(…)	→ 18	2	4	4.5	6
DILM12-...(…)	→ 18	2.5	4.5	5.5	7
DILM15-...(…)	→ 18	2.5	4.5	5.5	7
DILM17-...(…)	→ 18	6.5	12	14.5	19
DILM25-...(…)	→ 18	7	13.5	16	21
DILM32-...(…)	→ 18	7.5	14.5	17	22.5
DILM40(…)	→ 20	11	20.5	24.5	32
DILM50(…)	→ 20	11.5	22	26	34.5
DILM65(…)	→ 20	12.5	23.5	28	37
DILM80(…)	→ 20	16	30.5	36.5	48
DILM95(…)	→ 20	18	34	41	54
DILM115(…)	→ 20	24	46	54.5	72
DILM150(…)	→ 20	28	53	63.5	83.5
DILM185A(…)	→ 30	87	150	190	150
DILM300A(…)	→ 30	115	200	265	200
DILM580(…)	→ 30	175	300	400	300
<b>Group compensation, with choke, open version</b>					
DILM7-...(…)	→ 18	4	7	7.5	12
DILM9-...(…)	→ 18	5	8	10	14
DILM12-...(…)	→ 18	5.5	10	12	16
DILM15-...(…)	→ 18	5.5	10	12	16
DILM17-...(…)	→ 18	7.5	18	20	28
DILM25-...(…)	→ 18	10	20	23	30
DILM32-...(…)	→ 18	12.5	25	25	32
DILM40(…)	→ 20	15	30	30	40
DILM50(…)	→ 20	20	40	40	48
DILM65(…)	→ 20	25	50	50	57
DILM80(…)	→ 20	30	60	70	90
DILM95(…)	→ 20	35	70	80	104
DILM115(…)	→ 20	50	95	100	125
DILM150(…)	→ 20	55	115	115	152
DILM185A(…)	→ 30	80	150	200	260
DILM225A(…)	→ 30	100	175	230	300
DILM250(…)	→ 30	110	190	260	340
DILM300A(…)	→ 30	130	225	290	390
DILM400(…)	→ 30	160	280	370	480
DILM500(…)	→ 30	220	390	500	680
<b>Group compensation, without choke, open version</b>					
DILK12-...(…)	→ 41	7.5	12.5	16.7	20
DILK20-...(…)	→ 41	11	20	25	33.3
DILK25-...(…)	→ 41	15	25	33.3	40
DILK33-...(…)	→ 41	20	33.3	40	55
DILK50-...(…)	→ 41	25	50	65	85
DILM185A(…)	→ 30	66	115	145	115
DILM300A(…)	→ 30	85	150	195	150
DILM580(…)	→ 30	145	250	333	250

#### Notes

##### Use of the contactors DILM without series resistor for group compensation

When using the contactors for group compensation in a system without chokes each capacitor must have a minimum induction of approx. 6 µH to limit the peak inrush current. This corresponds to an air-cored coil with 5 windings and a coil diameter of approximately Ø 140 mm. The conductor cross section must correspond to the rated operational current.

# 1.1

## Contactors combinations

Star-delta combinations

### Ordering

1

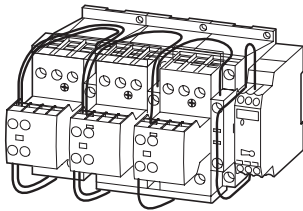
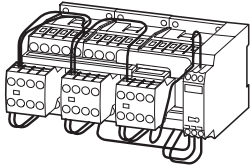
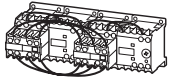

### Star-delta combinations SDAINL

Operating frequency: maximum 30 starts per hour

Rated operational current AC-3	Max. rated operational power for three-phase motors, 50 - 60 Hz					Max. change- over time s	Part no. Article no.	Price See price list	Std. pack
	400 V	230 V	400 V	500 V	690 V				
$I_e$ A	P kW	P kW	P kW	P kW	P kW				
12	4	5.5	5.5	–	–	< 30	<b>SDAINLM(230V50Hz)</b> 051840	1 off	
12	3	5.5	5.5	5.5	–	< 20	<b>SDAINLM12(230V50Hz)</b> 278286	1 off	
12	3	5.5	5.5	5.5	–	< 20	<b>SDAINLM12(400V50Hz)</b> 101380	1 off	
12	3	5.5	5.5	5.5	–	< 20	<b>SDAINLM12(24VDC)</b> 100416	1 off	
16	4	7.5	7.5	7.5	–	< 20	<b>SDAINLM16(230V50Hz)</b> 278311	1 off	
16	4	7.5	7.5	7.5	–	< 20	<b>SDAINLM16(400V50Hz)</b> 101381	1 off	
16	4	7.5	7.5	7.5	–	< 20	<b>SDAINLM16(24VDC)</b> 100417	1 off	
22	5.5	11	11	11	–	< 20	<b>SDAINLM22(230V50Hz)</b> 278336	1 off	
22	5.5	11	11	11	–	< 20	<b>SDAINLM22(400V50Hz)</b> 101382	1 off	
22	5.5	11	11	11	–	< 20	<b>SDAINLM22(24VDC)</b> 100418	1 off	
30	7.5	15	18.5	18.5	–	< 20	<b>SDAINLM30(230V50Hz)</b> 278361	1 off	
30	7.5	15	18.5	18.5	–	< 20	<b>SDAINLM30(400V50Hz)</b> 101383	1 off	
30	7.5	15	18.5	18.5	–	< 20	<b>SDAINLM30(RDC24)</b> 100419	1 off	
45	11	22	30	22	–	< 20	<b>SDAINLM45(230V50Hz)</b> 278386	1 off	
45	11	22	30	22	–	< 20	<b>SDAINLM45(400V50Hz)</b> 101384	1 off	
45	11	22	30	22	–	< 20	<b>SDAINLM45(RDC24)</b> 100420	1 off	
55	15	30	37	30	–	< 20	<b>SDAINLM55(230V50Hz)</b> 278411	1 off	
55	15	30	37	30	–	< 20	<b>SDAINLM55(400V50Hz)</b> 101385	1 off	
55	15	30	37	30	–	< 20	<b>SDAINLM55(RDC24)</b> 100421	1 off	
70	18.5	37	45	37	–	< 20	<b>SDAINLM70(230V50Hz)</b> 239895	1 off	
70	18.5	37	45	37	–	< 20	<b>SDAINLM70(400V50Hz)</b> 101386	1 off	
90	22	45	55	45	–	< 20	<b>SDAINLM90(230V50Hz)</b> 239937	1 off	
115	30	55	75	55	–	< 20	<b>SDAINLM115(230V50Hz)</b> 239963	1 off	
140	37	75	90	90	–	< 20	<b>SDAINLM140(230V50Hz)</b> 240009	1 off	
165	45	90	110	132	–	< 20	<b>SDAINLM165(230V50Hz)</b> 240035	1 off	
200	55	110	132	160	–	< 20	<b>SDAINLM200(230V50Hz)</b> 101010	1 off	
260	75	132	160	160	–	< 20	<b>SDAINLM260(230V50Hz)</b> 101031	1 off	

Individual components of the combination				Spare auxiliary contacts			Notes
Mains contactor Q11	Delta contactor Q15	Star contactor Q13	Timing relays K1	Q11	Q13	Q15	
Part no.	Part no.	Part no.	Part no.				
DILEM-10 + 22DILEM	DILEM-01	DILEM-10 + 02DILEM	DILET		—	—	<p>Main circuit: Depending on the type of coordination required (i.e. Type "1" or Type "2") it must be established whether the fuse protection and the input wiring for the mains contactor and delta contactor are to be common or separate.</p> <p>The following applies for SDAINLM 140 – SDAINLM 260:</p> <ul style="list-style-type: none"> <li>On the mounting plate.</li> </ul> <p>Circuit diagrams, Star-delta combinations → page 46</p>
DILM7-10 + DILA-XHI20	DILM7-01 + DILA-XHI20	DILM7-01 + DILA-XHI20	ETR4-51				
DILM7-10 + DILA-XHI20	DILM7-01 + DILA-XHI20	DILM7-01 + DILA-XHI20	ETR4-51				
DILM7-10 + DILA-XHI20	DILM7-01 + DILA-XHI20	DILM7-01 + DILA-XHI20	ETR4-51				
DILM9-10 + DILA-XHI20	DILM9-01 + DILA-XHI20	DILM7-01 + DILA-XHI20	ETR4-51				
DILM9-10 + DILA-XHI20	DILM9-01 + DILA-XHI20	DILM7-01 + DILA-XHI20	ETR4-51				
DILM9-10 + DILA-XHI20	DILM9-01 + DILA-XHI20	DILM7-01 + DILA-XHI20	ETR4-51				
DILM12-10 + DILA-XHI20	DILM12-01 + DILA-XHI20	DILM7-01 + DILA-XHI20	ETR4-51				
DILM12-10 + DILA-XHI20	DILM12-01 + DILA-XHI20	DILM7-01 + DILA-XHI20	ETR4-51				
DILM12-10 + DILA-XHI20	DILM12-01 + DILA-XHI20	DILM7-01 + DILA-XHI20	ETR4-51				
DILM12-10 + DILA-XHI20	DILM12-01 + DILA-XHI20	DILM7-01 + DILA-XHI20	ETR4-51				
DILM17-10 + DILA-XHI20	DILM17-01 + DILA-XHI20	DILM17-01 + DILA-XHI20	ETR4-51				
DILM17-10 + DILA-XHI20	DILM17-01 + DILA-XHI20	DILM17-01 + DILA-XHI20	ETR4-51				
DILM17-10 + DILA-XHI20	DILM17-01 + DILA-XHI20	DILM17-01 + DILA-XHI20	ETR4-51				
DILM17-10 + DILA-XHI20	DILM17-01 + DILA-XHI20	DILM17-01 + DILA-XHI20	ETR4-51				
DILM25-10 + DILA-XHI20	DILM25-01 + DILA-XHI20	DILM17-01 + DILA-XHI20	ETR4-51				
DILM25-10 + DILA-XHI20	DILM25-01 + DILA-XHI20	DILM17-01 + DILA-XHI20	ETR4-51				
DILM25-10 + DILA-XHI20	DILM25-01 + DILA-XHI20	DILM17-01 + DILA-XHI20	ETR4-51				
DILM32-10 + DILA-XHI20	DILM32-01 + DILA-XHI20	DILM25-01 + DILA-XHI20	ETR4-51				
DILM32-10 + DILA-XHI20	DILM32-01 + DILA-XHI20	DILM25-01 + DILA-XHI20	ETR4-51				
DILM32-10 + DILA-XHI20	DILM32-01 + DILA-XHI20	DILM25-01 + DILA-XHI20	ETR4-51				
DILM40 + DILM150-XHI31	DILM40 + DILM150-XHI11	DILM40 + DILM150-XHI11	ETR4-51		—	—	
DILM40 + DILM150-XHI31	DILM40 + DILM150-XHI11	DILM40 + DILM150-XHI11	ETR4-51		—	—	
DILM50 + DILM150-XHI31	DILM50 + DILM150-XHI11	DILM40 + DILM150-XHI11	ETR4-51		—	—	
DILM65 + DILM150-XHI31	DILM65 + DILM150-XHI11	DILM40 + DILM150-XHI11	ETR4-51		—	—	
DILM80 + DILM150-XHI31	DILM80 + DILM150-XHI11	DILM50 + DILM150-XHI11	ETR4-51		—	—	
DILM95 + DILM150-XHI31	DILM95 + DILM150-XHI11	DILM65 + DILM150-XHI11	ETR4-51		—	—	
DILM115 + DILM150-XHI31	DILM115 + DILM150-XHI11	DILM80 + DILM150-XHI11	ETR4-51		—	—	
DILM150 + DILM150-XHI31	DILM150 + DILM150-XHI11	DILM95 + DILM150-XHI11	ETR4-51		—	—	

**Accessories**  
1 Overload relay  
Accessories

**Page**  
→ Chapter 1.2  
→ 52

# 1.1 Contactor combinations

## Star-delta combinations

### 1 Engineering

#### SDAINL Circuit diagrams, Star-delta combinations

SDAINLEM



SDAINLM12...SDAINLM55

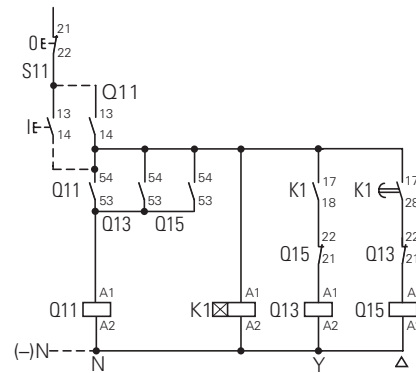
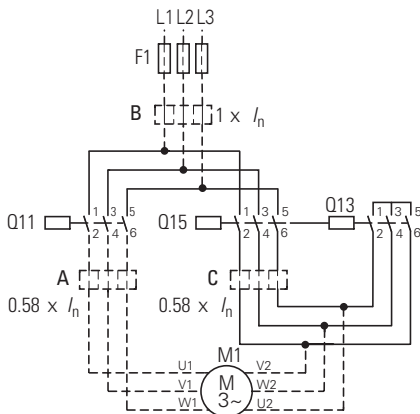

SDAINLM70...SDAINLM260

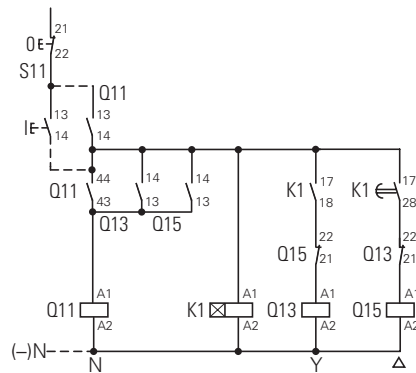

Overload relay settings

- A:**  $I_N \times 0.58$   
Motor protected in Y and  $\Delta$ - positions
- B:**  $I_N \times 1$   
Only partial motor protection in Y position
- C:**  $I_N \times 0.58$   
Motor not protected in Y position
- Timing relay set to approx. 10 s
- Main circuit:

Starting

- $\leq 15$  s
- 15 – 40 s
- > 40 s

Depending on the type of coordination required (i.e. Type "1" or Type "2") it must be established whether the fuse protection and the input wiring for the mains contactor and delta contactor are to be common or separate.

### SDAINL Components for self-assembly of star-delta combinations

Maximum operational rating of AC motors 50 - 60 Hz  
AC-3

Changeover time<sup>1)</sup>

#### Individual components of the combination

Spare auxiliary contacts

230 V kW	400 V kW	500 V kW	690 V kW	1000 V kW	up to 12 s	up to 20 s	up to 30 s	Coil to EN 50005 Switching element to EN 50005 and EN 50012				Q11	Q15	Q13
								Mains contactor Q11 Part no. DIL	Delta contactor Q15 Part no. DIL	Star contactor Q13 Part no. DIL	Timing relay K1 Part no.			
90	160	200	250	132	●	●	●	M185A/22	M185A/22	M115/22	ETR4-51			
110	200	250	315	160	●	●	—	M225A/22	M225A/22	M150/22	ETR4-51			
132	250	315	400	200	●	●	●	M250/22	M250/22	M185A/22	ETR4-51			
160	300	355	450	200	●	●	●	M300A/22	M300A/22	M185A/22	ETR4-51			
200	355	450	560	220	●	●	—	M400/22	M400/22	M250/22	ETR4-51			
250	450	560	600	220	●	●	●	M500/22	M500/22	M300A/22	ETR4-51			
300	560	710	900	355	●	●	●	M580/22	M580/22	M400/22	ETR4-51			
350	630	750	950	355	●	●	●	M650/22	M650/22	M400/22	ETR4-51			
400	710	900	1200	1400	●	●	●	M750/22	M750/22	M580/22	ETR4-51			
450	800	950	1300	1400	●	●	●	M820/22	M820/22	M580/22	ETR4-51			
560	1000	1200	1700	1700	●	●	—	M1000/22	M1000/22	M650/22	ETR4-51			

#### Notes

<sup>1)</sup> Longer changeover times please enquire

#### Components for self-assembly

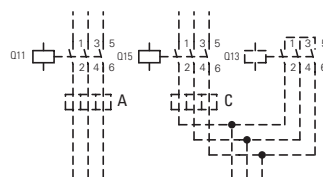

#### Notes

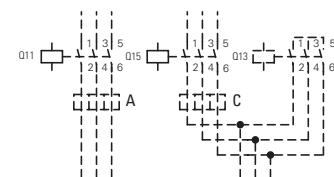

#### Overload relay settings

Timing relay set to approx. 10 s

$I_N$	Starting	Main circuit: Depending on the coordination type required (i.e. Type "1" or Type "2") it must be established whether the fuse protection and the input wiring for the mains contactor and delta contactor are to be common or separate.
<b>A</b> x 0.58 Motor protection in Y and $\Delta$ positions	$\leq 15$ s	
<b>B</b> x 1 In Y position only limited motor protection	15 – 40 s	Control circuit: If the combinations are to be used within the scope of IEC/EN 60 204 Part 1, VDE 0113 Part 1, then Point 9.1.1 regarding the supply of control circuits, must be observed.
<b>C</b> x 0.58 Motor not protected in Y position	> 40 s	





































# 1.1

## Contactors combinations

### Reversing combinations

#### 1 Ordering

#### DIUL reversing combinations

Rated operational current	Max. motor rating for three-phase motors 50 - 60 Hz						Part no. Article no.	Price See price list	Std. pack
	AC-3 400 V	AC-3			AC-4				
$I_e$ A	220 V 230 V	380 V 400 V	660 V 690 V	220 V 230 V	380 V 400 V	660 V 690 V			
	P kW	P kW	P kW	P kW	P kW	P kW			
	9	2.2	4	4	1.5	3	3	<b>DIULEM/21(MV(230V50Hz))<sup>1)</sup></b> 051849	1 Off  
	9	2.2	4	4	1.5	3	3	<b>DIULEM/21(MV-G(24VDC))<sup>2)</sup></b> 214655	1 Off  
	7	2.2	3	3.5	1	2.2	2.9	<b>DIULM7/21(230V50Hz)<sup>2)</sup></b> 278061	1 Off  
	7	2.2	3	3.5	1	2.2	2.9	<b>DIULM7/21(24VDC)<sup>2)</sup></b> 107021	1 Off  
	9	2.5	4	4.5	1.5	2.5	3.6	<b>DIULM9/21(230V50Hz)<sup>2)</sup></b> 278086	1 Off  
	9	2.5	4	4.5	1.5	2.5	3.6	<b>DIULM9/21(24VDC)<sup>2)</sup></b> 107022	1 Off  
	12	3.5	5.5	6.5	2	3	4.4	<b>DIULM12/21(230V50Hz)<sup>2)</sup></b> 278111	1 Off  
	12	3.5	5.5	6.5	2	3	4.4	<b>DIULM12/21(24VDC)<sup>2)</sup></b> 107023	1 Off  
	18	5	7.5	11	2.5	4.5	6.5	<b>DIULM17/21(230V50Hz)<sup>2)</sup></b> 278136	1 Off  
	18	5	7.5	11	2.5	4.5	6.5	<b>DIULM17/21(RDC24)<sup>2)</sup></b> 107024	1 Off  
	25	7.5	11	14	3.5	6	8.5	<b>DIULM25/21(230V50Hz)<sup>2)</sup></b> 278161	1 Off  
	25	7.5	11	14	3.5	6	8.5	<b>DIULM25/21(RDC24)<sup>2)</sup></b> 107025	1 Off  
	32	10	15	17	4	7	10	<b>DIULM32/21(230V50Hz)<sup>2)</sup></b> 278186	1 Off  
	32	10	15	17	4	7	10	<b>DIULM32/21(RDC24)<sup>2)</sup></b> 107026	1 Off  
	40	12.5	18.5	23	5	9	12	<b>DIULM40/11(230V50Hz)<sup>2)</sup></b> 278211	1 Off  
	50	15.5	22	30	6	10	14	<b>DIULM50/11(230V50Hz)<sup>2)</sup></b> 278236	1 Off  
	65	20	30	35	7	12	17	<b>DIULM65/11(230V50Hz)<sup>2)</sup></b> 278261	1 Off  

#### AC operation

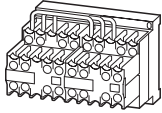

#### AC operation

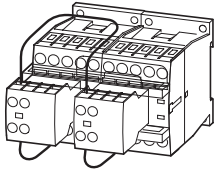

#### AC operation

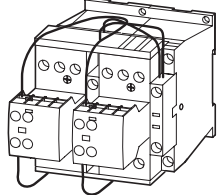

#### Information relevant for export to North America



1) Product Standards	IEC/EN 60947-4-1; UL 508; CSA-C22.2 No.14-05; CE marking
UL File No.	E29096
UL CCN	NLDX
CSA File No.	012528
CSA Class No.	3211-04
NA Certification	UL Listed, CSA certified

#### Information relevant for export to North America



2) Product Standards	IEC/EN 60947-4-1; UL 508; CSA-C22.2 No.14-05; CE marking
UL File No.	E29096
UL CCN	NLDX
CSA File No.	012528
CSA Class No.	2411-03, 3211-04
NA Certification	UL Listed, CSA certified

Individual components of the combination		Spare auxiliary contacts		Mechanical interlock	Circuit diagram	Notes
Contactor Q11	Contactor Q12	Q11	Q12			
Part no.	Part no.					
DILEM-10 + 11DILEM	DILEM-10 + 11DILEM			+		<p><b>Accessories</b> 1 Overload relay Accessories</p> <p>Reversing contactors</p>
DILEM-10-G + 11DILEM	DILEM-10-G + 11DILEM			+		
DILM7-01 + DILA-XHI20	DILM7-01 + DILA-XHI20			+		<p><b>Accessories</b> 1 Overload relay Accessories</p> <p>Reversing contactors</p> <p>DIULM7/21 to DIULM65/11 with mechanical interlock</p>
DILM7-01 + DILA-XHI20	DILM7-01 + DILA-XHI20			+		
DILM9-01 + DILA-XHI20	DILM9-01 + DILA-XHI20			+		
DILM9-01 + DILA-XHI20	DILM9-01 + DILA-XHI20			+		
DILM12-01 + DILA-XHI20	DILM12-01 + DILA-XHI20			+		
DILM12-01 + DILA-XHI20	DILM12-01 + DILA-XHI20			+		
DILM17-01 + DILA-XHI20	DILM17-01 + DILA-XHI20			+		
DILM17-01 + DILA-XHI20	DILM17-01 + DILA-XHI20			+		
DILM25-01 + DILA-XHI20	DILM25-01 + DILA-XHI20			+		
DILM25-01 + DILA-XHI20	DILM25-01 + DILA-XHI20			+		
DILM32-01 + DILA-XHI20	DILM32-01 + DILA-XHI20			+		
DILM32-01 + DILA-XHI20	DILM32-01 + DILA-XHI20			+		
DILM40 + DILM150-XHI11	DILM40 + DILM150-XHI11	-	-	+		
DILM50 + DILM150-XHI11	DILM50 + DILM150-XHI11	-	-	+		
DILM65 + DILM150-XHI11	DILM65 + DILM150-XHI11	-	-	+		

**Page**  
→ Chapter 1.2  
→ 52

# 1.1

## Contactor relays, contactors

### Suppressor circuit

#### 1 Ordering

#### DILM...-XSP... Suppressor circuits

##### RC suppressors

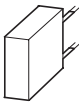

Voltage $U_s$ V	For use with	Circuit symbol	Part no. Article no.	Price See price list	Std. pack	Notes
24 - 48 AC	DILM7 - DILM15 DILMP20		<b>DILM12-XSPR48</b> 281199	10 Off		For AC operated contactors 50 - 60 Hz. DC operated contactors and DILM115 and DILM150 have an integrated suppressor. Note drop-out delay.
110 - 240 AC	DILA		<b>DILM12-XSPR240</b> 281200	10 Off		
240 - 500 AC			<b>DILM12-XSPR500</b> 281201	10 Off		
24 - 48 AC	DILM17 - DILM32 DILK12 - DILK25		<b>DILM32-XSPR48</b> 281202	10 Off		
110 - 240 AC	DILL... DILMP32 - DILMP45		<b>DILM32-XSPR240</b> 281203	10 Off		
240 - 500 AC			<b>DILM32-XSPR500</b> 281204	10 Off		
24 - 48 AC	DILM40 - DILM95 DILK33 - DILK50		<b>DILM95-XSPR48</b> 281205	10 Off		
110 - 240 AC	DILMP63 - DILMP200		<b>DILM95-XSPR240</b> 281206	10 Off		
240 - 500 AC			<b>DILM95-XSPR500</b> 281207	10 Off		

##### Varistor suppressors

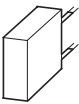

24 - 48 AC	DILM7 - DILM15 DILMP20		<b>DILM12-XSPV48</b> 281208	10 Off		For AC operated contactors 50 - 60 Hz. DC operated contactors and DILM115 and DILM150 have an integrated suppressor. Note drop-out delay.
48 - 130 AC	DILA		<b>DILM12-XSPV130</b> 281209	10 Off		
130 - 240 AC			<b>DILM12-XSPV240</b> 281210	10 Off		
240 - 500 AC		<b>DILM12-XSPV500</b> 281211	10 Off			
24 - 48 AC	DILM17 - DILM32 DILK12 - DILK25		<b>DILM32-XSPV48</b> 281212	10 Off		
48 - 130 AC	DILL... DILMP32 - DILMP45		<b>DILM32-XSPV130</b> 281213	10 Off		
130 - 240 AC			<b>DILM32-XSPV240</b> 281214	10 Off		
240 - 500 AC		<b>DILM32-XSPV500</b> 281215	10 Off			
24 - 48 AC	DILM40 - DILM95 DILK33 - DILK50		<b>DILM95-XSPV48</b> 281216	10 Off		
48 - 130 AC	DILMP63 - DILMP200		<b>DILM95-XSPV130</b> 281217	10 Off		
130 - 240 AC			<b>DILM95-XSPV240</b> 281218	10 Off		
240 - 500 AC		<b>DILM95-XSPV500</b> 281219	10 Off			

#### Information relevant for export to North America



Product Standards	IEC/EN 60947-4-1; UL 508; CSA-C22.2 No.14-05; CE marking
UL File No.	E29096
UL CCN	NLDX
CSA File No.	227038
CSA Class No.	3211-07
NA Certification	UL Listed, CSA certified

### Ordering

#### DILM...-XSP... Suppressor circuits

##### Varistor suppressors with integrated LED



##### Diode suppressor



Voltage $U_s$ V	For use with	Circuit symbol	Part no. Article no.	Price See price list	Std. pack	Notes
24 - 48 AC	DILM7 - DILM15 DILMP20		<b>DILM12-XSPVL48</b> 281220		10 Off 	For AC operated contactors 50 - 60 Hz. DC operated contactors and DILM115 and DILM150 have an integrated suppressor. Note drop-out delay.
130 - 240 AC	DILA		<b>DILM12-XSPVL240</b> 281221		10 Off 	
24 - 48 AC	DILM17 - DILM32 DILK12 - DILK25		<b>DILM32-XSPVL48</b> 281222		10 Off 	
130 - 240 AC	DILL... DILMP32 - DILMP45		<b>DILM32-XSPVL240</b> 281223		10 Off 	
24 - 48 AC	DILM40 - DILM95 DILK33 - DILK50		<b>DILM95-XSPVL48</b> 281224		10 Off 	
130 - 240 AC	DILMP63 - DILMP200		<b>DILM95-XSPVL240</b> 281225		10 Off 	
12 - 250 DC	DILM7 - DILM15 DILMP20 DILA		<b>DILM12-XSPD</b> 101672		10 Off 	DC operated contactors. Prevention of negative switch-off voltage when the contactor is used together with a safety PLC.















#### Information relevant for export to North America

	Product Standards	IEC/EN 60947-4-1; UL 508; CSA-C22.2 No.14-05; CE marking
	UL File No.	E29096
	UL CCN	NLDX
	CSA File No.	227038
	CSA Class No.	3211-07
	NA Certification	UL Listed, CSA certified

# 1.1 Contactor relays, contactors

## Accessories

### 1 DILM...-XDILM...-XVB, DILM...-XMV





	For use with	Part no. Article no.	Price See price list	Std. pack	Notes	Information relevant for export to North America 	
<b>Mechanical interlocks</b>							
For mechanically linking contactors in combinations 0 mm distance between contactors.							
	DILM7 - DILM72 DILA	<b>DILM32-XVB</b> 281227		50 Off 	–	Product Standards	IEC/EN 60947-4-1; UL 508; CSA-C22.2 No.14-05; CE marking
						UL File No.	E36332
						UL CCN	NLRV
						CSA File No.	012528
						CSA Class No.	3211-05
						NA Certification	UL Listed, CSA certified
	DILM80 - DILM170	<b>DILM150-XVB</b> 281226		10 Off 	–	Product Standards	IEC/EN 60947-4-1; UL 508; CSA-C22.2 No.14-05; CE marking
						UL File No.	E29184
						UL CCN	NKCR
						CSA File No.	012528
						CSA Class No.	3211-03
						NA Certification	UL Listed, CSA certified
<b>Mechanical interlocks</b>							
	DILM7 - DILM15 DILMP20 DILA	<b>DILM12-XMV</b> 281196		1 Off 	For two contactors with AC or DC operation arranged vertically or horizontally. Distance between contactors 0 mm, including contactor connector Mechanical lifespan 2.5 x 10 <sup>6</sup> operations. DILM 150-XMV including mounting plate for contactors. Additional auxiliary contact modules possible. →36	Product Standards	IEC/EN 60947-4-1; UL 508; CSA-C22.2 No.14-05; CE marking
						UL File No.	E29096
						UL CCN	NLDX
						CSA File No.	012528
						CSA Class No.	2411-03
						NA Certification	UL Listed, CSA certified
	DILM17 - DILM38	<b>DILM32-XMV</b> 281197		1 Off 		Product Standards	IEC/EN 60947-4-1; UL 508; CSA-C22.2 No.14-05; CE marking
						UL File No.	E29096
						UL CCN	NLDX
						CSA File No.	012528
						CSA Class No.	2411-03,3211-04
						NA Certification	UL Listed, CSA certified
	DILM40 - DILM72	<b>DILM65-XMV</b> 281198		1 Off 		Product Standards	IEC/EN 60947-4-1; UL 508; CSA-C22.2 No.14-05; CE marking
						UL File No.	E29096
						UL CCN	NLDX
						CSA File No.	012528
						CSA Class No.	2411-03
						NA Certification	UL Listed, CSA certified
	DILM80 - DILM170	<b>DILM150-XMV</b> 240081		1 Off 		Product Standards	IEC/EN 60947-4-1; UL 508; CSA-C22.2 No.14-05; CE marking
						UL File No.	E29096
						UL CCN	NLDX
						CSA File No.	012528
						CSA Class No.	2411-03
						NA Certification	UL Listed, CSA certified
	DILM185A, DILM225A, DILM250, DILM300A, DILM400, DILM500, DILM570	<b>DILM500-XMV</b> 208289		1 Off 	For contactors with the same or different magnet systems mounted horizontally or vertically, mechanical lifespan 5 x 10 <sup>6</sup> operations. <b>No</b> auxiliary contact permitted between mechanical interlock and contactor. Combination only with consecutive installation sizes or DILM185A - DILM570.	Product Standards	IEC/EN 60947-4-1; UL 508; CSA-C22.2 No.14-05; CE marking
						UL File No.	E29184
						UL CCN	NKCR
						CSA File No.	012528
						CSA Class No.	3211-04
						NA Certification	UL Listed, CSA certified
	DILM580, DILM650, DILM750, DILM820 DILM1000	<b>DILM820-XMV</b> 208288		1 Off 	For contactors with the same or different magnet systems mounted horizontally or vertically, mechanical lifespan 5 x 10 <sup>6</sup> operations. <b>No</b> auxiliary contact permitted between mechanical interlock and contactor. DILM820-XMV consists of interlock element and mounting plate.	Product Standards	IEC/EN 60947-4-1; UL 508; CSA-C22.2 No.14-05; CE marking
						UL File No.	E29184
						UL CCN	NKCR
						CSA File No.	012528
						CSA Class No.	3211-04
						NA Certification	UL Listed, CSA certified
<b>Set of spare parts for mechanical interlock</b>							
Ball for mechanical interlock, incl. contactor connector.							
–	DILM80 - DILM170	<b>DILM150-XMVE</b> 107020		1 Off 		UL/CSA certification not required	

### DILM...-XP1, DILM...-XS1

For use with	Circuit symbol	Part no. Article no.	Price See price list	Std. pack	Notes	Information relevant for export to North America
<b>Paralleling links for main contacts</b>						
Consisting of 2 paralleling links						
	DILM7 - DILM15	<b>DILM12-XP1</b> 281193		5 Off  	4th pole can be broken off AC-1 current carrying capacity of the open contactor increases by a factor of 2.5 Protected against accidental contact in accordance with VDE 0106 Part 100	Product Standards  UL File No. UL CCN CSA File No. CSA Class No. NA Certification
	DILM17 - DILM32	<b>DILM32-XP1</b> 281194		5 Off  		IEC/EN 60947-4-1; UL 508; CSA-C22.2 No.14-05; CE marking E29096 NLDX 012528 3211-03 UL Listed, CSA certified
	DILM40 - DILM72	<b>DILM65-XP1</b> 281195		1 Off  	A cover is included with DILM185-XP1 for protection against accidental contact.	
	DILM80 - DILM170	<b>DILM150-XP1</b> 284769		1 Off  	Connection cross section for DILM...-XP1 Technical data	
	DILM185A	<b>DILM185-XP1</b> 208292		1 Off		–
<b>Star-point bridges</b>						
	DILM7 - DILM15	<b>DILM12-XS1</b> 281190		20 Off  	<ul style="list-style-type: none"> <li>Designed as tool-less plug connection</li> <li>Use as DILA-XHIT... contactor auxiliary contact → 38</li> </ul>	Product Standards  UL File No. UL CCN CSA File No. CSA Class No. NA Certification
	DILM17 - DILM32	<b>DILM32-XS1</b> 281191		20 Off  	Use as DILA-XHIT... contactor auxiliary contact → 38	Product Standards  UL File No. UL CCN CSA File No. CSA Class No. NA Certification
	DILM40 - DILM72	<b>DILM65-XS1</b> 281192		10 Off  	–	IEC/EN 60947-4-1; UL 508; CSA-C22.2 No.14-05; CE marking E36332 NLRV 012528 3211-04 UL Listed, CSA certified
	DILM80 - DILM170	<b>DILM150-XS1</b> 284768		5 Off  	–	Product Standards  UL File No. UL CCN CSA File No. CSA Class No. NA Certification
	DILM185A - DILM400	<b>DILM400-XS1</b> 208291		1 Off  	A cover is included for protection against accidental contact.	Product Standards  UL File No. UL CCN CSA File No. CSA Class No. NA Certification
	DILM500	<b>DILM500-XS1</b> 208290		1 Off  	A cover is included for protection against accidental contact.	Product Standards  UL File No. UL CCN NA Certification









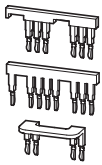

### DILM...-XSL Star-delta wiring kit

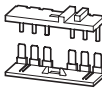
#### Main current wiring for star-delta combination Including star-point bridge







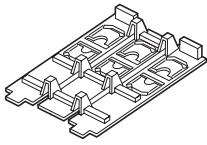

For use with	Part no. Article no.	Price See price list	Std. pack	Notes	Information relevant for export to North America
	DILM7/9/12/15 mains contactors DILM7/9/12/15 delta contactors DILM7/9/12/15 star contactors	<b>DILM12-XSL</b> 283130	1 Off 	<ul style="list-style-type: none"> <li>Designed for tool-less plug connection</li> <li>Use as DILA-XHIT... contactor auxiliary contact → 38</li> </ul> <p>The following control cables are integrated in addition to electrical interlock:</p> <ul style="list-style-type: none"> <li>Q13: A1 - Q15: 21</li> <li>Q13: 21 - Q15: A1</li> <li>Q13: A2 - Q15: A2</li> </ul>	<b>Product Standards</b> IEC/EN 60947-4-1; UL 508; CSA-C22.2 No.14-05; CE marking <b>Product Standards</b> IEC/EN 60947-4-1; UL 508; CSA-C22.2 No.14-05; CE marking <b>CSA File No.</b> 012528 <b>CSA Class No.</b> 3211-05 <b>NA Certification</b> UL Listed, CSA certified
	DILM17/25/32 mains contactors DILM17/25/32 delta contactors DILM17/25/32 star contactors	<b>DILM32-XSL</b> 283131	1 Off 	<ul style="list-style-type: none"> <li>Consists of the following connection bridges:</li> <li>Mains - delta contactors</li> <li>Delta - star contactors</li> <li>Star-point bridge</li> </ul>	<b>Product Standards</b> IEC/EN 60947-4-1; UL 508; CSA-C22.2 No.14-05; CE marking <b>UL File No.</b> E36332 <b>UL CCN</b> NLRV <b>CSA File No.</b> 012528 <b>CSA Class No.</b> 3211-04 <b>NA Certification</b> UL Listed, CSA certified
	DILM40/50/65 mains contactors DILM40/50/65 delta contactors DILM40/50/65 star contactors	<b>DILM65-XSL</b> 101058	1 Off 		<b>Product Standards</b> IEC/EN 60947-4-1; UL 508; CSA-C22.2 No.14-05; CE marking <b>UL File No.</b> E36332 <b>UL CCN</b> NLRV <b>CSA File No.</b> 012528 <b>CSA Class No.</b> 3211-04 <b>NA Certification</b> UL Listed, CSA certified
	DILM 80/95 mains contactors DILM80/95 delta contactors DILM50/65 star contactors	<b>DILM95-XSL</b> 101486	1 Off		–
DILM 115/150 mains contactors DILM115/150 delta contactors DILM80/95/115 star contactors	<b>DILM150-XSL</b> 101487	1 Off 		<b>Product Standards</b> IEC/EN 60947-4-1; UL 508; CSA-C22.2 No.14-05; CE marking <b>UL File No.</b> E36332 <b>UL CCN</b> NLRV <b>CSA File No.</b> 012528 <b>CSA Class No.</b> 2411-03,3211-04 <b>NA Certification</b> UL Listed, CSA certified	
DILM 185/225 mains contactors DILM185/225 delta contactors DILM115/150 star contactors	<b>DILM225-XSL</b> 101488	1 Off		–	

### DILM...-XRL, DILM...XIP2X Reversing starter wiring kits

#### Main current wiring for reversing combinations

For use with	Part no. Article no.	Price See price list	Std. pack	Notes	Information relevant for export to North America
	DILM7	<b>DILM12-XRL</b> 283108	1 Off  	<ul style="list-style-type: none"> <li>Designed for tool-less plug connection</li> <li>As auxiliary contact DILA-XHIT...use → 38</li> </ul> The following control cables are integrated in addition to electrical interlock: <ul style="list-style-type: none"> <li>Q11: A1 - Q12: 21</li> <li>Q11: 21 - Q12: A1</li> <li>Q11: A2 - Q12: A2</li> </ul>	<b>Product Standards</b> IEC/EN 60947-4-1; UL 508; CSA-C22.2 No.14-05; CE marking E36332 <b>UL File No.</b> UL CCN <b>CSA File No.</b> CSA Class No. <b>NA Certification</b> UL Listed, CSA certified
	DILM9				
	DILM12				
	DILM17	<b>DILM32-XRL</b> 283109	1 Off  	-	<b>Product Standards</b> IEC/EN 60947-4-1; UL 508; CSA-C22.2 No.14-05; CE marking E36332 <b>UL File No.</b> UL CCN <b>CSA File No.</b> CSA Class No. <b>NA Certification</b> UL Listed, CSA certified
	DILM25				
	DILM32				
	DILM40	<b>DILM65-XRL</b> 101057	1 Off  	-	<b>UL File No.</b> UL CCN <b>CSA File No.</b> CSA Class No. <b>NA Certification</b> UL Listed, CSA certified
	DILM50				
	DILM65				
	DILM80	<b>DILM150-XRL</b> 101681	1 Off  	-	<b>Product Standards</b> IEC/EN 60947-4-1; UL 508; CSA-C22.2 No.14-05; CE marking E36332 <b>UL File No.</b> UL CCN <b>CSA File No.</b> CSA Class No. <b>NA Certification</b> UL Listed, CSA certified
	DILM95				
	DILM115				
	DILM150				

### DILM...-XRL, DILM...XIP2X IP2X cover set

For use with	Part no. Article no.	Price See price list	Std. pack	Notes	Information relevant for export to North America
	DILM17	<b>DILM32-XIP2X</b> 118855	1 Off  	Each cover set consists of two three-pole and two single-pole covers.	UL/CSA certification not required
	DILM25				
	DILM32				
	DILM38				
	DILMP32				
	DILMP45				
	DILM40	<b>DILM65-XIP2X</b> 106491	8 Off  	2 covers are required per phase The cover set consists of 8 covers	UL/CSA certification not required
	DILM50				
	DILM65				
	DILM72				
	DILMP63				
	DILMP80				
	DILM80	<b>DILM150-XIP2X</b> 106492	8 Off  		UL/CSA certification not required
	DILM95				
	DILM115				
	DILM150				
	DILM170				
	DILMP125				
	DILMP160				
	DILMP200				
	ZB150				



#### DILM12-XDSBS Three-phase commoning links

Protected against accidental contact, short-circuit proof,  $U_e = 690\text{ V}$ ,  $I_u = 35\text{ A}$  Can be extended by rotating by mounting

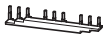

For use with	Part no. Article no.	Price See price list	Std. pack	Notes	Information relevant for export to North America
DILM7 DILM9 DILM12 DILM15	<b>DILM12-XDSB0/3</b> 240084		5 Off 	Suitable for 3 contactors. Length 112 mm	Product Standards IEC/EN 60947-4-1; UL 508; CSA-C22.2 No.14-05; CE marking UL File No. E36332 UL CCN NLRV CSA File No. 012528 CSA Class No. 2411-03 NA Certification UL Listed, CSA certified
DILM7 DILM9 DILM12 DILM15	<b>DILM12-XDSB0/4</b> 240085		5 Off 	Suitable for 4 contactors. Length 157 mm	
DILM7 DILM9 DILM12 DILM15	<b>DILM12-XDSB0/5</b> 240086		5 Off 	Suitable for 5 contactors. Length 202 mm	

#### DILM12-XDSBS Incoming connection block

For use with	Part no. Article no.	Price See price list	Std. pack	Notes	Information relevant for export to North America
DILM7 DILM9 DILM12 DILM15	<b>DILM12-XEK</b> 240083		5 Off 	For three-phase commoning link, protected against accidental contact, $U_e = 690\text{ V}$ , $I_u = 35\text{ A}$ . Terminal capacities: Stranded 2.5...16 mm <sup>2</sup> Flexible with ferrule 2.5...16 mm <sup>2</sup> AWG14...8	Product Standards IEC/EN 60947-4-1; UL 508; CSA-C22.2 No.14-05; CE marking UL File No. E36332 UL CCN NLRV CSA File No. 012528 CSA Class No. 2411-03 NA Certification UL Listed, CSA certified



#### DILM12-XDSBS Adapter plate

Enables clipping on of switches on to DIN rails

For use with	Part no. Article no.	Price See price list	Std. pack	Notes	Information relevant for export to North America
DILM80 DILM95 DILM115 DILM150 DILM170	<b>NZM2-XC75</b> 260215		1 Off 	For top-hat rail 75 mm	Product Standards IEC/EN 60947-4-1; UL 489; CSA-C22.2 No.14-05; CE marking UL File No. E140305 UL CCN DIHS CSA File No. 022086 CSA Class No. 1437-01 NA Certification UL Listed, CSA certified

### DILM32-XTE

#### Electronic timer modules

**On-delayed, Cannot be combined with top mounting auxiliary contacts Incl. suppressor circuits**



**Off-delayed, auxiliary voltage-free Cannot be combined with top mounting auxiliary contacts Incl. suppressor circuits**

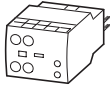

**For star-delta applications Cannot be combined with top mounting auxiliary contacts Incl. suppressor circuits**



	For use with	Circuit symbol	Part no. Article no.	Price See price list	Std. pack	Notes	
24 V AC/DC	DILM7 - DILM32		<b>DILM32-XTEE11(RA24)</b> 101440		1 Off	Time range can be selected	
100 ... 130 V AC	DILMP20 DILMP32-DILMP45 DILA		<b>DILM32-XTEE11(RAC130)</b> 101441		1 Off	0.05 s...1 s 0.5 s...10 s 5 s...100 s	
200 ... 240 V AC			<b>DILM32-XTEE11(RAC240)</b> 101442		1 Off		
24 V AC/DC	DILM7 - DILM32		<b>DILM32-XTED11-1(RA24)</b> 105210		1 Off	Time range 0.05 s...1 s	
24 V AC/DC	DILMP20 DILMP32-DILMP45 DILA		<b>DILM32-XTED11-10(RA24)</b> 104943		1 Off	Time range 0.5 s...10 s	
24 V AC/DC			<b>DILM32-XTED11-100(RA24)</b> 104946		1 Off	Time range 5 s...100 s	
100 ... 130 V AC			<b>DILM32-XTED11-1(RAC130)</b> 105211		1 Off	Time range 0.05 s...1 s	
100 ... 130 V AC			<b>DILM32-XTED11-10(RAC130)</b> 104944		1 Off	Time range 0.5 s...10 s	
100 ... 130 V AC			<b>DILM32-XTED11-100(RAC130)</b> 104947		1 Off	Time range 5 s...100 s	
200 ... 240 V AC			<b>DILM32-XTED11-1(RAC240)</b> 105212		1 Off	Time range 0.05 s...1 s	
200 ... 240 V AC			<b>DILM32-XTED11-10(RAC240)</b> 104945		1 Off	Time range 0.5 s...10 s	
200 ... 240 V AC			<b>DILM32-XTED11-100(RAC240)</b> 104948		1 Off	Time range 5 s...100 s	
24 V AC/DC	DILM7 - DILM32			<b>DILM32-XTEY20(RA24)</b> 101446		1 Off	Changeover time 1...30 s
100 ... 130 V AC	DILMP20 DILMP32-DILMP45 DILA			<b>DILM32-XTEY20(RAC130)</b> 101447		1 Off	50 ms changeover delay Sample circuit → Page 92
200 ... 240 V AC				<b>DILM32-XTEY20(RAC240)</b> 101448		1 Off	

#### Information relevant for export to North America





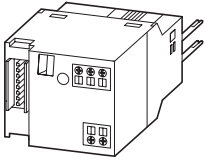

Product Standards	IEC/EN 60947-4-1; UL 508; CSA-C22.2 No.14-05; CE marking
UL File No.	E29184
UL CCN	NKCR
CSA File No.	012528
CSA Class No.	3211-03
NA Certification	UL Listed, CSA certified

1









### DIL-SWD..., DILM12-XMC SWD contactor modules

SmartWire-DT® module for installation on contactors. One module per contactor

	For use with	Part no. Article no.	Price See price list	Std. pack	Notes
Two digital inputs for potential-free contacts. 1 electrical interlock for the surface mounting of reversing starters. Messages: Contactor switch status, status of the digital inputs 1 and 2. Commands: Contactor actuation	DILM(C)7... - DILM(C)32 DILM38 DILA	<b>DIL-SWD-32-001<sup>1)</sup></b> 118560		5 Off  	<ul style="list-style-type: none"> <li>Take into account the max. current consumption of the contactor coils per SmartWire-DT® line.</li> <li>A2 terminals must not be bridged.</li> <li>Wiring sets DILM 12-XRL and PKZM0-XRM12 cannot be used.</li> <li>Connection terminals for electrical interlocking are not suitable for safety technology.</li> </ul>
Two digital inputs for potential-free contacts. 1 electrical interlock for the surface mounting of reversing starters. 1-0-A switch for manual or automatic operation. Messages: contactor switching position, status of the digital inputs 1 and 2, 1-0-A switch position. Commands: Contactor actuation	DILM(C)7... - DILM(C)32 DILM38 DILA	<b>DIL-SWD-32-002<sup>1)</sup></b> 118561		5 Off  	

### DIL-SWD..., DILM12-XMC Wiring set for motor feeder plug

For use with	Part no. Article no.	Price See price list	Std. pack	Notes
DILM(C)7 DILM(C)9 DILM(C)12 DILM(C)15	<b>DILM12-XMCE<sup>2)</sup></b> 121764		5 Off  	35x7.5 (15) mm mounting rail (as per DIN EN 60715) with PE function required. For connection of: PE 0.75 – 4 mm <sup>2</sup>
DILM(C)7 DILM(C)9 DILM(C)12 DILM(C)15	<b>DILM12-XMCP/E<sup>2)</sup></b> 121769		1 Off  	35x7.5 (15) mm mounting rail (as per DIN EN 60715) with PE function required. For connection of: L1, L2, L3, PE 0.75 – 2.5 mm <sup>2</sup>
PKZM0/PKE + DILM(C)7 PKZM0/PKE + DILM(C)9 PKZM0/PKE + DILM(C)12 PKZM0/PKE + DILM(C)15 MSC-D(E)-...-M7... MSC-D(E)-...-M9... MSC-D(E)-...-M15...	<b>DILM12-XMCP/T<sup>2)</sup></b> 121770		1 Off  	For connection of: L1, L2, L3, PE 0.75 – 2.5 mm <sup>2</sup>

#### PE module with contact plate

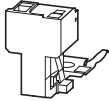

#### Motor plate with PE module and contact plate

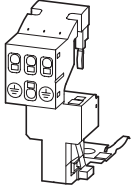

#### Motor plate with PE module and contact plate











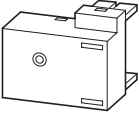

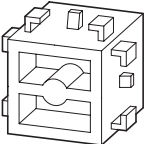
#### Information relevant for export to North America

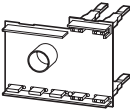

- |  |   |
|--|---|
| 1) NA Certification                      | Request filed for UL and CSA  |
| 2) Product Standards<br>NA Certification | IEC/EN 60947-4-1; UL 508; CSA-C22.2 No. 14-05; CE marking<br>Request filed for UL and CSA |

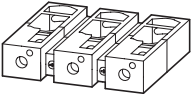
## DILM...-X...

	For use with	Part no. Article no.	Price See price list	Std. pack	Notes	Information relevant for export to North America 
<b>Motor suppressor module</b>						
Can be used at 380...575 V 50/60 Hz.						
	DILM7 - DILM15	<b>DILM12-XMSM</b> 109399		4 Off 	<ul style="list-style-type: none"> <li>• Tool-less version using tool-less plug connection</li> <li>• RC suppressor</li> <li>• Ambient temperature -25...+60 °C, open.</li> <li>• Insulated material, difficult to ignite according to UL 94.</li> <li>• Weight = 0.05 kg.</li> <li>• UL/CSA approval applied for</li> </ul>	Product Standards IEC/EN 60947-4-1; UL 508; CE marking UL File No. E300273 UL CCN NMTR2 NA Certification UL Listed
<b>Test block</b>						
Suitable for switching on contactor off-load						
	DILM7 - DILM38 DILA	<b>DILM32-XMAN</b> 110955		1 Off 	–	UL/CSA certification not required
<b>Printed board contact</b>						
For the adaption of a control circuit on a printed-circuit board						
	DILM7 - DILM15 DILA	<b>DILM12-XPBC</b> 109400		4 Off	–	–
<b>Load resistor</b>						
For DC contactors in order to increase power consumption						
	DILM17 DILM25 DILM32 DILM38 DILMP32 DILMP45	<b>DILM32-XSPLW24</b> 112419		1 Off 	Installed in a suppressor circuit enclosure. Required when using special PLC outputs for actuation, e.g.: Beckhoff safety controllers.	Product Standards IEC/EN 60947-4-1; CSA-C22.2 No.14-05; CE marking CSA File No. 225135 CSA Class No. 3211-07 NA Certification CSA certified
<b>Extension terminals</b>						
	DILM80 DILM95 DILM115 DILM150 DILM170	<b>DILM150-XZK</b> 104486		10 Off 	Can be fitted on every main terminal of the contactor. Connection options: maximum 2 x 4 mm <sup>2</sup> solid maximum 2 x 2.5 mm <sup>2</sup> flexible with ferrule	Product Standards IEC/EN 60947-4-1; UL 508; CSA-C22.2 No.14-05;CE marking UL File No. E29184 UL CCN NKCR CSA File No. 012528 CSA Class No. 2411-03, 2411-04 NA Certification UL Listed, CSA certified
<b>Cable terminal block</b>						
With control circuit terminal Consisting of three flat ribbon terminals						
	DILM250 DILM300A DILM400	<b>DILM400-XKU-S</b> 208293		1 Off 	Connection options: round conductors, flexible and stranded, ribbon cables.	Product Standards IEC/EN 60947-4-1; UL 508; CSA-C22.2 No.14-05;CE marking UL File No. E29184 UL CCN NKCR CSA File No. 012528 CSA Class No. 3211-04 NA Certification UL Listed, CSA certified

# 1.1

## Contactors relays, contactors

### Accessories

1

#### DILM...-XK... Flat strip conductor terminal kit

With control cable connection

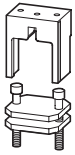

For use with	Part no. Article no.	Price See price list	Std. pack	Notes	Information relevant for export to North America  
DILM580 DILM650 DILM750 DILM820	<b>DILM820-XKB-S</b> 208295		1 Off	Connection options: ribbon cables	

#### DILM...-XK... Connection terminal sets for North America

Consist of three individual terminals

Conductor material	Cross-section X number of cores mm <sup>2</sup>	For use with	Part no. Article no.	Price See price list	Std. pack	Notes	Information relevant for export to North America  
Copper, aluminum	2 x (AWG4 ... MCM500)	DILM500/22	<b>DILM500-XK-CNA</b> 232192		1 Off  	Including cover With control cable connec- tion	Product Standards IEC/EN 60947-4-1; UL 508; CSA-C22.2 No.14-05; CE marking E29184 NKCR UL File No. UL CCN CSA File No. CSA Class No. NA Certification
Copper, aluminum	4 x (AWG2 ... MCM500)	DILM580/22 DILM650/22 DILM750/22 DILM820/22	<b>DILM820-XK-CNA</b> 232194		1 Off  		UL File No. UL CCN CSA File No. CSA Class No. NA Certification

## DILM...-XHB, DILM...-XAB

Description	For use with	Part no. Article no.	Price See price list	Std. pack	Notes	Information relevant for export to North America 
<b>Sealable shrouds</b>						
Transparent						
	DILM32-XTE...	<b>DILM32-XTEPLH</b> 101449		1 Off	-	-
<b>Device labelling, label sheet</b>						
7.5 x 17 mm Colour: yellow HKS 3 (≈ RAL 1018)						
	Labelling with laser printer, plotter, film plotter, copier	<b>XGKE-GE</b> 207517		25 Off 	1 off = 1 sheet 240 labels per sheet 1 sheet = DIN A4, Can be split into two DIN A5 sheets	UL/CSA certification not required
<b>Covers</b>						
Terminal cover						
	DILM185A DILM225A	<b>DILM225A-XHB</b> 139560		1 Off 	To provide terminals with protection against accidental contact vertical from the front	UL/CSA certification not required
	DILM250 DILM300A DILM400	<b>DILM400-XHB</b> 208287		1 Off 		
	DILM500	<b>DILM500-XHB</b> 208286		1 Off 		
	DILM580 DILM650	<b>DILM650-XHB</b> 208285		1 Off 		
	DILM750 DILM820, DILM1000	<b>DILM820-XHB</b> 208284		1 Off 		
	<b>Shroud for star-point bridge</b>					
	DILM400-XS1	<b>DILM400-XHBS1</b> 101687		1 Off 	Can be combined with star-delta wiring kits DILM250-XSL and DILM400-XSL.	UL/CSA certification not required
<b>Auxiliary contact seat cover</b>						
	DILM7 - DILM38 DILMP32 DILMP45 DILA DILL	<b>DILM32-XAB</b> 129538		10 Off 	For preventing manual actuation. Cannot be combined with additional surface mounting accessories	UL/CSA certification not required
	DILM40 - DILM170 DILMP63 - DILMP200	<b>DILM150-XAB</b> 121712		10 Off 		
<b>Suppressor circuits for vacuum contactors (on load side)</b>						
	DILM580 DILM650 DILM750 DILM820 DILM1000	<b>DILM1000-XSM</b> 125947		1 Off 	For damping the cutout overvoltage when switching off inductive loads.	NA Certification Request filed for UL and CSA
	DILH2000 DILH2200 DILH2600	<b>DILH2600-XSM</b> 125946		1 Off 		

# 1.1

## Contactors relays, contactors

### Accessories

1



#### DILM...-XSP... Amplifier module for separate mounting

Input with integrated suppressor circuit for overvoltage limitation

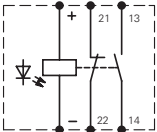
Rated operational current		Actuating voltage	Actuating current	Circuit symbol	For use with	Part no. Article no.	Price See price list	Std. pack	Information relevant for export to North America
AC-15	DC								
230 V	400 V	220 V							
$I_e$	$I_e$	$I_e$	$U_s$	$I$					
A	A	A	V DC	mA					
2	2	0.03	24	25		...DILM DIMLP... DILL... DILK... <b>ETS4-VS3</b> 083094		1 Off 	Product Standards IEC/EN 60947-4-1; UL 508; CSA-C22.2 No. 14-05; CE marking E36332 NLRV UL File No. UL CCN CSA File No. CSA Class No. NA Certification UL Listed, CSA certified

**Notes** Contactor coils with rated operational current > 2 A must be actuated via the DILER-G mini contactor relay.  
Rated operational current DC:  
Making and breaking conditions DC-13, time L/R 300ms

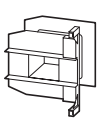

#### DILM...-XSP... Individual coils

For use with	DC voltage	Part no. Article no.	Prices See price list	AC voltage	Part no. Article no.	Price See price list	Std. pack	Notes
DILM17 DILM25 DILM32 DILM38		<b>DILM32-XSP(RDC24)<sup>1)</sup></b> 281155		<b>DILM32-XSP(230V50Hz,240V60Hz)</b>	281141		1 Off 	For additional actuating voltages → Page 75
DILM40 DILM50 DILM65 DILM72		<b>DILM65-XSP(RDC24)<sup>1)</sup></b> 281185		<b>DILM65-XSP(230V50Hz,240V60Hz)</b>	281171		1 Off 	
DILM80 DILM95		<b>DILM95-XSP(RDC24)<sup>1)</sup></b> 230080		<b>DILM95-XSP(230V50Hz,240V60Hz)</b>	230062		1 Off 	
DILM115 DILM150 DILM170		<b>DILM150-XSP(RDC24)<sup>1)</sup></b> 230115		<b>DILM150-XSP(RAC240)<sup>1)</sup></b>	230112		1 Off 	
DILM185A DILM225A		<b>DILM225A-XSP(RDC24)<sup>1)</sup></b> 139568		<b>DILM225A-XSP(RAC240)<sup>1)</sup></b>	139565		1 Off 	

**Notes** <sup>1)</sup> Incl. electronic module

#### Information relevant for export to North America

	Product Standards	IEC/EN 60947-4-1; UL 508; CSA-C22.2 No.14-05; CE marking
	UL File No.	E29096
	UL CCN	NLDX
	CSA File No.	012528
	CSA Class No.	2411-03, 3211-04
	NA Certification	UL Listed, CSA certified

## DILM...-XSP/E... Electronic modules including coils

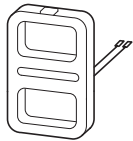
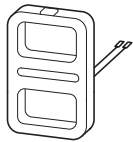

For use with	DC voltage Part no. Article no.	Price See price list	AC voltage Part no. Article no.	Price See price list	Std. pack	Notes
DILM250 DILM300A	<b>DILM250-XSP/E(RA250)</b> <sup>1)</sup> 208252		<b>DILM250-XSP/E(RA250)</b> <sup>1)</sup> 208252		1 Off 	For additional actuating voltages → Page 77
DILM400 DILM500	<b>DILM500-XSP/E(RA250)</b> <sup>1)</sup> 208256		<b>DILM500-XSP/E(RA250)</b> <sup>1)</sup> 208256		1 Off 	
DILM580 DILM650 DILM750 DILM820 DILM1000	<b>DILM1000-XSP/E(RA250)</b> <sup>1)</sup> 289145		<b>DILM1000-XSP/E(RA250)</b> <sup>1)</sup> 289145		1 Off 	
DILH1400	–		<b>DILH1400-XSP/E(RAW250)</b> <sup>2)</sup> 289161		1 Off 	
DILM250-S DILM300A-S	–		<b>DILM250-S-XSP/E(220-240V50/60Hz)</b> <sup>2)</sup> 274202		1 Off 	
DILM400-S DILM500-S	–		<b>DILM500-S-XSP/E(220-240V50/60Hz)</b> <sup>2)</sup> 274205		1 Off 	

1)

### Information relevant for export to North America



Product Standards	IEC/EN 60947-4-1; UL 508; CSA-C22.2 No.14-05; CE marking
UL File No.	E29096
UL CCN	NLDX
CSA File No.	1017510
CSA Class No.	3211-04
NA Certification	UL Listed, CSA certified

2)

### Information relevant for export to North America



Product Standards	IEC/EN 60947-4-1; UL 508; CSA-C22.2 No.14-05; CE marking
UL File No.	E29096
UL CCN	NLDX
CSA File No.	012528
CSA Class No.	3211-04
NA Certification	UL Listed, CSA certified



# 1.1 Contactor monitoring devices

## 1 Description, ordering



### General

For safety-related off switching to safety category 3 and 4 according to EN 954-1, at present two contactors must be used in series. Especially with larger contactors this is an expensive solution.

### Application

This is where the CMD can be used. The function of the CMD is to monitor the main contacts of a contactor against welding. For this the control voltage of the contactor is compared with the state of the main contacts which is reliably monitored using a mirror contact (IEC EN 60947-4-1 Annex F). If the coil is de-energized and the contactor does not drop out the CMD trips the upstream circuit-breaker/motor protective circuit breaker/switch-disconnector via a shunt release.

### Safety

The CMD has a safety-compliant design so that in safety combinations with a circuit-breaker/motor protective circuit breaker/switch-disconnector the reliable switch off in the case of a "welded contactor" can be guaranteed. In this application it replaces the series connection of a second contactor. As a component it conforms to safety category 3 according to EN 954-1 and EN ISO 13849.

### Mounting

The CMD can be combined with the following Eaton components:

- Contactors:
  - DILEM
  - DILM7 to DILM150
  - DILM185(-S) to DILM500(-S):
  - DILM580 to DILM1600
  - DILH1400 ... DILH2000
  - SE-1A-PKZ2 and S-PKZ2
- Motor-protective circuit-breakers/circuit-breakers:
  - PKZ2 + U-PKZ2(18VDC)
  - NZM1 + NZM1-XUVL
  - NZM2 + NZM2/3-XUV
  - NZM3 + NZM2/3-XUV
  - NZM4 + NZM4-XUV
  - N1 + NZM1-XUVL
  - N2 + NZM2/3-XUV
  - N3 + NZM2/3-XUV
  - N4 + NZM4-XUV

For the wiring of the CMD the auxiliary N/C contact, mirror contact must be according to IEC/EN 60947-4-1 and the auxiliary N/O contact must be interlocked and opposing according to IEC/EN 60947-5-1. Also the auxiliary N/C contact for the feedback circuit must have a mirror contact function according to IEC/EN 60947-4-1.

### Auxiliary contact requirements per contactor:

	CMD	Self maintaining	Feedback circuit	Electrical interlock
DOL starter	1 N/O + 1 N/C	1S	1 B	
Reversing starter	1 N/O + 1 N/C	1S	1 B	1 B

## Ordering

### CMD contactor monitoring device

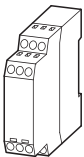

### CMD

Part no. Article no.	Price See Price List	Std. pack
<b>CMD(24VDC)</b> 106170		1 Off
<b>CMD(220-240VAC)</b> 106172		1 Off



# 1.1

## Mini contactor relays, contactor relays

Actuating voltages

### 1 Ordering

#### DILER, DILEEM

AC	DILER-40(...)	DILER-31(...)	DILER-22(...)	DILEEM-10(...)	DILEEM-01(...)
	Article no. <sup>1)</sup>	Article no. <sup>1)</sup>	Article no. <sup>1)</sup>	Article no. <sup>1)</sup>	Article no. <sup>1)</sup>
<b>Standard voltages</b>	See price list	See price list	See price list	See price list	See price list
<b>24V 50Hz</b>	010094	010251	010344	051604	051629
<b>48V 50Hz</b>	010190	010044	010201	051603	051628
<b>240V 50Hz</b>	010478	010300	010138	051602	051627
<b>115V 60Hz</b>	010270	010204	010211	051598	051624
<b>42V 50Hz, 48V 60Hz</b>	–	–	–	051612	051637
<b>110V 50Hz, 120V 60Hz</b>	051756	051765	051774	051611	051636
<b>190V 50Hz, 220V 60Hz</b>	051757	051766	051775	051610	051635
<b>220V 50Hz, 240V 60Hz</b>	051758	051767	051776	051609	051634
<b>230V 50Hz, 240V 60Hz</b>	051759	051768	051777	051608	051633
<b>380V 50Hz, 440V 60Hz</b>	051760	051769	051778	051607	051632
<b>400V 50Hz, 440V 60Hz</b>	051761	051770	051779	051606	051631
<b>415V 50Hz, 480V 60Hz</b>	051762	051771	051780	051605	051630
<b>24V 50/60Hz</b>	021924	021594	021704	051596	051621
<b>42V 50/60Hz</b>	033459	029869	029433	051595	051620
<b>110V 50/60Hz</b>	021961	021624	021871	051592	051618
<b>230V 50/60Hz</b>	052725	052509	052508	056674	058771

#### DILER, DILEEM

DC	DILER-40-G(...)	DILER-31-G(...)	DILER-22-G(...)	DILEEM-10-G(...)	DILEEM-01-G(...)
	Article no. <sup>1)</sup>	Article no. <sup>1)</sup>	Article no. <sup>1)</sup>	Article no. <sup>1)</sup>	Article no. <sup>1)</sup>
<b>Standard voltages</b>	See price list	See price list	See price list	See price list	See price list
<b>12V DC</b>	079711	079761	080728	051644	051649
<b>24V DC</b>	010223	010157	010042	051643	051650
<b>48V DC</b>	010255	010205	010346	051642	051648
<b>110V DC</b>	010287	010253	010043	051640	051646
<b>220V DC</b>	010303	010269	010091	051639	051645

**Notes** <sup>1)</sup> To obtain the article number for ordering, read under selected part number and actuating voltage from the table.  
Devices with dual-voltage coils are to be ordered under a single article number.

## DILEM

AC	DILEM-10(...)	DILEM-01(...)	DILEM12-10(...)	DILEM12-01(...)	DILEM4(...)
	Article no. <sup>1)</sup>	Article no. <sup>1)</sup>	Article no. <sup>1)</sup>	Article no. <sup>1)</sup>	Article no. <sup>1)</sup>
<b>Standard voltages</b>	See price list	See price list	See price list	See price list	See price list
<b>24V 50Hz</b>	010005	010086	127067	127083	014754
<b>48V 50Hz</b>	010020	010294	–	–	–
<b>240V 50Hz</b>	010032	010151	–	–	014305
<b>115V 60Hz</b>	010024	010470	–	–	–
<b>42V 50Hz, 48V 60Hz</b>	051782	051791	–	–	–
<b>110V 50Hz, 120V 60Hz</b>	051783	051792	127072	127088	051801
<b>190V 50Hz, 220V 60Hz</b>	051784	051793	–	–	–
<b>220V 50Hz, 240V 60Hz</b>	051785	051794	–	–	051803
<b>230V 50Hz, 240V 60Hz</b>	051786	051795	–	–	051804
<b>380V 50Hz, 440V 60Hz</b>	051787	051796	–	–	–
<b>400V 50Hz, 440V 60Hz</b>	051788	051797	–	–	051806
<b>415V 50Hz, 480V 60Hz</b>	051789	–	–	–	–
<b>24V 50/60Hz</b>	021417	020402	127079	127095	022044
<b>42V 50/60Hz</b>	032174	033233	–	–	–
<b>110V 50/60Hz</b>	021455	020436	127081	127097	–
<b>230V 50/60Hz</b>	052302	051114	127082	127098	052506

## DILEM

DC	DILEM-10-G(...)	DILEM-01-G(...)	DILEM12-10-G(...)	DILEM12-01-G(...)	DILEM4-G(...)
	Article no. <sup>1)</sup>	Article no. <sup>1)</sup>	Article no. <sup>1)</sup>	Article no. <sup>1)</sup>	Article no. <sup>1)</sup>
<b>Standard voltages</b>	See price list	See price list	See price list	See price list	See price list
<b>12V DC</b>	079594	079642	–	–	079680
<b>24V DC</b>	010213	010343	127132	127137	012701
<b>48V DC</b>	010245	010496	–	–	–
<b>110V DC</b>	010309	010136	–	–	–
<b>220V DC</b>	010325	010168	–	–	–

### Notes

<sup>1)</sup> To obtain the article number for ordering, read under selected part number and actuating voltage from the table. Devices with **dual-voltage coils** are to be ordered under a **single** article number.

# 1.1

## Contactor relays

Actuating voltages

1

### DILA

AC

	With screw terminals			With Spring-loaded terminals		
	DILA-40(...)	DILA-31(...)	DILA-22(...)	DILAC-40(...)	DILAC-31(...)	DILAC-22(...)
	Article no. <sup>1)</sup>	Article no. <sup>1)</sup>	Article no. <sup>1)</sup>	Article no. <sup>1)</sup>	Article no. <sup>1)</sup>	Article no. <sup>1)</sup>
<b>Standard voltages</b>	See price list	See price list	See price list	See price list	See price list	See price list
<b>24V 50Hz</b>	276316	276351	276386	276431	276463	276495
<b>240V 50Hz</b>	276318	276353	276388	–	–	–
<b>110V 50Hz 120V 60Hz</b>	276326	276361	276396	276438	276470	276502
<b>190V 50Hz 220V 60Hz</b>	276327	276362	276397	–	–	–
<b>220V 50Hz 240V 60Hz</b>	276328	276363	276398	–	–	–
<b>230V 50Hz 240V 60Hz</b>	276329	276364	276399	276441	276473	276505
<b>380V 50Hz 440V 60Hz</b>	276330	276365	276400	–	–	–
<b>400V 50Hz 440V 60Hz</b>	276331	276366	276401	–	–	–
<b>24V 50Hz/60Hz</b>	276333	276368	276403	276445	276477	276509
<b>42V 50Hz/60Hz</b>	276334	276369	276404	–	–	–
<b>110V 50Hz/60Hz</b>	276335	276370	276405	–	–	–
<b>220V 50Hz/60Hz</b>	276336	276371	276406	–	–	–
<b>230V 50Hz/60Hz</b>	276337	276372	276407	276449	276481	276513
Special voltages other than the already shown normal voltages <sup>2)</sup>	See price list	See price list	See price list	See price list	See price list	See price list
<b>...V 50Hz(12-500V)<sup>3)</sup></b>	276341	276376	276411	276453	276485	276517
<b>...V 60Hz(12-600V)<sup>3)</sup></b>	276342	276377	276412	276454	276486	276518

### DILA

DC

	With screw terminals			With Spring-loaded terminals		
	DILA-40(...)	DILA-31(...)	DILA-22(...)	DILAC-40(...)	DILAC-31(...)	DILAC-22(...)
	Article no. <sup>1)</sup>	Article no. <sup>1)</sup>	Article no. <sup>1)</sup>	Article no. <sup>1)</sup>	Article no. <sup>1)</sup>	Article no. <sup>1)</sup>
<b>Standard voltages</b>	See price list	See price list	See price list	See price list	See price list	See price list
<b>24V DC</b>	276344	276379	276414	276456	276488	276520
<b>48V DC</b>	276345	276380	276415	–	–	–
<b>110V DC</b>	276347	276382	276417	276459	276491	276523
<b>220V DC</b>	276348	276383	276418	276460	276492	276524
Special voltages other than the already shown normal voltages <sup>2)</sup>	See price list	See price list	See price list	See price list	See price list	See price list
<b>...V DC(12-250V)<sup>3)</sup></b>	276349	276384	276419	276461	276493	276525

#### Notes

<sup>1)</sup> The article number is a combination of part no. and operating voltage devices with dual-voltage coils can be ordered under a single article no.

<sup>2)</sup> With non-standard voltages the required actuating voltage from the defined range (...-...V) must be stated.

<sup>3)</sup> Minimum order quantity 10 units

**DILM**

AC	DILM7-10 (...)	DILM7-01 (...)	DILM9-10 (...)	DILM9-01 (...)	DILM12-10 (...)	DILM12-01 (...)	DILM15-10 (...)	DILM15-01 (...)
	Article no. <sup>1)</sup>	Article no. <sup>1)</sup>	Article no. <sup>1)</sup>	Article no. <sup>1)</sup>	Article no. <sup>1)</sup>	Article no. <sup>1)</sup>	Article no. <sup>1)</sup>	Article no. <sup>1)</sup>
<b>Standard voltages</b>	See price list	See price list	See price list	See price list	See price list	See price list	See price list	See price list
<b>24V 50Hz</b>	276537	276572	276677	276712	276817	276852	290045	290080
<b>240V 50Hz</b>	276539	276574	276679	276714	276819	276854	–	–
<b>42V 50Hz</b>	276546	–	276686	–	276826	–	–	–
<b>48V 60Hz</b>								
<b>110V 50Hz</b>	276547	276582	276687	276722	276827	276862	290055	290090
<b>120V 60Hz</b>								
<b>190V 50Hz</b>	276548	276583	276688	276723	276828	276863	–	–
<b>220V 60Hz</b>								
<b>220V 50Hz</b>	276549	276584	276689	276724	276829	276864	–	–
<b>240V 60Hz</b>								
<b>230V 50Hz</b>	276550	276585	276690	276725	276830	276865	290058	290093
<b>240V 60Hz</b>								
<b>380V 50Hz</b>	276551	276586	276691	276726	276831	276866	–	–
<b>440V 60Hz</b>								
<b>400V 50Hz</b>	276552	276587	276692	276727	276832	276867	–	–
<b>440V 60Hz</b>								
<b>415V 50Hz</b>	276553	–	276693	–	276833	–	–	–
<b>480V 60Hz</b>								
<b>24V 50Hz/60Hz</b>	276554	276589	276694	276729	276834	276869	290062	290097
<b>42V 50Hz/60Hz</b>	276555	276590	276695	276730	276835	276870	–	–
<b>110V 50Hz/60Hz</b>	276556	276591	276696	276731	276836	276871	–	–
<b>220V 50Hz/60Hz</b>	276557	276592	276697	276732	276837	276872	–	–
<b>230V 50Hz/60Hz</b>	276558	276593	276698	276733	276838	276873	290066	290101
Special voltages other than the already shown normal voltages <sup>2)</sup>	See price list	See price list	See price list	See price list	See price list	See price list	See price list	See price list
<b>...V 50Hz (12 – 600V)<sup>3)</sup></b>	276562	276597	276702	276737	276842	276877	290070	290105
<b>...V 60Hz (12 – 600V)<sup>3)</sup></b>	276563	276598	276703	276738	276843	276878	290071	290106

**DILM**

DC	DILM7-10 (...)	DILM7-01 (...)	DILM9-10 (...)	DILM9-01 (...)	DILM12-10 (...)	DILM12-01 (...)	DILM15-10 (...)	DILM15-01 (...)
	Article no. <sup>1)</sup>	Article no. <sup>1)</sup>	Article no. <sup>1)</sup>	Article no. <sup>1)</sup>	Article no. <sup>1)</sup>	Article no. <sup>1)</sup>	Article no. <sup>1)</sup>	Article no. <sup>1)</sup>
<b>Standard voltages</b>	See price list	See price list	See price list	See price list	See price list	See price list	See price list	See price list
<b>24V DC</b>	276565	276600	276705	276740	276845	276880	290073	290108
<b>48V DC</b>	276566	276601	276706	276741	276846	276881	–	–
<b>110V DC</b>	276568	276603	276708	276743	276848	276883	–	–
<b>220V DC</b>	276569	276604	276709	276744	276849	276884	–	–
Special voltages other than the already shown normal voltages <sup>2)</sup>	See price list	See price list	See price list	See price list	See price list	See price list	See price list	See price list
<b>...V DC (12-250V)<sup>3)</sup></b>	276570	276605	276710	276745	276850	276885	290078	290113

**Notes**

- <sup>1)</sup> To obtain the article number for ordering, read under selected part number and actuating voltage from the table. devices with dual-voltage coils can be ordered under a single article no.
- <sup>2)</sup> With non-standard voltages the required actuating voltage from the defined range (...–...V) must be stated.
- <sup>3)</sup> Minimum order quantity 10 units

## 1 DILM

AC	DILM17-10 (...)	DILM17-01 (...)	DILM25-10 (...)	DILM25-01 (...)	DILM32-10 (...)	DILM32-01 (...)	DILM38-10(...) (...)	DILM38-01(...) (...)
	Article no. <sup>1)</sup>	Article no. <sup>1)</sup>	Article no. <sup>1)</sup>	Article no. <sup>1)</sup>	Article no. <sup>1)</sup>	Article no. <sup>1)</sup>	Article no. <sup>1)</sup>	Article no. <sup>1)</sup>
<b>Standard voltages</b>	See price list	See price list	See price list	See price list	See price list	See price list	See price list	See price list
<b>24V 50Hz</b>	276991	277023	277119	277151	277247	277279	112378	112446
<b>240V 50Hz</b>	276993	–	277121	–	277249	–	112420	–
<b>42V 50Hz</b>	277000	–	277128	–	277256	–	112424	–
<b>48V 60Hz</b>								
<b>110V 50Hz</b>	277001	277033	277129	277161	277257	277289	112425	112454
<b>120V 60Hz</b>								
<b>190V 50Hz</b>	277002	–	277130	–	277258	–	112426	–
<b>220V 60Hz</b>								
<b>220V 50Hz</b>	277003	–	277131	–	277259	–	112427	–
<b>240V 60Hz</b>								
<b>230V 50Hz</b>	277004	277036	277132	277164	277260	277292	112428	112457
<b>240V 60Hz</b>								
<b>380V 50Hz</b>	277005	–	277133	–	277261	–	112429	–
<b>440V 60Hz</b>								
<b>400V 50Hz</b>	277006	277038	277134	277166	277262	277294	112430	112459
<b>440V 60Hz</b>								
<b>415V 50Hz</b>	277007	–	277135	–	277263	–	112431	–
<b>480V 60Hz</b>								
<b>24V 50Hz/60Hz</b>	277008	277040	277136	277168	277264	277296	112432	112461
<b>42V 50Hz/60Hz</b>	277009	–	277137	–	277265	–	112433	–
<b>110V 50Hz/60Hz</b>	277010	277042	277138	277170	277266	277298	112434	112463
<b>220V 50Hz/60Hz</b>	277011	277043	277139	277171	277267	277299	112435	112464
<b>230V 50Hz/60Hz</b>	277012	277044	277140	277172	277268	277300	112436	112465
Special voltages other than the already shown normal voltages <sup>2)</sup>	See price list	See price list	See price list	See price list	See price list	See price list	See price list	See price list
<b>...V 50Hz (24 – 600V)</b>	277016 <sup>7)</sup>	277048 <sup>7)</sup>	277144 <sup>7)</sup>	277176 <sup>7)</sup>	277272 <sup>7)</sup>	277304 <sup>8)</sup>	112440 <sup>7)</sup>	112468 <sup>7)</sup>
<b>...V 60Hz (24 – 600V)</b>	277017 <sup>7)</sup>	277049 <sup>7)</sup>	277145 <sup>7)</sup>	277177 <sup>7)</sup>	277273 <sup>7)</sup>	277305 <sup>8)</sup>	112441 <sup>7)</sup>	112469 <sup>7)</sup>

## DILM

DC	DILM17-10(...)	DILM17-01(...)	DILM25-10(...)	DILM25-01(...)	DILM32-10(...)	DILM32-01(...)	DILM38-10(...)	DILM38-01(...)
	Article no. <sup>1)</sup>	Article no. <sup>1)</sup>	Article no. <sup>1)</sup>	Article no. <sup>1)</sup>	Article no. <sup>1)</sup>	Article no. <sup>1)</sup>	Article no. <sup>1)</sup>	Article no. <sup>1)</sup>
<b>Standard voltages</b>	See price list	See price list	See price list	See price list	See price list	See price list	See price list	See price list
<b>RDC 24<sup>3)</sup></b>	277018	277050	277146	277178	277274	277306	112442	112470
<b>RDC 60<sup>4)</sup></b>	277019	277051	277147	277179	277275	277307	112443	112471
<b>RDC 130<sup>5)</sup></b>	277020	277052	277148	277180	277276	277308	112444	112472
<b>RDC 240<sup>6)</sup></b>	277021	277053	277149	277181	277277	277309	112445	112473

## Notes

- <sup>1)</sup> To obtain the article number for ordering, read under selected part number and actuating voltage from the table. devices with dual-voltage coils can be ordered under a single article no.
- <sup>2)</sup> With non-standard voltages the required actuating voltage from the defined range (...–...V) must be stated.
- <sup>3)</sup> 24 – 27 V DC
- <sup>4)</sup> 48 – 60 V DC
- <sup>5)</sup> 110 – 130 V DC
- <sup>6)</sup> 200 – 240 V DC
- <sup>7)</sup> Minimum order quantity 10 units
- <sup>8)</sup> Minimum order quantity 5 units

**DILM**

AC	DILM40(...)	DILM50(...)	DILM65(...)	DILM72(...)
	Article no. <sup>1)</sup>	Article no. <sup>1)</sup>	Article no. <sup>1)</sup>	Article no. <sup>1)</sup>
<b>Standard voltages</b>	See price list	See price list	See price list	See price list
<b>24V 50Hz</b>	277753	277817	277881	–
<b>240V 50Hz</b>	277755	277819	277883	109183
<b>42V 50Hz</b> <b>48V 60Hz</b>	277762	277826	277890	–
<b>110V 50Hz</b> <b>120V 60Hz</b>	277763	277827	277891	109191
<b>190V 50Hz</b> <b>220V 60Hz</b>	277764	277828	277892	–
<b>220V 50Hz</b> <b>240V 60Hz</b>	277765	277829	277893	–
<b>230V 50Hz</b> <b>240V 60Hz</b>	277766	277830	277894	107670
<b>380V 50Hz</b> <b>440V 60Hz</b>	277767	277831	277895	–
<b>400V 50Hz</b> <b>440V 60Hz</b>	277768	277832	277896	109195
<b>415V 50Hz</b> <b>480V 60Hz</b>	277769	277833	277897	–
<b>24V 50Hz/60Hz</b>	277770	277834	277898	109197
<b>42V 50Hz/60Hz</b>	277771	277835	277899	–
<b>110V 50Hz/60Hz</b>	277772	277836	277900	109199
<b>220V 50Hz/60Hz</b>	277773	277837	277901	109200
<b>230V 50Hz/60Hz</b>	277774	277838	277902	109201
Special voltages other than the already shown normal voltages <sup>2)</sup>	See price list	See price list	See price list	See price list
<b>...V 50Hz (24 – 600V)</b>	277778 <sup>8)</sup>	277842 <sup>8)</sup>	277906 <sup>8)</sup>	109205 <sup>7)</sup>
<b>...V 60Hz (24 – 600V)</b>	277779 <sup>8)</sup>	277843 <sup>8)</sup>	277907 <sup>8)</sup>	109206 <sup>7)</sup>

**DILM**

DC	DILM40(...)	DILM50(...)	DILM65(...)	DILM72(...)
	Article no. <sup>1)</sup>	Article no. <sup>1)</sup>	Article no. <sup>1)</sup>	Article no. <sup>1)</sup>
<b>Standard voltages</b>	See price list	See price list	See price list	See price list
<b>RDC 24<sup>3)</sup></b>	277780	277844	277908	107671
<b>RDC 60<sup>4)</sup></b>	277781	277845	277909	–
<b>RDC 130<sup>5)</sup></b>	277782	277846	277910	–
<b>RDC 240<sup>6)</sup></b>	277783	277847	277911	109209

**Notes**

- <sup>1)</sup> To obtain the article number for ordering, read under selected part number and actuating voltage from the table.  
devices with dual-voltage coils can be ordered under a single article no.
- <sup>2)</sup> With non-standard voltages the required actuating voltage from the defined range (...–...V) must be stated.
- <sup>3)</sup> 24 – 27 V DC
- <sup>4)</sup> 48 – 60 V DC
- <sup>5)</sup> 110 – 130 V DC
- <sup>6)</sup> 200 – 240 V DC
- <sup>7)</sup> Minimum order quantity 10 units



## DILM

AC	DILM80 (...)	DILM95 (...)
	Article no. <sup>1)</sup>	Article no. <sup>1)</sup>
	See price list	See price list
<b>Standard voltages</b>		
<b>24 V 50 Hz</b>	235904	239467
<b>240V 50Hz</b>	235910	239469
<b>42V 50Hz 48V 60Hz</b>	239394	239476
<b>110V 50Hz 120V 60Hz</b>	239399	239477
<b>190V 50Hz 220V 60Hz</b>	239400	239478
<b>220V 50Hz 240V 60Hz</b>	239401	239479
<b>230V 50Hz 240V 60Hz</b>	239402	239480
<b>380V 50Hz 440V 60Hz</b>	239403	239481
<b>400V 50Hz 440V 60Hz</b>	239404	239482
<b>415V 50Hz 480V 60Hz</b>	239405	239483
<b>24V 50Hz/60Hz</b>	239406	239484
<b>42V 50Hz/60Hz</b>	239407	239485
<b>110V 50Hz/60Hz</b>	239408	239486
<b>220V 50Hz/60Hz</b>	239409	239487
<b>230V 50Hz/60Hz</b>	239410	239488
Special voltages other than the already shown normal voltages <sup>2)</sup>	See price list	list
<b>...V 50Hz (24 – 600V) <sup>13)</sup></b>	239414	239504
<b>...V 60Hz (24 – 600V) <sup>13)</sup></b>	239415	239509

## DILM

DC	DILM80 (...)	DILM95 (...)
	Article no. <sup>1)</sup>	Article no. <sup>1)</sup>
	See price list	See price list
<b>Standard voltages</b>		
<b>RDC 24<sup>3)</sup></b>	239416	239510
<b>RDC 60<sup>4)</sup></b>	239417	239511
<b>RDC 130<sup>5)</sup></b>	239418	239512
<b>RDC 240<sup>6)</sup></b>	239419	239513

## DILM

AC	DILM115 (...)	DILM150 (...)	DILM170 (...)	DILM185A/ 22(...)	DILM225A/ 22(...)
	Article no. <sup>1)</sup>	Article no. <sup>1)</sup>	Article no. <sup>1)</sup>	Article no. <sup>1)</sup>	Article no. <sup>1)</sup>
	See price list	See price list	See price list	See price list	See price list
<b>Standard voltages</b>					
<b>RAC 24<sup>7)</sup></b>	239545	239585	107010	139534	139544
<b>RAC 48<sup>8)</sup></b>	239546	239586	107011	139535	139545
<b>RAC 120<sup>9)</sup></b>	239547	239587	107012	139536	139546
<b>RAC 240<sup>10)</sup></b>	239548	239588	107013	139537	139547
<b>RAC 440<sup>11)</sup></b>	239549	239589	107014	139538	139548
<b>RAC 500<sup>12)</sup></b>	239550	239590	107015	139539	139549

## DILM

DC	DILM115 (...)	DILM150 (...)	DILM170 (...)	DILM185A/ 22(...)	DILM225A/ 22(...)
	Article no. <sup>1)</sup>	Article no. <sup>1)</sup>	Article no. <sup>1)</sup>	Article no. <sup>1)</sup>	Article no. <sup>1)</sup>
	See price list	See price list	See price list	See price list	See price list
<b>Standard voltages</b>					
<b>RDC 24<sup>3)</sup></b>	239555	239591	107016	139540	139550
<b>RDC 60<sup>4)</sup></b>	239560	239592	107017	139541	139551
<b>RDC 130<sup>5)</sup></b>	239567	239593	107018	139542	139552
<b>RDC 240<sup>6)</sup></b>	239572	239594	107019	139543	139553

### Notes

- <sup>1)</sup> The article no. results from combining the part no. and the actuating voltage. Devices with dual-voltage coils must be ordered under a single article no.
- <sup>2)</sup> With non-standard voltages the required actuating voltage from the defined range (...-...V) must be stated.
- <sup>3)</sup> 24 - 27 V DC
- <sup>4)</sup> 48 – 60 V DC
- <sup>5)</sup> 110 - 130 V DC
- <sup>6)</sup> 200 - 240 V DC
- <sup>7)</sup> 24 V 50/60 Hz
- <sup>8)</sup> 42 – 48 V 50/60 Hz
- <sup>9)</sup> 100 – 120 V 50/60 Hz
- <sup>10)</sup> 190 – 240 V 50/60 Hz
- <sup>11)</sup> 380 – 440 V 50/60 Hz
- <sup>12)</sup> 480 – 500 V 50/60 Hz
- <sup>13)</sup> Minimum order quantity 5 units

**DILM**

AC	DILMC7-10 (...)	DILMC7-01 (...)	DILMC9-10 (...)	DILMC9-01 (...)	DILMC12-10 (...)	DILMC12-01 (...)	DILMC15-10 (...)	DILMC15-01 (...)
	Article no. <sup>1)</sup>	Article no. <sup>1)</sup>	Article no. <sup>1)</sup>	Article no. <sup>1)</sup>	Article no. <sup>1)</sup>	Article no. <sup>1)</sup>	Article no. <sup>1)</sup>	Article no. <sup>1)</sup>
<b>Standard voltages</b>	See price list	See price list	See price list	See price list	See price list	See price list	See price list	See price list
<b>24 V 50 Hz</b>	277379	277411	277443	277475	277507	277539	293938	293933
<b>110V 50Hz</b>	277386	277418	277450	277482	277514	277546	293908	293943
<b>120V 60Hz</b>								
<b>230V 50Hz</b>	277389	277421	277453	277485	277517	277549	293911	293946
<b>240V 60Hz</b>								
<b>24V 50Hz/60Hz</b>	277393	277425	277457	277489	277521	277553	293915	293950
<b>230V 50Hz/60Hz</b>	277397	277429	277461	277493	277525	277557	293919	293954
Special voltages other than the already shown normal voltages <sup>2)</sup>	See price list	See price list	See price list	See price list	See price list	See price list	See price list	See price list
<b>...V 50Hz (12 – 600V)<sup>6)</sup></b>	277401	277433	277465	277497	277529	277561	293923	293958
<b>...V 60Hz (12 – 600V)<sup>6)</sup></b>	277402	277434	277466	277498	277530	277562	293924	293959

**DILM**

DC	DILMC7-10 (...)	DILMC7-01 (...)	DILMC9-10 (...)	DILMC9-01 (...)	DILMC12-10 (...)	DILMC12-01 (...)	DILMC15-10 (...)	DILMC15-01 (...)
	Article no. <sup>1)</sup>	Article no. <sup>1)</sup>	Article no. <sup>1)</sup>	Article no. <sup>1)</sup>	Article no. <sup>1)</sup>	Article no. <sup>1)</sup>	Article no. <sup>1)</sup>	Article no. <sup>1)</sup>
<b>Standard voltages</b>	See price list	See price list	See price list	See price list	See price list	See price list	See price list	See price list
<b>24V DC</b>	277404	277436	277468	277500	277532	277564	293926	293961
<b>110V DC</b>	277407	277439	277471	277503	277535	277567	293929	293964
<b>220V DC</b>	277408	277440	277472	277504	277536	277568	293930	293965
Special voltages other than the already shown normal voltages <sup>2)</sup>	See price list	See price list	See price list	See price list	See price list	See price list	See price list	See price list
<b>...VDC (12 – 250V)<sup>6)</sup></b>	277409	277441	277473	277505	277537	277569	293931	293966

**DILM**

AC	DILMC17-10 (...)	DILMC17-01(...)	DILMC25-10 (...)	DILMC25-01 (...)	DILMC32-10 (...)	DILMC32-01 (...)
	Article no. <sup>1)</sup>	Article no. <sup>1)</sup>	Article no. <sup>1)</sup>	Article no. <sup>1)</sup>	Article no. <sup>1)</sup>	Article no. <sup>1)</sup>
<b>Standard voltages</b>	See price list	See price list	See price list	See price list	See price list	See price list
<b>24 V 50 Hz</b>	277570	277600	277630	277660	277690	277720
<b>110V 50Hz</b>	277578	277608	277638	277668	277698	277728
<b>120V 60Hz</b>						
<b>230V 50Hz</b>	277581	277611	277641	277671	277701	277731
<b>240V 60Hz</b>						
<b>24V 50Hz/60Hz</b>	277585	277615	277645	277675	277705	277735
<b>220V 50Hz/60Hz</b>	277588	277618	277648	277678	277708	277738
<b>230V 50Hz/60Hz</b>	277589	277619	277649	277679	277709	277739
Special voltages other than the already shown normal voltages <sup>2)</sup>	See price list	See price list	See price list	See price list	See price list	See price list
<b>...V 50Hz (24 – 600V)<sup>6)</sup></b>	277593	277623	277653	277683	277713	277743
<b>...V 60Hz (24 – 600V)<sup>6)</sup></b>	277594	277624	277654	277684	277714	277744

**DILM**

DC	DILMC17-10 (...)	DILMC17-01 (...)	DILMC25-10 (...)	DILMC25-01 (...)	DILMC32-10 (...)	DILMC32-01 (...)
	Article no. <sup>1)</sup>	Article no. <sup>1)</sup>	Article no. <sup>1)</sup>	Article no. <sup>1)</sup>	Article no. <sup>1)</sup>	Article no. <sup>1)</sup>
<b>Standard voltages</b>	See price list	See price list	See price list	See price list	See price list	See price list
<b>RDC 24<sup>3)</sup></b>	277595	277625	277655	277685	277715	277745
<b>RDC 130<sup>4)</sup></b>	277597	277627	277657	277687	277717	277747
<b>RDC 240<sup>5)</sup></b>	277598	277628	277658	277688	277718	277748

**Notes**

- <sup>1)</sup> The article no. results from combining the part no. and the actuating voltage. Devices with dual-voltage coils must be ordered under a single article no.
- <sup>2)</sup> With non-standard voltages the required actuating voltage from the defined range (...-...V) must be stated.
- <sup>3)</sup> 24 - 27 V DC
- <sup>4)</sup> 110 - 130 V DC
- <sup>5)</sup> 200 - 240 V DC
- <sup>6)</sup> Minimum order quantity 10 units

# 1.1

## Contactors Actuating voltages

### 1 DILMP20

AC	DILMP20 (...)	AC	DILMP20 (...)	AC	DILMP20 (...)
	Article no. <sup>1)</sup>		Article no. <sup>1)</sup>		Article no. <sup>1)</sup>
<b>Standard voltages</b>	See price list	<b>Standard voltages</b>	See price list	<b>Non-standard voltages<sup>2)</sup></b>	See price list
<b>240V 50Hz</b>	–	<b>RAC 24<sup>4)</sup></b>	–	<b>...V 50Hz (12 – 600V)<sup>3)</sup></b>	276982
<b>110V 50Hz</b>	276967	<b>RAC 120<sup>5)</sup></b>	–	<b>...V 60Hz (12 – 600V)<sup>3)</sup></b>	276983
<b>120V 60Hz</b>	–	<b>RAC 240<sup>6)</sup></b>	–		
<b>230 V 50Hz</b>	276970				
<b>240V 60Hz</b>	–				
<b>24V 50/60Hz</b>	276974				
<b>230V 50/60Hz</b>	276978				

### DILMP20

DC	DILMP20 (...)	DC	DILMP20 (...)
	Article no. <sup>1)</sup>		Article no. <sup>1)</sup>
<b>Standard voltages</b>	See price list	<b>Non-standard voltages<sup>2)</sup></b>	See price list
<b>24V DC</b>	276985	<b>...V DC (12 – 250V)<sup>3)</sup></b>	276990
<b>RDC 24<sup>7)</sup></b>	–		

#### Notes

- <sup>1)</sup> The article number is a combination of part no. and actuating voltage
- <sup>2)</sup> For non-standard voltages, state the actuating voltage selected from the range (... – ...V) shown.
- <sup>3)</sup> Minimum order quantity: 10 units
- <sup>4)</sup> 24 V 50/60 Hz
- <sup>5)</sup> 100 – 120 V 50/60 Hz
- <sup>6)</sup> 190 – 240 V 50/60 Hz
- <sup>7)</sup> 24 – 27 V DC

DILM...XSP...

AC	DILM32-XSP (...)	DILM65-XSP (...)	DILM95- XSP
	Article no. <sup>1)</sup>	Article no. <sup>1)</sup>	Article no. <sup>1)</sup>
<b>Standard voltages</b>	See price list	See price list	See price list
<b>24V 50Hz</b>	281130	281160	229984
<b>240V 50Hz</b>	281132	281162	229986
<b>24V 60Hz</b>	281134	281164	229988
<b>115V 60Hz</b>	281136	281166	229990
<b>42V 50Hz 48V 60Hz</b>	281137	281167	229994
<b>110V 50Hz 120V 60Hz</b>	281138	281168	230058
<b>190V 50Hz 220V 60Hz</b>	281139	281169	230059
<b>220V 50Hz 240V 60Hz</b>	281140	281170	230061
<b>230V 50Hz 240V 60Hz</b>	281141	281171	230062
<b>380V 50Hz 440V 60Hz</b>	281142	281172	230063
<b>400V 50Hz 440V 60Hz</b>	281143	281173	230064
<b>415V 50Hz 480V 60Hz</b>	281144	281174	230065
<b>24V 50Hz/60Hz</b>	281145	281175	230066
<b>42V 50Hz/60Hz</b>	281146	281176	230067
<b>110V 50Hz/60Hz</b>	281147	281177	230068
<b>220V 50Hz/60Hz</b>	281148	281178	230073
<b>230V 50Hz/60Hz</b>	281149	281179	230074
Special voltages other than the already shown normal-voltages <sup>2)</sup>	See price list	See price list	See price list
<b>...V 50Hz (24 – 600V)</b>	281153 <sup>13)</sup>	281183 <sup>14)</sup>	230078 <sup>14)</sup>
<b>...V 60Hz (24 – 600V)</b>	281154 <sup>13)</sup>	281184 <sup>14)</sup>	230079 <sup>14)</sup>

DILM...XSP...

DC	DILM32-XSP (...)	DILM65-XSP (...)	DILM95- XSP
	Article no. <sup>1)</sup>	Article no. <sup>1)</sup>	Article no. <sup>1)</sup>
<b>Standard voltages</b>	See price list	See price list	See price list
<b>RDC 24<sup>3)</sup></b>	281155	281185	230080
<b>RDC 60<sup>4)</sup></b>	281156	281186	230081
<b>RDC 130<sup>5)</sup></b>	281157	281187	230082
<b>RDC 240<sup>6)</sup></b>	281158	281188	230107

DILM...XSP...

AC	DILM150-XSP (...)	DILM225A-XSP (...)
	Article no. <sup>1)</sup>	Article no. <sup>1)</sup>
<b>Standard voltages</b>	See price list	See price list
<b>RAC 24<sup>7)</sup></b>	230109	139562
<b>RAC 48<sup>8)</sup></b>	230110	139563
<b>RAC 120<sup>9)</sup></b>	230111	139564
<b>RAC 240<sup>10)</sup></b>	230112	139565
<b>RAC 440<sup>11)</sup></b>	230113	139566
<b>RAC 500<sup>12)</sup></b>	230114	139567

DILM...XSP...

DC	DILM150-XSP (...)	DILM225A-XSP (...)
	Article no. <sup>1)</sup>	Article no. <sup>1)</sup>
<b>Standard voltages</b>	See price list	See price list
<b>RDC 24<sup>3)</sup></b>	230115	139568
<b>RDC 60<sup>4)</sup></b>	230116	139569
<b>RDC 130<sup>5)</sup></b>	230117	139570
<b>RDC 240<sup>6)</sup></b>	230122	139571

Notes

- 1) To obtain the article number for ordering, read under selected part number and actuating voltage from the table.  
Devices with dual-voltage coils are to be ordered under a single article number.
- 2) With non-standard voltages the required actuating voltage from the defined range (...–...V) must be stated.
- 3) 24 – 27 V DC
- 4) 48 – 60 V DC
- 5) 110 – 130 V DC
- 6) 200 – 240 V DC
- 7) 24 V 50/60 Hz
- 8) 42 – 48 V 50/60 Hz
- 9) 100 – 120 V 50/60 Hz
- 10) 190 – 240 V 50/60 Hz
- 11) 380 – 440 V 50/60 Hz
- 12) 480 – 500 V 50/60 Hz
- 13) Minimum order quantity 10 units
- 14) Minimum order quantity 5 units

# 1.1

## Contactor for capacitors, contactor

Actuating voltages

### 1 DILK, DILMF

AC	DILK12-11 (...)	DILK20-11 (...)	DILK25-11 (...)	DILK33-10 (...)	DILK50-10 (...)
	Article no. <sup>1)</sup>	Article no. <sup>1)</sup>	Article no. <sup>1)</sup>	Article no. <sup>1)</sup>	Article no. <sup>1)</sup>
<b>Standard voltages</b>	See price list	See price list	See price list	See price list	See price list
<b>110V 50Hz, 120V 60Hz</b>	293985	294007	294029	294051	294073
<b>190V 50Hz, 220V 60Hz</b>	293986	294008	294030	294052	294074
<b>230V 50Hz, 240V 60Hz</b>	293988	294010	294032	294054	294076
<b>400V 50Hz, 440V 60Hz</b>	293990	294012	294034	294056	294078
Special voltages other than the already shown normal voltages <sup>2)</sup>	See price list	See price list	See price list		
<b>... V 50Hz</b> (24 – 600V) <sup>3)</sup>	293997	294019	294041	–	–
<b>... V 60Hz</b> (24 – 600V) <sup>3)</sup>	293998	294020	294042	–	–

#### Notes

- <sup>1)</sup> The article no. results from combining the part no. and the actuating voltage.  
Devices with dual-voltage coils must be ordered under a single article no.
- <sup>2)</sup> With non-standard voltages the required actuating voltage from the defined range (...–...V) must be stated.
- <sup>3)</sup> Minimum order quantity 10 units

**DILM**

**Complete comfort devices**

	<b>DILM250</b> <b>/22(...)</b>	<b>DILM300A</b> <b>/22(...)</b>	<b>DILM400</b> <b>/22(...)</b>	<b>DILM500</b> <b>/22(...)</b>	<b>DILM580</b> <b>/22(...)</b>	<b>DILM650</b> <b>/22(...)</b>	<b>DILM750</b> <b>/22(...)</b>	<b>DILM820</b> <b>/22(...)</b>	<b>DILM1000</b> <b>/22(...)</b>
<b>Voltage variants</b>	Article no. <sup>1)</sup> See price list	Article no. <sup>1)</sup> See price list	Article no. <sup>1)</sup> See price list	Article no. <sup>1)</sup> See price list	Article no. <sup>1)</sup> See price list	Article no. <sup>1)</sup> See price list	Article no. <sup>1)</sup> See price list	Article no. <sup>1)</sup> See price list	Article no. <sup>1)</sup> See price list
<b>RDC 48<sup>2)</sup></b>	208199	139554	208207	208211	–	–	–	–	–
<b>RA 110<sup>3)</sup></b>	208200	139555	208208	208212	208215	208218	208221	208224	–
<b>RA 250<sup>4)</sup></b>	208201	139556	208209	208213	208216	208219	208222	208225	267214
<b>RAC 500<sup>5) 6)</sup></b>	208202	139557	208210	208214	208217	208220	208223	208226	–

**DILM**

**Complete units  
Standard**

	<b>DILM250</b> <b>-S/22(...)</b>	<b>DILM300A</b> <b>-S/22(...)</b>	<b>DILM400</b> <b>-S/22(...)</b>	<b>DILM500</b> <b>-S/22(...)</b>
<b>Voltage variants</b>	Article no. <sup>1)</sup> See price list	Article no. <sup>1)</sup> See price list	Article no. <sup>1)</sup> See price list	Article no. <sup>1)</sup> See price list
<b>110-120V 50/60Hz</b>	274189	139558	274195	274198
<b>220-240V 50/60Hz</b>	274190	139559	274196	274199

**DILM**

**Electronic module, incl. coil, for  
comfort model**

	<b>DILM250-XSP/E(...)</b>	<b>DILM500-XSP/E(...)</b>	<b>DILM1000-XSP/E(...)</b>
<b>Voltage variants</b>	Article no. <sup>1)</sup> See price list	Article no. <sup>1)</sup> See price list	Article no. <sup>1)</sup> See price list
<b>RDC 48<sup>2)</sup></b>	208250	208254	–
<b>RA 110<sup>3)</sup></b>	208251	208255	289146
<b>RA 250<sup>4)</sup></b>	208252	208256	289145
<b>RAC 500<sup>5) 6)</sup></b>	208253	208257	289147

**DILM**

**Electronic module, incl. coil, for  
standard model**

	<b>DILM250-S-XSP/E(...)</b>	<b>DILM500-S-XSP/E(...)</b>
<b>Voltage variants</b>	Article no. <sup>1)</sup> See price list	Article no. <sup>1)</sup> See price list
<b>110-120V 50/60Hz</b>	274201	274204
<b>220-240V 50/60Hz</b>	274202	274205

**Notes**

- <sup>1)</sup> The article no. results from combining the part no. and the voltage variant.
- <sup>2)</sup> 24 – 48 V DC
- <sup>3)</sup> 48 – 110 V 40 – 60 Hz/48 – 110 V DC
- <sup>4)</sup> 110 – 250 V 40 – 60 Hz/110 – 250 V DC
- <sup>5)</sup> 250 – 500 V 40 – 60 Hz
- <sup>6)</sup> DC on request

## 1 Engineering

### DILM, DILA, DILE, DILH

The diagrams show the closing and opening travel of the contacts at no load.

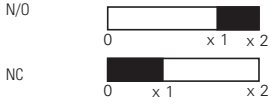

		x1	x2
<b>DILE AC</b>	N/O	1.9	2.8
	NC	0.95	2.8
	...DILE	1.9	2.8
	NC	0.9	2.8
...DDILE	NO early-make	1.06	2.9
	Late-break N/C contact	1.86	2.9
	N/O	1.9	2.8
	NC	0.9	2.8
<b>DILE DC</b>	N/O	1.9	2.85
	NC	0.95	2.85
	DILE...	1.9	2.8
	NC	0.9	2.8
...DDILE	NO early-make	1.06	2.9
	Late-break N/C contact	1.86	2.9
	N/O	1.9	2.8
	NC	0.9	2.8
<b>DILA-AC</b>	N/O	3.3	4.5
	NC	1.0	4.5
	DILA-XHI	3.2	4.5
	NC	1.6	4.5
DILA-XHIV	NO early-make	2.0	4.5
	Late-break N/C contact	2.8	4.5
	N/O	3.2	4.5
	NC	1.6	4.5
<b>DILA-DC</b>	N/O	2.1	2.9
	NC	0.7	2.9
	DILA-XHI	2.3	2.9
	NC	0.7	2.9
DILA-XHIV	NO early-make	1.1	2.9
	Late-break N/C contact	1.9	2.9
	N/O	2.3	2.9
	NC	0.7	2.9
<b>DILM7/9 AC</b>	N/O	3.3	4.5
	NC	1.0	4.5
	DILM32-XHI, DILA-XHI	3.2	4.5
	NC	1.6	4.5
DILA-XHIV	NO early-make	2.0	4.5
	Late-break N/C contact	2.8	4.5
	N/O	3.2	4.5
	NC	1.6	4.5
<b>DILM7/9 DC</b>	N/O	2.1	2.9
	NC	0.7	2.9
	DILM32-XHI, DILA-XHI	2.3	2.9
	NC	0.7	2.9
DILA-XHIV	NO early-make	1.1	2.9
	Late-break N/C contact	1.9	2.9
	N/O	2.3	2.9
	NC	0.7	2.9
<b>DILM12/15/P20 AC</b>	N/O	3.3	4.5
	NC	1.0	4.5
	DILM32-XHI, DILA-XHI	3.2	4.5
	NC	1.6	4.5
DILA-XHIV	NO early-make	2.0	4.5
	Late-break N/C contact	2.8	4.5
	N/O	3.2	4.5
	NC	1.6	4.5
<b>DILM12/15/P20 DC</b>	N/O	3.3	4.4
	NC	1.0	4.4
	DILM32-XHI, DILA-XHI	3.2	4.4
	NC	1.6	4.4

### DILM, DILA, DILE, DILH

The diagrams show the closing and opening travel of the contacts at no load.

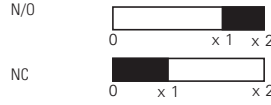

		x1	x2		
<b>DILA-XHIV</b>	NO early-make	2.0	4.4		
	Late-break N/C contact	2.8	4.4		
	N/O	3.2	4.4		
	NC	1.6	4.4		
<b>DILM17/25/32/P32/P45</b>	N/O	4.0	6.0		
	Auxiliary N/C	1.8	6.0		
	Auxiliary N/O	3.2	6.0		
	NC	3.2	6.0		
DILM32-XHI, DILA-XHI	N/O	3.2	6.0		
	NC	1.6	6.0		
	DILA-XHIV	NO early-make	2.0	6.0	
	Late-break N/C contact	2.8	6.0		
DILA-XHIV	N/O	3.2	6.0		
	NC	1.6	6.0		
	<b>DILM40/50/65/P63/P80</b>	N/O	5.1	7.5	
		DILM150-XHI	N/O	5.7	7.5
NC		3.9	7.5		
DILM150-XHIV		NO early-make	3.8	7.5	
DILM150-XHIV	Late-break N/C contact	5.4	7.5		
	N/O	5.7	7.5		
	NC	3.9	7.5		
	DILM1000-XHI	N/O	5.5	7.5	
DILM1000-XHIV	NC	3.6	7.5		
	NO early-make	4.1	7.5		
	Late-break N/C contact	5.0	7.5		
	<b>DILM80/95/115/150/170/P125/P160/P200</b>	N/O	8.0	11	
DILM150-XHI		N/O	9.2	11	
NC		7.4	11		
DILM150-XHIV		NO early-make	7.3	11	
DILM150-XHIV	Late-break N/C contact	8.9	11		
	N/O	9.2	11		
	NC	7.4	11		
	DILM1000-XHI	N/O	9.0	11	
DILM1000-XHIV	NC	7.1	11		
	NO early-make	7.6	11		
	Late-break N/C contact	8.5	11		
	<b>DILM185A/225A</b>	N/O	10.0	13.0	
DILM1000-XHI		N/O	10.0	13.0	
NC		8.1	13.0		
DILM1000-XHIV		NO early-make	8.4	13.0	
DILM1000-XHIV	Late-break N/C contact	9.5	13.0		
	<b>DILM250/300A</b>	N/O	10.1	13.1	
		DILM820-XHI	N/O	10.3	13.1
		NC	8.4	13.1	
DILM820-XHIV		NO early-make	8.7	13.1	
DILM820-XHIV	Late-break N/C contact	9.8	13.1		
	<b>DILM400/500/570</b>	N/O	8.9	13.1	
		DILM820-XHI	N/O	10.3	13.1
		NC	8.4	13.1	
DILM820-XHIV		NO early-make	8.7	13.1	
DILM820-XHIV	Late-break N/C contact	9.8	13.1		
	<b>DILM580/650/750/820</b>	N/O	2.0	4.1	
		DILM820-XHI	N/O	7.4	10.5
		NC	5.5	10.5	
DILM820-XHIV		NO early-make	6.0	10.5	
DILM820-XHIV	Late-break N/C contact	6.8	10.5		
	<b>DILM1000/1600, DILH1400/2000/2200/2600</b>	N/O	2.0	4.1	
		DILM820-XHI	N/O	7.4	10.5
		NC	5.5	10.5	
DILM820-XHIV		NO early-make	6.0	10.5	
DILM820-XHIV	Late-break N/C contact	6.8	10.5		

**DILE, DILM, SDAINL, DIUL**

**Components**

Contactor selection

Part no.	With top mounting auxiliary contacts	With side mounting auxiliary contacts	With overload relay	With parallel connector	Insulated enclosures
DILE...(-G)(-C)	–	–	–	–	CI-K1-95-TS
DILE...(-G)(-C)	●	–	–	–	CI-K2-145-TS
DILE...(-G)	●	–	●	–	CI-K2-145-AD
DILE...(-G)	–	–	–	●	CI-K2-100-TS
DILE...(-G)	●	–	–	●	CI-K2-145-TS
DILM7 to DILM15	●	–	–	–	CI-K2-145-TS
DILM7 to DILM15	●	–	●	–	CI-K3-160-TS
DILM17 to DILM32	–	–	–	–	CI-K2-145-TS
DILM17 to DILM32	●	–	●	–	CI23E-150
DILM40 to DILM65	–	●	–	–	CI-K3-160-TS
DILM40 to DILM65	●	●	●	–	CI43E-150
DILM80 to DILM170	●	●	–	–	CI43E-200
DILM80 to DILM170	●	●	●	–	CI44E-200
DILM185A	–	●	–	–	CI48-250
DILM225A	–	●	–	–	CI48-250
DILM250	–	●	–	–	CI48-250
DILM300A	–	●	–	–	CI48-250
DILM400	–	●	–	–	CI48-250
DILM500	–	●	–	–	CI48-250
DILM580	–	●	–	–	CI48-250
DILM650	–	●	–	–	CI48-250
DILM750	–	●	–	–	CI48-250
DILM820	–	●	–	–	CI48-250
DIULE...	●	–	–	–	CI-K3-125-TS
DIULE...	●	–	●	–	CI-K3-125-TS
DIULM7 to DIULM12	●	–	–	–	CI-K4-160-TS
DIULM17 to DIULM32	●	–	–	–	CI23E-150
DIULM40 to DIULM65	●	–	–	–	CI43E-200
SDAINLEM...	●	–	–	–	CI-K5-125-TS CI-K5-125-M
SDAINLM12 to SDAINLM22	●	–	–	–	CI-K5-160-TS
SDAINLM30 to SDAINLM65	●	–	–	–	CI23E-150
SDAINLM70 to SDAINLM115	●	–	–	–	CI43E-200
<b>Notes</b>	CI-K small enclosure	→ See catalog	Insulated PE, N or PEN terminal for enclosure CI-K	→ See catalog	
	Terminal for CI-K enclosure	→ See catalog			
	CI enclosure	→ See catalog			



# 1.1

## Contactors

UL/CSA-approved rating data

### 1 for North America

#### DILE, DILA, DILM

##### Rating data for approved types



Maximum alternating current-motor rating

Single-phase

3-phase

115 V 120 V HP	230 V 240 V HP	200 V 208 V HP	230 V 240 V HP	460 V 480 V HP	575 V 600 V HP
----------------------	----------------------	----------------------	----------------------	----------------------	----------------------

##### GENERAL USE

Maximum motor-rated current  
 $I_{th}$   
Open/enclosed

A

##### Contactors

NEMA size

						A	Part no.	
1/2	1 1/2	2	3	5	5	15/13.5	<b>DILEM(4)</b>	00
1/4	1	1 1/2	2	3	5	20	<b>DILM7-...(...)</b>	00
1/2	1 1/2	3	3	5	7 1/2	20	<b>DILM9-...(...)</b>	00
1	2	3	3	10	10	20	<b>DILM12-...(...)</b>	0
1	3		5	10	10	20	<b>DILM15-...(...)</b>	0
2	3	5	7 1/2	10	15	35	<b>DILM17-...(...)</b>	0
2	5	7 1/2	7 1/2	15	20	35	<b>DILM25-...(...)</b>	1
3	5	10	10	20	25	40	<b>DILM32-...(...), DILM38-...(...)</b>	1
3	7 1/2	10	15	30	40	55	<b>DILM40(...)</b>	2
3	10	15	20	40	50	65	<b>DILM50(...)</b>	2
5	15	20	25	40	60	80	<b>DILM65(...), DILM70(...)</b>	2
7 1/2	15	25	30	60	75	125	<b>DILM80(...)</b>	3
7 1/2	15	25	40	75	100	125	<b>DILM95(...)</b>	3
10	25	40	50	100	125	160	<b>DILM115(...)</b>	4
15	30	40	60	125	125	160	<b>DILM150(...), DILM170(...)</b>	4
–	–	50	60	125	150	225	<b>DILM185(...)</b>	4
–	–	60	75	150	200	250	<b>DILM225(...)</b>	4
–	–	75	100	200	250	350	<b>DILM250(...)</b>	5
–	–	100	125	250	300	350	<b>DILM300(...)</b>	5
–	–	125	150	300	400	450	<b>DILM400(...)</b>	5
–	–	150	200	400	500	550	<b>DILM500(...)</b>	6
–	–	200	200	400	600	630	<b>DILM580(...)</b>	6
–	–	200	250	500	600	700	<b>DILM650(...)</b>	6
–	–	250	300	600	700	800	<b>DILM750(...)</b>	6
–	–	290	350	700	860	850	<b>DILM820(...)</b>	6
–	–	350	400	800	1000	1000	<b>DILM1000(...)</b>	7
–	–	560	640	1200	1300	1600	<b>DILM1600(...)</b>	8

#### DILE, DILA, DILM

##### Approved rating data UL - File No. E29184 for auxiliary contacts



Pilot Duty

General Use

Part no.	Pilot Duty		General Use			
	AC	DC	AC V	A	DC V	A
<b>DIL(E)EM-10(-01)</b> <b>DILER-40(31)(22)</b> <b>...(D)DILE</b>	A600	P300	600	10	250	0.5
<b>DILM7-10(-01)</b> To <b>DILM32-10(-01)</b> <b>DILA...</b>	A600	P300	600	15	250	1
<b>DILA-XHI...</b> <b>DILM32-XHI...</b>	A600	P300	600	15	250	1
<b>DILM...-XHI11-SI</b> <b>DILM...-XHI11-SA</b> <b>DILM...-XHI11V-SI</b>	A600	P600	600	10	–	–

Further approvals → 81

- Elevator control
- Refrigeration control
- Resistance air heating
- Incandescent lamps
- Electrical discharge lamps
- Capacitive switching

for North America

DILM, DILMP, DILK

Special purpose rating



	DIL	M7	M9	M12	M15	M17	M25 MP32 MP45	M32	M40 MP63	M50 MP80	M65 M72	M80 MP125	M95 MP160	M115	M150 M170 MP200
<b>Electrical discharge lamps (ballast)</b>															
480V 60Hz 3phase, 277V 60Hz 1phase	A	12	18	20	20	27	35	40	63	79	88	85	100	136	160
600V 60Hz 3phase, 347V 60Hz 1phase	A	12	18	20	20	27	35	40	63	79	88	85	100	136	160
<b>Incandescent lamps (Tungsten)</b>															
480V 60Hz 3phase, 277V 60Hz 1phase	A	8	11	14	14	23	32	40	55	74	88	85	100	136	160
600V 60Hz 3phase, 347V 60Hz 1phase	A	8	11	14	14	23	32	40	55	74	88	85	100	136	160
<b>Resistance air heating</b>															
480V60Hz 3phase, 277V60Hz 1phase	A	12	18	20	20	27	35	40	63	79	88	94	110	136	160
600V60Hz 3phase, 347V60Hz 1phase	A	12	18	20	20	27	35	40	63	79	88	94	110	136	160
<b>Refrigeration control (CSA only)</b>															
LRA 480V 60Hz 3phase	A	60	60	60	60	240	240	240	270	270	270	540	540	540	540
LRA 600V 60Hz 3phase	A	60	60	60	60	180	180	180	270	270	270	420	420	540	540
480V 60Hz 3phase	A	6	7.5	10	10	23	32	40	26	36	45	63	70	84	90
600V 60Hz 3phase	A	6	7.5	10	10	17	24	30	26	36	45	63	70	84	90
<b>Elevator control</b>															
200V 60Hz 3phase	HP (A)	¾ (3.7)	2 (7.8)	2 (7.8)	2 (7.8)	3 (11)	3 (11)	7½ (25.3)	7½ (25.3)	10 (32.2)	10 (32.2)	20 (62.1)	20 (62.1)	30 (92)	30 (92)
240V 60Hz 3phase	HP (A)	1½ (6.0)	2 (6.8)	2 (6.8)	3 (9.6)	3 (9.6)	5 (15.2)	7½ (22)	10 (28)	15 (42)	15 (42)	25 (68)	30 (80)	40 (104)	40 (104)
480V 60Hz 3phase	HP (A)	2 (3.4)	3 (4.8)	7½ (11)	7½ (11)	7½ (11)	10 (14)	20 (27)	25 (34)	30 (40)	30 (40)	50 (65)	60 (77)	75 (96)	75 (96)
600V 60Hz 3phase	HP (A)	3 (3.9)	5 (6.1)	7½ (9.6)	7½ (9.6)	10 (11)	15 (17)	20 (22)	30 (32)	40 (41)	40 (41)	60 (62)	75 (77)	100 (99)	100 (99)

DILM, DILMP, DILK

Special purpose rating



	DIL	K12	K20	K25	K33	K50
<b>Capacitor Switching</b>						
240V 60Hz 3phase	A	18	28	36	48	72
480V 60Hz 3phase	A	18	28	36	48	72
600V 60Hz 3phase	A	14.4	28	38.4	48	72
240V 60Hz 3phase	kvar	7.5	12	15	20	30
480V 60Hz 3phase	kvar	15	20	30	40	60
600V 60Hz 3phase	kvar	15	30	40	50	75

# 1.1

## Contactors

UL/CSA short circuit current rating

### 1 for North America

#### DILM

##### Short circuit current rating (SCCR)



Contactor	Basic Rating			480 V High Fault				600 V High Fault			
	kA	Max. fuse A	Max. CB A	kA	Max. fuse A	kA	Max. CB A	kA	Max. fuse A	kA	Max. CB A
DILM7-...(…)	5	45	60	100	20 Class J	-	Fuse only	30	25	-	Fuse only
DILM9-...(…)	5	45	60	100	20 Class J	-	Fuse only	30	25	-	Fuse only
DILM12-...(…)	5	45	60	100	20 Class J	-	Fuse only	30	25	-	Fuse only
DILM15-...(…)	5	45	60	100	20 Class J	-	Fuse only	30	25	-	Fuse only
DILM17-...(…)	5	125	125	100	70 Class J	10	50	10	125	10	50
DILM25-...(…)	5	125	125	100	100 Class J	10	50	10	125	10	50
DILM32-...(…)	5	125	125	100	125 Class J	10	50	10	125	10	50
DILM38-...(…)	5	125	125	100	125 Class J	10	50	10	125	10	50
DILM40(…)	10	250	250	100	150 Class J	65	100	30	250	30	250
DILM50(…)	10	250	250	100	150 Class J	65	100	30	250	30	250
DILM65(…)	10	250	250	100	150 Class J	65	100	30	250	30	250
DILM72(…)	10	250	250	100	150 Class J	65	100	30	250	30	250
DILM80(…)	10	600	600	100	300 Class J	65	250	30	300	30	350
DILM95(…)	10	600	600	100	300 Class J	65	250	30	300	30	350
DILM115(…)	10	600	600	100	300 Class J	65	250	30	300	30	350
DILM150(…)	10	600	600	100	300 Class J	65	250	30	300	30	350
DILM170(…)	10	600	600	100	300 Class J	65	250	30	300	30	350
DILM185(…)	18	700	600	-	CB only	65	250	-	-	-	-
DILM225(…)	18	700	600	-	CB only	65	250	-	-	-	-
DILM250(…)	18	700	600	-	CB only	65	250	-	-	-	-
DILM300(…)	30	800	600	-	CB only	42	600	30	800	30	600
DILM400(…)	30	800	600	-	CB only	42	600	30	800	30	600
DILM500(…)	30	800	600	-	CB only	42	600	30	800	30	600
DILM570(…)	30	800	600	-	CB only	42	600	30	800	30	600
DILM580(…)	30	2000	1200	85	2000	85	1200	85	2000	85	1200
DILM650(…)	30	2000	1200	85	2000	85	1200	85	2000	85	1200
DILM750(…)	42	2000	1200	85	2000	85	1200	85	2000	85	1200
DILM820(…)	42	2000	1200	85	2000	85	1200	85	2000	85	1200
DILM1000(…)	85	2000	1200	85	2000	85	1200	85	2000	85	1200
DILM1600(…)	85	2000	-	85	2000	-	-	85	2000	85	-

# 1.1

## Contactors

Contactors for resistive load

### 1 DILM, DILEM

#### Rating data

##### Single-phase rating AC-1

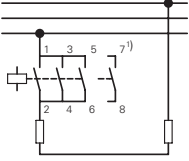

##### Three-phase rating AC-1

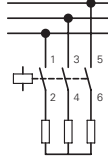

##### Three-phase rating AC-1

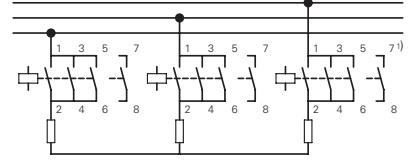

Voltage in V			Max. upstream fuse gG/gL	Rated operational current $I_e = I_{th}$ or $I_{the}$
220	380	660		
230	400	690		
240	440			
kW			A	A

Voltage in V			Max. upstream fuse gG/gL	Rated operational current $I_e = I_{th}$ or $I_{the}$
220	380	660		
230	400	690		
240	440			
kW			A	A

Voltage in V			Max. upstream fuse gG/gL	Rated operational current $I_e = I_{th}$ or $I_{the}$
220	380	660		
230	400	690		
240	440			
kW			A	A

#### Open version

10	18	31	50	50	7	13	20	20	20	18	31	54	50	50
10	18	31	50	50	7	13	20	20	20	18	31	54	50	50
12	21	37	63	60	–	–	–	–	–	21	37	65	63	60
10	18	31	–	50	7	13	22	–	20	18	31	54	–	50
13	22	38	–	60	–	–	–	–	–	22	38	65	–	60
18	32	55	–	88	13	22	38	–	35	32	55	95	–	88
21	36	63	–	100	14	25	43	–	40	36	63	109	–	100
26	45	78	–	125	18	31	54	–	50	45	78	136	–	125
34	59	102	–	163	24	41	71	–	65	59	102	176	–	163
42	72	125	–	200	29	50	87	–	80	72	125	217	–	200
47	81	141	–	225	33	56	98	–	90	81	141	244	–	225
57	99	172	–	275	40	69	119	–	110	100	172	299	–	275
68	117	204	–	325	47	81	141	–	130	118	203	353	–	325
84	144	251	–	400	58	100	174	–	160	145	250	434	–	400
101	175	317	–	460	70	120	220	–	185	175	302	549	–	460
144	248	431	800	688	100	172	299	315	275	262	453	786	–	688
165	284	494	800	788	114	197	342	315	315	300	519	900	–	788
172	297	516	1000	825	120	206	357	400	330	333	576	1000	–	875
183	316	548	1000	875	126	219	380	400	350	381	658	1143	–	1000
261	451	784	1250	1250	181	313	543	500	500	476	825	1429	–	1250
366	632	1097	–	1750	253	438	760	800	700	667	1152	2000	–	1750
418	722	1254	–	2000	290	500	869	800	800	762	1316	2286	–	2000
444	767	1332	–	2125	308	531	923	1000	850	810	1400	2429	–	2125
470	812	1411	–	2250	326	563	977	1000	900	857	1480	2572	–	2250
523	903	1568	–	2500	362	625	1086	1000	1000	953	1646	2858	–	2500
732	1264	2195	–	3500	507	875	1520	–	1400	1334	2300	4000	–	3500
1045	1805	3135	–	5000	724	1251	2172	–	2000	1905	3290	5716	–	5000
1150	1985	3449	–	5500	796	1376	2389	–	2200	2095	3619	6288	–	5500
1358	2346	4075	–	6500	941	1626	2827	–	2600	2476	4277	7430	–	6500

#### Notes

<sup>1)</sup> Contact 7 – 8 only with DILEM4(-G), DILMP20...

**DILM, DILEM**

Part no.	Ordering data	Required accessories:	Notes
		<b>Paralleling links</b>	

AC operated	Page	Part no.	Accessories	Page
DILEM-10(...)	→ 4	P1DILEM		
DILEM-01(...)	→ 4	P1DILEM		
DILEM4(...)	→ 4	P1DILEM		
DILM7-...(...)	→ 18	DILM12-XP1	Auxiliary contact modules	→ 6
DILMP20(...)	→ 34	DILM12-XP1	Set of paralleling links	→ 36
DILM17-...(...)	→ 18	DILM32-XP1	Enclosure	→ 53
DILM25-...(...)	→ 18	DILM32-XP1	Accessories	→ 63
DILM40(...)	→ 20	DILM65-XP1		→ 52
DILM50(...)	→ 20	DILM65-XP1		
DILM65(...)	→ 20	DILM65-XP1		
DILM80(...)	→ 20	DILM150-XP1		
DILM95(...)	→ 20	DILM150-XP1		
DILM115(...)	→ 20	DILM150-XP1		
DILM150(...)	→ 20	DILM150-XP1		
DILM170(...)	→ 20	DILM150-KP1		
DILM185A(...)	→ 30	DILM185-XP1		
DILM225A(...)	→ 30	DILM185-XP1		
DILM250(...)	→ 30	–		
DILM300A(...)	→ 30	–		
DILM400(...)	→ 30	–		
DILM500(...)	→ 30	–		
DILM580(...)	→ 30	–		
DILM650(...)	→ 30	–		
DILM750(...)	→ 30	–		
DILM820(...)	→ 30	–		
DILH1400(...)	→ 32	–		
DILH2000(...)	→ 32	–		
DILH2200(...)	→ 32	–		
DILH2600(...)	→ 32	–		

# 1.1

## Mini contactor relays, contactor relays

Electrical lifespan

### 1 DILA (AC-15)

Component lifespan (operations)  
 $I_e$  = Rated operational current

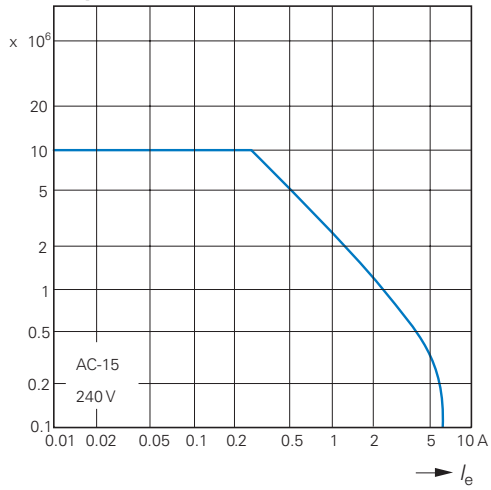

### DILA DC<sup>1)</sup>

Component lifespan (operations)  
 $I_e$  = Rated operational current

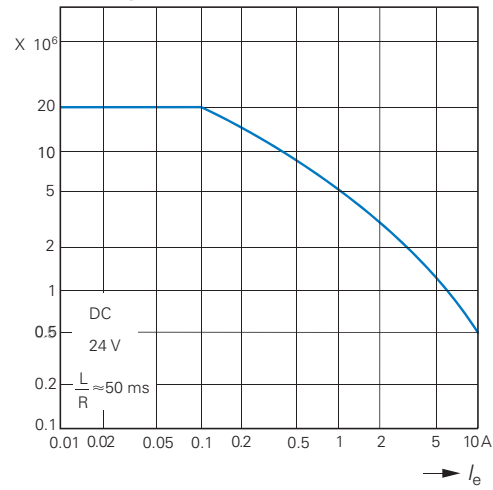

<sup>1)</sup> Three contacts in series

### DILER (AC-15)

Component lifespan (operations)  
 $I_e$  = Rated operational current

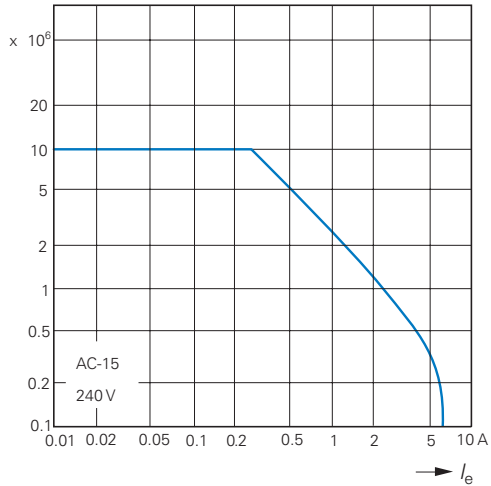

Normal switching duty

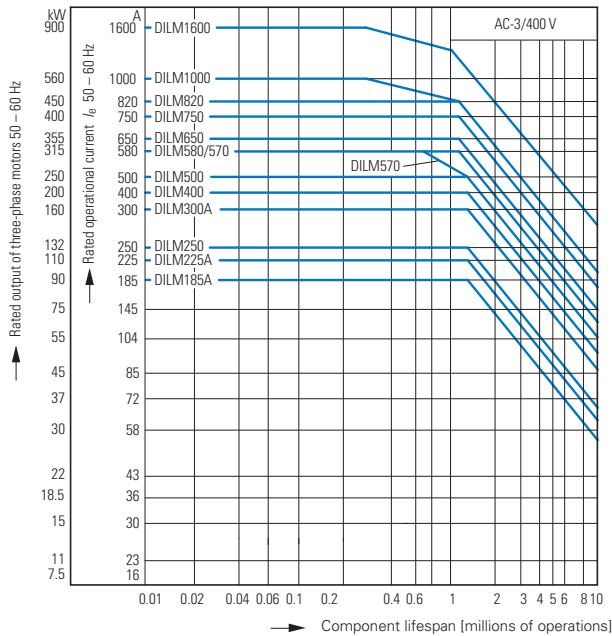

Extreme switching duty

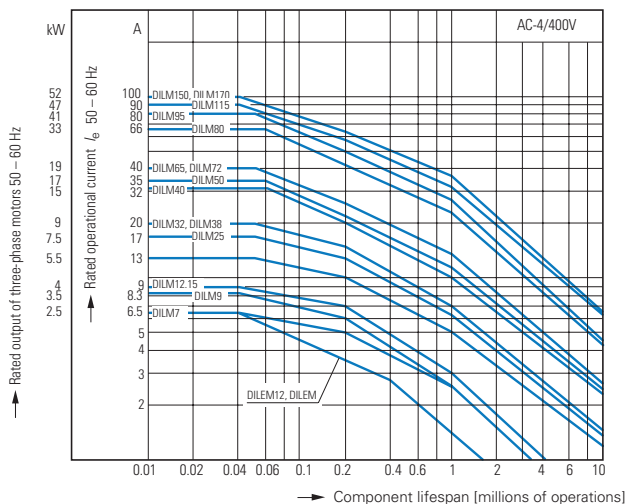

Normal AC induction motor

Operating characteristics

Make: from stop

Break: during run

Electrical characteristics:

Make: up to 6 X rated motor current

Break: 1 X rated motor current

Utilization category

100 % AC-3

Typical applications:

- |  |                 |                       |
|--|-----------------|-----------------------|
| Compressors  | Lifts           | Mixers                |
| Pumps  | Escalators      | Agitators             |
| Fan  | Conveyor belts  | Centrifuges           |
| Hinged flaps   | Bucket-elevator | Air conditioning sys- |
| General drives for manufacturing and processing machines |                 |                       |

Normal AC induction motor

Operating characteristics

Inching, plugging, reversing

Electrical characteristics:

Make: up to 6 X rated motor current

Break: 6 X rated motor current

Utilization category

100 % AC-4

Typical applications:

- |   |              |             |
|---|--------------|-------------|
| Printing machines                                       | Wire-drawing | Centrifuges |
| Special drives on manufacturing and processing machines |              |             |

# 1.1

## Contactors

### Switching conditions

#### 1 Extreme switching duty

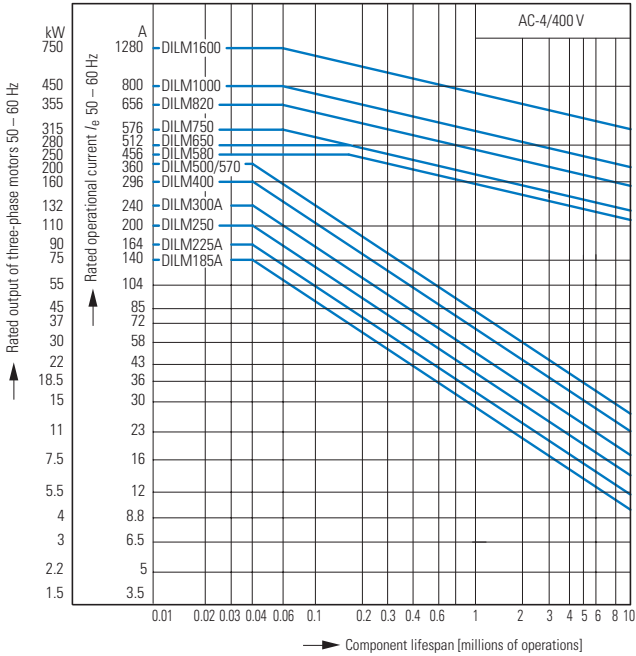

#### Normal AC induction motor

Operating characteristics

Inching, plugging, reversing

Electrical characteristics:

Make: up to 6 X rated motor current

Break: 6 X rated motor current

Utilization category

100% AC-4

Typical applications:

Printing machines    Wire-drawing machines    Centrifuges

Special drives on manufacturing and processing machines

#### Switching conditions for 3 pole, non-motor loads

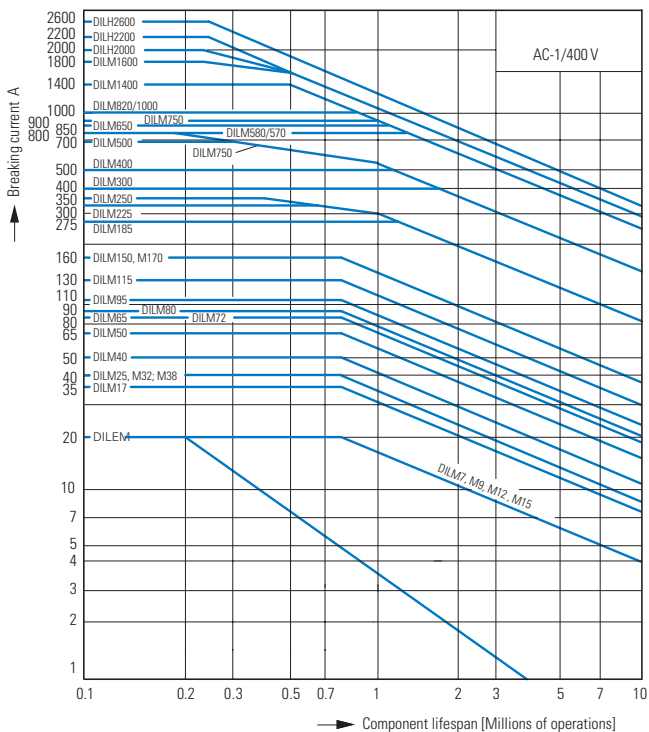

Operating characteristics

Non inductive and slightly inductive loads

Electrical characteristics:

Make: 1 X rated operational current

Break: 1 X rated operational current

Utilization category

100% AC-1

Typical applications:

Electric heat



Switching conditions for 4 pole, non-motor loads

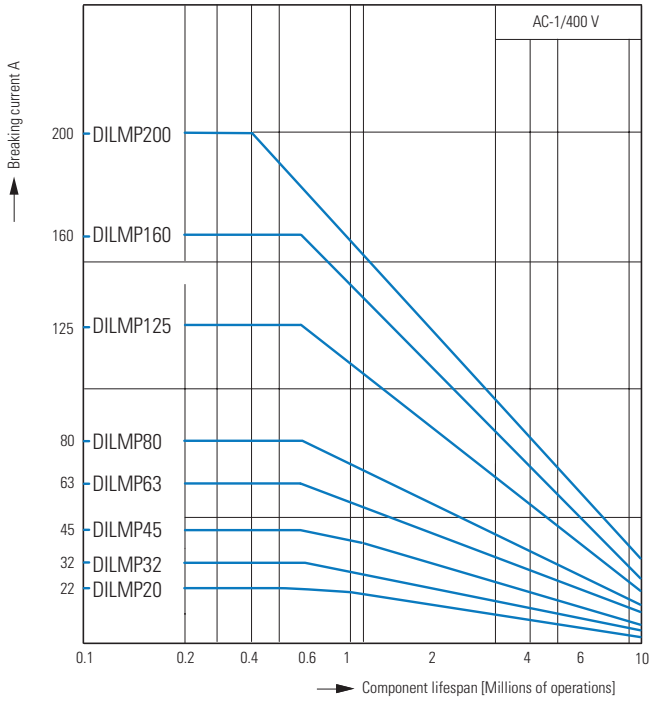

- Operating characteristics
  - Non inductive and slightly inductive loads
- Electrical characteristics:
  - Make: 1 X rated operational current
  - Break: 1 X rated operational current
- Utilization category
  - 100% AC-1
- Typical applications:
  - Electric heat

# 1.1

## Contactors

### Short-time loading

#### 1 Short-time loading 3 pole

Time interval between two loads: 15 minutes

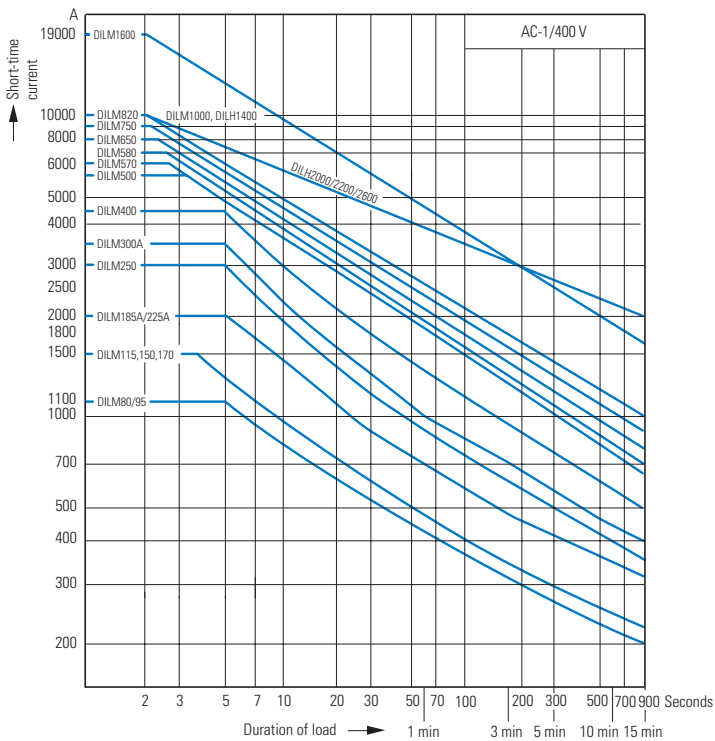
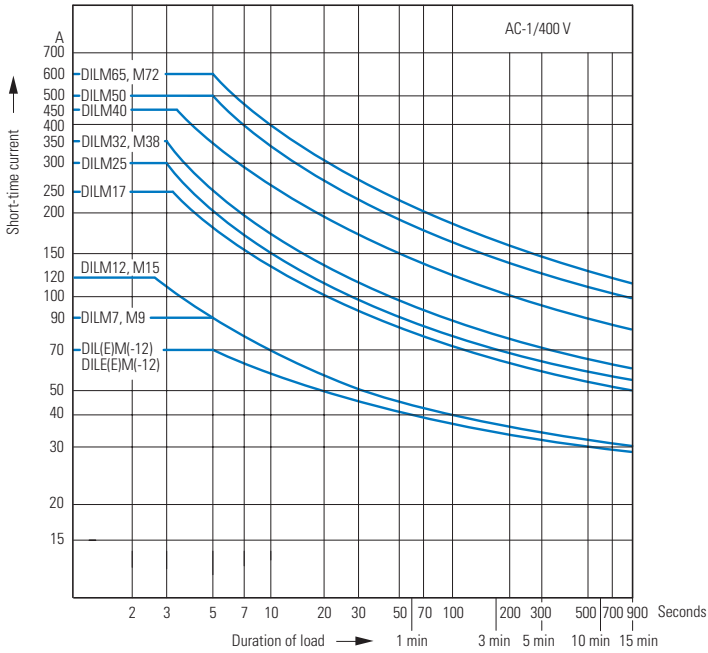

**Determination of the maximum operating frequency dependent on the rating and utilization category (recommended values) for 400 V**

$P_N$  = max. rated motor output (kW) of respective contactor according to → Page 18 and → Page 4

S/h = max. operation per hour

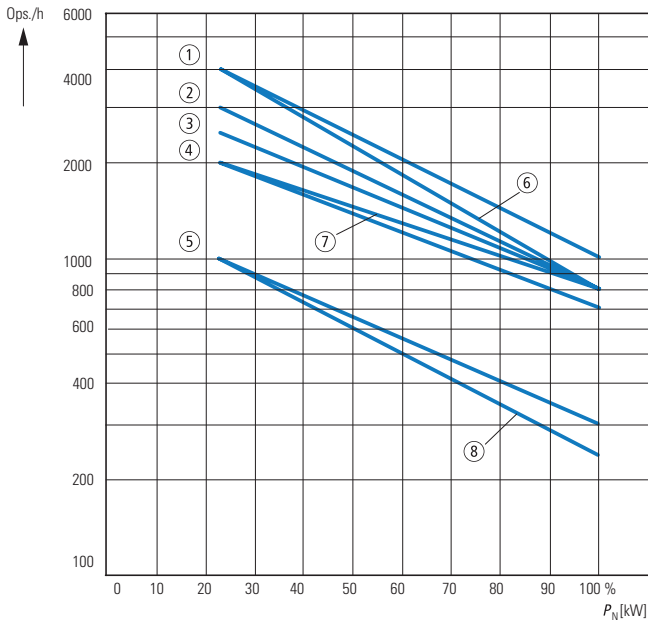

**DILEM, DILM, DILH**

Part no.	Characteristic		
	AC-1	AC-3	AC-2 AC-4
DILE(E)M(-12)	7	6	8
DILM7, 9, 12, 15	3	1	5
DILM17, 25, 32, 38	3	2	5
DILM40, 50, 65, 72	3	2	5
DILM80, 95, 115, 150, 170	3	4	5

**Determination of the maximum operating frequency dependent on the rating and utilization category (recommended values)**

$P_N$  = max. rated motor output (kW) of respective contactor according to → Page 28 and → Page 32

S/h = max. operation per hour

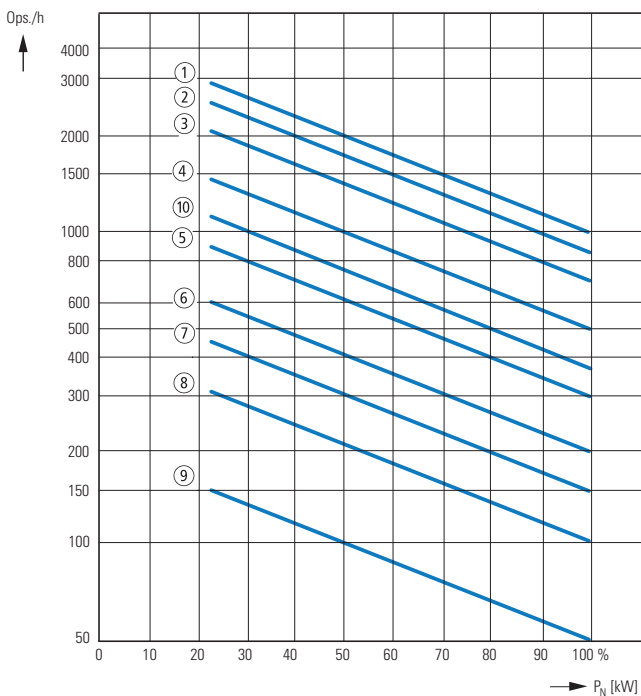

**DILEM, DILM, DILH**

Part no.	Characteristic		
	AC-1	AC-3	AC-4
DILM185A	2	1	8
DILM225A	2	1	8
DILM250	2	1	8
DILM300A	3	2	9
DILM400	3	2	9
DILM500	3	2	9
DILM580	3	4	7
DILM650	3	4	7
DILM750	3	4	7
DILM820	3	4	7
DILM1000	3	4	7
DILM1600	10	10	7
DILH1400	10	–	–
DILH2000	10	–	–
DILH2200	10	–	–
DILH2600	10	–	–

# 1.1

## Contactors

Switching of DC current

### 1 DC current switching

----- when necessary  
conductor to be  
supplied by customer

#### DILEEM ... DILM700

Without overload relay  
≤ 60 V DC

> 60 V DC

With overload relay  
> 60 V DC

1 pole

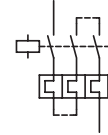
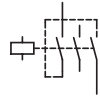

2 pole

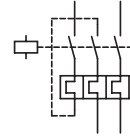

#### DILEM4 DILMP...

1 pole

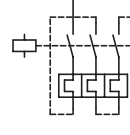
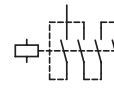

2 pole

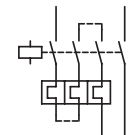

### Wiring, star-delta combination with DILM32-XTEY20

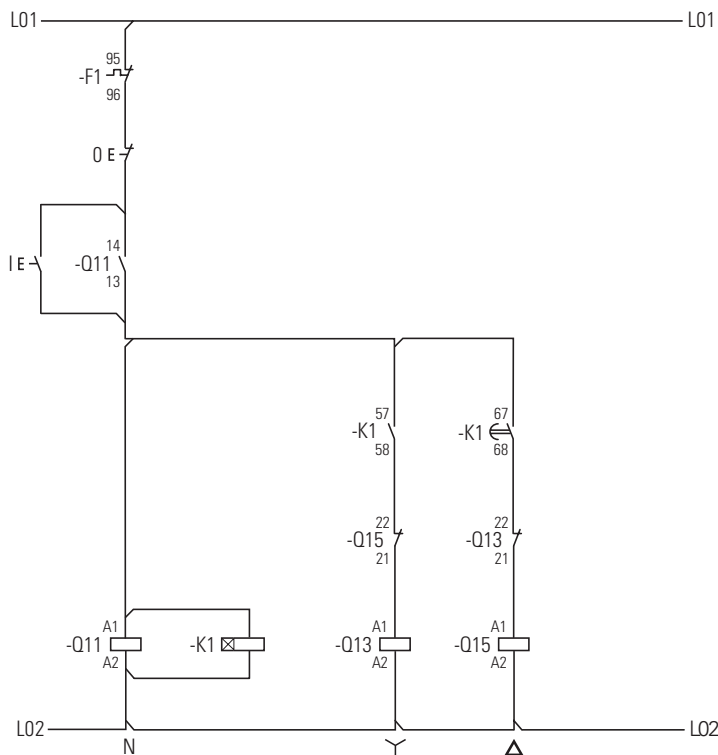

Technical data

DILER, DILA

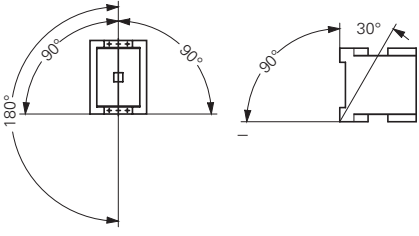
			DILA	DILA...XHI	DILER	DILE...	
<b>General</b>							
Standards			IEC/EN 60947, VDE 0660, UL, CSA				
Lifespan, mechanical							
AC operated	Operations	x 10 <sup>6</sup>	20	10	10	10	
DC operated	Operations	x 10 <sup>6</sup>	20	10	20	20	
Maximum operating frequency							
Maximum operating frequency	Operations/h		9000	9000	9000	9000	
Climatic proofing							
			Damp heat, constant, to IEC 60068-2-78; Damp heat, cyclic, to IEC 60068-2-30				
Ambient temperature							
Open		°C	-25...60	-25...60	-25...50	-25...50	
Enclosed		°C	-25...40	-25...40	-25...40	-25...40	
Ambient temperature for storage		°C	-40 - 80	-40 - 80			
Mounting position							
						Any, except vertically with terminals A1/A2 below	
Mechanical shock resistance (IEC/EN 60068-2-27)							
Half-sinusoidal shock 10 ms							
Basic devices with auxiliary contact module							
		g	7	7	10	10	
	N/O	g	7	7	10	10	
	NC	g	5	5	8	8	
Protection type							
			IP20	IP20	IP20	IP20	
Protection against direct contact when actuated from front (EN 50274)							
			Finger- and back-of-hand proof				
Weight							
AC operated		kg	0.23	0.05	0.17	–	
DC operated		kg	0.28	0.05	0.2	–	
Terminal capacity							
Screw terminals							
	Solid	mm <sup>2</sup>	1 x (0.75 - 4) 2 x (0.75 - 2.5)	1 x (0.75 - 4) 2 x (0.75 - 2.5)	1 x (0.75 - 2.5) 2 x (0.75 - 2.5)	1 x (0.75 - 2.5) 2 x (0.75 - 2.5)	
	Flexible with ferrule	mm <sup>2</sup>	1 x (0.75 - 2.5) 2 x (0.75 - 2.5)	1 x (0.75 - 2.5) 2 x (0.75 - 2.5)	1 x (0.75 - 1.5) 2 x (0.75 - 1.5)	1 x (0.75 - 1.5) 2 x (0.75 - 1.5)	
	Solid or stranded	AWG	18 - 14	18 - 14	18 - 14	18 - 14	
	Terminal screw		M3.5	M3.5	M3.5	M3.5	
	Pozidriv screwdriver	Size	2	2	2	2	
	Flat-blade screwdriver	mm	0.8 x 5.5 1 x 6	0.8 x 5.5 1 x 6	0.8 x 5.5 1 x 6	0.8 x 5.5 1 x 6	
	Max. tightening torque	Nm	1.2	1.2	1.2	1.2	
Spring-loaded terminals							
	Solid	mm <sup>2</sup>	1 x (0.75 - 2.5) 2 x (0.75 - 2.5)	1 x (0.75 - 2.5) 2 x (0.75 - 2.5)	1 x (1 - 2.5) 2 x (1 - 2.5)	1 x (1 - 2.5) 2 x (1 - 2.5)	
	Flexible with ferrule	mm <sup>2</sup>	1 x (0.75 - 1.5) 2 x (0.75 - 1.5)	1 x (0.75 - 1.5) 2 x (0.75 - 1.5)	1 x (1 - 2.5) 2 x (1 - 2.5)	1 x (1 - 2.5) 2 x (1 - 2.5)	
	Flexible without ferrule DIN 46228	mm <sup>2</sup>	1 x (0.75 - 2.5) 2 x (0.75 - 2.5)	1 x (0.75 - 1.5) 2 x (0.75 - 1.5)	–	–	
	Solid or stranded	AWG	18 - 14	18 - 14	1 x (16 - 14) 2 x (16 - 14)	1 x (16 - 14) 2 x (16 - 14)	
	Flat-blade screwdriver	mm	0.6 x 3.5	0.6 x 3.5	0.6 x 3.5	0.6 x 3.5	

# 1.1 Mini contactor relays, contactor relays

## 1 DILER, DILA

			DILA	DILA...XHI	DILER	DILE...
<b>Contacts</b>						
Interlocked opposing contacts to EN 60947-4-1, Annex L, including auxiliary contact module			Yes	Yes	Yes	Yes
Rated impulse withstand voltage	$U_{imp}$	V AC	6000	6000	6000	6000
Overvoltage category/degree of pollution			III/3	III/3	III/3	III/3
Rated insulation voltage	$U_i$	V AC	690	690	690	690
Rated operating voltage	$U_e$	V AC	690	500	600	600
Safe isolation according to EN 61140						
Between coil and auxiliary contacts			V AC	400	300	300
Between the auxiliary contacts			V AC	400	300	300
Rated operational current						
AC-15						
220/240 V	$I_e$	A	4	4	6	4
380/415 V	$I_e$	A	4	4	3	2
500 V	$I_e$	A	1.5	1.5	1.5	1.5
DC <sup>1)</sup>						
L/R $\leq$ 15 ms						
Contacts in series:						
1	24 V	A	10	10	2.5	2.5
1	60 V	A	6	6	–	–
2	60 V	A	10	10	2.5	2.5
1	110 V	A	3	3	–	–
3	110 V	A	6	6	1.5	1.5
1	220 V	A	1	1	–	–
3	220 V	A	5	5	0.5	0.5
L/R $\leq$ 50 ms						
Contacts in series:						
3	24 V	A	4	2.5	–	–
3	60 V	A	4	1	–	–
3	110 V	A	2	0.5	–	–
3	220 V	A	1	0.25	–	–
DC-13 (6xP)						
Contacts in series:						
3	24 V	A	2.5	2.5	–	–
3	60 V	A	1	1	–	–
3	110 V	A	0.5	0.5	–	–
3	220 V	A	0.25	0.25	–	–
Control circuit reliability (at $U_e = 24$ V DC, $U_{min} = 17$ V, $I_{min} = 5.4$ mA)			Fault probability	$\lambda$	<10 <sup>-8</sup> , < one failure in 100 million operations	
Conventional thermal current			$I_{th}$	A	16	10
Short-circuit strength without welding						
Maximum overcurrent protection device						
220/240 V		PKZM0	4	–	4	4
380/415 V		PKZM0	4	–	4	4
Short-circuit protection rating maximum fuse <sup>2)</sup>						
500 V		A gG/gL	10	10	6	6
500 V		A fast	–	–	10	10
Current heat loss at load of $I_{th}$						
AC operated			W	0.3	0.2	0.2
DC operated			W	0.3	0.3	0.3

### Notes

<sup>1)</sup> Switch-on and switch-off conditions based on DC-13, time constant as specified

<sup>2)</sup> See characteristic curve "Fuses" for time/current characteristics (please enquire)

## DILER, DILA

1

			DILA	DILA...XHI	DILER	DILE...	
<b>Magnet systems</b>							
Voltage tolerance							
AC operated							
	Single-voltage coil 50 Hz and dual-voltage coil 50 Hz, 60 Hz	Pick-up	$x U_c$	0.8...1.1	–	0.8...1.1	–
	Dual-frequency coil 50/60 Hz	Pick-up	$x U_c$	0.8...1.1	–	0.85...1.1	–
DC operated <sup>1)</sup>							
	Starting voltage	Pick-up	$x U_c$	0.8...1.1	–	0.85...1.3	–
	At 24 V: without auxiliary contact module (40 °C)	Pick-up	$x U_c$	0.7 - 1.3	–	0.7 - 1.3	–
Power consumption							
	50 Hz	Pick-up	VA	24	–	25	–
	50 Hz	Sealing	VA	3.4	–	4.6	–
	50 Hz	Sealing	W	1.2	–	1.3	–
	60 Hz	Pick-up	VA	30	–	25	–
	60 Hz	Sealing	VA	4.4	–	4.6	–
	60 Hz	Sealing	W	1.4	–	1.3	–
	50/60 Hz	Pick-up	VA	27 25	–	30 29	–
	50/60 Hz	Sealing	VA	4.2 3.3	–	5.4 3.9	–
	50/60 Hz	Sealing	W	1.4 1.2	–	1.6 1.1	–
	DC operated	Pick-up = sealing	W	3	–	2.6	–
Duty factor			% DF	100	–	100	–
Changeover times at 100 % $U_c$ (recommended values)							
	AC operated closing delay		ms	15 - 21	–	14 - 21	–
	AC operated normally open contact opening delay		ms	9 - 18	–	8 - 18	–
	AC operated with auxiliary contact module, max. closing delay		ms	–	–	45	45
	DC operated closing delay		ms	31	–	26 - 35	–
	DC operated normally open contact opening delay		ms	12	–	15 - 25	–
	DC operated with auxiliary contact module, max. closing delay		ms	–	–	70	70

## Notes

<sup>1)</sup> Smoothed DC, three-phase bridge rectifier or smoothed two-phase bridge rectifier

# 1.1

## Contactors

Amplifier modules, electronic timer module, contactor monitoring device

### 1 ETS-VS3, DILM, CMD

			ETS4-VS3	DILM32-XTE	CMD(24VDC) CMD(220-240VAC)
<b>General</b>					
Standards			IEC/EN 60947, VDE 0660, UL, CSA	DIN EN 61812, IEC/EN 60947, VDE 0660, UL, CSA	IEC/EN 60947 UL CSA
Lifespan, mechanical					
AC operated	c (contacts)	x 10 <sup>6</sup>	–	3	10
DC operated	c (contacts)	x 10 <sup>6</sup>	30	3	3
Maximum operating frequency					
DC operated	c (contacts)	x 10 <sup>6</sup>	72000	–	9000
Climatic proofing					
			Damp heat, constant, to IEC 60068-2-78 Damp heat, cyclic, to IEC 60068-2-30		
Ambient temperature					
Storage		°C	–	-40 - 80	-40 - 80
Open		°C	-25 - 60	-25 - 60	-25 - 50
Enclosed		°C	-25 - 45	-25 - 40	–
Mounting position			Any	As required, except suspended	Any
Mechanical shock resistance (IEC/EN 60068-2-27)					
Half-sinusoidal shock 20 ms					
N/O		g	10	–	–
Half-sinusoidal shock 10 ms					
N/O		g	–	6	4
NC		g	–	6	4
Protection type			IP20	IP20	IP20
Protection against direct contact when actuated from front (EN 50274)			Finger- and back-of-hand proof		
Weight		kg	0.09	0.08	0.1
Terminal capacity					
Solid		mm <sup>2</sup>	1 x (0.75 - 2.5) 2 x (0.75 - 2.5) <sup>1)</sup>	1 x (0.75 - 2.5) 2 x (0.75 - 1.5)	1 x (0.75...2.5) 2 x (0.75...1.5)
Flexible with ferrule		mm <sup>2</sup>	1 x (0.75 - 2.5) 2 x (0.75 - 1.5) <sup>1)</sup>	1 x (0.75 - 1.5) 2 x (0.75 - 1.5)	1 x (0.75...1.5) 2 x (0.75...1.5)
Solid or stranded		AWG	16 - 14	18 - 14	18...14
Terminal screw			M3.5	M3.5	M3.5
Pozidriv screwdriver		Size	2	2	2
Flat-blade screwdriver		mm	0.8 x 5.5 1 x 6	0.8 x 5.5 1 x 6	0.8 x 5.5 1 x 6
Max. tightening torque		Nm	1.2	1.2	1.2

#### Notes

<sup>1)</sup> Use equal cross-sections only



## ETS-VS3, DILM, CMD

1

			ETS4-VS3	DILM32-XTE	CMD(24VDC)	CMD(220-240VAC)
<b>Contacts</b>						
Rated impulse withstand voltage	$U_{imp}$	V AC	6000	6000	8000	4000
Overvoltage category/degree of pollution			III/2	III/3	III/3	III/3
Rated insulation voltage	$U_i$	V AC	440	600	100	250
Rated operating voltage	$U_e$	V	440 AC	400 AC	24 DC	250 AC
Rated operational current						
AC-15						
220/240 V	$I_e$	A	2	3	–	–
280/415 V	$I_e$	A	2	–	–	–
DC-13 <sup>1)</sup>						
DC-13 L/R $\leq 15$ ms						
Contacts in series:						
1	24 V	A	2.6	1	–	–
1	60 V	A	1	0.2	–	–
1	110 V	A	0.6	0.2	–	–
1	220 V	A	0.2	0.1	–	–
DC-13 L/R $\leq 50$ ms						
Contacts in series:						
1	24 V	A	2	1	–	–
1	60 V	A	0.6	0.2	–	–
1	110 V	A	0.08	0.2	–	–
1	220 V	A	0.08	0.1	–	–
DC-13 L/R $\leq 300$ ms						
Contacts in series:						
1	24 V	A	0.6	1	–	–
1	60 V	A	0.2	0.2	–	–
1	110 V	A	0.08	0.2	–	–
1	220 V	A	0.03	0.1	–	–
Safe isolation according to EN 61140						
Between coil and auxiliary contacts		V AC	–	250	–	–
Between the auxiliary contacts		V AC	–	250	–	–
Control circuit reliability (at $U_e = 24$ V DC, $U_{min} = 17$ V, $I_{min} = 5.4$ mA)	Fault probability	$\lambda$	$<10^{-8}$ , < one failure in 100 million operations	–	–	–
Conventional thermal current	$I_{th}$	A	6	4	–	–
Component lifespan						
AC-15						
230 V, $I_e = 0.1$ A	Switch operations	$\times 10^6$	7	–	–	–
230 V, $I_e = 1.2$ A	Switch operations	$\times 10^6$	1	–	–	–
Short-circuit rating without welding						
Short-circuit protection rating maximum fuse <sup>2)</sup>						
500 V		A gG/gL	–	4	2	2
500 V		A fast	4	–	–	–

### Notes

<sup>1)</sup> Switch-on and switch-off conditions based on DC-13, time constant as specified

<sup>2)</sup> See transparent overlay "Fuses" for time/current characteristics (please enquire)

# 1.1

## Contactors

Amplifier modules, electronic timer module, contactor monitoring device

### 1 ETS-VS3, DILM, CMD

			ETS4-VS3	DILM32-XTE	CMD(24VDC) CMD(220-240VAC)
<b>Magnet systems</b>					
Voltage tolerance					
Starting voltage					
AC operated					
	Pick-up	x U <sub>c</sub>	–	0.85 - 1.1	0.85 - 1.1
DC operated <sup>1)</sup>					
	Pick-up	x U <sub>c</sub>	0.85 - 1.2	0.7 - 1.2	0.85 - 1.1
Power consumption					
AC operated	Sealing	VA	–	2	4
AC operated	Sealing	W	–	1.8	4
DC operated	Pick-up = sealing	W	0.6	–	4
Duty factor		% DF	100	100	100
Changeover times at 100 % U <sub>c</sub> (recommended values)					
DC operated closing delay		ms	7	–	–
DC operated opening delay		ms	3	–	–
Maximum operating frequency					
Max. operating frequency		Ops/h	–	3600	–
6 A/250 V		Ops/h	–	360	–
Minimum on duration					
On-delayed		ms	–	< 50	–
Off-delayed		ms	–	< 200	–
Repetition accuracy (with constant parameters)	Deviation	%	–	< 5	–
Recovery time (after 100% time delay)		ms	–	70	–
Contact changeover time					
DILM32-XTEE11/DILM32-XTED11	t <sub>0</sub>	ms	–	10	–
DILM32-XTEY20	t <sub>0</sub>	ms	–	50	–
CMD	t <sub>0</sub>	ms	–	–	100 ± 20%

#### Notes

<sup>1)</sup> Smoothed DC, three-phase bridge rectifier or smoothed two-phase bridge rectifier

## DILEEM, DILEM

			DILEEM DILEM DILEM12	DILEEM-G DILEM-G DILEM12-G	DILEM4	DILEM4-G
<b>General</b>						
Standards			IEC/EN 60947, VDE 0660, CSA, UL			
Lifespan, mechanical; Coil 50/60 Hz	at 50 Hz		7	–	7	–
Lifespan, mechanical	c (contacts)	x 10 <sup>6</sup>	10	20	20	–
Maximum operating frequency						
Mechanical		Ops/h	9000			
Electrical (Contactor without overload relay)			→ Characteristic curves Page 91			
Climatic proofing						
			Damp heat, constant, to IEC 60068-2-78 Damp heat, cyclic, to IEC 60068-2-30			
Ambient temperature						
Open		°C	-25 - 50			
Enclosed		°C	-25 - 40			
Mounting position						
			Any, except for vertically with terminals A1/A2 below			
						
Mechanical shock resistance (IEC/EN 60068-2-27)						
Half-sinusoidal shock 10 ms						
Basic device without auxiliary contact module						
	Main circuit normally open contact	g	10			
	Auxiliary contacts NC/Normally open contact	g	10/8	10/8	–	–
Basic devices with auxiliary contact module						
	Main circuit normally open contact	g	10			
	Auxiliary contacts Normally open contact/NC	g	20/20			
Protection type						
			IP20			
Protection against direct contact when actuated from front (EN 50274)						
			Finger- and back-of-hand proof			
Weight						
		kg	0.2	0.17	0.2	0.17
Terminal capacity: main and auxiliary contacts						
Solid		mm <sup>2</sup>	1 x (0.75 - 2.5) 2 x (0.75 - 2.5)			
Flexible with ferrule		mm <sup>2</sup>	1 x (0.75 - 1.5) 2 x (0.75 - 1.5)			
Solid or stranded		AWG	18 - 14			
Terminal screw						
			M3.5			
Pozidriv screwdriver						
		Size	2			
Flat-blade screwdriver						
		mm	0.8 x 5.5 1 x 6			
Max. tightening torque						
		Nm	1.2			
Terminal capacity springloaded terminals main and control circuits						
Solid		mm <sup>2</sup>	1 x (1 - 2.5) 2 x (1 - 2.5)			
Flexible with ferrule		mm <sup>2</sup>	1 x (1 - 2.5) 2 x (1 - 2.5)			
Flat-blade screwdriver						
		mm	0.6 x 3.5			

# 1.1

## Mini contactor relays

### DILEEM, DILEM

1

				DILEEM DILEEM-G	DILEM DILEM-G	DILEM4	DILEM4-G	DILEM12 DILEM12-G	
<b>Main contacts</b>									
Rated impulse withstand voltage	$U_{imp}$	V AC		6000	6000	6000	6000	6000	
Overvoltage category/pollution degree				III/3	III/3	III/3	III/3	III/3	
Rated insulation voltage	$U_i$	V AC		690	690	690	690	690	
Rated operating voltage	$U_e$	V AC		690	690	690	690	690	
Safe isolation according to EN 61140									
Between coil and contacts		V AC		300	300	300	300	300	
Between the contacts		V AC		300	300	300	300	300	
Making capacity of up to 440 V (cos $\phi$ as specified in IEC/EN 60947)				A	110	110	110	120	
Breaking capacity	220/230 V	A		90	90	90	90	96	
	380/400 V	A		90	90	90	90	96	
	500 V	A		64	64	64	64	72	
	660/690 V	A		42	42	42	42	42	
Devices lifespan	AC-1			→ Engineering Page 88					
	AC-3			→ Engineering Page 87					
	AC-4			→ Engineering Page 87					
Short-circuit protection rating maximum fuse									
	Type "2" coordination 500 V	gL/gG	A	10	10	10	10	20	
	Type "1" coordination 500 V	gL/gG	A	20	20	20	20	35	
<b>AC voltage</b>									
AC-1 operation									
Conventional thermal current 3 pole 50 - 60 Hz									
Open		at 40 °C	$I_{th}$	A	22	22	22	22	
		at 50 °C	$I_{th}$	A	20	20	20	20	
		at 55 °C	$I_{th}$	A	19	19	19	19	
Enclosed <sup>1)</sup>		$I_{th}$	A	16	16	16	16		
Conventional thermal current, 1-pole									
Open <sup>1)</sup>		$I_{th}$	A	50	50	60	60	50	
Enclosed <sup>1)</sup>		$I_{th}$	A	40	40	50	50	40	
AC-3 operation									
Rated operational current AC-3 open, 50 - 60 Hz, 3-pole1)	220/230 V	$I_e$	A	6.6	9	9	9	12	
	240 V	$I_e$	A	6.6	9	9	9	12	
	380/400 V	$I_e$	A	6.6	9	9	9	12	
	415 V	$I_e$	A	6.6	9	9	9	12	
	440 V	$I_e$	A	6.6	9	9	9	10.5	
	500 V	$I_e$	A	5	6.4	6.4	6.4	9	
Motor rating	660/690 V	$I_e$	A	3.5	4.8	4.8	4.8	5.2	
	220/230 V	P	kW	1.5	2.2	2.2	2.2	3.5	
	240 V	P	kW	1.8	2.5	2.5	2.5	3	
	380/400 V	P	kW	3	4	4	4	5.5	
	415 V	P	kW	3.1	4.3	4.3	4.3	5.5	
	440 V	P	kW	3.3	4.6	4.6	4.6	5.5	
AC-4 operation	500 V	P	kW	3	4	4	4	5.5	
	660/690 V	P	kW	3	4	4	4	4	
	Rated operational current AC-4 open, 50 - 60 Hz, 3-pole1)	220/230 V	$I_e$	A	5	6.6	6.6	6.6	6.6
		240 V	$I_e$	A	5	6.6	6.6	6.6	6.6
		280/400 V	$I_e$	A	5	6.6	6.6	6.6	6.6
		415 V	$I_e$	A	5	6.6	6.6	6.6	6.6
440 V		$I_e$	A	5	6.6	6.6	6.6	6.6	
500 V		$I_e$	A	3.7	5	5	5	5	
Rated operational power	660/690 V	$I_e$	A	2.9	3.4	3.4	3.4	3.4	
	220/230 V	P	kW	1.1	1.5	1.5	1.5	1.5	
	240 V	P	kW	1.3	1.8	1.8	1.8	1.8	
	380/400 V	P	kW	2.2	3	3	3	3	
	415 V	P	kW	2.3	3.1	3.1	3.1	3.1	
	440 V	P	kW	2.4	3.3	3.3	3.3	3.3	
500 V	P	kW	2.2	3	3	3	2.2		
660/690 V	P	kW	2.2	3	3	3	2.2		

#### Notes

<sup>1)</sup> At maximum permissible ambient air temperature

DILEEM, DILEM

				DILEEM	DILEEM-G	DILEM	DILEM-G	DILEM4	DILEM4-G	DILEM12	DILEM12-G
<b>DC voltage</b>											
Operations				→ Engineering Page 92							
Rated operational current open											
DC-1	12 V	$I_e$	A	20	20	20	20	20	20	20	20
	24 V	$I_e$	A	20	20	20	20	20	20	20	20
	60 V	$I_e$	A	20	20	20	20	20	20	20	20
	110 V	$I_e$	A	20	20	20	20	20	20	20	20
	220 V	$I_e$	A	20	20	20	20	20	20	20	20
DC-3	12 V	$I_e$	A	6	6	8	8	8	8	8	8
	24 V	$I_e$	A	6	6	8	8	8	8	6	8
	60 V	$I_e$	A	3	3	4	4	4	4	4	4
	110 V	$I_e$	A	2	2	3	3	3	3	3	3
	220 V	$I_e$	A	–	–	–	–	1	1	–	–
DC-5	12 V	$I_e$	A	1.8	1.8	2.5	2.5	2.5	2.5	2.5	2.5
	24 V	$I_e$	A	1.8	1.8	2.5	2.5	2.5	2.5	2.5	2.5
	60 V	$I_e$	A	1.8	1.8	2.5	2.5	2.5	2.5	2.5	2.5
	110 V	$I_e$	A	1.8	1.8	1.5	1.5	2.5	2.5	1.5	1.5
	220 V	$I_e$	A	0.2	0.2	0.3	0.3	1	1	0.3	0.3
Current heat loss (3-pole or 4-pole)											
At $I_{th}$			W	2	3.5	2	3.5	2.7	4.7	2	3.5
At $I_e$ to AC-3/400 V			W	0.5	0.7	0.5	0.7	–	–	0.5	0.7
<b>Magnet systems</b>											
Voltage tolerance											
Single-voltage coil 50 Hz and dual-voltage coil 50 Hz, 60 Hz		Pick-up	$x U_c$	0.8 - 1.1	–	0.8 - 1.1	–	0.8 - 1.1	–	0.8 - 1.1	–
Dual-frequency coil 50/60 Hz		Pick-up	$x U_c$	0.8 - 1.1	–	0.85 - 1.1	–	0.85 - 1.1	–	0.8 - 1.1	–
DC operated		Pick-up	$x U_c$	–	0.8 - 1.1	–	0.8 - 1.1	–	0.85 - 1.1	–	0.8 - 1.1
Power consumption											
AC operation	Single-voltage coil, 50 Hz, and dual-voltage coil, 50 Hz, 60 Hz	Pick-up	VA	25	–	25	–	25	–	25	–
		Pick-up	W	22	–	22	–	22	–	22	–
		Sealing	VA	4.6	–	4.6	–	4.6	–	4.6	–
		Sealing	W	1.3	–	1.3	–	1.3	–	1.3	–
	Dual-frequency coil 50/60 Hz at 50 Hz	Pick-up	VA	30	–	30	–	30	–	30	–
		Pick-up	W	26	–	26	–	26	–	26	–
		Sealing	VA	5.4	–	5.4	–	5.4	–	5.4	–
		Sealing	W	1.6	–	1.6	–	1.6	–	1.6	–
	Dual-frequency coil 50/60 Hz at 60 Hz	Pick-up	VA	29	–	29	–	29	–	29	–
		Pick-up	W	24	–	24	–	24	–	24	–
		Sealing	VA	3.9	–	3.9	–	3.9	–	3.9	–
		Sealing	W	1.1	–	1.1	–	1.1	–	1.1	–
	Single-voltage coil, 50 Hz, and dual-voltage coil, 50 Hz, 60 Hz	Pick-up	VA	25	–	25	–	25	–	25	–
		Pick-up	VA	30	–	30	–	30	–	30	–
Pick-up		VA	29	–	29	–	29	–	29	–	
Pick-up		VA	29	–	29	–	29	–	29	–	
DC operation <sup>1)</sup>	Power consumption pick-up = sealing		VA/W	–	2.6	–	2.6	–	2.6	–	2.6
Duty fac tor			% DF	100	100	100	100	100	100	100	100
Switching times at 100 % $U_c$											
N/O	Closing delay min.		ms	14	26	14	26	14	26	14	26
	Closing delay max.		ms	21	35	21	35	21	35	21	35
	Opening delay min.		ms	8	15	8	15	8	15	8	15
	Opening delay max.		ms	18	25	18	25	18	25	18	25
	Closing delay with top mounting auxiliary contact		ms	Max. 45	Max. 70	Max. 45	Max. 70	Max. 45	Max. 70	Max. 45	Max. 70
Reversing con-	Changeover time at 110 % $U_c$ factors										
	Changeover time min.		ms	16	40	16	40	16	40	16	40
	Changeover time maX.		ms	21	50	21	50	21	50	21	50
Arcing time at 690 V AC		ms	Max. 12	Max. 12	Max. 12	Max. 12	Max. 12	Max. 12	Max. 12	Max. 12	Max. 12
Coil	Lifespan, mechanical; Coil 50/60 Hz		c(contacts) x 10 <sup>6</sup>	7	–	7	–	7	–	7	–

Notes

<sup>1)</sup> Smoothed DC or three-phase bridge rectifier

# 1.1 Mini contactor relays

## DILEEM, DILEM

1

		DILE(E)M(-12)...		...DILEM
<b>Auxiliary contact</b>				
Interlocked opposing contacts to EN 60947-5-1 Annex L, including auxiliary contact module		Yes		Yes
Rated impulse withstand voltage	$U_{imp}$	V AC	6000	6000
Overvoltage category/pollution degree		III/3		III/3
Rated insulation voltage	$U_i$	V AC	690	690
Rated operating voltage	$U_e$	V AC	600	600
Safe isolation according to EN 61140				
Between coil and auxiliary contacts		V AC	300	300
Between the auxiliary contacts		V AC	300	300
Rated operational current				
AC-15				
	220/240 V	$I_e$	A	6
	380/415 V	$I_e$	A	3
	500 V	$I_e$	A	1.5
DC	$L/R \leq 15$ ms			
Contacts in series:				
	1	24 V	A	2.5
	2	60 V	A	2.5
	3	100 V	A	1.5
	3	220 V	A	0.5
Conventional thermal current		$I_{th}$	A	10
Control circuit reliability (at $U_e = 24$ V DC, $U_{min} = 17$ V, $I_{min} = 5.4$ mA)		Fault probability	$\lambda$	$<10^{-8}$ , < one failure in 100 million operations
Component lifespan at $U_e = 240$ V				
AC-15		c (contacts)	$\times 10^6$	0.2
DC <sup>1)</sup>				
	$L/R = 50$ ms: 2 contacts in series at $I_e = 0.5$ A	c (contacts)	$\times 10^6$	0.15
Short-circuit rating without welding				
Maximum overcurrent protective device		PKZM0-4		PKZM0-4
Short-circuit protection rating maximum fuse				
	500 V	A gG/gL	6	6
	500 V	A fast	10	10
Current heat loss at load of $I_{th}$				
	Per contact	W	0.2	0.2

**Notes** <sup>1)</sup> Switch-on and switch-off conditions based on DC-13, time constant as specified

## DILM7 ... DILM170

1

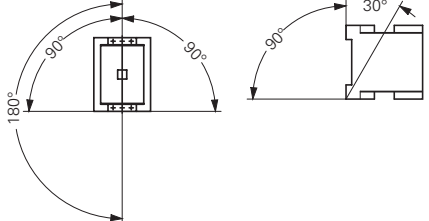
			DILM7	DILM9	DILM12	DILM15	DILM17	DILM25
<b>General</b>								
Standards			IEC/EN 60947, VDE 0660, UL, CSA					
Lifespan, mechanical								
AC operated	c (contacts)	x 10 <sup>6</sup>	10	10	10	10	10	10
DC operated	c (contacts)	x 10 <sup>6</sup>	10	10	10	10	10	10
Operating frequency, mechanical								
Mechanical, AC operated	Operations/h		9000	9000	9000	5000	5000	5000
DC operated	Operations/h		9000	9000	9000	5000	5000	5000
Maximum operating frequency								
Electrical (Contactor without overload relay)			→ Characteristic curves Page 74					
Climatic proofing								
			Damp heat, constant, to IEC 60068-2-78 Damp heat, cyclic, to IEC 60068-2-30					
Ambient temperature								
Open	°C		-25...60	-25...60	-25...60	-25...60	-25...60	-25...60
Enclosed	°C		-25...40	-25...40	-25...40	-25...40	-25...40	-25...40
Storage	°C		-40 - 80	-40 - 80	-40 - 80	-40 - 80	-40 - 80	-40 - 80
Mounting position AC- and DC operated								
Mechanical shock resistance (IEC/EN 60068-2-27)								
Half-sinusoidal shock 10 ms								
Main contacts								
	N/O	g	10	10	10	10	10	10
Auxiliary contacts								
	N/O	g	7	7	7	7	7	7
	NC	g	5	5	5	5	5	5
Mechanical shock resistance (IEC/EN 60068-2-27) with table mounting								
Half-sinusoidal shock 10 ms								
Main contacts								
	N/O	g	5.7	5.7	5.7	5.7	6.9	6.9
Auxiliary contacts								
	N/O	g	3.4	3.4	3.4	3.4	5.3	5.3
	NC	g	3.4	3.4	3.4	3.4	3.5	3.5
Protection type			IP20 IP20 IP20 IP20 IP00 IP00					
Protection against direct contact when actuated from front (EN 50274)			Finger- and back-of-hand proof					
Weight								
AC operated	kg		0.23	0.23	0.23	0.23	0.42	0.42
DC operated	kg		0.28	0.28	0.28	0.28	0.48	0.48
Terminal type, screw connection								
Terminal capacity of main cable								
Solid	mm <sup>2</sup>		1 x (0.75 - 4) 2 x (0.75 - 2.5)				1 x (0.75 - 16) 2 x (0.75 - 10)	
Flexible with ferrule	mm <sup>2</sup>		1 x (0.75 - 2.5) 2 x (0.75 - 2.5) <sup>1)</sup>				1 x (0.75 - 16) 2 x (0.75 - 10)	
Stranded	mm <sup>2</sup>		-				1 x 16 1 x 16	
Solid or stranded	AWG		18 - 10 18 - 10 18 - 10 18 - 10				18 - 6 18 - 6	
Flat conductor	mm	Number of layers x width x thickness	-				-	
Terminal capacity of control circuit cable								
Solid	mm <sup>2</sup>		1 x (0.75 - 4) 2 x (0.75 - 2.5)				1 x (0.75 - 4) 2 x (0.75 - 4)	
Flexible with ferrule	mm <sup>2</sup>		1 x (0.75 - 2.5) 2 x (0.75 - 2.5)				1 x (0.75 - 2.5) 2 x (0.75 - 2.5)	
Solid or stranded	AWG		18 - 10 18 - 10 18 - 10 18 - 10				18 - 14 18 - 14	

## Notes

<sup>1)</sup> Also without ferrule.

DILM32	DILM38	DILM40	DILM50	DILM65	DILM72	DILM80	DILM95	DILM115	DILM150	DILM170
--------	--------	--------	--------	--------	--------	--------	--------	---------	---------	---------

IEC/EN 60947, VDE 0660, UL, CSA

10	10	10	10	10	10	10	10	10	10	10
10	10	10	10	10	10	10	10	10	10	10
5000	5000	5000	5000	5000	5000	3600	3600	3600	3600	3000
5000	5000	5000	5000	5000	5000	3600	3600	3600	3600	3000

→ Characteristic curves Page 74

Damp heat, constant, to IEC 60068-2-78

Damp heat, cyclic, to IEC 60068-2-30

-25...60	-25...60	-25...60	-25...60	-25...60	-25...60	-25...60	-25...60	-25...60	-25...60	-25...60
-25...40	-25...40	-25...40	-25...40	-25...40	-25...40	-25...40	-25...40	-25...40	-25...40	-25...40
-40 - 80	-40 - 80	-40 - 80	-40 - 80	-40 - 80	-40 - 80	-40 - 80	-40 - 80	-40 - 80	-40 - 80	-40 - 80

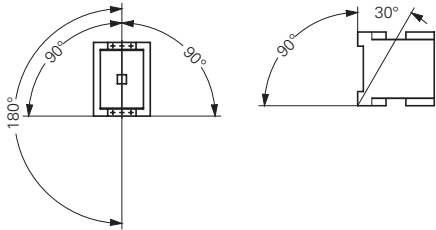

10	10	10	10	10	10	10	10	10	10	10
7	7	7	7	7	7	7	7	7	7	7
5	5	5	5	5	5	5	5	5	5	5

6.9	6.9	10	10	10	10	10	10	10	10	10
5.3	5.3	7	7	7	7	7	7	7	7	7
3.5	3.5	5	5	5	5	5	5	5	5	5
IP00	IP00	IP00	IP00	IP00	IP00	IP00	IP00	IP00	IP00	IP00

Finger- and back-of-hand proof

0.42	0.42	0.9	0.9	0.9	0.9	2	2	2	2	2
0.48	0.48	1.1	1.1	1.1	1.1	2.1	2.1	2.1	2.1	2.1

1 x (0.75 - 16) 2 x (0.75 - 10)		1 x (0.75 - 16) 2 x (0.75 - 16)				-	-	-	-	-
1 x (0.75 - 16) 2 x (0.75 - 10)		1 x (0.75 - 35) 2 x (0.75 - 25)				1 x (10 - 95) 2 x (10 - 70)				
1 x 16	1 x 16	1 x (16 - 50) 2 x (16 - 35)				1 x (16 - 95) 2 x (16 - 70)				
18 - 6	18 - 6	12 - 2	12 - 2	12 - 2	12 - 2	8...3/0	8...3/0	8...3/0	8...3/0	8...3/0
-	-	2 x (6 x 9 x 0.8)				2 x (6 x 16 x 0.8)				

1 x (0.75 - 4)  
2 x (0.75 - 4)  
1 x (0.75 - 2.5)  
2 x (0.75 - 2.5)

18 - 14	18 - 14	18 - 14	18 - 14	18 - 14	18 - 14	18 - 14	18 - 14	18 - 14	18 - 14	18 - 14
---------	---------	---------	---------	---------	---------	---------	---------	---------	---------	---------



## 1 DILM7 ... DILM170

			DILM7	DILM9	DILM12	DILM15	DILM17	DILM25
<b>General</b>								
Main cable connection screw/bolt			M3.5	M3.5	M3.5	M3.5	M5	M5
Tightening torque	Nm		1.2	1.2	1.2	1.2	3.2	3.2
Control circuit cable connection screw/bolt			M3.5	M3.5	M3.5	M3.5	M3.5	M3.5
Tightening torque	Nm		1.2	1.2	1.2	1.2	1.2	1.2
<b>Tools</b>								
Main conductors								
Pozidriv screwdriver		Size	2	2	2	2	2	2
Internal hexagon	SW	mm	–	–	–	–	–	–
Flat-blade screwdriver		mm	0.8 x 5.5 1 x 6	0.8 x 5.5 1 x 6	0.8 x 5.5 1 x 6	0.8 x 5.5 1 x 6	0.8 x 5.5 1 x 6	0.8 x 5.5 1 x 6
Auxiliary conductors								
Pozidriv screwdriver		Size	2	2	2	2	2	2
Flat-blade screwdriver		mm	0.8 x 5.5 1 x 6	0.8 x 5.5 1 x 6	0.8 x 5.5 1 x 6	0.8 x 5.5 1 x 6	0.8 x 5.5 1 x 6	0.8 x 5.5 1 x 6
Terminal type spring-cage terminal								
Terminal capacity of main cable								
Solid		mm <sup>2</sup>	1 x (0.75 - 2.5) 2 x (0.75 - 2.5)				–	–
Flexible		mm <sup>2</sup>	1 x (0.75 - 2.5) 2 x (0.75 - 2.5)				–	–
Flexible with ferrule		mm <sup>2</sup>	1 x (0.75 - 1.5) 2 x (0.75 - 1.5)				–	–
Flexible without ferrule		mm <sup>2</sup>	1 x (0.75 - 2.5) 2 x (0.75 - 2.5)				–	–
Solid or stranded		AWG	18 - 14	18 - 14	18 - 14	18 - 14	–	–
Terminal capacity of control circuit cable								
Solid		mm <sup>2</sup>	1 x (0.75 - 2.5) 2 x (0.75 - 2.5)					
Flexible		mm <sup>2</sup>	1 x (0.75 - 2.5) 2 x (0.75 - 2.5)					
Flexible with ferrule		mm <sup>2</sup>	1 x (0.75 - 1.5) 2 x (0.75 - 1.5)					
Flexible without ferrule		mm <sup>2</sup>	1 x (0.75 - 2.5) 2 x (0.75 - 2.5)				–	–
Solid or stranded		AWG	18 - 14	18 - 14	18 - 14	18 - 14	18 - 14	18 - 14
<b>Tools</b>								
Strip length		mm	10	10	10	10	10	10
Screwdriver blade width		mm	3.5	3.5	3.5	3.5	3.5	3.5
<b>Main contacts</b>								
Rated impulse withstand voltage	$U_{imp}$	V AC	8000	8000	8000	8000	8000	8000
Overvoltage category/pollution degree			III/3	III/3	III/3	III/3	III/3	III/3
Rated insulation voltage	$U_i$	V AC	690	690	690	690	690	690
Rated operating voltage	$U_e$	V AC	690	690	690	690	690	690
Safe isolation according to EN 61140								
Between coil and contacts		V AC	400	400	400	400	440	440
Between the contacts		V AC	400	400	400	400	440	440
Making capacity (cos $\Phi$ to IEC/EN 60947)	To 690 V	A	112	112	144	155	238	350
Breaking capacity								
230 V		A	70	90	120	124	170	250
280/400 V		A	70	90	120	124	170	250
500 V		A	50	70	100	100	170	250
660/690 V		A	40	50	70	70	120	150
Short-circuit rating								
Short-circuit protection rating maximum fuse								
Type "2" coordination								
400 V	gG/gL 500 V	A	20	20	20	20	35	35
690 V	gG/gL 690 V	A	16	16	20	20	35	35
Type "1" coordination								
400 V	gG/gL 500 V	A	35	35	35	63	63	100
690 V	gG/gL 690 V	A	20	20	25	50	50	50

DILM32	DILM38	DILM40	DILM50	DILM65	DILM72	DILM80	DILM95	DILM115	DILM150	DILM170
M5	M5	M6	M6	M6	M6	M10	M10	M10	M10	M10
3.2	3.2	3.3	3.3	3.3	3.3	14	14	14	14	14
M3.5	M3.5	M3.5	M3.5	M3.5	M3.5	M3.5	M3.5	M3.5	M3.5	M3.5
1.2	1.2	1.2	1.2	1.2	1.2	1.2	1.2	1.2	1.2	1.2
2	2	2	2	2	2	–	–	–	–	–
–	–	–	–	–	–	5	5	5	5	5
0.8 x 5.5 1 x 6	0.8 x 5.5 1 x 6	0.8 x 5.5 1 x 6	0.8 x 5.5 1 x 6	0.8 x 5.5 1 x 6	0.8 x 5.5 1 x 6	–	–	–	–	–
2	2	2	2	2	2	2	2	2	2	2
0.8 x 5.5 1 x 6	0.8 x 5.5 1 x 6	0.8 x 5.5 1 x 6	0.8 x 5.5 1 x 6	0.8 x 5.5 1 x 6	0.8 x 5.5 1 x 6	0.8 x 5.5 1 x 6	0.8 x 5.5 1 x 6	0.8 x 5.5 1 x 6	0.8 x 5.5 1 x 6	0.8 x 5.5 1 x 6
–	–	–	–	–	–	–	–	–	–	–
–	–	–	–	–	–	–	–	–	–	–
–	–	–	–	–	–	–	–	–	–	–
–	–	–	–	–	–	–	–	–	–	–
–	–	–	–	–	–	–	–	–	–	–
1 x (0.75 - 2.5) 2 x (0.75 - 2.5)										
1 x (0.75 - 2.5) 2 x (0.75 - 2.5)										
1 x (0.75 - 1.5) 2 x (0.75 - 1.5)										
–	–	–	–	–	–	–	–	–	–	–
18 - 14	18 - 14	18 - 14	18 - 14	18 - 14	18 - 14	18 - 14	18 - 14	18 - 14	18 - 14	18 - 14
10	10	10	10	10	10	10	10	10	10	10
3.5	3.5	3.5	3.5	3.5	3.5	3.5	3.5	3.5	3.5	3.5
8000	8000	8000	8000	8000	8000	8000	8000	8000	8000	8000
III/3	III/3	III/3	III/3	III/3	III/3	III/3	III/3	III/3	III/3	III/3
690	690	690	690	690	690	690	690	690	690	690
690	690	690	690	690	690	690	690	690	690	690
440	440	440	440	440	440	690	690	690	690	690
440	440	440	440	440	440	690	690	690	690	690
384	384	560	700	910	910	1120	1330	1610	2100	2100
320	320	400	500	650	650	800	950	1150	1500	1500
320	320	400	500	650	650	800	950	1150	1500	1500
320	320	400	500	650	650	800	950	1150	1500	1500
180	180	250	320	370	370	650	800	1100	1200	1320
63	63	63	80	125	125	160	160	250	250	250
35	35	50	63	80	80	160	160	250	250	250
125	125	125	160	250	250	250	250	250	250	250
63	63	80	80	100	100	200	200	250	250	250

# 1.1

## Contactors

Basic devices up to 170 A

### 1 DILM7 ... DILM170

				DILM7	DILM9	DILM12	DILM15	DILM17	DILM25	
<b>AC voltage</b>										
AC-1 operation										
Conventional free air thermal current 3 pole 50 - 60 Hz	Open	at 50 °C	$I_{th}$	A	22	22	22	22	40	45
		at 50 °C	$I_{th}$	A	21	21	21	21	38	43
	Enclosed	at 55 °C	$I_{th}$	A	21	21	21	21	37	42
		at 60 °C	$I_{th}$	A	20	20	20	20	35	40
Conventional free air thermal current 1 pole	Open		$I_{th}$	A	50	50	50	50	88	100
	Enclosed		$I_{th}$	A	45	45	45	45	80	90
AC-3 operation										
Rated operational current AC -3 open, 50 - 60 Hz, 3 pole	220/230 V		$I_e$	A	7	9	12	15.5	18	25
	240 V		$I_e$	A	7	9	12	15.5	18	25
	380/400 V		$I_e$	A	7	9	12	15.5	18	25
	415 V		$I_e$	A	7	9	12	15.5	18	25
	440 V		$I_e$	A	7	9	12	15.5	18	25
	500 V		$I_e$	A	5	7	10	12.5	18	25
	660/690 V		$I_e$	A	4	5	7	9	12	15
Rated operational power	220/230 V	P	kW	2.2	2.5	3.5	4	5	7.5	
	240 V	P	kW	2.2	3	4	4.6	5.5	8.5	
	380/400 V	P	kW	3	4	5.5	7.5	7.5	11	
	415 V	P	kW	4	5.5	7	8	10	14.5	
	440 V	P	kW	4.5	5.5	7.5	8.4	10.5	15.5	
	500 V	P	kW	3.5	4.5	7	7.5	12	17.5	
	660/690 V	P	kW	3.5	4.5	6.5	7	11	14	
AC-4 operation										
Rated operational current AC-4 open, 50 - 60 Hz, 3 pole	220/230 V		$I_e$	A	5	6	7	7	10	13
	240 V		$I_e$	A	5	6	7	7	10	13
	380/400 V		$I_e$	A	5	6	7	7	10	13
	415 V		$I_e$	A	5	6	7	7	10	13
	440 V		$I_e$	A	5	6	7	7	10	13
	500 V		$I_e$	A	4.5	5	6	6	10	13
	660/690 V		$I_e$	A	4	4.5	5	5	8	10
Rated operational power	220/230 V	P	kW	1	1.5	2	2	2.5	3.5	
	240 V	P	kW	1.5	1.6	2.2	2.2	3	4	
	380/400 V	P	kW	2.2	2.5	3	3	4.5	6	
	415 V	P	kW	2.3	2.8	3.4	3.4	5	6.5	
	440 V	P	kW	2.4	3	3.6	3.6	5.5	7	
	500 V	P	kW	2.5	2.8	3.5	3.5	6	8	
	660/690 V	P	kW	2.9	3.6	4.4	4.4	6.5	8.5	
<b>DC voltage</b>										
Operations				→ Switching of DC current Page 92						
Rated operational current $I_e$ open										
DC-1 operation	60 V		$I_e$	A	20	20	20	20	35	40
	110 V		$I_e$	A	20	20	20	20	35	40
	220 V		$I_e$	A	15	15	15	15	35	40
	440 V		$I_e$	A	1	1.3	1.3	1.3	2.9	2.9
DC-3 operation	660 V		$I_e$	A	20	20	20	20	35	35
	110 V		$I_e$	A	20	20	20	20	35	35
	220 V		$I_e$	A	1.5	1.5	1.5	1.5	10	10
	440 V		$I_e$	A	0.2	0.2	0.2	0.2	0.6	0.6
DC-5 operation	60 V		$I_e$	A	20	20	20	20	35	35
	110 V		$I_e$	A	20	20	20	20	35	35
	220 V		$I_e$	A	1.5	1.5	1.5	1.5	10	10
	440 V		$I_e$	A	0.2	0.2	0.2	0.2	0.6	0.6

DILM32	DILM38	DILM40	DILM50	DILM65	DILM72	DILM80	DILM95	DILM115	DILM150	DILM170
45	45	60	80	98	98	110	130	160	190	225
43	43	57	71	88	88	98	125	142	180	200
42	42	55	68	83	83	94	115	135	170	190
40	40	50	65	80	80	90	110	130	160	185
36	36	45	58	72	72	80	100	115	144	166
100	100	125	162	200	200	225	275	325	400	460
90	90	112	145	180	180	200	250	285	360	415
32	38	40	50	65	72	80	95	115	150	170
32	38	40	50	65	72	80	95	115	150	170
32	38	40	50	65	72	80	95	115	150	170
32	38	40	50	65	72	80	95	115	150	170
32	38	40	50	65	72	80	95	115	150	170
32	38	40	50	65	72	80	95	115	150	170
18	22.5	25	32	37	37	65	80	93	100	150
10	11	12.5	15.5	20	22	25	30	37	48	52
11	12	13.5	17	22	25	27.5	32	40	52	57
15	18.5	18.5	22	30	37	37	45	55	75	90
19	20	24	30	39	41	48	57	70	91	100
20	21	25	32	41	44	51	60	75	95	105
23	24	28	36	47	50	58	70	85	110	120
17	21	23	30	35	35	63	75	90	96	140
15	15	18	21	25	25	40	50	55	65	65
15	15	18	21	25	25	40	50	55	65	65
15	15	18	21	25	25	40	50	55	65	65
15	15	18	21	25	25	40	50	55	65	65
15	15	18	21	25	25	40	50	55	65	65
12	12	14	17	20	20	27	37	45	50	50
4	4	5	6	7	7	12	16	17	20	20
4.5	4.5	5.5	6.5	7.5	7.5	13	17	19	22	22
7	7	9	10	12	12	20	26	28	33	33
7.5	7.5	9.5	11	13	13	24	30	33	39	39
8	8	10	12	14	14	25	32	35	41	41
9	9	11	13	16	16	29	36	40	47	47
10	10	12	14	17	17	26	35	43	48	48
40	40	50	60	72	72	110	110	160	160	160
40	40	50	50	72	72	110	110	160	160	160
40	40	45	45	65	65	70	70	90	90	90
2.9	2.9	2.9	2.9	2.9	2.9	4.5	4.5	4.5	4.5	4.5
40	40	50	60	72	72	110	110	160	160	160
40	40	50	50	72	72	110	110	160	160	160
25	25	25	25	35	35	35	35	40	40	40
0.6	0.6	0.6	0.6	0.6	0.6	1	1	1	1	1
40	40	50	60	72	72	110	110	160	160	160
40	40	50	50	72	72	110	110	160	160	160
10	10	25	25	35	35	35	35	40	40	40
0.6	0.6	0.6	0.6	0.6	0.6	1	1	1	1	1

## 1 DILM7 ... DILM170

			DILM7	DILM9	DILM12	DILM15	DILM17	DILM25
<b>Current heat loss (3 pole)</b>								
Current heat loss at $I_{th}$	W		3	3	3	3	7.3	9.6
Current heat loss at $I_e$ to AC-3/400 V	W		0.37	0.6	1.1	1.8	1.9	3.8
Impedance per pole	mΩ		2.5	2.5	2.5	2.5	2	2
<b>Magnet systems</b>								
Voltage tolerance								
AC operated	Pick-up	x $U_c$	0.8 - 1.1	0.8 - 1.1	0.8 - 1.1	0.8 - 1.1	0.8 - 1.1	0.8 - 1.1
AC operated	Drop-out	x $U_c$	0.3 - 0.6	0.3 - 0.6	0.3 - 0.6	0.3 - 0.6	0.3 - 0.6	0.3 - 0.6
DC operated <sup>3)</sup>	Pick-up	x $U_c$	0.8 - 1.1	0.8 - 1.1 <sup>1)</sup>	0.8 - 1.1 <sup>1)</sup>	0.8 - 1.1 <sup>1)</sup>	0.7 - 1.2 <sup>2)</sup>	0.7 - 1.2 <sup>2)</sup>
DC operated <sup>3)</sup>	Drop-out	x $U_c$	0.15 - 0.6	0.15 - 0.6	0.15 - 0.6	0.15 - 0.6	0.15 - 0.6	0.15 - 0.6
Power consumption of the coil in a cold state and 1.0 x $U_c$								
50 Hz	Pick-up	VA	24	24	24	24	52	52
50 Hz	Sealing	VA	3.4	3.4	3.4	3.4	7.1	7.1
50 Hz	Sealing	W	1.2	1.2	1.2	1.2	2.1	2.1
60 Hz	Pick-up	VA	30	30	30	30	67	67
60 Hz	Sealing	VA	4.4	4.4	4.4	4.4	8.7	8.7
60 Hz	Sealing	W	1.4	1.4	1.4	1.4	2.6	2.6
50/60 Hz	Pick-up	VA	27	27	27	27	62	62
			25	25	25	25	58	58
50/60 Hz	Sealing	VA	4.2	4.2	4.2	4.2	9.1	9.1
			3.3	3.3	3.3	3.3	6.5	6.5
50/60 Hz	Sealing	W	1.4	1.4	1.4	1.4	2.5	2.5
			1.2	1.2	1.2	1.2	2	2
DC operated	Pick-up	W	3	3	4.5	4.5	12	12
DC operated	Sealing	W	3	3	4.5	4.5	0.5	0.5
Duty factor	% DF		100	100	100	100	100	100
Changeover times at 100 % $U_c$ (recommended values)								
Main contacts								
AC operated	Closing delay	ms	15...21	15...21	15...21	15...21	16...22	16...22
	Opening delay	ms	9...18	9...18	9...18	9...18	8...14	8...14
DC operated	Closing delay	ms	31	31	31	31	47	47
	Opening delay	ms	12	12	12	12	30	30
Arcing time		ms	10	10	10	10	10	10
Permissible residual current when A1 - A2 are actuated from the electronic system (with 0 signal)		mA	–	–	–	–	–	–
Lifespan, mechanical; Coil 50/60 Hz		At 50 Hz	Mechanical lifespan at 50 Hz approx. 30% lower than under → Technical data general					
<b>Electromagnetic compatibility (EMC)</b>								
Emitted interference			To EN 60947-1					
Interference immunity			To EN 60947-1					

**Notes**

<sup>1)</sup> At 24 V DC: 0.7 – 1.3 without auxiliary contact module and at ambient temperature + 40 °C

<sup>2)</sup> RDC 24 (Umin 24 V DC/Umax 27 V DC)  
RDC 60 (Umin 48 V DC/Umax 60 V DC)  
RDC 130 (Umin 110 V DC/Umax 130 V DC)  
RDC 240 (Umin 200 V DC/Umax 240 V DC)

Example:  $U_c = 0.7 \times U_{min} - 1.2 \times U_{max} / U_c = 0.7 \times 24 \text{ V} - 1.2 \times 27 \text{ V DC}$

<sup>3)</sup> At least: smoothed two-phase bridge rectifier or three-phase rectifier

DILM32	DILM38	DILM40	DILM50	DILM65	DILM72	DILM80	DILM95	DILM115	DILM150	DILM170
12.1	12.1	11.3	19	28.8	28.8	12.2	18.2	20.3	30.7	41.1
6.1	6.1	7.2	11.3	19	23	9.6	13.5	15.9	27	34.7
2	2	1.5	1.5	1.5	1.5	0.5	0.5	0.4	0.4	0.4
0.8 - 1.1	0.8 - 1.1	0.8 - 1.1	0.8 - 1.1	0.8 - 1.1	0.8 - 1.1	0.8 - 1.1	0.8 - 1.1	0.8 - 1.15	0.8 - 1.15	0.8 - 1.15
0.3 - 0.6	0.3 - 0.6	0.3 - 0.6	0.3 - 0.6	0.3 - 0.6	0.3 - 0.6	0.3 - 0.6	0.3 - 0.6	0.25 - 0.6	0.25 - 0.6	0.25 - 0.6
0.7 - 1.2 <sup>2)</sup>	0.7 - 1.2 <sup>2)</sup>	0.7 - 1.2 <sup>2)</sup>	0.7 - 1.2 <sup>2)</sup>	0.7 - 1.2 <sup>2)</sup>	0.7 - 1.2 <sup>2)</sup>	0.7 - 1.2 <sup>2)</sup>	0.7 - 1.2 <sup>2)</sup>	0.7 - 1.2 <sup>2)</sup>	0.7 - 1.2 <sup>2)</sup>	0.7 - 1.2 <sup>2)</sup>
0.15 - 0.6	0.15 - 0.6	0.15 - 0.6	0.15 - 0.6	0.15 - 0.6	0.15 - 0.6	0.15 - 0.6	0.15 - 0.6	0.15 - 0.6	0.15 - 0.6	0.15 - 0.6
52	52	149	149	149	149	310	310	180	180	180
7.1	7.1	16	16	16	16	26	26	3.1	3.1	3.1
2.1	2.1	4.3	4.3	4.3	4.3	5.8	5.8	2.1	2.1	2.1
67	67	178	178	178	178	345	345	170	170	170
8.7	8.7	19	19	19	19	30	30	3.1	3.1	3.1
2.6	2.6	5.3	5.3	5.3	5.3	7.1	7.1	2.1	2.1	2.1
62	62	168	168	168	168	372	372	170	170	170
58	58	154	154	154	154	328	328	170	170	170
9.1	9.1	22	22	22	22	37.1	37.1	3.1	3.1	3.1
6.5	6.5	14	14	14	14	22.6	22.6	3.1	3.1	3.1
2.5	2.5	5.3	5.3	5.3	5.3	7.5	7.5	2.1	2.1	2.1
2	2	4.3	4.3	4.3	4.3	6.1	6.1	2.1	2.1	2.1
12	12	24	24	24	24	90	90	149	149	149
0.5	0.5	0.5	0.5	0.5	0.5	1.3	1.3	2.1	2.1	2.1
100	100	100	100	100	100	100	100	100	100	100
16...22	16...22	12...18	12...18	12...18	12...18	14...20	14...20	28...33	28...33	28...33
8...14	8...14	8...13	8...13	8...13	8...13	9...14	9...14	35...41	35...41	35...41
47	47	54	54	54	54	45	45	35	35	35
30	30	24	24	24	24	34	34	30	30	30
10	10	10	10	10	10	15	15	15	15	15
-	-	-	-	-	-	≤1	≤1	≤1	≤1	≤1

Mechanical lifespan at 50 Hz approx. 30% lower than under → Technical data general

To EN 60947-1

To EN 60947-1

# 1.1

## Contactors

Comfort devices and standard devices greater than 170 A

### 1 DILM185...DILM1600, DILH

#### Contactors

DILM185A DILM225A DILM250 DILM300A DILM400 DILM500 DILM570

General			DILM185A	DILM225A	DILM250	DILM300A	DILM400	DILM500	DILM570
Standards			IEC/EN 60947, VDE 0660, UL, CSA						
Lifespan, mechanical									
AC operated	c (contacts)	x 10 <sup>6</sup>	10	10	10	10	7	7	7
DC operated	c (contacts)	x 10 <sup>6</sup>	10	10	10	10	7	7	7
Operating frequency, mechanical									
AC operated	Operations/h		3000	3000	3000	3000	2000	2000	2000
DC operated	Operations/h		3000	3000	3000	3000	2000	2000	2000
Maximum operating frequency			→ Engineering Page 91						
Electrical (Contactor without overload relay)			→ Engineering Page 91						
Climatic proofing			Damp heat, constant, to IEC 60068-2-78 Damp heat, cyclic, to IEC 60068-2-30						
Ambient temperature									
Open		°C	-25...60	-25...60	-25...60	-25...60	-25...60	-25...60	-25...60
Enclosed		°C	-25...40	-25...40	-25...40	-25...40	-25...40	-25...40	-25...40
Storage		°C	-40 - 80	-40 - 80	-40 - 80	-40 - 80	-40 - 80	-40 - 80	-40 - 80
Mounting position: AC and DC-actuated									
Mechanical shock resistance (IEC/EN 60068-2-27)									
Half-sinusoidal shock 10 ms									
Main contacts									
N/O		g	10	10	10	10	10	10	10
Auxiliary contacts									
N/O		g	10	10	10	10	10	10	10
NC		g	8	8	8	8	8	8	8
Protection type			IP00 IP00 IP00 IP00 IP00 IP00 IP00						
Protection against direct contact when actuated from front (EN 90274)			Finger- and back-of-hand proof with cover or terminal block						
Weight									
Weight		kg	3.2	3.2	6.5	6.5	8	8	8
Terminal capacity of main cable									
Flexible with cable lug		mm <sup>2</sup>	50 - 185	50 - 185	50 - 240	50 - 240	50 - 240	50 - 240	50 - 240
Stranded with cable lug		mm <sup>2</sup>	50 - 185	70 - 185	70 - 240	70 - 240	70 - 240	70 - 240	70 - 240
Solid or stranded		AWG	1/0 - 350	2/0 - 250	2/0 - 500	2/0 - 500	2/0 - 500	2/0 - 500	2/0 - 500
		MCM		MCM	MCM	MCM	MCM	MCM	MCM
Busbar	Width	mm	32	32	25	25	25	30	30
Main cable connection screw/bolt			M10 M10 M10 M10 M10 M10 M10						
Tightening torque			Nm 24 24 24 24 24 24 24						
Terminal capacity of control circuit cable									
Solid		mm <sup>2</sup>	1 x (0.75 - 2.5) 2 x (0.75 - 2.5)						
Flexible with ferrule		mm <sup>2</sup>	1 x (0.75 - 2.5) 2 x (0.75 - 2.5)						
Solid or stranded		AWG	2 x (18 - 12)	2 x (18 - 12)	2 x (18 - 12)	2 x (18 - 12)	2 x (18 - 12)	2 x (18 - 12)	2 x (18 - 12)
Control circuit cable connection screw/bolt			M3.5 M3.5 M3.5 M3.5 M3.5 M3.5 M3.5						
Tightening torque			Nm 1.2 1.2 1.2 1.2 1.2 1.2 1.2						
Tools									
Main conductors									
Wrench		mm	16	16	16	16	16	16	16
Auxiliary conductors									
Pozidriv screwdriver		Size	2	2	2	2	2	2	2

DILM580	DILM650	DILM750	DILM820	DILM1000	DILM1600	DILH1400	DILH2000	DILH2200	DILH2600
IEC/EN 60947, VDE 0660, UL, CSA									
5	5	5	5	5	5	5	5	5	5
5	5	5	5	5	5	5	5	5	5
1000	1000	1000	1000	1000	1000	1000	1000	1000	1000
1000	1000	1000	1000	1000	1000	1000	1000	1000	1000
→ Engineering Page 91									
Damp heat, constant, to IEC 60068-2-78									
Damp heat, cyclic, to IEC 60068-2-30									
-25...60	-25...60	-25...60	-25...60	-25...60	-25...60	-25...60	-25...60	-25...60	-25...60
-25...40	-25...40	-25...40	-25...40	-25...40	-25...40	-25...40	-25...40	-25...40	-25...40
-40 - 80	-40 - 80	-40 - 80	-40 - 80	-40 - 80	-40 - 80	-40 - 80	-40 - 80	-40 - 80	-40 - 80
10	10	10	10	10	10	10	10	10	10
10	10	10	10	10	10	10	10	10	10
8	8	8	8	8	8	8	8	8	8
IP00	IP00	IP00	IP00	IP00	IP00	IP00	IP00	IP00	IP00
Finger- and back-of-hand proof with cover or terminal block									
15	15	15	15	15	32	15	32	32	32
50 - 240	50 - 240	50 - 240	50 - 240	50 - 240	–	–	–	–	–
70 - 240	70 - 240	70 - 240	70 - 240	70 - 240	–	–	–	–	–
2/0 - 500 MCM	2/0 - 500 MCM	2/0 - 500 MCM	2/0 - 500 MCM	2/0 - 500 MCM	–	–	–	–	–
50	50	60	60	60	100	80	100	100	100
M10	M10	M12	M12	M12	M12	M12	M12	M12	M12
24	24	35	35	35	35	35	35	35	35
1 x (0.75 - 2.5)									
2 x (0.75 - 2.5)									
1 x (0.75 - 2.5)									
2 x (0.75 - 2.5)									
2 x (18 - 12)	2 x (18 - 12)	2 x (18 - 12)	2 x (18 - 12)	2 x (18 - 12)	2 x (18...12)	2 x (18 - 12)	2 x (18 - 12)	2 x (18 - 12)	2 x (18 - 12)
M3.5	M3.5	M3.5	M3.5	M3.5	M3.5	M3.5	M3.5	M3.5	M3.5
1.2	1.2	1.2	1.2	1.2	1.2	1.2	1.2	1.2	1.2
16	16	18	18	18	18	18	18	18	18
2	2	2	2	2	2	2	2	2	2



# 1.1

## Contactors

Comfort devices and standard devices greater than 170 A

### 1 DILM185...DILM1600, DILH

#### Contactors

DILM185A DILM225A DILM250 DILM300A DILM400 DILM500 DILM570

#### Main contacts

			DILM185A	DILM225A	DILM250	DILM300A	DILM400	DILM500	DILM570
Rated impulse withstand voltage	$U_{imp}$	V AC	8000	8000	8000	8000	8000	8000	8000
Overvoltage category/pollution degree			III/3	III/3	III/3	III/3	III/3	III/3	III/3
Rated insulation voltage	$U_i$	V AC	1000	1000	1000	1000	1000	1000	1000
Rated operating voltage	$U_e$	V AC	1000	1000	1000	1000	1000	1000	1000
Safe isolation according to EN 61140									
Between coil and contacts		V AC	500	500	500	500	500	500	500
Between the contacts		V AC	500	500	500	500	500	500	500
Making capacity (cos $\Phi$ to IEC/EN 60947)		A	2700	2700	3000	3600	5500	5500	6000
Breaking capacity									
220/230 V		A	2250	2250	2500	3000	5000	5000	5800
380/440 V		A	2250	2250	2500	3000	5000	5000	5800
500 V		A	2250	2250	2500	3000	5000	5000	5800
660/690 V		A	2250	2250	2500	3000	5000	5000	5800
1000 V		A	760	760	760	950	950	950	950

Component lifespan

→ Page 87

Short-circuit rating

Short-circuit protection rating maximum fuse									
Type "2" coordination									
400 V	gG/gL 500 V	A	250	250	315	315	500	500	500
690 V	gG/gL 690 V	A	250	250	315	315	500	500	500
1000 V	gG/gL 1000 V	A	160	160	160	160	200	200	200
Type "1" coordination									
400 V	gG/gL 500 V	A	400	400	400	400	630	630	800
690 V	gG/gL 690 V	A	315	315	400	400	630	630	630
1000 V	gG/gL 1000 V	A	200	200	200	200	250	250	250

#### AC voltage

AC-1 operation

Conventional thermal current 3 pole 50 - 60 Hz									
Open									
at 40 °C	$I_{th}$	A	337	356	400	430	612	857	920
at 50 °C	$I_{th}$	A	301	310	360	385	548	767	821
at 55 °C	$I_{th}$	A	287	295	340	365	522	731	783
at 60 °C	$I_{th}$	A	275	285	330	350	500	700	750
Enclosed <sup>1)</sup>	$I_{th}$	A	245	275	300	315	450	650	–
Conventional thermal current, 1-pole									
Open <sup>1)</sup>	$I_{th}$	A	685	707	825	875	1250	1750	1875
Enclosed <sup>1)</sup>	$I_{th}$	A	625	636	742	785	1125	1600	–

AC-3 operation

Rated operational current AC -3 open, 50 – 60 Hz, 3 pole									
220/230 V	$I_e$	A	185	225	250	300	400	500	580
240 V	$I_e$	A	185	225	250	300	400	500	580
380/400 V	$I_e$	A	185	225	250	300	400	500	580
415 V	$I_e$	A	185	225	250	300	400	500	580
440 V	$I_e$	A	185	225	250	300	400	500	580
500 V	$I_e$	A	185	225	250	300	400	500	500
660/690 V	$I_e$	A	150	160	250	210	360	360	360
1000 V	$I_e$	A	76	76	76	95	95	95	95
Rated operational power									
220/230 V	P	kW	55	70	75	90	125	155	185
240 V	P	kW	62	75	85	100	132	170	200
380/400 V	P	kW	90	110	132	160	200	250	315
415 V	P	kW	110	132	148	180	240	300	348
440 V	P	kW	115	138	132	185	200	250	370
500 V	P	kW	132	160	180	215	290	360	360
660/690 V	P	kW	140	150	240	195	344	344	344
1000 V	P	kW	108	108	108	132	132	132	132

Notes

<sup>1)</sup> At maximum permissible ambient air temperature

<sup>2)</sup> To 690 V

DILM580	DILM650	DILM750	DILM820	DILM1000	DILM1600	DILH1400	DILH2000	DILH2200	DILH2600
8000	8000	8000	8000	8000	8000	8000	8000	8000	8000
III/3	III/3	III/3	III/3	III/3	III/3	III/3	III/3	III/3	III/3
1000	1000	1000	1000	1000	1000	1000	1000	1000	1000
1000	1000	1000	1000	1000	1000	1000	1000	1000	1000
500	500	500	500	500	500	500	500	500	500
500	500	500	500	500	500	500	500	500	500
7800	7800	9840	9840	9840	19000	9840	9840	9840	9840
6500	6500	8200	8200	8200	16000	8200	8200	8200	8200
6500	6500	8200	8200	8200	16000	8200	8200	8200	8200
6500	6500	8200	8200	8200	16000	8200	8200	8200	8200
6500	6500	8200	8200	8200	16000	8200	8200	8200	8200
4350	4350	5800	5800	5800	5800	5800	5800	5800	5800
→ Page 87									
630	630	630	630	630	-	-	-	-	-
630	630	630	630	630	-	-	-	-	-
500	500	630	630	630	-	-	-	-	-
1000	1000	1200	1200	1200	-	-	-	-	-
1000	1000	1200	1200	1200	-	-	-	-	-
630	630	800	800	800	-	-	-	-	-
980	1041	1102	1225	1225	2200 <sup>2)</sup>	1714 <sup>2)</sup>	2450 <sup>2)</sup>	2700 <sup>2)</sup>	3185 <sup>2)</sup>
876	931	986	1095	1095	1970 <sup>2)</sup>	1533 <sup>2)</sup>	2190 <sup>2)</sup>	2400 <sup>2)</sup>	2847 <sup>2)</sup>
836	888	940	1044	1044	1880 <sup>2)</sup>	1462 <sup>2)</sup>	2089 <sup>2)</sup>	2300 <sup>2)</sup>	2716 <sup>2)</sup>
800	850	900	1000	1000	1800 <sup>2)</sup>	1400 <sup>2)</sup>	2000 <sup>2)</sup>	2200 <sup>2)</sup>	2600 <sup>2)</sup>
-	-	-	-	-	-	-	-	-	-
2000	2125	2250	2500	2500	4500	3500	5000	5500	6500 <sup>2)</sup>
-	-	-	-	-	-	-	-	-	-
580	650	750	820	1000	1600	-	-	-	-
580	650	750	820	1000	1600	-	-	-	-
580	650	750	820	1000	1600	-	-	-	-
580	650	750	820	1000	1600	-	-	-	-
580	650	750	820	1000	1600	-	-	-	-
580	650	750	820	1000	1600	-	-	-	-
580	650	750	820	1000	1600	-	-	-	-
435	435	580	580	750	1200	-	-	-	-
185	205	240	260	315	500	-	-	-	-
200	225	260	285	340	550	-	-	-	-
315	355	400	450	560	900	-	-	-	-
348	390	455	500	610	930	-	-	-	-
370	420	480	450	650	1000	-	-	-	-
420	470	550	600	730	1180	-	-	-	-
560	630	720	750	1000	1600	-	-	-	-
600	600	800	800	1100	1770	-	-	-	-

# 1.1

## Contactors

Comfort devices and standard devices greater than 170 A

### 1 DILM185...DILM1600, DILH

#### Contactors

DILM185A DILM225A DILM250 DILM300A DILM400 DILM500 DILM570

#### AC voltage

AC-4 operation

Rated operational current AC -4 open, 50 – 60 Hz, 3 pole			DILM185A	DILM225A	DILM250	DILM300A	DILM400	DILM500	DILM570
220/230 V	I <sub>e</sub>	A	136	164	200	240	296	360	360
240 V	I <sub>e</sub>	A	136	164	200	240	296	360	360
380/400 V	I <sub>e</sub>	A	136	164	200	240	296	360	360
415 V	I <sub>e</sub>	A	136	164	200	240	296	360	360
440 V	I <sub>e</sub>	A	136	164	200	240	296	360	360
500 V	I <sub>e</sub>	A	136	164	200	240	296	360	360
660/690 V	I <sub>e</sub>	A	110	120	200	170	296	296	296
1000 V	I <sub>e</sub>	A	55	55	76	76	95	95	95
Rated operational power			DILM185A	DILM225A	DILM250	DILM300A	DILM400	DILM500	DILM570
220/230 V	P	kW	41	51	62	75	92	112	112
240 V	P	kW	45	54	68	82	101	122	122
380/400 V	P	kW	75	90	110	132	160	200	200
415 V	P	kW	80	96	117	142	176	216	216
440 V	P	kW	85	102	125	150	186	229	229
500 V	P	kW	96	116	143	172	214	260	260
660/690 V	P	kW	102	110	189	160	283	344	344
1000 V	P	kW	77	77	108	109	132	132	132

#### Capacitor operation

Individual compensation rated operational current I<sub>e</sub> of alternating current capacitor

Open			DILM185A	DILM225A	DILM250	DILM300A	DILM400	DILM500	DILM570
To 525 V		A	220	220	220	307	307	307	307
690 V		A	133	133	133	177	177	177	177
Max. peak inrush current	x I <sub>e</sub>		30	30	30	30	30	30	30
Component lifespan	c (contacts)	x 10 <sup>6</sup>	0.1	0.1	0.1	0.1	0.1	0.1	0.1
Max. operating frequency		Ops/h	200	200	200	200	200	200	200

#### DC voltage

Operations

→ Engineering Page 92

Rated operational current I<sub>e</sub> open

DC-1 operation			DILM185A	DILM225A	DILM250	DILM300A	DILM400	DILM500	DILM570
60 V	I <sub>e</sub>	A	300	300	300	400	400	400	400
110 V	I <sub>e</sub>	A	300	300	300	400	400	400	400
220 V	I <sub>e</sub>	A	300	300	300	400	400	400	400
440 V	I <sub>e</sub>	A	11	11	11	11	11	11	11
DC-3 operation			DILM185A	DILM225A	DILM250	DILM300A	DILM400	DILM500	DILM570
60 V	I <sub>e</sub>	A	300	300	300	400	400	400	400
110 V	I <sub>e</sub>	A	300	300	300	400	400	400	400
220 V	I <sub>e</sub>	A	300	300	300	400	400	400	400
DC-5 operation			DILM185A	DILM225A	DILM250	DILM300A	DILM400	DILM500	DILM570
60 V	I <sub>e</sub>	A	300	300	300	400	400	400	400
110 V	I <sub>e</sub>	A	300	300	300	400	400	400	400
220 V	I <sub>e</sub>	A	300	300	300	400	400	400	400

#### Current heat loss (3 pole)

Current heat loss at I <sub>th</sub>	W	34	45	55	37	58	113	130
Current heat loss at I <sub>e</sub> to AC-3/400 V	W	16	23	28	21	37	58	78

DILM580	DILM650	DILM750	DILM820	DILM1000	DILM1600	DILH1400	DILH2000	DILH2200	DILH2600
456	512	576	656	800	1280	-	-	-	-
456	512	576	656	800	1280	-	-	-	-
456	512	576	656	800	1280	-	-	-	-
456	512	576	656	800	1280	-	-	-	-
456	512	576	656	800	1280	-	-	-	-
456	512	576	656	800	1280	-	-	-	-
456	512	576	656	800	1280	-	-	-	-
348	348	464	464	700	1120	-	-	-	-
143	161	181	209	260	430	-	-	-	-
156	176	200	228	280	450	-	-	-	-
250	280	315	355	450	750	-	-	-	-
274	307	346	394	490	770	-	-	-	-
290	326	367	418	520	830	-	-	-	-
330	370	417	474	590	940	-	-	-	-
440	494	556	633	780	1300	-	-	-	-
509	509	678	678	1000	1650	-	-	-	-
463	463	463	463	463	-	-	-	-	-
265	265	265	265	265	-	-	-	-	-
30	30	30	30	30	-	-	-	-	-
0.1	0.1	0.1	0.1	0.1	-	-	-	-	-
200	200	200	200	200	-	-	-	-	-
-	-	-	-	-	-	-	-	-	-
-	-	-	-	-	-	-	-	-	-
-	-	-	-	-	-	-	-	-	-
-	-	-	-	-	-	-	-	-	-
-	-	-	-	-	-	-	-	-	-
-	-	-	-	-	-	-	-	-	-
-	-	-	-	-	-	-	-	-	-
-	-	-	-	-	-	-	-	-	-
-	-	-	-	-	-	-	-	-	-
-	-	-	-	-	-	-	-	-	-
-	-	-	-	-	-	-	-	-	-
-	-	-	-	-	-	-	-	-	-
61	69	78	96	96	155	188	192	232	250
32	41	54	65	96	123	-	-	-	-

### DILM185...DILM1600, DILH

				Contactors						
				DILM185A	DILM225A	DILM250	DILM300A	DILM400	DILM500	DILM570
<b>Magnet systems</b>										
Voltage tolerance <sup>1)</sup>	AC operated	Pick-up	$x U_c$	0.8 - 1.15	0.8 - 1.15					
	AC operated	Drop-out	$x U_c$	0.25 - 0.6	0.25 - 0.6					
	DC operated	Pick-up	$x U_c$	0.7 - 1.2	0.7 - 1.2					
	DC operated	Drop-out	$x U_c$	0.15 - 0.6	0.15 - 0.6					
Power consumption of the coil in a cold state and $1.0 x U_c$	50/60 Hz	Pick-up	VA	210	210	–	–	–	–	–
	50/60 Hz	Sealing	VA	2.6	2.6	–	–	–	–	–
	50/60 Hz	Sealing	W	2.6	2.6	–	–	–	–	–
	DC operated	Pick-up	W	180	180	–	–	–	–	–
	DC operated	Sealing	W	2.1	2.1	–	–	–	–	–
Voltage tolerance	Comfort series DILM...	Pick-up	$x U_c$	–	–	$0.7 x U_{c\ min} - 1.15 x U_{c\ max}$				
	Standard range DILM...-S	Pick-up	$x U_c$	–	–	$0.85 x U_{c\ min} - 1.1 x U_{c\ max}$				
	Comfort series DILM...	Drop-out	$x U_c$	–	–	$0.2 x U_{c\ min} - 0.6 x U_{c\ min}$				
	Standard range DILM...-S	Drop-out	$x U_c$	–	–	$0.2 x U_{c\ min} - 0.4 x U_{c\ min}$				
Power consumption of the coil in a cold state and $1.0 x U_c$	Comfort series DILM...	Pick-up	VA	–	–	380 <sup>2)</sup>	380 <sup>2)</sup>	450 <sup>2)</sup>	450 <sup>2)</sup>	450 <sup>2)</sup>
	Comfort series DILM...	Pick-up	W	–	–	250	250	350	350	350
	Comfort series DILM...	Sealing	VA	–	–	4.3	4.3	4.3	4.3	4.3
	Comfort series DILM...	Sealing	W	–	–	3.3	3.3	3.3	3.3	3.3
	Standard range DILM...-S	Pick-up	VA	–	–	360 <sup>4)</sup>	360 <sup>4)</sup>	715 <sup>4)</sup>	715 <sup>4)</sup>	715 <sup>4)</sup>
	Standard range DILM...-S	Pick-up	W	–	–	325	625	645	645	645
	Standard range DILM...-S	Sealing	VA	–	–	4.3	4.3	4.3	4.3	4.3
	Standard range DILM...-S	Sealing	W	–	–	3.3	3.3	3.3	3.3	3.3
Duty factor			% DF	–	–	100	100	100	100	100
Changeover time at 100 % $U_c$ (recommended values), main circuit										
Comfort series DILM...	Closing delay	ms		–	–	< 100	< 80	< 80	< 80	< 80
	Opening delay	ms		–	–	< 110	< 110	< 110	< 110	< 110
Standard range DILM...-S	Closing delay	ms		< 60	< 60	< 55	< 55	< 55	< 55	< 55
	Opening delay	ms		< 40	< 40	< 40	< 40	< 50	< 50	< 50
Behavior in limit range and transition area, hold state										
Voltage interruption	$(0 - 0.2 x U_{c\ min}) \leq 10\ ms$			–	–	Targeted bridging during this time				
	$(0 - 0.2 x U_{c\ min}) > 10\ ms$			Drop-out of the contactor						
Voltage drops	$(0 - 0.2 x U_{c\ min}) \leq 12\ ms$			Targeted bridging during this time						
	$(0.2 - 0.6 x U_{c\ min}) > 12\ ms$			Drop-out of the contactor						
	$(0.6 - 0.7 x U_{c\ min})$			Contactor remains switched on						
Excess voltage	$(1.15 - 1.3 x U_{c\ max})$			Contactor remains switched on						
	$(> 1.3 x U_{c\ max}) \leq 3\ s$			Contactor remains switched on						
	$(> 1.3 x U_{c\ max}) > 3\ s$			Drop-out of the contactor						
Pick-up phase	$(0.7 x U_{c\ min})$			Contactor does not switch on						
	$(0.7 x U_{c\ min} - 1.15 x U_{c\ max})$			Contactor switches on safely						
	$(> 1.15 x U_{c\ max})$			Contactor switches on safely						
Permissible transitional contact resistance (of external control unit when A11 is actuated)			m $\Omega$	–	–	$\leq 500$	$\leq 500$	$\leq 500$	$\leq 500$	–
Permissible residual current (when A11 is actuated from the electronic system in the event of a 0 signal)			mA	–	–	$\leq 1$	$\leq 1$	$\leq 1$	$\leq 1$	–
PLC signal level (A3 - A4) to IEC/EN 61131-2 (part no. 2)										
High			V	15	15	15	15	15	15	–
Low			V	5	5	5	5	5	5	–

### Electromagnetic compatibility (EMC)

Electromagnetic compatibility

This product is designed for operation in industrial environments (environment 2). The use in residential environments (environment 1) could cause electrical interference so that addition suppression must be planned.

### Notes

- <sup>1)</sup>  $U_{c\ min}$ ,  $U_{c\ max}$ ,
- <sup>2)</sup> Control transformer with  $u_k \leq 0.6$
- <sup>3)</sup> Control transformer with  $u_k \leq 0.7$
- <sup>4)</sup>  $u_k \leq 10\ %$



# 1.1

## Contactors

Basic devices up to 200 A, 4 pole

### DILMP20 ... DILMP200

1

DILMP20      DILMP32      DILMP63      DILMP125  
 DILMP45      DILMP80      DILMP160      DILMP200

General					
Standards	IEC/EN 60947, VDE 0660, UL, CSA				
Lifespan, mechanical					
AC operated	c (contacts)	x 10 <sup>6</sup>	10		
DC operated	c (contacts)	x 10 <sup>6</sup>	10		
Operating frequency, mechanical					
Mechanical, AC operated	Operations/h		5000		3600
DC operated	Operations/h		5000		3600
Maximum operating frequency					
Electrical (Contactor without overload relay)	600				
Climatic proofing					
			Damp heat, constant, to IEC 60068-2-3 Damp heat, cyclic, to IEC 60068-2-30		
Ambient temperature					
Open	°C	-25...60			
Enclosed	°C	-25...40			
Storage	°C	-40 - 80			
Mounting position AC- and DC operated					
Mechanical shock resistance (IEC/EN 60068-2-27)					
Half-sinusoidal shock 10 ms					
Main contacts					
N/O	g	10			
Auxiliary contacts					
N/O	g	7			
NC	g	5			
Protection type					
		IP20	IP00		
With accessories					
		–	IP20		
Protection against direct contact when actuated from front (EN 50274)					
Finger- and back-of-hand proof					
<b>Terminal type, screw connection</b>					
Terminal capacity of main cable					
Solid	mm <sup>2</sup>	1 x (0.75 - 4) 2 x (0.75 - 2.5)	1 x (0.75 - 16) 2 x (0.75 - 10)	1 x (2.5 - 16) 2 x (2.5 - 16)	–
Flexible with ferrule	mm <sup>2</sup>	1 x (0.75 - 2.5) 2 x (0.75 - 2.5)	1 x (0.75 - 16) 2 x (0.75 - 10)	1 x (2.5 - 35) 2 x (2.5 - 25)	1 x (10 - 95) 2 x (10 - 70)
Stranded	mm <sup>2</sup>	–	1 x 16	1 x (16 - 50) 2 x (16 - 35)	1 x (16 - 120) 2 x (16 - 95)
Solid or stranded	AWG	18 - 14	18 - 6	12 - 2	8 - 250MCM
Flat conductor	Number of layers x width x thickness	mm	–	2 x (6 x 9 x 0.8)	2 x (6 x 16 x 0.8)
Terminal capacity of control circuit cable					
Solid	mm <sup>2</sup>	1 x (0.75 - 4) 2 x (0.75 - 2.5)	1 x (0.75 - 4) 2 x (0.75 - 2.5)	1 x (0.75 - 4) 2 x (0.75 - 4)	1 x (0.75 - 4) 2 x (0.75 - 4)
Flexible with ferrule	mm <sup>2</sup>	1 x (0.75 - 2.5) 2 x (0.75 - 2.5)	1 x (0.75 - 2.5) 2 x (0.75 - 2.5)	1 x (0.75 - 2.5) 2 x (0.75 - 2.5)	1 x (0.75 - 2.5) 2 x (0.75 - 2.5)
Solid or stranded	AWG	18 - 14	18 - 14	18 - 14	18 - 14
Main cable connection screw/bolt					
		M3.5	M5	M6	M10
Tightening torque					
	Nm	1.2	3	3.3	14
Control circuit cable connection screw/bolt					
		M3.5	M3.5	M3.5	M3.5
Tightening torque					
	Nm	1.2	1.2	1.2	1.2
Tools					
Main conductors					
Pozidriv screwdriver	Size	2	2	2	–
Internal hexagon	SW	mm	–	–	5
Flat-blade screwdriver	mm	0.8 x 5.5 1 x 6	0.8 x 5.5 1 x 6	0.8 x 5.5 1 x 6	–
Auxiliary conductors					
Pozidriv screwdriver	Size	2	2	2	2
Flat-blade screwdriver	mm	0.8 x 5.5 1 x 6	0.8 x 5.5 1 x 6	0.8 x 5.5 1 x 6	0.8 x 5.5 1 x 6

## DILMP20 ... DILMP200

				DILMP20	DILMP32 DILMP45	DILMP63 DILMP80	DILMP125 DILMP160	DILMP200				
<b>Main contacts</b>												
Rated impulse withstand voltage	$U_{imp}$	V AC		8000								
Overvoltage category/pollution degree				III/3								
Rated insulation voltage	$U_i$	V AC		690								
Rated operating voltage	$U_e$	V AC		690								
Safe isolation according to EN 61140												
	Between coil and contacts		V AC	400	440							
	Between the contacts		V AC	400	440							
Making capacity (cos $\varphi$ to IEC/EN 60947)	To 690 V	A		144	238	350	560	700	1120	1330	1800	
Breaking capacity												
	220/230 V	A		120	180	250	400	500	800	950	1150	
	380/400 V	A		120	180	250	400	500	800	950	1150	
	500 V	A		100	180	250	400	500	800	950	1150	
	660/690 V	A		70	120	144	250	296	650	750	800	
Short-circuit rating												
Short-circuit protection rating maximum fuse												
Type "2" coordination												
	400 V	gG/gL 500 V	A	20	35	35	63	80	160	160	250	
	690 V	gG/gL 690 V	A	20	35	35	50	63	160	160	200	
Type "1" coordination												
	400 V	gG/gL 500 V	A	35	63	100	125	160	250	250	250	
	690 V	gG/gL 690 V	A	25	50	50	80	80	200	200	200	
<b>AC voltage</b>												
AC-1 operation												
Conventional thermal current 3 pole 50 - 60 Hz												
	Open	at 40 °C	$I_{th}$	A	22	32	45	63	80	125	160	200
		at 50 °C	$I_{th}$	A	21	30	41	60	76	116	150	188
		at 60 °C	$I_{th}$	A	20	28	39	54	69	108	138	172
	Enclosed		$I_{th}$	A	18	27	36	50	64	100	128	160
Conventional thermal current, 1 pole												
	Open		$I_{th}$	A	60	84	117	162	207	325	415	516
	Enclosed		$I_{th}$	A	54	76	105	146	186	292	373	464
Rated operational power												
	220/230 V	P	kW	8	12	16	23	29	45	58	72	
	240 V	P	kW	9	13	18	25	32	49	63	79	
	380 V	P	kW	14	20	28	39	50	78	100	125	
	415 V	P	kW	15	22	31	43	55	85	109	137	
	440 V	P	kW	16	23	33	46	58	90	116	145	
	500 V	P	kW	18	26	37	52	66	103	132	165	
	690 V	P	kW	24	35	49	68	87	136	174	217	
AC-3 operation												
Rated operational current AC -3 open, 50 – 60 Hz, 3 pole												
	220/230 V	$I_e$	A	12	18	25	40	50	80	95	115	
	240 V	$I_e$	A	12	18	25	40	50	80	95	115	
	380/400 V	$I_e$	A	12	18	25	40	50	80	95	115	
	415 V	$I_e$	A	12	18	25	40	50	80	95	115	
	440 V	$I_e$	A	12	18	25	40	50	80	95	115	
	500 V	$I_e$	A	10	18	25	40	50	80	95	115	
	660/690 V	$I_e$	A	7	12	15	25	32	65	80	93	
Rated operational power												
	220/230 V	P	kW	3.5	5	7.5	12.5	15.5	25	30	37	
	240 V	P	kW	4	5.5	8.5	13.5	17	27.5	33	40	
	380/400 V	P	kW	5.5	7.5	11	18.5	22	37	45	55	
	415 V	P	kW	7	10	14.5	24	30	48	57	70	
	440 V	P	kW	7.5	10.5	15.5	25	32	51	60	75	
	500 V	P	kW	7	12	17.5	28	36	58	70	85	
	660/690 V	P	kW	6.5	11	14	23	30	63	75	90	



# 1.1

## Contactors

Basic devices up to 200 A, 4 pole

### 1 DILMP20 ... DILMP200

				DILMP20	DILMP32	DILMP63	DILMP125				
					DILMP45	DILMP80	DILMP160				DILMP200
<b>DC voltage</b>											
Rated operational current $I_e$ open											
DC-1 operation											
	60 V	$I_e$	A	22	32	45	63	80	125	160	200
	110 V	$I_e$	A	22	32	45	63	80	125	160	200
	220 V	$I_e$	A	6	32	45	63	80	125	160	200
	440 V	$I_e$	A	1.3	3	3	5	5	10	10	10
DC-3 operation											
	60 V	$I_e$	A	20	32	45	63	80	125	160	200
	110 V	$I_e$	A	20	32	45	63	80	125	160	200
	220 V	$I_e$	A	1.5	32	45	63	80	125	160	200
	440 V	$I_e$	A	0.2	6	6	8	8	9	9	9
DC-5 operation											
	60 V	$I_e$	A	20	32	45	63	80	125	160	200
	110 V	$I_e$	A	20	25	32	50	80	125	160	200
	220 V	$I_e$	A	1.5	15	22	38	70	100	125	150
	440 V	$I_e$	A	0.2	4	4	8	8	8	8	8
<b>Current heat loss (3 pole)</b>											
	Current heat loss at $I_{th}$		W	4.7	8.2	12	16	23	29	46	60
	Impedance per pole		m $\Omega$	2.5	2	1.5	1	0.7	0.6	0.6	0.5
<b>Magnet systems</b>											
Voltage tolerance											
	AC operated 50 Hz	Pick-up	$x U_c$	0.8 - 1.1	0.8 - 1.1	0.8 - 1.1	0.8 - 1.1	0.8 - 1.1	0.8 - 1.1	0.8 - 1.1	0.8 - 1.1
	AC operated 50/60 Hz		$x U_c$	0.8 - 1.1	0.85 - 1.1	0.85 - 1.1	0.85 - 1.1	0.85 - 1.1	0.85 - 1.1	0.85 - 1.1	0.85 - 1.1
	AC operated	Drop-out	$x U_c$	0.4 - 0.6	0.4 - 0.6	0.4 - 0.6	0.4 - 0.6	0.4 - 0.6	0.4 - 0.6	0.4 - 0.6	0.4 - 0.6
	DC operated <sup>1)</sup>	Pick-up	$x U_c$	0.8 - 1.1	0.7 - 1.2	0.7 - 1.2	0.7 - 1.2	0.7 - 1.2	0.7 - 1.2	0.7 - 1.2	0.7 - 1.2
	DC operated <sup>1)</sup>	Drop-out	$x U_c$	0.2 - 0.6	0.2 - 0.6	0.2 - 0.6	0.2 - 0.6	0.2 - 0.6	0.2 - 0.6	0.2 - 0.6	0.2 - 0.6
Power consumption of the coil in a cold state and $1.0 \times U_c$											
	AC operated 50/60 Hz	Pick-up	VA	24	50	150	180	180	180	180	180
	AC operated 50/60 Hz	Pick-up	W	19	40	95	150	150	150	150	150
	AC operated 50/60 Hz	Sealing	VA	4	8	16	3.1	3.1	3.1	3.1	3.1
	AC operated 50/60 Hz	Sealing	W	1.2	2.4	4	2.1	2.1	2.1	2.1	2.1
	DC operated <sup>1)</sup>	Pick-up	W	4.5	12	24	149	149	149	149	149
	DC operated <sup>1)</sup>	Sealing	W	4.5	0.5	0.5	2.1	2.1	2.1	2.1	2.1
	Duty factor		% DF	100	100	100	100	100	100	100	100
Changeover times at 100 % $U_c$ (recommended values)											
Main contacts											
AC operated											
	Closing delay		ms	15...21	16...22	12...18	28...33	28...33	28...33	28...33	28...33
	Opening delay		ms	9...18	8...14	8...13	35...41	35...41	35...41	35...41	35...41
DC operated <sup>1)</sup>											
	Closing delay		ms	31	47	54	35	35	35	35	35
	Opening delay		ms	12	30	24	30	30	30	30	30
	Arcing time		ms	10	10	10	15	15	15	15	15
	Permissible residual current when A1 - A2 are actuated from the electronic system (with 0 signal)		mA	$\leq 1$	$\leq 1$	$\leq 1$	$\leq 1$	$\leq 1$	$\leq 1$	$\leq 1$	$\leq 1$

#### Notes

<sup>1)</sup> At least double-pulse bridge rectifier

### DILK

1

			DILK12	DILK20	DILK25	DILK33	DILK50	
<b>General</b>								
Standards			IEC/EN 60947, VDE 0660					
Ambient temperature								
Open	°C		-25...60	-25...60	-25...60	-25...60	-25...60	
Enclosed	°C		-25...40	-25...40	-25...40	-25...40	-25...40	
Mounting position								
Protection type			IP00	IP00	IP00	IP00	IP00	
Protection against direct contact when actuated from front (EN 50274)			Finger- and back-of-hand proof					
Weight basic device								
AC operated	kg		0.55	0.55	0.55	1	1	
Terminal capacity of main cable								
Solid	mm <sup>2</sup>		1 x (0.75 - 16)	1 x (0.75 - 16)	1 x (0.75 - 16)	1 x (2.5 - 16)	1 x (2.5 - 16)	
Flexible with ferrule	mm <sup>2</sup>		1 x (0.75 - 16)	1 x (0.75 - 16)	1 x (0.75 - 16)	1 x (2.5 - 35)	1 x (2.5 - 35)	
Stranded	mm <sup>2</sup>		1 x 16	1 x 16	1 x 16	1 x (16 - 50)	1 x (16 - 50)	
Solid or stranded	AWG		18 - 16	18 - 6	18 - 6	12 - 2	12 - 2	
Flat conductor	Number of layers x width x thickness	mm	-	-	-	1 x (6 x 9 x 0.8)	1 x (6 x 9 x 0.8)	
<b>Group compensation</b>								
60 Hz								
230 V	kvar		7.5	11	15	20	25	
400 V	kvar		12.5	20	25	33.3	50	
525 V	kvar		16.7	25	33.3	40	65	
690 V	kvar		20	33.3	40	55	85	
50/60 Hz								
Open								
230 V	$I_e$	A	18	29	38	50	72	
400 V	$I_e$	A	18	29	38	50	72	
525 V	$I_e$	A	18	29	38	50	72	
690 V	$I_e$	A	18	29	38	50	72	
Enclosed								
230 V	$I_e$	A	16	26	34	45	65	
400 V	$I_e$	A	16	26	34	45	65	
525 V	$I_e$	A	16	26	34	45	65	
690 V	$I_e$	A	16	26	34	45	65	
Making capacity (i-peak value) without damping			x $I_e$	180	180	180	180	180
Component lifespan			c (contacts) x 10 <sup>6</sup>	0.15	0.15	0.15	0.15	0.15
Maximum operating frequency			Ops/h	120	120	120	120	120

# 1.1

## Contactors

Contactor for capacitors

### 1 DILK

			DILK12	DILK20	DILK25	DILK33	DILK50
<b>Magnet systems</b>							
Voltage tolerance							
AC operated	Pick-up	x U <sub>c</sub>	0.8 - 1.1	0.8 - 1.1	0.8 - 1.1	0.8 - 1.15	0.8 - 1.15
AC operated	Drop-out	x U <sub>c</sub>	0.3 - 0.6	0.3 - 0.6	0.3 - 0.6	0.3 - 0.6	0.3 - 0.6
Power consumption of the coil in a cold state and 1.0 x U <sub>c</sub>							
50 Hz	Pick-up	VA	58	58	58	45	45
50 Hz	Sealing	VA	7.6	7.6	7.6	1.5	1.5
50 Hz	Sealing	W	2.3	2.3	2.3	1.5	1.5
60 Hz	Pick-up	VA	71	71	71	45	45
60 Hz	Sealing	VA	9.3	9.3	9.3	1.5	1.5
60 Hz	Sealing	W	2.8	2.8	2.8	1.5	1.5
50/60 Hz	Pick-up	VA	65	65	65	45	45
			59	59	59	45	45
50/60 Hz	Sealing	VA	9.6	9.6	9.6	1.5	1.5
			7	7	7	1.5	1.5
50/60 Hz	Sealing	W	2.7	2.7	2.7	1.5	1.5
			2.2	2.2	2.2	1.5	1.5
Duty factor		% DF	100	100	100	100	100
Changeover times at 100 % U <sub>c</sub> (recommended values)							
Main contacts							
AC operated							
	Closing delay	ms	16...22	16...22	16...22	50	50
	Opening delay	ms	8...14	8...14	8...14	40	40
Arcing time		ms	10	10	10	10	10
<b>Electromagnetic compatibility (EMC)</b>							
Emitted interference			To EN 60947-1	To EN 60947-1	To EN 60947-1	To EN 60947-1	To EN 60947-1
Interference immunity			To EN 60947-1	To EN 60947-1	To EN 60947-1	To EN 60947-1	To EN 60947-1
<b>Further technical data</b>							
As per contactor	DIL		M17	M25	M32	M50	M65

DILL

1

				DILL12	DILL18	DILL20
<b>General</b>						
Standards				IEC/EN 60947, VDE 0660, UL, CSA		
Lifespan, mechanical						
AC operated		c (contacts)	x 10 <sup>6</sup>	1	1	1
Operating frequency, mechanical						
Mechanical, AC operated		Operations/h		60	60	60
Maximum operating frequency						
Electrical		Operations/h		60	60	60
Climatic proofing				Damp heat, constant, to IEC 60068-2-78; Damp heat, cyclic, to IEC 60068-2-30		
Ambient temperature	Open	°C		-25...60	-25...60	-25...60
	Enclosed	°C		-25...40	-25...40	-25...40
	Storage	°C		-40 - 80	-40 - 80	-40 - 80
Mounting position						
Mechanical shock resistance (IEC/EN 60068-2-27)						
Half-sinusoidal shock 10 ms				6.9	6.9	6.9
Protection type				IP00	IP00	IP00
Weight						
AC operated		kg		0.42	0.42	0.42
<b>Main contacts</b>						
Rated impulse withstand voltage		U <sub>imp</sub>	V AC	8000	8000	8000
Overvoltage category/pollution degree				III/3	III/3	III/3
Rated insulation voltage		U <sub>i</sub>	V AC	690	690	690
Rated operating voltage		U <sub>e</sub>	V AC	690	690	690
Making capacity		A		238	350	550
Breaking capacity		380/400 V	A	170	250	320
Lifespan, electrical		c (contacts)		10000	10000	10000
Short-circuit protection rating maximum fuse						
400 V		gG/gL 500 V	A	63	100	125
<b>AC voltage</b>						
AC-1 operation						
Conventional thermal current						
at 40 °C		I <sub>th</sub>	A	27	40	45
at 60 °C		I <sub>th</sub>	A	24	35	40
230 V		I <sub>e</sub>	A	12	18	20
400 V		I <sub>e</sub>	A	12	18	20
AC-1 operation						
220/230 V		I <sub>e</sub>	A	14	21	27
400 V		I <sub>e</sub>	A	14	21	27
Electric lamps						
Filament bulbs		A		14	21	27
Mercury blended lamps		A		12	16	23
Fluorescent lamp load						
Conventional reactor starter connection		A		20	26	35
Duo circuit		A		20	26	35
Electronic upstream devices		A		12	18	20
High-pressure mercury vapour lamps		A		12	18	20
Metal-halide lamps		A		12	18	20
High-pressure sodium lamps		A		12	18	20
Low-pressure sodium lamps		A		7.5	10	12
Maximum permissible compensation capacitance		µF		470	470	470
<b>Further technical data</b>						
As per contactor		DIL		M17	M25	M32

# 1.1

## Contactors

Contactors up to 150 A with electronic actuation

### 1 DILMF

DILMF8      DILMF11      DILMF14      DILMF17

#### General

Mounting position

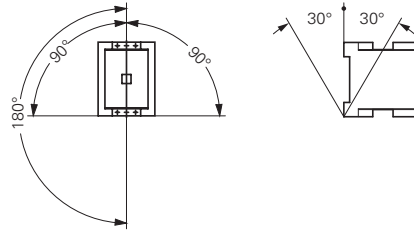

#### AC voltage

AC-3 operation

Rated operational current AC-3 open, 50 – 60 Hz, 3 pole	220/230 V	$I_e$	A	7	9	12	18
	240 V I	$I_e$	A	7	9	12	18
	380/400 V	$I_e$	A	7	9	12	18
	415 V	$I_e$	A	7	9	12	18
	440 V	$I_e$	A	7	9	12	18
	500 V	$I_e$	A	5	7	10	18
	660/690 V	$I_e$	A	4	5	7	12
Rated operational power	220/230 V	P	kW	2.2	2.5	3.5	5
	240 V	P	kW	2.2	3	4	5.5
	380/400 V	P	kW	3	4	5.5	7.5
	415 V	P	kW	4	5.5	7	10
	440 V	P	kW	4.5	5.5	7.5	10.5
	500 V	P	kW	3.5	4.5	7	12
	660/690 V	P	kW	3.5	4.5	6.5	11

AC-4 operation

Rated operational current AC-4 open, 50 - 60 Hz, 3 pole	220/230 V I	$I_e$	A	5	6	7	10
	240 V	$I_e$	A	5	6	7	10
	380/400 V	$I_e$	A	5	6	7	10
	415 V	$I_e$	A	5	6	7	10
	440 V	$I_e$	A	5	6	7	10
	500 V	$I_e$	A	4.5	5	6	10
	660/690 V	$I_e$	A	4	4.5	5	8
Rated operational power	220/230 V	P	kW	1	1.5	2	2.5
	240 V	P	kW	1.5	1.6	2.2	3
	380/400 V	P	kW	2.2	2.5	3	4.5
	415 V	P	kW	2.3	2.8	3.4	5
	440 V	P	kW	2.4	3	3.6	5.5
	500 V	P	kW	2.5	2.8	3.5	6
	660/690 V	P	kW	2.9	3.6	4.4	6.5

#### Current heat loss (3 pole)

Current heat loss at $I_{th}$		W	2.4	2.4	2.4	7.3
Current heat loss at $I_e$ to AC-3/400 V		W	0.3	0.6	1	1.9

#### Magnet systems

Voltage tolerance	AC operated	Pick-up	$x U_c$	0.8 - 1.15	0.8 - 1.15	0.8 - 1.15	0.8 - 1.15
	AC operated	Drop-out	$x U_c$	0.2 - 0.5	0.2 - 0.5	0.2 - 0.5	0.2 - 0.5
Power consumption of the coil in a cold state and $1.0 \times U_c$	Electronic actuation	Pick-up	VA	14	14	14	14
	Electronic actuation	Sealing	VA	0.7	0.7	0.7	0.7
	Electronic actuation	Sealing	W	0.7	0.7	0.7	0.7
Duty factor		% DF	100	100	100	100	
Switching times	Closing delay	ms	40	40	40	40	
	Opening delay	ms	45	45	45	45	

suitable according to

SEMI F47      SEMI F47      SEMI F47      SEMI F47

#### Electromagnetic compatibility (EMC)

Emitted interference	To EN 60947-1
Interference immunity	To EN 60947-1

#### Further technical data

As per contactor	DIL	M7	M9	M12	M17
------------------	-----	----	----	-----	-----

#### Terminal type

As per contactor	DIL	M17	M17	M17	M17
------------------	-----	-----	-----	-----	-----

DILMF25	DILMF32	DILMF40	DILMF50	DILMF65	DILMF80	DILMF95	DILMF115	DILMF150
---------	---------	---------	---------	---------	---------	---------	----------	----------

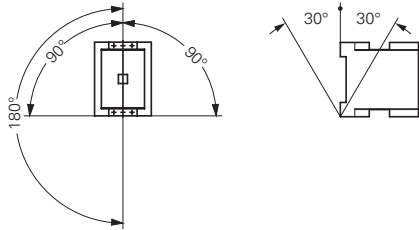

25	32	40	50	65	80	95	115	150
25	32	40	50	65	80	95	115	150
25	32	40	50	65	80	95	115	150
25	32	40	50	65	80	95	115	150
25	32	40	50	65	80	95	115	150
15	18	25	32	37	65	80	93	100
7.5	10	12.5	15.5	20	25	30	37	48
8.5	11	13.5	17	22	27.5	4	40	52
11	15	18.5	22	30	37	45	55	75
14.5	19	24	30	39	48	57	70	91
15.5	20	25	32	41	51	60	75	95
17.5	23	28	36	47	58	70	85	110
14	17	23	30	35	63	75	90	96

13	15	18	21	25	40	50	55	65
13	15	18	21	25	40	50	55	65
13	15	18	21	25	40	50	55	65
13	15	18	21	25	40	50	55	65
13	15	18	21	25	40	50	55	65
13	15	18	21	25	40	50	55	65
10	12	14	17	20	27	37	45	50
3.5	4	5	6	7	12	16	17	20
4	4.5	5.5	6.5	7.5	13	17	19	22
6	7	9	10	12	20	26	28	33
6.5	7.5	9.5	11	13	24	30	33	39
7	8	10	12	14	25	32	35	41
8	9	11	13	16	29	36	40	47
8.5	10	12	14	17	26	35	43	48

9.6	12.1	11.3	19	28.8	14.6	21.8	30.4	46.1
3.8	6.1	7.2	11.3	19	11.5	16.2	23.8	40.5

0.8 - 1.15	0.8 - 1.15	0.8 - 1.15	0.8 - 1.15	0.8 - 1.15	0.8 - 1.15	0.8 - 1.15	0.8 - 1.15	0.8 - 1.15
0.2 - 0.5	0.2 - 0.5	0.2 - 0.5	0.2 - 0.5	0.2 - 0.5	0.2 - 0.5	0.2 - 0.5	0.2 - 0.5	0.2 - 0.5
14	14	45	45	45	75	75	180	180
0.7	0.7	1.5	1.5	1.5	2	2	3.1	3.1
0.7	0.7	1.5	1.5	1.5	2	2	2.1	2.1
100	100	100	100	100	100	100	100	100
40	40	50	50	50	55	55	40	40
45	45	45	45	45	40	40	40	40
SEMI F47	SEMI F47	SEMI F47	SEMI F47	SEMI F47	SEMI F47	SEMI F47	SEMI F47	SEMI F47

To EN 60947-1

To EN 60947-1

M25	M32	M40	M50	M65	M80	M95	M115	M150
-----	-----	-----	-----	-----	-----	-----	------	------

M25	M32	M40	M50	M65	M80	M95	M115	M150
-----	-----	-----	-----	-----	-----	-----	------	------

# 1.1

## Contactors

### Auxiliary contact modules

#### 1 DILM..., DILA...

			DILM7-... - DILM38-...	DILA- XHI(C)...(-S)	DILM32- XHI(C)...(-S)	DILM150- XHI...	DILM1000-XHI... DILM820-XHI...
<b>Auxiliary contact</b>							
Interlocked opposing contacts within an auxiliary contact module (to IEC 60947-5-1 Annex L) <sup>1)</sup>			-	Yes	Yes	Yes	Yes
Normally closed (not late-normally closed) suitable as a mirror contact (to IEC/EN 60947-4-1, Annex F)			DILM7 - DILM38	DILM7 - DILM38	DILM7 - DILM38	DILM40 - DILM170	DILM40 - DILM225A DILM250 - DILM1000
Rated impulse withstand voltage	U <sub>imp</sub>	V AC	6000	6000	6000	6000	6000
Overvoltage category/pollution degree			III/3	III/3	III/3	III/3	III/3
Rated insulation voltage	U <sub>i</sub>	V AC	690	690	690	690	690
Rated operating voltage	U <sub>e</sub>	V AC	500	500	500	500	500
Safe isolation according to EN 61140							
Between coil and auxiliary contacts		V AC	400	400	400	440	440
Between the auxiliary contacts		V AC	400	400	400	440	440
Rated operational current							
AC-15							
	230 V	I <sub>e</sub>	A	4	4	4	4
	380/415 V	I <sub>e</sub>	A	4	4	4	4
	500 V	I <sub>e</sub>	A	1.5	–	1.5	1.5
DC L/R ≅ 15 ms <sup>2)</sup>							
	24 V	I <sub>e</sub>	A	10	10	10	10
	60 V	I <sub>e</sub>	A	6	6	6	6
	110 V	I <sub>e</sub>	A	3	3	3	3
	220 V	I <sub>e</sub>	A	1	1	1	1
DC-13 (6xP)							
Contacts in series:							
	3	24 V	A	2.5	2.5	2.5	–
	3	60 V	A	1	1	1	–
	3	110 V	A	0.5	0.5	0.5	–
	3	220 V	A	0.25	0.25	0.25	–
Conventional thermal current	I <sub>th</sub>	A	10	16	16	16	10
Control circuit reliability (at U <sub>e</sub> = 24 V DC, U <sub>min</sub> = 17 V, I <sub>min</sub> = 5.4 mA)	Fault probability	λ	< 10 <sup>-8</sup> , < 1 one failure in 100 million operations				
Component lifespan							
at U <sub>e</sub> = 230 V, AC-15, 3 A		c (contacts)	x 10 <sup>6</sup>	1.3	1.3	1.3	1.3
Short-circuit rating without welding							
Max. fuse		A gG/gL	10	10	10	16	16

#### Notes

<sup>1)</sup> Not with DIL...-XHIV and DIL...-XHICV.

<sup>2)</sup> Switch-on and switch-off conditions based on DC-13, time constant as specified.

P1SIL...M, DILM...-XP1

1

			P1DILEM DILM12-XP1	DILM32-XP1	DILM65-XP1	DILM150-XP1	DILM185-XP1
<b>Parallel connector</b>							
Terminal capacity							
Solid		mm <sup>2</sup>	1 - 16	16	16	–	–
Flexible with ferrule		mm <sup>2</sup>	1 x (0.5 - 25) 2 x (0.5 - 16)	1 x (16 - 35)	1 x (16 - 120)	–	–
Stranded		mm <sup>2</sup>	1 x (0.5 - 25) 2 x (0.5 - 16)	1 x (16 - 50)	1 x (16 - 120)	1 x (35 - 300) 2 x (35 - 120)	–
Flat conductor	Number of layers x width x thickness	mm	6 x 9 x 0.8	–	–	2 x (11 x 21 x 1)	1 x (6 x 16 x 0.8) 2 x (20 x 32 x 0.5) 2 x (11 x 21 x 1)
Tightening torque		Nm	4	4	14	14	6
Terminal capacity of control circuit cable							
Solid		mm <sup>2</sup>	–	–	–	–	1 x (0.75 - 4) 2 x (0.75 - 4)
Flexible with ferrule		mm <sup>2</sup>	–	–	–	–	1 x (0.75 - 2.5) 2 x (0.75 - 2.5)
Tools							
Pozidriv screwdriver		Size	2	2	–	–	–
Internal hexagon	SW	mm	–	–	5	6	5
Conventional thermal current							
3 pole	I <sub>th</sub>	A	50	100	180	400	700
4 pole	I <sub>th</sub>	A	60	–	–	–	–



# 1.1

## Contactors

Minicontactor relay, contactor combination

### Dimensions

#### 1 Mini contactor relays

DILER-...(-C)  
DILER-...-G(-C)



DILER-...(-C) + ...DILE(-C)  
DILER-...-G(-C) + ...DILE(-C)



DILEEM-..., DILEM-...(-C), DILEM-12-...  
DILEEM-...-G, DILEM-...-G(-C), DILEM-12-...-G



Part no.	c	c1
DILE(E)M-...(-G)	52	83
DILE(E)M-...-G(-C)	54	86

DILER-... + HDILE  
DILER-...-G + HDILE



### Suppressor circuit

RCDILE...  
VGDILE



2DILE-... + MVDILE  
2DILE-...-G + MVDILE

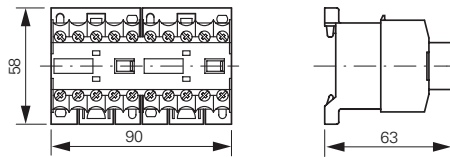

2DILE-... + MVDILE + ...DILE  
2DILE-...-G + MVDILE + ...DILE

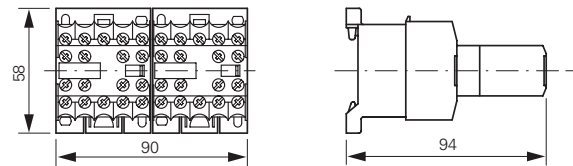

### Star-delta contactors

DIULEM

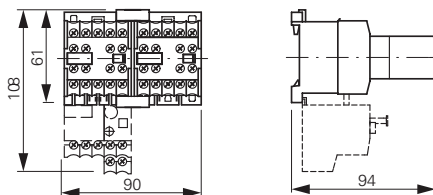

### Star-delta contactors

SDAINLEM

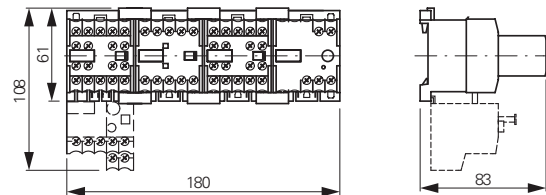

DILER-... + TDDILE24

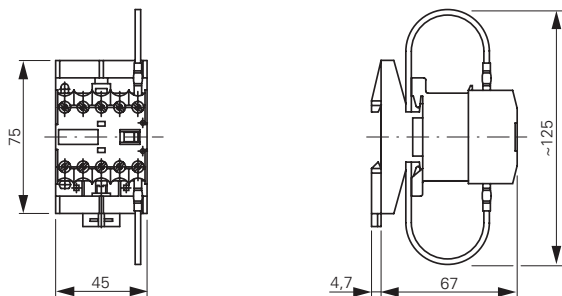

### Parallel connector

P1DILEM

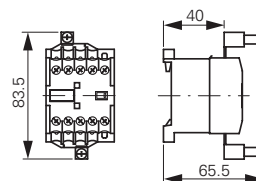

## Contactor with auxiliary contact module

DILM7...DILM15

DILA...

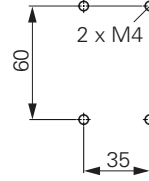
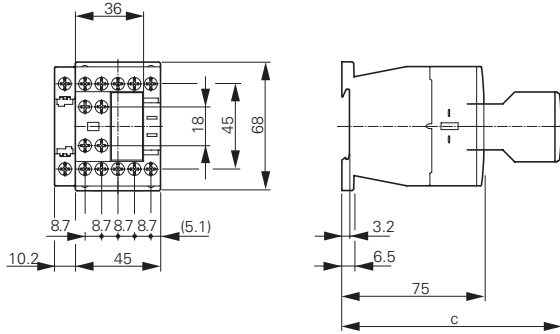

Part no.	c
DILM32-XHI	117
DILA-XHI	117
DILA-XHI...T	125

DILMC7...DILMC15

DILAC...

DILA-XHIC...

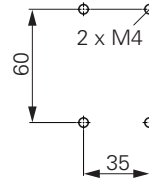
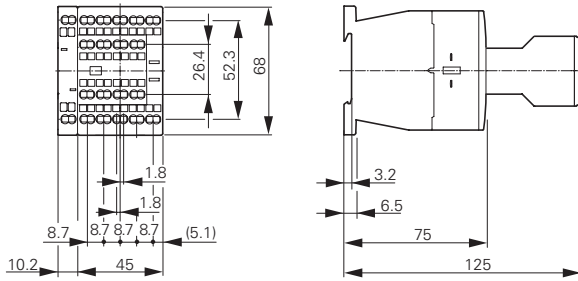

DILM17...DILM38

DILMC17...DILMC32

DILMF8...DILMF32

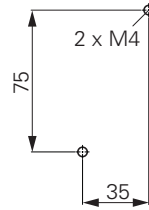
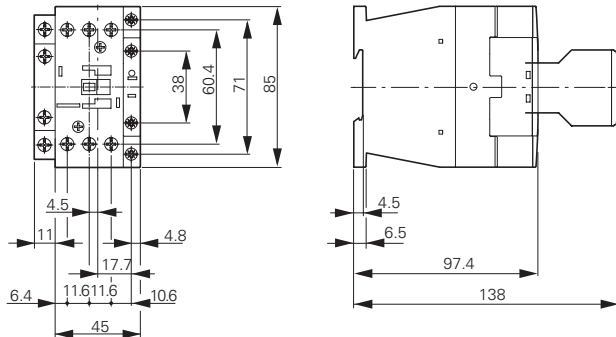

Clearance at side to grounded parts: 6 mm

# 1.1

## Contactors

Basic devices up to 170 A, suppressor circuit

### 1 Contactors

DILM40...DILM72  
DILMC40...DILMC65  
DILMF40...DILMF65

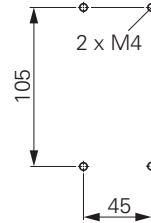
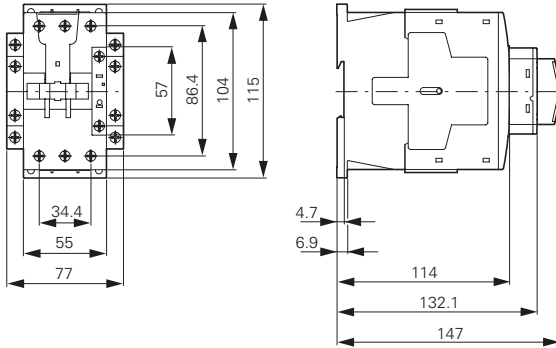

Clearance at side to grounded parts: 6 mm

DILM80...DILM170  
DILMC80...DILMC150  
DILMF80...DILMF150

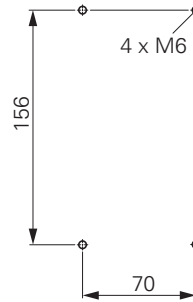
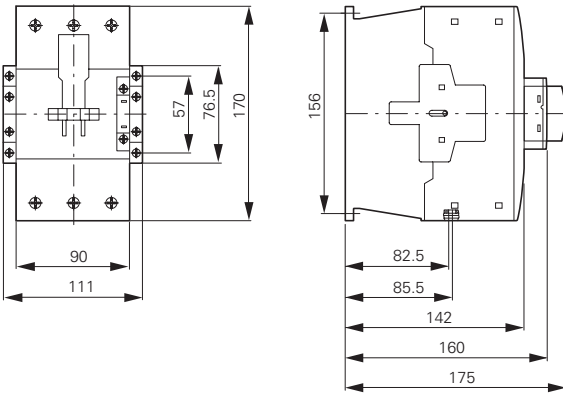

Clearance at side to grounded parts: 10 mm

### Suppressor circuits

DILM...XSP...

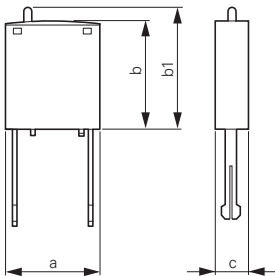

Part no.	a	b	b1	c
DILM12-XSP...	25	28	≈32	9
DILM32-XSP...	25	28	≈32	9
DILM95-XSP...	25	28	≈32	9

**Contactor with auxiliary contact module**

DILMP20

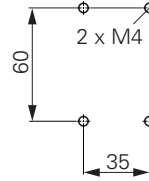
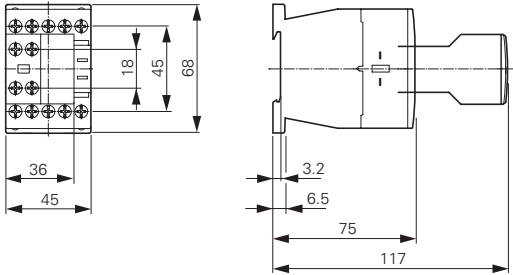

DILMP32 DILMP45

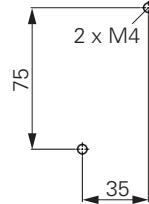
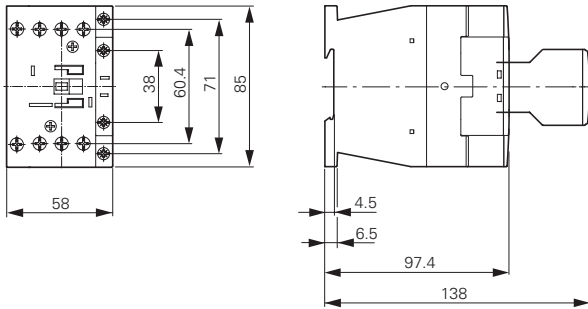

Distance at side to grounded parts: 6 mm

**Contactors**

DILMP63 DILMP80

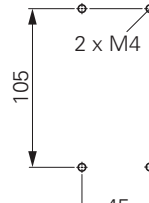
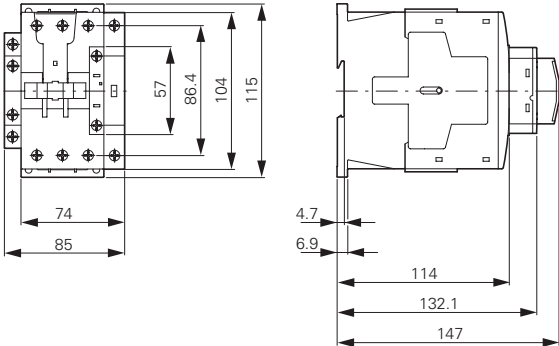

Distance at side to grounded parts: 6 mm

DILMP125 DILMP160 DILMP200

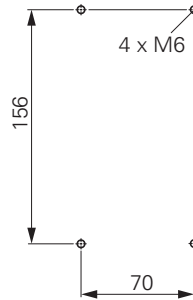
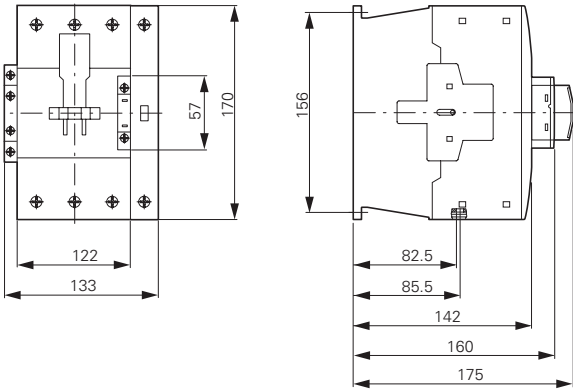

Clearance at side to earthed parts: 10 mm

**Motor suppressor module**

DILM12-XMSM

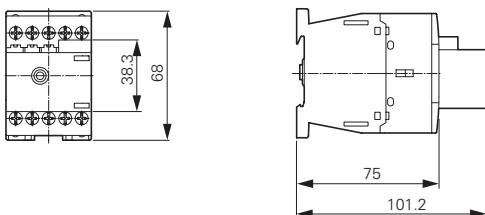

# 1.1

## Contactors

Complete units for currents greater than 170 A

### 1 Complete units

DILM185A...DILM500  
DILM250-S...DILM570-S



- ① DILM1000-XHI...-SI
- ② DILM1000-XHI11-SA

Part no.	a	a1	a2	b	b1	b2	b3	d1	d2	e	c	f
DILM185A	140	120	160	180	160	165	190	20	41	5	158	83
DILM225A	140	120	160	180	160	165	190	20	41	5	158	83
DILM250	140	120	160	180	160	164	189	25	48	5	208	140
DILM300A	140	120	160	180	160	164	189	25	48	5	208	140
DILM400	160	130	180	200	180	184	209	25	48	6	216	140
DILM500	160	130	180	200	180	189	219	38	57	6	216	140
DILM570	160	130	180	200	180	189	219	38	57	6	216	140

DILM580...DILM1000

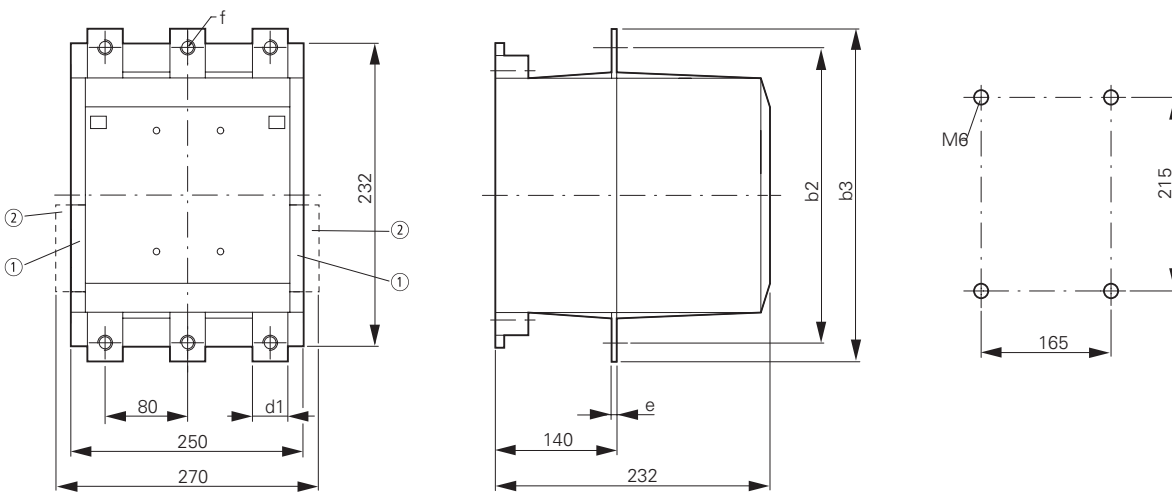

- ① DILM820-XHI...-SI
- ② DILM820-XHI11-SA

Part no.	b2	b3	d1	e	f
DILM580	256	296	45	6	13.5
DILM650	256	296	45	6	13.5
DILM750	256	296	45	6	13.5
DILM820	256	296	45	6	13.5
DILM1000	256	296	45	10	13.5

AC-1 contactors greater than 1000 A

DILH1400

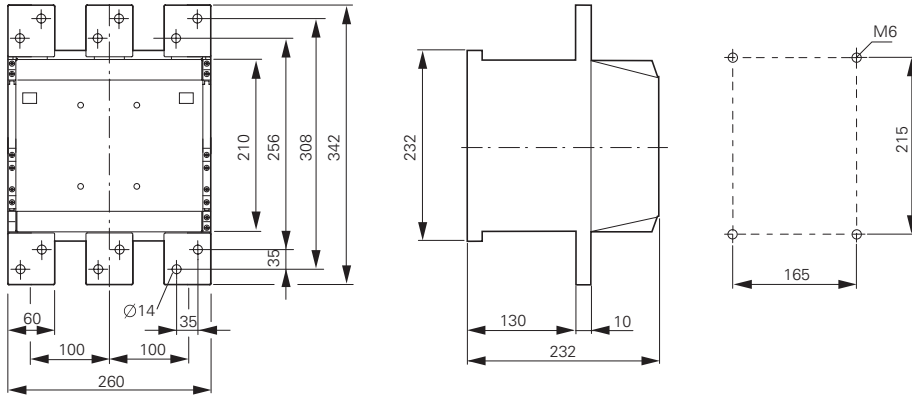

DILM1600

DILH2000

DILH2200

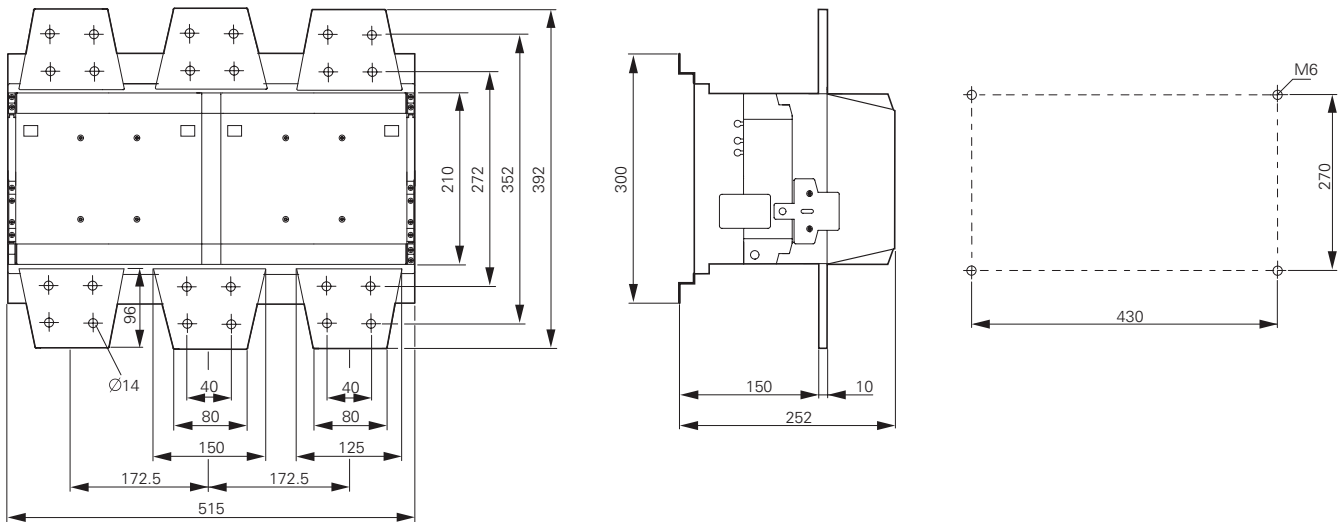

DILH2600

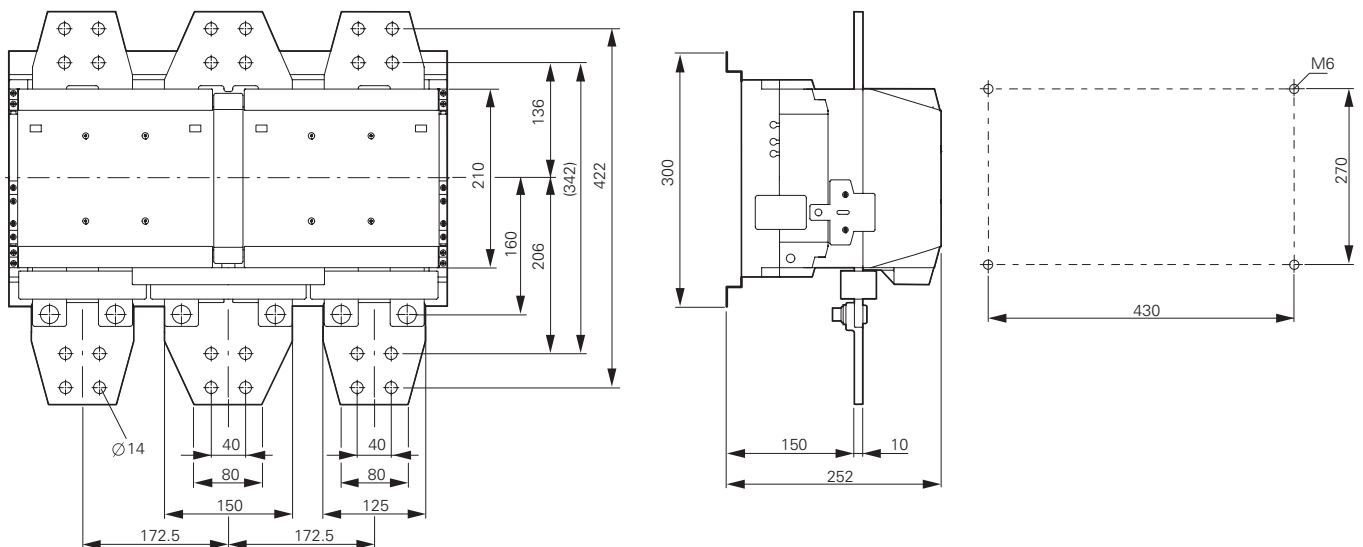

# 1.1

## Contactors

Capacitor contactors, lamp contactors, contactor monitoring devices, SWD contactor modules

### 1 Contactor for capacitors

DILK...

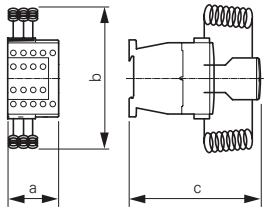

Part no.	a	b	c	a1	b1	d
DILK12	45	135	138	35	75	2 x M4
DILK20	45	135	138	35	75	2 x M4
DILK25	45	135	138	35	75	2 x M4
DILK33	55	190	147	45	105	2 x M4
DILK50	55	190	147	45	105	2 x M4

### Illumination contactors

DILL...

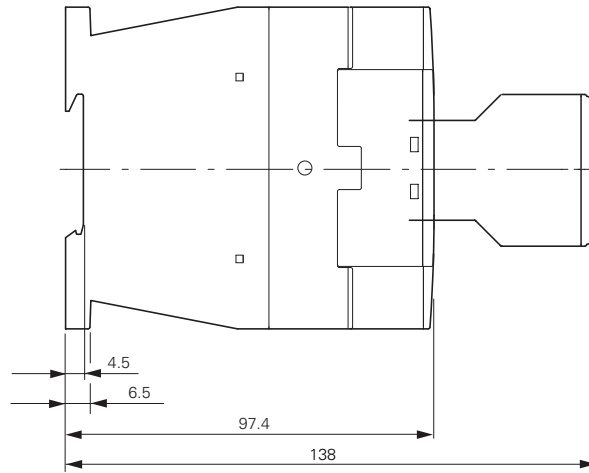

Clearance at side to grounded parts: 6 mm

### Contactor monitoring devices

CMD(...)

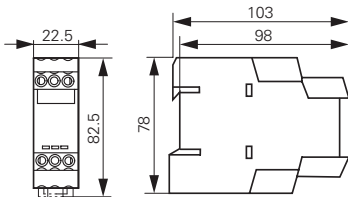

### SWD contactor modules

DIL-SWD-32...

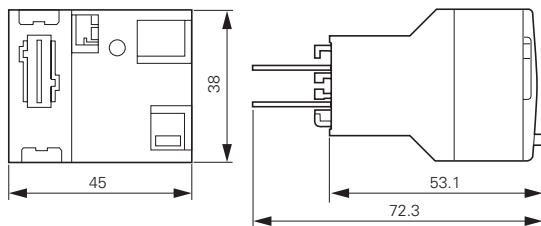

**Star-delta contactors**

SDAINLM12...SDAINLM115

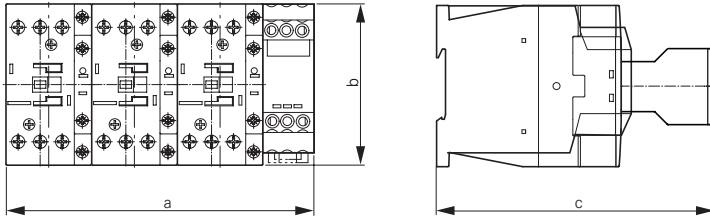

Part no.	a	b	c
SDAINLM12...22	158	68	117
SDAINLM30...55	158	85	138
SDAINLM70...115	188	115	147

SDAINLM140...SDAINLM260

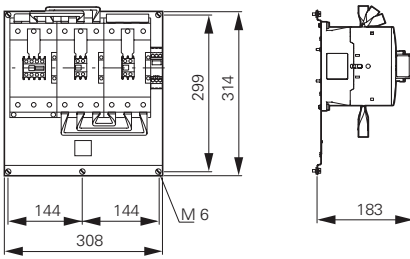

**Reversing contactors**

DIULM7...DIULM65

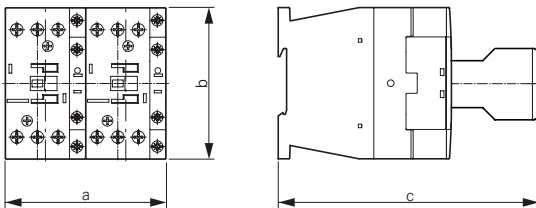

Part no.	a	b	c
DIULM7/21...12/21	90	68	117
DIULM17/21...32/21	90	85	138
DIULM40/11...65/11	110	115	147

DIULM80...DIULM150

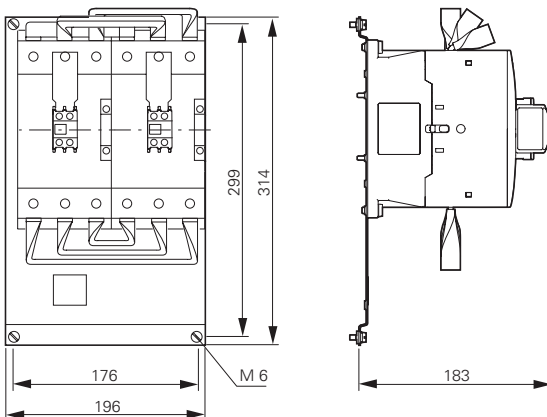



# 1.1 Contactors

## Accessories

### 1 Three-phase commoning links

DILM12-XDSB...

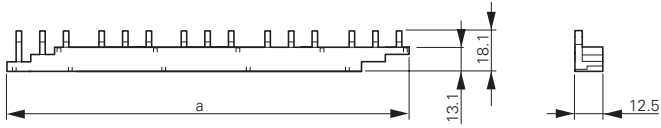

Part no.	a
DILM12-XDSB0/3	112
DILM12-XDSB0/4	157
DILM12-XDSB0/5	202

### Electronic timer modules

DILM...XTE

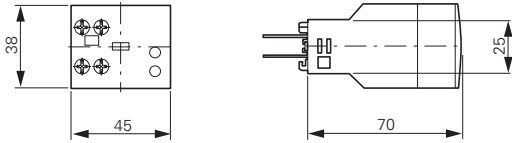

### Amplifier module

ETS4-VS3

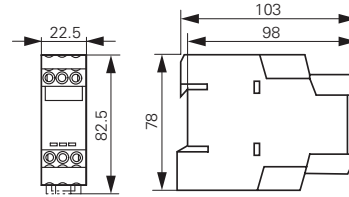

### Wiring set for motor feeder plug

DILM12-XMCE

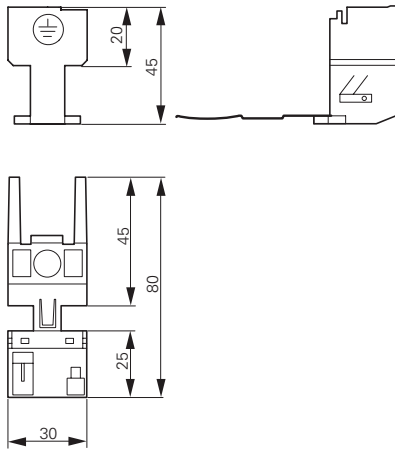

DILM12-XMCP/T

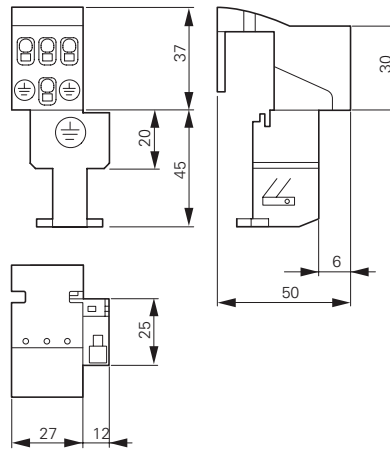

DILM12-XMCP/E

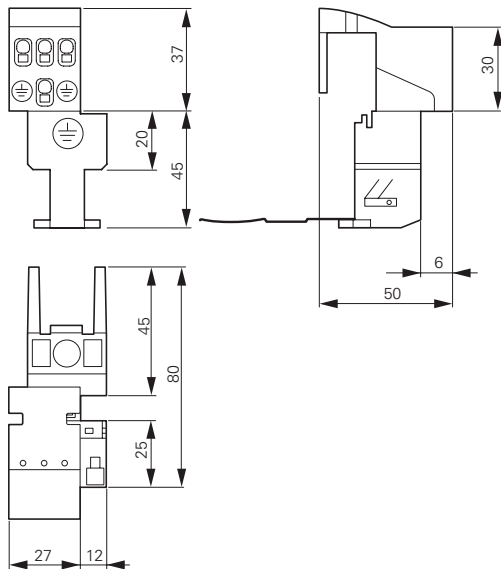

**Contactors with terminal shrouds**

DILM250...DILM1000 + DILM...-XHB



for part no.	a	b
DILM250, DILM300A	150	384
DILM400	150	404
DILM500	174	426
DILM580...1000	236	506

DILM250 + Z5-.../FF250

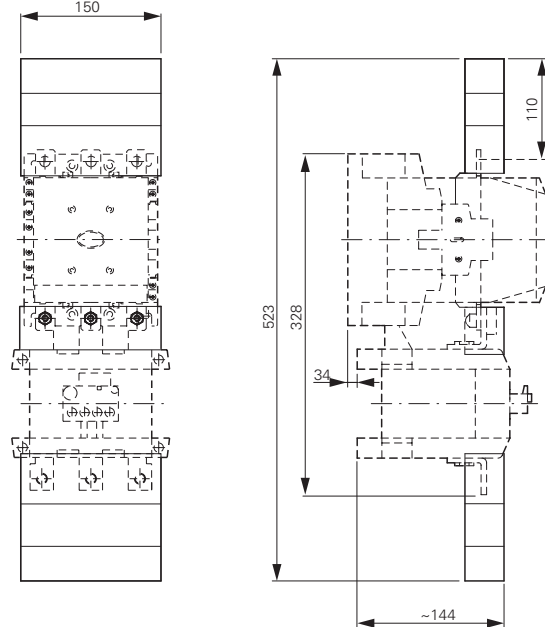

DILM185A...DILM225A + DILM225A-XHB

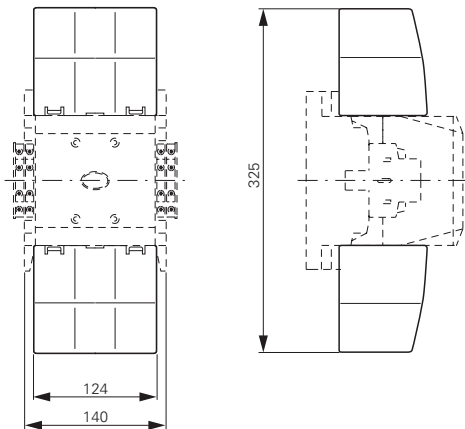

**Contactor with star-point bridge and terminal shroud**

DILM...XS1

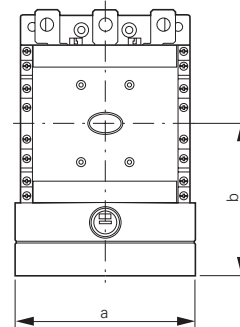

for part no.	a	b
DILM185...250	150	127
DILM300...400	150	137
DILM500	176	146

**Mechanical interlock**

DILM500-XMV

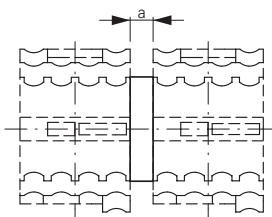

for part no.	a
DILM185...500	15

DILM820-XMV

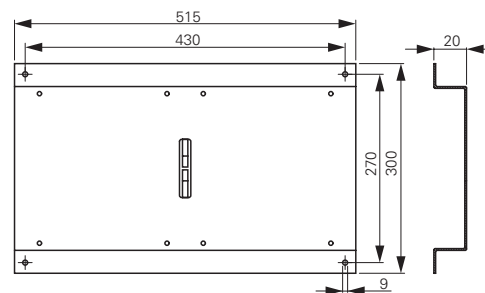



# Overload relay

Motor protection is a central task of electrical equipment for machinery. From cost-effective bimetal solutions to demanding full motor protection with cross-linkage - we offer the right solution for each application.

**ATEX** 

## **Bimetal relay - overload relay up to 630 A**

- Direct mounting on contactor saves mounting time.
- ATEX approval for the protection of EEx e motors up to 250 A.
- Comprehensive motor protection through phase failure sensitivity.
- Integrated test pushbutton facilitates high safety → Page 6.



## **ZEB electronic overload relay - overload relay up to 1500 A**

- ATEX approval for protection of EEx e motors up to 1500 A.
- Adjustable tripping classes.
- Phase failure and unbalance protection.
- Optional earth fault detection.
- Additional current setting range (5:1) → Page 14.

## **EMT6 thermistor overload relay for machine protection**

- Overload protection through direct evaluation of winding temperature.
- Quick detection of operating state through LED display.
- Suitable for overload monitoring of motors in EEx e range.
- Wide range power supply reduces amount of types → Page 19.



## Technical overview

Bimetal relay ZE, ZB, Z5 . . . . .	2
Overload relay ZW7 . . . . .	2
Electronic overload relays ZEB . . . . .	4
EMT6 thermistor overload relay for machine protection . . . . .	4

## Ordering

Bimetal relays for mini-contactor relays . . . . .	6
Bimetal relays up to 150 A . . . . .	8
Bimetal relay greater than 150 A . . . . .	12
Overload relays . . . . .	12
Bimetal relay accessories . . . . .	21
ZEB electronic overload relay . . . . .	14

## Ordering

EMT6 thermistor overload relay for machine protection . . . . .	19
---	----

## Engineering

EMT6 thermistor overload relay for machine protection . . . . .	20
Selection criteria ZE, ZB, Z5, ZW7 . . . . .	23
Characteristic curve ZB, Z5, ZW7 . . . . .	23
UL/CSA short-circuit strength ZE, ZB, Z5 . . . . .	24

## Technical data

Bimetal relay for mini-contactor relays . . . . .	25
Bimetal relays up to 150A . . . . .	25
Overload relays greater than 150 A . . . . .	26
Overload relays . . . . .	26
ZEB electronic overload relay . . . . .	28
EMT6 thermistor overload relay for machine protection . . . . .	29

## Dimensions

Bimetal relays for mini-contactor relays . . . . .	30
Bimetal relays up to 150A . . . . .	30
Bimetal relays greater than 150 A . . . . .	32
Overload relay . . . . .	32
ZEB electronic overload relay . . . . .	33
EMT6 thermistor overload relay for machine protection . . . . .	35

# 1.2

## Overload relays

Overload relays, CT-operated overload relays

### 1 Technical overview

#### Overload relays, CT-operated overload relays

Setting ranges (A)  
(note max. current of the contactor)



**DILEM**

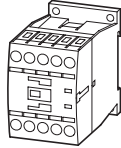

**DILM7 DILM12  
DILM9 DILM15**

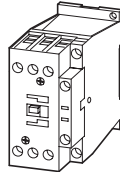

**DILM17 DILM32  
DILM25 DILM38**

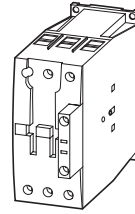

**DILM40 DILM65  
DILM50 DILM72**

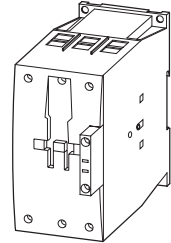

**DILM80 DILM150  
DILM95 DILM170  
DILM115**

#### Overload relays

**ZE**  
0.1-12

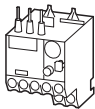

**ZB12**  
0.1-16

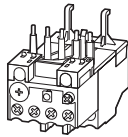

**ZB32**  
0.1-38

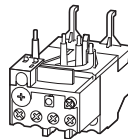

**ZB65**  
6-75

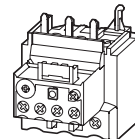

**ZB150**  
35-175

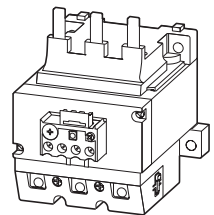

**Z5-.../FF225A**  
70-250

**Z5-.../FF250**  
50-300

#### Current transformer-operated overload relay

**ZW7-...**  
42-630

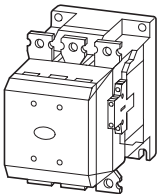

**DILM185A**  
**DILM225A**

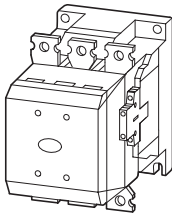

**DILM250**  
**DILM300**

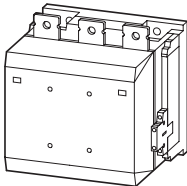

**DILM400 DILM580**  
**DILM500**

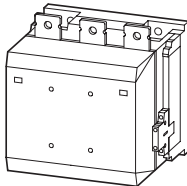

**DILM650**

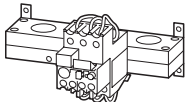
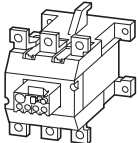
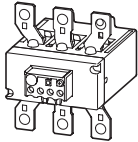

# 1.2

## Overload relays

Electronic overload relays, thermistor overload relay for machine protection

### 1 Electronic overload relays, thermistor overload relay for machine protection

Setting ranges (A)  
(note max. current of the contactor)



**DILEM**

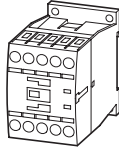

**DILM7 DILM12  
DILM9 DILM15**

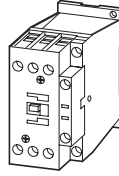

**DILM17 DILM32  
DILM25 DILM38**

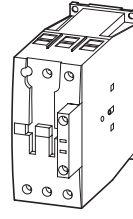

**DILM40 DILM65  
DILM50 DILM72**

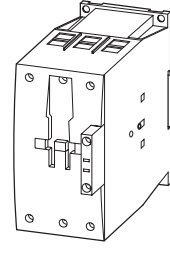

**DILM80 DILM150  
DILM95 DILM170  
DILM115**

#### Electronic overload relays

**ZEB12**  
0.33-20



**ZEB32**  
0.33-45

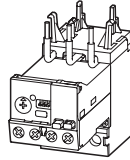

**ZEB65**  
9-100

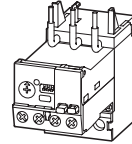

**ZEB150**  
20-100

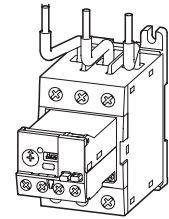

#### ZEB32-5-(GF)/KK combined with

**ZEB-XCT300**  
60-300

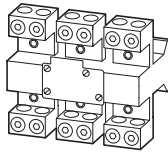

**ZEB-XCT600**  
120-600

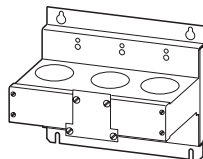

**ZEB-XCT1000**  
200-1000

**ZEB-XCT1500**  
300-1500

#### Thermistor overload relay for machine protection

**EMT6((DB)K)**

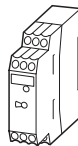

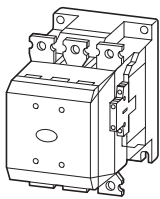

DILM185A  
DILM225A

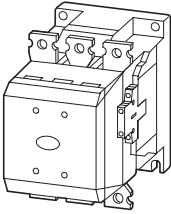

DILM250  
DILM300

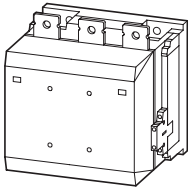

DILM400 DILM500  
DILM580 DILM650

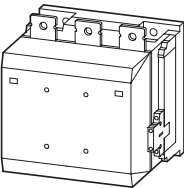

DILM750 DILM820

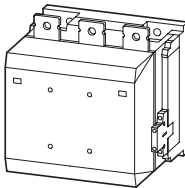

DILM1000

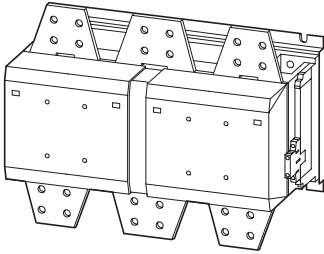

DILM1600

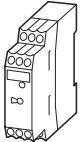



# 1.2



## Overload relays

Bimetal relays for mini-contactor relays

### 1 Ordering

#### ZE overload relays for mini contactor relays

- Phase failure sensitivity to IEC/EN 60947, VDE 0660 Part 102
- Test/off pushbutton
- Reset pushbutton manual/auto
- Trip-free release
- Direct mounting

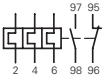
Setting range of overload releases	Circuit symbol	Auxiliary contact		For use with	Short-circuit protection	
		N/O = normally open contact NC = normally closed contact			Type "1" coordination gG/gL A	Type "2" coordination gG/gL A
$I_r$ A 						
0.1 – 0.16		1 N/O	1 NC	DILEM DIULEM/21/MV SDAINLEM	20	0.5
0.16 – 0.24		1 N/O	1 NC		20	1
0.24 – 0.4		1 N/O	1 NC		20	2
0.4 – 0.6		1 N/O	1 NC		20	2
0.6 – 1		1 N/O	1 NC		20	4
1 – 1.6		1 N/O	1 NC		20	6
1.6 – 2.4		1 N/O	1 NC		20	6
2.4 – 4		1 N/O	1 NC		20	10
4 – 6		1 N/O	1 NC		20	10
6 – 9		1 N/O	1 NC		20	10
9 – 12		1 N/O	1 NC		20	10

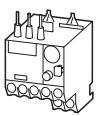

#### Information relevant for export to North America



Product Standards	UL 508; CSA-C22.2 No.14; IEC/EN 60947-4-1; CE marking
UL File No.	E29184
UL CCN	NKCR
CSA File No.	12528
CSA Class No.	3211-03
NA Certification	UL Listed, CSA certified
Suitable for	Branch circuits
Max. Voltage Rating	600 V AC
Degree of Protection	IEC: IP20, UL/CSA Type: -
See also	→ Page 24

Part no. Article no.	Price See price list	Std. pack	Notes
-------------------------	-------------------------	-----------	-------

<b>ZE-0.16</b> 014263		1 Off	Overload release: tripping class 10 A Short-circuit protection: With direct mounting, observe the maximum permissible fuse of the contactor.
<b>ZE-0.24</b> 014285			
<b>ZE-0.4</b> 014300			Suitable for protection of EEx e motors
<b>ZE-0.6</b> 014333			 II (2) GD PTB 01 ATEX 3331
<b>ZE-1.0</b> 014376			Observe manual AWB2300-1425D/GB.
<b>ZE-1.6</b> 014432			
<b>ZE-2.4</b> 014479			
<b>ZE-4</b> 014518			
<b>ZE-6</b> 014565			
<b>ZE-9</b> 014708			
<b>ZE-12</b> 014752			

With side-by-side mounting, there must be a minimum clearance of 5 mm between overload relays.

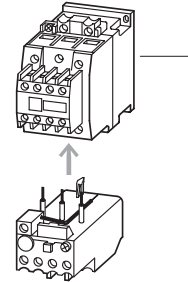

1 Contactor → Chapter 1.1  
 Accessories → Page 21  
 Manual → Page 21

# 1.2

## Overload relays

Overload relays up to 150A

1

### ZB12, ZB32

Setting range of overload releases

Circuit symbol

Auxiliary contact

For use with

Short-circuit protection

$I_r$

A



N/O = normally open contact  
NC = normally closed contact

Contactors

Soft starters

Type "1" coordination

gG/gL

A



Type "2" coordination

gG/gL

A



#### ZB12 overload relay

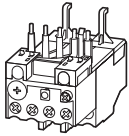

Setting range of overload releases	Circuit symbol	Auxiliary contact	For use with	Soft starters	Type "1" coordination	Type "2" coordination	
0.1 – 0.16		1 N/O 1 NC	DILM7, DILM9, DILM12, DILM15, DIULM7, DIULM9, DIULM12, SDAINLM12, SDAINLM16, SDAINLM22	–	25	0.5	
0.16 – 0.24		1 N/O 1 NC	–	–	25	1	
0.24 – 0.4		1 N/O 1 NC	–	–	25	2	
0.4 – 0.6		1 N/O 1 NC	–	–	25	4	
0.6 – 1		1 N/O 1 NC	–	–	25	4	
1 – 1.6		1 N/O 1 NC	–	–	25	6	
1.6 – 2.4		1 N/O 1 NC	–	–	25	10	
2.4 – 4		1 N/O 1 NC	–	–	DS7-34...SX004...	25	16
4 – 6		1 N/O 1 NC	–	–	DS7-34...SX005...	25	20
6 – 10		1 N/O 1 NC	–	–	DS7-34...SX007... DS7-34...SX009...	50	25
9 – 12		1 N/O 1 NC	–	–	DS7-34...SX012...	50	25
12 – 16		1 N/O 1 NC	–	–	–	50	25

#### ZB32 overload relay

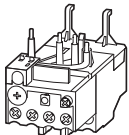

Setting range of overload releases	Circuit symbol	Auxiliary contact	For use with	Soft starters	Type "1" coordination	Type "2" coordination	
0.1 – 0.16		1 N/O 1 NC	DILM17, DILM25, DILM32, DILM38, DILMF8, DILMF11, DILMF14, DILMF17, DILMF25, DILMF32, DIULM17, DIULM25, DIULM32, SDAINLM30, SDAINLM45, SDAINLM55	–	25	0.5	
0.16 – 0.24		1 N/O 1 NC	–	–	25	1	
0.24 – 0.4		1 N/O 1 NC	–	–	25	2	
0.4 – 0.6		1 N/O 1 NC	–	–	25	4	
0.6 – 1		1 N/O 1 NC	–	–	25	4	
1 – 1.6		1 N/O 1 NC	–	–	25	6	
1.6 – 2.4		1 N/O 1 NC	–	–	25	10	
2.4 – 4		1 N/O 1 NC	–	–	25	16	
4 – 6		1 N/O 1 NC	–	–	25	20	
6 – 10		1 N/O 1 NC	–	–	50	25	
10 – 16		1 N/O 1 NC	–	–	DS7-34...SX016...	63	35
16 – 24		1 N/O 1 NC	–	–	DS7-34...SX024...	100	35
24 – 32		1 N/O 1 NC	–	–	DS7-34...SX032...	125	63
32 – 38		1 N/O 1 NC	–	–	–	125	63

#### Information relevant for export to North America



Product Standards  
UL File No.  
UL CCN  
CSA File No.  
CSA Class No.

UL 508; CSA-C22.2 No.14; IEC/EN 60947-4-1; CE marking  
E29184  
NKCR  
12528  
3211-03

NA Certification  
Suitable for  
Max. Voltage Rating  
Degree of Protection  
See also

UL Listed, CSA certified  
Branch circuits  
600 V AC  
IEC: IP20, UL/CSA Type: -  
→ Page 24

**Part no.**  
Article no.

**Price**  
See price list

**Std. pack**

**Notes**

**ZB12-0,16**  
278431

**ZB12-0,24**  
278432

**ZB12-0,4**  
278433

**ZB12-0,6**  
278434

**ZB12-1**  
278435

**ZB12-1,6**  
278436

**ZB12-2,4**  
278437

**ZB12-4**  
278438

**ZB12-6**  
278439

**ZB12-10**  
278440

**ZB12-12**  
278441

**ZB12-16**  
290168

**ZB32-0,16**  
278442

**ZB32-0,24**  
278443

**ZB32-0,4**  
278444

**ZB32-0,6**  
278445

**ZB32-1**  
278446

**ZB32-1,6**  
278447

**ZB32-2,4**  
278448

**ZB32-4**  
278449

**ZB32-6**  
278450

**ZB32-10**  
278451

**ZB32-16**  
278452

**ZB32-24**  
278453

**ZB32-32**  
278454

**ZB32-38**  
112474



Overload release: tripping class 10 A  
Short-circuit protection: With direct mounting, observe the maximum permissible fuse of the contactor.

Suitable for protection of EEx e motors.

II (2) GD  
PTB 04 ATEX 3022

Observe manual AWB2300-1527D/GB.

- Phase failure sensitivity to IEC/EN 60947, VDE 0660 Part 102
- Test/off pushbutton
- Reset pushbutton manual/auto
- Trip-free release
- Direct mounting

Fitted directly to the contactor

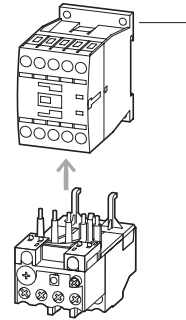

1 Contactor → Chapter 1.1  
Accessories → Page 21  
Manual → Page 21



Overload release: tripping class 10 A  
Short-circuit protection: With direct mounting, observe the maximum permissible fuse of the contactor.

Suitable for protection of EEx e motors.

II (2) GD  
PTB 04 ATEX 3022

Observe manual AWB2300-1527D/GB.

- Phase failure sensitivity to IEC/EN 60947, VDE 0660 Part 102
- Test/off pushbutton
- Reset pushbutton manual/auto
- Trip-free release
- Direct mounting

Fitted directly to the contactor

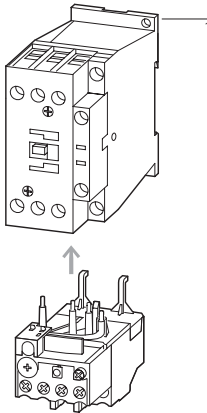

Separate mounting

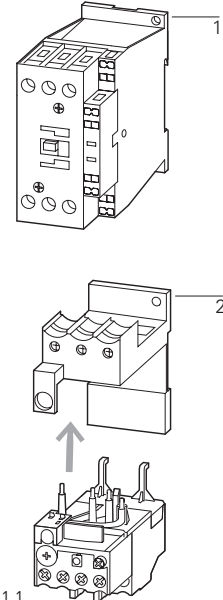

1 Contactor → Chapter 1.1  
2 Base → Page 21  
Manual → Page 21

# 1.2

## Overload relays

Overload relays up to 150A

1

### ZB65, ZB150

Setting range of overload releases

Circuit symbol

Auxiliary contact

For use with

Short-circuit protection



N/O = normally open contact  
NC = normally closed contact

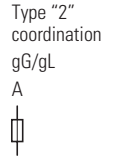
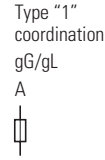

#### ZB65 overload relay

- Phase failure sensitivity to IEC/EN 60947, VDE 0660 Part 102
- Test/off pushbutton
- Reset pushbutton manual/auto
- Trip-free release
- Direct mounting

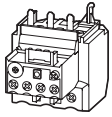

Setting range of overload releases	Circuit symbol	Auxiliary contact	For use with	Short-circuit protection
6 – 10		1 N/O 1 NC	DILM40, DILM50, DILM65, DILM72, DILMF40, DILMF50, DILMF65, DIULM40, DIULM50, DIULM65, SDAINLM70, SDAINLM90, SDAINLM115	Type "1" coordination gG/gL A 50 Type "2" coordination gG/gL A 25
10 – 16		1 N/O 1 NC		63 35
16 – 24		1 N/O 1 NC		63 50
24 – 40		1 N/O 1 NC		125 63
40 – 57		1 N/O 1 NC		160 80
50 – 65		1 N/O 1 NC		160 100
65 – 75		1 N/O 1 NC		250 160

#### ZB150 overload relay

- Phase failure sensitivity to IEC/EN 60947, VDE 0660 Part 102
- Test/off pushbutton
- Reset pushbutton manual/auto
- Trip-free release
- Direct mounting

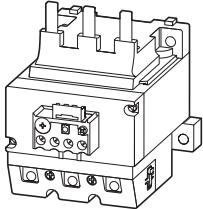

35 – 50		1 N/O 1 NC	DILM80, DILM95, DILM115, DILM150, DILM170, DILMF80, DILMF95, DILMF115, DILMF150, DIULM80, DIULM95, DIULM115, DIULM150, SDAINLM140, SDAINLM165, SDAINLM200, SDAINLM260	160 125
50 – 70		1 N/O 1 NC		250 160
70 – 100		1 N/O 1 NC		315 200
95 – 125		1 N/O 1 NC		315 250
120 – 150		1 N/O 1 NC		315 250
145 – 175		1 N/O 1 NC		315 250

#### ZB150 overload relay

- Phase failure sensitivity to IEC/EN 60947, VDE 0660 Part 102
- Test/off pushbutton
- Reset pushbutton manual/auto
- Trip-free release
- Separate mounting

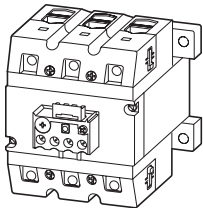

35 – 50		1 N/O 1 NC	DILM80, DILM95, DILM115, DILM150, DILM170, DILMF80, DILMF95, DILMF115, DILMF150, DIULM80, DIULM95, DIULM115, DIULM150, SDAINLM140, SDAINLM165, SDAINLM200, SDAINLM260	160 125
50 – 70		1 N/O 1 NC		250 160
70 – 100		1 N/O 1 NC		315 200
95 – 125		1 N/O 1 NC		315 250
120 – 150		1 N/O 1 NC		315 250
145 – 175		1 N/O 1 NC		400 315

#### Information relevant for export to North America



Product Standards  
UL File No.  
UL CCN  
CSA File No.  
CSA Class No.  
NA Certification  
Suitable for  
Max. Voltage Rating  
Degree of Protection  
See also

UL 508; CSA-C22.2 No.14; IEC/EN 60947-4-1; CE marking  
E29184  
NKCR  
12528  
3211-03  
UL Listed, CSA certified  
Branch circuits  
600 V AC  
IEC: IP00, UL/CSA Type: -  
→ Page 24

**Part no.**  
Article no.

**Price**  
See price list

**Std. pack**



**Notes**

<b>ZB65-10</b> 278455	1 Off	Overload release: tripping class 10 A Short-circuit protection: With direct mounting, observe the maximum permissible fuse of the contactor.
<b>ZB65-16</b> 278456		
<b>ZB65-24</b> 278457		Suitable for protection of EExe motors.
<b>ZB65-40</b> 278458		 II (2) GD PTB 04 ATEX 3022
<b>ZB65-57</b> 278459		Observe manual AWB2300-1545D/GB.
<b>ZB65-65</b> 278460		
<b>ZB65-75</b> 108792		
<b>ZB150-50</b> 278462	1 Off	Overload release: tripping class 10 A Short-circuit protection: With direct mounting, observe the maximum permissible fuse of the contactor.
<b>ZB150-70</b> 278463		
<b>ZB150-100</b> 278464		Suitable for protection of EEx e motors.
<b>ZB150-125</b> 278465		 II (2) GD PTB 04 ATEX 3022
<b>ZB150-150</b> 278466		Observe manual AWB2300-1545D/GB.
<b>ZB150-175</b> 107316		

Fitted directly to the contactor

Separate mounting



<b>ZB150-50/KK</b> 278468	1 Off	Overload release: tripping class 10 A Short-circuit protection: With direct mounting, observe the maximum permissible fuse of the contactor.
<b>ZB150-70/KK</b> 278469		
<b>ZB150-100/KK</b> 278470		Suitable for protection of EEx e motors.
<b>ZB150-125/KK</b> 278471		 II (2) GD PTB 04 ATEX 3022
<b>ZB150-150/KK</b> 278472		Observe manual AWB2300-1545D/GB.
<b>ZB150-175/KK</b> 107317		

1 Contactor → Chapter 1.1  
2 Base → Page 21  
Manual → Page 21

# 1.2

## Overload relays

Overload relays greater than 150 A, CT-operated overload relays

1

### Z5, ZW7

Setting range of overload releases

Circuit symbol

Auxiliary contacts

For use with

Short-circuit protection

N/O = normally open contact  
NC = normally closed contact

Type "1" coordination  
gG/gL

Type "2" coordination  
gG/gL



#### Z5 overload relays greater than 150A

- Phase failure sensitivity to IEC/EN 60947, VDE 0660 Part 102
- Test/off pushbutton
- Reset pushbutton manual/auto
- Trip-free release

Direct mounting  
Separate mounting

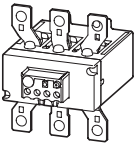

50 – 70

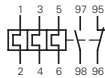

1 N/O 1 NC

DILM185A  
DILM225A

250

160

70 – 100

1 N/O 1 NC

250

160

95 – 125

1 N/O 1 NC

315

200

120 – 160

1 N/O 1 NC

315

200

160 – 220

1 N/O 1 NC

400

250

200 – 250

1 N/O 1 NC

400

250

#### Z5 overload relays greater than 150A

- Phase failure sensitivity to IEC/EN 60947, VDE 0660 Part 102
- Test/off pushbutton
- Reset pushbutton manual/auto
- Trip-free release

Direct mounting  
Separate mounting

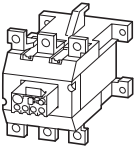

70 – 100

1 N/O 1 NC

DILM250A

250

160

70 – 100

1 N/O 1 NC

250

160

95 – 125

1 N/O 1 NC

315

200

120 – 160

1 N/O 1 NC

315

200

160 – 220

1 N/O 1 NC

315

250

200 – 250

1 N/O 1 NC

315

250

200 – 300

1 N/O 1 NC

DILM300A

400

315

#### ZW7 current transformer-operated overload relays

- Test/off button
- Reset pushbutton manual/auto
- Trip-free release
- Protection with heavy starting duty

Separate mounting

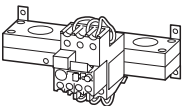

42 – 63

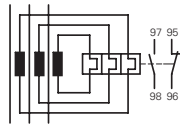

1 N/O 1 NC

–

–

–

60 – 90

1 N/O 1 NC

–

–

–

85 – 125

1 N/O 1 NC

–

–

–

110 – 160

1 N/O 1 NC

–

–

–

160 – 240

1 N/O 1 NC

–

–

–

190 – 290

1 N/O 1 NC

–

–

–

270 – 400

1 N/O 1 NC

–

–

–

360 – 540

1 N/O 1 NC

–

–

–



420 – 630

1 N/O 1 NC

–

–

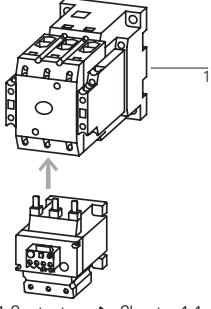
–

Part no. Article no.	Price See price list	Std. pack	Notes	Information relevant for export to North America
<b>Z5-70/FF225A</b> 139572		1 Off	Overload release: tripping class 10 A	Product Standards UL 508; CSA-C22.2 No.14; IEC/EN 60947-4-1; CE marking
<b>Z5-100/FF225A</b> 139573			Short-circuit protection: With direct mounting, observe the maximum permissible fuse of the contactor.	NA Certification Suitable for Branch circuits
<b>Z5-125/FF225A</b> 139574				Max. Voltage Rating 600 V AC
<b>Z5-160/FF225A</b> 139575			Z5-.../FF225A for protecting EEx electric motors in preparation.	Degree of Protection IEC: IP00, UL/CSA Type: - → Page 24
<b>Z5-220/FF225A</b> 139576			Fitted directly to the contactor	
<b>Z5-250/FF225A</b> 139577				
<b>Z5-70/FF250</b> 210070				Product Standards UL 508; CSA-C22.2 No.14; IEC/EN 60947-4-1; CE marking
<b>Z5-100/FF250</b> 210071				UL File No. E29184
<b>Z5-125/FF250</b> 210072				UL CCN NKCR
<b>Z5-160/FF250</b> 210073				CSA File No. 12528
<b>Z5-220/FF250</b> 210074				CSA Class No. 3211-03
<b>Z5-250/FF250</b> 210075				NA Certification UL Listed, CSA certified
<b>Z5-300/FF250</b> 139578				Suitable for Branch circuits
			1 Contactor → Chapter 1.1 Accessories → Page 22	Max. Voltage Rating 600 V AC
				Degree of Protection IEC: IP00, UL/CSA Type: - → Page 24
<b>ZW7-63</b> 000245		1 Off	The main current characteristic values are defined by the main current wiring being used.	Product Standards UL 508; CSA-C22.2 No.14; IEC/EN 60947-4-1; CE marking
<b>ZW7-90</b> 002618			Adjustment for smaller rated motor currents → Page 23	NA Certification Request filed for UL and CSA Branch circuits
<b>ZW7-125</b> 004991				Suitable for Branch circuits
<b>ZW7-160</b> 007364				Max. Voltage Rating 600 V AC
<b>ZW7-240</b> 009737				Degree of Protection IEC: IP00, UL/CSA Type: -
<b>ZW7-290</b> 052448				
<b>ZW7-400</b> 045329				
<b>ZW7-540</b> 047702				
<b>ZW7-630</b> 050075		1 Off		



# 1.2 Electronic overload relays to 1500 A

## Basic devices

1

### ZEB12, ZEB32

Ground fault detection

Setting range of overload releases



Circuit symbol

Auxiliary contact

N/O = normally open contact  
NC = normally closed contact

For use with

#### ZEB12 electronic overload relay

- Phase-failure sensitivity
- Test/off pushbutton
- Reset button
- Manual/Auto reset selectable
- Protection with heavy starting duty (Class 5-30)

Direct mounting

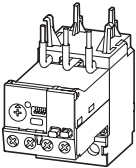

Ground fault detection	Setting range of overload releases	Circuit symbol	Auxiliary contact	For use with	
Without	0.33 – 1.65		1 N/O	1 NC	DILM7 DILM9 DILM12 DILM15
Without	1 – 5		1 N/O	1 NC	DIULM7 DIULM9 DIULM12
Without	4 – 20		1 N/O	1 NC	SDAINLM16 SDAINLM22
With	0.33 – 1.65		1 N/O	1 NC	
With	1 – 5		1 N/O	1 NC	
With	4 – 20		1 N/O	1 NC	

#### ZEB32 electronic overload relay

- Phase-failure sensitivity
- Test/off pushbutton
- Reset button
- Manual/Auto reset selectable
- Protection with heavy starting duty (Class 5-30)

Direct mounting

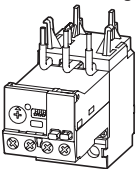

Without	0.33 – 1.65		1 N/O	1 NC	DILM17 DILM25 DILM32 DILM38
Without	1 – 5		1 N/O	1 NC	DIULM17 DIULM25 DIULM32
Without	4 – 20		1 N/O	1 NC	SDAINLM30 SDAINLM45 SDAINLM55
Without	9 – 45		1 N/O	1 NC	
With	0.33 – 1.65		1 N/O	1 NC	
With	1 – 5		1 N/O	1 NC	
With	4 – 20	1 N/O	1 NC		
With	9 – 45	1 N/O	1 NC		

#### ZEB32 electronic overload relay

- Phase-failure sensitivity
- Test/off pushbutton
- Reset button
- Manual/Auto reset selectable
- Protection with heavy starting duty (Class 5-30)

Separate mounting

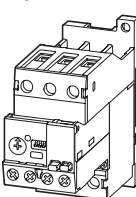

Without	0.33 – 1.65		1 N/O	1 NC	DILM17 DILM25 DILM32 DILM38
Without	1 – 5		1 N/O	1 NC	DIULM17 DIULM25 DIULM32
Without	4 – 20		1 N/O	1 NC	SDAINLM30 SDAINLM45 SDAINLM55
Without	9 – 45		1 N/O	1 NC	
With	0.33 – 1.65		1 N/O	1 NC	
With	1 – 5		1 N/O	1 NC	
With	4 – 20	1 N/O	1 NC		
With	9 – 45	1 N/O	1 NC		

#### Information relevant for export to North America



Product Standards  
NA Certification  
Suitable for  
Max. Voltage Rating  
Degree of Protection

UL 508; CSA-C22.2 No. 14; IEC/EN 60947-4-1; CE marking  
Request filed for UL and CSA  
Branch circuits  
600 V AC  
IEC: IP20, UL/CSA Type: -

Part no. Article no.	Price See price list	Std. pack	Notes	
<b>ZEB12-1,65</b> 136480		1 Off	Suitable for protection of EEx e motors.	Fitted directly to the contactor
<b>ZEB12-5</b> 136481			 II (2) GD PTB ATEX starting 08/2010	 <p>1 Contactor → Chapter 1.1 Accessories → Page 18</p>
<b>ZEB12-20</b> 136482			Observe manual AWB2320-1633D/GB.	
<b>ZEB12-1,65-GF</b> 136483			Switchgear and cable dimensioning according to CLASS	
<b>ZEB12-5-GF</b> 136484			→ Page 18	
<b>ZEB12-20-GF</b> 136485				
<b>ZEB32-1,65</b> 136486		1 Off	Suitable for protection of EEx e motors.	Fitted directly to the contactor
<b>ZEB32-5</b> 136487			 II (2) GD PTB ATEX starting 08/2010	 <p>1 Contactor → Chapter 1.1 Accessories → Page 18</p>
<b>ZEB32-20</b> 136488			Observe manual AWB2320-1633D/GB.	
<b>ZEB32-45</b> 136489			Switchgear and cable dimensioning according to CLASS	
<b>ZEB32-1,65-GF</b> 136490			→ Page 18	
<b>ZEB32-5-GF</b> 136491				
<b>ZEB32-20-GF</b> 136492				
<b>ZEB32-45-GF</b> 136493				
<b>ZEB32-1,65/KK</b> 136494		1 Off	Suitable for protection of EEx e motors.	
<b>ZEB32-5/KK</b> 136495			 II (2) GD PTB ATEX starting 08/2010	
<b>ZEB32-20/KK</b> 136496			Observe manual AWB2320-1633D/GB.	
<b>ZEB32-45/KK</b> 136497			Switchgear and cable dimensioning according to CLASS	
<b>ZEB32-1,65-GF/KK</b> 136498			→ Page 18	
<b>ZEB32-5-GF/KK</b> 136499				
<b>ZEB32-20-GF/KK</b> 136500				
<b>ZEB32-45-GF/KK</b> 136501				

# 1.2 Electronic overload relays to 1500 A

## Basic devices

1

### ZEB65, ZEB150

Ground fault detection	Setting range of overload releases $I_r$ A	Circuit symbol	Auxiliary contact	For use with	
Without	9 – 45		1 N/O	1 NC	DILM40 DILM50 DILM65 DILM72 DIULM40 DIULM50 DIULM65
With	9 – 45		1 N/O	1 NC	SDAINLM70 SDAINLM90 SDAINLM115
Without	20 – 100		1 N/O	1 NC	
With	20 – 100		1 N/O	1 NC	

#### ZEB65 electronic overload relay

- Phase-failure sensitivity
- Test/off pushbutton
- Reset button
- Manual/Auto reset selectable
- Protection with heavy starting duty (Class 5-30)

#### Direct mounting

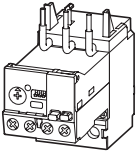

#### ZEB150 electronic overload relay

- Phase-failure sensitivity
- Test/off pushbutton
- Reset button
- Manual/Auto reset selectable
- Protection with heavy starting duty (Class 5-30)

#### Direct mounting

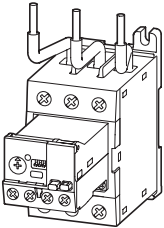

Without	20 – 100		1 N/O	1 NC	DILM80 DILM95 DILM115 DILM150 DIULM80 DIULM95 DIULM115 DIULM150
With	20 – 100		1 N/O	1 NC	SDAINLM140 SDAINLM165 SDAINLM200 SDAINLM260

#### ZEB150 electronic overload relay

- Phase-failure sensitivity
- Test/off pushbutton
- Reset button
- Manual/Auto reset selectable
- Protection with heavy starting duty (Class 5-30)

#### Separate mounting

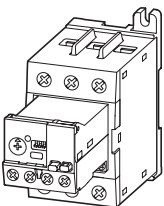



Without	20 – 100		1 N/O	1 NC	DILM80 DILM95 DILM115 DILM150 DIULM80 DIULM95 DIULM115 DIULM150
With	20 – 100		1 N/O	1 NC	SDAINLM140 SDAINLM165 SDAINLM200 SDAINLM260

#### Information relevant for export to North America





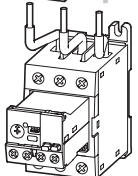







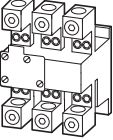

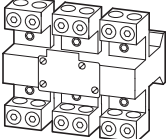

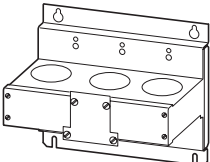
Product Standards	UL 508; CSA-C22.2 No.14; IEC/EN 60947-4-1; CE marking
NA Certification	Request filed for UL and CSA
Suitable for	Branch circuits
Max. Voltage Rating	600 V AC
Degree of Protection	IEC: IP20, UL/CSA Type: -

Part no. Article no.	Price See price list	Std. pack	Notes	
<b>ZEB65-45</b> 136502		1 Off	Suitable for protection of EEx e motors.	Fitted directly to the contactor
<b>ZEB65-45-GF</b> 136503		 	 II (2) GD PTB ATEX starting 08/2010	 <p>1 Contactor → Chapter 1.1 Accessories → Page 18</p>
<b>ZEB65-100</b> 136504			Observe manual AWB2320-1633D/GB.	
<b>ZEB65-100-GF</b> 136505			Switchgear and cable dimensioning according to CLASS → Page 18	
<b>ZEB150-100</b> 136506		1 Off	Suitable for protection of EEx e motors.	Fitted directly to the contactor
<b>ZEB150-100-GF</b> 136507		 	 II (2) GD PTB ATEX starting 08/2010	 <p>1 Contactor → Chapter 1.1 Accessories → Page 18</p>
			Observe manual AWB2320-1633D/GB.	
			Switchgear and cable dimensioning according to CLASS → Page 18	
<b>ZEB150-100/KK</b> 136508		1 Off	Suitable for protection of EEx e motors.	
<b>ZEB150-100-GF/KK</b> 136509		 	 II (2) GD PTB ATEX starting 08/2010	 <p>1 Contactor → Chapter 1.1 Accessories → Page 18</p>
			Observe manual AWB2320-1633D/GB.	
			Switchgear and cable dimensioning according to CLASS → Page 18	

# 1.2 Electronic overload relays to 1500 A

## Accessories

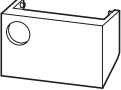
### 1 ZEB-XCT...

	Setting range of overload releases	Language	Can be used with	Part no. Article no.	Price See price list	Std. pack
	$I_r$ A					
<b>Current sensors</b>						
	60 – 300	–	ZEB32-5-GF/KK ZEB32-5/KK	<b>ZEB-XCT300</b> <sup>1)</sup> 136511		1 off  
	120 – 600	–	ZEB32-5-GF/KK ZEB32-5/KK	<b>ZEB-XCT600</b> <sup>1)</sup> 136512		1 off  
	200 – 1000	–	ZEB32-5-GF/KK ZEB32-5/KK	<b>ZEB-XCT1000</b> <sup>1)</sup> 136517		1 off  
	300 – 1500	–		<b>ZEB-XCT1500</b> <sup>1)</sup> 136513		1 off  
<b>Sealable shroud</b>						
Cover to prevent adjustment of motor current (tamper-proof)						
	–	–	–	<b>ZEB-XSC</b> <sup>2)</sup> 136514		1 off  
<b>Reset adapter</b>						
Cover to prevent adjustment of motor current (tamper-proof)						
	–	–	–	<b>ZEB-XRB</b> <sup>2)</sup> 136515		1 off  
<b>Documentation</b>						
ZEB electronic overload relay Overload monitoring of EEx e motors						
	–	Deutsch English	ZEB12 ZEB32 ZEB65 ZEB150	<b>AWB2320-1633DE/EN</b> 136516		1 off

1)

#### Information relevant for export to North America



Product Standards UL 508; CSA-C22.2 No.14; IEC/EN 60947-4-1; CE marking  
NA Certification Request filed for UL and CSA  
Suitable for Branch circuits  
Max. Voltage Rating 600 V AC  
Degree of Protection IEC: IP00, UL/CSA Type: -

2)

#### Information relevant for export to North America



Product Standards UL 508; CSA-C22.2 No.14; IEC/EN 60947-4-1; CE marking  
NA Certification Request filed for UL and CSA  
Max. Voltage Rating 600 V AC  
Degree of Protection IEC: IP20, UL/CSA Type: -

### Switchgear and cable sizing corresponding to the respective starting inertia (CLASS) for ZEB

Switchgear is designed according to "CLASS 10" requirements for both normal and overload operation conditions. In order for the switchgear (circuit-breaker and contactor) and the cables not to be overloaded with long tripping times, they must be oversized accordingly. The rated operational current,  $I_b$ , for switchgear and cables can be calculated with the following current factor taking the tripping class into account:

Tripping class	Class 5	Class 10	Class 15	Class 20	Class 25	Class 30	Class 35	Class 40
Current factor of rated operational current $I_b$	1.00	1.00	1.22	1.41	1.58	1.73	1.89	2.00

## Ordering

### EMT6

Function	Rated operational current	Conventional thermal current	Rated control voltage	Part no. Article no.	Price See price list	Std. pack	Notes
	AC-15 240 V	AC-14 400 V					
	$I_e$ A	$I_e$ A	$I_{th}$ A	$U_s$ V			

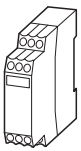

#### EMT6 thermistor machine protection overload relays

Without automatic reset Mains and fault LED display	3	3	6	24 - 240 V 50/60 Hz, 24 - 240 V DC	<b>EMT6</b> <sup>1) 2)</sup> 066166	1 off	II (2) G
				230 V 50/60 Hz	<b>EMT6(230V)</b> <sup>1) 2)</sup> 066400		II (2) GD only for EMT6-K
Without automatic reset Mains and fault LED display Tripped in the event of a short-circuit in the sensor-cable	3	3	6	24 - 240 V 50/60 Hz, 24 - 240 V DC	<b>EMT6-K</b> <sup>2)</sup> 269470		PTB 02 ATEX 3162
Selector switch with/without automatic reset For manual or remote resetting Test button Mains and fault LED display	3	3	6	24 - 240 V 50/60 Hz, 24 - 240 V DC	<b>EMT6-DB</b> <sup>1) 2)</sup> 066167		Observe the manual AWB 2327-1446 → Page 19
				230 V 50/60 Hz	<b>EMT6-DB(230V)</b> <sup>1) 2)</sup> 066401		Can be snap fitted on a top-hat rail to IEC/EN 60715.
Selector switch with/without automatic reset For manual or remote resetting Test button Mains and fault LED display Trip with short-circuit in the sensor cable	3	3	6	24 - 240 V 50/60 Hz, 24 - 240 V DC	<b>EMT6-KDB</b> <sup>2)</sup> 269471		Device clearance ≧ 3 mm.
All-in-one device Selector switch with/without automatic reset Trip with short-circuit in the sensor cable Zero-voltage safe For manual or remote resetting Test button Short-circuit detection and retention can be deactivated Mains and fault LED display	3	3	6	24 - 240 V 50/60 Hz, 24 - 240 V DC	<b>EMT6-DBK</b> <sup>2)</sup> 066168		

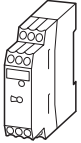
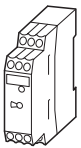

#### Accessories

##### Screw adapters for screw fixing

					<b>CS-TE</b> <sup>3)</sup> 095853	10 off	–

#### Documentation

##### EMT6 thermistor overload relay Overload monitoring of machines in the EEx e area

German					<b>AWB2327-1446D</b> 264853	1 off	
English					<b>AWB2327-1446GB</b> 267010	1 off	

#### Notes

<sup>1)</sup> For EMT6, EMT6(230V), EMT6-DB and EMT6-DB(230V) applies:  
Provide additional short-circuit protection in the sensor circuit with a current monitoring relay.

<sup>2)</sup>

##### Information relevant for export to North America

Product Standards	UL 508; CSA-C22.2 No.14; IEC/EN 60947-4-1; CE marking
UL File No.	E29184
UL CCN	NKCR
CSA File No.	12528
CSA Class No.	3211-03
NA Certification	UL Listed, CSA certified
Max. Voltage Rating	600 V AC
Degree of Protection	IEC: IP20, UL/CSA Type: -

<sup>3)</sup>

##### Information relevant for export to North America

	UL/CSA certification not required

# 1.2 Overload relays for machine protection

Selection aid

## 1 Engineering

### Terminal marking according to EN 50005

EMT6(-K), EMT6(-K)DB, EMT6-DBK  
Auto

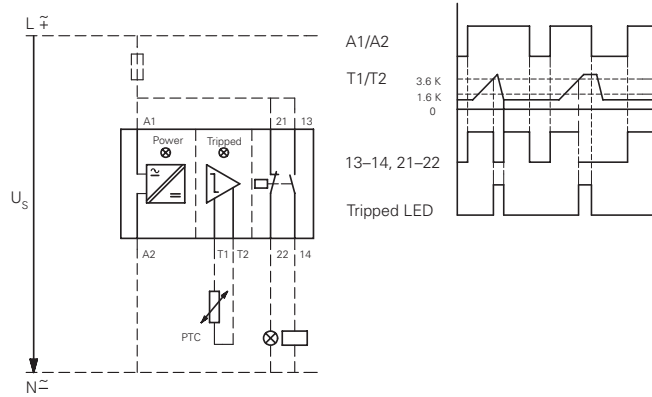

EMT6(-K)DB, EMT6-DBK  
Manual

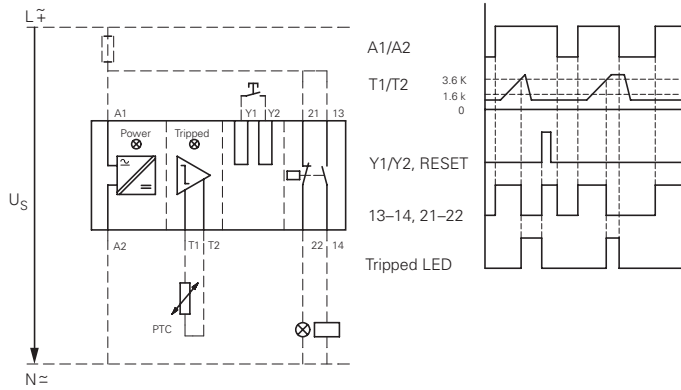

### EMT6-DBK

Zero-voltage safe operation

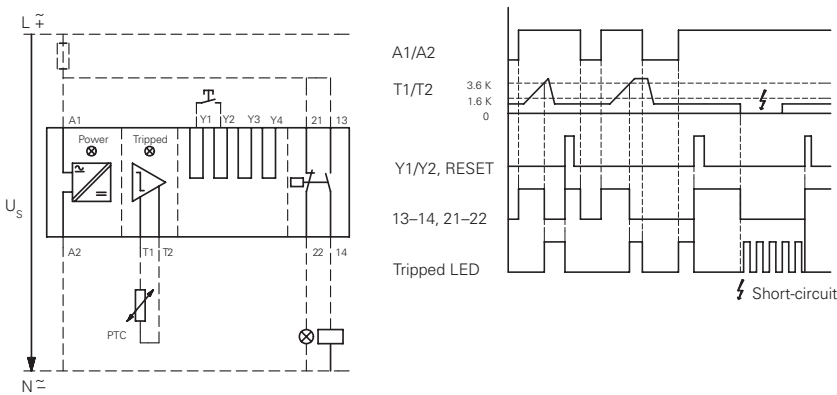

### Sensor circuit

At  $R_K \cong 250 \Omega$  per sensor; at  $R_K \cong 100 \Omega$  per sensor: 9 sensors in the winding (provided by user), max. cable length to sensor 250 m (not shielded); Total PTC thermistor resistance  $\sum R_K \cong 1500 \Omega$

Sensor circuit characteristic values at  $U_S$  and  $+20^\circ\text{C}$

	EMT6...	
$R_{T1-T2}$	$U_{T1-T2}$ V DC max.	$I_{T1-T2}$ mA max.
T1, T2 short-circuited	-	1.9
4 k $\Omega$	3	0.8
T1-T2 open	5.1	-





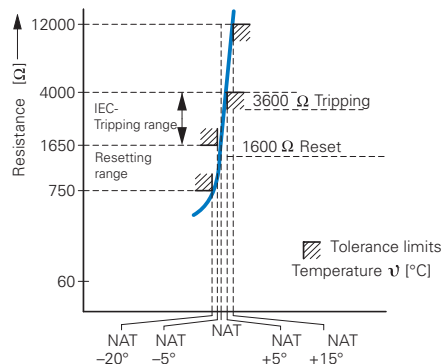









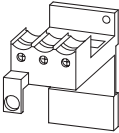

Functions that can be disconnected on the EMT6-DBK:

Function	Disconnection by link
Short-circuit monitoring	Y <sub>1</sub> - Y <sub>3</sub>
Zero-voltage safety	Y <sub>1</sub> - Y <sub>4</sub>



Ordering

ZB, Z5, ZW7

	For use with	Part no. Article no.	Price See price list	Std. pack	Notes	Information relevant for export to North America
						 
<b>Documentation</b> Overload relays Overload monitoring of EEx e motors	ZE...	<b>AWB2300-1425D</b> 258704		1 off	German	
	ZB12... ZB32...	<b>AWB2300-1527D/GB</b> 284910		1 off	German/English	
	ZB65... ZB150...	<b>AWB2300-1545D/GB</b> 102065		1 off	German/English	
<b>Bases</b> For separate mounting	ZB32	<b>ZB32-XEZ</b> 278473		5 off  	Can be snap fitted on a top-hat rail to IEC/EN 60715 or can be screw fitted.	Product Standards UL 508; CSA-C22.2 No.14; IEC/EN 60947-4-1; CE marking E29184
	ZB65	<b>ZB65-XEZ</b> 278474		2 off  	For ZB32-38, use BK25/3-PKZ0 additionally.	UL File No. UL CCN CSA File No. CSA Class No. NA Certification Max. Voltage Rating Degree of Protection 600 V AC IEC: IP00, UL/CSA Type: -
<b>Pushbuttons</b> For enclosed Overload relay Mounting diameter: 22.3 mm External reset button, IP65	ZW7... ZE Z5 ZB12 ZB32 ZB65 ZB150	<b>M22-DZ-B</b> 254833		10 off  	Button plate, blue	Product Standards UL 508; CSA-C22.2 No.14; IEC/EN 60947-4-1; CE marking E29184
	ZW7... ZE Z5 ZB12 ZB32 ZB65 ZB150	<b>M22-DZ-B-GB14</b> 254834		10 off  	Button plate, blue RESET	UL File No. UL CCN CSA File No. CSA Class No. NA Certification NKCR 12528 3211-03 UL Listed, CSA certified
<b>Pushbuttons</b> For enclosed Overload relay Mounting diameter: 22.3 mm Off button, IP65	ZW7... ZE Z5 ZB12 ZB32 ZB65 ZB150	<b>M22-DZ-X</b> 254835		10 off  	Without button plate, add button plate.	Product Standards UL 508; CSA-C22.2 No.14; IEC/EN 60947-4-1; CE marking E29184
	ZW7... ZE Z5 ZB12 ZB32 ZB65 ZB150	<b>M22-DZ-X</b> 254835		10 off  	Without button plate, add button plate.	UL File No. UL CCN CSA File No. CSA Class No. NA Certification NKCR 12528 3211-03 UL Listed, CSA certified
<b>Pushbuttons</b> For enclosed Overload relay Mounting diameter: 22.3 mm Button plates	M22-DZ-X	<b>M22-XD-R</b> 216423		10 off  	Button plate, red	UL/CSA certification not required
	M22-DZ-X	<b>M22-XD-R-X0</b> 218153			Red button plate with white circle	
	M22-DZ-X	<b>M22-XD-R-GB0</b> 218194			Button plate red STOP	

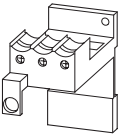



# 1.2 Overload relays

## Accessories

1

### Z5..., K-B..., KS-B...

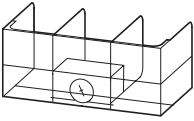
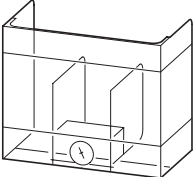
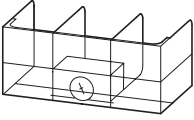
	For use with	Part no. Article no.	Price See price list	Std. pack	Notes		
<b>Covers</b> 	Direct mounting Z5-.../FF225 to DILM185A DILM225A	<b>Z5/FF225A-XHB-Z</b> 139579		1 off	Fitted directly to the contactor		
					DILM400-XHB		
					DILM185A/225A		
					Z5/FF225A-XHB-Z		
<b>Covers</b> 	Z5-.../FF225A Z5-.../FF250	<b>Z5/FF250-XHB</b> 215217		1 off	Separate mounting		
					Z5/FF250-XHB	Fitted directly to the contactor	Fitted directly to the contactor
					Z5-.../FF250/FF225A	DILM400-XHB	DILM400-XHB
					Z5/FF250-XHB	DILM250/300A	DILM185A/225A
						Z5/FF250-XHB-Z	Z5/FF225A-XHB-Z
						Z5-.../FF250	Z5-.../FF225A
<b>Covers</b> 	Direct mounting Z5-.../FF250 to DILM250 DILM300A	<b>Z5/FF250-XHB-Z</b> 215218		1 off	Fitted directly to the contactor		
					DILM400-XHB		
					DILM250/300A		
					Z5/FF250-XHB-Z		
					Z5-.../FF250		

### Box terminals kit

Consisting of 3 individual clamps

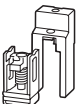
	For use with	For connection of copper flat strip max. W x H mm	Part no. Article no.	Price See price list	Std. pack	Notes
<b>With protective cover</b> 	Z5-.../FF250	24 x 26	<b>K-B-DIL6AM</b> 064062		1 off	When using box terminals the protective covers must be used.
<b>With control circuit terminal and protective cover</b> 	Z5-.../FF250	24 x 26	<b>KS-B-DIL6AM</b> 064063		1 off	When using box terminals the protective covers must be used.

Engineering

Protection of single-phase and DC current motors:

1 pole

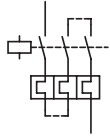

2 pole

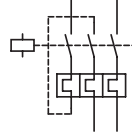

Mounting position:

ZE

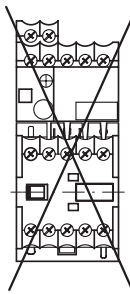
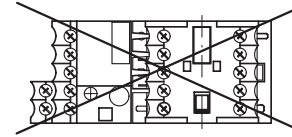

ZB12, ZB32, ZB65, ZB150, Z5

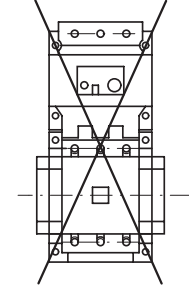

Tripping characteristics

These tripping characteristics are mean values of the spread at 20 °C ambient temperature in a cold state. They show the tripping times in relation to the response current. When the devices are at operational temperature the tripping time of the overload relay drops to approx. 25% of the value shown. Specific characteristics for each individual setting range can be found in the manual on → Page 21

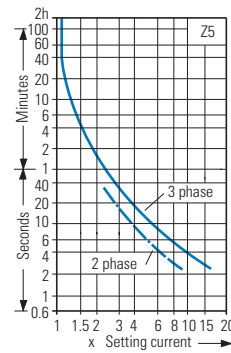
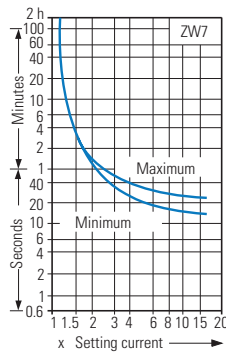
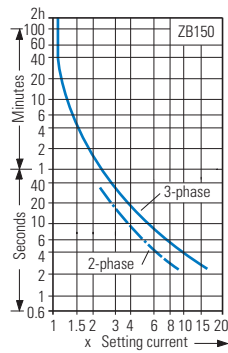
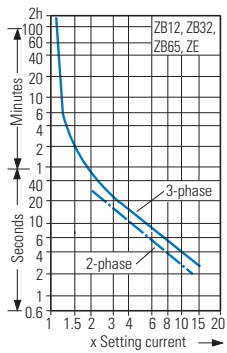

Adaption of ZW7 to smaller rated motor currents

Number of loops	ZW7 -63	-90	-125	-160	-240	-290	-400	-540	-630
	<b>Rated motor current <math>I_N</math> [A]</b>								
1	42-63	60-90	85-125	110-160	160-240	190-290	270-400	360-540	420-630
2	21-31,5	30-45	42,5-62,5	55-80	80-120	95-145	135-200	180-270	210-315
3	14-21	20-30	28,3-41,7	36,7-53,3	53,3-80	63,3-96,7	90-133,3	120-180	140-210
4	10,5-15,8	15-22,5	21,3-31,3	27,5-40	40-60	47,5-72,5	67,5-100	90-135	105-157,5
5	8,4-12,6	12-18	17-25	22-32	32-48	38-58	54-80	72-108	84-126

# 1.2

## Overload relays UL/CSA-short-circuit strength

1

### ZE, ZB, Z5

#### Overload relay short-circuit strength



UL508, CSA-C22,2 No. 14/SCCR values

	Fuse acc. to NEC, CEC		CB	
	A	kA	A	kA
	600V AC		480V AC	
ZE-0,16	1	5	15	5
ZE-0,24	1	5	15	5
ZE-0,4	1	5	15	5
ZE-0,6	1	5	15	5
ZE-1,0	3	5	15	5
ZE-1,6	6	5	15	5
ZE-2,4	6	5	15	5
ZE-4	15	5	15	5
ZE-6	20	5	15	5
ZE-9	35	5	15	5
ZE-12	45	5	-	-
	600V AC			
ZB12(32)-0,16	1 CLASS J/CC	100	-	-
ZB12(32)-0,24	1 CLASS J/CC	100	-	-
ZB12(32)-0,4	1 CLASS J/CC	100	-	-
ZB12(32)-0,6	1 CLASS J/CC	100	-	-
ZB-12(32)-1,0	1 CLASS J/CC	100	-	-
ZB-12(32)-1,6	3 CLASS J/CC	100	-	-
ZB-12(32)-2,4	3 CLASS J/CC	100	-	-
ZB-12(32)-4	6 CLASS J/CC	100	-	-
ZB-12(32)-6	10 CLASS J/CC	100	-	-
ZB-12(32)-10	15 CLASS J/CC	100	-	-
ZB12-12	15 CLASS J/CC	100	-	-
ZB12-16	30 CLASS J/CC	100	-	-
ZB32-16	35 CLASS J	100	-	-
ZB32-24	45 CLASS J	100	-	-
ZB32-32	60 CLASS J	100	-	-
	600V AC		600V AC	
ZB65-10	15 CLASS J	100	40	5
ZB65-16	35 CLASS J	100	60	5
ZB65-24	45 CLASS J	100	90	5
ZB65-40	60 CLASS J	100	125	5
ZB65-57	110 CLASS J	100	150	10
ZB65-65	125 CLASS J	100	150	10
ZB65-75	125 CLASS J	100	150	10

	Fuse acc. to NEC, CEC		CB	
	A	kA	A	kA
	600V AC		600 V AC	
ZB150-50	225	5	200	5
ZB150-70	250	10	250	10
ZB150-100	400 CLASS J	10	400	10
ZB150-125	500 CLASS J	10	500	10
ZB150-150	600 CLASS J	10	600	10
ZB150-175	600 CLASS J	10	600	10
ZB150-50(KK)	110 CLASS J	100	200	5
ZB150-70(KK)	125 CLASS J	100	250	10
ZB150-100(KK)	200 CLASS J	100	400	10
ZB150-125(KK)	250 CLASS J	100	500	10
ZB150-150(KK)	300 CLASS J	100	600	10
ZB150-175(KK)	300 CLASS J	100	600	10
	600V AC		600V AC	
Z5-70/...	250	10	250	10
Z5-100/...	400 CLASS J	10	400	10
Z5-125/...	500 CLASS J	10	500	10
Z5-160/...	600 CLASS J	10	600	10
Z5-220/...	800 CLASS J	10	800	10
Z5-250/...	700 CLASS J	10	600	10
Z5-70/...	125 CLASS J	100	-	-
Z5-100/...	200 CLASS J	100	-	-
Z5-125/...	250 CLASS J	100	-	-
Z5-160/...	300 CLASS J	100	-	-

Technical data

ZE, ZB

			ZE	ZB12, ZB32	ZB65	ZB150(KK)
<b>General</b>						
Standards			IEC/EN 60947, VDE 0660, UL, CSA			
Climatic proofing			Damp heat, constant, to IEC 60068-2-78 Damp heat, cyclic, to IEC 60068-2-30			
Ambient temperature						
Open <sup>1)</sup>	°C		-25...50	-25...55	-25...55	-25...55
Enclosed <sup>1)</sup>	°C		-25...40	-25...40	-25...40	-25...40
Temperature compensation			Continuous			
Mounting position			→ Page 23			
Weight	kg		0.07	0.15	0.25	1.64
Mechanical shock resistance half-sinusoidal shock, 10 ms to IEC 60068-2-27	g		10	10	10	10
Protection type			IP20	IP20	IP00	IP00
Protection against direct contact when actuated from front (EN 50274)			Finger- and back-of-hand proof			
<b>Main contacts</b>						
Rated impulse withstand voltage	$U_{imp}$	V AC	6000	6000	6000	8000
Overtoltage category/pollution degree			III/3	III/3	III/3	III/3
Rated insulation voltage						
AC	$U_i$	V AC	690	690	690	1000
Rated operating voltage	$U_e$	V AC	690	690	690	1000
Safe isolation according to EN 61140						
Between auxiliary contacts and main contacts		V AC	300	440	440	440
Between the main contacts		V AC	300	440	440	440
Overload relay setting range		A	0.1...12	0.1...38	6...75	25...175
Temperature compensation residual error > 40 °C		%/K	≅ 0.25	≅ 0.25	≅ 0.25	≅ 0.25
Short-circuit protection rating maximum fuse			→ Page 6	→ Page 8	→ Page 10	→ Page 10
Current heat loss (3 conductors)						
Lower value of setting range		W	2.5	2.5	3	16
Upper value of setting range		W	6	6	7.5	18
Terminal capacity						
Solid		mm <sup>2</sup>	2 x (0.75 - 2.5)	2 x (1 - 6) <sup>5)</sup>	2 x (1 - 16) <sup>4)</sup>	2 x (4 - 16)
Flexible with ferrule		mm <sup>2</sup>	2 x (0.5 - 1.5)	2 x (1 - 4) <sup>5)</sup> 2 x (1 - 6) <sup>3)</sup>	1 x (1...25) <sup>2)</sup> 2 x (1...10) <sup>2)</sup>	1 x (4 - 70) 2 x (4 - 50)
Stranded		mm <sup>2</sup>	–	–	1 x (16...25)	1 x (16...50) 2 x (16...50)
Solid or stranded		AWG	18 - 14	14 - 8 <sup>5)</sup>	14 - 2	3/0
Busbar	Width	mm	–	–	–	–
Terminal screw			M3.5	M4	M6	M10
Tightening torque		Nm	1.2	1.8 <sup>5)</sup>	3.5	10
<b>Tools</b>						
Pozidriv screwdriver		Size	2	2	2	–
Flat-blade screwdriver		mm	0.8 x 5.5	1 x 6	1 x 6	–
Hexagon socket	SW	mm	–	–	–	5

Notes

- <sup>1)</sup> Ambient temperature: Operating range to IEC/EN 60947, PTB: -5°C to +55°C
- <sup>2)</sup> Use identical cross-section when using two conductors
- <sup>3)</sup> 6 mm flexible with ferrules to DIN 46228
- <sup>4)</sup> With ZB65-XEZ max 1 x (1... 16)
- <sup>5)</sup> ZB32-38: solid and flexible with ferrule, 2.5 - 25 mm<sup>2</sup>, 3 Nm tightening torque. AWG10-b, 27 lb-in tightening torque for solid or stranded conductors.

# 1.2

## Overload relays

### Overload relays, CT-operated overload relays

#### 1 Z5, ZW7

		Z5-.../FF225A(250)		ZW7
<b>General</b>				
Standards		IEC/EN 60947, VDE 0660, UL, CSA		IEC/EN 60947, VDE 0660, UL, CSA
Climatic proofing		Damp heat, constant, to IEC 60068-2-78 Damp heat, cyclic, to IEC 60068-2-30		
Ambient temperature				
Open <sup>1)</sup>	°C	-25...50		-25...50
Enclosed <sup>1)</sup>	°C	-25...40		-25...40
Temperature compensation		Continuous		Continuous
Mounting position		→ Page 23		Any
Weight	kg	1.55		0.8
Mechanical shock resistance half-sinusoidal shock, 10 ms to IEC 60068-2-27	g	10		10
Protection type		IP00		IP00
Protection against direct contact when actuated from front (EN 50274)		With terminal cover		Finger- and back-of-hand proof
<b>Main contacts</b>				
Rated impulse withstand voltage	$U_{imp}$	V AC	8000	6000
Overvoltage category/pollution degree			III/3	III/3
Rated insulation voltage				
AC	$U_i$	V AC	1000	690
Rated operating voltage	$U_e$	V AC	1000	690
Safe isolation according to EN 61140				
Between auxiliary contacts and main contacts		V AC	440	440
Between the main contacts		V AC	440	440
Overload relay setting range		A	50...300	42...630
Temperature compensation residual error > 40 °C		%/K	≤ 0.25	–
Short-circuit protection rating maximum fuse			→ Page 12	With overload relay in conjunction with a transformer as required for the contactor
Current heat loss (3 conductors)				
Lower value of setting range		W	16	3
Upper value of setting range		W	28	10
Terminal capacity				
Flexible with ferrule		mm <sup>2</sup>	95	–
Stranded with ferrule		mm <sup>2</sup>	120	–
Solid or stranded		AWG	250 MCM	–
Flat conductor.	Number of segments x width x thickness	mm	6 x 16 x 0.8 <sup>2)</sup>	–
Busbar	Width	mm	20 x 3	–
Push-through opening	∅	mm	–	27
Terminal screw			M8 x 25	–
Tightening torque		Nm	24	–
Tools				
Hexagonal socket		SW	mm	13

#### Notes

<sup>1)</sup> Ambient temperature: Operating range to IEC/EN 60947, PTB: -5°C to +50°C

<sup>2)</sup> Fixing with box terminals

## ZE, ZB, Z5, ZW7

			ZE	ZB12, ZB32	ZB65	ZB150(KK)	Z5-.../FF225 Z5-.../FF250	ZW7
<b>Auxiliary and control circuits</b>								
Rated impulse withstand voltage	$U_{imp}$	V	6000	6000	6000	6000	6000	6000
Overvoltage category/Pollution degree			III/3	III/3	III/3	III/3	III/3	III/3
Terminal capacity								
Solid		mm <sup>2</sup>	2 x (0.75 - 2.5)	2 x (0.75 - 4)	2 x (0.75 - 4)	2 x (0.75 - 4)	2 x (0.75 - 4)	2 x (0.75 - 4)
Flexible with ferrule		mm <sup>2</sup>	2 x (0.5 - 1.5)	2 x (0.75 - 2.5)	2 x (0.75 - 2.5)	2 x (0.75 - 2.5)	2 x (0.75 - 2.5)	2 x (0.75 - 2.5)
Solid or stranded		AWG	2 x (18 - 12)	2 x (18 - 12)	2 x (18 - 12)	2 x (18 - 12)	2 x (18 - 12)	2 x (18 - 12)
Terminal screw			M3.5	M3.5	M3.5	M3.5	M3.5	M3.5
Tightening torque		Nm	0.8 - 1.2	0.8 - 1.2	0.8 - 1.2	0.8 - 1.2	0.8 - 1.2	0.8 - 1.2
Tools								
Pozidriv screwdriver		Size	2	2	2	2	2	2
Flat-blade screwdriver		mm	0.8 x 5.5	1 x 6	1 x 6	1 x 6	1 x 6	1 x 6
Auxiliary circuit rated insulation voltage	$U_i$	V AC	690	500	500	500	500	500
Rated operating voltage	$U_e$	V AC	500	500	500	500	500	500
Safe isolation according to EN 61140								
Between the auxiliary contacts		V AC	300	240	240	240	240	240
Conventional thermal current	$I_{th}$	A	6	6	6	6	6	6
Rated operational current								
AC-15								
N/O								
120 V	$I_e$	A	1.5	1.5	1.5	1.5	1.5	1.5
240 V	$I_e$	A	1.5	1.5	1.5	1.5	1.5	1.5
415 V	$I_e$	A	0.5	0.5	0.5	0.5	0.5	0.5
500 V	$I_e$	A	0.3	0.5	0.5	0.5	0.5	0.5
NC								
120 V	$I_e$	A	1.5	1.5	1.5	1.5	1.5	1.5
240 V	$I_e$	A	1.5	1.5	1.5	1.5	1.5	1.5
415 V	$I_e$	A	0.7	0.9	0.9	0.9	0.9	0.9
500 V	$I_e$	A	0.5	0.8	0.8	0.8	0.8	0.8
DC-13 L/R $\leq 15$ ms <sup>1)</sup>								
24 V	$I_e$	A	0.9	0.9	0.9	0.9	0.9	0.9
60 V	$I_e$	A	0.75	0.75 <sup>3)</sup>	0.75 <sup>3)</sup>	0.75 <sup>3)</sup>	0.75 <sup>3)</sup>	0.75 <sup>3)</sup>
110 V	$I_e$	A	0.4	0.4	0.4	0.4	0.4	0.4
220 V	$I_e$	A	0.2	0.2	0.2	0.2	0.2	0.2
General Use								
AC operated		V	240 600	–	–	–	–	–
AC operated		A	1.5 0.6	–	–	–	–	–
DC operated		V	–	–	–	–	–	–
DC operated		A	–	–	–	–	–	–
Pilot Duty								
AC operated			D300	B300 <sup>4)</sup> B600 <sup>5)</sup>	B300 <sup>4)</sup> B600 <sup>5)</sup>	B300 <sup>4)</sup> B600 <sup>5)</sup>	B300 <sup>4)</sup> B600 <sup>5)</sup>	B300 <sup>4)</sup> B600 <sup>5)</sup>
DC operated			R300	R300	R300	R300	R300	R300
Short-circuit rating without welding								
Max. fuse <sup>2)</sup>		A gG/gL	4	6	6	6	6	6

### Notes

- <sup>1)</sup> Making and breaking conditions to DC-13, time constant as stated
- <sup>2)</sup> See transparent overlay "Fuses" for time/current characteristics (please enquire)
- <sup>3)</sup> Rated operational current DC-13, 60 V: N/O auxiliary contact 0.6 A
- <sup>4)</sup> With opposite polarity
- <sup>5)</sup> With same polarity

# 1.2 Electronic overload relays to 1500 A

ZEB

1

				ZEB12, ZEB32	ZEB65-45	ZEB65-100	ZEB150
<b>General</b>							
Standards	IEC/EN 60947, VDE 0660, UL, CSA						
Climatic proofing	Damp heat, constant, to IEC 60068-2-78 Damp heat, cyclic, to IEC 60068-2-30						
Ambient temperature							
Open	°C		-25...65	-25...65	-25...65	-25...65	-25...65
Enclosed	°C		-25...65	-25...40	-25...40	-25...40	-25...40
Temperature compensation	Continuous						
Mounting position	Any						
Mechanical shock resistance half-sinusoidal shock, 10 ms to IEC 60068-2-27	g		15	15	15	15	15
Protection type	IP20						
Protection against direct contact when actuated from front (EN 50274)	Finger- and back-of-hand proof						
<b>Main contacts</b>							
Rated impulse withstand voltage	$U_{imp}$	V AC	6000	6000	6000	6000	6000
Overvoltage category/pollution degree	III / 3						
Rated insulation voltage							
AC	$U_i$	V AC	690	690	690	690	690
Rated operating voltage	$U_e$	V AC	690	690	690	690	690
Safe isolation according to EN 61140							
Between auxiliary contacts and main contacts	V AC		600	600	600	600	600
Between the main contacts	V AC		600	600	600	600	600
Overload relay setting range	A		0.3...45	9...45	20...100	20...100	20...100
Terminal capacity							
Solid	mm <sup>2</sup>		1 x 2.5 - 16	1 x 2.5 - 16	1 x 6 - 50	1 x 6 - 50	1 x 6 - 50
Solid or stranded	AWG		1 x 14 - 4	1 x 14 - 4	1 x 10 - 1	1 x 10 - 1	1 x 10 - 1
<b>Auxiliary and control circuits</b>							
Rated impulse withstand voltage	$U_{imp}$	V	6000	6000	6000	6000	6000
Overvoltage category/pollution degree	III / 3						
Terminal capacity							
Solid	mm <sup>2</sup>		2 x (0.75 - 4)	2 x (0.75 - 4)	2 x (0.75 - 4)	2 x (0.75 - 4)	2 x (0.75 - 4)
Flexible with ferrule	mm <sup>2</sup>		2 x (0.75 - 2.5)	2 x (0.75 - 2.5)	2 x (0.75 - 2.5)	2 x (0.75 - 2.5)	2 x (0.75 - 2.5)
Solid or stranded	AWG		2 x (18 - 12)	2 x (18 - 12)	2 x (18 - 12)	2 x (18 - 12)	2 x (18 - 12)
Terminal screw	M3.5						
Terminal screw	Nm		0.8 - 1.2	0.8 - 1.2	0.8 - 1.2	0.8 - 1.2	0.8 - 1.2
Tightening torque	lb-in		7 - 10.6	7 - 10.6	7 - 10.6	7 - 10.6	7 - 10.6
Tools							
Pozidriv screwdriver	Size		2	2	2	2	2
Flat-blade screwdriver	mm		1 x 6	1 x 6	1 x 6	1 x 6	1 x 6
Auxiliary circuit rated insulation voltage	$U_i$	V AC	500	500	500	500	500
Rated operating voltage	$U_e$	V AC	500	500	500	500	500
Safe isolation according to EN 61140							
Between the auxiliary contacts	V AC		240	240	240	240	240
Conventional thermal current	$I_{th}$	A	5	5	5	5	5
Rated operational current							
AC-15							
N/O							
120 V	$I_e$	A	1.5	1.5	1.5	1.5	1.5
240 V	$I_e$	A	1.5	1.5	1.5	1.5	1.5
415 V	$I_e$	A	0.5	0.5	0.5	0.5	0.5
500 V	$I_e$	A	0.5	0.5	0.5	0.5	0.5
NC							
120 V	$I_e$	A	1.5	1.5	1.5	1.5	1.5
240 V	$I_e$	A	1.5	1.5	1.5	1.5	1.5
415 V	$I_e$	A	0.9	0.9	0.9	0.9	0.9
500 V	$I_e$	A	0.8	0.8	0.8	0.8	0.8
DC-13 L/R $\leq$ 15 ms							
24 V	$I_e$	A	0.9	0.9	0.9	0.9	0.9
60 V	$I_e$	A	0.75	0.75	0.75	0.75	0.75
110 V	$I_e$	A	0	0	0.4	0.4	0.4
220 V	$I_e$	A	0.2	0.2	0.2	0.2	0.2
Short-circuit rating without welding							
Max. fuse	A gG/gL		6	6	6	6	6

EMT6

EMT6

1

<b>General</b>			
Standards			IEC/EN 60947, VDE 0660, EN 55011
Climatic proofing			Damp heat, constant, to IEC 60068-2-78; Damp heat, cyclic, to IEC 60068-2-30
Ambient temperature			
Open	°C		-25...60
Enclosed	°C		-25...45
Storage	°C		-45 - 60
Mounting position			Any
Weight	kg		0.15
Shock resistance half-sinusoidal shock 10 ms to IEC 60068-2-27	g		10
Protection type			IP20
Protection against direct contact when actuated from front (EN 50274)			Finger- and back-of-hand proof
Safe isolation according to EN 61140			
Between the contacts	V AC		250
Between contacts and supply voltage	V AC		250
<b>Auxiliary and control circuits</b>			
Rated impulse withstand voltage	$U_{imp}$	V AC	6000
Oversvoltage category/pollution degree			III/3
Auxiliary and control circuit terminal capacity			
Solid	mm <sup>2</sup>		1 x 2.5 2 x (0.5 - 1.5)
Flexible with ferrule	mm <sup>2</sup>		1 x 2.5 2 x (0.5 - 1.5)
Solid or stranded	AWG		20 - 14
Terminal screw			M3.5
Tightening torque	Nm		1.2
Tools			
Pozidriv screwdriver	Size		2
Flat-blade screwdriver	mm		1 x 6
<b>Auxiliary circuit</b>			
Rated insulation voltage	$U_i$	V	400
Rated operational current			
AC-14			
N/O			
415 V	$I_e$	A	3
NC			
415 V	$I_e$	A	3
AC-15			
N/O			
240 V	$I_e$	A	3
415 V	$I_e$	A	1
NC			
240 V	$I_e$	A	3
415 V	$I_e$	A	1
Max. short-circuit protective device			
Fuse	gG/gL		6
<b>Control circuit</b>			
Rated insulation voltage	$U_i$	V	240
Rated operational voltage	$U_e$	V	240 <sup>1)</sup>
Voltage tolerance		x $U_e$	0.85 - 1.1
Power consumption			
AC		VA	3.5
DC		W	2
Trip at approx.		$\Omega$	$\cong$ 3600
Reset at approx.		$\Omega$	$\cong$ 1600

Notes

<sup>1)</sup> EMT6(-DB)230V:  $U_e = 230$  V



# 1.2

## Overload relays

Overload relays

### 1 Dimensions

#### Overload relays

ZE-...

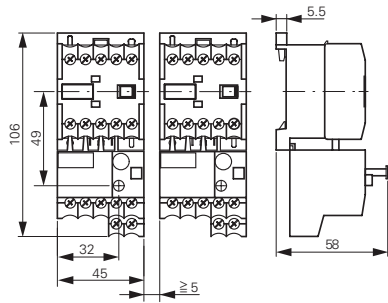

#### Base

ZB32-XEZ

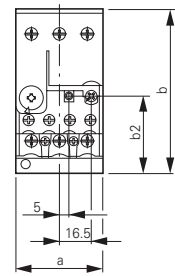

ZB65-XEZ

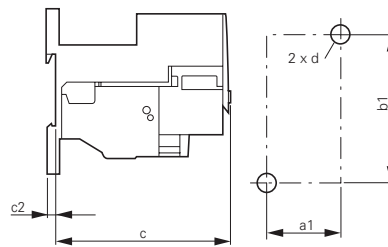

	ZB32	ZB65
a	45	60
b	85	86
c	90.5	112
c2	3.8	4.7
a1	35	50
b1	75	75
b2	40.5	47
d	M4	M5

ZB12

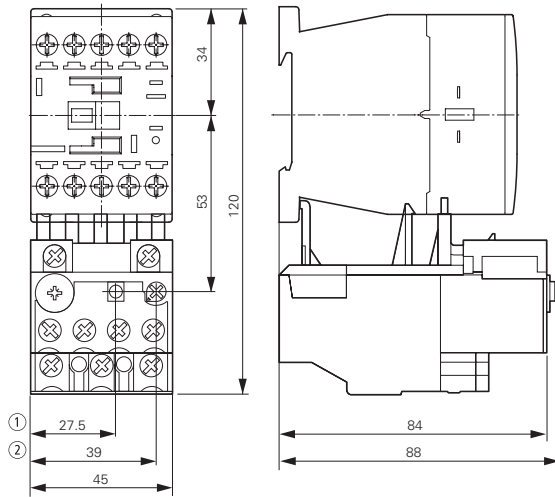

- ① OFF
- ② Reset/ON

ZB32

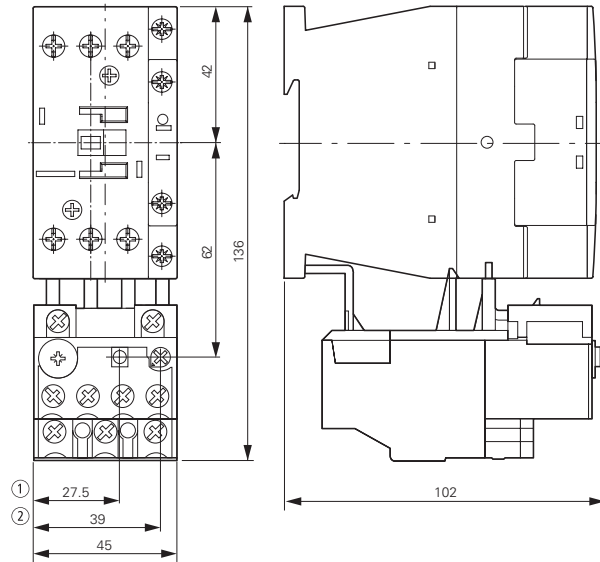

ZB32-38

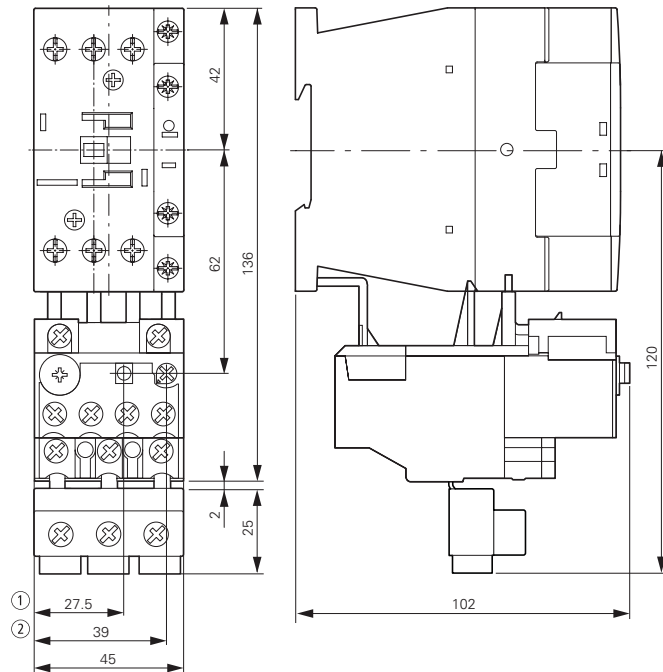

- ① OFF
- ② Reset/ON

Overload relays

ZB65

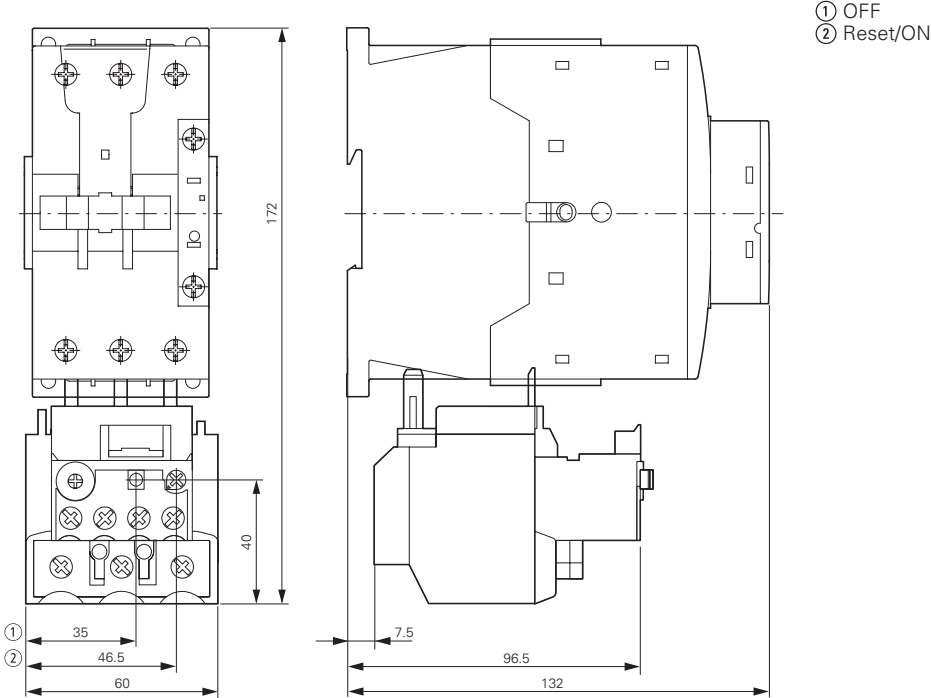

ZB150

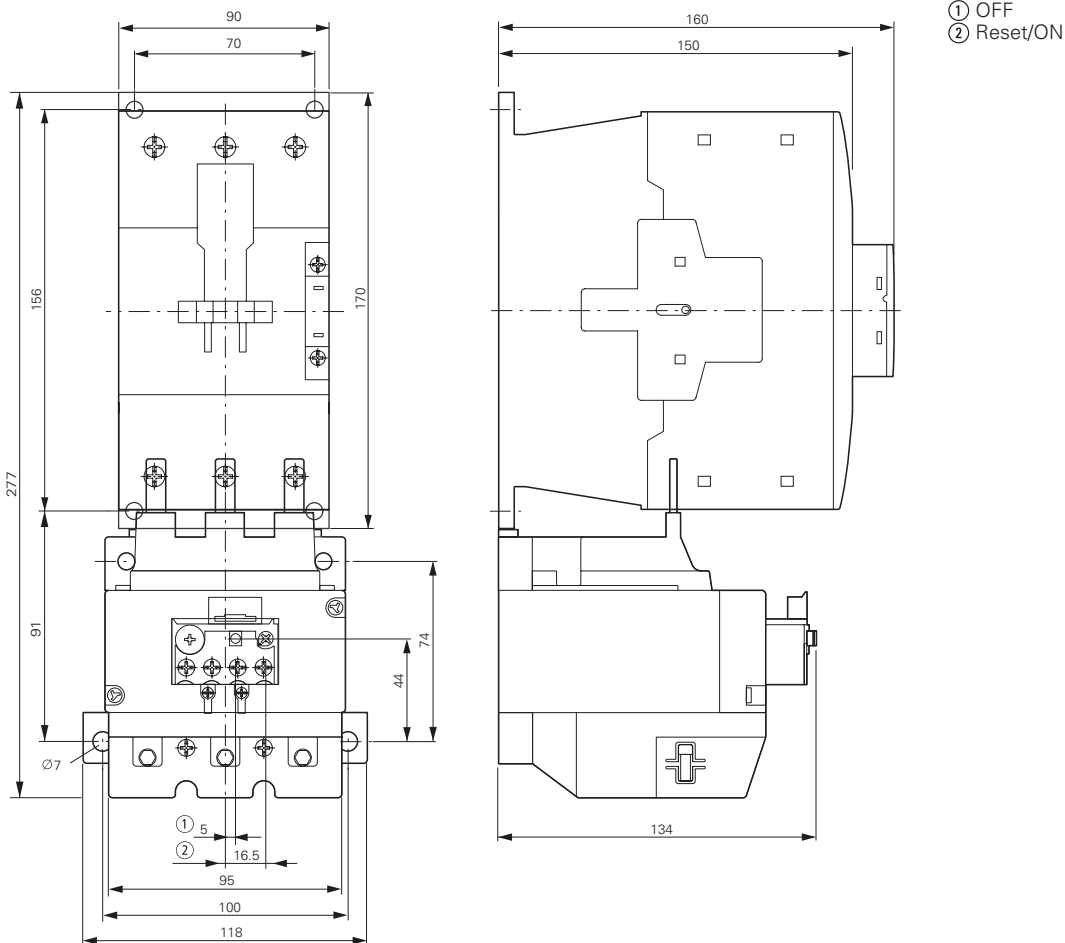



Electronic overload relays

ZEB12

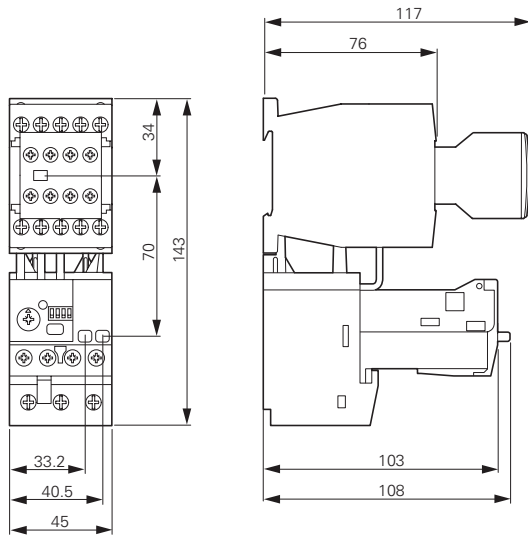

ZEB32

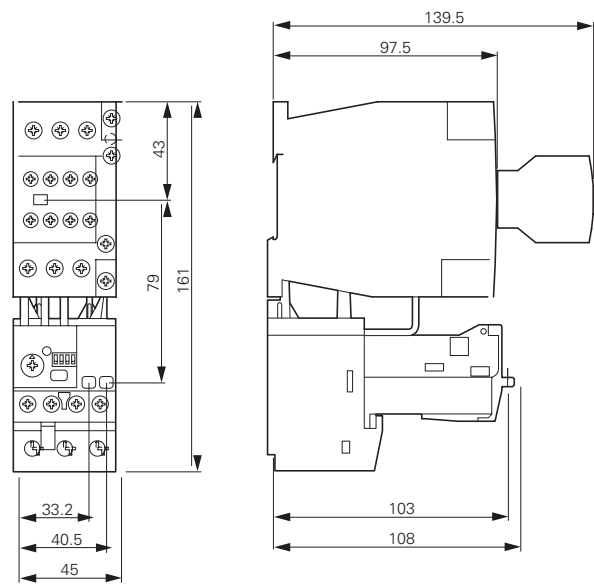

ZEB65-45

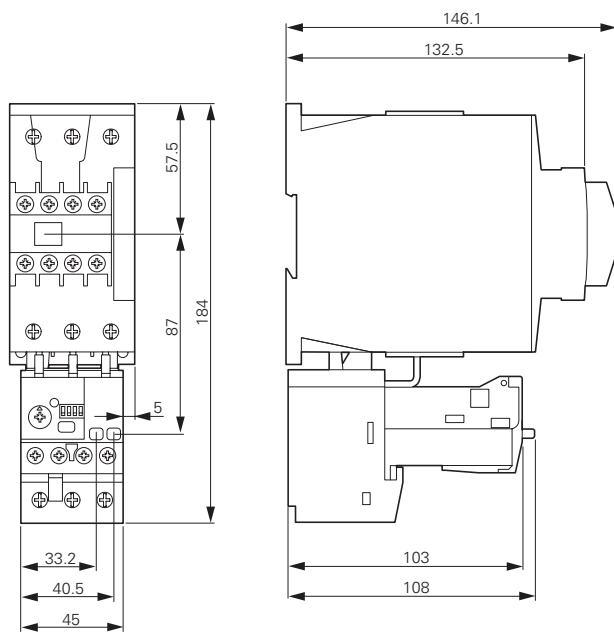

ZEB65-100

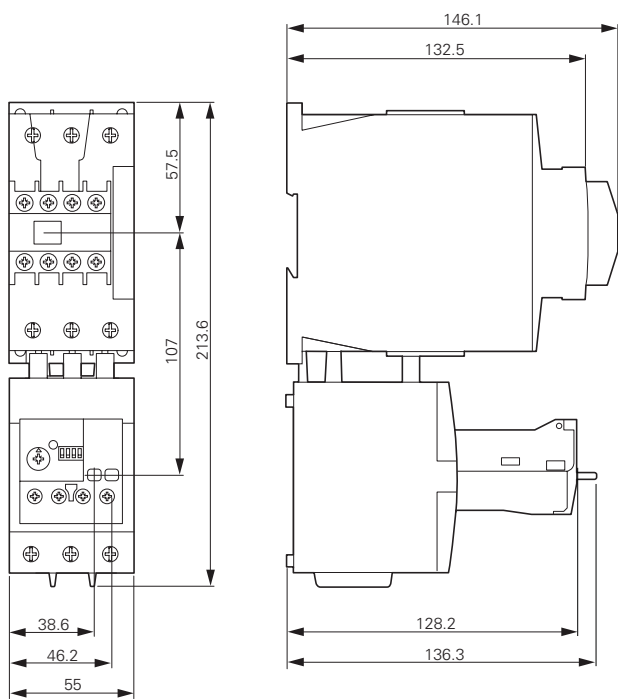

# 1.2

## Overload relays

Electronic overload relays

### 1 Electronic overload relays

ZEB150-100

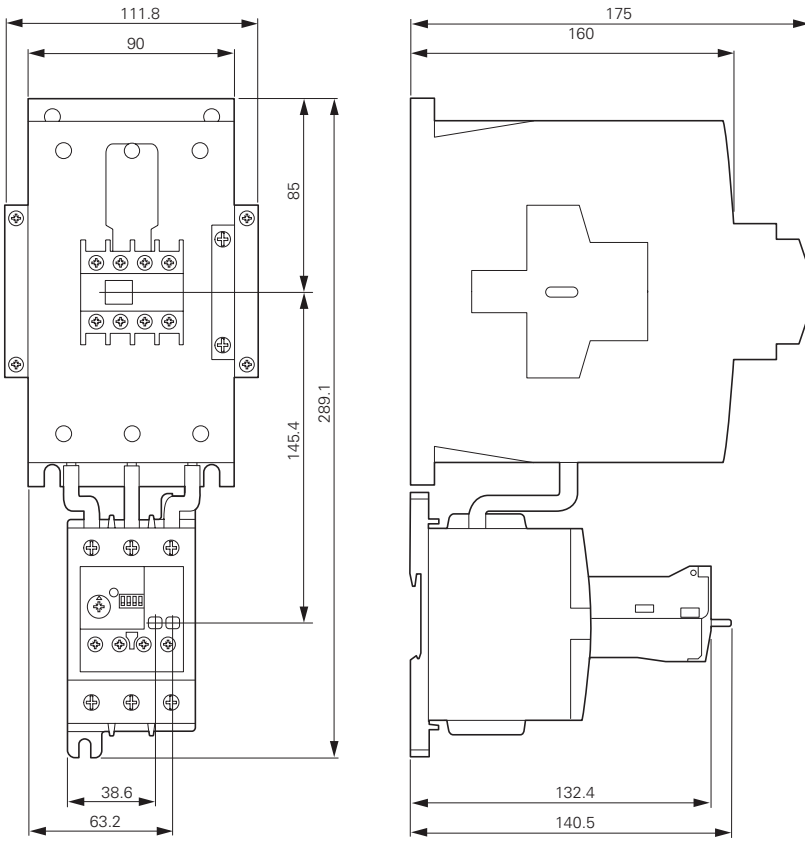

ZEB150-100/KK

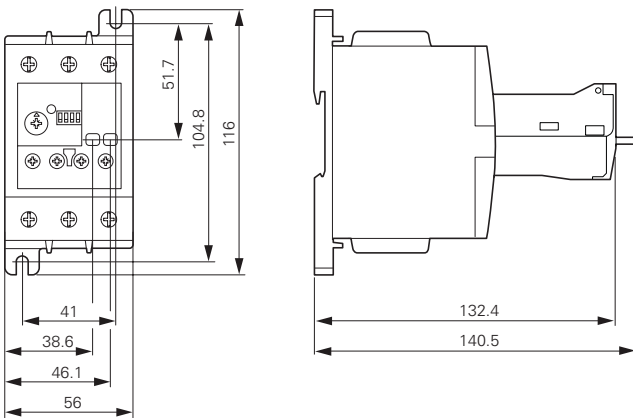

Current sensors

ZEB-XCT300

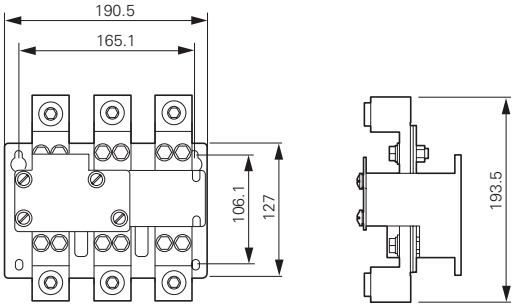

ZEB-XCT600

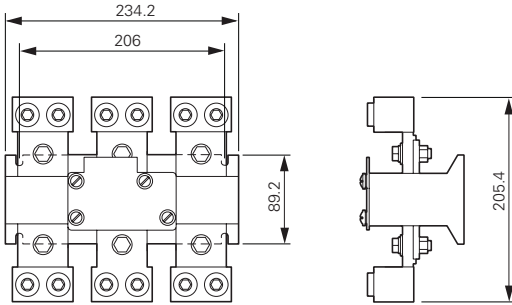

ZEB-XCT1000  
ZEB-XCT1500

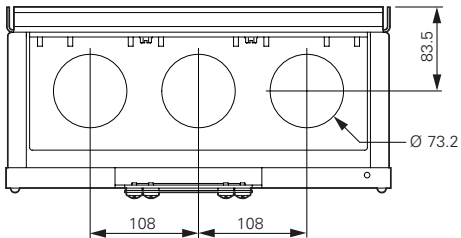
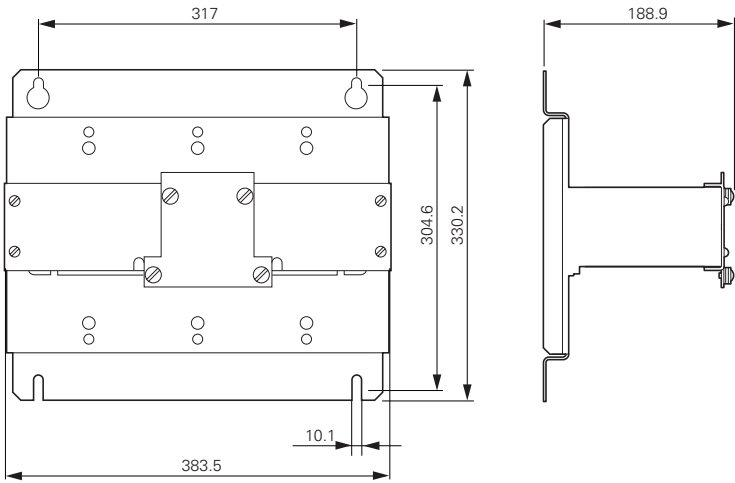

EMT6 thermistor overload relays for machine protection

EMT6...

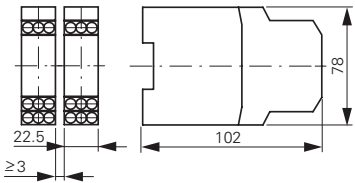

External reset button

M22-DZ-B  
M22-DZ-X

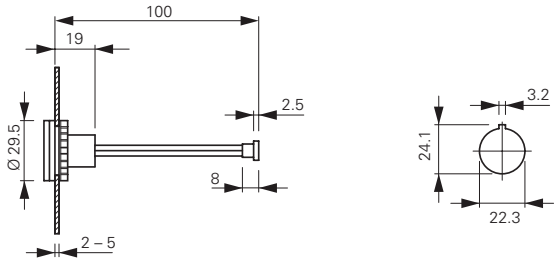

**C441 overload and monitoring relay**



**C441 overload and monitoring relay**

Features and benefits . . . . .	38
Catalog number selection . . . . .	41
Product selection . . . . .	42
Accessories . . . . .	43
Technical data and specifications . . . . .	48
Dimensions . . . . .	60

1

**C441 overload and monitoring relay**

**Product description**

Eaton’s Motor Insight, the first product in the Intelligent Power Control Solutions family, is a highly configurable motor, load and line protection device with power monitoring, diagnostics and flexible communications allowing the customer to save energy, optimize their maintenance schedules and configure greater system protection, thus reducing overall costs and downtime.

Motor Insight is available in either a line-powered or 120 Vac control powered design, capable of monitoring voltages up to 660 Vac. Each of these units is available in a 1–9 amp or a 5–90 amp FLA model. With external CTs, Motor Insight can protect motors up to 540 amps FLA. Available add-on accessories include communication modules for Modbus RTU, DeviceNet, PROFIBUS, Modbus TCP, EtherNet/IP and HTTP web services all with I/O options. For ease-of-use and operator safety, Motor Insight offers a remote display that mounts easily with two 30 mm knockouts.

# 1.2

## C441 overload and monitoring relay

### Features and benefits

#### 1 Features and Benefits

##### Features

###### Size/Range

- Broad FLA range of 1–540A
- Selectable trip class (5–30)
- Four operating voltage options
  - Line-powered from 240 Vac, 480 Vac, 600 Vac
  - Control-powered from 120 Vac

###### Motor Control

- Two output relays
  - One B300 Form C fault relay and one B300 ground fault shunt relay
  - Other relay configurations are available, including one Form A and one Form B SPST (fault and auxiliary relays) allowing programmable isolated relay behavior and unique voltages
- One external remote reset terminal
- Trip status indicator

###### Motor Protection

- Thermal overload
- Jam protection
- Current imbalance
- Current phase loss
- Ground fault
- Phase reversal

###### Load Protection

- Under current
- Low power (kW)
- High power (kW)

###### Standards and Certifications

- cULus listed NKCR, NKCR7, 508
- UL® 1053 applicable sections for ground fault detection
- CSA® certified (Class 3211-02)
- CE
- NEMA®

##### Benefits

###### Reliability and Improved Uptime

- Advanced diagnostics allows for quick and accurate identification of the root source of a motor, pump or power quality fault; reducing troubleshooting time and the loss of productivity, reducing repeat faults due to misdiagnosis, and increasing process output and profitability
- Provides superior protection of motors and pumps before catastrophic failure occurs
- Increases profitability with greater process uptime and throughput, reduced costs per repair, reduced energy consumption and extended equipment life
- Adjustments to overload configuration can be made at any time

###### Safety

- IP20 rated terminal blocks
- Terminal blocks are set back from the display to reduce operator shock hazard
- Remote display (optional) does not require that the operator open the panel to configure the device

###### Flexibility

- Communications modules
  - Offered in a variety of configurations
  - External snap-on modules provide support for multiple communications protocols
- Advanced power, voltage and current monitoring capabilities
- Communications modules and remote display can be used simultaneously
- Highly configurable fault and reset characteristics for numerous applications
- Fully programmable isolated fault and auxiliary relays

###### Ease of Use

- Bright LED display with easy-to-understand setting and references
- Powered from line voltage or 120 Vac control power
- Remote display powered from base unit
- Full word descriptions and units on user interface

- IEC EN 60947-4-1
- RoHS
- CCC





### Advanced Overload Education

Description	Definition	Source	Result	Motor Insight Protection
<b>Motor Protection</b>				
Thermal overload	Overload is a condition in which current draw to a motor exceeds 115% of the full load amperage rating over a period of time for an inductive motor.	<p>An increase in the load or torque that is being driven by the motor.</p> <p>A low voltage supply to the motor would cause the current to go high to maintain the power needed.</p> <p>A poor power factor would cause above normal current draw.</p>	Increase in current draw. Current leads to heat and insulation breakdown, which can cause system failure. Additionally, an increase in current can increase power consumption and waste valuable energy.	<p>Thermal trip behavior is defined by UL, CSA and IEC standards.</p> <p>Trip class is settable from 5–30 by 1</p> <p>Provides power factor monitoring and low voltage protection features.</p>
Jam	Jam is similar to thermal overload in that it is a current draw on the motor above normal operating conditions.	Mechanical stall, interference, jam or seizure of the motor or motor load.	The motor attempts to drive the load, which has more resistive force due to the mechanical interference. In order to drive the load, the motor draws an abnormal amount of current, which can lead to insulation breakdown and system failure.	<p>Provides a configurable Jam setting that is active during “motor run state” to avoid nuisance trips.</p> <p>Trip Threshold 150–400% of FLA.</p> <p>Trip Delay 1–20 seconds.</p>
Ground fault	A line to ground fault.	A current leakage path to ground.	An undetected ground fault can burn through multiple insulation windings, ultimately leading to motor failure.	<p>Motor Insight has ground fault protection capability down to 0.15 amps estimated from the existing three-phase CTs using the residual current method. That is, the three-phase current signals should sum to zero unless a ground fault (GF) condition is present. In the case of a GF, Motor Insight can alarm, trip the starter, or trip an alternative relay that can be used to shunt trip a breaker or light up a warning light. GF current can also be monitored in real-time through the advanced monitoring capabilities.</p> <p><b>Note:</b> GF settable thresholds vary with motor FLA. 0.15 amps may not be available in all cases.</p>
Imbalanced phases (voltage and current)	Uneven voltage or currents between phases in a three-phase system.	When a three-phase load is powered with a poor quality line, the voltage per phase may be imbalanced.	Imbalanced voltage causes large imbalanced currents and as a result this can lead to motor stator windings being overloaded, causing excessive heating, reduced motor efficiency and reduced insulation life.	Provides two protection settings that address this problem. The user can choose to set current imbalance thresholds or voltage imbalance thresholds, each of which can trip the starter. Additionally, both of these may be monitored through Motor Insight’s advanced monitoring capabilities, allowing the customer to notice in real-time when and where a condition is present.
Phase loss—current (single-phasing)	One of the three-phase current is not present.	Multiple causes, loose wire, improper wiring, grounded phase, open fuse, and so on.	Single-phasing can lead to unwanted motor vibrations in addition to the results of imbalanced phases as listed above.	Fixed protective setting that takes the starter offline if a phase drops below 60% of the other two phases.
Phase rotation (phase-reversal)	Improper wiring, leading to phases being connected to the motor improperly.	A miswired motor. Inadvertent phase-reversal by the utility.	Phase-reversal can cause unwanted directional rotation of a motor. In the event that the load attached to the motor can only be driven in one direction, the result could be significant mechanical failure and/or injury to an operator.	Configurable phase protection, allowing the user to define the phase sequencing intended for that application. If no phase sequence is required, the user has the ability to disable this feature.
Frequency variance	When line frequency is inconsistent.	Malfunctioning alternator speed regulator, or poor line quality caused by an overload of a supply powered by individual sources.	Variations in frequency can cause increases in losses, decreasing the efficiency of the motor. In addition, this can result in interference with synchronous devices.	Advanced monitoring capabilities allow the user to monitor frequency in real-time.

# 1.2

## C441 overload and monitoring relay

### Features and benefits

#### 1 Advanced Overload Education, continued

Description	Definition	Source	Result	Motor Insight Protection
<b>Load Protection</b>				
Under current or low power	Average rms current provided to the motor falls below normal operating conditions.	Under current is usually associated with a portion of the user's load disappearing. Examples of this would be a broken belt, a dry-pump (low suction head) or a dead-headed centrifugal pump.	If under current goes undetected, a mechanical failure can and has occurred. In the case of a pump, running a pump dry or running a pump in a dead-headed condition can cause excessive heating, damaging expensive seals and breaking down desired fluid properties.	Motor Insight has two protection settings to detect this: under current and low power. Low power is a more consistent way of ensuring detection as power is linear with motor load, where as current is not. An unloaded motor may draw 50% of its rated current, but the power draw will be less than 10% of rated power due to a low power factor.
High power	The motor load is drawing more power than it should at normal operating conditions.	This is typical of batch processing applications where several ingredients flow into a mixer. When a substance's consistency changes and viscosity increases from what is expected, the motor may use more power to blend the mixture. Out-of-tolerance conditions can be detected using the High Power and Low Power settings.	If a high-power fault goes undetected, the result may be a batch of material that does not meet specification.	Monitors the three-phase real power. If the real power value is estimated above the set threshold for the set length of time, a fault is detected and the overload will trip the starter. Additionally, power can be monitored in real-time.
<b>Line Protection</b>				
Over voltage	When the line voltage to the motor exceeds the specified rating.	Poor line quality.	An over voltage condition leads to a lower than rated current draw and a poor power factor. A trip limit of 110% of rated voltage is recommended. Over voltage can also lead to exceeding insulation ratings.	Monitors the maximum rms value of the three-phase voltages. If the rms value rises above the set threshold for the set length of time, a fault is detected and the overload can trip the starter or send and display an alarm of the condition. All line-related faults have an "alarm-no-trip" mode.
Under voltage	When the line voltage to the motor is below the specified rating.	Poor line quality.	An under voltage condition leads to excessive current draw. This increases the heating of the motor windings and can shorten insulation life. A trip limit set to 90% of rated voltage is recommended.	Monitors the minimum rms value of the three-phase voltages. If the rms value drops below the set threshold for the set length of time, a fault is detected and the overload can trip the starter or send and display an alarm of the condition. All line-related faults have an "alarm-no-trip" mode.
Power-up delay	Allows for starting motors and loads in a deliberate fashion.	When there is a power failure, or power cycle, multiple loads come online simultaneously.	Multiple loads starting simultaneously can cause sags affecting the operation of devices that may prevent successful startup.  If power is lost to a motor driving a pump, it may be necessary to delay a restart to allow the pump to come to a complete stop to prevent starting a motor during backspin.	Configurable to delay closing the fault relay on power-up. For each Motor Insight controlling a motor, a different setting can be programmed, helping to maintain the integrity of your line power.

Catalog Number Selection

Motor Insight Overload Relays

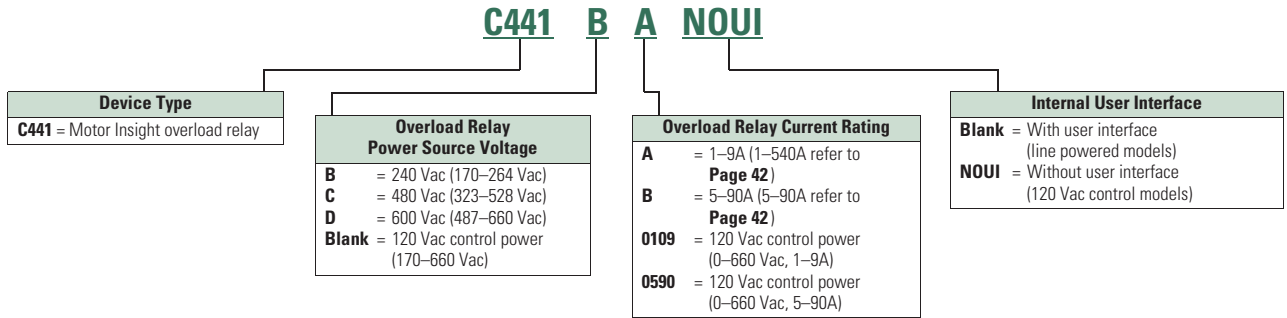

Motor Insight Overload Relays—Communications Modules and Accessory Types

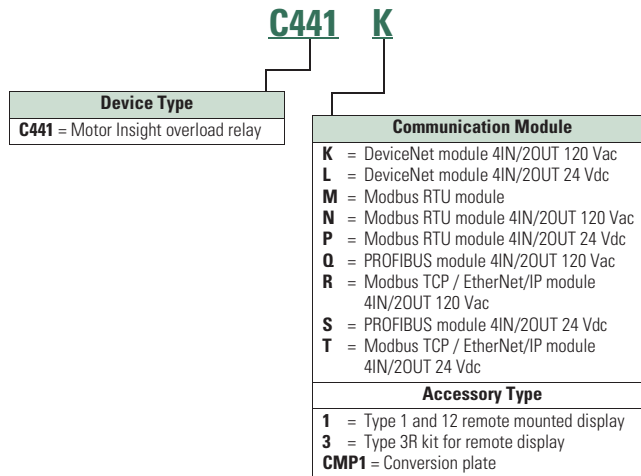

# 1.2

## C441 overload and monitoring relay

### Product selection

#### 1 Product Selection

##### Motor Insight



##### Motor Insight

Power Source	Monitoring Range	Current Range	Catalog Number
240 Vac (170–264)	170–264 Vac	1–9A	<b>C441BA</b>
		5–90A	<b>C441BB</b>
480 Vac (323–528)	323–528 Vac	1–9A	<b>C441CA</b>
		5–90A	<b>C441CB</b>
600 Vac (489–660)	489–660 Vac	1–9A	<b>C441DA</b>
		5–90A	<b>C441DB</b>
120 Vac (93.5–132)	170–660 Vac	1–9A	<b>C4410109NOUI</b>
		5–90A	<b>C4410590NOUI</b>

##### Motor Insight CT Multiplier and Wire Wrap Schedule

Catalog Number <sup>①</sup>	Motor FLA	Number of Loops	Number of Conductors Through CT Primary	CT Multiplier Setting	External CT Kit Catalog Number <sup>②</sup>
<b>Current Range: 5–90A</b>					
<b>C441_B and C4410590NOUI</b>	5–22.5A	3	4	4	—
	6.67–30A	2	3	3	—
	10–45A	1	2	2	—
	20–90A	0	1	1	—
<b>Current Range: 1–9A</b>					
<b>C441_A and C4410109NOUI</b>	1–5A	1	2	2	—
	2–9A	0	1	1	—
	60–135A	0	1	150–(150:5)	<b>C441CTKIT150</b>
	120–270A	0	1	300–(300:5)	<b>C441CTKIT300</b>
	240–540A	0	1	600–(600:5)	<b>C441CTKIT600</b>

##### Notes

<sup>①</sup> Underscore indicates Operating Voltage Code required.  
Operating Voltage Codes:

Code	Voltage
<b>B</b>	240 Vac
<b>C</b>	480 Vac
<b>D</b>	600 Vac
<b>&lt;empty&gt;</b>	120 Vac Control Power

<sup>②</sup> Any manufacturer's CTs may be used.

**Accessories**

**Modbus Communication Module**

The Motor Insight Modbus Communication Module is a side-mounted device providing Modbus communication capability to the Motor Insight overload relay.

The Modbus Communication Module with I/O provides communication, monitoring and control for the Motor Insight overload relay.

**Features and Benefits**

- The Modbus communication module is capable of baud rates up to 115K
- The Modbus address and baud rate configuration can be easily changed using the Motor Insight user interface (C441M only)
- Modbus address and baud rate are set via convenient DIP switches (C441N and C441P); LEDs are provided to display Modbus traffic
- Configuration with common Modbus configuration tools
- Terminals
  - Unique locking mechanism provides for easy removal of the terminal block with the field wiring installed
  - Each terminal is marked for ease of wiring and troubleshooting
- Selectable I/O assemblies
  - 4IN/2OUT
  - Signal types include 24 Vdc I/O and 120 Vac I/O
- Each I/O module is optically isolated between the field I/O and the network adapter to protect the I/O and communication circuits from possible damage due to transients and ground loops
- Input Module features a user-definable input debounce, which limits the effects of transients and electrical noise
- Output Module supports a user-definable safe state for loss of communication; hold last state, ON or OFF

**Modbus Communication Module**

	Description	I/O	Catalog Number
<b>Modbus Module</b>	Modbus Communication Module	None	<b>C441M</b>
<b>Modbus with I/O Module</b>	Modbus Communication Module 4IN/2OUT	120 Vac	<b>C441N</b>
	Modbus Communication Module 4IN/2OUT	24 Vdc	<b>C441P</b>



# 1.2

## C441 overload and monitoring relay

### Product selection

1

#### DeviceNet Communication Modules

The DeviceNet Communication Module provides monitoring and control for the Motor Insight overload relay from a single DeviceNet node. These modules also offer convenient I/O in two voltage options, 24 Vdc and 120 Vac.

#### Features and Benefits

- Communication to DeviceNet uses only one DeviceNet MAC ID
- Configuration
  - DeviceNet MAC ID and Baud rate are set via convenient DIP switches with an option to set from the network
  - Advanced configuration available using common DeviceNet tools
- Terminals
  - Unique locking mechanism provides for easy removal of the terminal block with the field wiring installed
  - Each terminal is marked for ease of wiring and troubleshooting
- Selectable I/O assemblies
  - 4IN/2OUT
  - Signal types include 24 Vdc I/O and 120 Vac I/O
  - Each I/O module is optically isolated between the field I/O and the network adapter to protect the I/O and communication circuits from possible damage due to transients and ground loops
- Input Module features a user-definable input debounce, which limits the effects of transients and electrical noise
- Output Module supports a user-definable safe state for loss of communication; hold last state, ON or OFF
- Combined status LED

#### DeviceNet Module



#### DeviceNet Modules

Description	I/O	Catalog Number
DeviceNet Communication Module	120 Vac	<b>C441K</b>
DeviceNet Communication Module	24 Vdc	<b>C441L</b>

### PROFIBUS Communication Module

The Motor Insight PROFIBUS Communication Module is a side-mounted device providing PROFIBUS communication capability to the Motor Insight overload relay.

The PROFIBUS Communication Module with I/O provides communication, monitoring and control for the Motor Insight overload relay.

#### Features and Benefits

- The PROFIBUS communication module is capable of baud rates up to 12 Mb
- PROFIBUS address is set via convenient DIP switches (C441Q and C441S); LEDs are provided to display PROFIBUS status
- Intuitive configuration with common PROFIBUS configuration tools
- Terminals
  - Unique locking mechanism provides for easy removal of the terminal block with the field wiring installed
  - Each terminal is marked for ease of wiring and troubleshooting
- Selectable I/O assemblies
  - 4IN/2OUT
  - Signal types include 24 Vdc I/O and 120 Vac I/O
- Each I/O module is optically isolated between the field I/O and the network adapter to protect the I/O and communication circuits from possible damage due to transients and ground loops
- Input Module features a user-definable input debounce, which limits the effects of transients and electrical noise
- Output Module supports a user-definable safe state for loss of communication; hold last state, ON or OFF

### PROFIBUS with I/O Module



### PROFIBUS Communication Module

Description	I/O	Catalog Number
PROFIBUS Communication Module 4IN/2OUT	120 Vac	<b>C441S</b>
PROFIBUS Communication Module 4IN/2OUT	24 Vdc	<b>C441Q</b>

# 1.2 C441 overload and monitoring relay

## Accessories

### 1 Ethernet Communication Module

The Motor Insight Ethernet Communication Module is a side-mounted device providing both Modbus TCP and EtherNet/IP communication capabilities with built-in HTTP web services to the Motor Insight overload relay.

The Ethernet Communication Module with I/O provides communication, monitoring and control for the Motor Insight overload relay.

#### Features and Benefits

- Supports Modbus TCP or EtherNet/IP in a single device
- Contains internal embedded switch which provides two Ethernet ports allowing linear or ring network configurations
- Embedded web services allow for simple configuration and monitoring through Internet Explorer
- IP Address is set via convenient DIP Switches located on the device
- Terminals
  - Unique locking mechanism provides for easy removal of the terminal block with the field wiring installed
  - Each terminal is marked for ease of wiring and troubleshooting
- Selectable I/O assemblies
  - 4IN/2OUT
  - Signal types include 24 Vdc I/O and 120 Vac I/O
- Each I/O module is optically isolated between the field I/O and the network adapter to protect the I/O and communication circuits from possible damage due to transients and ground loops
- Input Module features a user-definable input debounce, which limits the effects of transients and electrical noise
- Output Module supports a user-definable safe state for loss of communication; hold last state, ON or OFF

Ethernet with I/O Module



### Ethernet Communication Module

Description	I/O	Catalog Number
Modbus TCP / EtherNet/IP Communication Module 4IN/2OUT	120 Vac	<b>C441R</b>
Modbus TCP / EtherNet/IP Communication Module 4IN/2OUT	24 Vdc	<b>C441T</b>



### Type 3R Kit with Remote Display Mounted Inside



Motor Insight offers several accessories for the customer's ease of use and safety:

- Types 1 and 12 remote display
- Type 3R remote display kit
- Mounting plate adapter

### Features and Benefits

- Remote display unit:
  - Same user interface as the overload relay
  - Enhanced operator safety—operator can configure the overload without opening the enclosure door
- Type 3R kit mounts with standard 30 mm holes
- Mounting plate for retrofit in existing installations

### Type 3R Kit with Remote Display Mounted Inside

	Description	Catalog Number
	C4411 Remote display Types 1 and 12 (UL 508)	C4411
	C4413 Type 3R kit for remote display (UL 508) Conversion plate (not shown)	C4413 C441CMP1

### Communication Cables

The Remote Display requires a communication cable to connect to the Motor Insight overload relay:

### Communication Cable Lengths

Length in Inches (meters)	Catalog Number
9.8 (0.25)	D77E-QPIP25
39.4 (1.0)	D77E-QPIP100
78.7 (2.0)	D77E-QPIP200
118.1 (3.0)	D77E-QPIP300

### Current Transformer Kits

Description	Catalog Number
Three 150:5 CTs to be used with Motor Insight	C441CTKIT150
Three 300:5 CTs to be used with Motor Insight	C441CTKIT300
Three 600:5 CTs to be used with Motor Insight	C441CTKIT600

#### 1 Technical Data and Specifications

##### Motor Insight

Description	Specification C441B_	C441C_	C441D_	C441_ _ _ _NOUI		
<b>Electrical Ratings</b>						
<b>Feature</b>	<b>Range</b>					
Operating voltage (three-phase) and frequency	170–264 Vac 50/60 Hz	323–528 Vac 50/60 Hz	489–660 Vac 50/60 Hz	170–660 Vac 50/60 Hz		
<b>Trip Class</b>						
5–30	Selectable	Selectable	Selectable	Selectable		
<b>FLA Range</b>						
C441_A and C4410109NOUI	1–9A	Up to 540A with external CTs Refer to <b>Page 42</b> for CT multiplier and wire wrap schedule.	Up to 540A with external CTs Refer to <b>Page 42</b> for CT multiplier and wire wrap schedule.	Up to 540A with external CTs Refer to <b>Page 42</b> for CT multiplier and wire wrap schedule.		
C441_B and C4410590NOUI	5–90A					
<b>Monitoring Capabilities</b>						
<b>Feature</b>	<b>Value</b>					
Current	Per phase rms (1A, 1B, 1C), 2% accuracy Average rms, 2% accuracy Imbalance percent (0–100%) Ground fault current, 10% accuracy	Per phase rms (1A, 1B, 1C), 2% accuracy Average rms, 2% accuracy Imbalance percent (0–100%) Ground fault current, 10% accuracy	Per phase rms (1A, 1B, 1C), 2% accuracy Average rms, 2% accuracy Imbalance percent (0–100%) Ground fault current, 10% accuracy	Per phase rms (1A, 1B, 1C), 2% accuracy Average rms, 2% accuracy Imbalance percent (0–100%) Ground fault current, 10% accuracy	Per phase rms (1A, 1B, 1C), 2% accuracy Average rms, 2% accuracy Imbalance percent (0–100%) Ground fault current, 10% accuracy	
Voltage	Per phase rms (1A, 1B, 1C), 2% accuracy Average rms, 2% accuracy Imbalance percent (0–100%)	Per phase rms (1A, 1B, 1C), 2% accuracy Average rms, 2% accuracy Imbalance percent (0–100%)	Per phase rms (1A, 1B, 1C), 2% accuracy Average rms, 2% accuracy Imbalance percent (0–100%)	Per phase rms (1A, 1B, 1C), 2% accuracy Average rms, 2% accuracy Imbalance percent (0–100%)	Per phase rms (1A, 1B, 1C), 2% accuracy Average rms, 2% accuracy Imbalance percent (0–100%)	
Power	Motor kW, 5% accuracy Motor power factor, inductive 0–1.0, 1% accuracy	Motor kW, 5% accuracy Motor power factor, inductive 0–1.0, 1% accuracy	Motor kW, 5% accuracy Motor power factor, inductive 0–1.0, 1% accuracy	Motor kW, 5% accuracy Motor power factor, inductive 0–1.0, 1% accuracy	Motor kW, 5% accuracy Motor power factor, inductive 0–1.0, 1% accuracy	
Thermal capacity	0% cold, 100% trip	0% cold, 100% trip	0% cold, 100% trip	0% cold, 100% trip	0% cold, 100% trip	
Motor run hours	0–65,535 hours	0–65,535 hours	0–65,535 hours	0–65,535 hours	0–65,535 hours	
Frequency	47–63 Hz, 1% accuracy	47–63 Hz, 1% accuracy	47–63 Hz, 1% accuracy	47–63 Hz, 1% accuracy	47–63 Hz, 1% accuracy	
<b>Motor Protection</b>						
Thermal overload setting	1.05 x FLA: Does not trip 1.15 x FLA: Overload trip	1.05 x FLA: Does not trip 1.15 x FLA: Overload trip	1.05 x FLA: Does not trip 1.15 x FLA: Overload trip	1.05 x FLA: Does not trip 1.15 x FLA: Overload trip	1.05 x FLA: Does not trip 1.15 x FLA: Overload trip	
<b>Feature</b>	<b>Range</b>				<b>Fault Delay Setting</b>	
Jam	150–400% of motor FLA, OFF	150–400% of motor FLA, OFF	150–400% of motor FLA, OFF	50–400% of motor FLA, OFF	1–20 seconds	
Current imbalance	1–30%, OFF	1–30%, OFF	1–30%, OFF	1–30%, OFF	1–20 seconds	
Current phase loss	Fixed threshold 60%	Fixed threshold 60%	Fixed threshold 60%	Fixed threshold 60%	1–20 seconds	
<b>Ground fault current</b>						
C441_A and C4410109NOUI 1–9A	0.3–2.0A with one pass through the CTs <sup>①</sup>	0.3–2.0A with one pass through the CTs <sup>①</sup>	0.3–2.0A with one pass through the CTs <sup>①</sup>	0.3–2.0A with one pass through the CTs <sup>①</sup>	<150%, 1–60 seconds >150%, 2 seconds >250%, 1 second	
C441_B and C4410590NOUI 5–90A	3.0–20A with one pass through the CTs <sup>①</sup>	3.0–20A with one pass through the CTs <sup>①</sup>	3.0–20A with one pass through the CTs <sup>①</sup>	3.0–20A with one pass through the CTs <sup>①</sup>	<150%, 1–60 seconds >150%, 2 seconds >250%, 1 second	
Phase reversal	OFF = Ignore, 1 = ACB, 2 = ABC	OFF = Ignore, 1 = ACB, 2 = ABC	OFF = Ignore, 1 = ACB, 2 = ABC	OFF = Ignore, 1 = ACB, 2 = ABC		
Fault reset delay	2–500 minutes, auto <sup>②</sup>	2–500 minutes, auto <sup>②</sup>	2–500 minutes, auto <sup>②</sup>	2–500 minutes, auto <sup>②</sup>		
Fault reset attempts	0–4 restarts allowed or automatic reset <sup>②</sup>	0–4 restarts allowed or automatic reset <sup>②</sup>	0–4 restarts allowed or automatic reset <sup>②</sup>	0–4 restarts allowed or automatic reset <sup>②</sup>		

##### Notes

<sup>①</sup> Lower levels are achievable with multiple passes.

<sup>②</sup> Motor fault reset characteristics can be programmed as a group or for motor overloads only. Reference the user manual for more detailed information.

**Motor Insight, continued**

Description	Specification C441B_	C441C_	C441D_	C441_ _ _ _NOUI	
<b>Load Protection</b>					
<b>Feature</b>	<b>Range</b>				<b>Fault Delay Setting</b>
Under current	50–90% of motor FLA	50–90% of motor FLA	50–90% of motor FLA	50–90% of motor FLA	1–60 seconds
Low power (kW)	20–80% of rated kW	20–80% of rated kW	20–80% of rated kW	20–80% of rated kW	1–60 seconds
High power (kW)	50–110% of rated kW	50–110% of rated kW	50–110% of rated kW	50–110% of rated kW	1–60 seconds
Load reset delay	2–500 minutes, auto	2–500 minutes, auto	2–500 minutes, auto	2–500 minutes, auto	
Load reset attempts	0–4, auto	0–4, auto	0–4, auto	0–4, auto	
<b>Supply Protection</b>					
<b>Feature</b>	<b>Range</b>				<b>Fault Delay Setting</b>
Over voltage	170–264 Vac	323–528 Vac	489–660 Vac	0–660 Vac	1–20 seconds
Under voltage	170–264 Vac	323–528 Vac	489–660 Vac	0–660 Vac	1–20 seconds
Voltage imbalance	1–20% imbalance	1–20% imbalance	1–20% imbalance	1–20% imbalance	1–20% imbalance
Restart delay setting	1–500 seconds	1–500 seconds	1–500 seconds	1–500 seconds	1–500 seconds
<b>Electrical/EMC</b>					
Radiated emissions IEC 60947-4-1—Table 15, EN 55011 (CISPR 11) Group 1, Class A	30–1000 mHz	30–1000 mHz	30–1000 mHz	30–1000 mHz	30–1000 mHz
Conducted emissions IEC 60947-4-1—Table 14, EN 55011 (CISPR 11) Group 1, Class A	0.15–30 mHz	0.15–30 mHz	0.15–30 mHz	0.15–30 mHz	0.15–30 mHz
ESD immunity IEC 60947-4-1 (Table 13)	±8 kV air, ±4 kV contact	±8 kV air, ±4 kV contact	±8 kV air, ±4 kV contact	±8 kV air, ±4 kV contact	±8 kV air, ±4 kV contact
Radiated immunity IEC 60947-4-1	10 V/m 80–1000 mHz 80% amplitude modulated 1 kHz sine wave	10 V/m 80–1000 mHz 80% amplitude modulated 1 kHz sine wave	10 V/m 80–1000 mHz 80% amplitude modulated 1 kHz sine wave	10 V/m 80–1000 mHz 80% amplitude modulated 1 kHz sine wave	10 V/m 80–1000 mHz 80% amplitude modulated 1 kHz sine wave
Conducted immunity IEC 60947-4-1	140 dBuV (10V rms) 150 kHz–80 mHz	140 dBuV (10V rms) 150 kHz–80 mHz	140 dBuV (10V rms) 150 kHz–80 mHz	140 dBuV (10V rms) 150 kHz–80 mHz	140 dBuV (10V rms) 150 kHz–80 mHz
Fast transient immunity IEC 60947-4-1 (Table 13) IEC 61000-4-4	±2 kV using direct method	±2 kV using direct method	±2 kV using direct method	±2 kV using direct method	±2 kV using direct method
Surge immunity IEC 60947-4-1 (Table 13) IEC 61000-4-4	Three-phase power inputs: ±2 kV line-to-line (DM) ±4 kV line-to-ground (CM)  IEC 61000-4-5 Class 3 User IO and communication lines: ±1 kV line-to-line (DM) ±2 kV line-to-ground (CM)	Three-phase power inputs: ±2 kV line-to-line (DM) ±4 kV line-to-ground (CM)  IEC 61000-4-5 Class 3 User IO and communication lines: ±1 kV line-to-line (DM) ±2 kV line-to-ground (CM)	Three-phase power inputs: ±2 kV line-to-line (DM) ±4 kV line-to-ground (CM)  IEC 61000-4-5 Class 3 User IO and communication lines: ±1 kV line-to-line (DM) ±2 kV line-to-ground (CM)	Three-phase power inputs: ±2 kV line-to-line (DM) ±4 kV line-to-ground (CM)  IEC 61000-4-5 Class 3 User IO and communication lines: ±1 kV line-to-line (DM) ±2 kV line-to-ground (CM)	Three-phase power inputs: ±2 kV line-to-line (DM) ±4 kV line-to-ground (CM)  IEC 61000-4-5 Class 3 User IO and communication lines: ±1 kV line-to-line (DM) ±2 kV line-to-ground (CM)
Voltage variations immunity IEC 60947-4-1	30% dip, at 100 ms 60% dip at 10 ms >95% interrupt at 5 ms	30% dip, at 100 ms 60% dip at 10 ms >95% interrupt at 5 ms	30% dip, at 100 ms 60% dip at 10 ms >95% interrupt at 5 ms	30% dip, at 100 ms 60% dip at 10 ms >95% interrupt at 5 ms	30% dip, at 100 ms 60% dip at 10 ms >95% interrupt at 5 ms
Electromagnetic field IEC 60947-4-1 (Table 13) IEC 61000-4-3	10 V/m	10 V/m	10 V/m	10 V/m	10 V/m
Ground fault	UL 508, UL 1053 Sections 21 and 27	UL 508, UL 1053 Sections 21 and 27	UL 508, UL 1053 Sections 21 and 27	UL 508, UL 1053 Sections 21 and 27	UL 508, UL 1053 Sections 21 and 27

# 1.2

## C441 overload and monitoring relay

Technical data and specifications

### 1 Motor Insight, continued

Description	Specification C441B_	C441C_	C441D_	C441_ _ _ NOUI
<b>Environmental Ratings</b>				
<b>Feature</b>	<b>Range</b>			
Ambient temperature (operating)	−4° to 122°F (−20° to 50°C)	−4° to 122°F (−20° to 50°C)	−4° to 122°F (−20° to 50°C)	−4° to 122°F (−20° to 50°C)
Ambient temperature (storage)	−40° to 85°C	−40° to 85°C	−40° to 85°C	−40° to 85°C
Operating humidity	5% to 95% noncondensing	5% to 95% noncondensing	5% to 95% noncondensing	5% to 95% noncondensing
Altitude (no derating)	2000m	2000m	2000m	2000m
Shock (IEC 60068-2-27)	15G any direction	15G any direction	15G any direction	15G any direction
Vibration (IEC 60068-2-6)	3G any direction	3G any direction	3G any direction	3G any direction
Pollution degree per IEC 60947-1	3	3	3	3
Ingress protection	IP20	IP20	IP20	IP20
<b>Capacity</b>				
Input, auxiliary contact and external reset terminals				
Terminal capacity	18–12 AWG	18–12 AWG	18–12 AWG	18–12 AWG
Tightening torque	5.3 lb-in (0.6 Nm)	5.3 lb-in (0.6 Nm)	5.3 lb-in (0.6 Nm)	5.3 lb-in (0.6 Nm)
<b>Voltages</b>				
Monitoring voltage	170–264 Vac 50/60Hz	323–528 Vac 50/60Hz	489–660 Vac 60Hz	0–660 Vac 50/60Hz
Insulation voltage $U_i$ (three-phase voltage)	600 Vac	600 Vac	600 Vac	600 Vac
Insulation voltage $U_i$ (control)	240 Vac	240 Vac	240 Vac	240 Vac
Impulse withstand $U_{imp}$ (main/control)	6 kV	6 kV	6 kV	6 kV
<b>Expected Life</b>				
Mechanical/electrical	10 years	10 years	10 years	10 years
<b>Output Contact Ratings</b>				
Two output relays One Form C SPDT (fault relay) One Form A SPST (ground fault relay)	B300 pilot duty 5A thermal continuous current 30A make 3.00A break at 120 Vac and 15A make 1.50A break at 240 Vac	B300 pilot duty 5A thermal continuous current 30A make 3.00A break at 120 Vac and 15A make 1.50A break at 240 Vac	B300 pilot duty 5A thermal continuous current 30A make 3.00A break at 120 Vac and 15A make 1.50A break at 240 Vac	B300 pilot duty 5A thermal continuous current 30A make 3.00A break at 120 Vac and 30A make 1.50A break at 240 Vac <sup>①</sup>
C441_ _ _ NOUI models: One Form A SPST One Form B SPST				
External remote reset terminal	Isolated 120 Vac digital input IEC 61131-2 Section 5 Type 1	Isolated 120 Vac digital input IEC 61131-2 Section 5 Type 1	Isolated 120 Vac digital input IEC 61131-2 Section 5 Type 1	Isolated 120 Vac digital input IEC 61131-2 Section 5 Type 1
<b>Indications</b>				
Trip	Fault	Fault	Fault	Fault
Reset	Ready	Ready	Ready	Ready
Autoreset	Trip faulted/Ready flashing	Trip faulted/Ready flashing	Trip faulted/Ready flashing	Trip faulted/Ready flashing
<b>Power Consumption</b>				
Maximum	5W	5W	5W	5W
<b>Options</b>				
Remote display	Type 1, 12 and Type 3R kit	Type 1, 12 and Type 3R kit	Type 1, 12 and Type 3R kit	Type 1, 12 and Type 3R kit
Communications modules	Modbus, DeviceNet and PROFIBUS with I/O	Modbus, DeviceNet and PROFIBUS with I/O	Modbus, DeviceNet and PROFIBUS with I/O	Modbus, DeviceNet and PROFIBUS with I/O

#### Note

① In this model, there are two isolated relays: one Form A and one Form B SPST. One is the fault relay, and one is a programmable auxiliary relay.

## Motor Insight Short Circuit Ratings (North America CSA and UL)

1

Overload FLA Range	Maximum Operating Voltage	Standard-Fault Short Circuit Data			Maximum Thermal-Magnetic Circuit Breaker	Maximum Withstand Rating	Maximum Fuse (RK5)	Eaton Thermal-Magnetic Circuit Breaker	Catalog Number
		Withstand Rating	Maximum Fuse (RK5)	Maximum Thermal-Magnetic Circuit Breaker					
1-9A	264 Vac	5000A at 240 Vac	35A	35A	100 kA at 240 Vac	35A	—	C441BA	
					100 kA at 240 Vac	—	FDC3035L		
1-9A	528 Vac	5000A at 480 Vac	35A	35A	100 kA at 480 Vac	35A	—	C441CA	
					100 kA at 480 Vac	—	FDC3035L		
1-9A	660 Vac	5000A at 600 Vac	35A	35A	100 kA at 600 Vac	35A	—	C441DA	
					35 kA at 600 Vac	—	FDC3035L		
1-9A	660 Vac	5000A at 600 Vac	35A	35A	100 kA at 240 Vac	35A	—	C4410109NOUI	
					100 kA at 240 Vac	—	FDC3035L		
					100 kA at 480 Vac	35A	—		
					100 kA at 480 Vac	—	FDC3035L		
					100 kA at 600 Vac	35A	—		
35 kA at 600 Vac	—	FDC3035L							
5-90A	264 Vac	10,000A at 240 Vac	350A	350A	100 kA at 240 Vac	350A	—	C441BB	
					100 kA at 240 Vac	—	KDC3350		
5-90A	528 Vac	10,000A at 480 Vac	350A	350A	100 kA at 480 Vac	350A	—	C441CB	
					100 kA at 480 Vac	—	KDC3350		
5-90A	660 Vac	10,000A at 600 Vac	350A	350A	100 kA at 600 Vac	350A	—	C441DB	
					65 kA at 600 Vac	—	KDC3350		
5-90A	660 Vac	10,000A at 600 Vac	350A	350A	100 kA at 240 Vac	350A	—	C4410590NOUI	
					100 kA at 240 Vac	—	KDC3350		
					100 kA at 480 Vac	350A	—		
					100 kA at 480 Vac	—	KDC3350		
					100 kA at 600 Vac	350A	—		
35 kA at 600 Vac	—	KDC3350							

# 1.2 C441 overload and monitoring relay

## Technical data and specifications

### 1 Line Powered Models

#### Terminal Connection Diagram

Use 75C CU wire only

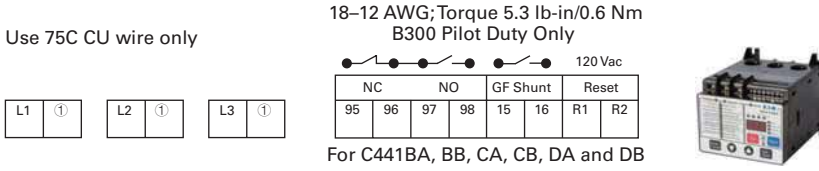

#### Terminal Connection Specifications

Name	Designation	Input	Description
Line voltage	L1, L2, L3	Line voltage	Three-phase line voltage input L1, L2, L3 connections must correspond to the respective CT1, CT2, CT3 current leads
Fault relay	95/96 96/97 (common) 97/98	B300 UL 508	Form C contact: 95/96 Contact opens when the unit is faulted or unpowered 97/98 Contact closes when the unit is faulted or unpowered
GF shunt	15 16	B300 UL 508	Form A contact: Contact closes when a ground fault is active
Reset input	R1, R2	120 Vac	Fault reset input IEC 61131-2 Type 1

### Control Powered Models

#### Terminal Connection Diagram

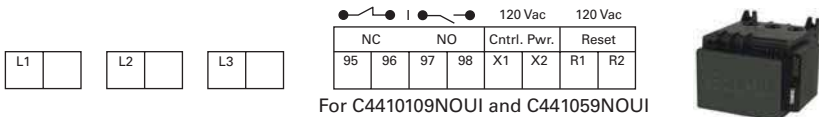

#### Terminal Connection Specifications

Name	Designation	Input	Description
Line voltage	L1, L2, L3	Line voltage	Three-phase line voltage input L1, L2, L3 connections must correspond to the respective CT1, CT2, CT3 current leads Terminal provided for wiring control power transformer (9A maximum capacity)
Control power	X1, X2	110–120 Vac 50–60Hz (+10/–15%)	Control power option for C441____NOUI
Fault relay	95/96 For C441____NOUI, the fault relay and auxiliary relay are isolated and do not share a common. By default they will behave like a Form C, but they can be programmed to act independently from one another. 96/97 (isolated) 97/98	B300 UL 508	Form C contact: 95/96 Contact opens when the unit is faulted or unpowered 97/98 Contact closes when the unit is faulted or unpowered Can be programmed to act independently of the 95/96 only in the C441____NOUI models
GF shunt	97/98	B300 UL 508	Form A contact: Contact closes when a ground fault is active Separate GF control can still be achieved by programming auxiliary relay 97/98 to act independently of the 95/96 relay
Reset input	R1, R2	120 Vac	Fault reset input IEC 61131-2 Type 1

#### Note

① No motor loads, 9A maximum.

## Modbus Communication Modules

Description	Specification	
<b>Electrical/EMC</b>		
Radiated emissions IEC 60947-4-1—Table 15, EN 55011 (CISPIR 11) Group 1, Class A	30–1000 mHz	
Conducted emissions IEC 60947-4-1—Table 14, EN 55011 (CISPIR 11) Group 1, Class A	0.15–30 mHz	
ESD immunity IEC 60947-4-1 (Table 13) IEC 61000-4-2	±8 kV air, ±4 kV contact	
Radiated immunity IEC 60947-4-1	10 V/m 80–1000 mHz 80% amplitude modulated 1 kHz sine wave	
Conducted immunity IEC 60947-4-1	140 dBuV (10V rms) 150 kHz–80 mHz	
Fast transient immunity IEC 60947-4-1 (Table 13) IEC 61000-4-4	±2 kV using direct method	
Surge immunity IEC 60947-4-1 (Table 13) IEC 61000-4-5 Class 3	User IO and communication lines <sup>①</sup> : ±1 kV line-to-line (DM) ±2 kV line-to-ground (CM)	
Electromagnetic field <sup>1</sup> IEC 60947-4-1 (Table 13) IEC 61000-4-3	10 V/m	
<b>Environmental Ratings</b>		
Ambient temperature (operating)	–20° to 50°C	
Ambient temperature (storage)	–40° to 85°C	
Operating humidity	5 to 95% noncondensing	
Altitude (no derating)	2000m	
Shock (IEC 60068-2-27)	15G any direction	
Vibration (IEC 60068-2-6)	3G any direction	
Pollution degree per IEC 60947-1	3	
Degree of protection	IP20	
Over voltage category per UL 508	III	
<b>C441P 24 Vdc Input</b>		
Nominal input voltage	24 Vdc	
Operating voltage	18–30 Vdc	
Number of inputs	4	
Signal delay	5 ms (programmable to 65 sec)	
OFF-state voltage	< 6 Vdc	
ON-state voltage	> 18 Vdc	
Nominal input current	5 mA	
Isolation	1500V	
Terminal screw torque	7–9 in-lb	
24 Vdc source current	50 mA	
<b>Operating Voltage Range—DC Input Modules</b>		
<b>OFF State</b>	<b>Transition Region</b>	<b>ON State</b>
0–6 Vdc	6–18 Vdc	18–30 Vdc
<b>C441N 120 Vac Input</b>		
Nominal input voltage	120 Vac	
Operating voltage	80–140 Vac	
Number of inputs	4	
OFF-state voltage	< 30 Vac	
ON-state voltage	> 80 Vac	
Nominal input current	15 mA	
Signal delay	1/2 cycle	
Isolation	1500V	
Terminal screw torque	7–9 in-lb	

**Note**

<sup>①</sup> Relates to C441M only.

# 1.2

## C441 overload and monitoring relay

Technical data and specifications

1

### Modbus Communication Modules, continued

Description	Specification
<b>Operating Voltage Range— AC Input Modules</b>	
<b>OFF State</b>	<b>Transition Region</b> <b>ON State</b>
0–30 Vac	30–80 Vac                                      80–140 Vac
<b>Output Modules</b>	
Nominal voltage	120 Vac 24 Vdc
Number of outputs	(2) 1NO Form A 1NO/NC Form C
Relay OFF time	3 ms
Relay ON time	7 ms
Max. current per point <sup>①</sup>	5A (B300 rated)
Electrical life	100,000 cycles
Mechanical life	1,000,000 cycles

### DeviceNet Communication Modules

Description	Specification
<b>Electrical/EMC</b>	
Radiated emissions IEC 60947-4-1—Table 15, EN 55011 (CISPIR 11) Group 1, Class A	30–1000 mHz
Conducted emissions IEC 60947-4-1—Table 14, EN 55011 (CISPIR 11) Group 1, Class A	0.15–30 mHz
ESD immunity IEC 60947-4-1 (Table 13) IEC 61000-4-2	±8 kV air, ±4 kV contact
Radiated immunity IEC 60947-4-1	10 V/m 80–1000 mHz 80% amplitude modulated 1 kHz sine wave
Conducted immunity IEC 60947-4-1	140 dBuV (10V rms) 150 kHz–80 mHz
Fast transient immunity IEC 60947-4-1 (Table 13) IEC 61000-4-4	±2 kV using direct method
Surge immunity IEC 60947-4-1 (Table 13) IEC 61000-4-5 Class 2	User I/O and communication lines: ±1 kV line-to-line (DM) ±2 kV line-to-ground (CM)
Electromagnetic field IEC 60947-4-1 Table 13, IEC 61000-4-3	10 V/m
<b>Environmental Ratings</b>	
Ambient temperature (operating)	–20° to 50°C
Ambient temperature (storage)	–40° to 85°C
Operating humidity	5–95% noncondensing
Altitude (no derating)	2000m
Shock (IEC 60068-2-27)	15G any direction
Vibration (IEC 60068-2-6)	3G any direction
Pollution degree per IEC 60947-1	3
Degree of protection	IP20
<b>DeviceNet</b>	
DeviceNet connections	Group 2, polling, bit strobe, explicit, no UCMM
DeviceNet baud rate	125K, 250K, 500K

**Note**

<sup>①</sup> Resistive current at 55°C ambient.



## DeviceNet Communication Modules, continued

Description	Specification	
<b>C441L 24 Vdc Input</b>		
Nominal input voltage	24 Vdc	
Operating voltage	18–30 Vdc	
Number of inputs	4	
Signal delay	5 ms (programmable to 65 sec)	
OFF-state voltage	< 6 Vdc	
ON-state voltage	> 18 Vdc	
Nominal input current	5 mA	
Isolation	250V	
Terminal screw torque	7–9 in-lb	
24V source current	50 mA	
<b>Operating Voltage Range—DC Input Modules</b>		
<b>OFF State</b>	<b>Transition Region</b>	<b>ON State</b>
0–6 Vdc	6–18 Vdc	18–30 Vdc
<b>C441K 120 Vac Input</b>		
Nominal input voltage	120 Vac	
Operating voltage	80–140 Vac	
Number of inputs	4	
OFF-state voltage	< 30 Vac	
ON-state voltage	> 80 Vac	
Nominal input current	15 mA	
Signal delay	1/2 cycle	
Isolation	250V	
Terminal screw torque	7–9 in-lb	
<b>Operating Voltage Range—AC Input Modules</b>		
<b>OFF State</b>	<b>Transition Region</b>	<b>ON State</b>
0–30 Vac	30–80 Vac	80–140 Vac
<b>Output Modules</b>		
Nominal voltage	120 Vac 24 Vdc	
Number of outputs	(2) 1NO Form A 1NO/NC Form C	
Relay OFF time	3 ms	
Relay ON time	7 ms	
Max. current per point <sup>①</sup>	5A (B300 rated)	
Electrical life	100,000 cycles	
Mechanical life	1,000,000 cycles	

**Note**

<sup>①</sup> Resistive current at 55°C ambient.

# 1.2

## C441 overload and monitoring relay

### Technical data and specifications

1

#### PROFIBUS Communication Modules

Description	Specification
<b>Electrical/EMC</b>	
Radiated emissions IEC 60947-4-1—Table 15, EN 55011 (CISPIR 11) Group 1, Class A	30–1000 mHz
Conducted emissions IEC 60947-4-1—Table 14, EN 55011 (CISPIR 11) Group 1, Class A	0.15–30 mHz
ESD immunity IEC 60947-4-1 (Table 13) IEC 61000-4-2	±8 kV air, ±4 kV contact
Radiated immunity IEC 60947-4-1 Table 13, IEC 61000-4-3	10 V/m 80–1000 mHz 80% amplitude modulated 1 kHz sine wave
Conducted immunity IEC 60947-4-1	140 dBuV (10V rms) 150 kHz–80 mHz
Fast transient immunity IEC 60947-4-1 (Table 13) IEC 61000-4-4	±2 kV using direct method
Surge immunity IEC 60947-4-1 (Table 13) IEC 61000-4-5 Class 2	User IO and communication lines: ±1 kV line-to-line (DM) ±2 kV line-to-ground (CM)
<b>Environmental Ratings</b>	
Ambient temperature (operating)	–20° to 50°C
Ambient temperature (storage)	–40° to 85°C
Operating humidity	5–95% noncondensing
Altitude (no derating)	2000m
Shock (IEC 60068-2-27)	15G any direction
Vibration (IEC 60068-2-6)	3G any direction
Pollution degree per IEC 60947-1	3
Degree of protection	IP20
<b>PROFIBUS</b>	
PROFIBUS connections	Group 2, polling, bit strobe, explicit, no UCMM
PROFIBUS baud rate	9.6K, 19.2K, 45.45K, 93.75K, 187.5K, 500K, 1.5M, 3M, 6M, 12M
<b>C441Q 24 Vdc Input</b>	
Nominal input voltage	24 Vdc
Operating voltage	18–30 Vdc
Number of inputs	4
Signal delay	5 ms (programmable to 65 sec)
OFF-state voltage	<6 Vdc
ON-state voltage	>10 Vdc
Nominal input current	5 mA
Isolation	1500V
Terminal screw torque	7–9 in-lb
24V source current	50 mA

## PROFIBUS Communication Modules, continued

Description	Specification	
<b>Operating Voltage Range—DC Input Modules</b>		
<b>OFF State</b>	<b>Transition Region</b>	<b>ON State</b>
0–6 Vdc	6–18 Vdc	18–30 Vdc
<b>C441S 120 Vac Input</b>		
Nominal input voltage	120 Vac	
Operating voltage	80–140 Vac	
Number of inputs	4	
OFF-state voltage	< 20 Vac	
ON-state voltage	> 70 Vac	
Nominal input current	15 mA	
Signal delay	1/2 cycle	
Isolation	1500V	
Terminal screw torque	7–9 in-lb	
<b>Operating Voltage Range—AC Input Modules</b>		
<b>OFF State</b>	<b>Transition Region</b>	<b>ON State</b>
0–30 Vac	30–80 Vac	80–140 Vac
<b>Output Modules</b>		
Nominal voltage	120 Vac 24 Vdc	
Number of outputs	(2) 1NO Form A 1NO/NC Form C	
Relay OFF time	3 ms	
Relay ON time	7 ms	
Max. current per point <sup>①</sup>	5A (B300 rated)	
Electrical life	100,000 cycles	
Mechanical life	1,000,000 cycles	

**Note**

<sup>①</sup> Resistive current at 55°C ambient.

# 1.2

## C441 overload and monitoring relay

### Technical data and specifications

#### 1 Ethernet (Modbus TCP / EtherNet/IP) Communication Modules

Description	Specification
<b>Electrical/EMC</b>	
Radiated emissions IEC 60947-4-1, Table 15, EN 55011 (CISPIR 11) Group 1, Class A	30–1000 mHz
Conducted emissions IEC 60947-4-1, Table 15, EN 55011 (CISPIR 11) Group 1, Class A	0.15–30 mHz
ESD immunity IEC 60947-4-1 (Table 13) IEC 61000-4-2	±8 kV air, ±4 kV contact
Radiated immunity IEC 60947-4-1 (Table 13) IEC 61000-4-3	10 V/m 80–1000 mHz 80% amplitude modulated 1 kHz sine wave
Conducted immunity IEC 60947-4-1	140 dBuV (10V rms) 150 kHz to 80 mHz
Fast transient immunity IEC 60947-4-1 (Table 13) IEC 61000-4-4	±2 kV using direct method
Surge immunity IEC 60947-4-1 (Table 13) IEC 61000-4-5 Class 2	User IO and communication lines: ±1 kV line-to-line (DM) ±2 kV line-to-ground (CM)
<b>Environmental Ratings</b>	
Ambient temperature (operating)	–20° to 50°C
Ambient temperature (storage)	–40° to 85°C
Operating humidity	5–95% noncondensing
Altitude (no derating)	2000m
Shock (IEC 60068-2-27)	15G any direction
Vibration (IEC 60068-2-6)	3G any direction
Pollution degree per IEC 60947-1	3
Degree of protection	IP20
<b>Ethernet</b>	
Ethernet connections	Integrated two-port switch with dual RJ45 Ethernet connections
Ethernet type	Ethernet 10/100 Mbps, AutoMDX, Auto Negotiation
<b>C441T 24 Vdc Input</b>	
Nominal input voltage	24 Vdc
Operating voltage	18–30 Vdc
Number of inputs	4
Signal delay	5 ms (programmable to 65 sec)
OFF-state voltage	<6 Vdc
ON-state voltage	>18 Vdc
Nominal input current	5 mA
Isolation	1500V
Terminal screw torque	7–9 in-lb
24V source current	50 mA

**Ethernet (Modbus TCP / EtherNet/IP) Communication Modules, continued**

Description	Specification	
<b>Operating Voltage Range—DC Input Modules</b>		
<b>OFF State</b>	<b>Transition Region</b>	<b>ON State</b>
0–6 Vdc	6–18 Vdc	18–30 Vdc
<b>C441R 120 Vac Input</b>		
Nominal input voltage	120 Vac	
Operating voltage	80–140 Vac	
Number of inputs	4	
OFF-state voltage	< 30 Vac	
ON-state voltage	> 80 Vac	
Nominal input current	15 mA	
Signal delay	1/2 cycle	
Isolation	1500V	
Terminal screw torque	7–9 in-lb	
<b>Operating Voltage Range—AC Input Modules</b>		
<b>OFF State</b>	<b>Transition Region</b>	<b>ON State</b>
0–30 Vac	30–80 Vac	80–140 Vac
Nominal voltage	120 Vac 24 Vdc	
Number of outputs	(2) 1NO Form A 1NO/NC Form C	
Relay OFF time	3 ms	
Relay ON time	7 ms	
Maximum current per point <sup>①</sup>	5A (B300 rated)	
Electrical life	100,000 cycles	
Mechanical life	1,000,000 cycles	

**Note**

<sup>①</sup> Resistive current at 55°C ambient.

# 1.2 C441 overload and monitoring relay

## Dimensions

### 1 Dimensions

Approximate Dimensions in mm

#### Motor Insight Overload Relay

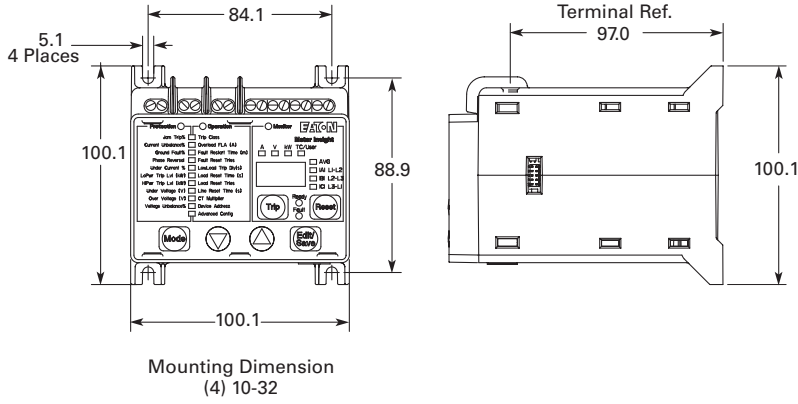

#### Motor Insight with Mounted DeviceNet, PROFIBUS or Modbus with I/O Communication Module

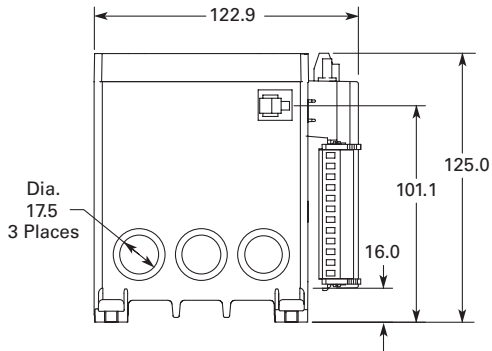

Approximate Dimensions in mm

## Motor Insight with Mounted Modbus Communication Module

1

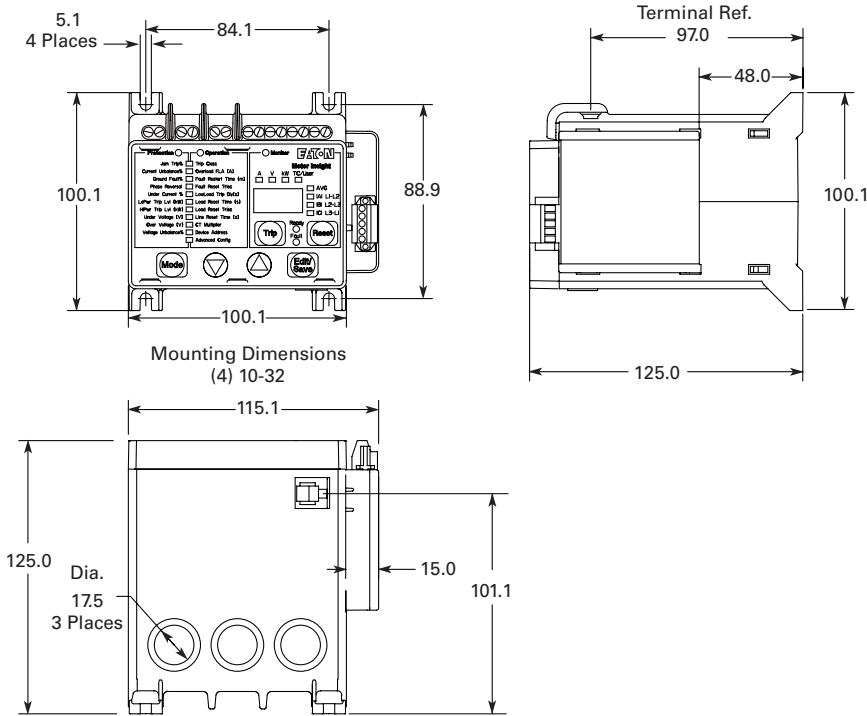

## Motor Insight Remote Display



# 1.2 C441 overload and monitoring relay

## Dimensions

1 Approximate Dimensions in mm

### Motor Insight Cover Assembly

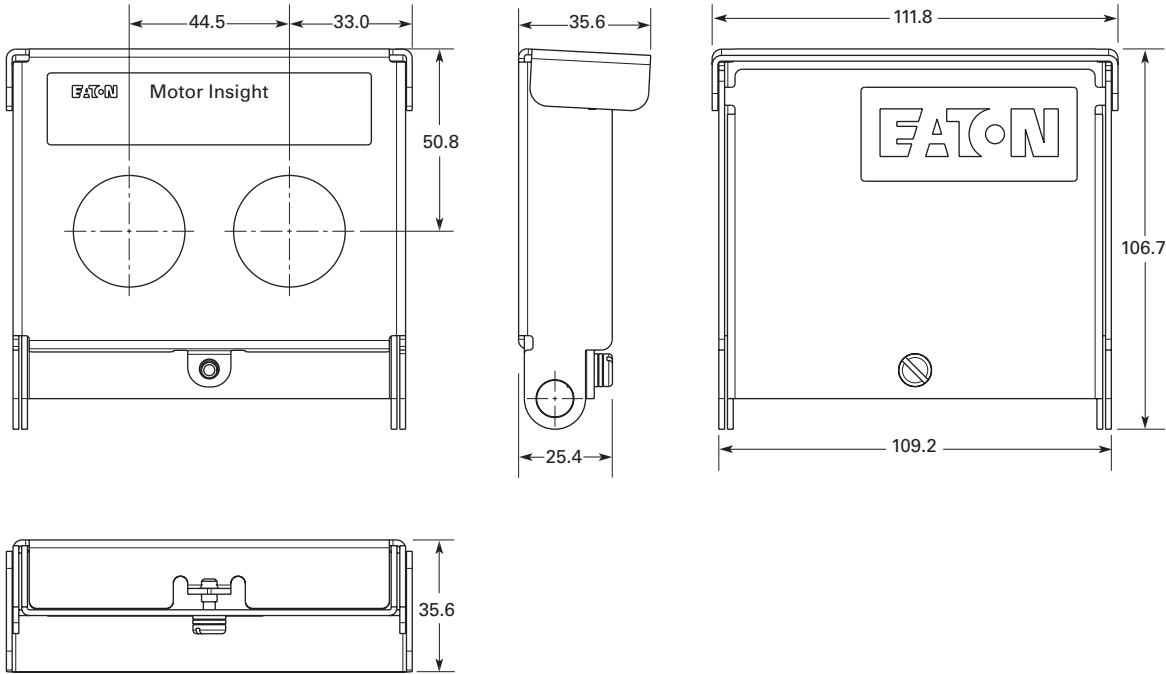

### Motor Insight Conversion Plate

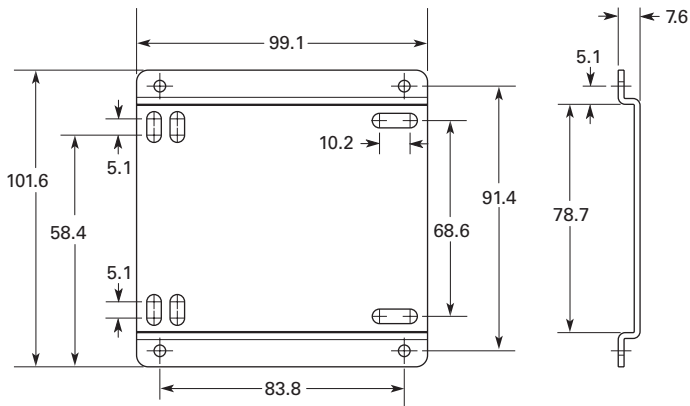





# PKZ and PKE motor-protective circuit-breakers

Machinery and installation downtimes should be kept as short as possible. The PKZ fuseless motor-protective circuit-breakers combine short-circuit and overload protection in one device, allowing fast restart readiness. PKZM01, PKZM0, PKZM4 and PKE have the same accessories. Combines easily with DILM contactors and DS7 soft starters. Connecting PKE to SmartWire-DT® facilitates high data transparency.



## PKZM01 (up to 16 A) motor-protective circuit-breaker with pushbuttons

- Motor-protective circuit-breaker in housing for protection types IP40 and IP65.
- Integrated EMERGENCY STOP and EMERGENCY OFF pushbuttons reduce wiring.

## PKZM0 (up to 32 A) and PKZM4 (up to 65 A) motor-protective circuit-breakers with rotary handle

- Short-circuit proof up to at least 50 kA for easy engineering
- Trip-indicating auxiliary contact enables remote diagnosis
- High safety through application as main switch or repair and maintenance switch
- ATEX approval for protection of EEx e motors up to 65 A



## PKE (up to 65 A) motor-protective circuit-breakers with electronic wide-range overload protection

- High flexibility through plug-in trip block
- Wide current setting ranges enable only five trip blocks up to 65 A
- Precise and extremely long-term stable characteristic curves
- Individual supply through integrated current converter
- ATEX approval for protection of EEx e motors up to 65 A
- Adjustable tripping classes

## DC string circuit-breakers PKZ-SOL and DC switch-disconnectors P-SOL (up to 63 A) for installations

- High string circuit-breaker flexibility due to wide current setting range
- Enclosed switch-disconnector for external mounting (IP65)
- Remote shutdown through optional secondary voltage and shunt trip
- Voltage up to 1000 V DC
- TÜV certified

**Motor-protective circuit-breaker  
PKZM01, PKZM0, PKZM4, PKE**



**DC string circuit-breaker PKZ-SOL,  
DC switch-disconnectors P-SOL, SOL**



**System overview**

PKZM01, PKZM0, PKZM4, PKE motor-protective circuit-breakers . . . . . 2

**Ordering**

Motor-protective circuit-breakers . . . . . 3  
 Motor-protective circuit-breakers for starter combinations . . . . . 6  
 Transformer-protective circuit-breakers . . . . . 6  
 PKE electronic motor-protective circuit-breaker . . . . . 8  
 Standard auxiliary contacts . . . . . 10  
 Auxiliary contacts, shunt releases, undervoltage release . . . . . 12

**Engineering**

Accessories for motor-protective circuit-breakers in enclosures . . . . . 14

**Ordering**

Insulated enclosures . . . . . 16  
 Accessories . . . . . 20  
 Busbar adapters . . . . . 22  
 Wiring sets . . . . . 25  
 Motor feeder plugs, three-phase commoning links . . . . . 26  
 Actuating voltages . . . . . 29

**Engineering**

Motor-protective circuit-breakers . . . . . 30  
 Characteristic curves . . . . . 30  
 Switching capacity . . . . . 32

**Technical data**

Motor-protective circuit-breakers . . . . . 36  
 Auxiliary contacts . . . . . 38

**Dimensions**

PKZM01, PKZM0 motor-protective circuit-breaker . . . . . 39  
 Accessories . . . . . 40  
 PKZM4 motor-protective circuit-breaker . . . . . 45  
 Accessories . . . . . 46

**Description**

DC switches P-SOL, PKZ-SOL, SOL . . . . . 47

**Ordering**

DC switch-disconnector SOL, ready-to-install . . . . . 48  
 DC switch-disconnector P-SOL, open . . . . . 49  
 DC string circuit-breaker PKZ-SOL . . . . . 49

**Engineering**

Circuit P-SOL, PKZ-SOL Interior circuit SOL . . . . . 50  
 Characteristic curves . . . . . 51

**Technical data**

DC switch-disconnectors P-SOL, SOL . . . . . 52  
 DC string circuit-breaker PKZ-SOL . . . . . 53

**Dimensions**

DC switches P-SOL, PKZ-SOL, SOL . . . . . 54

# 1.3

## Motor-protective circuit-breakers PKZM01, PKZM0, PKZM4, PKE

Motor-protective circuit-breaker

### 1 System overview

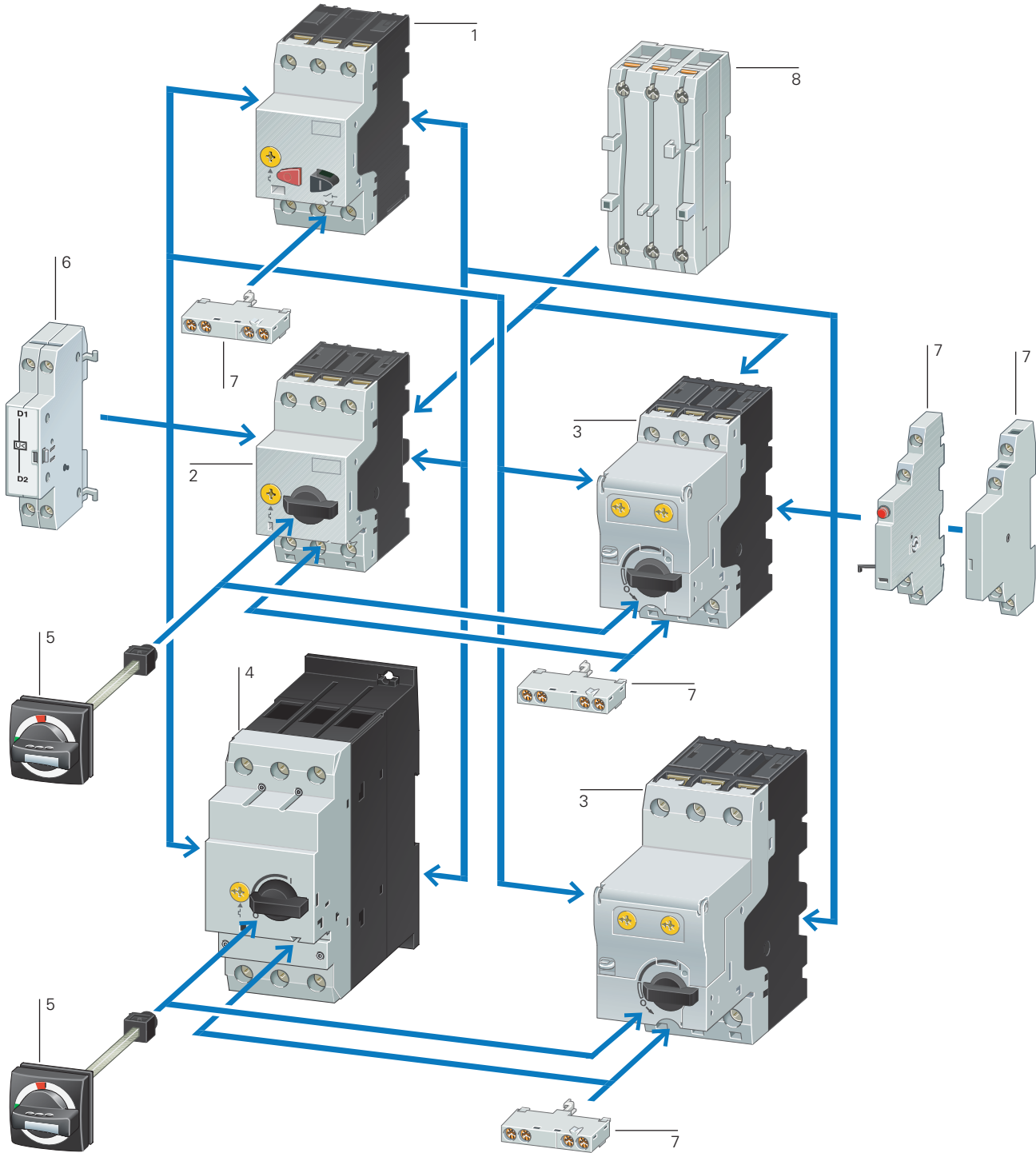

#### Basic devices

Motor-protective circuit-breaker PKZM01	1
→ Page 3	
Motor-protective circuit-breaker PKZM0	2
→ Page 4	

Motor-protective circuit-breaker with wide-range overload protection	3
→ Page 8	
Motor-protective circuit-breaker PKZM4	4
→ Page 4	

#### Add-on functions

Standard auxiliary contacts	7
→ Page 10	
Shunt release	6
→ Page 29	
Current limiters	8
→ Page 12	

#### Mounting accessories

Door coupling handles IP65	5
→ Page 20	
Insulated enclosure	
→ Page 16	
Mounting/wiring	
→ Page 22	

Ordering



PKZM01

Max. motor rating  
AC-3

220 V	380 V	440 V
230 V	400 V	
240 V	415 V	

Rated uninter-  
rupted  
current

Setting range

Overload  
releases

Short-  
circuit  
releases

Screw terminals

Part no.  
Article no.

Price  
See price  
list

Std. pack

Information relevant for export to  
North America



P	P	P	$I_u$	$I_r$	$I_{rm}$
kW	kW	kW	A	A	A

Motor-protective circuit-breakers, type "1"; and type "2" coordination

–	–	–	0.16	0.1...0.16	2.2	<b>PKZM01-0.16</b> 278475	1 off			Product Standards	UL 508; CSA-C22.2 No.14; IEC60947- 4-1; CE marking	
–	0.06	0.06	0.25	0.16...0.25	3.5	<b>PKZM01-0.25</b> 278476	1 off			UL File No.	E36332	
0.06	0.09	0.12	0.4	0.25...0.4	5.6	<b>PKZM01-0.4</b> 278477	1 off			UL CCN	NLRV 12528	
0.09	0.12	0.18	0.63	0.4...0.63	8.8	<b>PKZM01-0.63</b> 278478	1 off			CSA File No.	3211-05	
0.12	0.25	0.25	1	0.63...1	14	<b>PKZM01-1</b> 278479	1 off			NA Certification	UL Listed, CSA certified	Branch circuits, or suitable for group installations
0.25	0.55	0.55	1.6	1...1.6	22	<b>PKZM01-1.6</b> 278480	1 off			See also	→ Page 34	
0.37	0.75	1.1	2.5	1.6...2.5	35	<b>PKZM01-2.5</b> 278481	1 off					
0.75	1.5	1.5	4	2.5...4	56	<b>PKZM01-4</b> 278482	1 off					
1.1	2.2	3	6.3	4...6.3	88	<b>PKZM01-6.3</b> 278483	1 off					
2.2	4	4	10	6.3...10	140	<b>PKZM01-10</b> 278484	1 off					
3	5.5	5.5	12	8...12	168	<b>PKZM01-12</b> 278485	1 off					
4	7.5	9	16	10...16	224	<b>PKZM01-16</b> 283390	1 off					
5.5	9	11	20	16...20	280	<b>PKZM01-20</b> 283383	1 off			Product Standards	UL 508; CSA-C22.2 No.14; IEC/EN 60947- 4-1; CE marking	
5.5	12.5	12.5	25	20...25	350	<b>PKZM01-25</b> 288893	1 off			UL File No.	E36332	
										UL CCN	NLRV 12528	
										CSA File No.	3211-05	
										CSA Class No.	UL Listed, CSA certified	
										NA Certification		

Notes

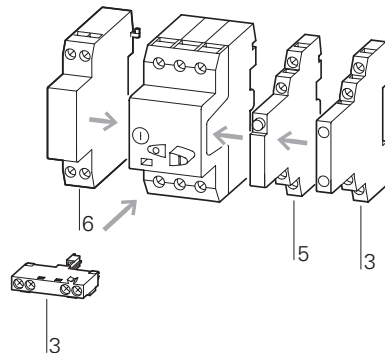

Accessories

- 3 Standard auxiliary contacts
- 5 Trip-indicating auxiliary contact
- 6 Shunt release, undervoltage release

Page

- 10
- 12
- 29

Phase failure sensitivity to IEC/EN 60947-4-1, VDE 0660 Part 102.

Can be snap-fitted to IEC/EN 60715 top-hat rail with 7.5 or 15 mm height

# 1.3

## Motor-protective circuit-breakers PKZM01, PKZM0, PKZM4, PKE

### Motor-protective circuit-breaker

1

Circuit diagrams

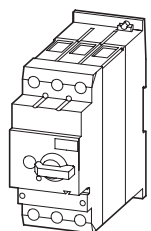
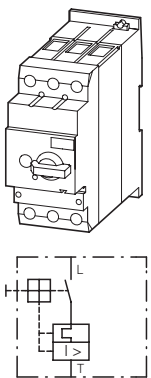
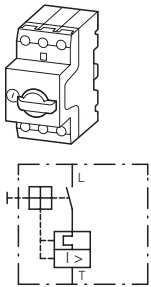

### PKZM0, PKZM4

Max. motor rating AC-3					Rated uninter-rupted current	Setting range		Part no. Article no.	Price See price list	Screw terminals on feed side, spring-loaded terminals on output side
220 V	380 V	440 V	500 V	660 V		Overload releases	Short-circuit releases			
230 V	400 V			690 V	$I_u$	$I_r$				
240 V	415 V				A	A				
P kW	P kW	P kW	P kW	P kW						
<b>Motor-protective circuit-breakers, type "1" and type "2" coordination<sup>1)</sup></b>										
–	–	–	–	0.06	0.16	0.1...0.16	2.2	<b>PKZM0-0.16</b> 072730		<b>PKZM0-0.16-SC</b> 229828
–	0.06	0.06	0.06	0.12	0.25	0.16...0.25	3.5	<b>PKZM0-0.25</b> 072731		<b>PKZM0-0.25-SC</b> 229829
0.06	0.09	0.12	0.12	0.18	0.4	0.25...0.4	5.6	<b>PKZM0-0.4</b> 072732		<b>PKZM0-0.4-SC</b> 229830
0.09	0.12	0.18	0.25	0.25	0.63	0.4...0.63	8.8	<b>PKZM0-0.63</b> 072733		<b>PKZM0-0.63-SC</b> 229831
0.12	0.25	0.25	0.37	0.55	1	0.63...1	14	<b>PKZM0-1</b> 072734		<b>PKZM0-1-SC</b> 229832
0.25	0.55	0.55	0.75	1.1	1.6	1...1.6	22	<b>PKZM0-1.6</b> 072735		<b>PKZM0-1.6-SC</b> 229833
0.37	0.75	1.1	1.1	1.5	2.5	1.6...2.5	35	<b>PKZM0-2.5</b> 072736		<b>PKZM0-2.5-SC</b> 229834
0.75	1.5	1.5	2.2	3	4	2.5...4	56	<b>PKZM0-4</b> 072737		<b>PKZM0-4-SC</b> 229835
1.1	2.2	3	3	4	6.3	4...6.3	88	<b>PKZM0-6.3</b> 072738		<b>PKZM0-6.3-SC</b> 229836
2.2	4	4	4	7.5	10	6.3...10	140	<b>PKZM0-10</b> 072739		<b>PKZM0-10-SC</b> 229837
3	5.5	5.5	5.5	11	12	8...12	168	<b>PKZM0-12</b> 278486		<b>PKZM0-12-SC</b> 278487
4	7.5	9	9	12.5	16	10...16	224	<b>PKZM0-16</b> 046938		<b>PKZM0-16-SC</b> 229838
5.5	9	11	12.5	15	20	16...20	280	<b>PKZM0-20</b> 046988		
5.5	12.5	12.5	15	22	25	20...25	350	<b>PKZM0-25</b> 046989		
7.5	15	15	22	30	32	25...32	448	<b>PKZM0-32</b> 278489		
<b>Motor-protective circuit-breakers, type "1" and type "2" coordination<sup>1)</sup></b>										
4	7.5	9	9	12.5	16	10...16	224	<b>PKZM4-16</b> 222350		
5.5	12.5	12.5	15	22	25	16...25	350	<b>PKZM4-25</b> 222352		
7.5	15	17.5	22	22	32	25...32	448	<b>PKZM4-32</b> 222353		
11	20	22	24	30	40	32...40	560	<b>PKZM4-40</b> 222354		
14	25	30	30	45	50	40...50	700	<b>PKZM4-50</b> 222355		
17	30	37	37	55	58	50...58	812	<b>PKZM4-58</b> 222394		
18.5	34	37	45	55	65	55...65	882	<b>PKZM4-63</b> 222413		
<b>Circuit-breakers<sup>2)</sup></b>										
<b>For line and cable protection</b>										
–	–	–	–	–	16	10...16	224	<b>PKZM4-16-CB</b> 132591		
–	–	–	–	–	25	16...25	350	<b>PKZM4-25-CB</b> 132592		
–	–	–	–	–	32	25...32	448	<b>PKZM4-32-CB</b> 132593		

### Spring-loaded terminals

**Part no.**      **Price**      **Std. pack**      **Notes**  
 Article no.      See price list

**Information relevant for export to North America**



**PKZM0-0,16-C**  
229669



**PKZM0-0,25-C**  
229670

**PKZM0-0,4-C**  
229671

**PKZM0-0,63-C**  
229672

**PKZM0-1-C**  
229673

**PKZM0-1,6-C**  
229674

**PKZM0-2,5-C**  
229675

**PKZM0-4-C**  
229676

**PKZM0-6,3-C**  
229677

**PKZM0-10-C**  
229678

**PKZM0-12-C**  
278488

**PKZM0-16-C**  
229679

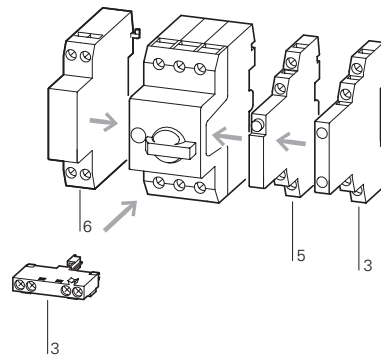

**Accessories**

- 3 Standard auxiliary contacts
- 5 Trip-indicating auxiliary contact
- 6 Shunt release, undervoltage release

**Page**

- 10
- 12
- 29

Phase failure sensitivity to IEC/EN 60947-4-1, VDE 0660 Part 102.  
 Can be snap-fit to IEC/EN 60715 top-hat rail with 7.5 or 15 mm height  
 PTB 02 ATEX 3151, see manual → 21

1) Product Standards      UL 508; CSA-C22.2 No.14; IEC60947-4-1; CE marking  
 UL File No.              E36332  
 UL CCN                    NLRV  
 CSA File No.              12528  
 CSA Class No.            3211-05  
 NA Certification        UL Listed, CSA certified  
 Suitable for              Branch circuit: Manual type E if used with terminal, or suitable for group installations  
 See also                    → Page 34

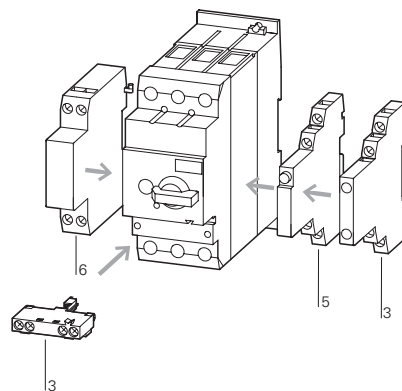

**Accessories**

- 3 Standard auxiliary contacts → 10
- 5 Trip-indicating auxiliary contact → 12
- 6 Shunt release, undervoltage release → 29

Only motor-protective circuit-breaker:  
 Phase failure sensitivity to IEC/EN 60947-4-1, VDE 0660 Part 102  
 Can be snap-fitted to IEC/EN 60715 top-hat rail with 7.5 or 15 mm height  
 PTB 02 ATEX 3153, see manual → 21



Not usable as a main switch  
 Phase failure sensitivity to IEC/EN 60947-4-1, VDE 0660 Part 102.  
 Switching capacity of SCCR  
 65 kA (480 Y/277 V)  
 22 kA (600 Y/347 V)

2) Product Standards      UL 489; CSA-C22.2 No.5-09; IEC 60947-4-1; CE marking  
 NA Certification        Request filed for UL and CSA  
 Specially designed for NA Yes  
 Suitable for              Feeder and branch circuit as BCPD

# 1.3

## Motor-protective circuit-breakers PKZM01, PKZM0, PKZM4, PKE

Motor-protective circuit-breaker for starter combinations and transformers

1

### PKZM0

Max. motor rating AC-3					Rated uninterrupted current $I_u$	Setting range		Screw terminals Part no. Article no.	Price See price list	Std. pack
220 V 230 V 240 V	380 V 400 V 415 V	440 V	500 V	660 V 690 V		Overload releases $I_r$	Short-circuit releases $I_m$			
P kW	P kW	P kW	P kW	P kW	A	A	A			
				0.06	0.16		2.2	<b>PKM0-0,16</b> 072720		1 off
	0.06	0.06	0.06	0.12	0.25		3.5	<b>PKM0-0,25</b> 072721		1 off
0.06	0.09	0.12	0.12	0.18	0.4		5.6	<b>PKM0-0,4</b> 072722		1 off
0.09	0.12	0.18	0.25	0.25	0.63		8.8	<b>PKM0-0,63</b> 072723		1 off
0.12	0.25	0.25	0.38	0.55	1		14	<b>PKM0-1</b> 072724		1 off
0.25	0.37	0.55	0.75	1.1	1.6		22	<b>PKM0-1,6</b> 072725		1 off
0.37	0.75	1.1	1.1	1.5	2.5		35	<b>PKM0-2,5</b> 072726		1 off
0.75	1.5	1.5	2.2	3	4		56	<b>PKM0-4</b> 072727		1 off
1.1	2.2	3	3	4	6.3		88	<b>PKM0-6,3</b> 072728		1 off
2.2	4	4	4	7.5	10		140	<b>PKM0-10</b> 072729		1 off
3	5.5	5.5	5.5	11	12		168	<b>PKM0-12</b> 278490		1 off
4	7.5	9	9	12.5	16		224	<b>PKM0-16</b> 044502		1 off
5.5	9	11	12.5	15	20		280	<b>PKM0-20</b> 203594		1 off
5.5	12.5	12.5	15	22	25		350	<b>PKM0-25</b> 044503		1 off
7.5	15	15	22	30	32		448	<b>PKM0-32</b> 278491		1 off
				0.16	0.16	0.1...0.16	2.4	<b>PKZM0-0,16-T</b> 088907		1 off
				0.25	0.25	0.16...0.25	4.25	<b>PKZM0-0,25-T</b> 088908		1 off
				0.4	0.4	0.25...0.4	6.8	<b>PKZM0-0,4-T</b> 088909		1 off
				0.63	0.63	0.4...0.63	12	<b>PKZM0-0,63-T</b> 088910		1 off
				1	1	0.63...1	20	<b>PKZM0-1-T</b> 088911		1 off
				1.6	1.6	1...1.6	32	<b>PKZM0-1,6-T</b> 088912		1 off
				2.5	2.5	1.6...2.5	50	<b>PKZM0-2,5-T</b> 088913		1 off
				4	4	2.5...4	84	<b>PKZM0-4-T</b> 088914		1 off
				6.3	6.3	4...6.3	141	<b>PKZM0-6,3-T</b> 088915		1 off
				10	10	6.3...10	224	<b>PKZM0-10-T</b> 088916		1 off
				12	12	8...12	224	<b>PKZM0-12-T</b> 278492		1 off
				16	16	10...16	280	<b>PKZM0-16-T</b> 088917		1 off
				20	20	16...20	350	<b>PKZM0-20-T</b> 088918		1 off
				25	25	20...25	437	<b>PKZM0-25-T</b> 278493		1 off

Motor-protective circuit-breakers for starter combinations  
Short-circuit protective breakers without overload function

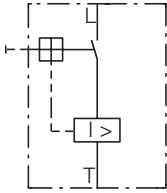
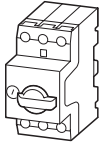

Transformer-protective circuit-breakers

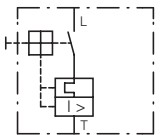
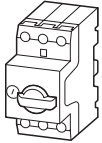

**Notes**



When using the PKM0 as short-circuit protection for motors with heavy starting duty, a device must be selected whose rated operational current  $I_e$  is higher by the following factors:

- CLASS 5 = 1.0
- CLASS 10 = 1.0
- CLASS 15 = 1.22
- CLASS 20 = 1.41
- CLASS 25 = 1.58
- CLASS 30 = 1.73
- CLASS 35 = 1.89
- CLASS 40 = 2.0

**Accessories**

- 3 Standard auxiliary contacts
- 5 Trip-indicating auxiliary contact
- 6 Shunt release, undervoltage release
- Additional accessories

**Page**

- 10
- 12
- 29
- 46

Can be snap-fitted to IEC/EN 60715 top-hat rail with 7.5 or 15 mm height

Assignment of the short-circuit protective breakers and contactors in "Fuseless motor-starter combinations" section.

An appropriate overload relay must be fitted to protect motors against overload.

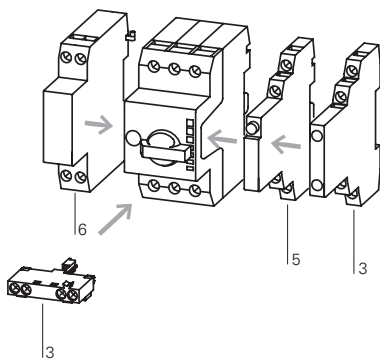

**Accessories**

- 3 Standard auxiliary contacts
- 5 Trip-indicating auxiliary contact
- 6 Shunt release, undervoltage release

**Page**

- 10
- 12
- 29

For the protection of transformers with a high inrush current

Can be snap-fitted to IEC/EN 60715 top-hat rail with 7.5 or 15 mm height

Phase failure sensitivity to IEC/EN 60947-4-1, VDE 0660 Part 102.















# 1.3

## Motor-protective circuit-breakers PKZM01, PKZM0, PKZM4, PKE

### Motor-protective circuit-breaker

#### PKE

1

Motor rating P kW	Motor full-load current					Setting range Overload releases	Basic device Part no. Article no.	See price list	Std. pack
	AC-3 220 V 230 V 240 V	380 V 400 V 415 V	440 V	500 V	660 V 690 V				
	I A	I A	I A	I A	I A				
<b>Motor-protective circuit-breakers, type "1" and type "2" coordination</b>									
0.06						0.3...1.2 A	<b>PKE12</b> 121721		1off  
0.09									
0.12									
0.18									
0.25									
0.37									
0.55									
0.75									
0.18						1...4 A	<b>PKE12</b> 121721		1off  
0.25									
0.37									
0.55									
0.75									
1.1									
1.5									
2.2									
3									
0.75						3...12 A	<b>PKE12</b> 121721		1off  
1.1									
1.5									
2.2									
3									
4									
5.5									
7.5									
2.2						8...32 A	<b>PKE32</b> 121722		1off  
3									
4									
5.5									
7.5									
11									
15									
18.5									
22									
30									
5.5						16...65 A	<b>PKE65</b> 138258		1off  
7.5									
11									
15									
18.5									
22									
30									
37									
45									
55									
2.2						8...32 A	<b>PKE65</b> 138258		1off  
3									
4									
5.5									
7.5									
11									
15									
18.5									
22									
30									

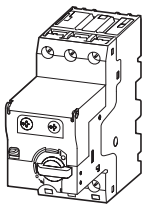
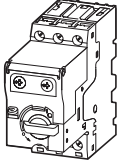

**Notes** Select switchgear and cables according to Class as shown in the table on Chapter 1.2 (Page 22)  
<sup>1)</sup> For communications, module PKE-SWD-32 for contactors is required in addition, → See catalog

# Motor-protective circuit-breakers PKZM01, PKZM0, PKZM4, PKE

## Motor-protective circuit-breaker

# 1.3

1

Trip module Standard				Trip module Expanded <sup>1)</sup>			Motor-protective circuit-breakers Standard Complete device			
usable for	Part no. Article no.	See price list	Std. pack	usable for	Part no. Article no.	See price list	Std. pack	Part no. Article no.	See price list	Std. pack
	<b>PKE12</b>		1off 	<b>PKE12</b>	<b>PKE-XTU-1,2</b> 121723		1off 	<b>PKE12/XTU-1,2</b> 121731		1off 
		Start of delivery 07/2010				Start of delivery 07/2010			Start of delivery 07/2010	
	<b>PKE12</b>		1off 	<b>PKE12</b>	<b>PKE-XTU-4</b> 121724		1off 	<b>PKE12/XTU-4</b> 121732		1off 
						Start of delivery 05/2010				
	<b>PKE12</b> <b>PKE32</b>		1off 	<b>PKE12</b> <b>PKE32</b>	<b>PKE-XTU-12</b> 121725		1off 	<b>PKE12/XTU-12</b> 121733		1off 
						Start of delivery 05/2010				
	<b>PKE32</b>		1off 	<b>PKE32</b>	<b>PKE-XTU-32</b> 121726		1off 	<b>PKE32/XTU-32</b> 121734		1off 
						Start of delivery 05/2010				
	<b>PKE65</b>		1off 	<b>PKE65</b>	<b>PKE-XTU-65</b> 138259		1off 	<b>PKE65/XTU-65</b> 138516		1off
		Start of delivery 10/2010				Start of delivery 10/2010			Start of delivery 10/2010	
	<b>PKE65</b>		1off 	<b>PKE65</b>	<b>PKE-XTUW-32</b> 138261		1off 	<b>PKE65/XTUW-32</b> 138517		1 off
		Start of delivery 10/2010				Start of delivery 10/2010			Start of delivery 10/2010	

Information relevant for export to North America

Product Standards  
NA Certification

UL 508; CSA-C22.2 No. 14; IEC60947-4-1; CE marking  
Request filed for UL and CSA

# 1.3

## Motor-protective circuit-breakers PKZM01, PKZM0, PKZM4, PKE Standard auxiliary contacts

1

### NHI...-PKZ0... Standard auxiliary contacts

For motor-protective circuit-breakers

Contact configuration	Contact sequence	Circuit diagrams	Connection method	For use with	Part no. Article no.	Price See price list	Std. pack
1 N/O N/O = normally open contact	1 NC NC = normally closed contact			Screw terminals	PKZM01 PKZM0 PKZM4 PKZM0-T PKM0 PKE 1)	<b>NHI11-PKZ0</b> 072896	5 off 
1 N/O	1 NC			Spring-loaded terminals	PKZM01 PKZM0 PKZM4 PKZM0-T PKM0 PKE 1)	<b>NHI11-PKZ0-C</b> 229680	5 off 
1 N/O	2 NC			Screw terminals	PKZM01 PKZM0 PKZM4 PKZM0-T PKM0 PKE 1)	<b>NHI12-PKZ0</b> 072895	5 off 
2 N/O	1 NC			Screw terminals	PKZM01 PKZM0 PKZM4 PKZM0-T PKM0 PKE 1)	<b>NHI21-PKZ0</b> 072894	5 off 
1 N/O	1 NC			Screw terminals	PKZM01 PKZM0 PKZM4 PKZM0-T PKM0 PKE 1)	<b>NHI-E-11-PKZ0</b> 082882	5 off 
1 N/O	-			Screw terminals	PKZM01 PKZM0 PKZM4 PKZM0-T PKM0 PKE 1)	<b>NHI-E-10-PKZ0</b> 082884	5 off 
1 N/O	-			Spring-loaded terminals	PKZM01 PKZM0 PKZM4 PKZM0-T PKM0 PKE 1)	<b>NHI-E-10-PKZ0-C</b> 229681	5 off 
-	1 NC			Spring-loaded terminals	PKZM01 PKZM0 PKZM4 PKZM0-T PKM0 PKE 1)	<b>NHI-E-01-PKZ0-C</b> 229682	5 off
1 N/O	1 NC			Screw terminals	PKZM01 PKZM0 PKZM4 PKZM0-T PKM0 PKE 1)	<b>NHI-B-11-PKZ0</b> 208277	5 off

**Notes**

1) Only standard auxiliary contacts manufactured on or after CW 36/2009 are for use with PKE.

### Notes

Can be fitted to the right side of: motor-protective circuit-breakers, transformer protective circuit breakers and motor-protective circuit-breakers for starter combinations

Can be combined with:  
Trip-indicating auxiliary contact AGM, NHI-E...

### Notes

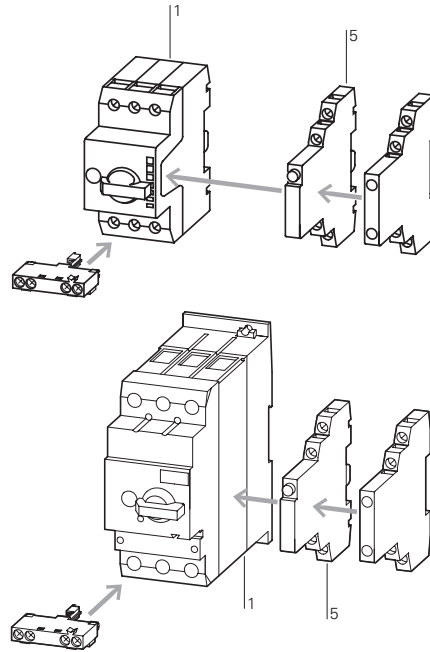

### Information relevant for export to North America



Product Standards	UL 508; CSA-C22.2No.14; IEC 60947-4-1; CE marking
UL File No.	E36332
UL CCN	NLRV
CSA File No.	12528
CSA Class No.	3211-05
NA Certification	UL Listed, CSA certified

Can be fitted to motor-protective circuit-breakers, transformer-protective circuit-breakers and motor-protective circuit-breakers for starter combinations from serial number 01. 45 mm (PKZM0 and PKZM01) or 55 mm (PKZM4) widths of the motor-protective circuit-breakers remain unchanged.  
NHI-E...-PKZO-C not for use with MSC...-type motor starter combinations.

### Accessories

- 1 Motor-protective circuit-breakers → 4
- 5 Trip-indicating auxiliary contact → 12
- Additional accessories → 20

# 1.3

## Motor-protective circuit-breakers PKZM01, PKZM0, PKZM4, PKE

Auxiliary contacts, undervoltage releases

1

### AGM2...., VHI...

Contact configuration

N/O = normally open contact  
NC = normally closed contact

Contact sequence

Circuit diagrams

For use with

Part no.  
Article no.

Price  
See price list

Std. pack

#### Trip indicators

##### For motor-protective circuit-breakers

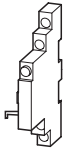

2 x 1 N/O

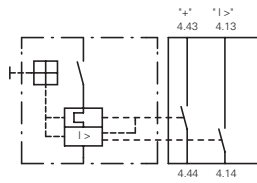
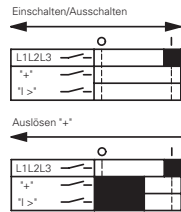

PKZM0  
PKZM4  
PKZM0-T  
PKM0  
PKZM01  
PKE<sup>1)</sup>

**AGM2-10-PKZ0**  
072898

2 off

– 2 x 1 NC

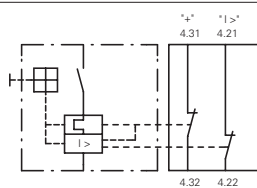
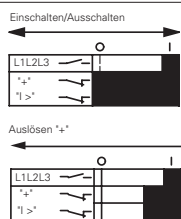

PKZM0  
PKZM4  
PKZM0-T  
PKM0  
PKZM01  
PKE<sup>1)</sup>

**AGM2-01-PKZ0**  
072899

2 off

#### Early-make auxiliary contacts

##### For motor-protective circuit-breakers



2 N/O

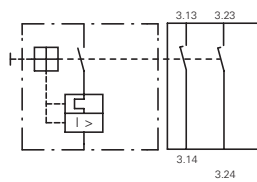

PKZM0  
PKZM0-T  
PKM0  
PKZM4

**VHI20-PKZ0**  
203595

2 off

2 N/O



PKZM01

**VHI20-PKZ01**  
278495

5 off

#### Shunt release (for power circuit-breakers)

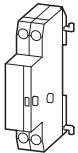

–

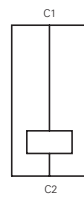

PKZM0  
PKZM4  
PKZM0-T  
PKM0  
PKZM01  
PKE<sup>2)</sup>

**A-PKZ0(230V50Hz)**  
073187

2 off

–

PKZM0  
PKZM4  
PKZM0-T  
PKM0  
PKZM01  
PKE<sup>2)</sup>

**A-PKZ0(24VDC)**  
073200

2 off

#### Undervoltage release

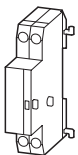

–

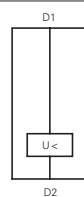

PKZM0  
PKZM4  
PKZM0-T  
PKM0  
PKZM01  
PKE<sup>2)</sup>

**U-PKZ0(230V50Hz)**  
073135

2 off

#### Current limiters

##### For increasing switching capacity of motor-protective circuit-breakers without auto-protection

–

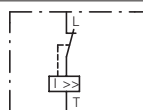

PKZM0  
PKZM4  
PKE

**CL-PKZ0**  
082881

1 off

#### Notes

- <sup>1)</sup> Only AGM2-...-PKZ0 manufactured on or after 06/2009 can be fitted.
- <sup>2)</sup> Only A(U)-PKZ0... with serial number 02 or higher can be fitted.

**Notes**

Can be fitted to the right side of motor-protective circuit-breakers

Can be combined with:  
Standard auxiliary contacts  
NHI11-PKZO  
NHI12-PKZO  
NHI21-PKZO  
NHI-E-...

Separate indication of:  
a) General trip indication (overload)  
b) Short-circuit trip

Local short-circuit indication by red indicator, manually resettable.

Can be fitted to front of motor-protective circuit-breaker, 45 mm width of the motor-protective circuit-breaker remains unchanged.  
For early energization of undervoltage release, e.g. in emergency switching off circuits to EN 60204.  
VHI20-PKZO cannot be used in combination with PKZO-X(R).

**Notes**

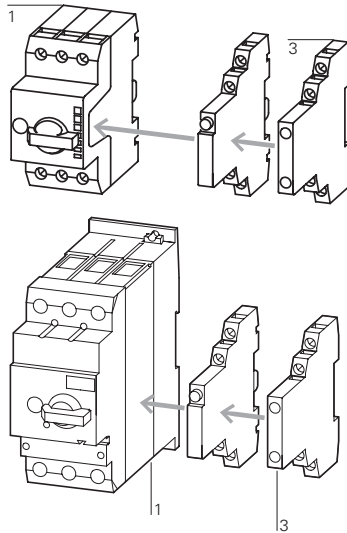

**Accessories**

- 1 Motor-protective circuit-breakers
- 3 Standard auxiliary contacts

**Page**

- 4
- 10

**Information relevant for export to North America**



Product Standards	UL 508; CSA-C22.2No.14; IEC60947-4-1; CE marking
UL File No.	E36332
UL CCN	NLRV
CSA File No.	12528
CSA Class No.	3211-05
NA Certification	UL Listed, CSA certified

Can be fitted to the left side of motor-protective circuit-breakers.  
Cannot be combined with:  
undervoltage release U-PKZO  
DC: Intermittent operation 5 s

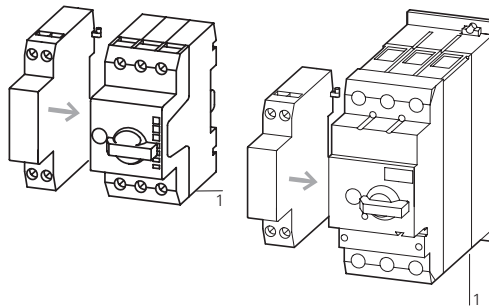

**Accessories**

- 1 Motor-protective circuit-breakers
- Further actuating voltages

**Page**

- 4
- 29

Can be fitted to the left side of motor-protective circuit-breakers.  
Cannot be combined with:  
A-PKZO shunt release  
When combined with circuit-breaker, can be used as emergency switching off device to IEC/EN 60204.

Max. rated operating voltage  $U_n = 690$  V, rated uninterrupted current  $I_n = 63$  A  
Can be used for individual and group protection.  
For group protection and in combination with PKZM4, order additional BK25/3 incoming terminal if required.  
Mounting next to or behind the motor-protective circuit-breaker.  
PKZM4: 16 - 63 A: 100 kA/400 V  
PKZM4: 16 - 63 A: 10 kA/690 V











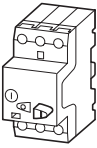

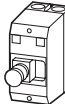
# 1.3

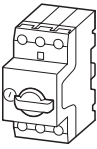
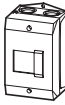
## Motor-protective circuit-breakers PKZM01, PKZM0, PKZM4, PKE

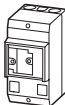
Accessories for motor-protective circuit-breakers in enclosures

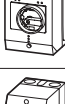
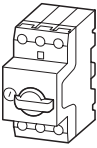
### 1 Engineering

#### PKZM01, PKZM

Part no.	Enclosure		Degree of protection	Handle color	Accessories							
	Part no.				NHI...-PKZ0	AGM2...-PKZ0	NHI-E...-PKZ0	VHI...-PKZ0	VHI...-PKZ01	U-PKZ0 or A-PKZ0	L-PKZ0	
<b>Surface mounting enclosure</b>												
<b>Motor-protective circuit-breaker PKZM01</b>												
		<b>CI-PKZ01</b>	IP40	—	—	—	●	—	—	●	●	
					—	—	—	—	●	●	●	
					●	—	●	—	—	—	●	
					●	—	—	—	●	—	●	
		<b>CI-PKZ01-G</b>	IP65	—	—	—	●	—	—	●	●	
					—	—	—	—	●	●	●	
					●	—	●	—	—	—	●	
					●	—	—	—	●	—	●	
		<b>CI-PKZ01-PVT</b> <b>CI-PKZ01-PVS</b>	IP65	Red-yellow	—	—	●	—	—	●	●	
					—	—	—	—	●	●	●	
					—	—	—	—	●	●	●	
		<b>CI-PKZ01-SVB</b> <b>CI-PKZ01-SVB-V</b>	IP65	—	—	—	●	—	—	●	●	
					—	—	—	—	● <sup>1)</sup>	●	●	
					—	—	—	—	—	●	●	
<b>Motor-protective circuit-breaker PKZM0</b>												
		<b>CI-K2-PKZ0</b>	IP41	—	●	—	●	—	—	●	●	
					—	●	●	—	—	●	●	
					●	—	—	—	—	●	●	
					—	●	●	—	—	●	●	
		<b>CI-K2-PKZ0-G</b>	IP65	Black	●	—	●	—	—	●	●	
					—	●	●	—	—	●	●	
					●	—	—	—	—	●	●	
		<b>CI-K2-PKZ0-GR</b>	IP65	Red-yellow	●	—	●	—	—	●	●	
					—	●	●	—	—	●	●	
					—	—	—	—	—	●	●	
		<b>CI-PKZ0-M</b>	IP40	—	●	—	●	—	—	—	●	
					—	—	●	—	—	●	●	
					—	—	—	—	—	●	●	
		<b>CI-PKZ0-GM</b>	IP55	Black	●	—	●	—	—	—	●	
					—	—	●	—	—	●	●	
					—	—	—	—	—	●	●	
		<b>CI-PKZ0-GRM</b>	IP55	Red-yellow	●	—	●	—	—	—	●	
					—	—	●	—	—	—	●	
					—	—	—	—	—	●	●	
<b>Motor-protective circuit-breaker PKZM0 + early-make auxiliary contact VHI-PKZ0</b>												
		<b>CI-K2-PKZ0-GV</b>	IP65	Black	●	—	—	●	—	●	●	
					—	●	—	●	—	●	●	
					●	—	—	●	—	●	●	
					—	●	—	●	—	●	●	
		<b>CI-K2-PKZ0-GRV</b>	IP65	Red-yellow	●	—	—	●	—	●	●	
					—	●	—	●	—	●	●	
					—	—	—	●	—	●	●	
					—	—	—	●	—	●	●	
		<b>CI-K2-PKZ0-GVM</b>	IP55	Black	●	—	—	●	—	—	●	
					—	—	—	●	—	●	●	
					—	—	—	●	—	●	●	
					—	—	—	●	—	●	●	
		<b>CI-K2-PKZ0-GRVM</b>	IP55	Red-yellow	●	—	—	●	—	—	●	
					—	—	—	●	—	—	●	
					—	—	—	●	—	●	●	

**Notes**

The combination possibilities of circuit-breakers in an enclosure with accessory modules are identified by a ●

<sup>1)</sup> Always required

## PKZM4, PKZM01, PKZM0

Enclosure		Accessories								
Part no.	Part no.	Degree of protection	Handle color	NHI...-PKZ0	AGM2...-PKZ0	NHI-E...-PKZ0	VHI...-PKZ0	VHI...-PKZ01	U-PKZ0 or A-PKZ0	L-PKZ0
<b>Surface mounting enclosure</b>										
<b>Motor-protective circuit-breaker PKZM4</b>										
	CI-K4-PKZ4-G	IP65	Black	●	●	●	-	-	●	●
	CI-K4-PKZ4-GR	IP65	Red-yellow	●	●	●	-	-	●	●
<b>Installation enclosure</b>										
<b>Motor-protective circuit-breaker PKZM01</b>										
	E-PKZ01	IP40	-	-	-	●	-	-	●	●
				●	-	●	-	●	●	●
	E-PKZ01-G	IP65	-	-	-	●	-	-	●	●
				●	-	●	-	●	●	●
	E-PKZ01-PVT E-PKZ01-PVS	IP65	Red-yellow	-	-	●	-	-	●	●
				-	-	-	-	●	●	●
	E-PKZ01-SVB	IP65	-	-	-	●	-	-	●	●
	E-PKZ01-SVB-V	IP65	-	-	-	-	-	● <sup>1)</sup>	●	●
<b>Motor-protective circuit-breaker PKZM0</b>										
	E-PKZ0	IP40	-	●	-	-	-	-	-	●
				-	-	-	-	-	●	●
	E-PKZ0-G	IP55	Black	●	-	●	-	-	-	●
				-	-	●	-	-	●	●
	E-PKZ1-GR	IP55	Red-yellow	●	-	●	-	-	-	●
				-	-	●	-	-	●	●

**Notes**

The combination possibilities of circuit-breakers in an enclosure with accessory modules are identified by a ●  
<sup>1)</sup> Always required











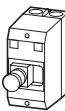
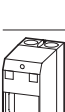

# 1.3



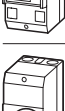
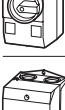

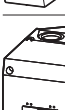























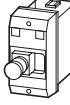

## Motor-protective circuit-breakers PKZM01, PKZM0, PKZM4, PKE Insulated enclosure

1

### PKZM01, PKZM0, PKZM4

	Degree of protection	For use with	Part no. Article no.	Price See price list	Std. pack	Notes
<b>Insulated enclosures for surface mounting</b>						
<b>For Motor-protective circuit-breaker PKZM01</b>						
	IP40	PKZM01 +NHI-E or VHI-PKZ01 +U or A or NHI +L (2 off)	<b>CI-PKZ01</b> 281403		1 off	Integrated terminal for PE(N) connection, two M25 cable entry knockouts at top and at bottom.
	IP65		<b>CI-PKZ01-G</b> 281404		1 off	
	IP65	PKZM01 +NHI-E or +U or A +L (2 off)	<b>CI-PKZ01-SVB</b> 281405		1 off	
	IP65		<b>CI-PKZ01-SVB-V</b> 281944		1 off	
	IP65		<b>CI-PKZ01-PVT</b> 281406		1 off	
	IP65		<b>CI-PKZ01-PVS</b> 281407		1 off	
	As insert	PKZM01	<b>CI-PKZ01-X</b> 289934		1 off	
<b>For Motor-protective circuit-breakers PKZM0</b>						
	IP41 with vertical mounting	PKZM0-... +NHI or AGM +U or A +NHI-E +L-PKZ0 (2 off)	<b>CI-K2-PKZ0</b> 219653		1 off	M25 metric cable entry knockout, top and bottom Cable push-through membrane top, bottom, in the back plate and as a control line entry. Insulated enclosure CI-K2 incl. N and PE terminal.
	IP65		<b>CI-K2-PKZ0-G</b> 219654		1 off	
	IP65		<b>CI-K2-PKZ0-GR</b> 219655		1 off	
	IP40	PKZM0-... +NHI or U or A +L-PKZ0 (2 off)	<b>CI-PKZ0-M</b> 267083		1 off	Integrated terminal for PE(N) connection, two M25 cable entry knockouts at top and at bottom.
	IP55	PKZM0-... +NHI-E	<b>CI-PKZ0-GM</b> 260089		1 off	
	IP55	+NHI or U or A +L-PKZ0 (2 off)	<b>CI-PKZ0-GRM</b> 260104		1 off	
<b>For Motor-protective circuit-breakers PKZM0 with early-make VHI auxiliary contacts</b>						
	IP65	PKZM0-... and VHI +NHI or AGM	<b>CI-K2-PKZ0-GV</b> 219657		1 off	M25 metric cable entry knockout, top and bottom Cable push-through membrane top, bottom, in the back plate and as a control line entry. Insulated enclosure CI-K2 incl. N and PE terminal.
	IP65	+U or A +L (2 off)	<b>CI-K2-PKZ0-GRV</b> 219656		1 off	
	IP55	PKZM0-... and VHI +U or A (undervoltage or shunt release) +L-PKZ0 (2 off)	<b>CI-PKZ0-GVM</b> 263526		1 off	Integrated terminal for PE(N) connection, two M25 cable entry knockouts at top and at bottom.
	IP55		<b>CI-PKZ0-GRVM</b> 263525		1 off	
<b>For Motor-protective circuit-breakers PKZM4</b>						
	IP65	PKZM4-... +VHI or NHI-E	<b>CI-K4-PKZ4-G</b> 225524		1 off	Metric knockout: Top and bottom: M25/M32 In the back plate: M25/M32 Control cable entry: M20 CI-K4 insulated enclosure including insulated PE terminal
	IP65	+NHI and AGM +U or A +L-PKZ0 (2 off)	<b>CI-K4-PKZ4-GR</b> 225525		1 off	

## E-PKZ





















	Degree of protection	For use with	Part no. Article no.	Price See price list	Std. pack	Information relevant for export to North America	
						 	 
<b>Insulated enclosures for flush mounting</b>							
<b>For Motor-protective circuit-breaker PKZM01</b>							
<b>Integrated terminal for PE(N) connection.</b>							
		Front IP40	PKZM01 +NHI or U or A +NHI-E or VHI +L (2 off)	<b>E-PKZ01</b> 281633	1 off  	Product Standards	UL 508; CSA-C22.2 No.14; IEC60947-4-1; CE marking
	With operating membrane	Front IP65		<b>E-PKZ01-G</b> 281634	1 off  	UL File No. UL CCN CSA File No. CSA Class No. NA Certification	E36332 NLRV 12528 3211-05 UL Listed, CSA certified
	Lockable in Off position	Front IP65	PKZM01 +U or A +NHI-E	<b>E-PKZ01-SVB</b> 281635	1 off  		
	Lockable in Off position, in combination with VHI-PKZ01	Front IP65	PKZM01 +U or A +NHI-E or VHI	<b>E-PKZ01-SVB-V</b> 281943	1 off  		
	With emergency switching off mushroom button, maintained	Front IP65		<b>E-PKZ01-PVT</b> 281636	1 off  		
	With emergency switching off mushroom button, with key-release	Front IP65		<b>E-PKZ01-PVS</b> 281637	1 off  		
	For extension with inserts C/E-PKZ01-X... unit	As insert	PKZM01	<b>E-PKZ01-X</b> 289935	1 off		
<b>For Motor-protective circuit-breakers PKZM0</b>							
<b>Integrated terminal for PE(N) connection.</b>							
	Cover with aperture dimensioned to accommodate front of breaker	Front IP40	PKZM0-... +NHI or U or A +L-PKZ0 (2 parts)	<b>E-PKZ0</b> 072906	1 off  	Product Standards	UL 508; CSA-C22.2 No.14; IEC60947-4-1; CE marking
	With black-grey rotary knob	Front IP55	PKZM0-... +NHI or U or A +NHI-E +L-PKZ0 (2 parts)	<b>E-PKZ0-G</b> 072907	1 off  	UL File No. UL CCN CSA File No. CSA Class No. NA Certification	E36332 NLRV 12528 3211-05 UL Listed, CSA certified
	With red-yellow rotary knob, for use as emergency switching off device to EN 60204	Front IP55		<b>E-PKZ0-GR</b> 072908	1 off  	Degree of Protection	UL 508; CSA-C22.2 No.14; IEC60947-4-1; CE marking IEC: Front IP55, UL/CSA Type: 1,12, 3R

# 1.3

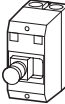









## Motor-protective circuit-breakers PKZM01, PKZM0, PKZM4, PKE Insulated enclosure

1

### CI-PKZ

	Degree of protection	For use with	Part no. Article no.	Price  See price list	Std. pack	Information relevant for export to North America 
<b>Insulated enclosures for surface mounting</b>						
<b>For Motor-protective circuit-breaker PKZM01s</b>						
<b>Integrated terminal for PE(N) connection.</b>						
	IP41	PKZM01 +NHI-E or VHI-PKZ01 +U or A or NHI +L (2 off)	<b>CI-PKZ01-NA</b> 281408		1 off 	Product Standards UL 508; CSA-C22.2 No.14; IEC60947- 4-1; CE marking UL File No. UL CCN CSA File No. CSA Class No. NA Certification E36332 NLRV 12528 3211-05 UL Listed, CSA certified
	With operating membrane IP65	PKZM01 +NHI-E or VHI-PKZ01 +U or A or NHI +L (2 off)	<b>CI-PKZ01-NA-G</b> 281409		1 off 	UL Listed, CSA certified Specially designed for NA ✓ Degree of Protection IEC: IP41, UL/CSA Type: -
	Lockable in Off position IP65	PKZM01 +NHI-E or VHI-PKZ01 +U or A +L (2 off)	<b>CI-PKZ01-NA-SVB</b> 281630		1 off 	
	Lockable in Off position, in combination with VHI-PKZ01 IP65	PKZM01 +NHI-E +U or A +L (2 off)	<b>CI-PKZ01-NA-SVB-V</b> 281945		1 off 	
	With emergency switching off mushroom button, maintained IP65		<b>CI-PKZ01-NA-PVT</b> 281631		1 off 	
	With emergency switching off mushroom button, with key-release IP65		<b>CI-PKZ01-NA-PVS</b> 281632		1 off 	
<b>For Motor-protective circuit-breakers PKZM0</b>						
<b>Integrated N and PE terminals; lower section without knockouts</b>						
	With black-grey rotary knob IP55	PKZM0-... +NHI or U or A +NHI-E +L-PKZ0 (2 parts)	<b>CI-K2-PKZ0-NA-G</b> 262680		1 off 	
	With red-yellow rotary knob, for use as emergency switching off device to EN 60204 IP55		<b>CI-K2-PKZ0-NA-GR</b> 262681		1 off 	
<b>For Motor-protective circuit-breakers PKZM0 with early-make auxiliary contacts</b>						
<b>Integrated N and PE terminals; lower section without knockouts</b>						
	With black-grey rotary knob IP55	PKZM0-... +VHI... + U... +L-PKZ0 (2 parts)	<b>CI-K2-PKZ0-NA-GV</b> 262682		1 off 	
	With red-yellow rotary knob, for use as emergency switching off device to EN 60204 IP55		<b>CI-K2-PKZ0-NA-GRV</b> 262683		1 off 	

## SVB-PKZ, CL/EPKZ01

	Degree of protection	For use with	Part no. Article no.	Price See price list	Std. pack	Information relevant for export to North America 
<b>Insulated enclosures, accessories</b>						
<b>Padlocking feature</b>						
<b>For up to 3 padlocks with 3 – 6 mm hasp thickness, for use as main switch to IEC/EN60204</b>						
	Lockable in the 0-position of the PKZM0 or Motor-protective circuit-breaker PKZM4.	–	CI-K2-PKZ0-G(R)(V) CI-PKZ0-G(R)(V)M	<b>SVB-PKZ0-CI</b> 035129	3 off 	Product Standards UL 508; CSA-C22.2 No.14; IEC60947-4-1; CE marking
	–	–	E-PKZ0-G(R)	<b>SVB-PKZ0-E</b> 035127	3 off 	UL File No. UL CCN CSA File No. CSA Class No. NA Certification E36332 NLRV 12528 3211-05 UL Listed, CSA certified
	–	–	CI-K4-PKZ4-G(R)	<b>SVB-PKZ4-CI</b> 225526	1 off	
<b>Neutral terminal</b>						
<b>For connection of a 5th conductor</b>						
	Flexible, 1 - 4 mm <sup>2</sup>	–	CI-K2-PKZ0-...	<b>K-CI-K1/2</b> 207451	20 off 	UL/CSA certification not required
	63 A, flexible, 6 - 16 mm <sup>2</sup>	–	CI-K4-PKZ4-G(R)	<b>K25/1</b> 096200	10 off	
	–	–	E-PKZ0(-G)(-GR) E-PKZ01(-G)	<b>N-PKZ0</b> 082160	20 off	
<b>Units for insulated enclosures for PKZ01</b>						
<b>Combinable with CI-PKZ01-X and E-PKZ01-X.</b>						
	With operating membrane	Front IP65	PKZM01 +NHI-E or VHI-PKZ01 +U or A or NHI +L (2 off)	<b>CI/E-PKZ01-XG</b> 289936	1 off	
	Lockable in Off position	Front IP65	PKZM01 +NHI-E +U or A +L (2 off)	<b>CI/E-PKZ01-XSVB</b> 289939	1 off	
	With emergency switching off mushroom button, maintained	Front IP65	PKZM01 +NHI-E or VHI-PKZ01 +U or A +L (2 off)	<b>CI/E-PKZ01-XPVT</b> 289937	1 off	
	With emergency switching off mushroom button, with key-release	Front IP65	PKZM01 +NHI-E or VHI-PKZ01 +U or A +L (2 off)	<b>CI/E-PKZ01-XPVS</b> 289938	1 off	
	Lockable in Off position, in combination with VHI-PKZ01	Front IP65	PKZM01 VHI-PKZ01 +U or A +L (2 off)	<b>CI/E-PKZ01-XSVB-V</b> 289980	1 off	

# 1.3

## Motor-protective circuit-breakers PKZM01, PKZM0, PKZM4, PKE Accessories

1

### Accessories

**Metric cable glands to EN 50262**

- With lock nut and built-in strain relief
- IP68 up to 5 bar, halogen free

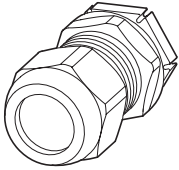

**Metric diaphragm grommets**



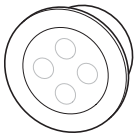

















- IP66
- With integral push-through diaphragm



Cable entry	Drilling dimensions mm	External cable diameter mm	Part no. Article no.	Price See price list	Std. pack
M20	20.5	6 - 13	<b>V-M20</b> 206910		20 off
M25	25.5	9 - 17	<b>V-M25</b> 206911		20 off
M32	32.5	13 - 21	<b>V-M32</b> 206912		10 off
M32	32.5	18 - 25	<b>V-M32G</b> 226156		10 off
M20	20.5	1 - 13	<b>KT-M20</b> 207602		100 off
M25	25.5	1 - 18	<b>KT-M25</b> 207603		100 off
M32	32.5	1 - 25	<b>KT-M32</b> 207604		100 off

**Door coupling handles**  
Degree of protection IP65, UL/CS Type 4X / Type12



	For use with	Color	Part no. Article no.	Price See price list	Std. pack	Notes
For use as main switch to IEC/EN 60204	PKZM0 PKZM4	Black	<b>PKZ0-XH<sup>1)</sup></b> 106132		1 off  	Pluggable PKZ0-XAH extension shaft, can be cut to any required length for installation depths of 100...240 mm. Follower included in delivery. With ON/OFF switch position and "+" (tripped), lockable. With 3 padlocks, 4 – 8 mm hasp. Cannot be used in combination with VH20-PKZ0.
For use as a main switch with emergency switching off function to EN 60204	PKZM0 PKZM4	Red-yellow	<b>PKZ0-XRH<sup>1)</sup></b> 106133		1 off  	
For use as a main switch to EN 60204 in MCC power distribution systems and with PKZM0 installed rotated by 90°	PKZM0 PKZM4	Black	<b>PKZ0-XH-MCC<sup>1)</sup></b> 106136		1 off  	
For use as a main switch with emergency switching off function to EN 60204 in MCC power distribution systems and with PKZM0 installed rotated by 90°	PKZM0 PKZM4	Red-yellow	<b>PKZ0-XRH-MCC<sup>1)</sup></b> 106137		1 off  	
For use as main switch to IEC/EN 60204	PKE	Black	<b>PKE-XH<sup>1)</sup></b> 142416		1 off  	Pluggable PKZ0-XAH extension shaft, can be cut to any required length for installation depths of 100...240 mm. Follower included in delivery. With ON/OFF switch position and "+" (tripped), lockable. With 3 padlocks, 4 – 8 mm hasp.
For use as a main switch with emergency switching off function to EN 60204	PKE	Red-yellow	<b>PKE-XRH<sup>1)</sup></b> 142417		1 off  	
For use as a main switch to EN 60204 in MCC power distribution systems and with PKE installed rotated by 90°	PKE	Black	<b>PKE-XH-MCC<sup>1)</sup></b> 142418		1 off  	
For use as a main switch with emergency-switching off function to EN 60204 in MCC power distribution systems and with PKE installed rotated by 90°	PKE	Red-yellow	<b>PKE-XRH-MCC<sup>1)</sup></b> 142419		1 off  	
For increasing the degree of protection of the PKZM4 to IP2X	PKZM4	–	<b>HB-PKZ4<sup>2)</sup></b> 256581		1 off  	Suitable for connecting cables with a max. external diameter of 9.5 mm
–	PKZM0 PKZM4	–	<b>PKZ0-XAH<sup>1)</sup></b> 106134		1 off  	Follower not included

**Information relevant for export to North America**  

<sup>1)</sup> Product Standards	UL 508; CSA-C22.2 No.14; IEC60947-4-1; CE marking
UL File No.	E36332
UL CCN	NLRV
CSA File No.	12528
CSA Class No.	3211-05
NA Certification	UL Listed, CSA certified
Degree of Protection	IEC: IP65, UL/CSA Type: 4X, 12

<sup>2)</sup> Product Standards	UL 508; CSA-C22.2 No.14; IEC60947-4-1; CE marking
UL File No.	E36332
UL CCN	NLRV
CSA File No.	12528
CSA Class No.	3211-05
NA Certification	UL Listed, CSA certified

## Accessories

**Telescopic adapters**  
With 45 mm top-hat rail to IEC/EN 60715 for compensation of the mounting depth of rear-mounted devices enclosures CI-K and cabinets

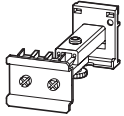

Notes	Part no. Article no.	Price See price list	Std. pack	Information relevant for export to North America 
Telescopic clip Stepless adjustment via scale from 75 – 115 mm.	<b>M22-TA</b> 226161		1 off 	Product Standards IEC/EN60947-5; UL 508; CSA-C22.2 No.14-05; CSA-C22.2 No.94-91; CE marking E29184 UL File No. UL CCN CSA File No. 012528 CSA Class No. 3211-03 NA Certification UL Listed, CSA certified

**Lockable rotary handle**



For locking motor-protective circuit-breakers PKZM0, PKZM4 and PKE as a main switch in compliance with EN 60204. Can be padlocked in the "0" position. Hasp thickness: 3 – 6.35 mm	Can not be combined with VHI-PKZ0.	<b>AK-PKZ0</b> 030851	5 off 	Product Standards UL 508; CSA-C22.2 No.14; IEC/EN 60947-4-1; CE marking E36332 UL File No. NLRV UL CCN CSA File No. 12528 CSA Class No. 3211-05 NA Certification UL Listed, CSA certified
---	------------------------------------	--------------------------	-----------	--

**Holding facility**

To prevent tampering with the overload release and the test function, it can be sealed using industry standard sealing wire For use with motor-protective circuit-breakers PKZM0 and PKZM4	–	<b>PL-PKZ0</b> 203599	5 off	
---	---	--------------------------	-------	--

**Mounting angle bracket**



For screw fixing to mounting plate	–	<b>PKE32-XMB</b> 134837	20 off 	Product Standards UL 508; CSA-C22.2 No.14; IEC/EN 60947-4-1; CE marking NA Certification Request filed for UL and CSA
------------------------------------	---	----------------------------	------------	--

**Documentation**

Motor-protective circuit-breakers PKZM0, overload monitoring of EEx e motors	German/English	<b>AWB1210-1458D/GB</b> 266164	1 off	
Motor-protective circuit-breakers PKZM4, overload monitoring of EEx e motors	German/English	<b>AWB1210-1457D/GB</b> 266165	1 off	
Motor-protective circuit-breakers PKE, EEx electric motor overload monitoring	German/English	<b>AWB1210-1631DE/EN</b> 134836	1 off	

**Indicator lights with glow lamp**



For use with Color Voltage	Color	Voltage $U_s$ V	Part no. Article no.	Price See price list	Std. pack
CI-K2-PKZ0-..., CI-K4-PKZ4, CI-PKZ0(1), E-PKZ0(1)	White	110 - 230	<b>L-PKZ0(230V)</b> 082151		10 off
CI-K2-PKZ0-..., CI-K4-PKZ4, CI-PKZ0(1), E-PKZ0(1)	White	230 - 400	<b>L-PKZ0(400V)</b> 082152		10 off
CI-K2-PKZ0-..., CI-K4-PKZ4, CI-PKZ0(1), E-PKZ0(1)	White	415 - 500	<b>L-PKZ0(500V)</b> 082153		5 off
CI-K2-PKZ0-..., CI-K4-PKZ4, CI-PKZ0(1), E-PKZ0(1)	Green	110 - 230	<b>L-PKZ0-GN(230V)</b> 082154		10 off
CI-K2-PKZ0-..., CI-K4-PKZ4, CI-PKZ0(1), E-PKZ0(1)	Green	230 - 400	<b>L-PKZ0-GN(400V)</b> 082155		10 off
CI-K2-PKZ0-..., CI-K4-PKZ4, CI-PKZ0(1), E-PKZ0(1)	Green	415 - 500	<b>L-PKZ0-GN(500V)</b> 082156		5 off
CI-K2-PKZ0-..., CI-K4-PKZ4, CI-PKZ0(1), E-PKZ0(1)	Red	110 - 230	<b>L-PKZ0-RT(230V)</b> 082157		10 off
CI-K2-PKZ0-..., CI-K4-PKZ4, CI-PKZ0(1), E-PKZ0(1)	Red	230 - 400	<b>L-PKZ0-RT(400V)</b> 082158		10 off

# 1.3











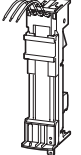

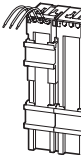
## Motor-protective circuit-breakers PKZM01, PKZM0, PKZM4, PKE

### Busbar adapters

#### Busbar adapters for PKZ and PKE

Approved to **UL508**.

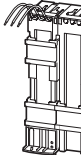
For fitting to flat copper busbars with 60mm between busbar centers, suitable for 5 mm and 10 mm busbar thickness.

Rated operational voltage $U_e$ V	Conductor cross-section	Adapter width mm	Mounting rails Number	For use with	Part no. Article no.	Price See price list	Std. pack	Notes			
<b>Rated operational current 16 A</b> <b>For starters with spring-loaded terminals</b> 	690	AWG 14 (2.5 mm <sup>2</sup> )	45	2	PKZM0-C + DILMC7 PKZM0-C + DILMC9 PKZM0-C + DILMC12	<b>BBA0C-16</b> 101455	4 off  	According to UL 508: $I_e = 12$ A			
	<b>Rated operational current 25 A</b> <b>For reversing starters</b> 	690	AWG 12 (4 mm <sup>2</sup> )	90	1	PKZM0, PKE + 2 x DILM7-01 PKZM0, PKE + 2 x DILM9-01 PKZM0, PKE + 2 x DILM12-01 MSC-R-0,25-M7... - MSC-R-12-M12...	<b>BBA0R-25</b> 101453	2 off  	In combination with individual components PKZM0 and DILM, use reversing starter kit PKZM0-XRM12. Fully assembled and tested combination with MSC-R → Chapter 1.4 (Page 18) Only busbar adapters/wiring sets manufactured on or after CW35/2009 can be used for PKE.		
		690	AWG 12 (4 mm <sup>2</sup> )	45	2	–	<b>BBA0-25/2TS</b> 101481	4 off  	Mounting rails can be moved within 1.25 mm grid.		
		<b>For DOL starters</b> 	690	AWG 12 (4 mm <sup>2</sup> )	45	1	PKZM0, PKE + 2 x DILM17-01 PKZM0, PKE + 2 x DILM25-01 PKZM0, PKE + 2 x DILM25-01 PKZM0, PKE + 2 x DILM32-01 MSC-R-16-M17... MSC-R-32-M32...	<b>BBA0-25</b> 101451	4 off  	In combination with individual components PKZM0 and DILM, use DOL starter kit PKZM0-XRM12. Fully assembled and tested combination with MSC-D → Chapter 1.4 (Page 2) Only busbar adapters/wiring sets manufactured on or after CW35/2009 can be used for PKE.	
			<b>For soft starters</b> 	690	AWG 12 (4 mm <sup>2</sup> )	45	1	PKZM0, PKE + DS7...004N... PKZM0, PKE + DS7...007N... PKZM0, PKE + DS7...009N... PKZM0, PKE + DS7...012N...	<b>BBA0L-25</b> 142526	1 off	–
				<b>Rated operational current 32 A</b> <b>For reversing starters</b> 	690	AWG 10 (6 mm <sup>2</sup> )	90	3	PKZM0, PKE + 2 x DILM17-01 PKZM0, PKE + 2 x DILM25-01 PKZM0, PKE + 2 x DILM32-01 MSC-R-16-M17... - MSC-R-32-M32...	<b>BBA0R-32</b> 101454	2 off  

#### Information relevant for export to North America



#### Product Standards

UL File No.  
UL CCN











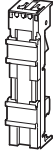

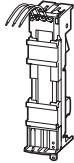
UL 508A; CSA-C22.2 No. 14;  
IEC60439-1; CE marking  
UL File No.E300273  
NMTR, NMTRZ

#### CSA File No.

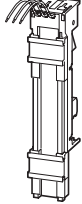
CSA Class No.  
NA Certification  
Max. Voltage Rating

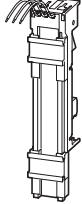
232140

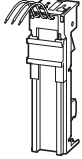
3211-37  
UL Listed, CSA certified  
600 V AC

	Rated operational voltage $U_e$ V	Conductor cross-section	Adapter width mm	Mounting rails Number	For use with	Part no. Article no.	Price See price list	Std. pack	Notes
<b>Rated operational current 32 A</b> <b>Can be used universally.</b> 	690	–	45	2	PKZM0..., PKE + DILM...	<b>BBA0-32/2TS-C<sup>2)</sup></b> 116708		4 off  	Universal adapter 1-, 2- and 3-phase applications. Mounting rail can be moved within 1.25 mm grid. For conductor cross-sections, round conductors of up to 6 mm <sup>2</sup> . Only busbaradapters/wiring sets manufactured on or after CW 35/2009 can be used for PKE.
<b>For DOL starters.</b> 	690	AWG 10 (6 mm <sup>2</sup> )	45	2	PKZM0, PKE + DILM17 PKZM0, PKE + DILM25 PKZM0, PKE + DILM32 MSC-D-16-M17... - MSC-D-32-M32...	<b>BBA0-32<sup>1)</sup></b> 101452		4 off  	In combination with individual components PKZM0 and DILM wiring kit PKZM0-XM32DE can be used. Fully assembled and tested combination with MSC-D → Chapter 1.4 (Page 2) Only busbar adapters/wiring sets manufactured on or after CW35/2009 can be used for PKE.
<b>For soft starters</b> 	690	AWG 10 (6 mm <sup>2</sup> )	45	2	PKZM0, PKE + DS7...016N... PKZM0, PKE + DS7...024N... PKZM0, PKE + DS7...032N...	<b>BBA0L-32</b> 142527		1 off	–
<b>For 160 mm adapter system with motor-protective circuit-breakers</b> 	690	AWG 10 (6 mm <sup>2</sup> )	45	1	PKZM0, PKE	<b>BBA0K-32</b> 142528		1 off	–
<b>Rated operational current 63 A</b> <b>For DOL starters.</b> 	690	AWG 8 (10 mm <sup>2</sup> )	55	2	PKZM4 + DILM17 PKZM4 + DILM25 PKZM4 + DILM32 PKZM4 + DILM40 PKZM4 + DILM50 PKZM4 + DILM65	<b>BBA4-63<sup>1)</sup></b> 101459		4 off  	The following can be used to establish an electrical connection: For PKZM4 + DILM17 to DILM32: MVS-LB0-0M-G For PKZM4 + DILM40 to DILM65: PKZM4-XM65DE.
<b>For motor-protective circuit-breakers</b> 	690	AWG 8 (10 mm <sup>2</sup> )	54	1	PKZM4	<b>BBA4-63<sup>1)</sup></b> 101457		4 off  	–

**Information relevant for export to North America**



1)  
 Product Standards UL 508; CSA-C22.2 No.14; IEC60439-1; CE marking  
 UL File No. E300273  
 UL CCN NMTR, NMTR7  
 CSA File No. 232140  
 CSA Class No. 3211-37  
 NA Certification UL Listed, CSA certified  
 Max. Voltage Rating 600 V AC

2)  
 Product Standards UL 508; CSA-C22.2 No.14; IEC60439-1; CE marking  
 UL File No. E300273  
 UL CCN NMTR, NMTR7  
 NA Certification UL Listed, CSA certified  
 Max. Voltage Rating 600 V AC













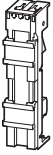





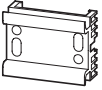

# 1.3

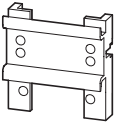
## Motor-protective circuit-breakers PKZM01, PKZM0, PKZM4, PKE

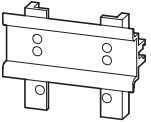
### Busbar adapters

1

#### BBA, PKZM0-XM

	Rated operational voltage $U_e$ V	Conductor cross-section	Adapter width mm	Mounting rails Number	For use with	Part no. Article no.	Price See price list	Std. pack	Notes
<b>Without electrical contacts Empty module.</b> 	–	–	45	2	–	<b>BBA0/ZTS-L<sup>1)</sup></b> 101482		4 off  	Mounting rails can be moved within a 1.25 mm grid. Can be used to mount reversing and star-delta starters.
	–	–	54	2	–	<b>BBA4/ZTS-L<sup>1)</sup></b> 101483		4 off  	Mounting rails can be moved within a 1.25 mm grid. Can be used to mount reversing and star-delta starters.
<b>Side-mounted module, can be attached on both sides.</b> 	–	–	9	–	–	<b>BBA-XSM<sup>1)</sup></b> 101484		10 off  	Can be grouped with busbar adapters in order to extend the mounting width.
<b>Busbar adapters accessories Mounting rails</b> 	–	–	45	–	BBA...	<b>PKZM0-XMR<sup>2)</sup></b> 239364		10 off  	–
<b>Busbar adapters accessories Mounting rails</b> 	–	–	54	–	BBA...	<b>PKZM0-XMR54<sup>2)</sup></b> 113911		10 off  	–
<b>Busbar adapters accessories Mounting rails</b> 	–	–	72	–	BBA...	<b>PKZM0-XMR72<sup>2)</sup></b> 113912		10 off  	–
<b>Connecting cable</b> –	–	–	–	–	BBA...	<b>BBA-XLT-6-130<sup>3)</sup></b> 116902		30 off  	–
	–	–	–	–	BBA...	<b>BBA-XLT-16-142<sup>3)</sup></b> 116903		30 off  	–

#### Information relevant for export to North America



1)  
 Product Standards UL 508A; CSA-C22.2 No.14; IEC60439-1; CE marking  
 UL File No. E300273  
 UL CCN NMTR, NMTR7  
 CSA File No. 232140  
 CSA Class No. 3211-37  
 NA Certification UL Listed, CSA certified  
 Max. Voltage Rating 600 V AC

2)  
 Product Standards UL 508A; CSA-C22.2 No.14; IEC60947-4-1; CE marking  
 UL File No. E300273  
 UL CCN NMTR, NMTR7  
 CSA File No. 232140  
 CSA Class No. 3211-37  
 NA Certification UL Listed, CSA certified

3)  
 Product Standards UL 508A; CSA-C22.2 No.14; IEC60439-1; CE marking  
 UL File No. On request  
 UL CCN On request  
 CSA File No. On request  
 CSA Class No. On request  
 NA Certification UL Recognized, CSA certified

### Wiring set

For use with

**Part no.**  
Article no.

**Price**  
See price list

Std. pack

**Notes**

1

#### DOL starter

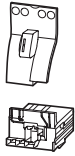

PKZM0, PKE + DILM7  
PKZM0, PKE + DILM9  
PKZM0, PKE + DILM12  
PKZM0, PKE + DILM15  
DS7-34...SX004...  
DS7-34...SX007...  
DS7-34...SX009...  
DS7-34...SX012...

**PKZM0-XDM12**  
283149

1 off

Consists of:

- Mechanical connection element for PKZM0 and contactor
- Main supply wiring between PKZM0 and contactor with tool-less plug connection
- Cable routing

As auxiliary contact, use DILA-XHIT... → Chapter 1.1 (Page 38)  
Cannot be combined with NHI-E...PKZ0-C.  
 $U_e \leq 415 \text{ V}^{1)}$

#### DOL starter

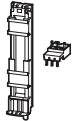

PKZM0, PKE + DILM17  
PKZM0, PKE + DILM25  
PKZM0, PKE + DILM32

**PKZM0-XDM32**  
283153

1 off

Consists of:

- Top-hat rail adapter plates
- Power supply wiring between PKZ and contactor<sup>1)</sup>

PKZM4 + DILM40  
PKZM4 + DILM50  
PKZM4 + DILM65

**PKZM4-XDM65**  
101053

1 off

#### Reversing starters

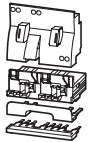

PKZM0, PKE + DILM7-01  
PKZM0, PKE + DILM9-01  
PKZM0, PKE + DILM12-01

**PKZM0-XRM12**  
283185

1 off

Consists of:

- Mechanical connection element for PKZM0 and contactor
- Reversing starters main supply wiring with tool-less plug connection
- Control cables for electrical interlocking in tool-less plug connection:
  - K1M: A1 -K2M: 21
  - K1M: 21 -K2M: A1
  - K1M: A2 -K2M: A2
- Cable routing

As auxiliary contact DILA-XHIT...use → Chapter 1.1 (Page 38)  
Can not be combined with AGM PKZ0.  
 $U_e \leq 415 \text{ V}^{1)}$

#### Reversing starters

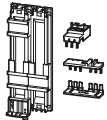

PKZM0, PKE + DILM17  
PKZM0, PKE + DILM25  
PKZM0, PKE + DILM32

**PKZM0-XRM32**  
283189

1 off

Consists of:

- Top-hat rail adapter plates
- Reversing starters supply wiring<sup>1)</sup>

#### Wiring kit



PKZM0, PKE + DILM17  
PKZM0, PKE + DILM25  
PKZM0, PKE + DILM32  
DS7-34...SX016...  
DS7-34...SX024...  
DS7-34...SX032...

**PKZM0-XM32DE**  
239349

5 off

• Main supply wiring between PKZM0 and contactor  
• Use only in combination with busbar adapter or mounting rail adapter plate

PKZM4 + DILM40  
PKZM4 + DILM50  
PKZM4 + DILM65

**PKZM4-XM65DE**  
101056

5 off

• Main current supply between PKZM4 and contactor

#### Top-hat rail adapter plates



PKZM0-XDM12  
PKZM0-XRM12

**PKZM0-XC45**  
283132

4 off

Consists of:

- 45 mm wide adapter plate
- Connection element for side-by-side positioning of further plates<sup>1)</sup>

#### Top-hat rail adapter plates

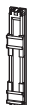

PKZM4 + DILM40  
PKZM4 + DILM50  
PKZM4 + DILM65

**PKZM4-XC55/2**  
101054

4 off

Consists of:

- 55 mm wide adapter plate
- Connection cam for additional plates<sup>1)</sup>
- For use with reversing and start-delta starters

#### Soft starters



PKZM0, PKE + DS7...004N...  
PKZM0, PKE + DS7...007N...  
PKZM0, PKE + DS7...009N...  
PKZM0, PKE + DS7...012N...

**PKZM0-XC45L**  
142529

1 off

Consists of:

- 45 mm wide adapter plate

#### Soft starters

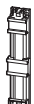

PKZM0, PKE + DS7...016N...  
PKZM0, PKE + DS7...024N...  
PKZM0, PKE + DS7...032N...

**PKZM0-XC45L/2**  
142570

1 off

Consists of:

- 45 mm wide adapter plate

#### Notes

<sup>1)</sup> Use only busbar adapters/wiring sets manufactured on or after CW35/2009 for PKE.

#### Information relevant for export to North America



<sup>2)</sup>  
Product Standards UL 508; CSA-C22.2 No.14; IEC60947-4-1;  
CE marking  
UL File No. E36332  
UL CCN NLRV  
CSA File No. 12528  
CSA Class No. 3211-05  
NA Certification UL Listed, CSA certified

<sup>3)</sup>  
UL/CSA certification not required

<sup>4)</sup>  
Product Standards UL 508; CSA-C22.2 No.14;  
IEC60947-4-1; CE marking  
UL File No. E300273  
UL CCN NMTR, NMTR7  
NA Certification UL Listed, CSA certified  
Max. Voltage Rating 600 V AC

# 1.3

## Motor-protective circuit-breakers PKZM01, PKZM0, PKZM4, PKE

Motor feeder plugs, three-phase commoning links

1

Description	For use with	Part no. Article no.	Price See price list	Std. pack	Notes	Information relevant for export to North America 
<b>PE module with contact plate</b>						
DILM(C)7 DILM(C)9 DILM(C)12 DILM(C)15		<b>DILM12-XMCE</b> 121764		5 off 	35 x 7.5 (15) mm mounting rail (as per DIN EN 60715) with PE function required. For connection of: PE 0.75 – 4 mm <sup>2</sup>	Product Standards UL 508; CSA-C22.2 No. 14; IEC60947-4-1; CE marking NA Certification Request filed for UL and CSA
<b>Motor feeder plug with PE module and contact plate</b>						
DILM(C)7 DILM(C)9 DILM(C)12 DILM(C)15		<b>DILM12-XMCP/E</b> 121769		1 off 	35 x 7.5 (15) mm mounting rail (as per DIN EN 60715) with PE function required. For connection of: L1, L2, L3, PE 0.75 – 2.5 mm <sup>2</sup>	Product Standards IEC/EN 60947-4-1; UL 508; CSA-C22.2 No. 14-05; CE marking NA Certification Request filed for UL and CSA
<b>Motor feeder plug with PE module without contact plate</b>						
PKZM0/PKE + DILM(C)7 PKZM0/PKE + DILM(C)9 PKZM0/PKE + DILM(C)12 PKZM0/PKE + DILM(C)15 MSC-D(E)-...-M7... MSC-D(E)-...-M9... MSC-D(E)-...-M15...		<b>DILM12-XMCP/T</b> 121770		1 off 	For connection of: L1, L2, L3, PE 0.75 – 2.5 mm <sup>2</sup>	Product Standards IEC/EN 60947-4-1; UL 508; CSA-C22.2 No. 14-05; CE marking NA Certification Request filed for UL and CSA

### Three-phase commoning links, incoming unit via terminals 1, 3, and 5

Finger- and back-of-hand-proof, short-circuit proof,  $U_e=690\text{ V}$ ,  $I_n=63\text{ A}$   
Can be extended through rotated installation

Circuit-breakers Number	Length mm	Unit width mm	Part no. Article no.	Price See price list	Std. pack	Notes
<b>For PKZM0-... or PKE without side-mounted auxiliary contacts or voltage releases</b>						
	2	90	45	<b>B3.0/2-PKZ0<sup>1)</sup></b> 063961	10 off 	For parallel feeding of multiple motor-protective circuit-breakers on terminals 1, 3, and 5
	3	135	45	<b>B3.0/3-PKZ0<sup>1)</sup></b> 232289	10 off 	
	4	180	45	<b>B3.0/4-PKZ0<sup>1)</sup></b> 063960	10 off 	
	5	225	45	<b>B3.0/5-PKZ0<sup>1)</sup></b> 232290	10 off 	
<b>For motor-protective circuit-breakers with one auxiliary contact or trip-indicating auxiliary contact each fitted to right side</b>						
	2	99	45 + 9	<b>B3.1/2-PKZ0<sup>1)</sup></b> 044945	10 off 	For parallel feeding of multiple motor-protective circuit-breakers on terminals 1, 3, and 5
	3	153	45 + 9	<b>B3.1/3-PKZ0<sup>1)</sup></b> 044946	10 off 	
	4	207	45 + 9	<b>B3.1/4-PKZ0<sup>1)</sup></b> 044947	10 off 	
	5	261	45 + 9	<b>B3.1/5-PKZ0<sup>1)</sup></b> 044948	10 off 	
<b>For PKZM0-... or PKE with one auxiliary contact or trip-indicating auxiliary contact each fitted to right side, or one voltage release fitted on left side</b>						
	2	108	45 + 18	<b>B3.2/2-PKZ0<sup>1)</sup></b> 063963	10 off 	For parallel feeding of multiple motor-protective circuit-breakers on terminals 1, 3, and 5
	4	234	45 + 18	<b>B3.2/4-PKZ0<sup>1)</sup></b> 063959	10 off 	

#### Information relevant for export to North America



1)  
Product Standards  
UL File No.  
UL CCN  
CSA File No.  
CSA Class No.  
NA Certification

UL 508A; CSA-C22.2 No.14; IEC60947-4-1; CE marking  
E36332  
NLRV  
98494  
3211-06  
UL Listed, CSA certified

## HB3...PKZO, BK...I3-PKZ

Circuit-breakers	For use with	Unit width	Part no. Article no.	Price See price list	Std. pack	Notes
------------------	--------------	------------	-------------------------	-------------------------	-----------	-------

Number	mm
--------	----



### Shroud for unused terminals

Protection against direct contact.

For covering unused terminals on three-phase commoning link B3...-PKZO

-	-	-	<b>H-B3-PKZO<sup>1)</sup></b> 032721		20 off 	-
---	---	---	---	--	------------	---

### Incoming terminals

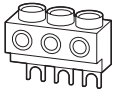

-	PKZM0 PKE	-	<b>BK25/3-PKZO<sup>2)</sup></b> 032720		5 off 	For three-phase commoning link, protected against accidental contact, $U_e = 690\text{ V}$ , $I_u = 63\text{ A}$ For conductor cross-sections: 2.5 - 25 mm <sup>2</sup> stranded 2.5 - 16 mm <sup>2</sup> flexible with ferrule AWG 14 - 6, usable on terminals 1, 3, and 5
---	--------------	---	---	--	-----------	---

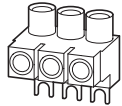

-	PKZM0	-	<b>BK25/3-PKZO-E<sup>3)</sup></b> 262518		5 off 	For three-phase commoning link, protected against accidental contact, $U_e = 690\text{ V}$ , $I_u = 60\text{ A}$ For conductor cross-sections: 2.5 - 25 mm <sup>2</sup> stranded 2.5 - 16 mm <sup>2</sup> flexible with ferrule AWG 14 - 6 For assembly of Type E starters.
---	-------	---	---	--	-----------	--



-	PKZM4	-	<b>BK50/3-PKZ4-E<sup>4)</sup></b> 272165		1 off 	Can be combined with three-phase commoning link B3...PKZ4. $I_u = 120\text{ A}$ . For assembly of Type E starters.
---	-------	---	---	--	-----------	--

### Information relevant for export to North America



1)

Product Standards	UL 508; CSA-C22.2 No.14; IEC60947-4-1; CE marking
UL File No.	E36332
UL CCN	NLRV
CSA File No.	98494
CSA Class No.	3211-06
NA Certification	UL Listed, CSA certified

2)

Product Standards	UL 508; CSA-C22.2 No.14; IEC60947-4-1; CE marking
UL File No.	E36332
UL CCN	NLRV
CSA File No.	12528
CSA Class No.	3211-05
NA Certification	UL Listed, CSA certified

3)

Product Standards	UL 508; CSA-C22.2 No.14; IEC60947-4-1; CE marking
UL File No.	E36332
UL CCN	NLRV
CSA File No.	98494
CSA Class No.	3211-06
NA Certification	UL Listed, CSA certified
Specially designed for NA Suitable for	✓ PKZM0/PKE, line terminal required for Type E/F applications

4)

Product Standards	UL 508; CSA-C22.2 No.14; IEC60947-4-1; CE marking
UL File No.	E36332
UL CCN	NLRV
CSA File No.	12528
CSA Class No.	3211-06
NA Certification	UL Listed, CSA certified
Specially designed for NA Suitable for	✓ PKZM4/PKE, line terminal required for Type E/F applications

# 1.3

## Motor-protective circuit-breakers PKZM01, PKZM0, PKZM4, PKE Three-phase commoning links

1

### Three-phase commoning links

Finger- and back-of-hand-proof, short-circuit proof  $U_p=690\text{ V}$ ,  $I_p=128\text{ A}$

Circuit-breakers	Length	Unit width	Part no.	Price	Std. pack
Number	mm	mm	Article no.	See price list	

Information relevant for export to North America



#### For PKZM4 without side-mounted auxiliary contacts or voltage releases

2	110	55	<b>B3.0/2-PKZ4</b> 220220	1 off	
3	165	55	<b>B3.0/3-PKZ4</b> 220221	1 off	
4	220	55	<b>B3.0/4-PKZ4</b> 220222	1 off	

Product Standards UL 508; CSA-C22.2 No.14; IEC60947-4-1; CE marking  
UL File No. E36332  
UL CCN NLRV  
CSA File No. 12528  
CSA Class No. 3211-06  
NA Certification UL Listed, CSA certified

#### For PKZM4 with one auxiliary contact or trip-indicating auxiliary contact each fitted on the right side

2	119	55 + 9	<b>B3.1/2-PKZ4</b> 220223	1 off	
3	183	55 + 9	<b>B3.1/3-PKZ4</b> 220224	1 off	
4	247	55 + 9	<b>B3.1/4-PKZ4</b> 220225	1 off	

#### For PKZM4 with one auxiliary contact or trip-indicating auxiliary contact each fitted to right side, or one voltage release fitted to left side

2	128	55 + 18	<b>B3.2/2-PKZ4</b> 220226	1 off	
4	274	55 + 18	<b>B3.2/4-PKZ4</b> 220227	1 off	

### Shroud for unused terminals

Protection against direct contact.  
To cover unused terminals on three-phase commoning link

Circuit-breakers	Length	Unit width	Part no.	Price	Std. pack
Number	mm	mm	Article no.	See price list	

Information relevant for export to North America







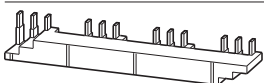
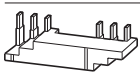
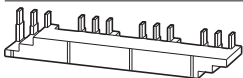
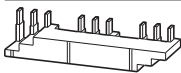
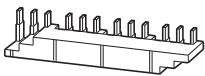
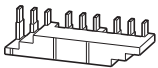



















































–	–	–	<b>H-B3-PKZ4</b> 220228	10 off	
---	---	---	----------------------------	--------	--

Product Standards UL 508; CSA-C22.2 No.14; IEC60947-4-1; CE marking  
UL File No. E36332  
UL CCN NLRV  
CSA File No. 12528  
CSA Class No. 3211-06  
NA Certification UL Listed, CSA certified



## A-PKZO, U-PKZO

Actuating voltage	Part no. Article no.	Price See price list	Std. pack	Part no. Article no.	Price See price list	Std. pack	Notes
<b>Shunt release, undervoltage release</b>							
AC							
Standard voltage							
24 V 50 Hz	<b>A-PKZO(24V50Hz)<sup>1)</sup></b> 073181		2 off  	<b>U-PKZO(24V50Hz)<sup>1)</sup></b> 073129		2 off  	
110 V 50 Hz	<b>A-PKZO(110V50Hz)<sup>1)</sup></b> 073184		2 off  	<b>U-PKZO(110V50Hz)<sup>1)</sup></b> 073132		2 off  	
220 V 50 Hz	<b>A-PKZO(220V50Hz)<sup>1)</sup></b> 073186		2 off  	<b>U-PKZO(220V50Hz)<sup>1)</sup></b> 073134		2 off  	
230 V 50 Hz	<b>A-PKZO(230V50Hz)<sup>1)</sup></b> 073187		2 off  	<b>U-PKZO(230V50Hz)<sup>1)</sup></b> 073135		2 off  	Only A(U)-PKZO... with serial number 02 or higher can be fitted
240 V 50 Hz	<b>A-PKZO(240V50Hz)<sup>1)</sup></b> 073188		2 off  	<b>U-PKZO(240V50Hz)<sup>1)</sup></b> 073136		2 off  	
380 V 50 Hz	<b>A-PKZO(380V50Hz)<sup>1)</sup></b> 073189		2 off  	<b>U-PKZO(380V50Hz)<sup>1)</sup></b> 073137		2 off  	
400 V 50 Hz	<b>A-PKZO(400V50Hz)<sup>1)</sup></b> 073190		2 off  	<b>U-PKZO(400V50Hz)<sup>1)</sup></b> 073138		2 off  	
415 V 50 Hz	<b>A-PKZO(415V50Hz)<sup>1)</sup></b> 073191		2 off  	<b>U-PKZO(415V50Hz)<sup>1)</sup></b> 073139		2 off  	
120 V 60 Hz	<b>A-PKZO(120V60Hz)<sup>1)</sup></b> 073195		2 off  	<b>U-PKZO(120V60Hz)<sup>1)</sup></b> 073143		2 off  	
240 V 60 Hz	<b>A-PKZO(240V60Hz)<sup>1)</sup></b> 073198		2 off  	<b>U-PKZO(240V60Hz)<sup>1)</sup></b> 073146		2 off  	
440 V 60 Hz	<b>A-PKZO(440V60Hz)<sup>1)</sup></b> 082164		2 off  	<b>U-PKZO(440V60Hz)<sup>1)</sup></b> 082161		2 off  	
480 V 60 Hz	<b>A-PKZO(480V60Hz)<sup>1)</sup></b> 073199		2 off  	<b>U-PKZO(480V60Hz)<sup>1)</sup></b> 073147		2 off  	
Non-standard voltages not covered by above standard voltages							
... V 50 Hz (24 - 500 V)	<b>A-PKZO(*V50Hz)<sup>1)</sup></b> 982165		2 off  	<b>U-PKZO(*V50Hz)</b> 982162			The part number for ordering consists of the basic part number and the actuating voltage. For non-standard voltages, specify the required actuating voltage within the indicated range (... - ... V). Minimum order quantity is 10 units
... V 60 Hz (24 - 600 V)	<b>A-PKZO(*V60Hz)<sup>1)</sup></b> 982166		2 off  	<b>U-PKZO(*V60Hz)</b> 982163			
DC							
Standard voltage							
24 V DC	<b>A-PKZO(24VDC)<sup>1)</sup></b> 073200		2 off  				PKE can be fitted only with A(U)-PKZO... with serial number 02 or higher.
110 V DC	<b>A-PKZO(110VDC)<sup>1)</sup></b> 073203		2 off  				

### Information relevant for export to North America



1)  
 Product Standards UL 508; CSA-C22.2 No.14; IEC60947-4-1; CE marking  
 UL File No. E36332  
 UL CCN NLRV  
 CSA File No. 12528  
 CSA Class No. 3211-05  
 NA Certification UL Listed, CSA certified

# 1.3 Motor-protective circuit-breakers PKZM01, PKZM0, PKZM4, PKE

## 1 Engineering

### 1- and 2-pole-connected PKZM0, PKZM4 with AC and DC



### 2-pole-connected PKZM0(1) and PKZM4 with CL-PKZ0

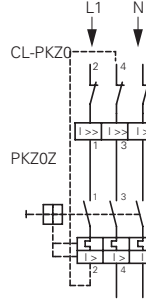

### Protection of PVC-insulated cables against thermal overload on short-circuits

The table specifies which minimum conductor cross-sections are protected by motor-protective circuit-breaker PKZ(M) up to their rated conditional short-circuit current  $I_q$ .

Min. cross-section protected 380 – 415 V, 50 Hz, Cu mm <sup>2</sup>	Device Part no.
4	PKZM0-0,16
2.5	PKZM0-6.3
1.5	PKZM0-10
1	PKZM0-12
0.75	PKZM0-16
	PKZM0-20
	PKZM0-25
	PKZM0-32
	PKZM4-16
	PKZM4-25
	PKZM4-32
	PKZM4-40
	PKZM4-50
	PKZM4-58
	PKZM4-63

### PKZM0-...T tripping characteristics (not for PKM0-...), PKZM01

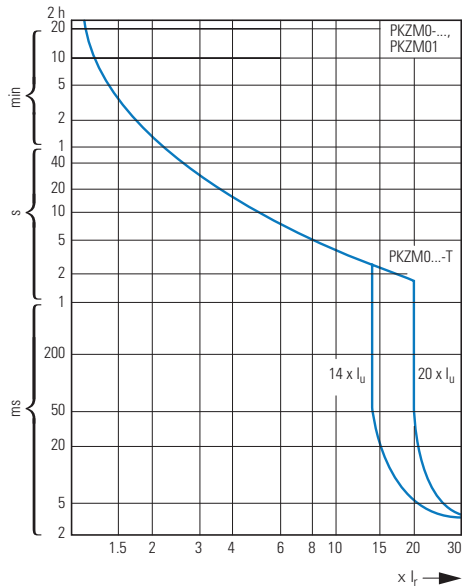

Tripping characteristic curves, wide-range circuit-breaker PKE

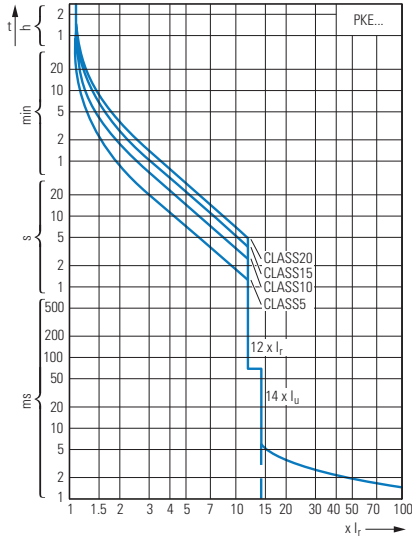

Let-through characteristics, motor-protective circuit-breaker, transformer-protective circuit-breakers, circuit-breaker for starter combinations

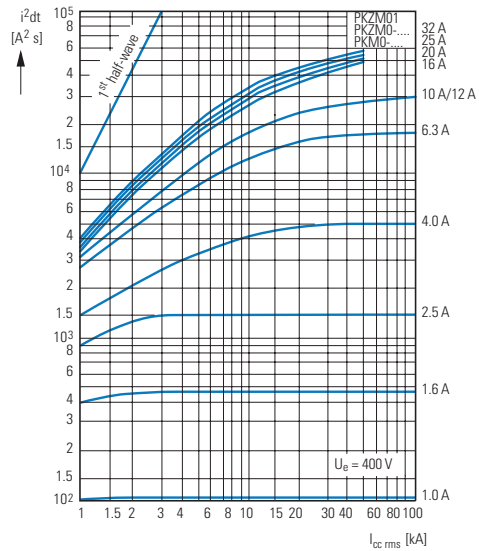
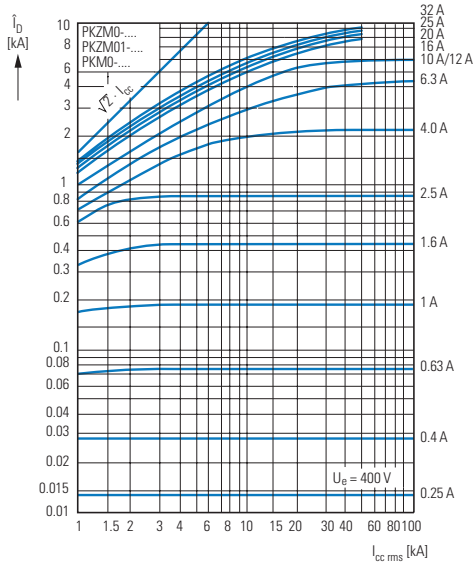

Motor-protective circuit-breaker let-through characteristics

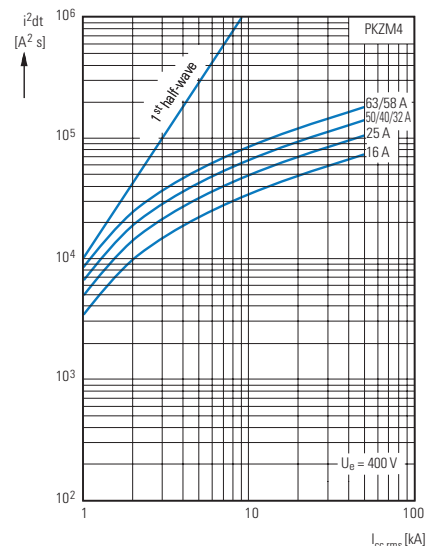



# 1.3

## Motor-protective circuit-breakers PKZM01, PKZM0, PKZM4, PKE

Switching capacity

### Circuit-breaker switching capacity from serial no. 04

1

Rated uninterrupted current  $I_u$

Rated conditional short-circuit current  $I_q$  IEC/EN 60947-4-1

Rated ultimate short-circuit breaking capacity  $I_{cu}$   
 Rated breaking capacity  $I_{cs}$  } IEC/EN 60947-2

	230 V				400 V				440 V				500 V				690 V			
$I_u$ A	$I_q$ kA	$I_{cu}$ kA	$I_{cs}$ kA	A <sup>1)</sup>	$I_q$ kA	$I_{cu}$ kA	$I_{cs}$ kA	A <sup>1)</sup>	$I_q$ kA	$I_{cu}$ kA	$I_{cs}$ kA	A <sup>1)</sup>	$I_q$ kA	$I_{cu}$ kA	$I_{cs}$ kA	A <sup>1)</sup>	$I_q$ kA	$I_{cu}$ kA	$I_{cs}$ kA	A <sup>1)</sup>

#### PKZM0, PKZM0...-T, PKM0 with type "1" and "2" coordination

0.16 – 1	150	150	150	N	150	150	150	N				N				N				N
1.6	150	150	150	N	150	150	150	N				N				N				N
2.5	150	150	150	N	150	150	150	N				N				N	5	5	5	50
4	150	150	150	N	150	150	150	N				N				N	3	3	3	50
6.3	150	150	150	N	150	150	150	N				N	42	42	11	50	3	3	2	50
10	150	150	150	N	150	150	150	N	42	42	12	50	42	42	11	50	3	3	2	50
12	50	50	13	50	50	50	13	50	15	15	12	50	15	15	8	50	3	3	2	50
16	50	50	13	50	50	50	13	50	15	15	12	50	15	15	8	50	3	3	2	50
20	50	50	13	50	50	50	13	50	10	10	13	50	6	6	3	50	3	3	1	50
25	50	50	13	50	50	50	13	50	10	10	13	50	6	6	3	50	3	3	1	50
32	50	50	13	50	50	50	13	50	10	10	13	50	6	6	3	50	3	3	1	50

#### PKZM0 (PKZM0...-T, PKM0) + CL-PKZ0

0.16 – 1				N				N				N				N				20	N
1.6				N				N				N				N				20	N
2.5				N				N				N				N	20	20	20	20	N
4				N				N				N				N	20	20	20	20	N
6.3				N				N				N			50	N	20	20	20	20	N
10				N				N				N			20	N	20	20	20	20	N
12				N				N				N			20	N	5	5	2.5	2.5	N
16				N				N				N			20	N	5	5	2.5	2.5	N
20				N				N				N	10	10	10	N	5	5	2.5	2.5	N
25				N				N				N	10	10	10	N	5	5	2.5	2.5	N
32				N				N				N	10	10	10	N	5	5	2.5	2.5	N

#### PKZM0 (PKZM0...-T, PKM0) + 2 CL-PKZ0

0.16 – 1				N				N				N				N				20	N
1.6				N				N				N				N				20	N
2.5				N				N				N				N	40	40	20	20	N
4				N				N				N				N	40	40	20	20	N
6.3				N				N				N			50	N	20	20	20	20	N
10				N				N				N			40	N	20	20	20	20	N
12				N				N				N			40	N	10	10	2.5	2.5	N
16				N				N				N			40	N	10	10	2.5	2.5	N
20				N				N				N	20	20	20	N	10	10	2.5	2.5	N
25				N				N				N	20	20	20	N	10	10	2.5	2.5	N
32				N				N				N	20	20	20	N	10	10	2.5	2.5	N

**Notes**   No upstream protective device required, as it is the auto-protected range (100/150 kA)

<sup>1)</sup> Required back-up fuse if the short-circuit current exceeds the device's rated conditional short-circuit current ( $I_{cc} > I_q$ ).

N Not necessary

## Circuit-breaker switching capacity

Rated uninterrupted current  $I_u$

Rated conditional short-circuit current  $I_q$  IEC/EN 60947-4-1

Rated maximum short-circuit breaking capacity  $I_{cu}$   
 Rated breaking capacity  $I_{cs}$  } IEC/EN 60947-2

$I_u$ A	230 V				400 V				440 V <sup>2)</sup>				500 V <sup>2)</sup>				690 V <sup>2)</sup>			
	$I_q$ kA	$I_{cu}$ kA	$I_{cs}$ kA	A <sup>1)</sup>	$I_q$ kA	$I_{cu}$ kA	$I_{cs}$ kA	A <sup>1)</sup>	$I_q$ kA	$I_{cu}$ kA	$I_{cs}$ kA	A <sup>1)</sup>	$I_q$ kA	$I_{cu}$ kA	$I_{cs}$ kA	A <sup>1)</sup>	$I_q$ kA	$I_{cu}$ kA	$I_{cs}$ kA	A <sup>1)</sup>
<b>PKZM01 with type "1" and "2" coordination</b>																				
0.16 – 1	50	50	50	50	50	50	50	50	50	50	50	50	50	50	50	50	50	50	50	50
1.6	50	50	50	50	50	50	50	50	50	50	50	50	50	50	50	50	50	50	50	50
2.5	50	50	50	50	50	50	50	50	50	50	50	50	50	50	50	50	50	50	50	50
4	50	50	50	50	50	50	50	50	50	50	50	50	50	50	50	50	50	50	50	50
6.3	50	50	50	50	50	50	50	50	50	50	50	50	50	50	50	50	50	50	50	50
10	50	50	50	50	50	50	50	50	42	42	10	50	50	50	50	50	50	50	50	50
12	50	50	10	50	50	50	10	50	15	15	10	50	50	50	50	50	50	50	50	50
16	50	50	10	50	50	50	10	50	15	15	10	50	50	50	50	50	50	50	50	50
20, 25	50	50	10	50	50	50	10	50	10	10	3	50	50	50	50	50	50	50	50	50
<b>PKZM4 with type "1" and "2" coordination</b>																				
16	150	150	25	N	150	150	25	N	45	45	25	100	15	15	100	8	8	2.5	100	
25	150	150	25	N	150	150	25	N	45	45	25	100	15	15	100	8	8	2.5	100	
32	50	50	25	100	50	50	25	100	45	45	25	100	15	15	100	5	5	2.5	100	
40	50	50	25	100	50	50	25	100	45	45	25	100	15	15	100	5	5	2.5	100	
50	50	50	25	100	50	50	25	100	45	45	25	100	15	15	100	5	5	2.5	100	
58	50	50	25	160	50	50	25	160	45	45	25	160	15	15	160	5	5	2.5	160	
63	50	50	25	160	50	50	25	160	45	45	25	160	15	15	160	5	5	2.5	160	
<b>PKE12...<sup>2)</sup> with type of coordination „1“ and</b>																				
0.3 - 1.2	100			50	100			50	50			50	10			50	3			50
1 - 4	100			50	100			50	50			50	10			50	3			50
3 - 12	100			50	100			50	15			50	10			50	3			50
<b>PKE32...<sup>2)</sup> with type of coordination „1“ and</b>																				
3 - 12	100			50	100			50	15			50	6			50	3			50
8 - 32	100			50	100			50	25			50	6			50	3			50

### Notes

- No upstream protective device required, as it is the auto-protected range (150 kA)
- N Not necessary

- Fuse (A gG/gL) for increasing the switching capacity of the motor-protective circuit-breaker to 100 kA
- Please enquire for additional information regarding voltages >400 V and device combinations with CL-PKZ0.

## Motor-protective circuit-breaker internal resistances

	Impedance	Heat dissipation (3 pole at operating temperature)	Rated uninterrupted current $I_u$		Impedance	Heat dissipation (3 pole at operating temperature)	Rated uninterrupted current $I_u$
	$\Omega$	W	A		$\Omega$	W	A
PKZM0-0.16	78	6	0.16	PKZM4-16	0.029	22	16
PKZM0-0.25	32	6	0.25	PKZM4-25	0.012	22	25
PKZM0-0.4	13	6	0.4	PKZM4-32	0.007	22	32
PKZM0-0.63	5	6	0.63	PKZM4-40	0.005	22	40
PKZM0-1	2	6	1	PKZM4-50	0.003	22	50
PKZM0-1.6	0.8	6	1.6	PKZM4-58	0.002	22	58
PKZM0-2.5	0.32	6	2.5	PKZM4-63	0.002	22	65
PKZM0-4	0.13	6	4				
PKZM0-6.3	0.050	6	6.3				
PKZM0-10	0.020	6	10				
PKZM0-12	0.014	6	12				
PKZM0-16	0.008	6	16				
PKZM0-20	0.005	6	20				
PKZM0-25	0.003	6	25				
PKZM0-32	0.002	6	32				

# 1.3

## Motor-protective circuit-breakers PKZM01, PKZM0, PKZM4, PKE

### Motor-protective circuit-breakers PKZM

#### 1 Approvals for world markets

##### PKZM01, PKZM0, PKZM4

Rating data for approved types<sup>1)</sup>  
UL 508/CSA C 22.2 No. 14

	Maximum motor rating				Setting ranges		Maximum protective device to UL/CSA					
	Three-phase current				Overload releases	Short-circuit releases	Group protection <sup>2)</sup>					
	200 V	230 V	460 V	575 V			Up to max. short-circuit current	Maximum fuse rating		Maximum circuit breaker		
	HP	HP	HP	HP	A	A	600 V	with CL	with CL	with CL	with CL	
Motor-protective circuit-breakers PKZM01	"Manual Motor Starter with thermal and magnetic trip"											
PKZM01-0,16	3)				0.1 – 0.16	2.2	50	600		600		
PKZM01-0.25					0.16 – 0.25	3.4	50	600		600		
PKZM01-0.4					0.25 – 0.4	5.6	50	600		600		
PKZM01-0,63					0.4 – 0.63	8.8	50	600		600		
PKZM01-1					0.63 – 1	14	50	600		600		
PKZM01-1,6					1 – 1.6	22	50	600		600		
PKZM01-2.5	½	½	1	1½	1.6 – 2.5	35	50	600		600		
PKZM01-4	¾	¾	2	3	2.5 – 4	56	50	600		600		
PKZM01-6,3	1	1½	3	5	4 – 6.3	88	50	600		600		
PKZM01-10	3	3	7½	10	6.3 – 11	140	22	50	150	600	125	600
PKZM01-12	3	3	7½	10	9 – 12	168	18	50	150	600	125	600
PKZM01-16	3	5	10	10	10 – 16	224	10	50	150	600	125	600
PKZM01-20	5	-	-	15	16 – 20	280	10	18	150	600	125	600
PKZM01-25	-	7½	15	20	20 – 25	350	10	18	150	600	125	600
Motor-protective circuit-breakers PKZM01	"Manual Motor Starter with thermal and magnetic trip"											
PKZM0-0,16	3)				0.1 – 0.16	2.2	50	600		600		
PKZM0-0.25					0.16 – 0.25	3.4	50	600		600		
PKZM0-0.4					0.25 – 0.4	5.6	50	600		600		
PKZM0-0.63					0.4 – 0.63	8.8	50	600		600		
PKZM0-1					0.63 – 1	14	50	600		600		
PKZM0-1.6					1 – 1.6	22	50	600		600		
PKZM0-2.5	½	½	1	1½	1.6 – 2.5	35	50	600		600		
PKZM0-4	¾	¾	2	3	2.5 – 4	56	50	600		600		
PKZM0-6.3	1	1½	3	5	4 – 6.3	88	50	600		600		
PKZM0-10	3	3	7½	10	6.3 – 11	140	22	50	150	600	125	600
PKZM0-12	3	3	7½	10	9 – 12	168	18	50	150	600	125	600
PKZM0-16	3	5	10	10	10 – 16	224	10	50	150	600	125	600
PKZM0-20	5	-	-	15	16 – 20	280	10	18	150	600	125	600
PKZM0-25	-	7½	15	20	20 – 25	350	10	18	150	600	125	600
PKZM0-32	7½	10	20	25	24 – 32	448	10	18	150	600	125	600
Motor-protective circuit-breakers PKZM4												
PKZM4-16	3	5	10	15	10 – 16	224	50	600		600		
PKZM4-25	7½	7½	20	25	16 – 25	350	50	600		600		
PKZM4-32	10	10	25	30	25 – 34	448	50	600		600		
PKZM4-40	10	15	30	40	32 – 42	560	50	600		600		
PKZM4-50	10	15	30	40	40 – 52	700	10	600		600		
PKZM4-58	15	15	40	50	50 – 56	812	10	600		600		
PKZM4-63	15	15	40	50	52 – 58	882	10	600		600		

#### Notes

Service factor (SF)

Set value  $I_r$ , on the current scale, depending on the load factor

$$SF = 1.15 \rightarrow I_r = 1 \times I_{n\text{ mot}}$$

$$SF = 1 \rightarrow I_r = 0.9 \times I_{n\text{ mot}}$$

<sup>1)</sup> Devices for world markets IEC  $\Delta$  UL/CSA

<sup>2)</sup> Caution: Changed requirements for group protection

<sup>3)</sup> Calculate motor output in this range according to rated operational current. Specified values as per NEC Table 430 – 150

### PKZM

#### Rating data for approved types<sup>1)</sup>

UL 508/CSA C 22.2 No. 14

		For use with	Pilot Duty	General Use	
<b>Accessories</b>					
Standard auxiliary contacts	NHI11-PKZO	PKZM0(-T) PKZM4	A 600, Q 300	5 A – 600 V AC 1 A – 250 V DC	–
	NHI12-PKZO				
	NHI21-PKZO				
	NHI2-11S-PKZO				
	NHI-E-11-PKZO				
Early-make auxiliary contacts	NHI-E-10-PKZO		E150	0.5 A – 250 V AC	–
	VHI20-PKZO	PKZM0(-T)	E150	0.5 A – 250 V AC	–
Trip indicators	VHI20-PKZO1	PKZM01	E150	0.5 A – 250 V AC	–
	AGM2-10-PKZO	PKZM0(-T) PKZM4	A 600, Q 300	5 A – 600 V AC 1 A – 250 V DC	–
AGM2-01-PKZO					
Shunt release	A-PKZO(...)	PKZM0(-T) PKZM4	–	–	Actuating voltages and ordering information → Products for the German market
	U-PKZO(...)				
Auxiliary contact for contact module	HI11-S/EZ-PKZO	PKZM0	A 600, Q 300	5 A – 600 V AC 1 A – 250 V DC	–

#### Notes

<sup>1)</sup> Devices for world markets IEC Δ UL/CSA

### PKZM

#### Motor-protective circuit-breakers PKZM0(4) used as "Manual self-protected Motor Starters" – UL 508 Type E

Maximum motor output				Setting ranges		Interrupting Capacity = Short Circuit Current (SCCR)			Components	
AC				Overload releases	Short-circuit releases	240 V	480Y/ 277 V <sup>2)</sup>	600Y/ 347 V <sup>2)</sup>	Motor Protector	Accessories
200 V	230 V	460 V	575 V	[A]	[A]	[kA]	[kA]	[kA]	Part no.	Part no.
208 V	240 V	480 V	600 V							
<sup>1)</sup>				0.1 – 0.16	2.2	65	65	50	<b>PKZM0-0.16</b>	<b>BK25/3-PKZO-E</b>
				0.16 – 0.25	3.4	65	65	50	<b>PKZM0-0.25</b>	<b>BK25/3-PKZO-E</b>
				0.25 – 0.4	5.6	65	65	50	<b>PKZM0-0.4</b>	<b>BK25/3-PKZO-E</b>
				0.4 – 0.63	8.8	65	65	50	<b>PKZM0-0.63</b>	<b>BK25/3-PKZO-E</b>
				0.63 – 1	14	65	65	50	<b>PKZM0-1</b>	<b>BK25/3-PKZO-E</b>
				1 – 1.6	22	65	65	50	<b>PKZM0-1.6</b>	<b>BK25/3-PKZO-E</b>
½	½	1	1½	1.6 – 2,5	35	65	65	50	<b>PKZM0-2.5</b>	<b>BK25/3-PKZO-E</b>
¾	¾	2	3	2.5 – 4	56	65	65	50	<b>PKZM0-4</b>	<b>BK25/3-PKZO-E</b>
1	1½	3	5	4 – 6.3	88	65	65	50	<b>PKZM0-6.3</b>	<b>BK25/3-PKZO-E</b>
3	3	7½	10	6.3 – 11	140	65	65	50	<b>PKZM0-10</b>	<b>BK25/3-PKZO-E</b>
3	3	7½	–	9 – 12	168	65	65	–	<b>PKZM0-12</b>	<b>BK25/3-PKZO-E</b>
3	5	10	–	10 – 16	224	42	42	–	<b>PKZM0-16</b>	<b>BK25/3-PKZO-E</b>
5	–	–	–	16 – 20	280	18	18	–	<b>PKZM0-20</b>	<b>BK25/3-PKZO-E</b>
–	7½	15	–	20 – 25	350	18	18	–	<b>PKZM0-25</b>	<b>BK25/3-PKZO-E</b>
7½	10	20	–	24 – 32	448	18	18	–	<b>PKZM0-32</b>	<b>BK25/3-PKZO-E</b>
3	5	10	10	10 – 16	224	65	65	25	<b>PKZM4-16</b>	<b>BK50/3-PKZ4-E</b>
5	7½	15	20	16 – 27	350	65	65	25	<b>PKZM4-25</b>	<b>BK50/3-PKZ4-E</b>
7½	10	20	30	24 – 34	448	65	65	25	<b>PKZM4-32</b>	<b>BK50/3-PKZ4-E</b>
10	–	30	30	32 – 40	560	65	65	25	<b>PKZM4-40</b>	<b>BK50/3-PKZ4-E</b>
–	15	30	–	40 – 52	700	65	65	–	<b>PKZM4-50</b>	<b>BK50/3-PKZ4-E</b>
–	–	40	–	50 – 56	812	65	65	–	<b>PKZM4-58</b>	<b>BK50/3-PKZ4-E</b>
–	–	40	–	52 – 58	882	65	–	–	<b>PKZM4-63</b>	<b>BK50/3-PKZ4-E</b>

#### Notes

<sup>1)</sup> Calculate motor power in this range according to the rated current. Stated values to NEC Table 430 -150

<sup>2)</sup> Suitable for networks with grounded star-point

# 1.3

## Motor-protective circuit-breakers PKZM01, PKZM0, PKZM4, PKE

### Motor-protective circuit-breaker

### 1 Technical data

#### PKZM, PKE

		PKZM01...	PKZM0-... <sup>1)</sup>
<b>General</b>			
Standards		IEC/EN 60947, VDE 0660, UL 508, CSA C 22.2 No. 14	
Climatic proofing		Damp heat, constant, to IEC 60068-2-78 Damp heat, cyclic, to IEC 60068-2-30	
Ambient temperature	Storage	°C	-25...80
	Open	°C	-25...55
	Encapsulated	°C	-25...40
Built-in position			
Direction of incoming supply		Any	Any
Degree of protection	Device	IP20	IP20
	Terminals	IP00	IP00
Contact protection to EN 50274		Finger- and back-of-hand proof	
Shock resistance, half-sinusoidal shock, 10 ms to IEC 60068-2-27		g	25
Installation altitude		m	max. 2000
Terminal capacity, screw terminals	Solid	mm <sup>2</sup>	1 x (1 - 6) 2 x (1 - 6)
		mm <sup>2</sup>	1 x (1 - 6) 2 x (1 - 6)
	Flexible with ferrule to DIN 46228	mm <sup>2</sup>	1 x (1 - 6) 2 x (1 - 6)
Terminal capacity, spring-loaded terminals	Solid	mm <sup>2</sup>	–
		mm <sup>2</sup>	–
	Flexible with ferrule to DIN 46228	mm <sup>2</sup>	–
Terminal screw tightening torque	Main conductors	Nm	1.7
		Nm	1
	Auxiliary conductors	Nm	1
<b>Main contacts</b>			
Rated impulse withstand voltage	$U_{imp}$	V AC	6000
Overvoltage category/pollution degree			III/3
Rated operational voltage	$U_e$	V AC	690
Rated uninterrupted current = rated operational current	$I_u = I_e$	A	16 or current setting of the overcurrent release
Rated frequency		Hz	40 - 60
Heat dissipation (3 pole at operating temperature)		W	6
Lifespan, mechanical	Operations	$\times 10^6$	0.05
Lifespan, electrical (AC-3 at 400 V)	Operations	$\times 10^6$	0.05
Maximum operating frequency	Operations/h	Ops/h	25
Short-circuit rating	AC		→ Page 33
	DC	kA	60
Motor switching capacity	AC-3 up to 690 V	A	16
	DC-5 (up to 250 V)	A	16 (3 contacts in series)
Trip blocks	AC		→ Page 32
	DC		60 (up to PKZM0-16) 40 (PKZM0-20 to PKZM0-32)
<b>Temperature compensation</b>			
To IEC/EN 60947, VDE 0660		°C	-5...40
Operating range		°C	-25...55
Temperature compensation residual error for $T > 40$ °C		%/K	$\leq 0.25$
Setting range of overload releases		$\times I_u$	0.6 - 1
Short-circuit releases tolerance		%	$\pm 20$
Phase-failure sensitivity			IEC/EN 60947-4-1, VDE 0660 Part 102

**Notes** <sup>1)</sup> Tested according to IEC/EN 60947-1 (isolating characteristics) and IEC/EN 60947-2

PKM0-...	PKZM0-...-T	PKZM4	PKE
IEC/EN 60947, VDE 0660, UL 508, CSA C 22.2 No. 14			
Damp heat, constant, to IEC 60068-2-78			
Damp heat, cyclic, to IEC 60068-2-30			
-25...80	-25...80	-25...70	-25...80
-25...55	-25...55	-25...55	-25...55
-25...40	-25...40	-25...40	-25...40
			
Any	Any	Any	Any
IP20	IP20	IP20	IP20
IP00	IP00	IP00	IP00
Finger- and back-of-hand proof			
25	25	15	25
max. 2000	max. 2000	max. 2000	max. 2000
1 x (1 - 6)	1 x (1 - 6)	1 x (1 - 50)	1 x (1 - 6)
2 x (1 - 6)	2 x (1 - 6)	2 x (1 - 35)	2 x (1 - 6)
1 x (1 - 6)	1 x (1 - 6)	1 x (1 - 35)	1 x (1 - 6)
2 x (1 - 6)	2 x (1 - 6)	2 x (1 - 35)	2 x (1 - 6)
18 - 10	18 - 10	14 - 2	18 - 10
1 x (1...2.5)	-	-	1 x (1...2.5)
2 x (1...2.5)	-	-	2 x (1...2.5)
1 x (1...2.5)	-	-	1 x (1...2.5)
2 x (1...2.5)	-	-	2 x (1...2.5)
18...14	-	-	18...14
1.7	1.7	3.3	1.7
1	1	1	1
6000	6000	6000	6000
III/3	III/3	III/3	III/3
690	690	690	690
32 or current setting of the overcurrent release	25 or current setting of the overcurrent release	65 Open 63 enclosed	32 A or set current of the overcurrent release
40 - 60	40 - 60	40 - 60	40 - 60
6	6	22	6
0.1	0.1	0.03	0.05
0.1	0.1	0.03	0.05
40	40	40	60
→ Page 32	→ Page 32	→ Page 33	→ Page 33
60 (up to PKM0-16) 40 (PKM0-20 to PKM0-32)	60 (up to PKZM0-16) 40 (PKZM0-20 to PKZM0-32)	60	-
32	25	65	32
25 (3 contacts in series)	25 (3 contacts in series)	63 (3 contacts in series)	-
-5...40	-5...40	-5...40	-5...40
-25...55	-25...55	-25...55	-25...55
≅ 0.25	≅ 0.25	≅ 0.25	
	0.6 - 1	0.6 - 1	0.25 - 1
± 20	± 20	± 20	± 20
-	IEC/EN 60947-1-1, VDE 0660 Part 102	IEC/EN 60947-4-1, VDE 0660 Part 102	Yes

# 1.3

## Motor-protective circuit-breakers PKZM01, PKZM0, PKZM4, PKE Auxiliary contacts

### 1 NHI...PKZ, AGM, U-PKZ, A-PKZ

			NHI...PKZ0	NHI-E...PKZ0	VHI...PKZ0	AGM	
<b>Auxiliary contacts</b>							
Rated impulse withstand voltage	$U_{imp}$	V AC	6000	4000	4000	6000	
Overvoltage category/pollution degree			III/3	III/3	III/3	III/3	
Rated operating voltage							
	$U_e$	V AC	500	440	440	500	
	$U_e$	V DC	250	250	250	250	
Safe isolation according to EN 61140							
		V AC	690	690	690	690	
Rated operational current							
AC-15							
	220 - 240 V	$I_e$	A	3.5	1	1	3.5
	380 - 415 V	$I_e$	A	2	–	–	2
	440 - 500 V	$I_e$	A	1	–	–	1
DC-13 L/R $\leq$ 100 ms							
	24 V	$I_e$	A	2	2	2	2
	60 V	$I_e$	A	1.5	–	–	1.5
	110 V	$I_e$	A	1	–	–	1
	220 V	$I_e$	A	0.25	–	–	0.25
Durability							
	Lifespan, mechanical	Operations	$\times 10^6$	> 0.1	> 0.1	> 0.1	> 0.01
	Lifespan, electrical	Operations	$\times 10^6$	> 0.05	> 0.1	> 0.1	> 0.05
	Control circuit reliability (at $U_e = 24$ V DC, $U_{min} = 17$ V, $I_{min} = 5.4$ mA)	Fault probability	$\lambda$	< $10^{-8}$ < 1 failure in $1 \times 10^8$ operations			
	Interlocked opposing contacts			Yes	–	–	–
Short-circuit rating without welding							
	Fuseless			FAZ-B4/1-HI	–	–	FAZ-B4/1-HI
	Fuse	A gG/gL	10	10	10	10	
<b>Terminal capacity</b>							
	Solid or flexible conductor with ferrule	mm <sup>2</sup>	0.75 - 2.5	0.75 - 1.5	0.75 - 1.5	0.75 - 2.5	
	Solid or stranded	AWG	18 - 14	18 - 16	18 - 16	18 - 14	

### NHI...PKZ, AGM, U-PKZ, A-PKZ

			Undervoltage release U-PKZ...	Shunt release A-PKZ...	
<b>General</b>					
Terminal capacity					
	Solid or flexible conductor with ferrule	mm <sup>2</sup>	1 x (0.75 - 2.5) 2 x (0.75 - 2.5)	1 x (0.75 - 2.5) 2 x (0.75 - 2.5)	
	Solid or stranded	AWG	1 x (18 - 14) 2 x (18 - 14)	1 x (18 - 14) 2 x (18 - 14)	
<b>Main contacts</b>					
	Rated operating voltage	$U_e$	V AC	42 - 480	42 - 480
	Rated operating voltage	$U_e$	V DC	24 - 250	24 - 250
<b>Pick-up-/drop-out voltage</b>					
	Pick-up voltage	$x U_s$		0.85 - 1.1	
	Drop-out voltage	$x U_s$		0.7 - 0.35	
<b>Operating range</b>					
	AC voltage		$x U_s$	0.7...1.1	
	DC voltage (intermittent operation 5 s)		$x U_s$	0.7...1.1	
<b>Power consumption</b>					
AC voltage					
	AC pick-up rating	Pick-up	VA	5	
	AC consumption when closed	Holding	VA	3	
DC voltage					
	DC pick-up rating	Pick-up	W	–	
	DC consumption when closed	Holding	W	–	

## Dimensions

### Motor-protective circuit-breaker

PKZM01 ...

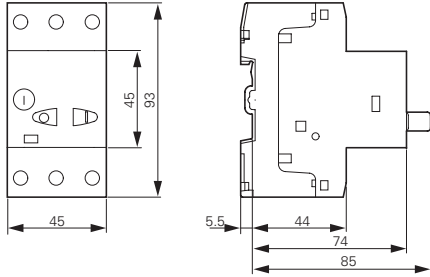

### Motor-protective circuit-breaker Transformer-protective circuit-breakers Motor-protective circuit-breaker with standard auxiliary contacts

PKZM0...(+NHI-E...-PKZ0)  
PKZM0...-T(+NHI-E...-PKZ0)  
PKM0...(+NHI-E...-PKZ0)

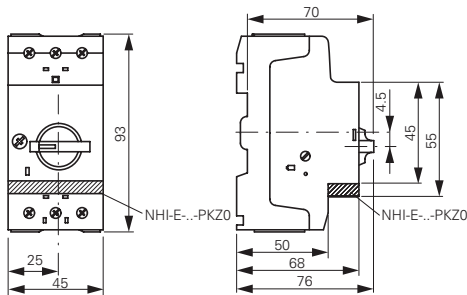

### Motor-protective circuit-breakers with lockable rotary handles

PKZM0...+AK-PKZ0

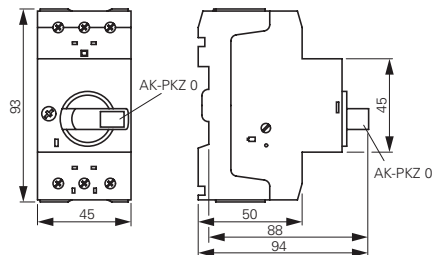

### Current limiters

CL-PKZ...

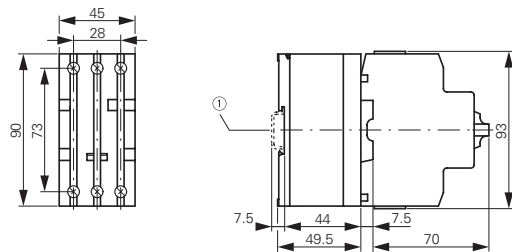

① Top-hat rail IEC/EN 60715

### Motor-protective circuit-breakers with early-make auxiliary contacts

PKZM0...+VHI...-PKZ0



### Standard auxiliary contacts

NHI...-PKZ0

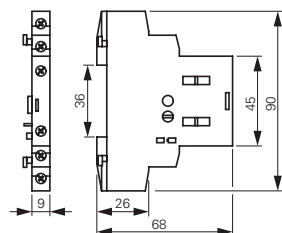

### Trip indicators

AGM2...-PKZ0



### Shunt release Undervoltage release

A-PKZ0...

U-PKZ0...





# 1.3

## Motor-protective circuit-breakers PKZM01, PKZM0, PKZM4, PKE

### Busbar adapters

1

**BBA0-25**  
**BBA0-25/2TS**  
**BBA0/2TS-L**  
**BBA0-32**  
**BBA0-32/2TS-C**  
**BBA0C-16**

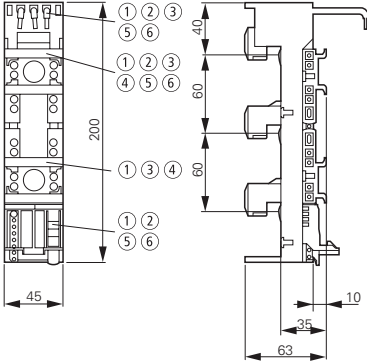

- ① BBA0-32/2TS-C
- ② BBA0-25/2TS
- ③ BBA0C-16
- ④ BBA0/2TS-L
- ⑤ BBA0-25
- ⑥ BBA0-32

**BBA2-63**  
**BBA2-63/2TS**

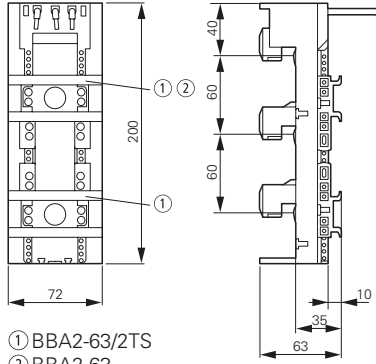

- ① BBA2-63/2TS
- ② BBA2-63

**BBA4/2TS-L**  
**BBA4L-63**

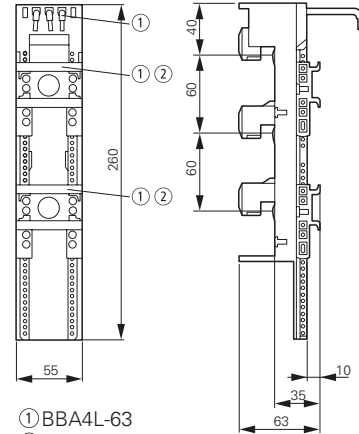

- ① BBA4L-63
- ② BBA4/2TS-L

**BBA4-63**

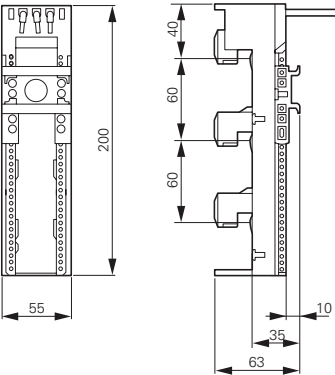

**BBA2-80/2TS-S**

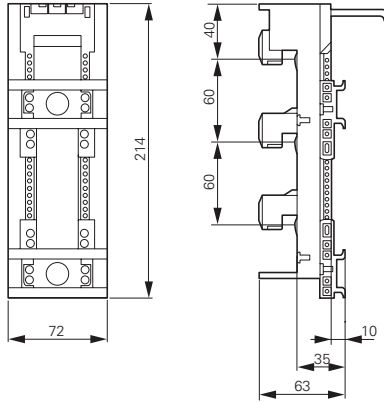

**BBA2L-63**

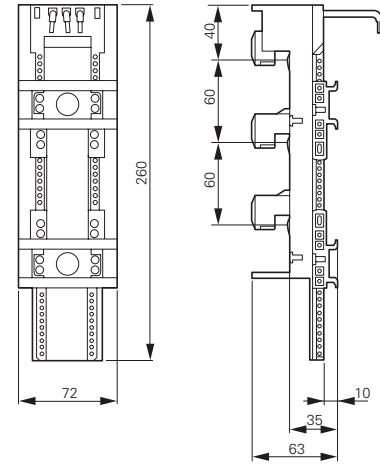

**BBA0L-25**  
**BBA0L-32**

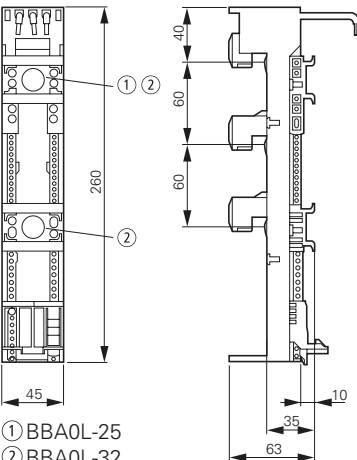

- ① BBA0L-25
- ② BBA0L-32

**BBA0K-32**

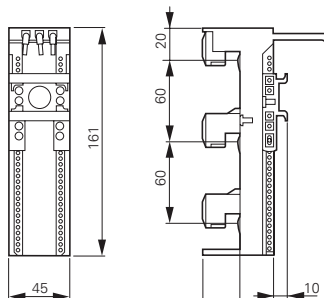

**PKZM0-XC45L**  
**PKZM0-XC45L-2**

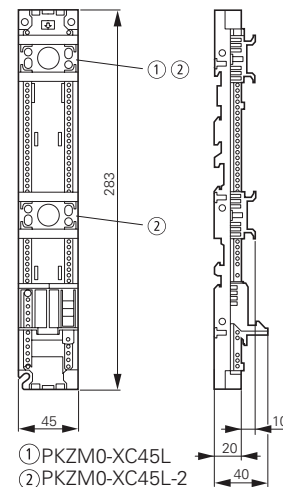

- ① PKZM0-XC45L
- ② PKZM0-XC45L-2

**Insulated enclosures for surface mounting**

CI-PKZ0-M

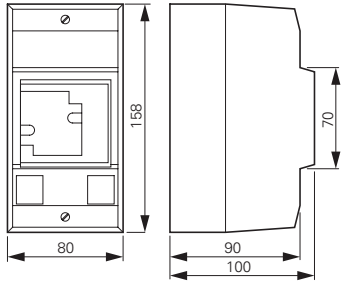

CI-PKZ10G...M

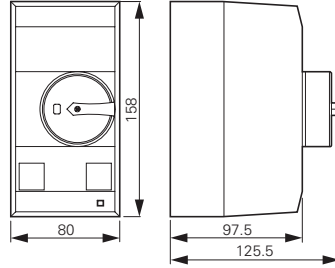

CI-PKZ0...M  
+ SVB-PKZ0-CI

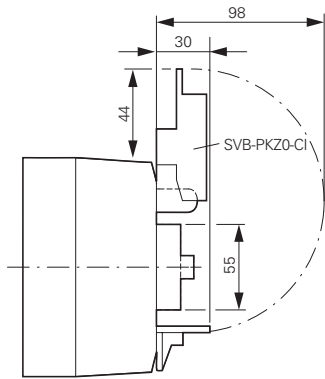

Drilling dimensions  
CI-PKZ0...M

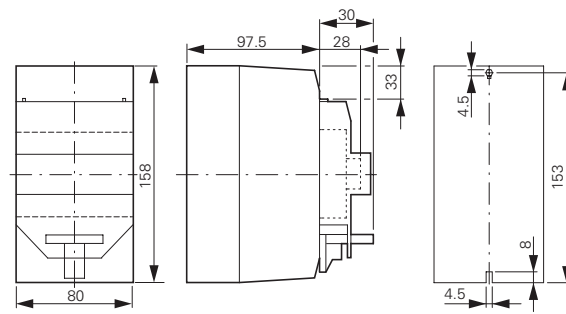

CI-K2-PKZ0

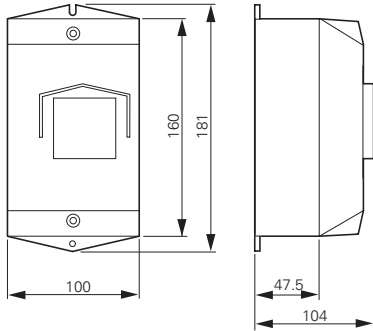

CI-K2-PKZ0G(R)(V)

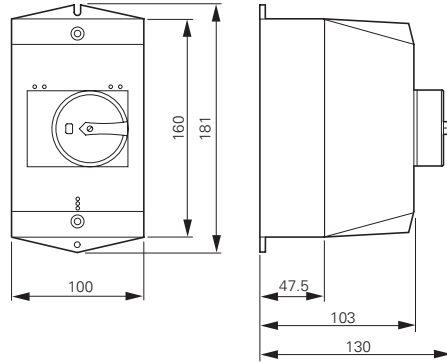

CI-K2-PKZ0-G(R)(V)  
+ SVB-PKZ0-CI

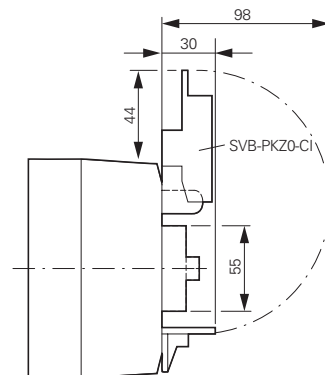

Drilling dimensions  
CI-K2-PKZ0...

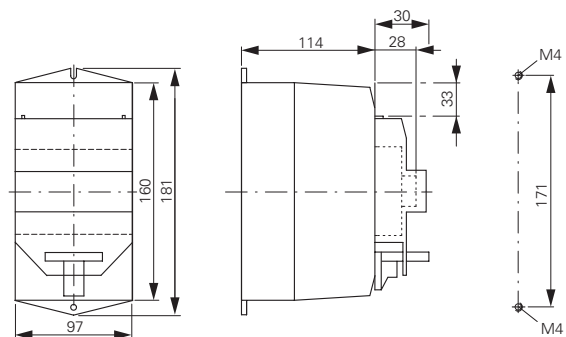

# 1.3

## Motor-protective circuit-breakers PKZM01, PKZM0, PKZM4, PKE Accessories

### Door coupling handles

PKZ0-X(R)H...

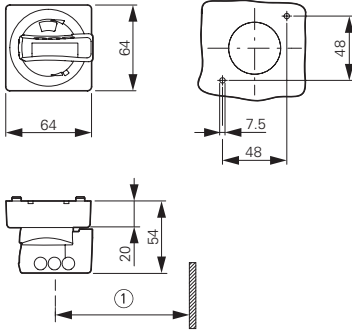

Mounting depth: 100 to 240 mm  
from the top edge of the top-hat rail  
to the front edge of the cabinet  
door/cover  
Distance between switch axis and  
cover hinge: at least 100 mm

① At least 100 mm from cover hinge

### Insulated enclosures for flush mounting

E-PKZ0 E-PKZ0-G...

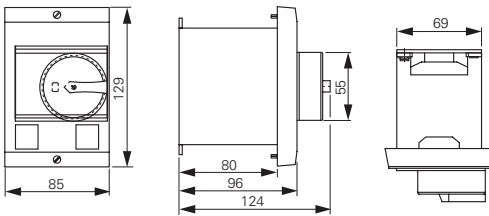

### Mounting aperture E-PKZ0...

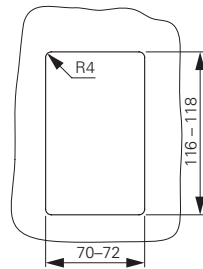

E-PKZ0-G... + SVB-PKZ0-E

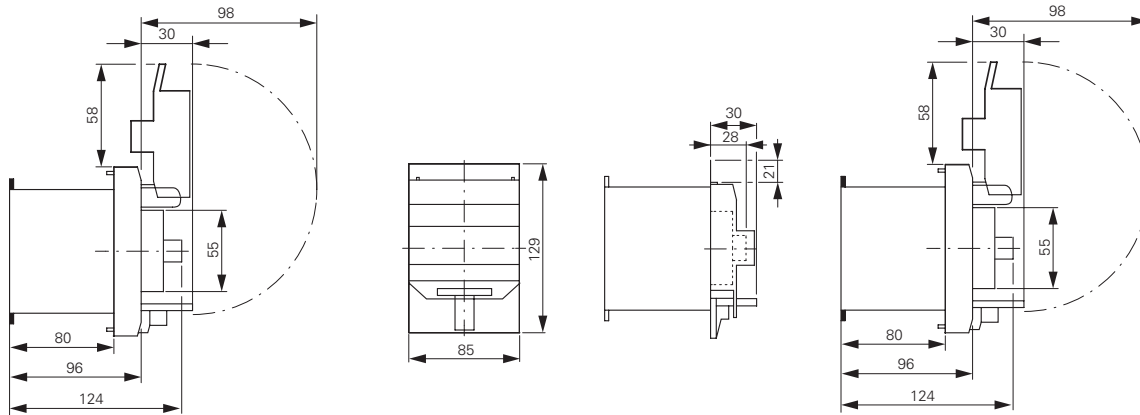

### Insulated enclosures for surface mounting

CI23E...

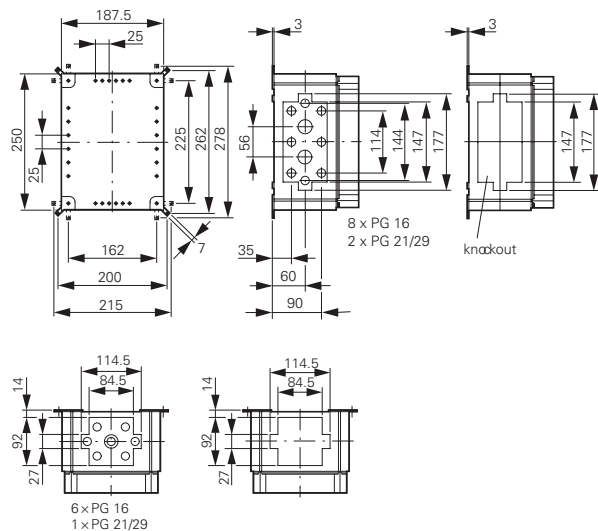

### Mounting plates

M3-CI23

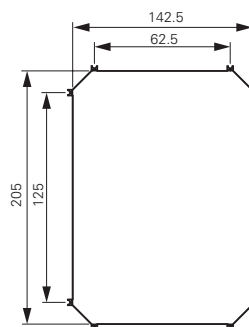

### Insulated enclosures for surface mounting

CI-PKZ01  
CI-PKZ01-G

CI-PKZ01-PVT  
CI-PKZ01-PVS

CI-PKZ01-SVB  
CI-PKZ01-SVB-V



### Insulated enclosures for flush mounting

E-PKZ01  
E-PKZ01-G

E-PKZ01-PVT  
E-PKZ01-PVS

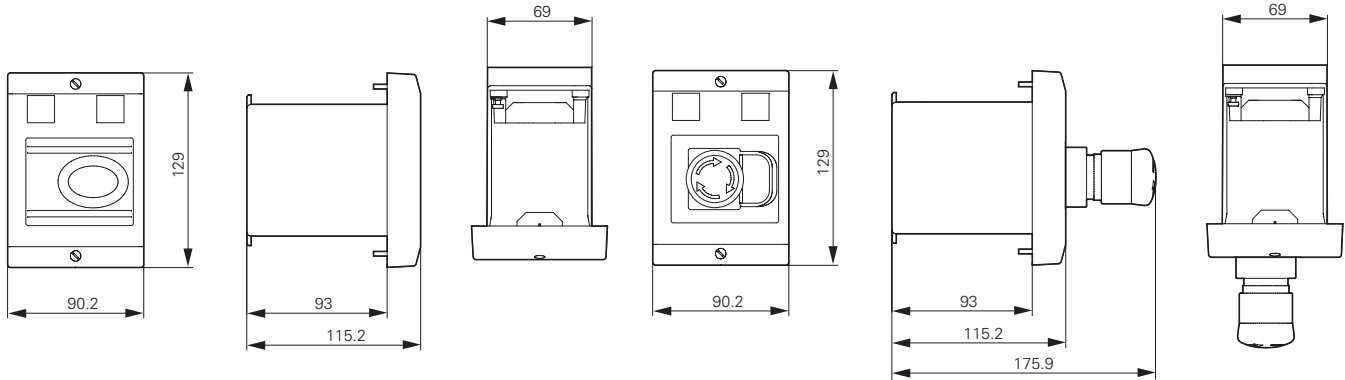

E-PKZ01-SVB  
E-PKZ01-SVB-V



# 1.3

## Motor-protective circuit-breakers PKZM01, PKZM0, PKZM4, PKE

### Accessories

#### Motor-protective circuit-breaker

PKZM4-...

1

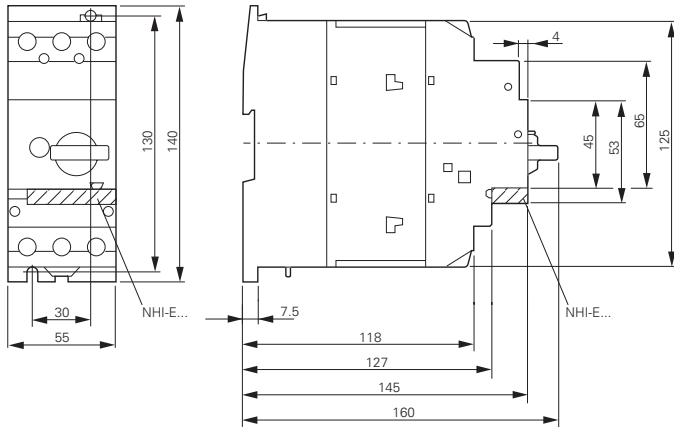

#### Standard auxiliary contacts

NHI...-PKZ...

NHI...-PKZ0

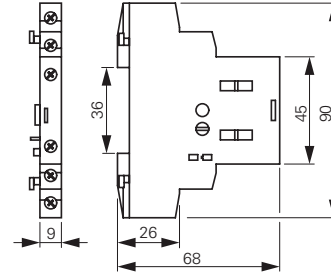

#### Motor-protective circuit-breakers with lockable cover

PKZM4-... +AK-PKZ0

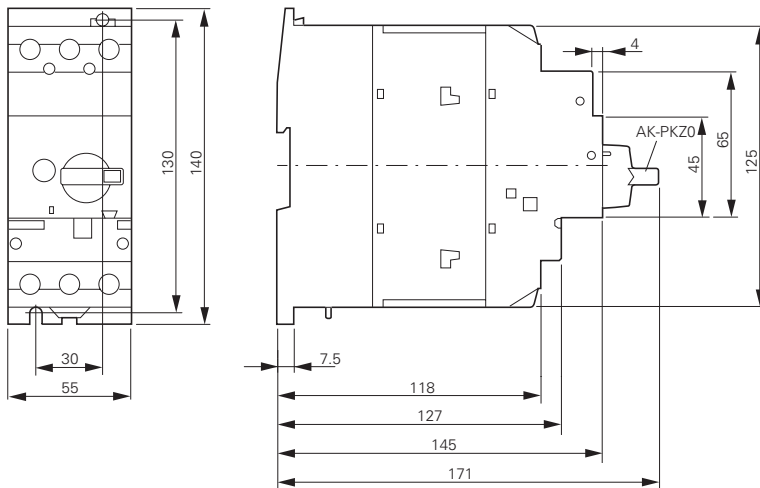

#### Trip indicators

AGM2...-PKZ...

AGM2...-PKZ0

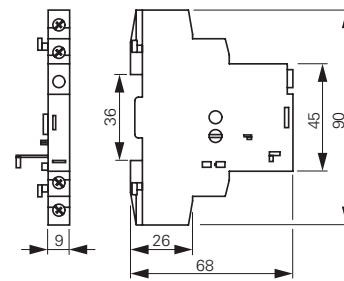

#### PKE Motor-protective circuit-breakers

PKE12, PKE32

PKE65

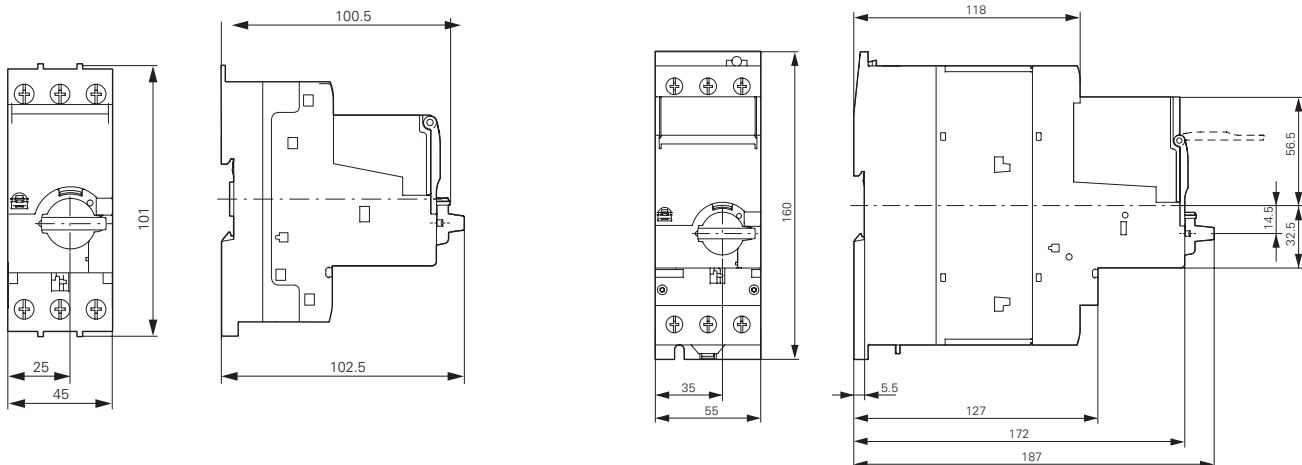

### Three-phase commoning links

B3.0/4-PKZ4

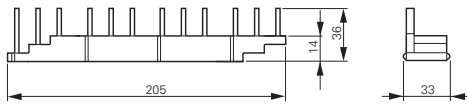

B3.2/4-PKZ4

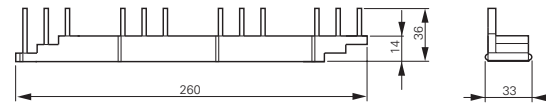

B3.0/3-PKZ4

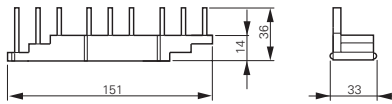

B3.2/2-PKZ4

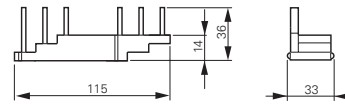

B3.0/2-PKZ4

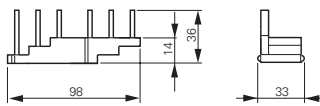

B3.0/3-PKZ4

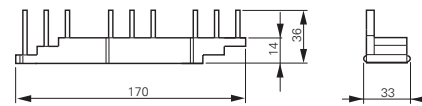

B3.1/4-PKZ4

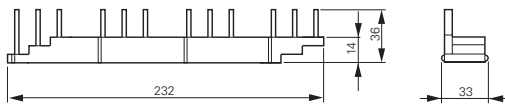

B3.1/2-PKZ4

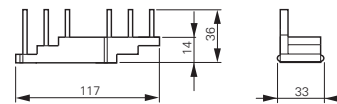

### Three-phase commoning links

B3.0/4-PKZ0

B3.0/2-PKZ0

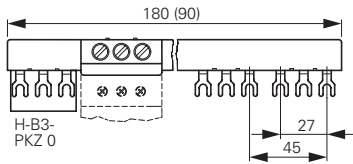

### Three-phase commoning links

B3.2/4-PKZ0

B3.2/2-PKZ0

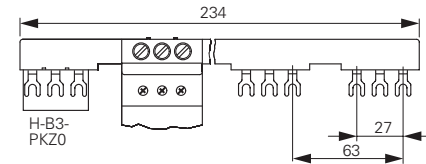

### Three-phase commoning links

B3.1/5-PKZ0 B3.1/3-PKZ0

B3.1/4-PKZ0 B3.1/2-PKZ0

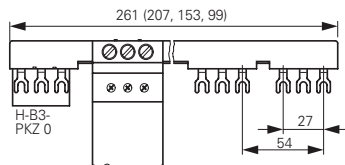

### Incoming terminals

BK25/3-PKZ0

Overlapping mounting to extend the three-phase commoning link

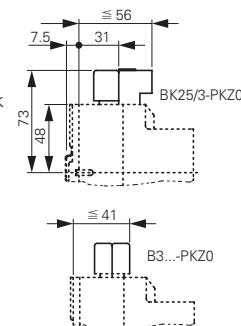

### Motor plug DILM12-XMCP/T

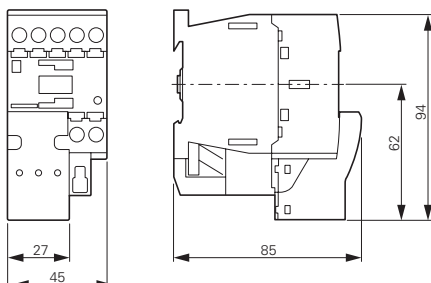

# 1.3

## Motor-protective circuit-breakers PKZM01, PKZM0, PKZM4, PKE Accessories

### 1 Insulated enclosures for surface mounting

CI-K4-PKZ4-G(R)  
+SVB-PKZ4-CI

CI-K4-PKZ4-G

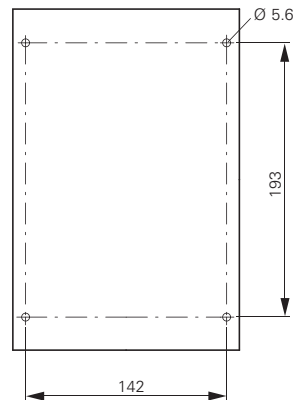
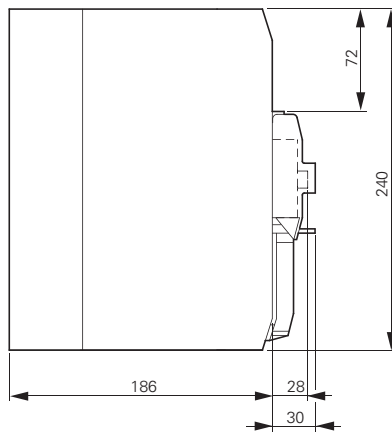
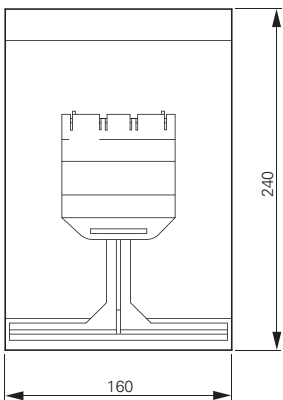
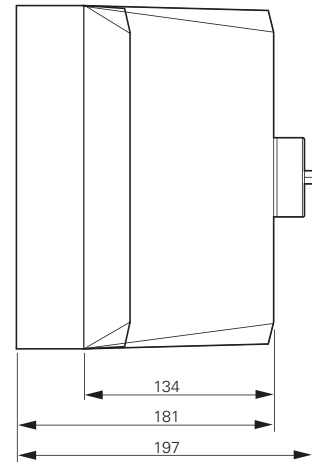
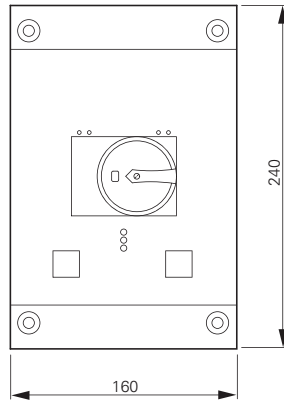
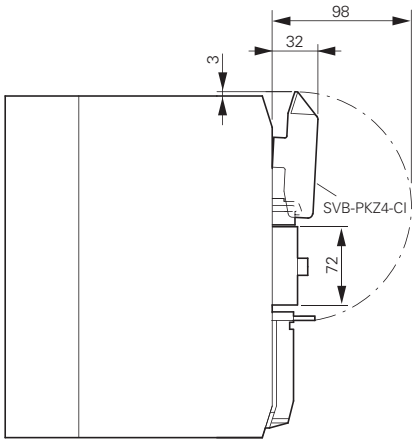

Drilling dimensions  
CI-K4-PKZ4-G(R)

## Description

### P-SOL, PKZ-SOL, SOL

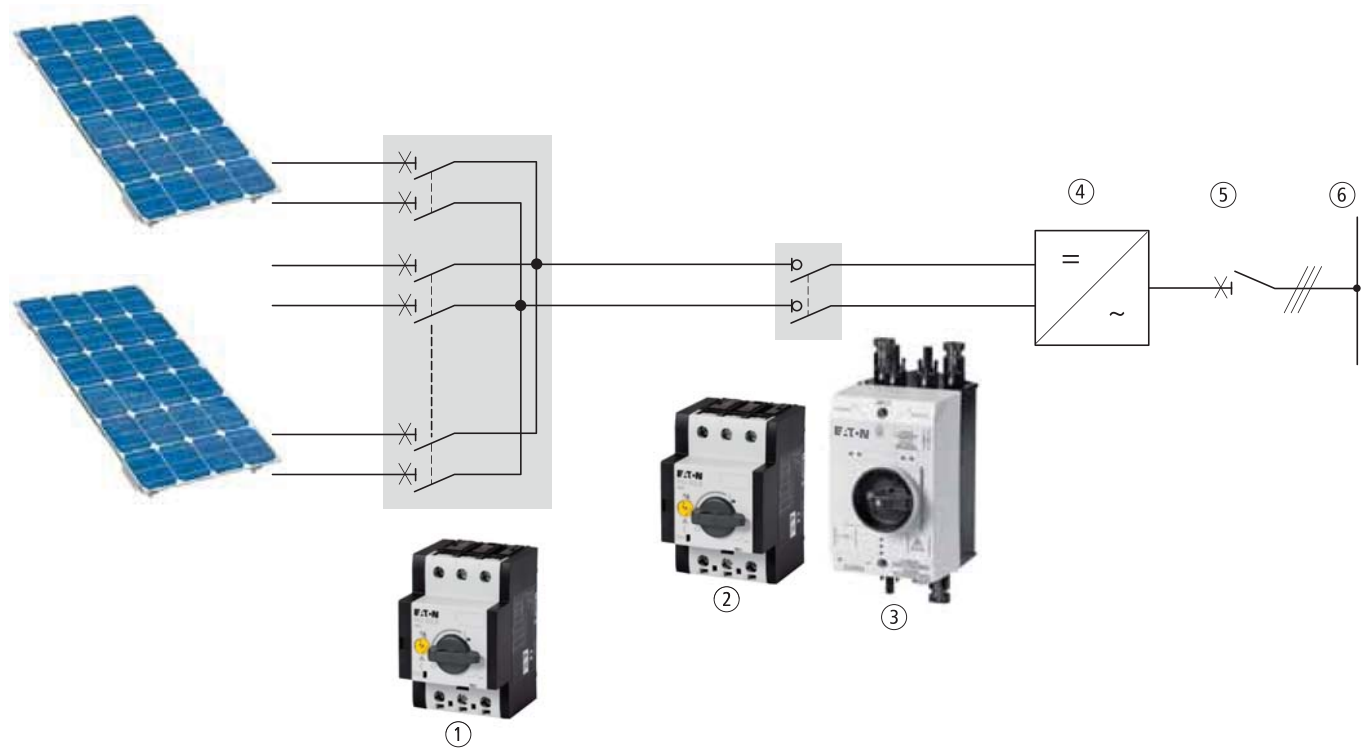

- ① DC string circuit-breaker PKZ-SOL
- ② DC switch-disconnector P-SOL
- ③ Ready-to-install DC switch-disconnector SOL
- ④ Inverter module
- ⑤ AC main switch
- ⑥ Network

### Photovoltaics description

Photovoltaic systems convert sunlight directly into electrical energy using solar cells. Photovoltaics represent a renewable source of energy that can be used on private and public buildings, as well as in large-scale power stations. These systems can be independent from the power grid or can be connected to it. Photovoltaic systems that are connected to the grid feed the generated power directly into the mains network. This eliminates the need for temporary storage. These systems consist of solar cells, one or more inverters, and a protective device for automatic cutoff in the event of a grid fault. Because of this, photovoltaic systems that are connected to the grid require extremely reliable and safe individual components.

### Features

#### DC string circuit-breakers

- Protect PV modules from fault currents, prevent (in larger systems, for instance) intact modules from feeding power back into a module with a short-circuit.
- Are ready for operation immediately after tripping and after the trip cause has been fixed.
- Open and for installation in customized generator terminal boxes.
- Tripping currents are adjustable within a wide range of limits.
- Optional shunt releases A-PKZO and undervoltage releases U-PKZO enable remote shutdown, e.g for the fire department. Optional auxiliary contact NHIE-PKZO signals switching state.
- When installed in an enclosure, suitable for voltages of up to 900 VDC.

#### DC switch-disconnectors

- Required, according to standard VDE 0100-712 (June 2006), between the PV module and inverter.
- Enclosed and open (for installation in enclosure) switch-disconnectors for voltages of up to 1,000 VDC.
- Usable as a separate switching point as required in VDI Guideline VDI 6012, e.g. by de-energizing an inverter in a completely safe manner.

- Two-pole switching, making it suitable for non-earthed systems as well.
- TÜV-certified.
- Open switch-disconnectors P-SOL are designed for installation in customer-specific enclosures or inverters.
- Mounting on 35 mm top-hat rails, their terminals enable a connection to all popular cable types.
- Separate rotary handles and shaft extensions allow for flexible installation.
- An auxiliary switching block can be mounted in order to provide switching state feedback.
- A shunt release or undervoltage release is available for remote tripping.
- Switch-disconnectors SOL with enclosure are ready for installation. Models for 2 and 4 or 4 and 8 strings and for the most popular connector types, such as MC3, MC4, and metric screw connectors, allow for easy integration into various system concepts.
- Enclosure provides degree of protection IP65, making outdoor mounting possible.
- Lockable mechanism provides safety when maintenance is required.
- Pressure-equalizing element prevents the formation of condensed water, preventing failures caused by voltage sparkovers

























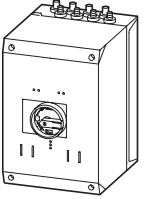

# 1.3

## DC string circuit-breakers, DC switch-disconnectors

DC switch-disconnectors, ready to install

### 1 Ordering

#### DC switch-disconnector, ready-to-install

Inputs Number of strings	Connection type	Outputs		Max. rated operational current DC-21A $I_e$ A	Part no. Article no.	Price See price list	Std. pack
		Number of strings	Connection type				
<b>Rated operational voltage <math>U_e</math> 1000 V</b>							
<b>Degree of protection IP65</b>							
<b>Protection class 2</b>							
<b>2 pole</b>							
	2	MC3	1	MC3	20	<b>SOL20/2MC3</b> 120913	1 off  
	4	MC3	1	MC3	20	<b>SOL20/4MC3</b> 120914	1 off  
	2	MC4	1	MC4	20	<b>SOL20/2MC4</b> 120915	1 off  
	4	MC4	1	MC4	20	<b>SOL20/4MC4</b> 120916	1 off  
	2	Screw connector M12	1	Screw connector M16	20	<b>SOL20/2MV</b> 120919	1 off  
	2	MC3	1	MC3	30	<b>SOL30/2MC3</b> 120920	1 off  
	4	MC3	1	MC3	30	<b>SOL30/4MC3</b> 120921	1 off  
	2	MC4	1	MC4	30	<b>SOL30/2MC4</b> 120922	1 off  
	4	MC4	1	MC4	30	<b>SOL30/4MC4</b> 120923	1 off  
	2	Screw connector M12	1	Screw connector M16	30	<b>SOL30/2MV</b> 120926	1 off  
	4	MC3	1	Screw connector M20	63	<b>SOL60/4MC3</b> 120927	1 off  
	8	MC3	1	Screw connector M20	63	<b>SOL60/8MC3</b> 120928	1 off  
	4	MC4	1	Screw connector M20	63	<b>SOL60/4MC4</b> 120929	1 off  
	8	MC4	1	Screw connector M20	63	<b>SOL60/8MC4</b> 120930	1 off  
	4	Screw connector M12	1	Screw connector M20	63	<b>SOL60/4MV</b> 120933	1 off  

#### Information relevant for export to North America



NA Certification Request filed for UL and CSA

**P-SOL, PKZ-SOL**

Max. rated operational current  
DC-21A

Permissible solar module  
short-circuit currents

**Part no.**  
Article no.

**Price**  
See price list

Std. pack

$I_e$   
A



**DC switch-disconnector, open**  
**Rated operating voltage  $U_e$  1000 V**  
**Protection class II**  
**2 pole**

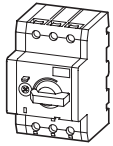

20

**P-SOL20**  
120934

1 off

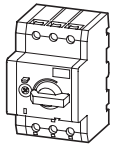

30

**P-SOL30**  
120935

1 off

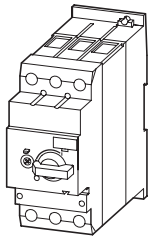

63

**P-SOL60**  
120936

1 off

**DC string circuit-breakers**  
**Rated operating voltage  $U_e$  900 V**  
**Protection class II**  
**2 pole**

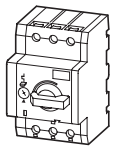

12

5 - 9

**PKZ-SOL12**  
120937

1 off

20

9 - 15

**PKZ-SOL20**  
120938

1 off

30

15 - 22

**PKZ-SOL30**  
120939

1 off

40

22 - 30

**PKZ-SOL40<sup>1)</sup>**  
120940

1 off

50

29 - 38

**PKZ-SOL50<sup>1)</sup>**  
120941

1 off

60

38 - 47

**PKZ-SOL60<sup>1)</sup>**  
120942

1 off

**Notes**

<sup>1)</sup> Availability from November 2010

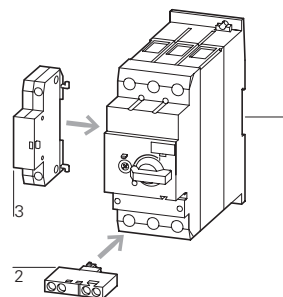
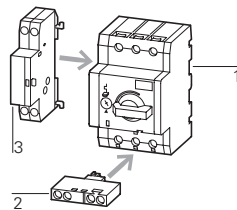

**Accessories**

- 2 Auxiliary contacts NHI-E → 10
- 3 Shunt releases A-PKZ0 → 29
- 3 Undervoltage releases U-PKZ0 → 29

**Information relevant for export to North America**



NA Certification Request filed for UL and CSA

# 1.3

## DC string circuit-breakers, DC switch-disconnectors

### 1 Engineering

#### P-SOL and PKZ-SOL wiring

##### Switch-disconnector P-SOL

Non-earthed grid

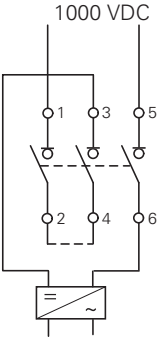

Earthed grid

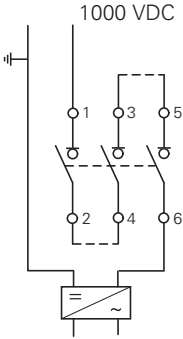

##### String circuit-breaker PKZ-SOL

Non-earthed grid

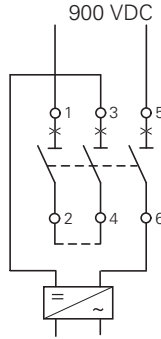

Earthed grid

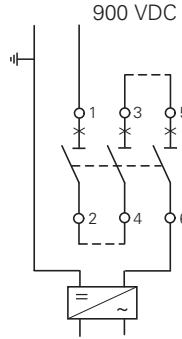

#### SOL internal circuit

SOL20/2MC3  
SOL20/2MC4  
SOL30/2MC3  
SOL30/2MC4

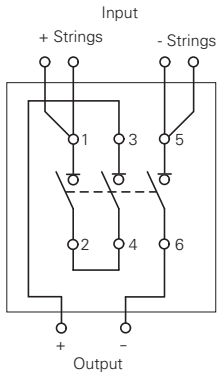

SOL20/2MV  
SOL30/2MV

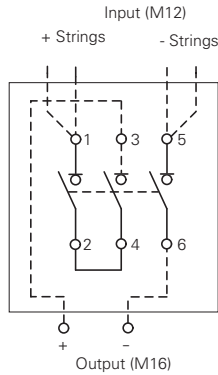

SOL20/4MC3  
SOL20/4MC4  
SOL30/4MC3  
SOL30/4MC4

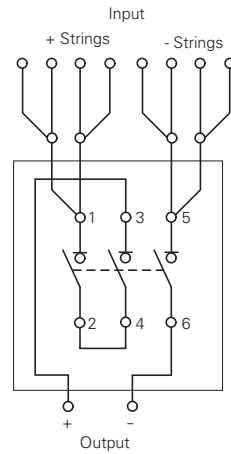

SOL60/4MC3  
SOL60/4MC4

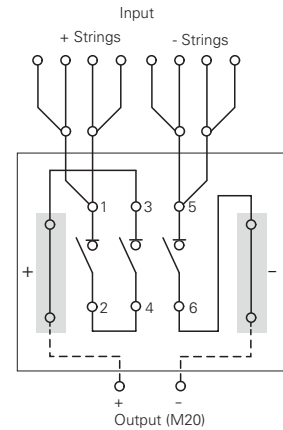

SOL60/4MV

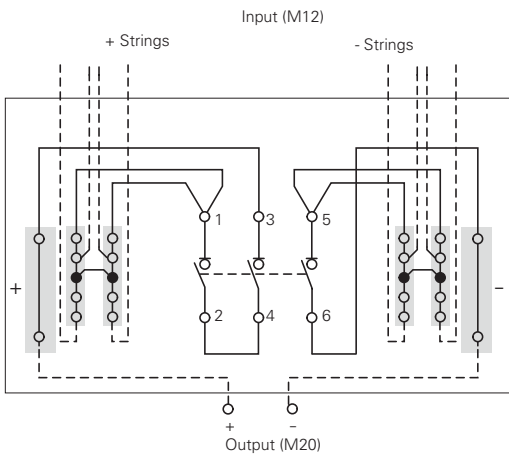

SOL60/8MC3  
SOL60/8MC4

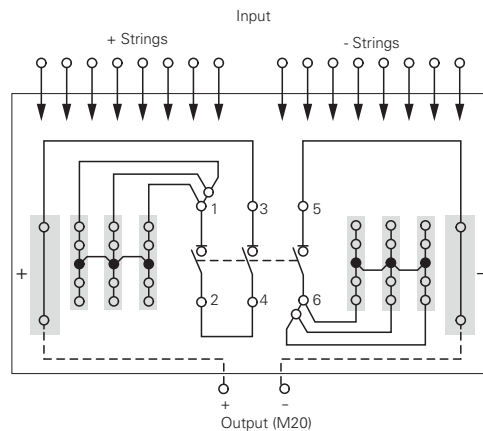

### Tripping characteristics

Tripping characteristics  
DC string circuit-breaker PKZ-SOL

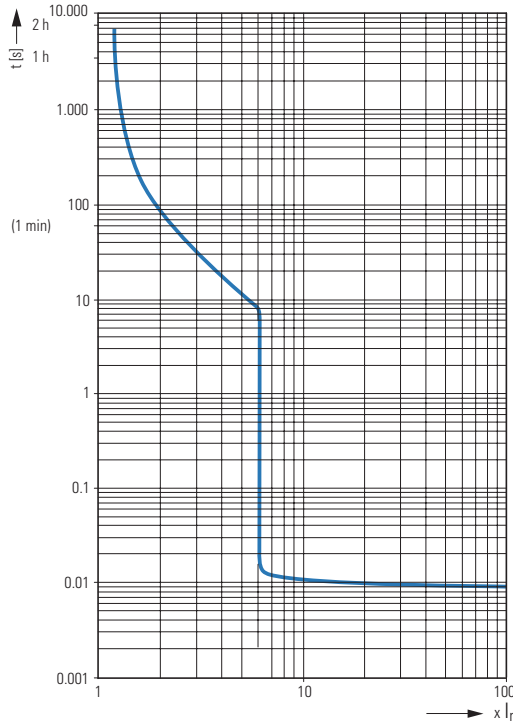

#### Characteristic curve set value - short-circuit current

As specified in the IEC 62548-1 draft for the protection of photovoltaic modules, the tripping current of the circuit-

breaker must lie between 1.4 and 2 times the value of the photovoltaic module's short-circuit current. Since only the current values of the installed overload release can be plotted on the setting scale for the

circuit-breaker<sup>1)</sup>, the correlation between the protective device's tripping current and the photovoltaic module's short-circuit current must be specified for each point of the scale in a suitable form.

Setting aid for string circuit-breaker PKZ-SOL

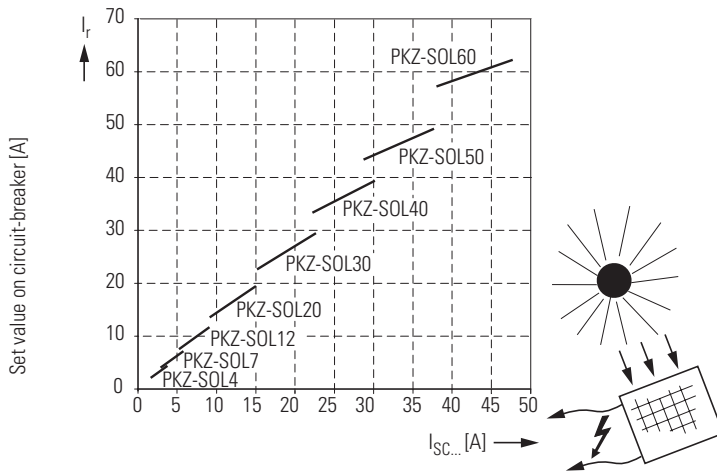

Short-circuit current in solar module [A]

<sup>1)</sup> Standard IEC/EN 60947-2 (Section 4.7.3) prohibits directly specifying the photovoltaic short-circuit current on the circuit-breaker's setting scale, meaning that only the current set value of the operating current can be plotted there.

# 1.3

## DC string circuit-breakers, DC switch-disconnectors

### DC switch-disconnectors

#### Technical data

#### 1 P-SOL, SOL

		SOL20		SOL30		SOL60	
Rated operational current $I_e$ at DC-21A	A	20	30	63			
Number of poles		2	2	2			
Rated operational voltage $U_e$	V DC	1000	1000	1000			
Isolating characteristics		Yes	Yes	Yes			
Standards		IEC/EN 60 947-3 UL 508, TÜV certificate					
Lifespan mechanical	Operations	100,000	100,000	100,000			30,000
Lifespan electrical	Operations	100,000	100,000	100,000			30,000
Max. operating frequency, mechanical	Ops/h	120	120	120			
Climatic proofing		Damp heat, constant, to IEC 60 068-2-78 Damp heat, cyclic, to IEC 60 068-2-30					
Ambient temperature	min./max. °C	-25 ... +60	-25 ... +60	-25 ... +60			
Mounting position		Any	Any	Any			
Degree of protection	IP	65	65	65			
Dimensions							
Width	mm	100	100	160			
Height	mm	215	215	305			
Depth	mm	130	130	210			
Weight	kg	0.42	0.42	2.2			
Lockable in OFF position		Yes	Yes	Yes			
Rated short-time withstand current $I_{cw}$ , 1 s to EN 60947-3	kA	0.24	0.36	0.72			
Rated short-circuit making capacity to EN 60947-3	$I_{cm}$ kA	0.32	0.32	0.6			
Internal resistance	mΩ	8	7	4			

#### P-SOL, SOL

		P-SOL20		P-SOL30		P-SOL60	
Rated operational current at DC-21A	$I_e$ A	20	30	63			
Number of poles		2	2	2			
Rated operational voltage	$U_e$ V DC	1000	1000	1000			
Isolating characteristics		Yes	Yes	Yes			
Standards		IEC/EN 60 947-3 UL 508, TÜV certificate					
Lifespan mechanical	Operations	100,000	100,000	100,000			30,000
Lifespan electrical	Operations	100,000	100,000	100,000			30,000
Max. operating frequency, mechanical	Ops/h	120	120	120			
Climatic proofing		Damp heat, constant, to IEC 60 068-2-78 Damp heat, cyclic, to IEC 60 068-2-30					
Ambient temperature							
Open	min./max. °C	-25 ... +60	-25 ... +60	-25 ... +60			
Mounting position		Any	Any	Any			
Dimensions							
Width	mm	58	58	55			
Height	mm	93	93	140			
Depth	mm	76	76	160			
Mounting							
Top-hat rail		35 mm	35 mm	35 mm			
Screw mounting		–	–	2 x M4 x 18 30 x 130			
Weight	kg	0.32	0.32	1.25			
Terminals							
Flexible with ferrule	mm <sup>2</sup>	1 x (1-6)	1 x (1-6)	1 x (1-35)			
	mm <sup>2</sup>	2 x (1-6)	2 x (1-6)	2 x (1-35)			
solid/stranded	AWG	18 - 14	18 - 14	14 - 2			
Rated short-time withstand current $I_{cw}$ , 1 s to EN 60947-3	kA	0.24	0.36	0.72			
Rated short-circuit making capacity to EN 60947-3	$I_{cm}$ kA	0.32	0.32	0.6			
Internal resistance	mΩ	6	5	3			

### PKZ-SOL

			PKZ-SOL12	PKZ-SOL20	PKZ-SOL30	PKZ-SOL40	PKZ-SOL50	PKZ-SOL60
Rated operational current at DC-21A/750VDC	$I_e$	A	12	20	30	40	50	63
Number of poles			2	2	2	2	2	2
Rated operational voltage	$U_e$	V DC	900	900	900	900	900	900
Thermal tripping			1.05 ... 1.3 x $I_e$					
Electromagnetic tripping			6 x $I_e$					
Standards			IEC/EN 60 947-2 UL 508, TÜV certificate					
Climatic proofing			Damp heat, constant, to IEC 60 068-2-78 Damp heat, cyclic, to IEC 60 068-2-30					
Ambient temperature								
Open	min./max.	°C	-25 ... +60	-25 ... +60	-25 ... +60	-25 ... +60	-25 ... +60	-25 ... +60
Mounting position								
			PKZ-SOL12 to PKZ-SOL60			PKZ-SOL12 to PKZ-SOL30		
Dimensions								
Width	mm		58	58	58	55	55	55
Height	mm		93	93	93	140	140	140
Depth	mm		76	76	76	160	160	160
Mounting								
Top-hat rail			35 mm	35 mm	35 mm	35 mm	35 mm	35 mm
Screw mounting			–	–	–	2 x M4 x 18 30 x 130	2 x M4 x 18 30 x 130	2 x M4 x 18 30 x 130
Weight	kg		0.32	0.32	0.32	1.25	1.25	1.25
Terminals								
flexible with ferrule	mm <sup>2</sup>		1 x (1-6)	1 x (1-6)	1 x (1-6)	1 x (1-35)	1 x (1-35)	1 x (1-35)
	mm <sup>2</sup>		2 x (1-6)	2 x (1-6)	2 x (1-6)	2 x (1-35)	2 x (1-35)	2 x (1-35)
solid/stranded	AWG		18 - 14	18 - 14	18 - 14	14 - 2	14 - 2	14 - 2
Internal resistance	mΩ		31	12	7	–	–	–

1





## Motor-starter combinations

Combining a motor protective circuit breaker or circuit breaker with a contactor results in a motor starter according to coordination type "1" or "2". Both types of coordination safely control short-circuit by switching it off. Coordination type "2" starters offer a high degree of operational continuity: after the cause of the short circuit has been removed, they can be switched back on immediately.

### Motor-starter combination - motor starter up to 1400 A

- Highest safety through proven combination in coordination type "1" or "2"
- Approved combinations for export to North America

### DOL starter and reversing starter MSC... – motor starter with motor-protective circuit-breaker PKZM0 up to 32A

- Mounted starters minimize wiring time
- Plug & Play with starters on busbar adapters
- Attractive design for high-quality installations
- Direct field bus connection through SmartWire-DT® communication system via plug-in type protective module

### DOL starter and reversing starter MSC-DE... – motor starter with electric motor-protective circuit-breaker PKE up to 32A

- Increased safety through separate contact systems between switching and safety devices
- Direct field bus connection through SmartWire-DT® communication system via plug-in type protective module
- Direct reading of motor current and state, transfer to subordinate control system through SmartWire-DT®

### Conditions for fulfilling type of coordination

- Coordination type: "1": Secure switching off of the entered short-circuit current  $I_q$
- No danger to personnel or installations in case of short-circuit
- For further operation without repair and partial renewal, switch does not need to be suitable
- Damage to the switch or individual components approved
- Coordination type: "2": Secure switching off of the entered short-circuit current  $I_q$
- No danger to personnel or installations in case of short-circuit
- Switch remains suitable for further operation
- No damage to switch, except to welds of protective contacts, when these can be easily separated without significant deformation







### Ordering

Direct-on-line starters MSC-D	
MSC-D complete units	2
MSC-US complete units	4
MSC-DEA complete units	6
Modules PKZM0/PKZM4 + DILM	8
Modules NZMN/NZMH + DILM	12
Modules PKM0 + DILM + ZB	16
Modules NZMN + DILM + ZB	16

### Ordering

Reversing starter MSC-R	
MSC-R complete units	18
Modules PKZM0/PKZM4 + DILM	20
Modules NZMN/NZMH + DILM	22

### Ordering

Starter on busbar adapter	
DOL starter complete units MSC-D/BBA	24
Reversing starters complete units MSC-R/BBA	26

### Ordering

Starter for North America	
Modules type F starter combinations	28
Modules DILEM/DILM + ZE/ZB/Z5/ZW7	29
Modules NZMH-...-CNA + DILM + ZB/Z5/ZW7	30

### System overview, description

Connection system SmartWire-DT®	31
---------------------------------	----

### Ordering

Connection system SmartWire-DT®	32
Accessories	33

### Engineering

Connection system SmartWire-DT®	34
---------------------------------	----

### Technical data

Connection system SmartWire-DT®	35
DOL starters MSC-D, MSC-DE(A)	39
Reversing starter MSC-R	39

### Dimensions

Direct-on-line starter MSC-D	
MSC-D complete units	39
MSC-D/BBA complete units	39
MSC-DE(A) complete units	40
Reversing starter MSC-R	
MSC-R complete units	40
MSC-R/BBA complete units	40
Connection system SmartWire-DT®	41

# 1.4

## Motor-starter combinations

Complete units

### Ordering

1

#### MSC-D: PKZM0, DILM

Motor data				Setting range		Motor starters actuating voltage 230 V 50 Hz	Part no. Article no.	Price See price list	Std. pack
Motor rating	Rated operational current	Rated short-circuit current		Overload trip	Short-circuit release				
AC-3	AC-3	380 - 415 V	380 - 415 V						
380 V 400 V 415 V	400 V	Type "1" coordination	Type "2" coordination						
P kW	$I_b$ A	$I_q$ kA	$I_q$ kA	$I_r$ A	$I_{rm}$ A				
0.06	0.21	150	50	0.16 - 0.25	3.5	<b>MSC-D-0.25-M7(230V50Hz)<sup>1)</sup></b> 281925		1 off	
0.09	0.31	150	50	0.25 - 0.4	5.6	<b>MSC-D-0.4-M7(230V50Hz)<sup>1)</sup></b> 281926		1 off	
0.12 0.18	0.41 0.6	150	50	0.4 - 0.63	8.82	<b>MSC-D-0.63-M7(230V50Hz)<sup>1)</sup></b> 281927		1 off	
0.25	0.8	150	50	0.63 - 1	14	<b>MSC-D-1-M7(230V50Hz)<sup>1)</sup></b> 281929		1 off	
0.37 0.55	1.1 1.5	150	50	1 - 1.6	22.4	<b>MSC-D-1.6-M7(230V50Hz)<sup>1)</sup></b> 283140		1 off	
0.75	1.9	150	50	1.6 - 2.5	35	<b>MSC-D-2.5-M7(230V50Hz)<sup>1)</sup></b> 283142		1 off	
1.1 1.5	2.6 3.6	150	50	2.5 - 4	56	<b>MSC-D-4-M7(230V50Hz)<sup>1)</sup></b> 283143		1 off	
2.2	5	150	50	4 - 6.3	88.2	<b>MSC-D-6.3-M7(230V50Hz)<sup>1)</sup></b> 283145		1 off	
3	6.6	150	–	6.3 - 10	140	<b>MSC-D-10-M7(230V50Hz)</b> 283146		1 off	
4	8.5	150	–	6.3 - 10	140	<b>MSC-D-10-M9(230V50Hz)</b> 283147		1 off	
5.5	11.3	50	–	8 - 12	168	<b>MSC-D-12-M12(230V50Hz)</b> 283148		1 off	
7.5	15.2	50	–	10 - 16	224	<b>MSC-D-16-M15(230V50Hz)</b> 100414		1 off	
3	6.6	50	50	6.3 - 10	140	<b>MSC-D-10-M17(230V50Hz)</b> 101045		1 off	
4	8.5	50	50	6.3 - 10	140	<b>MSC-D-10-M17(230V50Hz)</b> 101045		1 off	
5.5	11.3	50	50	8 - 12	168	<b>MSC-D-12-M17(230V50Hz)</b> 101046		1 off	
7.5	15.2	50	50	10 - 16	224	<b>MSC-D-16-M17(230V50Hz)<sup>1)</sup></b> 283150		1 off	
11	21.7	50	50	20 - 25	350	<b>MSC-D-25-M25(230V50Hz)<sup>1)</sup></b> 283151		1 off	
15	29.3	50	50	25 - 32	448	<b>MSC-D-32-M32(230V50Hz)<sup>1)</sup></b> 283152		1 off	

#### Complete units MSC-D

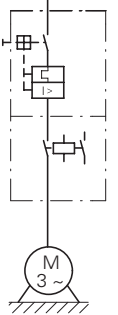
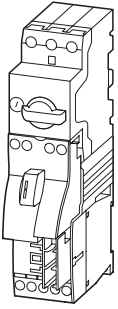

#### Complete units MSC-D

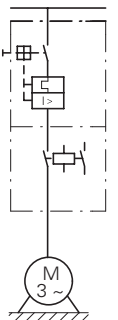
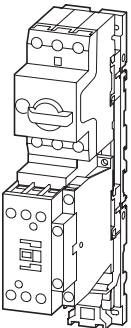

Motor starters actuating voltage 24 V DC	Std. pack	Motor protective circuit breaker	Contactor	DOL starter wiring set	Notes												
Part no. Article no.	Price See price list	Type	Type	Type													
<b>MSC-D-0.25-M7(24VDC)</b> <sup>1)</sup> 283154	1 off	PKZM0-0,25	DILM7-10(...)	PKZM0-XDM12	<p>The DOL starters (complete devices) consist of a motor protective circuit breaker PKZM0 and a contactor DILM. With the adapterless top-hat rail mounting of starters up to 15 A, only the motor-protective circuit-breaker on the top-hat rail requires an adapter. The contactors are provided with mechanical support via a mechanical connection element.</p> <p>Control wire guide with max. 6 conductors with up to 2.5 mm external diameter or 4 conductors up to 3.5 mm external diameter.</p> <p>From 16 A, the motor protective circuit breaker and contactors are mounted on the top-hat rail adapter plate. The connection of the main circuit between PKZ and contactor is established with electrical contact modules. When using auxiliary contacts DILA - XHIT... → Chapter 1.1 (Page 38) the electrical plugs can be pulled without having to remove the front mounting auxiliary contact.</p> <p>Cannot be combined with NHI-E-...-PKZ0-C standard auxiliary contact with spring-loaded terminal.</p>												
<b>MSC-D-0.4-M7(24VDC)</b> <sup>1)</sup> 283155	1 off	PKZM0-0,4	DILM7-10(...)	PKZM0-XDM12													
<b>MSC-D-0.63-M7(24VDC)</b> <sup>1)</sup> 283156	1 off	PKZM0-0,63	DILM7-10(...)	PKZM0-XDM12													
<b>MSC-D-1-M7(24VDC)</b> <sup>1)</sup> 283158	1 off	PKZM0-1	DILM7-10(...)	PKZM0-XDM12													
<b>MSC-D-1.6-M7(24VDC)</b> <sup>1)</sup> 283159	1 off	PKZM0-1,6	DILM7-10(...)	PKZM0-XDM12													
<b>MSC-D-2.5-M7(24VDC)</b> <sup>1)</sup> 283161	1 off	PKZM0-2,5	DILM7-10(...)	PKZM0-XDM12													
<b>MSC-D-4-M7(24VDC)</b> <sup>1)</sup> 283162	1 off	PKZM0-4	DILM7-10(...)	PKZM0-XDM12													
<b>MSC-D-6.3-M7(24VDC)</b> <sup>1)</sup> 283164	1 off	PKZM0-6,3	DILM7-10(...)	PKZM0-XDM12													
<b>MSC-D-10-M7(24VDC)</b> 283165	1 off	PKZM0-10	DILM7-10(...)	PKZM0-XDM12													
<b>MSC-D-10-M9(24VDC)</b> 283166	1 off	PKZM0-10	DILM9-10(...)	PKZM0-XDM12													
<b>MSC-D-12-M12(24VDC)</b> 283167	1 off	PKZM0-12	DILM12-10(...)	PKZM0-XDM12	<table border="0"> <tr> <td><b>Further information</b></td> <td><b>Page</b></td> </tr> <tr> <td>Technical data PKZM0</td> <td>→ Chapter 1.3</td> </tr> <tr> <td>Accessories PKZ</td> <td>→ Chapter 1.3 (Page 10)</td> </tr> <tr> <td>Technical data DILM</td> <td>→ Chapter 1.1</td> </tr> <tr> <td>Further actuating voltages</td> <td>→ Chapter 1.1 (Page 69)</td> </tr> <tr> <td>DILM accessories</td> <td>→ Chapter 1.1 (Page 50)</td> </tr> </table>	<b>Further information</b>	<b>Page</b>	Technical data PKZM0	→ Chapter 1.3	Accessories PKZ	→ Chapter 1.3 (Page 10)	Technical data DILM	→ Chapter 1.1	Further actuating voltages	→ Chapter 1.1 (Page 69)	DILM accessories	→ Chapter 1.1 (Page 50)
<b>Further information</b>	<b>Page</b>																
Technical data PKZM0	→ Chapter 1.3																
Accessories PKZ	→ Chapter 1.3 (Page 10)																
Technical data DILM	→ Chapter 1.1																
Further actuating voltages	→ Chapter 1.1 (Page 69)																
DILM accessories	→ Chapter 1.1 (Page 50)																
<b>MSC-D-10-M17(24VDC)</b> 101047	1 off	PKZM0-10	DILM17-10(...)	PKZM0-XDM32													
<b>MSC-D-12-M17(24VDC)</b> 101048	1 off	PKZM0-12	DILM17-10(...)	PKZM0-XDM32													
<b>MSC-D-16-M17(24VDC)</b> 283168	1 off	PKZM0-16	DILM17-10(...)	PKZM0-XDM32													
<b>MSC-D-25-M25(24VDC)</b> 283169	1 off	PKZM0-25	DILM25-10(...)	PKZM0-XDM32													
<b>MSC-D-32-M32(24VDC)</b> 283170	1 off	PKZM0-32	DILM32-10(...)	PKZM0-XDM32													

<sup>1)</sup> To assemble Type F starters that conform with UL508, incoming terminals BK25/3-PKZ0-E and, if necessary, three-phase terminal blocks B3.../...-PKZ0 can be added to motor starter combinations. Type F starter → Page 28

# 1.4

## Motor-starter combinations

Complete units 400/415 V

1

### MSC-DE: PKE, DILM

Motor data			Setting range			Motor starters actuating voltage 230 V 50 Hz	Std. pack
Rated operational power AC-3	Rated operational current AC-3	Rated short- circuit current	Overload trip	Short- circuit release	Type of coordina- tion	Part no. Article no.	Price See price list
380 V 400 V 415 V	400 V	380 - 415 V					
P kW	$I_e$ A	$I_q$ kA	$I_r$ A	$I_{rm}$ A			
0.06	0.21	100	0.3 - 1.2	16.8	"1"	<b>MSC-DE-1.2-M7(230V50Hz)</b> 121735	1 off
0.09	0.31	100	0.3 - 1.2	16.8	"1"	<b>MSC-DE-1.2-M7(230V50Hz)</b> 121735	1 off
0.12	0.41	100	0.3 - 1.2	16.8	"1"	<b>MSC-DE-1.2-M7(230V50Hz)</b> 121735	1 off
0.18	0.6	100	0.3 - 1.2	16.8	"1"	<b>MSC-DE-1.2-M7(230V50Hz)</b> 121735	1 off
0.25	0.8	100	0.3 - 1.2	16.8	"1"	<b>MSC-DE-1.2-M7(230V50Hz)</b> 121735	1 off
0.37	1.1	100	0.3 - 1.2	16.8	"1"	<b>MSC-DE-1.2-M7(230V50Hz)</b> 121735	1 off
0.55	1.5	100	1 - 4	56	"1"	<b>MSC-DE-4-M7(230V50Hz)</b> 121737	1 off
0.75	1.9	100	1 - 4	56	"1"	<b>MSC-DE-4-M7(230V50Hz)</b> 121737	1 off
1.1	2.6	100	1 - 4	56	"1"	<b>MSC-DE-4-M7(230V50Hz)</b> 121737	1 off
1.5	3.6	100	1 - 4	56	"1"	<b>MSC-DE-4-M7(230V50Hz)</b> 121737	1 off
2.2	5	100	3 - 12	168	"1"	<b>MSC-DE-12-M7(230V50Hz)</b> 121739	1 off
3	6.6	100	3 - 12	168	"1"	<b>MSC-DE-12-M7(230V50Hz)</b> 121739	1 off
4	8.5	100	3 - 12	168	"1"	<b>MSC-DE-12-M9(230V50Hz)</b> 121741	1 off
5.5	11.3	100	3 - 12	168	"1"	<b>MSC-DE-12-M12(230V50Hz)</b> 121743	1 off
2.2	5	100	3 - 12	168	"1", "2"	<b>MSC-DE-12-M17(230V50Hz)</b> 121745	1 off
3	6.6	100	3 - 12	168	"1", "2"	<b>MSC-DE-12-M17(230V50Hz)</b> 121745	1 off
4	8.5	100	3 - 12	168	"1", "2"	<b>MSC-DE-12-M17(230V50Hz)</b> 121745	1 off
5.5	11.3	100	3 - 12	168	"1", "2"	<b>MSC-DE-12-M17(230V50Hz)</b> 121745	1 off
7.5	16.7	100	8 - 32	448	"1", "2"	<b>MSC-DE-32-M17(230V50Hz)</b> 121747	1 off
11	21.7	100	8 - 32	448	"1", "2"	<b>MSC-DE-32-M25(230V50Hz)</b> 121749	1 off
15	29.3	100	8 - 32	448	"1", "2"	<b>MSC-DE-32-M32(230V50Hz)</b> 121751	1 off

#### Complete units MSC-US

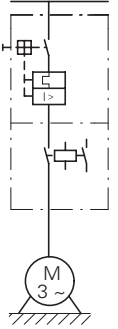
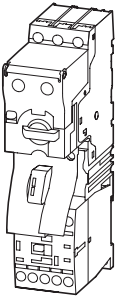

#### Complete units MSC-US

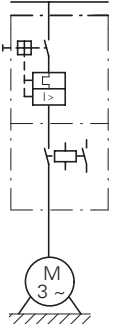
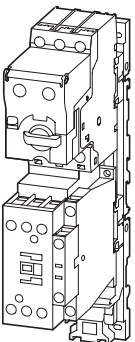

Motor starters actuating voltage 24 V DC	Std. pack	Motor protective circuit breaker	Contactor	DOL starter wiring set	Notes
Part no. Article no.	Price See price list	Type	Type	Type	
<b>MSC-DE-1.2-M7(24VDC)</b> 121736	1 off	PKE12/XTU-1.2	DILM7-10(...)	PKZM0-XDM12	<p>The DOL starters (complete devices) consist of a PKE motor protective circuit breaker and a DILM contactor. With the adapterless top-hat rail mounting of starters up to 15 A, only the motor protective circuit breaker on the top-hat rail requires an adapter. The contactors are provided with mechanical support via a mechanical connection element. Control wire guide with max. 6 conductors with up to 2.5 mm external diameter or 4 conductors up to 3.5 mm external diameter. From 16 A, the motor protective circuit breaker and contactor are mounted on the top-hat rail adapter plate. The connection of the main circuit between PKE and contactor is established with electrical contact modules. When using auxiliary contacts DILA-XHIT... → Chapter 1.1 (Page 38) the electrical plugs can be pulled without having to remove the front mounting auxiliary contact. Cannot be combined with standard auxiliary contact NHI-E....-PKZ0-C with spring-loaded terminals.</p>
<b>MSC-DE-1.2-M7(24VDC)</b> 121736	1 off	PKE12/XTU-1.2	DILM7-10(...)	PKZM0-XDM12	
<b>MSC-DE-1.2-M7(24VDC)</b> 121736	1 off	PKE12/XTU-1.2	DILM7-10(...)	PKZM0-XDM12	
<b>MSC-DE-1.2-M7(24VDC)</b> 121736	1 off	PKE12/XTU-1.2	DILM7-10(...)	PKZM0-XDM12	
<b>MSC-DE-1.2-M7(24VDC)</b> 121736	1 off	PKE12/XTU-1.2	DILM7-10(...)	PKZM0-XDM12	
<b>MSC-DE-1.2-M7(24VDC)</b> 121736	1 off	PKE12/XTU-1.2	DILM7-10(...)	PKZM0-XDM12	
<b>MSC-DE-4-M7(24VDC)</b> 121738	1 off	PKE12/XTU-4	DILM7-10(...)	PKZM0-XDM12	
<b>MSC-DE-4-M7(24VDC)</b> 121738	1 off	PKE12/XTU-4	DILM7-10(...)	PKZM0-XDM12	
<b>MSC-DE-4-M7(24VDC)</b> 121738	1 off	PKE12/XTU-4	DILM7-10(...)	PKZM0-XDM12	
<b>MSC-DE-4-M7(24VDC)</b> 121738	1 off	PKE12/XTU-4	DILM7-10(...)	PKZM0-XDM12	
<b>MSC-DE-12-M7(24VDC)</b> 121740	1 off	PKE12/XTU-12	DILM7-10(...)	PKZM0-XDM12	<p><b>Further information</b></p> <p>Technical data PKE → Chapter 1.3</p> <p>Accessories PKE → Chapter 1.3 (Page 10)</p> <p>Technical data DILM → Chapter 1.1</p> <p>Further actuating voltages → Chapter 1.1 (Page 69)</p> <p>DILM accessories → Chapter 1.1 (Page 50)</p>
<b>MSC-DE-12-M7(24VDC)</b> 121740	1 off	PKE12/XTU-12	DILM7-10(...)	PKZM0-XDM12	
<b>MSC-DE-12-M9(24VDC)</b> 121742	1 off	PKE12/XTU-12	DILM9-10(...)	PKZM0-XDM12	
<b>MSC-DE-12-M12(24VDC)</b> 121744	1 off	PKE12/XTU-12	DILM12-10(...)	PKZM0-XDM12	
<b>MSC-DE-12-M17(24VDC)</b> 121746	1 off	PKE12/XTU-12	DILM17-10(...)	PKZM0-XDM32	
<b>MSC-DE-12-M17(24VDC)</b> 121746	1 off	PKE12/XTU-12	DILM17-10(...)	PKZM0-XDM32	
<b>MSC-DE-12-M17(24VDC)</b> 121746	1 off	PKE12/XTU-12	DILM17-10(...)	PKZM0-XDM32	
<b>MSC-DE-12-M17(24VDC)</b> 121746	1 off	PKE12/XTU-12	DILM17-10(...)	PKZM0-XDM32	
<b>MSC-DE-32-M17(24VDC)</b> 121748	1 off	PKE32/XTU-32	DILM17-10(...)	PKZM0-XDM32	
<b>MSC-DE-32-M25(24VDC)</b> 121750	1 off	PKE32/XTU-32	DILM25-10(...)	PKZM0-XDM32	
<b>MSC-DE-32-M32(24VDC)</b> 121752	1 off	PKE32/XTU-32	DILM32-10(...)	PKZM0-XDM32	

# 1.4

## Motor-starter combinations

Complete units 400/415 V



1

### MSC-DEA: PKE, DILM

#### Motor data

#### Setting range

Rated operational power AC-3 380 V 400 V 415 V	Rated operational current AC-3 400 V	Rated short-circuit current 380 - 415 V	Overload trip	Short-circuit release	Type of coordination
--	--	--	---------------	-----------------------	----------------------

P kW	$I_e$ A	$I_q$ kA	$I_r$ A 	$I_{rm}$ A 	
0.06	0.21	100	0.3 - 1.2	16.8	"1"
0.09	0.31	100	0.3 - 1.2	16.8	"1"
0.12	0.41	100	0.3 - 1.2	16.8	"1"
0.18	0.6	100	0.3 - 1.2	16.8	"1"
0.25	0.8	100	0.3 - 1.2	16.8	"1"
0.37	1.1	100	0.3 - 1.2	16.8	"1"
0.55	1.5	100	1 - 4	56	"1"
0.75	1.9	100	1 - 4	56	"1"
1.1	2.6	100	1 - 4	56	"1"
1.5	3.6	100	1 - 4	56	"1"
2.2	5	100	3 - 12	168	"1"
3	6.6	100	3 - 12	168	"1"
4	8.5	100	3 - 12	168	"1"
5.5	11.3	100	3 - 12	168	"1"
2.2	5	100	3 - 12	168	"1", "2"
3	6.6	100	3 - 12	168	"1", "2"
4	8.5	100	3 - 12	168	"1", "2"
5.5	11.3	100	3 - 12	168	"1", "2"
7.5	16.7	100	8 - 32	448	"1", "2"
11	21.7	100	8 - 32	448	"1", "2"
15	29.3	100	8 - 32	448	"1", "2"

#### Complete devices MSD-DEA

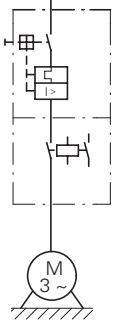
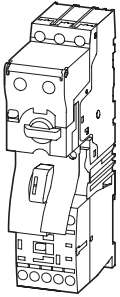

#### Complete devices MSD-DEA

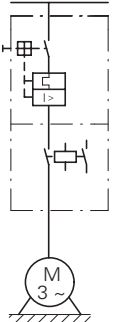
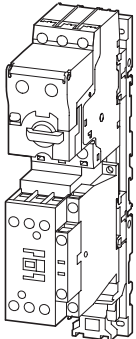

Motor starters actuating voltage 24 V DC	Std. pack	Motor protective circuit breaker	Contactor	DOL starter wiring set	Notes												
Part no. Article no.	Price See price list	Type	Type	Type													
<b>MSC-DEA-1.2-M7(24VDC)</b> 121753	1 off	PKE12/XTUA-1.2	DILM7-10(...)	PKZM0-XDM12	<p>The DOL starters (complete devices) consist of a PKE motor protective circuit breaker and a DILM contactor. With the adapterless top-hat rail mounting of starters up to 15 A, only the motor protective circuit breaker on the top-hat rail requires an adapter. The contactors are provided with mechanical support via a mechanical connection element. Control wire guide with max. 6 conductors with up to 2.5 mm external diameter or 4 conductors up to 3.5 mm external diameter. From 16 A, the motor protective circuit breaker and contactor are mounted on the top-hat rail adapter plate. The connection of the main circuit between PKE and contactor is established with electrical contact modules. When using auxiliary contacts DILA - XHIT... → Chapter 1.1 (Page 38) the electrical plugs can be pulled without having to remove the front mounting auxiliary contact. Cannot be combined with standard auxiliary contact NHI-E...-PKZO-C with spring-loaded terminals. The DOL starters MSC-DEA... are prepared for communication via SmartWire-DT®. For this the SWD-PKE communication must be added.</p> <table border="0"> <tr> <td><b>Further information</b></td> <td><b>Page</b></td> </tr> <tr> <td>Technical data PKE</td> <td>→ Chapter 1.3</td> </tr> <tr> <td>Accessories PKE</td> <td>→ Chapter 1.3 (Page 10)</td> </tr> <tr> <td>Technical data DILM</td> <td>→ Chapter 1.1</td> </tr> <tr> <td>Further actuating voltages</td> <td>→ Chapter 1.1 (Page 69)</td> </tr> <tr> <td>DILM accessories</td> <td>→ Chapter 1.1 (Page 50)</td> </tr> </table>	<b>Further information</b>	<b>Page</b>	Technical data PKE	→ Chapter 1.3	Accessories PKE	→ Chapter 1.3 (Page 10)	Technical data DILM	→ Chapter 1.1	Further actuating voltages	→ Chapter 1.1 (Page 69)	DILM accessories	→ Chapter 1.1 (Page 50)
<b>Further information</b>	<b>Page</b>																
Technical data PKE	→ Chapter 1.3																
Accessories PKE	→ Chapter 1.3 (Page 10)																
Technical data DILM	→ Chapter 1.1																
Further actuating voltages	→ Chapter 1.1 (Page 69)																
DILM accessories	→ Chapter 1.1 (Page 50)																
<b>MSC-DEA-1.2-M7(24VDC)</b> 121753	1 off	PKE12/XTUA-1.2	DILM7-10(...)	PKZM0-XDM12													
<b>MSC-DEA-1.2-M7(24VDC)</b> 121753	1 off	PKE12/XTUA-1.2	DILM7-10(...)	PKZM0-XDM12													
<b>MSC-DEA-1.2-M7(24VDC)</b> 121753	1 off	PKE12/XTUA-1.2	DILM7-10(...)	PKZM0-XDM12													
<b>MSC-DEA-1.2-M7(24VDC)</b> 121753	1 off	PKE12/XTUA-1.2	DILM7-10(...)	PKZM0-XDM12													
<b>MSC-DEA-1.2-M7(24VDC)</b> 121753	1 off	PKE12/XTUA-1.2	DILM7-10(...)	PKZM0-XDM12													
<b>MSC-DEA-4-M7(24VDC)</b> 121754	1 off	PKE12/XTUA-4	DILM7-10(...)	PKZM0-XDM12													
<b>MSC-DEA-4-M7(24VDC)</b> 121754	1 off	PKE12/XTUA-4	DILM7-10(...)	PKZM0-XDM12													
<b>MSC-DEA-4-M7(24VDC)</b> 121754	1 off	PKE12/XTUA-4	DILM7-10(...)	PKZM0-XDM12													
<b>MSC-DEA-4-M7(24VDC)</b> 121754	1 off	PKE12/XTUA-4	DILM7-10(...)	PKZM0-XDM12													
<b>MSC-DEA-12-M7(24VDC)</b> 121755	1 off	PKE12/XTUA-12	DILM7-10(...)	PKZM0-XDM12													
<b>MSC-DEA-12-M7(24VDC)</b> 121755	1 off	PKE12/XTUA-12	DILM7-10(...)	PKZM0-XDM12													
<b>MSC-DEA-12-M9(24VDC)</b> 121756	1 off	PKE12/XTUA-12	DILM9-10(...)	PKZM0-XDM12													
<b>MSC-DEA-12-M12(24VDC)</b> 121757	1 off	PKE12/XTUA-12	DILM12-10(...)	PKZM0-XDM12													
<b>MSC-DEA-12-M17(24VDC)</b> 121758	1 off	PKE12/XTUA-12	DILM17-10(...)	PKZM0-XDM32													
<b>MSC-DEA-12-M17(24VDC)</b> 121758	1 off	PKE12/XTUA-12	DILM17-10(...)	PKZM0-XDM32													
<b>MSC-DEA-12-M17(24VDC)</b> 121758	1 off	PKE12/XTUA-12	DILM17-10(...)	PKZM0-XDM32													
<b>MSC-DEA-12-M17(24VDC)</b> 121758	1 off	PKE12/XTUA-12	DILM17-10(...)	PKZM0-XDM32													
<b>MSC-DEA-32-M17(24VDC)</b> 121759	1 off	PKE32/XTUA-32	DILM17-10(...)	PKZM0-XDM32													
<b>MSC-DEA-32-M25(24VDC)</b> 121760	1 off	PKE32/XTUA-32	DILM25-10(...)	PKZM0-XDM32													
<b>MSC-DEA-32-M32(24VDC)</b> 121761	1 off	PKE32/XTUA-32	DILM32-10(...)	PKZM0-XDM32													

# 1.4

## Motor-starter combinations Modules

1

### PKZM, DILM

#### Motor data

#### Setting range

Rated operational power	Rated operational current		Voltage		Overload trip	Short-circuit release
AC-3	AC-3	380 - 415 V	380 - 415 V			
380 V 400 V 415 V	400 V	Type "1" coordination	Type "2" coordination			
P kW	$I_e$ A	$I_q$ kA	$I_q$ kA	$I_r$ A	$I_m$ A	
0.06	0.21	150	50	0.16 - 0.25	3.5	
0.09	0.31	150	50	0.25 - 0.4	5.6	
0.12	0.41	150	50	0.4 - 0.63	8.82	
0.18	0.6	150	50	0.4 - 0.63	8.82	
0.25	0.8	150	50	0.63 - 1	14	
0.37	1.1	150	50	1 - 1.6	22.4	
0.55	1.5	150	50	1 - 1.6	22.4	
0.75	1.9	150	50	1.6 - 2.5	35	
1.1	2.6	150	50	2.5 - 4	56	
1.5	3.6	150	50	2.5 - 4	56	
2.2	5	150	50	4 - 6.3	88.2	
3	6.6	150	50	6.3 - 10	140	
4	8.5	150	50	6.3 - 10	140	
5.5	11.3	50	50	8 - 12	168	
7.5	15.2	50	50	10 - 16	224	
11	21.7	50	50	20 - 25	350	
15	29.3	50	50	25 - 32	448	
5.5	11.3	50	50	10 - 16	224	
7.5	15.2	50	50	10 - 16	224	
11	21.7	50	50	20 - 25	350	
15	29.3	50	50	25 - 32	448	
18.5	36	50	50	32 - 40	560	
22	41	50	50	40 - 50	700	
30	55	50	50	50 - 58	812	
34	63	50	50	55 - 65	882	

#### Modules PKZM0 and DILM

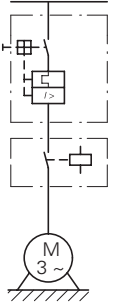

#### Modules PKZM4 and DILM

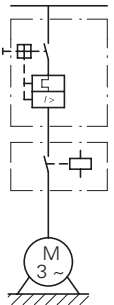



Motor protective circuit breaker	Contactor	Contactor	Notes
	Type "1" coordination	Type "2" coordination	
Type	Type	Type	
PKZM0-0,25	DILM7-...(…)	DILM7-...(…)	<p>The motor-starter combinations consist of the motor protective circuit breaker or a circuit breaker and a contactor. They conform with IEC/EN 60947-4-1 or VDE 0660 Part 102.</p> <p><math>I_q</math> = conditional rated current</p> <p><b>Further information</b></p> <p>Technical data PKZM0</p> <p>Accessories PKZ</p> <p>Technical data DILM</p> <p>Further actuating voltages</p> <p>DILM accessories</p>
PKZM0-0,4	DILM7-...(…)	DILM7-...(…)	
PKZM0-0,63	DILM7-...(…)	DILM7-...(…)	
PKZM0-0,63	DILM7-...(…)	DILM7-...(…)	
PKZM0-1	DILM7-...(…)	DILM7-...(…)	
PKZM0-1,6	DILM7-...(…)	DILM7-...(…)	
PKZM0-1,6	DILM7-...(…)	DILM7-...(…)	
PKZM0-2,5	DILM7-...(…)	DILM7-...(…)	
PKZM0-4	DILM7-...(…)	DILM7-...(…)	
PKZM0-4	DILM7-...(…)	DILM7-...(…)	
PKZM0-6,3	DILM7-...(…)	DILM7-...(…)	<p><b>Page</b></p> <p>→ Chapter 1.3</p> <p>→ Chapter 1.3 (Page 10)</p> <p>→ Chapter 1.1</p> <p>→ Chapter 1.1 (Page 69)</p> <p>→ Chapter 1.1 (Page 50)</p>
PKZM0-10	DILM7-...(…)	DILM17-...(…)	
PKZM0-10	DILM9-...(…)	DILM17-...(…)	
PKZM0-12	DILM12-...(…)	DILM17-...(…)	
PKZM0-16	DILM15-...(…)	DILM17-...(…)	
PKZM0-25	DILM25-...(…)	DILM25-...(…)	
PKZM0-32	DILM32-...(…)	DILM32-...(…)	
PKZM4-16	DILM17-...(…)	DILM17-...(…)	
PKZM4-16	DILM17-...(…)	DILM17-...(…)	
PKZM4-25	DILM25-...(…)	DILM25-...(…)	
PKZM4-32	DILM32-...(…)	DILM32-...(…)	<p><math>I_q</math> = conditional rated current</p> <p><b>Further information</b></p> <p>Technical data PKZM4</p> <p>Accessories PKZ</p> <p>Technical data DILM</p> <p>Further actuating voltages</p> <p>DILM accessories</p>
PKZM4-40	DILM40(…)	DILM40(…)	
PKZM4-50	DILM50(…)	DILM50(…)	
PKZM4-58	DILM65(…)	DILM65(…)	
PKZM4-63	DILM65(…)	DILM65(…)	
PKZM4-63	DILM65(…)	DILM65(…)	

# 1.4

## Motor-starter combinations Modules

1



### PKZM, DILM

#### Motor data

Rated operational power	Rated operational current	Rated short-circuit current	
AC-3	AC-3	500 V	500 V
500 V	500 V	Type "1" coordination	Type "2" coordination

#### Setting range

Overload trip	Short-circuit release
---------------	-----------------------

P kW	$I_e$ A	$I_q$ kA	$I_q$ kA	$I_r$ A 	$I_{rm}$ A 
0.06	0.17	100	50	0.16 - 0.25	3.5
0.09	0.25	100	50	0.25 - 0.4	5.6
0.12	0.33	100	50	0.25 - 0.4	5.6
0.18	0.48	100	50	0.4 - 0.63	8.8
0.25	0.7	100	50	0.63 - 1	14
0.37	0.9	100	50	0.63 - 1	14
0.55	1.2	100	50	1 - 1.6	22
0.75	1.5	100	50	1 - 1.6	22
1.1	2.1	100	50	1.6 - 2.5	35
1.5	2.9	100	50	2.5 - 4	56
2.2	4	42	18	4 - 6.3	88
2.2	4	—	50	4 - 6.3	88
3	5.3	42	18	4 - 6.3	88
3	5.3	—	50	4 - 6.3	88
4	6.8	42	18	6.3 - 10	140
4	6.8	—	50	6.3 - 10	140
5.5	9	42	18	6.3 - 10	140
5.5	9	—	50	6.3 - 10	140
6.5	10.6	42	18	8 - 12	168
6.5	10.6	—	50	8 - 12	168
7.5	12.1	15	18	10 - 16	224
7.5	12.1	—	50	10 - 16	224
11	17.4	6	—	16 - 20	280
11	17.4	15	—	16 - 20	280
15	23.4	6	—	20 - 25	350
15	23.4	15	—	20 - 25	350
18.5	28.9	6	—	25 - 32	448
18.5	28.9	15	—	25 - 32	448
11	17.4	50	50	16 - 25	350
15	23.4	50	50	16 - 25	350
18.5	28.9	50	50	25 - 32	448
22	33	50	50	32 - 40	560
30	44	50	50	40 - 50	700
37	54	50	50	50 - 58	812
45	65	50	50	55 - 65	882

#### Modules PKZM0 and DILM

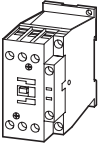
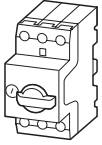

#### Modules PKZM4 and DILM

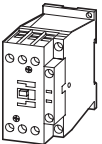
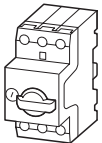

Motor protective circuit breaker	Contactor Type "1" coordination	Contactor Type "2" coordination	Current limiter	Notes	
Type	Type	Type	Type		
PKZM0-0,25	DILM7-...(…)	DILM7-...(…)	–	The motor-starter combinations consist of the motor protective circuit breaker or a circuit breaker and a contactor. They conform with IEC/EN 60947-4-1 or VDE 0660 Part 102. I <sub>q</sub> = rated conditional short-circuit current.	
PKZM0-0,4	DILM7-...(…)	DILM7-...(…)	–		
PKZM0-0,4	DILM7-...(…)	DILM7-...(…)	–		
PKZM0-0,63	DILM7-...(…)	DILM7-...(…)	–		
PKZM0-1	DILM7-...(…)	DILM7-...(…)	–		
PKZM0-1	DILM7-...(…)	DILM7-...(…)	–		
PKZM0-1,6	DILM7-...(…)	DILM7-...(…)	–		
PKZM0-1,6	DILM7-...(…)	DILM7-...(…)	–		
PKZM0-2,5	DILM7-...(…)	DILM17-...(…)	–		
PKZM0-4	DILM7-...(…)	DILM17-...(…)	–		
PKZM0-6,3	DILM7-...(…)	DILM17-...(…)	–	<b>Further information</b> Technical data PKZM... PKZM accessories... Technical data DILM Further actuating voltages DILM accessories	
PKZM0-6,3	–	DILM17-...(…)	CL-PKZ0		
PKZM0-6,3	DILM7-...(…)	DILM17-...(…)	–		
PKZM0-6,3	–	DILM17-...(…)	CL-PKZ0		
PKZM0-10	DILM9-...(…)	DILM17-...(…)	–		
PKZM0-10	–	DILM17-...(…)	CL-PKZ0		
PKZM0-10	DILM9-...(…)	DILM17-...(…)	–		
PKZM0-10	–	DILM17-...(…)	CL-PKZ0		
PKZM0-12	DILM12-...(…)	DILM17-...(…)	–		
PKZM0-12	–	DILM17-...(…)	CL-PKZ0		
PKZM0-16	DILM17-...(…)	DILM17-...(…)	–	<b>Further information</b> Technical data PKZM... PKZM accessories... Technical data DILM Further actuating voltages DILM accessories	
PKZM0-16	–	DILM17-...(…)	CL-PKZ0		
PKZM0-20	DILM25-...(…)	–	–		
PKZM0-20	DILM25-...(…)	–	CL-PKZ0		
PKZM0-25	DILM25-...(…)	–	–		
PKZM0-25	DILM25-...(…)	–	CL-PKZ0		
PKZM0-32	DILM32-...(…)	–	–		
PKZM0-32	DILM32-...(…)	–	CL-PKZ0		
PKZM4-25	DILM40(…)	DILM40(…)	–		The motor-starter combinations consist of the motor protective circuit breaker or a circuit breaker and a contactor. They conform with IEC/EN 60947-4-1 or VDE 0660 Part 102. I <sub>q</sub> = rated conditional short-circuit current.
PKZM4-25	DILM40(…)	DILM40(…)	–		
PKZM4-32	DILM40(…)	DILM40(…)	–		
PKZM4-40	DILM40(…)	DILM40(…)	–		
PKZM4-50	DILM50(…)	DILM50(…)	–		
PKZM4-58	DILM65(…)	DILM65(…)	–		
PKZM4-63	DILM65(…)	DILM65(…)	–		

# 1.4

## Motor-starter combinations Modules

1

### NZMN, NZMH, DILM

#### Motor data

Rated operational power AC-3	Rated operational current AC-3	Rated short-circuit current
380 V 400 V 415 V	400 V	400/415 V
P kW	$I_e$ A	$I_q$ kA

#### Setting range

Overload trip	Short-circuit release
---------------	-----------------------



#### Modules NZMN and DILM

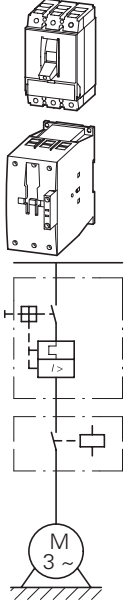

18.5	36	50	32 - 40	320 - 560
22	41	50	40 - 50	400 - 700
30	55	50	50 - 63	504 - 882
37	68	50	63 - 80	640 - 1120
45	81	50	80 - 100	800 - 1250
55	99	50	80 - 100	800 - 1250
75	134	50	125 - 160	1280 - 2240
90	161	50	160 - 200	1600 - 2500
110	196	50	160 - 200	1600 - 2500
132	231	50	175 - 350	350 - 4900
160	279	50	175 - 350	350 - 4900
200	349	50	175 - 350	350 - 4900
250	437	50	225 - 450	450 - 6300
315	544	50	275 - 550	550 - 7700
400	683	50	438 - 875	875 - 12250
450	750	50	438 - 875	875 - 12250
500	820	50	438 - 875	875 - 12250
560	947	50	700 - 1400	1400 - 19600

#### Modules NZMH and DILM

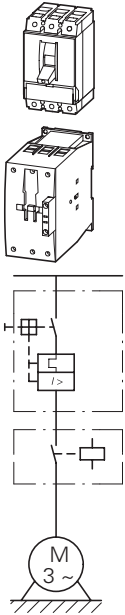

22	41	100	40 - 50	400 - 700
30	55	100	50 - 63	504 - 882
37	68	100	63 - 80	640 - 1120
45	81	100	80 - 100	800 - 1250
55	100	100	100 - 125	1000 - 1750
75	134	100	125 - 160	1280 - 2240
30	55	100	45 - 90	90 - 1260
37	68	100	45 - 90	90 - 1260
45	81	100	45 - 90	90 - 1260
55	100	100	70 - 140	140 - 1960
75	134	100	70 - 140	140 - 1960
90	161	100	110 - 120	220 - 3080
110	196	100	110 - 120	220 - 3080
132	231	100	175 - 350	350 - 4900
160	279	100	175 - 350	350 - 4900
200	349	100	175 - 350	350 - 4900

Notes

<b>Circuit-breaker</b>	<b>Contactor</b>	<b>Contactor</b>
	Type "1" coordination	Type "2" coordination

<b>Type</b>	<b>Type</b>	<b>Type</b>
-------------	-------------	-------------

NZMN1-M40	DILM40(...)	DILM80(...)	The motor-starter combinations consist of the motor protective circuit breaker or a circuit breaker and a contactor. They conform with IEC/EN 60947-4-1 or VDE 0660 Part 102. $I_q$ = conditional rated current
NZMN1-M50	DILM50(...)	DILM80(...)	
NZMN1-M63	DILM65(...)	DILM80(...)	
NZMN1-M80	DILM80(...)	DILM80(...)	
NZMN1-M100	DILM95(...)	DILM95(...)	
NZMN1-M100	DILM115(...)	DILM115(...)	
NZMN2-M160	DILM150(...)	DILM150(...)	
NZMN2-M200	DILM185A/22(...)	DILM185A/22(...)	
NZMN2-M200	DILM225A/22(...)	DILM225A/22(...)	
NZMN3-ME350	DILM250/22(...)	DILM250/22(...)	
NZMN3-ME350	DILM300A/22(...)	DILM300A/22(...)	
NZMN3-ME350	DILM400/22(...)	DILM400/22(...)	
NZMN3-ME450	DILM500/22(...)	DILM500/22(...)	
NZMN4-ME550	DILM580/22(...)	–	
NZMN4-ME875	DILM650/22(...)	–	
NZMN4-ME875	DILM750/22(...)	–	
NZMN4-ME875	DILM820/22(...)	–	
NZMN4-ME1400	DILM1000/22(...)	–	

NZMH2-M50	DILM80(...)	DILM80(...)	The motor-starter combinations consist of the motor protective circuit breaker or a circuit breaker and a contactor. They conform with IEC/EN 60947-4-1 or VDE 0660 Part 102. $I_q$ = conditional rated current
NZMH2-M63	DILM80(...)	DILM80(...)	
NZMH2-M80	DILM80(...)	DILM80(...)	
NZMH2-M100	DILM95(...)	DILM95(...)	
NZMH2-M125	DILM115(...)	DILM115(...)	
NZMH2-M160	DILM150(...)	DILM150(...)	
NZMH2-ME90	DILM80(...)	DILM80(...)	
NZMH2-ME90	DILM80(...)	DILM80(...)	
NZMH2-ME90	DILM95(...)	DILM95(...)	
NZMH2-ME140	DILM115(...)	DILM115(...)	
NZMH2-ME140	DILM150(...)	DILM150(...)	
NZMH2-ME220	DILM185A/22(...)	DILM185A/22(...)	
NZMH2-ME220	DILM225A/22(...)	DILM225A/22(...)	
NZMH3-ME350	DILM250/22(...)	DILM250/22(...)	
NZMH3-ME350	DILM300A/22(...)	DILM300A/22(...)	
NZMH3-ME350	DILM400/22(...)	DILM400/22(...)	

# 1.4 Motor-starter combinations

Modules

## 1 Modules NZMH and DILM

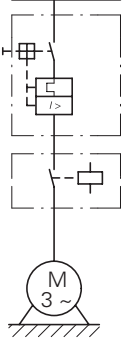
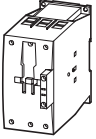
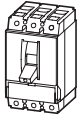

### NZMH, DILM

#### Motor data

Rated operational power AC-3	Rated operational current		Rated short-circuit current
500 V 525 V	500 V	525 V	500/525 V

#### Setting range

Overload trip	Short-circuit release
---------------	-----------------------

P kW	$I_e$ A	$I_e$ A	$I_q$ kA	$I_r$ A	$I_{rm}$ A
11	17.4	17	50	16 - 20	350 - 350
15	23.4	22.5	50	20 - 25	350 - 350
18.5	28.9	28	50	25 - 32	320 - 448
22	33	32	50	32 - 40	320 - 560
30	44	43	50	40 - 50	400 - 700
37	54	54	50	50 - 63	504 - 882
45	65	64	50	63 - 80	640 - 1120
55	79	78	50	63 - 80	640 - 1120
75	107	106	50	100 - 125	1000 - 1750
90	129	127	50	125 - 160	1280 - 2240
30	44	43	50	45 - 90	90 - 1260
37	54	54	50	45 - 90	90 - 1260
45	65	64	50	45 - 90	90 - 1260
55	79	78	50	45 - 90	90 - 1260
75	107	106	50	70 - 140	140 - 1960
90	129	127	50	70 - 140	140 - 1960



Circuit-breaker	Contactor	Contactor	Notes
	Type "1" coordination	Type "2" coordination	
Type	Type	Type	
NZMH2-M20	DILM40(...)	DILM80(...)	The motor-starter combinations consist of the motor protective circuit breaker or a circuit breaker and a contactor. They conform with IEC/EN 60947-4-1 or VDE 0660 Part 102. $I_q$ = conditional rated current
NZMH2-M25	DILM40(...)	DILM80(...)	
NZMH2-M32	DILM40(...)	DILM80(...)	
NZMH2-M40	DILM40(...)	DILM80(...)	
NZMH2-M50	DILM80(...)	DILM80(...)	
NZMH2-M63	DILM80(...)	DILM80(...)	
NZMH2-M80	DILM80(...)	DILM80(...)	
NZMH2-M80	DILM80(...)	DILM80(...)	
NZMH2-M125	DILM115(...)	DILM115(...)	
NZMH2-M160	DILM150(...)	DILM150(...)	
NZMH2-ME90	DILM80(...)	DILM80(...)	
NZMH2-ME90	DILM80(...)	DILM80(...)	
NZMH2-ME90	DILM80(...)	DILM80(...)	
NZMH2-ME140	DILM115(...)	DILM115(...)	
NZMH2-ME140	DILM150(...)	DILM150(...)	

# 1.4 Motor-starter combinations

## Modules

1

### PKZM0, DILM, ZB; NZMN1, DILM, ZB

Motor data			Setting range		Basic unit
Rated operational power	Rated operational current	Rated short-circuit current	Overload trip	Short-circuit release	
AC-3	AC-3				
380 V 400 V 415 V	400 V	380 - 415 V			
P	$I_e$	$I_q$	$I_r$	$I_{rm}$	Type
kW	A	kA	A 	A 	
0.06	0.21	100	0.16 - 0.24	3.5	PKM0-0,25
0.09	0.31	100	0.24 - 0.4	5.6	PKM0-0,4
0.12	0.41	100	0.4 - 0.6	8.82	PKM0-0,63
0.18	0.6	100	0.4 - 0.6	8.82	PKM0-0,63
0.25	0.8	100	0.6 - 1	14	PKM0-1
0.37	1.1	100	1 - 1.6	22.4	PKM0-1,6
0.55	1.5	100	1 - 1.6	22.4	PKM0-1,6
0.75	1.9	100	1.6 - 2.4	35	PKM0-2,5
1.1	2.6	100	2.4 - 4	56	PKM0-4
1.5	3.6	100	2.4 - 4	56	PKM0-4
2.2	5	100	4 - 6	88.2	PKM0-6,3
3	6.6	100	6 - 10	140	PKM0-10
4	8.5	100	6 - 10	140	PKM0-10
5.5	11.3	50	8 - 12	168	PKM0-12
5.5	11.3	50	10 - 16	168	PKM0-12
7.5	15.2	50	10 - 16	224	PKM0-16
11	21.7	50	16 - 24	350	PKM0-25
15	29.3	50	20 - 32	448	PKM0-32
18.5	36	50	24 - 40	320 - 560	NZMN1-S40
18.5	36	50	3 - 65	320 - 560	NZMN1-S40
22	41	50	40 - 57	400 - 700	NZMN1-S50
22	41	50	3 - 65	400 - 700	NZMN1-S50
30	55	50	40 - 57	504 - 882	NZMN1-S63
30	55	50	3 - 65	504 - 882	NZMN1-S63
37	68	50	50 - 70	640 - 1120	NZMN1-S80
37	68	50	10 - 145	640 - 1120	NZMN1-S80
45	81	50	70 - 100	800 - 1250	NZMN1-S100
45	81	50	10 - 145	800 - 1250	NZMN1-S100
55	99	50	70 - 100	800 - 1250	NZMN1-S100
55	99	50	10 - 145	800 - 1250	NZMN1-S100

#### Modules PKM0, DILM and ZB with and without automatic reset



#### Modules NZMN1, DILM and Z...





Contactor	Overload relay	Contactor	Overload relay	Current sensor	Notes
Type "1" coordination	Type "1" coordination	Type "2" coordination	Type "2" coordination		
Type	Type	Type	Type	Type	
DILM7-...(…)	ZB12-0,24	DILM7-...(…)	ZB12-0,24	–	<p>The motor-starter combinations consist of the motor protective circuit breaker (without overload function), a contactor and overload relay modules.</p> <p>They conform with IEC/EN 60947-4-1 or VDE 0660 Part 102.</p> <p><math>I_g</math> = conditional rated current</p> <p>The combinations can be operated with or without manual reset. In the Manual position, the combination is blocked against automatic restarting and must be reset locally. In the Auto position, the combination automatically switches on again after the bimetallic elements have cooled down.</p>
DILM7-...(…)	ZB12-0,4	DILM7-...(…)	ZB12-0,4	–	
DILM7-...(…)	ZB12-0,6	DILM7-...(…)	ZB12-0,6	–	
DILM7-...(…)	ZB12-0,6	DILM7-...(…)	ZB12-0,6	–	
DILM7-...(…)	ZB12-1	DILM7-...(…)	ZB12-1	–	
DILM7-...(…)	ZB12-1,6	DILM7-...(…)	ZB12-1,6	–	
DILM7-...(…)	ZB12-1,6	DILM7-...(…)	ZB12-1,6	–	
DILM7-...(…)	ZB12-2,4	DILM7-...(…)	ZB12-2,4	–	
DILM7-...(…)	ZB12-4	DILM7-...(…)	ZB12-4	–	
DILM7-...(…)	ZB12-4	DILM7-...(…)	ZB12-4	–	
DILM7-...(…)	ZB12-6	DILM17-...(…)	ZB32-6	–	
DILM9-...(…)	ZB12-10	DILM17-...(…)	ZB32-10	–	
DILM9-...(…)	ZB12-10	DILM17-...(…)	ZB32-10	–	
DILM12-...(…)	ZB12-12	–	–	–	
–	–	DILM17-...(…)	ZB32-16	–	
DILM17-...(…)	ZB32-16	DILM17-...(…)	ZB32-16	–	
DILM25-...(…)	ZB32-24	DILM25-...(…)	ZB32-24	–	
DILM32-...(…)	ZB32-32	DILM32-...(…)	ZB32-32	–	
DILM40(…)	ZB65-40	–	–	–	<p>The motor-starter combinations consist of the circuit-breaker (without overload function), contactor and overload relay module.</p> <p>They conform with IEC/EN 60947-4-1 or VDE 0660 Part 102.</p> <p><math>I_g</math> = conditional rated current</p> <p>The combinations can be operated with or without manual reset. In the Manual position, the combination is blocked against automatic restarting and must be reset locally. In the Auto position, the combination automatically switches on again after the bimetallic elements have cooled down.</p> <p>Maximum tripping tolerance CLASS10.</p>
–	–	DILM40(…)	–	–	
DILM50(…)	ZB65-57	–	–	–	
–	–	DILM50(…)	–	–	
DILM65(…)	ZB65-57	–	–	–	
–	–	DILM65(…)	–	–	
DILM80(…)	ZB150-70	–	–	–	
–	–	DILM80(…)	–	–	
DILM95(…)	ZB150-100	–	–	–	
–	–	DILM95(…)	–	–	
DILM115(…)	ZB150-100	–	–	–	
–	–	DILM115(…)	–	–	
–	–	–	–	–	
–	–	–	–	–	
					<p><b>Further information</b></p> <p>Technical data PKZMO → Chapter 1.3</p> <p>Accessories PKZ → Chapter 1.3 (Page 10)</p> <p>Technical data DILM → Chapter 1.1</p> <p>Further actuating voltages → Chapter 1.1 (Page 69)</p> <p>DIL accessories → Chapter 1.1 (Page 52)</p> <p>Technical data ZB... → Chapter 1.2</p> <p>Accessories ZB... → Chapter 1.2 (Page 21)</p>
					<p><b>Further information</b></p> <p>Technical data NZMN1 → See catalog</p> <p>Accessories NZM1 → See catalog</p> <p>Technical data DILM → Chapter 1.1</p> <p>Further actuating voltages → Chapter 1.1 (Page 71)</p> <p>DIL accessories → Chapter 1.1 (Page 50)</p> <p>Technical data ZB... → Chapter 1.2</p> <p>Accessories ZB... → Chapter 1.2 (Page 21)</p>

# 1.4 Motor-starter combinations

Complete units

1

## MSC-R: PKZM0, DILM

### Motor data

Rated operational power	Rated operational current	Rated short-circuit current	
AC-3	AC-3	380 - 415 V	380 - 415 V
380 V 400 V 415 V	400 V	Type "1" coordina- tion	Type "2" coordina- tion
P	$I_e$	$I_q$	$I_q$
kW	A	kA	kA

### Setting range

Overload trip	Short-circuit releases
$I_r$	$I_{rm}$
A	A

### Motor starters actuating voltage 230 V 50 Hz

Part no.  
Article no.

Price  
See price  
list

### Complete units MSC-R

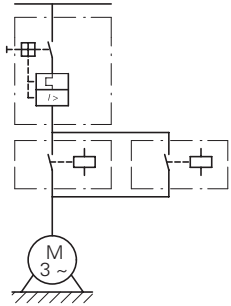
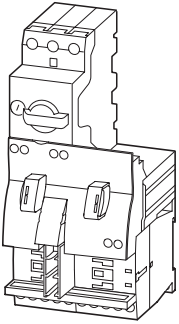

0.06	0.21	150	50	0.16 - 0.25	3.5	<b>MSC-R-0.25-M7(230V50Hz)</b> 283171
0.09	0.31	150	50	0.25 - 0.4	5.6	<b>MSC-R-0.4-M7(230V50Hz)</b> 283172
0.12 0.18	0.41 0.6	150	50	0.4 - 0.63	8.82	<b>MSC-R-0.63-M7(230V50Hz)</b> 283173
0.25	0.8	150	50	0.63 - 1	14	<b>MSC-R-1-M7(230V50Hz)</b> 283175
0.37 0.55	1.1 1.5	150	50	1 - 1.6	22.4	<b>MSC-R-1.6-M7(230V50Hz)</b> 283176
0.75	1.9	150	50	1.6 - 2.5	35	<b>MSC-R-2.5-M7(230V50Hz)</b> 283178
1.1 1.5	2.6 3.6	150	50	2.5 - 4	56	<b>MSC-R-4-M7(230V50Hz)</b> 283179
2.2	5	150	50	4 - 6.3	88.2	<b>MSC-R-6.3-M7(230V50Hz)</b> 283181
3	6.6	150	-	6.3 - 10	140	<b>MSC-R-10-M7(230V50Hz)</b> 283182
4	8.5	150	-	6.3 - 10	140	<b>MSC-R-10-M9(230V50Hz)</b> 283183
5.5	11.3	50	-	8 - 12	168	<b>MSC-R-12-M12(230V50Hz)</b> 283184

### Complete units MSC-R

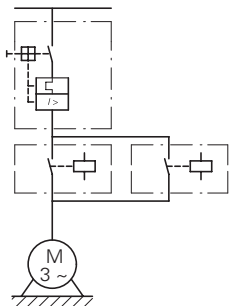
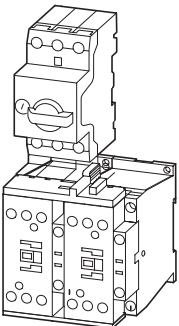

3	6.6	50	50	6.3 - 10	140	<b>MSC-R-10-M17(230V50Hz)</b> 101049
4	11.3	50	50	8 - 12	168	<b>MSC-R-12-M17(230V50Hz)</b> 101050
7.5	15.2	50	50	10 - 16	224	<b>MSC-R-16-M17(230V50Hz)</b> 283186
11	21.7	50	50	20 - 25	350	<b>MSC-R-25-M25(230V50Hz)</b> 283187
15	29.3	50	50	25 - 32	448	<b>MSC-R-32-M32(230V50Hz)</b> 283188

Motor starters actuating voltage 24 V DC	Price See price list	Std. pack	Motor protective circuit breaker	Contactore	Reversing starter wiring set	Notes
Part no. Article no.					Mechanical connection module, electrical contact module and reversing connector	
			Type	Type	Type	
<b>MSC-R-0.25-M7(24VDC)</b> 283190		1 off	PKZM0-0,25	DILM7-01(...)	PKZM0-XRM12	<p>The reversing starters (complete devices) consist of a PKZM0 motor protective circuit breaker and two contactors DILM.</p> <p>With the adapterless top-hat rail mounting of starters up to 12 A, only the motor-protective circuit-breaker on the top-hat rail requires an adapter. The contactors are provided with mechanical support via a mechanical connection element.</p> <p>Control wire guide with max. 6 conductors with up to 2.5 mm external diameter or 4 conductors up to 3.5 mm external diameter.</p> <p>From 16 A, the motor protective circuit breaker and contactors are mounted on the top-hat rail adapter plate. The connection of the main circuit between PKZ and contactor is established with electrical contact modules. Complete units with mechanical interlock, starters up to 12 A also with electrical interlock.</p> <p>When using auxiliary contacts DILA - XHIT... → Chapter 1.1 (Page 38) the electrical plugs can be pulled without having to remove the front mounting auxiliary contact.</p> <p>Cannot be combined with standard auxiliary contact NHI-E...-PKZ0-C with spring-loaded terminal.</p>
<b>MSC-R-0.4-M7(24VDC)</b> 283191		1 off	PKZM0-0,4	DILM7-01(...)	PKZM0-XRM12	
<b>MSC-R-0.63-M7(24VDC)</b> 283192		1 off	PKZM0-0,63	DILM7-01(...)	PKZM0-XRM12	
<b>MSC-R-1-M7(24VDC)</b> 283194		1 off	PKZM0-1	DILM7-01(...)	PKZM0-XRM12	
<b>MSC-R-1.6-M7(24VDC)</b> 283195		1 off	PKZM0-1,6	DILM7-01(...)	PKZM0-XRM12	
<b>MSC-R-2.5-M7(24VDC)</b> 283197		1 off	PKZM0-2,5	DILM7-01(...)	PKZM0-XRM12	
<b>MSC-R-4-M7(24VDC)</b> 283198		1 off	PKZM0-4	DILM7-01(...)	PKZM0-XRM12	
<b>MSC-R-6.3-M7(24VDC)</b> 283200		1 off	PKZM0-6,3	DILM7-01(...)	PKZM0-XRM12	
<b>MSC-R-10-M7(24VDC)</b> 283201		1 off	PKZM0-10	DILM7-01(...)	PKZM0-XRM12	
<b>MSC-R-10-M9(24VDC)</b> 283202		1 off	PKZM0-10	DILM9-01(...)	PKZM0-XRM12	
<b>MSC-R-12-M12(24VDC)</b> 283203		1 off	PKZM0-12	DILM12-01(...)	PKZM0-XRM12	
<b>MSC-R-10-M17(24VDC)</b> 101051		1 off	PKZM0-10	DILM17-01(...)	PKZM0-XRM32	<p><b>Further information</b></p> <p>Technical data PKZM0</p> <p>Accessories PKZ</p> <p>Technical data DILM</p> <p>Further actuation voltages</p> <p>DILM accessories</p>
<b>MSC-R-12-M17(24VDC)</b> 101052		1 off	PKZM0-12	DILM17-01(...)	PKZM0-XRM32	
<b>MSC-R-16-M17(24VDC)</b> 283204		1 off	PKZM0-16	DILM17-01(...)	PKZM0-XRM32	
<b>MSC-R-25-M25(24VDC)</b> 283205		1 off	PKZM0-25	DILM25-01(...)	PKZM0-XRM32	
<b>MSC-R-32-M32(24VDC)</b> 283206		1 off	PKZM0-32	DILM32-01(...)	PKZM0-XRM32	

Further information	Page
Technical data PKZM0	→ Chapter 1.3
Accessories PKZ	→ Chapter 1.3 (Page 10)
Technical data DILM	→ Chapter 1.1
Further actuation voltages	→ Chapter 1.1 (Page 69)
DILM accessories	→ Chapter 1.1 (Page 50)



# 1.4 Motor-starter combinations

## Modules

1

### PKZM, DILM

#### Motor data

Rated operational power	Rated operational current	Rated short-circuit current		Overload trip	Short-circuit release
400 V	AC-3 400 V	380 - 415 V	380 - 415 V		
P	$I_e$	Type "1" coordination	Type "2" coordination	$I_r$	$I_{rm}$
kW	A	$I_q$ kA	$I_q$ kA	A 	A 

#### Setting range

0.06	0.21	150	50	0.16 - 0.25	3.5
0.09	0.31	150	50	0.25 - 0.4	5.6
0.12	0.41	150	50	0.4 - 0.63	8.82
0.18	0.6	150	50	0.4 - 0.63	8.82
0.25	0.8	150	50	0.63 - 1	14
0.37	1.1	150	50	1 - 1.6	22.4
0.55	1.5	150	50	1 - 1.6	22.4
0.75	1.9	150	50	1.6 - 2.5	35
1.1	2.6	150	50	2.5 - 4	56
1.5	3.6	150	50	2.5 - 4	56
2.2	5	150	50	4 - 6.3	88.2
3	6.6	150	50	6.3 - 10	140
4	8.5	150	50	6.3 - 10	140
5.5	11.3	50	50	8 - 12	168
7.5	15.2	50	50	10 - 16	224
11	21.7	50	50	20 - 25	350
15	29.3	50	50	25 - 32	448

#### Modules PKZM0 and DILM

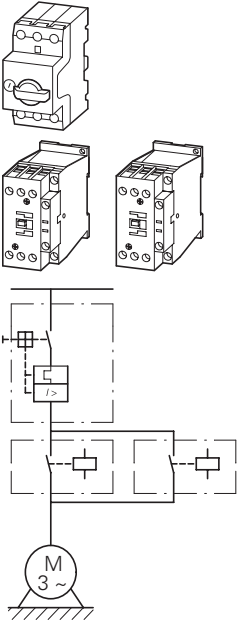

#### Modules PKZM4 and DILM

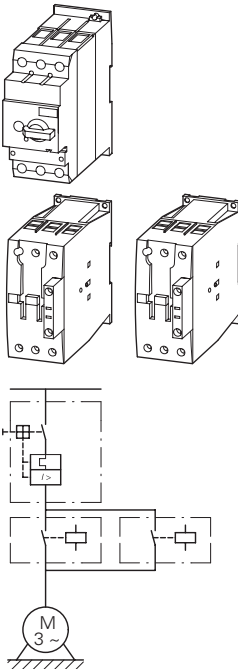

5.5	11.3	50	50	10 - 16	224
7.5	15.2	50	50	10 - 16	224
11	21.7	50	50	20 - 25	350
15	29.3	50	50	25 - 32	448
18.5	36	50	50	32 - 40	560
22	41	50	50	40 - 50	700
30	55	50	50	50 - 58	812
34	63	50	50	55 - 65	882

Motor protective circuit breaker	Contactor	Contactor	Notes
	Type "1" coordination	Type "2" coordination	
Type	Type	Type	
PKZM0-0,25	2 x DILM7-...(...)	2 x DILM7-...(...)	<p>The motor-starter combinations consist of the motor protective circuit breaker or a circuit breaker and a contactor. They conform with IEC/EN 60947-4-1 or VDE 0660 Part 102. I<sub>q</sub> = conditional rated current</p> <p><b>Further information</b></p> <p>Technical data PKZM0</p> <p>Accessories PKZ</p> <p>Technical data DILM</p> <p>Other operating voltages</p> <p>DILM accessories</p> <p><b>Page</b></p> <p>→ Chapter 1.3</p> <p>→ Chapter 1.3 (Page 10)</p> <p>→ Chapter 1.1</p> <p>→ Chapter 1.1 (Page 69)</p> <p>→ Chapter 1.1 (Page 50)</p>
PKZM0-0,4	2 x DILM7-...(...)	2 x DILM7-...(...)	
PKZM0-0,63	2 x DILM7-...(...)	2 x DILM7-...(...)	
PKZM0-0,63	2 x DILM7-...(...)	2 x DILM7-...(...)	
PKZM0-1	2 x DILM7-...(...)	2 x DILM7-...(...)	
PKZM0-1,6	2 x DILM7-...(...)	2 x DILM7-...(...)	
PKZM0-1,6	2 x DILM7-...(...)	2 x DILM7-...(...)	
PKZM0-2,5	2 x DILM7-...(...)	2 x DILM7-...(...)	
PKZM0-4	2 x DILM7-...(...)	2 x DILM7-...(...)	
PKZM0-4	2 x DILM7-...(...)	2 x DILM7-...(...)	
PKZM0-6,3	2 x DILM7-...(...)	2 x DILM7-...(...)	
PKZM0-10	2 x DILM9-...(...)	2 x DILM17-...(...)	
PKZM0-10	2 x DILM9-...(...)	2 x DILM17-...(...)	
PKZM0-12	2 x DILM12-...(...)	2 x DILM17-...(...)	
PKZM0-16	2 x DILM17-...(...)	2 x DILM17-...(...)	
PKZM0-25	2 x DILM25-...(...)	2 x DILM25-...(...)	
PKZM0-32	2 x DILM32-...(...)	2 x DILM32-...(...)	
PKZM4-16	2 x DILM17-...(...)	2 x DILM17-...(...)	<p>The motor-starter combinations consist of the motor protective circuit breaker or a circuit breaker and a contactor. They conform with IEC/EN 60947-4-1 or VDE 0660 Part 102. I<sub>q</sub> = rated conditional short-circuit current.</p> <p><b>Further information</b></p> <p>Technical data PKZM0</p> <p>Accessories PKZ</p> <p>Technical data DILM</p> <p>Other operating voltages</p> <p>DILM accessories</p> <p><b>Page</b></p> <p>→ Chapter 1.3</p> <p>→ Chapter 1.3 (Page 10)</p> <p>→ Chapter 1.1</p> <p>→ Chapter 1.1 (Page 70)</p> <p>→ Chapter 1.1 (Page 50)</p>
PKZM4-16	2 x DILM17-...(...)	2 x DILM17-...(...)	
PKZM4-25	2 x DILM25-...(...)	2 x DILM25-...(...)	
PKZM4-32	2 x DILM32-...(...)	2 x DILM32-...(...)	
PKZM4-40	2 x DILM40(...)	2 x DILM40(...)	
PKZM4-50	2 x DILM50(...)	2 x DILM50(...)	
PKZM4-58	2 x DILM65(...)	2 x DILM65(...)	
PKZM4-63	2 x DILM65(...)	2 x DILM65(...)	

# 1.4 Motor-starter combinations

## Modules



1

### NZMN, NZMH, DILM

#### Motor data

Rated operational power	Rated operational current	Rated short-circuit current
AC-3	AC-3	
380 V 400 V 415 V	400 V	400/415 V
P kW	$I_e$ A	$I_q$ kA

#### Setting range

Overload trip	Short-circuit release
$I_r$ A 	$I_{rm}$ A 

#### Modules NZMN and DILM

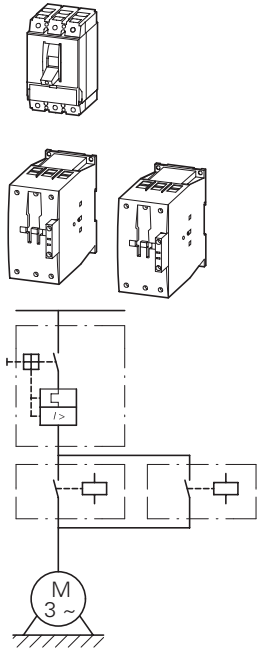

15	29.3	50	25 - 32	320 - 448
18.5	36	50	32 - 40	320 - 560
22	41	50	40 - 50	400 - 700
30	55	50	50 - 63	504 - 882
37	68	50	63 - 80	640 - 1120
45	81	50	80 - 100	800 - 1250
55	99	50	80 - 100	800 - 1250
75	134	50	125 - 160	1280 - 2240
90	161	50	160 - 200	1600 - 2500
110	196	50	160 - 200	1600 - 2500
132	231	50	175 - 350	350 - 4900
160	279	50	175 - 350	350 - 4900
200	349	50	175 - 350	350 - 4900
250	437	50	225 - 450	450 - 6300
315	544	50	275 - 550	550 - 7700
400	683	50	438 - 875	875 - 12250
450	750	50	438 - 875	875 - 12250
500	820	50	438 - 875	875 - 12250
560	947	50	700 - 1400	1400 - 19600

#### Modules NZMH and DILM

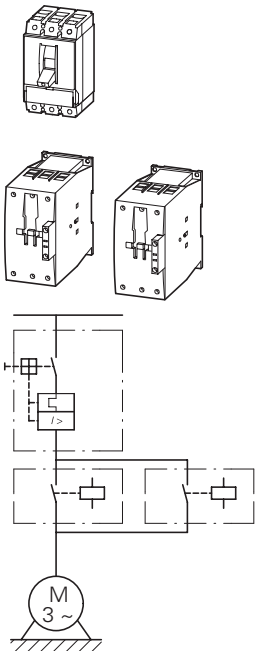

22	41	100	40 - 50	400 - 700
30	55	100	50 - 63	504 - 882
37	68	100	63 - 80	640 - 1120
55	81	100	80 - 100	800 - 1250
55	100	100	100 - 125	1000 - 1750
75	134	100	125 - 160	1280 - 2240
30	55	100	45 - 90	90 - 1260
37	68	100	45 - 90	90 - 1260
45	81	100	45 - 90	90 - 1260
55	100	100	70 - 140	140 - 1960
75	134	100	70 - 140	140 - 1960
90	161	100	110 - 120	220 - 3080
110	196	100	110 - 120	220 - 3080
132	231	100	175 - 350	350 - 4900
160	279	100	175 - 350	350 - 4900
200	349	100	175 - 350	350 - 4900

Circuit-breaker	Contactor	Contactor	Notes
	Type "1" coordination	Type "2" coordination	

Type	Type	Type	
NZMN1-M32	2 x DILM40(...)	2 x DILM80(...)	The motor starter combinations consist of the motor protective circuit-breaker and a contactor. They comply with IEC/EN 60947-4-1 and VDE 0660 Part 102. $I_q$ = conditional rated current.
NZMN1-M40	2 x DILM40(...)	2 x DILM80(...)	
NZMN1-M50	2 x DILM50(...)	2 x DILM80(...)	
NZMN1-M63	2 x DILM65(...)	2 x DILM80(...)	
NZMN1-M80	2 x DILM80(...)	2 x DILM80(...)	
NZMN1-M100	2 x DILM95(...)	2 x DILM95(...)	
NZMN1-M100	2 x DILM115(...)	2 x DILM115(...)	
NZMN2-M160	2 x DILM150(...)	2 x DILM150(...)	
NZMN2-M200	2 x DILM185A/22(...)	2 x DILM185A/22(...)	
NZMN2-M200	2 x DILM225A/22(...)	2 x DILM225A/22(...)	
NZMN3-ME350	2 x DILM250/22(...)	2 x DILM250/22(...)	
NZMN3-ME350	2 x DILM300A/22(...)	2 x DILM300A/22(...)	
NZMN3-ME350	2 x DILM400/22(...)	2 x DILM400/22(...)	
NZMN3-ME450	2 x DILM500/22(...)	2 x DILM500/22(...)	
NZMN4-ME550	2 x DILM580/22(...)	2 x –	
NZMN4-ME875	2 x DILM650/22(...)	2 x –	
NZMN4-ME875	2 x DILM750/22(...)	2 x –	
NZMN4-ME875	2 x DILM820/22(...)	2 x –	
NZMN4-ME1400	2 x DILM1000/22(...)	2 x –	
NZMH2-M50	2 x DILM80(...)	2 x DILM80(...)	The motor-starter combinations consist of the motor protective circuit breaker or a circuit breaker and a contactor. They conform with IEC/EN 60947-4-1 or VDE 0660 Part 102. $I_q$ = rated conditional short-circuit current.
NZMH2-M63	2 x DILM80(...)	2 x DILM80(...)	
NZMH2-M80	2 x DILM80(...)	2 x DILM80(...)	
NZMH2-M100	2 x DILM95(...)	2 x DILM95(...)	
NZMH2-M125	2 x DILM115(...)	2 x DILM115(...)	
NZMH2-M160	2 x DILM150(...)	2 x DILM150(...)	
NZMH2-ME90	2 x DILM80(...)	2 x DILM80(...)	
NZMH2-ME90	2 x DILM80(...)	2 x DILM80(...)	
NZMH2-ME90	2 x DILM95(...)	2 x DILM95(...)	
NZMH2-ME140	2 x DILM115(...)	2 x DILM115(...)	
NZMH2-ME140	2 x DILM150(...)	2 x DILM150(...)	
NZMH2-ME220	2 x DILM185A/22(...)	2 x DILM185A/22(...)	
NZMH2-ME220	2 x DILM225A/22(...)	2 x DILM225A/22(...)	
NZMH3-ME350	2 x DILM250/22(...)	2 x DILM250/22(...)	
NZMH3-ME350	2 x DILM300A/22(...)	2 x DILM300A/22(...)	
NZMH3-ME350	2 x DILM400/22(...)	2 x DILM400/22(...)	

# 1.4

## Motor-starter combinations

DOL starters

1

### MSC-D.../BBA

#### Motor data

Motor rating	Rated operational current	Rated short-circuit current	
AC-3	AC-3	380 - 415 V	380 - 415 V
380 V 400 V 415 V	400 V	Type "1" coordination	Type "2" coordination

P kW	I <sub>e</sub> A	I <sub>q</sub> kA	I <sub>q</sub> kA
---------	---------------------	----------------------	----------------------

#### Setting range

Overload trip	Short-circuit release
---------------	-----------------------



#### Motor starters actuating voltage 230 V 50 Hz

Part no.  
Article no.

Price  
See price list

Std.  
pack

Complete devices PKZ and DIL on BBA

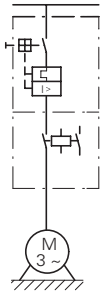

Complete devices PKZ and DIL on BBA

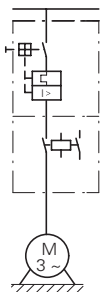

0.06	0.21	100	50	0.16 - 0.25	3.5	<b>MSC-D-0.25-M7(230V50Hz)/BBA<sup>1)</sup></b> 102737	1 off
0.09	0.31	100	50	0.25 - 0.4	5.6	<b>MSC-D-0.4-M7(230V50Hz)/BBA<sup>1)</sup></b> 102738	1 off
0.12 0.18	0.41 0.6	100	50	0.4 - 0.63	8.82	<b>MSC-D-0.63-M7(230V50Hz)/BBA<sup>1)</sup></b> 102739	1 off
0.25	0.8	100	50	0.63 - 1	14	<b>MSC-D-1-M7(230V50Hz)/BBA<sup>1)</sup></b> 102950	1 off
0.37 0.55	1.1 1.5	100	50	1 - 1.6	22.4	<b>MSC-D-1.6-M7(230V50Hz)/BBA<sup>1)</sup></b> 102951	1 off
0.75	1.9	100	50	1.6 - 2.5	35	<b>MSC-D-2.5-M7(230V50Hz)/BBA<sup>1)</sup></b> 102952	1 off
1.1 1.5	2.6 3.6	100	50	2.5 - 4	56	<b>MSC-D-4-M7(230V50Hz)/BBA<sup>1)</sup></b> 102953	1 off
2.2	5	100	50	4 - 6.3	88.2	<b>MSC-D-6.3-M7(230V50Hz)/BBA<sup>1)</sup></b> 102954	1 off
3	6.6	100	—	6.3 - 10	140	<b>MSC-D-10-M7(230V50Hz)/BBA</b> 102955	1 off
4	8.5	100	—	6.3 - 10	140	<b>MSC-D-10-M9(230V50Hz)/BBA</b> 102956	1 off
5.5	11.3	100	—	8 - 12	168	<b>MSC-D-12-M12(230V50Hz)/BBA</b> 102957	1 off
7.5	15.2	50	—	10 - 16	224	<b>MSC-D-16-M15(230V50Hz)/BBA</b> 102958	1 off
3	6.6	100	50	6.3 - 10	140	<b>MSC-D-10-M17(230V50Hz)/BBA</b> 102959	1 off
4	8.5	100	50	8 - 12	168	<b>MSC-D-12-M17(230V50Hz)/BBA</b> 102960	1 off
5.5	11.3	100	50	8 - 12	168	<b>MSC-D-12-M17(230V50Hz)/BBA</b> 102960	1 off
7.5	15.2	50	50	10 - 16	224	<b>MSC-D-16-M17(230V50Hz)/BBA<sup>1)</sup></b> 102961	1 off
11	21.7	50	50	20 - 25	350	<b>MSC-D-25-M25(230V50Hz)/BBA<sup>1)</sup></b> 102962	1 off
15	29.3	50	50	25 - 32	448	<b>MSC-D-32-M32(230V50Hz)/BBA<sup>1)</sup></b> 102963	1 off



Motor starters actuating voltage 24 V DC Part no. Article no.	Price See price list	Std. pack	Motor protective circuit breaker	Contactor	DOL starter wiring set  Mechanical con- nection module and electrical contact module	Busbar adapter	Notes
			Type	Type	Type	Type	
<b>MSC-D-0.25-M7(24VDC)/BBA</b> <sup>1)</sup> 102964		1 off	PKZM0-0,25	DILM7-10(...)	PKZM0-XDM12	BBA0-25	The DOL starters (complete devices) consist of a motor protective circuit breaker PKZM0 and a contactor DILM. These combinations are mounted on busbars. The connection of the main circuit between PKZ and contactor is established with electrical contact modules. Cannot be combined with standard auxiliary contact NHI-E-...-PKZ0-C with spring-loaded terminal.
<b>MSC-D-0.4-M7(24VDC)/BBA</b> <sup>1)</sup> 102965		1 off	PKZM0-0,4	DILM7-10(...)	PKZM0-XDM12	BBA0-25	
<b>MSC-D-0.63-M7(24VDC)/BBA</b> <sup>1)</sup> 102966		1 off	PKZM0-0,63	DILM7-10(...)	PKZM0-XDM12	BBA0-25	
<b>MSC-D-1-M7(24VDC)/BBA</b> <sup>1)</sup> 102967		1 off	PKZM0-1	DILM7-10(...)	PKZM0-XDM12	BBA0-25	
<b>MSC-D-1.6-M7(24VDC)/BBA</b> <sup>1)</sup> 102968		1 off	PKZM0-1,6	DILM7-10(...)	PKZM0-XDM12	BBA0-25	
<b>MSC-D-2.5-M7(24VDC)/BBA</b> <sup>1)</sup> 102969		1 off	PKZM0-2,5	DILM7-10(...)	PKZM0-XDM12	BBA0-25	
<b>MSC-D-4-M7(24VDC)/BBA</b> <sup>1)</sup> 102970		1 off	PKZM0-4	DILM7-10(...)	PKZM0-XDM12	BBA0-25	
<b>MSC-D-6.3-M7(24VDC)/BBA</b> 102971		1 off	PKZM0-6,3	DILM7-10(...)	PKZM0-XDM12	BBA0-25	
<b>MSC-D-10-M7(24VDC)/BBA</b> 102972		1 off	PKZM0-10	DILM7-10(...)	PKZM0-XDM12	BBA0-25	
<b>MSC-D-10-M9(24VDC)/BBA</b> 102973		1 off	PKZM0-10	DILM9-10(...)	PKZM0-XDM12	BBA0-25	
<b>MSC-D-12-M12(24VDC)/BBA</b> 102974		1 off	PKZM0-12	DILM12-10(...)	PKZM0-XDM12	BBA0-25	
<b>MSC-D-16-M15(24VDC)/BBA</b> 102975		1 off	PKZM0-16	DILM15-10(...)	PKZM0-XDM12	BBA0-25	
<b>MSC-D-10-M17(24VDC)/BBA</b> 102976		1 off	PKZM0-10	DILM17-10(...)	PKZM0-XM32DE	BBA0-32	<b>Further information</b> Technical data PKZM0 Accessories PKZ Technical data DILM DILM accessories  <sup>1)</sup> To assemble Type F starters that conform with UL508, incoming terminals BK25/3-PKZ0-E and, if necessary, three-phase terminal blocks B3.../...-PKZ0 can be added to motor starter combinations. Type F starter → Page 28
<b>MSC-D-12-M17(24VDC)/BBA</b> 102977		1 off	PKZM0-12	DILM17-10(...)	PKZM0-XM32DE	BBA0-32	
<b>MSC-D-16-M17(24VDC)/BBA</b> 102978		1 off	PKZM0-16	DILM17-10(...)	PKZM0-XM32DE	BBA0-32	
<b>MSC-D-25-M25(24VDC)/BBA</b> 102979		1 off	PKZM0-25	DILM25-10(...)	PKZM0-XM32DE	BBA0-32	
<b>MSC-D-32-M32(24VDC)/BBA</b> 102980		1 off	PKZM0-32	DILM32-10(...)	PKZM0-XM32DE	BBA0-32	

# 1.4 Motor-starter combinations



## Reversing starters

1

### MSC-R.../BBA

**Motor starters**  
actuating voltage  
**230 V 50 Hz**

**Price**  
See price  
list

Motor data				Setting range		Part no. Article no.
Motor rating	Rated operational current	Rated short-circuit current		Overload trip	Short-circuit release	
AC-3	AC-3	380 - 415 V		380 - 415 V		
380 V 400 V 415 V	400 V	Type "1" coordina- tion	Type "2" coordina- tion			
P kW	$I_e$ A	$I_q$ kA	$I_q$ kA	$I_r$ A	$I_m$ A	
						
0.06	0.21	100	50	0.16 - 0.25	3.5	<b>MSC-R-0.25-M7(230V50Hz)/BBA</b> 102981
0.09	0.31	100	50	0.25 - 0.4	5.6	<b>MSC-R-0.4-M7(230V50Hz)/BBA</b> 102982
0.12 0.18	0.41 0.6	100	50	0.4 - 0.63	8.82	<b>MSC-R-0.63-M7(230V50Hz)/BBA</b> 102983
0.25	0.8	100	50	0.63 - 1	14	<b>MSC-R-1-M7(230V50Hz)/BBA</b> 102984
0.37 0.55	1.1 1.5	100	50	1 - 1.6	22.4	<b>MSC-R-1.6-M7(230V50Hz)/BBA</b> 102985
0.75	1.9	100	50	1.6 - 2.5	35	<b>MSC-R-2.5-M7(230V50Hz)/BBA</b> 102986
1.1 1.5	2.6 3.6	100	50	2.5 - 4	56	<b>MSC-R-4-M7(230V50Hz)/BBA</b> 102987
2.2	5	100	50	4 - 6.3	88.2	<b>MSC-R-6.3-M7(230V50Hz)/BBA</b> 102988
3	6.6	100	–	6.3 - 10	140	<b>MSC-R-10-M7(230V50Hz)/BBA</b> 102989
4	8.5	100	–	6.3 - 10	140	<b>MSC-R-10-M9(230V50Hz)/BBA</b> 102990
5.5	11.3	100	–	8 - 12	168	<b>MSC-R-12-M12(230V50Hz)/BBA</b> 102991
3	6.6	100	50	6.3 - 10	140	<b>MSC-R-10-M17(230V50Hz)/BBA</b> 102992
4	8.5	100	50	8 - 12	168	<b>MSC-R-12-M17(230V50Hz)/BBA</b> 102993
5.5	11.3	100	50	8 - 12	168	<b>MSC-R-12-M17(230V50Hz)/BBA</b> 102993
7.5	15.2	50	50	10 - 16	224	<b>MSC-R-16-M17(230V50Hz)/BBA</b> 102994
11	21.7	50	50	20 - 25	350	<b>MSC-R-25-M25(230V50Hz)/BBA</b> 102995
15	29.3	50	50	25 - 32	448	<b>MSC-R-32-M32(230V50Hz)/BBA</b> 102996

**Complete devices PKZ and DILM on BBA for reversing starters**

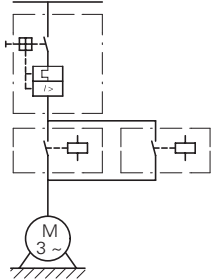
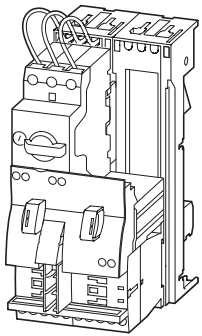

**Complete devices PKZ and DILM on BBA for reversing starters**

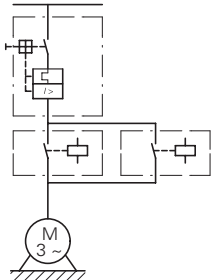
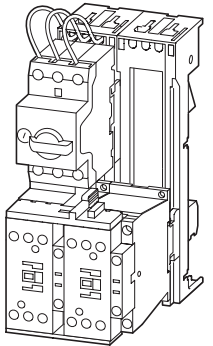

Motor starters actuating voltage 24 V DC	Price See price list	Std. pack	Motor protective circuit breaker	Contactor	Wiring set Reversing starters	Busbar adapter	Notes	
<b>Part no.</b> Article no.					Mechanical con- nection module, electrical contact module and reversing connec- tor			
			Type	Type	Type	Type		
<b>MSC-R-0.25-M7(24VDC)/BBA</b> 102997		1 off	PKZM0-0,25	2 x	DILM7-01(...)	PKZM0-XRM12	BBA0R-25	The reversing starters (complete devices) consist of a PKZM0 motor protective circuit breaker and two contactors DILM. These combinations are mounted on busbars. The connection of the main circuit between PKZ and contactor is established with electrical contact modules. Complete units with mechanical interlock, starters up to 12 A also with electrical interlock.
<b>MSC-R-0.4-M7(24VDC)/BBA</b> 102998		1 off	PKZM0-0,4	2 x	DILM7-01(...)	PKZM0-XRM12	BBA0R-25	
<b>MSC-R-0.63-M7(24VDC)/BBA</b> 102999		1 off	PKZM0-0,63	2 x	DILM7-01(...)	PKZM0-XRM12	BBA0R-25	
<b>MSC-R-1-M7(24VDC)/BBA</b> 103000		1 off	PKZM0-1	2 x	DILM7-01(...)	PKZM0-XRM12	BBA0R-25	
<b>MSC-R-1.6-M7(24VDC)/BBA</b> 103001		1 off	PKZM0-1,6	2 x	DILM7-01(...)	PKZM0-XRM12	BBA0R-25	
<b>MSC-R-2.5-M7(24VDC)/BBA</b> 103002		1 off	PKZM0-2,5	2 x	DILM7-01(...)	PKZM0-XRM12	BBA0R-25	
<b>MSC-R-4-M7(24VDC)/BBA</b> 103003		1 off	PKZM0-4	2 x	DILM7-01(...)	PKZM0-XRM12	BBA0R-25	
<b>MSC-R-6.3-M7(24VDC)/BBA</b> 103004		1 off	PKZM0-6,3	2 x	DILM7-01(...)	PKZM0-XRM12	BBA0R-25	
<b>MSC-R-10-M7(24VDC)/BBA</b> 103005		1 off	PKZM0-10	2 x	DILM7-01(...)	PKZM0-XRM12	BBA0R-25	
<b>MSC-R-10-M9(24VDC)/BBA</b> 103006		1 off	PKZM0-10	2 x	DILM9-01(...)	PKZM0-XRM12	BBA0R-25	
<b>MSC-R-12-M12(24VDC)/BBA</b> 103007		1 off	PKZM0-12	2 x	DILM12-01(...)	PKZM0-XRM12	BBA0R-25	
<b>MSC-R-10-M17(24VDC)/BBA</b> 103008		1 off	PKZM0-10	2 x	DILM17-01(...)	PKZM0-XM32DE+ DILM32-XRL	BBA0R-32	<b>Further information</b> <b>Page</b> Technical data PKZM0    → Chapter 1.3 Accessories PKZ        → Chapter 1.3 (Page 10) Technical data DILM     → Chapter 1.1 DILM accessories        → Chapter 1.1 (Page 50)
<b>MSC-R-12-M17(24VDC)/BBA</b> 103009		1 off	PKZM0-12	2 x	DILM17-01(...)	PKZM0-XM32DE+ DILM32-XRL	BBA0R-32	
<b>MSC-R-16-M17(24VDC)/BBA</b> 103010		1 off	PKZM0-16	2 x	DILM17-01(...)	PKZM0-XM32DE+ DILM32-XRL	BBA0R-32	
<b>MSC-R-25-M25(24VDC)/BBA</b> 103011		1 off	PKZM0-25	2 x	DILM25-01(...)	PKZM0-XM32DE+ DILM32-XRL	BBA0R-32	
<b>MSC-R-32-M32(24VDC)/BBA</b> 103012		1 off	PKZM0-32	2 x	DILM32-01(...)	PKZM0-XM32DE+ DILM32-XRL	BBA0R-32	

# 1.4 Motor-starter combinations

## Type F starter combinations

### 1 PKZMO, DILM, BK...

Maximum motor rating				Setting range		Rated short-circuit breaking capacity $I_{cn}$			Extension terminal	Motor protective circuit breaker	Contactor
Alternating current HP				Overload trip	Short-circuit release	240 V	480 V	600 V	Type	Type	Type
200 V	230 V	460 V	575 V			277 V <sup>2)</sup>	347 V <sup>2)</sup>				
208 V	240 V	480 V	600 V			kA	kA	kA			
HP	HP	HP	HP	$I_r$ A	$I_{lm}$ A						

#### Modules PKZMO, DIL, BK

1)				0.1 - 0.16	2.2	65	65	50	BK25/3-PKZ0	PKZMO-0,16	DILEM...(...)
				0.1 - 0.16	2.2	65	65	50	BK25/3-PKZ0	PKZMO-0,16	DILM7...(...)
				0.16 - 0.25	3.4	65	65	50	BK25/3-PKZ0	PKZMO-0,25	DILEM...(...)
				0.16 - 0.25	3.4	65	65	50	BK25/3-PKZ0	PKZMO-0,25	DILM7...(...)
				0.25 - 0.4	5.6	65	65	50	BK25/3-PKZ0	PKZMO-0,4	DILEM...(...)
				0.25 - 0.4	5.6	65	65	50	BK25/3-PKZ0	PKZMO-0,4	DILM7...(...)
				0.4 - 0.63	8.8	65	65	50	BK25/3-PKZ0	PKZMO-0,63	DILEM...(...)
				0.4 - 0.63	8.8	65	65	50	BK25/3-PKZ0	PKZMO-0,63	DILM7...(...)
	½	½		0.63 - 1	14	65	65	50	BK25/3-PKZ0	PKZMO-1	DILEM...(...)
	½	½		0.63 - 1	14	65	65	50	BK25/3-PKZ0	PKZMO-1	DILM7...(...)
	¾	1		1 - 1.6	22	65	65	50	BK25/3-PKZ0	PKZMO-1,6	DILEM...(...)
	¾	1		1 - 1.6	22	65	65	50	BK25/3-PKZ0	PKZMO-1,6	DILM7...(...)
½	½	1	1½	1.6 - 2.5	35	65	65	50	BK25/3-PKZ0	PKZMO-2,5	DILEM...(...)
½	½	1	1½	1.6 - 2.5	35	65	65	50	BK25/3-PKZ0	PKZMO-2,5	DILM7...(...)
1	1	2	3	2.5 - 4	56	65	65	50	BK25/3-PKZ0	PKZMO-4	DILEM...(...)
1	1	2	3	2.5 - 4	56	65	65	50	BK25/3-PKZ0	PKZMO-4	DILM7...(...)
1½	1½	3	5	4 - 6.3	88	65	65	50	BK25/3-PKZ0	PKZMO-6,3	DILEM...(...)
1½	1½	3	5	4 - 6.3	88	65	65	50	BK25/3-PKZ0	PKZMO-6,3	DILM7...(...)
3	3	7½	10	6.3 - 11	140	65	65	50	BK25/3-PKZ0	PKZMO-10	DILM9...(...)
3	3	7½	–	9 - 12	168	65	65	50	BK25/3-PKZ0	PKZMO-12	DILM12...(...)
3	5	10	–	10 - 16	224	50	50	–	BK50/3-PKZ4-E	PKZMO-16	DILM17...(...)
3	5	10	–	10 - 16	224	18	18	–	BK50/3-PKZ4-E	PKZMO-16	DILM17...(...)
5	5	10	–	16 - 20	280	18	18	–	BK50/3-PKZ4-E	PKZMO-20	DILM25...(...)
5	7½	15	–	20 - 25	350	18	18	–	BK50/3-PKZ4-E	PKZMO-25	DILM25...(...)
7½	10	20	–	25 - 32	448	18	18	–	BK50/3-PKZ4-E	PKZMO-32	DILM32...(...)

#### Modules PKZM4, DIL, BK

3	5	10	15	10 - 16	224	65	65	50	BK50/3-PKZ4-E	PKZM4-16	DILM17...(...)
5	7½	15	20	16 - 27	350	65	65	50	BK50/3-PKZ4-E	PKZM4-25	DILM25...(...)
7½	10	25	30	24 - 34	448	65	65	50	BK50/3-PKZ4-E	PKZM4-32	DILM32...(...)
10	15	30	30	32 - 40	560	65	65	50	BK50/3-PKZ4-E	PKZM4-40	DILM40(...)
10	15	30	–	40 - 52	700	65	65	–	BK50/3-PKZ4-E	PKZM4-50	DILM50(...)
15	15	40	–	50 - 56	812	65	65	–	BK50/3-PKZ4-E	PKZM4-58	DILM65(...)
15	15	40	–	52 - 58	882	65	65	–	BK50/3-PKZ4-E	PKZM4-63	DILM65(...)

#### Notes

Device for world markets  $\Delta$  IEC UL/CSA

Service factor (SF)

Set value  $I_r$  on the current scale, depending on the load factor

SF=1.15  $\rightarrow I_r = 1 \times I_{n \text{ mot}}$

SF=1.0  $\rightarrow I_r = 0.9 \times I_{n \text{ mot}}$

<sup>1)</sup> Calculate motor power in this range according to the rated operational current. Stated values to NEC Table 430 - 150.

<sup>2)</sup> Suitable for networks with grounded star-point

Type F starter combinations do not need an upstream protective device.

For use in Canada, the switch must be fitted with an AK-PKZ0.

## DILM, ZE, ZB, Z5, ZW7

### Rating data for approved types<sup>1)</sup>

Maximum motor rating				Max. rated motor current	Contactor	Overload relay	Maximum short-circuit protective device for North America	
Alternating current HP							Fuse CEC or NEC	Circuit-breaker <sup>2)</sup>
200 V 208 V HP	230 V 240 V HP	460 V 480 V HP	575 V 600 V HP	A	Type	Type	Continuous current	Short-circuit release

### Modules DIL, Z

–	–	½	½	1	DILEM-...(…)	ZE-1.0	3	15	–
–	–	¾	1	1.4	DILEM-...(…)	ZE-1.6	6	15	–
½	½	1	1½	2.3	DILEM-...(…)	ZE-2.4	6	15	–
–	1	2	3	3.9	DILEM-...(…)	ZE-4	15	15	–
1½	1½	3	–	6	DILEM-...(…)	ZE-6	20	15	–
–	2	–	–	6.8	DILEM-...(…)	ZE-9	35	15	–
2	2	5	5	7.8	DILEM-...(…)	ZE-9	35	15	–
2	3	5	5	9.6	DILEM-...(…)	ZE-12	45	–	–
–	–	½	½	1	DILM7-...(…)	ZB12-1	3	25	200
–	–	¾	1	1.4	DILM7-...(…)	ZB12-1,6	6	25	200
½	½	1	1½	2.3	DILM7-...(…)	ZB12-2,4	6	25	200
1	1	2	3	3.9	DILM7-...(…)	ZB12-4	15	25	200
1½	½	3	–	6	DILM7-...(…)	ZB12-6	20	25	200
–	–	–	7½	9	DILM9-...(…)	ZB12-10	25	25	200
–	3	5	7½	9.6	DILM12-...(…)	ZE-12	25	25	200
–	–	7½	10	11	DILM12-...(…)	ZB12-12	45	25	200
–	5	10	–	15.2	DILM15-...(…)	ZB12-16	60	40	320
–	–	½	½	1	DILM17-...(…)	ZB32-1	3	25	200
–	–	¾	1	1.4	DILM17-...(…)	Z78447	6	25	200
½	½	1	1½	2.3	DILM17-...(…)	ZB32-2,4	6	25	200
1	1	2	3	3.9	DILM17-...(…)	ZB32-4	15	25	200
½	1½	3	–	6	DILM17-...(…)	ZB32-6	20	25	200
–	3	5	7½	9.6	DILM17-...(…)	ZB32-10	25	25	200
–	–	7½	10	11	DILM17-...(…)	ZB32-16	40	30	320
–	5	10	–	15.2	DILM17-...(…)	ZB32-16	40	30	320
–	7½	15	20	22	DILM25-...(…)	ZB32-24	90	100	1200
–	10	20	25	32.2	DILM32-...(…)	ZB32-32	125	125	1200
–	3	5	7½	9.6	DILM40(…)	ZB65-10	40	40	380
–	5	10	10	15.2	DILM40(…)	ZB65-16	60	60	760
–	7½	20	25	32.2	DILM40(…)	ZB65-24	90	90	1200
–	10	20	30	34	DILM40(…)	ZB65-40	125	125	1200
–	20	40	50	54	DILM50(…)	ZB65-57	200	150	2000
–	20	50	50	63	DILM65(…)	ZB65-65	200	160	2000
–	25	50	60	68	DILM80(…)	ZB150-70	250	250	2500
–	30	75	100	99	DILM95(…)	ZB150-100	400	400	3200
–	40	100	100	124	DILM115(…)	ZB150-125	500	500	4000
–	60	125	125	156	DILM150(…)	ZB150-150	600	600	4800
50	60	125	150	156	DILM185A/22(…)	Z5-160/FF225A	600 CLASS J	600	7200
60	75	150	200	192	DILM225A/22(…)	Z5-220/FF225A	800 CLASS J	800	16000
75	100	200	250	248	DILM250/22(…)	Z5-250/FF250	700 CLASS J	600	–
100	125	250	300	312	DILM300A/22(…)	ZW7-400	1000	1000	–
125	150	300	400	382	DILM400/22(…)	ZW7-400	1000	1000	–
150	200	400	500	480	DILM500/22(…)	ZW7-540	1000	600	–

### Notes

<sup>1)</sup> Devices for world markets IEC ≙ UL/CSA

<sup>2)</sup> Circuit-breaker -> See catalog

# 1.4 Motor-starter combinations

## Function blocks

### 1 NZMH...S...CNA, DILM..., ZB, Z5, ZW7

#### Rating data for approved types

Maximum motor rating  
Alternating current HP

Max. rated motor current

Rated short-circuit breaking capacity

#### Setting range

Overload trip

Short-circuit releases

#### Circuit-breaker

#### Contactor

#### Overload relay

Minimum enclosure volume

200 V 230 V 460 V 575 V  
208 V 240 V 480 V 600 V

480 V 600 Y 600 V  
347 V<sup>1)</sup>

Type

Type

Type

HP HP HP HP A kA kA kA A A cm<sup>3</sup>



#### Module NZMH...S...CNA, DILM, Z

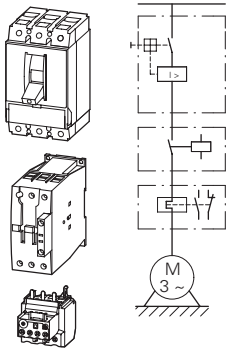

HP	HP	HP	HP	A	kA	kA	kA	A	A	Type	Type	Type	cm <sup>3</sup>
—	—	—	½	0.9	100	50	—	0.6 - 1	12.8 - 22.5	NZMH2-S1.6-CNA	DILM17-...(…)	ZB32-1	81.5
—	—	½	¾	1.3	100	50	—	1 - 1.6	12.8 - 22.5	NZMH2-S1.6-CNA	DILM17-...(…)	ZB32-1,6	81.5
—	—	¾	—	1.6	100	50	—	1 - 1.6	19.2 - 33.6	NZMH2-S2.4-CNA	DILM17-...(…)	ZB32-1,6	81.5
—	—	1	1	2.1	100	50	—	1.6 - 2.4	19.2 - 33.6	NZMH2-S2.4-CNA	DILM17-...(…)	ZB32-2,4	81.5
—	½	—	1½	2.4	100	50	—	1.6 - 2.4	32 - 56	NZMH2-S5-CNA	DILM17-...(…)	ZB32-2,4	81.5
¾	¾	2	3	3.9	100	50	—	2.4 - 4	32 - 56	NZMH2-S5-CNA	DILM17-...(…)	ZB32-4	81.5
—	1	—	—	4.2	100	50	—	4 - 6	32 - 56	NZMH2-S5-CNA	DILM17-...(…)	ZB32-6	81.5
1	1½	3	—	6	100	50	—	4 - 6	48 - 84	NZMH2-S8-CNA	DILM17-...(…)	ZB32-6	81.5
1½	2	—	5	6.9	100	50	—	6 - 10	48 - 84	NZMH2-S8-CNA	DILM17-...(…)	ZB32-10	81.5
2	3	5	7½	9.6	100	50	—	6 - 10	80 - 140	NZMH2-S12-CNA	DILM17-...(…)	ZB32-10	81.5
3	5	10	10	15.2	100	50	—	10 - 16	128 - 224	NZMH2-S18-CNA	DILM17-...(…)	ZB32-16	81.5
5	—	—	15	17.5	100	50	—	16 - 24	200 - 350	NZMH2-S26-CNA	DILM17-...(…)	ZB32-24	81.5
—	7½	15	20	22	100	50	—	16 - 24	200 - 350	NZMH2-S26-CNA	DILM25-...(…)	ZB32-24	81.5
7½	—	—	—	25.3	100	50	—	24 - 32	256 - 448	NZMH2-S33-CNA	DILM25-...(…)	ZB32-32	81.5
—	10	20	25	28	100	50	—	24 - 32	256 - 448	NZMH2-S33-CNA	DILM32-...(…)	ZB32-32	81.5
10	—	—	—	32.2	100	50	—	24 - 32	320 - 560	NZMH2-S40-CNA	DILM32-...(…)	ZB32-32	81.5
—	—	25	30	34	100	50	—	32 - 40	320 - 560	NZMH2-S40-CNA	DILM40(…)	ZB65-40	81.5
—	—	30	—	40	100	50	—	32 - 40	400 - 700	NZMH2-S50-CNA	DILM40(…)	ZB65-40	81.5
—	15	—	40	42	100	50	—	40 - 57	400 - 700	NZMH2-S50-CNA	DILM40(…)	ZB65-57	81.5
15	20	40	50	54	100	50	—	40 - 57	504 - 882	NZMH2-S63-CNA	DILM50(…)	ZB65-57	81.5
20	—	50	60	65	100	50	—	57 - 65	640 - 1120	NZMH2-S80-CNA	DILM65(…)	ZB65-65	81.5
—	25	—	—	68	100	50	—	50 - 70	640 - 1120	NZMH2-S80-CNA	DILM80(…)	ZB150-70	163
25	30	60	75	80	100	50	—	70 - 100	800 - 1400	NZMH2-S100-CNA	DILM80(…)	ZB150-100	163
—	40	75	100	104	100	50	—	70 - 100	1000 - 1750	NZMH2-S125-CNA	DILM95(…)	ZB150-100	163
30	—	—	—	92	100	50	—	70 - 100	1000 - 1750	NZMH2-S125-CNA	DILM115(…)	ZB150-100	163
40	—	100	125	125	100	50	—	100 - 125	1280 - 2240	NZMH2-S160-CNA	DILM115(…)	ZB150-125	163
—	50	—	—	130	100	50	—	125 - 150	1280 - 2240	NZMH2-S160-CNA	DILM115(…)	ZB150-150	163
—	—	125	—	156	100	50	—	125 - 150	1600 - 2500	NZMH2-S200-CNA	DILM150(…)	ZB150-150	265
50	60	—	150	154	100	50	—	120 - 160	1600 - 2500	NZMH2-S200-CNA	DILM185/22(…)	Z5-160/FF250	265
60	75	150	200	192	100	50	—	160 - 220	220 - 3080	NZMH2-SE220-CNA	DILM225/22(…)	Z5-220/FF250	265
75	100	200	250	248	100	50	50	160 - 220	350 - 4900	NZMH3-SE350-CNA	DILM250/22(…)	Z5-220/FF250	306
100	—	—	300	289	100	50	50	190 - 290	350 - 4900	NZMH3-SE350-CNA	DILM300/22(…)	ZW7-290	306
—	125	250	—	302	100	50	50	270 - 400	450 - 6300	NZMH3-SE450-CNA	DILM300/22(…)	ZW7-400	306
125	150	300	400	382	100	50	50	270 - 400	450 - 6300	NZMH3-SE450-CNA	DILM400/22(…)	ZW7-400	306

Notes <sup>1)</sup> Suitable for networks with grounded star-point

## Description

### SWIRE...

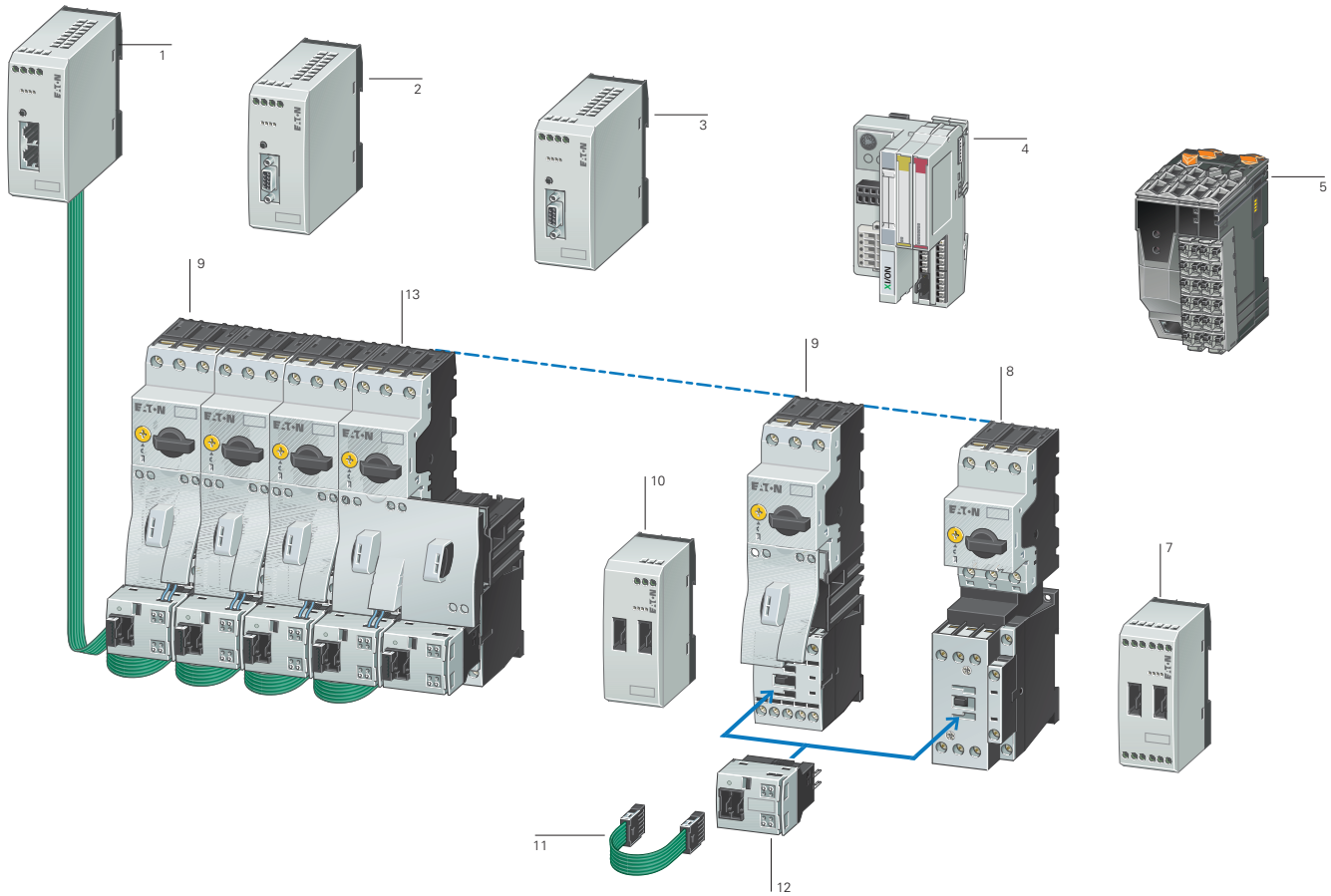

- 1 Gateway easy NET/CAN open
- 2 Gateway PROFIBUS-DP
- 3 Gateway MODBUS
- 4 Coupling unit XI/ON with SmartWire-DT® Interface card MicroInnovation AG, [www.microinnovation.com](http://www.microinnovation.com)
- 5 Interface module B & R CS1011 for X20 system, [www.br-automation.com](http://www.br-automation.com)
- 6 SmartWire-DT® I/O module
- 7 DOL starter MSC-D up to 32 A
- 8 DOL starter MSC-D up to 15.5 A
- 9 SmartWire-DT® power module
- 10 Connection cable
- 11 SmartWire-DT® module for DILM
- 12 Reversing starter MSC-R up to 12 A

### System description

With the SmartWire-DT® connection system, switchgear can be connected to a programmable logic controller without the need for complex control wiring. Plug-in SmartWire-DT® cards for DILM and a preassembled connection cable replace the control wiring, dramatically reducing wiring complexity and completely eliminating wiring errors. SmartWire-DT® also cuts the time needed for installation, commissioning and troubleshooting. The PLC's inputs and outputs are replaced by the SmartWire-DT® module for DILM, and no control wiring terminals are required. Connection to the various fieldbus systems is through third-party gateways or interface modules.

### Features

- Gateway
  - Connects the SmartWire-DT® cards with the fieldbus
  - Supports the fieldbus standards PROFIBUS-DP, MODBUS, CANopen and easy-NET
  - Supplies the control voltage for the motor starter or contactor
  - Supplies the supply voltage for the SmartWire-DT® connection system
  - Configuration button for automatic addressing of the SmartWire-DT® modules for DILM
  - Supports max. 16 SmartWire-DT® modules for DILM
- Interface of third-party manufacturers, e.g. for the XI/ON I/O system, X20 system CS1011 interface module
  - Connection to the field buses PROFIBUS-DP, MODBUS, CANopen and DeviceNET
- SmartWire-DT® module for DILM
  - Pluggable on contactors
  - Suitable for contactors DILM7 to DILM32 (24 V DC), DILMC7 to DILMC32 (24 V DC), DILMP20 (24 V DC) or motor starter MSC... (24 V DC)
  - Use the standard switchgear of the xStart range
  - Suitable for DOL and reversing starters
  - The accessories of the contactor series can be used
- Suitable for contactor combinations with PKZ or with Z relays
- Integrated switch position monitoring of the contactors
- Integrated mechanical switch position display
- Actuation of the contactors
- Scanning of a potential-free contact, e.g. NHI-E-10-PKZO
- Electrical interlocking, e.g. possible with reversing starters
- LED for status and diagnostic display
- Connection to gateway or interface from third party devices
- SmartWire-DT® I/O module
  - 4 digital inputs for connection of potential-free contacts
  - Power supply for the digital inputs comes from the device
  - 2 relay outputs 250 V AC
- SmartWire-DT® power module
  - Supply of the 24 V DC control voltage for actuation of contactors DILM
  - Assembly of Emergency Off groups
  - Increases the control voltage power in the SmartWire-DT® line
- Safety engineering
  - Emergency switching off disconnection as per IEC/EN 954-1, Switching Category 3
  - Central switch off of control voltage at the gateway or SmartWire-DT® power module
  - Combination with safety-relevant switchgear possible

# 1.4

## Connection system SmartWire-DT®

### 1 Ordering

#### SWIRE-...

Description	Part no. Article no.	Price See price list	Std. pack	Notes
-------------	-------------------------	-------------------------	-----------	-------

#### Gateway

##### PROFIBUS-DP



Gateway with integrated supply for the SmartWire-DT® module and control voltage for the switchgear.

- Connection to PROFIBUS-DP as slave.
- Transmission rate: 9.6 Kbits/s to 12 MBit/s.
- 9 pole SUB-D socket.
- Address range 1...126.
- Connection to SmartWire-DT® module as master.
- Supports 16 SmartWire-DT® modules.

**SWIRE-GW-DP**  
107027

1 off  
 

##### MODBUS



Gateway with integrated supply for the SmartWire-DT® module and control voltage for the switchgear.

- Connection to MODBUS-RTU as slave.
- Transmission rate: 9.6 to 57.6 Kbits/s.
- 9 pole SUB-D socket RS232/RS485.
- Address range 1...31.
- Connection to SmartWire-DT® module as master.
- Supports 16 SmartWire-DT® modules.

**SWIRE-GW-MB**  
118562

1 off  
 

#### Modules

##### SmartWire-DT® module for DILM

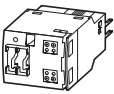

SmartWire-DT® module to assemble on the contactors DILM(C)7...DILM(C)38, DILA..., DILMP20

- One module is necessary per contactor.
- Connection to SmartWire-DT® gateway as slave.
- Max. 16 SmartWire-DT® modules per line.
- 1 digital input for floating contact.
- Signaling contactor switch position.

**SWIRE-DIL**  
107028

5 off  
 

- Take account of the max. current consumption of the contactor coils per SmartWire-DT® line.
- Length of connection cable at the input and the electrical interlock < 2.8 m.
- The A2 connection of the contactors must not be linked.
- Electrical interlocking only possible via the terminals on the module for DILM.
- Wiring sets DILM 12-XRL and PKZM0-XRM12 cannot be used.
- Connection terminals for electrical interlocking are not suitable for safety technology.

##### SmartWire-DT® power module



Power module for supplying the control voltage.

- Connection on SmartWire-DT® gateway as interactive station (no address).

**SWIRE-PF**  
107029

1 off  
 

Max. 4 power modules per SmartWire-DT® line.

##### SmartWire-DT® I/O mod-ule



4 digital inputs  
2 digital relay outputs

**SWIRE-4DI-2DO-R**  
107030

1 off  
 

Max. 4 SmartWire-DT® I/O modules per line.























#### Information relevant for export to North America



Product Standards	IEC/EN 60947-4-1; UL 508; CSA-C22.2 No.14-05;
	CE marking
UL File No.	E29184
UL CCN	NKCR
CSA File No.	012528
CSA Class No.	2252-01
NA Certification	UL Listed, CSA certified



SWIRE-...

Description	Part no. Article no.	Price See price list	Std. pack	Notes
<b>Accessory</b>				
SmartWire-DT® connection cable <sup>1)</sup>				
Length: 85 mm	<b>SWIRE-CAB-008</b> 107032		25 off  	Cable lengths: Engineering → 34
Length: 110 mm	<b>SWIRE-CAB-011</b> 107033		25 off  	
Length: 150 mm	<b>SWIRE-CAB-015</b> 107034		5 off  	
Length: 250 mm	<b>SWIRE-CAB-025</b> 107035		5 off  	
Length: 500 mm	<b>SWIRE-CAB-050</b> 112027		1 off  	
Length: 1000 mm	<b>SWIRE-CAB-100</b> 107036		1 off  	
Length: 2000 mm	<b>SWIRE-CAB-200</b> 107037		1 off  	
Termination connector <sup>1)</sup>				
– Termination plug for last SmartWire-DT® card, 6 pole, no electrical function.	<b>SWIRE-CAB-000</b> 107031		25 off  	–
Data cable <sup>1)</sup>				
– 6-core, ribbon cable, length: 100 m.	<b>SWIRE-CAB-100M</b> 107038		1 off  	Preassembly of cable only possible with special tool.
Plug <sup>1)</sup>				
– 6-pin plug for ribbon cable.	<b>SWIRE-CAB-CON</b> 107039		50 off  	For use with SWIRE-CAB-100M.
NHI-E with cable <sup>1)</sup>				
– NHI-E-10-PKZO with connection cable AWG18 blue, for connection to SmartWire-DT® module for DILM.	<b>NHI-E-10L-PKZO</b> 107040		5 off	–
Plug-in reversing bridge <sup>2)</sup>				
– For assembling reversing starters with tool-less plug connection	<b>DILM12-XR</b> 110099		20 off  	For use with DILM7...DILM15, without A2 link.

Information relevant for export to North America



1)  
 Product Standards IEC/EN 60947-4-1; UL 508; CSA-C22.2 No.14-05; CE marking  
 UL File No. E29184  
 UL CCN NKCR  
 CSA File No. 012528  
 CSA Class No. 2252-01  
 NA Certification UL Listed, CSA certified

2)  
 Product Standards IEC/EN 60947-4-1; UL 508; CSA-C22.2 No.14-05; CE marking  
 UL File No. E36332  
 UL CCN NLRV  
 CSA File No. 012528  
 CSA Class No. 3211-05  
 NA Certification UL Listed, CSA certified

# 1.4 Connection system SmartWire-DT®

## 1 Engineering

### SWIRE-... Cable lengths

For connection between motor starters and contactors DILM, the cable lengths depend on the combination and assembly of the devices.

Applications	PKZ accessories	from	to	Cable length
<b>Contactors DILM</b>	None (45 grid)	DILM7-...15	DILM7-...15	85 mm
		DILM17-...38	DILM17-...38	85 mm
		DILM7-...38	DILM17-...38	110 mm
		DILM17-...38	DILM7-...15	110 mm
	PKZM0 with U-/A.../NHI.../AGM...	DILM7-...15	DILM7-...15	110 mm
		DILM17-...32	DILM17-...32	110 mm
		DILM7-...15	DILM17-...32	110 mm
		DILM17-...32	DILM7-...15	110 mm
<b>Motor starters MSC</b>	None (45 grid)	DILM7-...15	DILM7-...15	85 mm
		DILM17-...32	DILM17-...32	85 mm
		DILM7-...15	DILM17-...32	110 mm
		DILM17-...32	DILM7-...15	110 mm
	PKZM0 with U-/A.../NHI.../AGM...	DILM7-...15	DILM7-...15	110 mm
		DILM17-...32	DILM17-...32	110 mm
		DILM7-...15	DILM17-...32	150 mm
		DILM17-...32	DILM7-...15	150 mm

### SWIRE-... Cable lengths

The cable lengths for connecting SmartWire-DT® devices depend on the combination and assembly of the devices.

Applications	Cable length
Connection from power module to SWIRE-DIL with mounting beside PKZ	250 mm
Connection from power module to SWIRE-DIL with mounting beside DILM	150 mm
Connection from gateway to SWIRE-DIL with mounting beside PKZ	250 mm
Connection from coupling unit to SWIRE-DIL with mounting beside DILM	250 mm

### SWIRE-... Magnet systems

The number of motor starters or contactors DILM that can be connected is dependant on the power consumption of the magnet systems per SmartWire-DT® line. To increase the number of SmartWire-DT® modules that can be connected, power modules can be used.

24 V DC		DILM7	DILM9	DILM12	DILM15	DILM17	DILM25	DILM32/38
Pick-up power	W	3	3	4.5	12 at 24 V	12 at 24 V	12 at 24 V	12 at 24 V
Holding power	W	3	3	4.5	0.5 at 24 V	0.5 at 24 V	0.5 at 24 V	0.5 at 24 V

**Technical data**
**SWIRE-...**

		SWIRE-GW-DP	SWIRE-PF	SWIRE-DIL
<b>General</b>				
Standards				
General		IEC/EN 60947 EN 55011 EN 55022 IEC/EN 61000-4 IEC/EN 60068-2-27		
Profibus-DP		IEC 61158	–	–
Mounting		Top-hat rail IEC/EN 60715 (35mm) or screw fixing with fixing brackets ZB4-101-GF1 (accessories)		on DILM7...DILM38
Dimensions (w x d x h)	mm	35 x 90 x 109	35 x 90 x 74	45 x 44 x 81
Weight	kg	0.15	0.1	0.04
<b>Terminal capacity</b>				
Solid	mm <sup>2</sup>	0.34...1.5	0.34...1.5	0.34...1.5
Flexible with ferrule	mm <sup>2</sup>	0.34...1.5	0.34...1.5	0.34...1.5
Solid or stranded	AWG	22...16	22...16	22...16
Flat-blade screwdriver	mm	3.5 x 0.8	3.5 x 0.8	3.5 x 0.8
Max. tightening torque	Nm	0.6	0.6	0.5
<b>Ambient climatic conditions</b>				
Ambient temperature	Operation	°C	-25 - +55	-25 - +55
	Storage	°C	-25 - +70	-25 - +70
Condensation		Prevent condensation by means of suitable measures		
Relative humidity, non-condensing (IEC/EN 60068-2-30)	%	5 - 95	5 - 95	5 - 95
Air pressure (in operation)	hPa	795 - 1080	795 - 1080	795 - 1080
<b>Ambient mechanical conditions</b>				
Protection type (IEC/EN 60529)		IP20	IP20	IP20
Pollution degree		2	2	2
Mounting position		Vertical	Vertical	As per DILM7 to DILM38
<b>Electromagnetic compatibility (EMC)</b>				
Electrostatic discharge (IEC EN 61000-4-2, Level 3, ESD)				
Air discharge	kV	8	8	8
Contact discharge	kV	–	–	–
Electromagnetic fields (IEC/EN 61000-4-3, RFI)	V/m	10	10	10
Radio interference suppression (EN 55011, EN 55022)		Class A	Class A	Class A
Burst pulses(IEC/EN 61000-4-4, level 3)				
Supply cables	kV	2	2	2
Signal cables	kV	2	2	2
High-energy pulses (surge) (IEC/EN 61000-4-5, level 2)	kV	0.5 (supply cables, symmetrical)		
Emitted RFI (IEC/EN 61000-4-6)	V	10	10	10
<b>Insulation resistance</b>				
Clearances and creepage distances		EN 50178, EN 60947-1, UL 508, CSA C22.2 No 142		
Insulation resistance		EN 50178, EN 60947-1		
<b>Supply voltage, gateway electronics and SmartWire-DT® station electronics</b>				
<b>U<sub>gateway</sub></b>				
Rated operational voltage U <sub>gateway</sub>	V DC	24, -15 %, +20 %	–	–
Permissible range		20.4...28.8	20.4...28.8	Supply from gateway or power module
Ripple	%	≅ 5	–	–
Maximum coupling unit power consumption at 24 V DC	mA	500 (typically 100 for gateway + typically 25 per SmartWire-DT® module)	–	–
Voltage dips (IEC/EN 61131-2)	ms	10	–	–
Heat dissipation at 24 V DC	W	Normally 6	Normally 1	Normally 0.6
Protection against polarity reversal		Yes	–	–
Short-circuit protection, SmartWire-DT® side		Yes	–	–

# 1.4 Connection system SmartWire-DT®

## SWIRE-...

1

		SWIRE-GW-DP	SWIRE-PF	SWIRE-DIL
<b>General</b>				
<b>Supply voltage <math>U_{AUX}</math> (supply voltage for switching SmartWire-DT® elements, e.g. contactor coils)</b>				
Rated operational voltage $U_{AUX}$	V DC	24, -15 %, +20 % (Derating from > 40 °C)	24, -15 %, +20 % (Derating from > 40 °C)	Supply from gateway or power module
Permissible range	V DC	20.4...28.8, at 45 °C: 21...28.8, at 50 °C: 21.6...28.8, at 55 °C: 22.2...27.6	20.4...28.8, at 45 °C: 21...28.8, at 50 °C: 21.6...28.8, at 55 °C: 22.2...27.6	Supply from gateway or power module
Input current $U_{AUX}$ at 24 V DC	A	Normally 3	Normally 3	–
Ripple	%	≅ 5	≅ 5	–
Voltage dips (IEC/EN 61131-2)	ms	10	10	–
Protection against polarity reversal				
Short-circuit protection, SmartWire-DT® side		No, external fuse 3 A or FAZ-Z3	No, external fuse 3 A or FAZ-Z3	–
<b>LED indicators</b>				
Operational		Ready: green	–	Ready: green
Power supply, SmartWire-DT® contactors		$U_{AUX}$ : green	$U_{AUX}$ : green	–
PROFIBUS-DP status		PROFIBUS-DP: green	–	–
SmartWire-DT® status		SmartWire-DT®: green	–	above Ready
Output status		–	–	–
<b>Connection floating contacts</b>				
Number		–	–	1
Rated voltage (internal supply)	$U_e$	V DC	–	17
Input current at "1" signal, typically		mA	–	5
Potential isolation		–	–	No
Max. cable length		m	–	< 2.8
<b>PROFIBUS-DP</b>				
Terminal type		SUB-D 9-pole, socket	–	–
Station address		1 ... 125	–	–
Address setting		DIP switches	–	–
Potential isolation				
From $U_{AUX}$ power supply		Yes	–	–
From $U_{Gateway}$ power supply		Yes	–	–
To SmartWire-DT®		Yes	–	–
Function		PROFIBUS-DP slave	–	–
Bus protocol		PROFIBUS-DP	–	–
Bus Terminating Resistors		can be connected via plug	–	–
Baud rate		Automatic, up to 12 Mbits/s	–	–
<b>SmartWire-DT®</b>				
Terminal type		Plug, 6-pole	Plug, 6-pole	Plug, 6-pole
Data/power cable		6-core ribbon cable	6-core ribbon cable	6-core ribbon cable
Maximum cable length, SmartWire-DT® system	m	Max. 4	Max. 4	Max. 4
Bus termination		No	Plug connectors	Plug connectors
Station address		Automatic assignment	None	1...16
Station		max. 126 PROFIBUS stations	Max. 4 SmartWire-DT® cards per line	Max. 16 SmartWire-DT® cards per line
Address setting		None	None	automatically via SmartWire-DT®
Potential isolation				
From $U_{AUX}$ power supply		No	No	No
From $U_{Gateway}$ power supply		No	No	No
Function		SmartWire-DT® master	no SmartWire-DT® station	SmartWire-DT® slave
Data transfer time, SmartWire-DT® system				
Write switch		–	–	Normally 20 ms for all stations
Read status information		–	–	Normally 10 ms per station

SWIRE-...

1

		SWIRE-4DI-2DO-R	SWIRE-GW-MB
<b>General</b>			
Standards			
General		IEC/EN 60947, EN 55011, EN 55022, IEC/EN 61000-4, IEC/EN 60068-2-27	
Mounting		Tophat rail IEC/EN 60715 (35 mm) or screw fixing with fixing brackets ZB4-101-GF1 (accessories)	
Dimensions (w x d x h)	mm	35 x 90 x 74	35 x 90 x 109
Weight	kg	0.12	0.15
<b>Terminal capacity</b>			
Solid	mm <sup>2</sup>	0.5...1.5	0.5...1.5
Flexible with ferrule	mm <sup>2</sup>	0.5...1.5	0.5...1.5
Solid or stranded	AWG	22...16	22...16
Flat-blade screwdriver	mm	3.5 x 0.8	3.5 x 0.8
Max. tightening torque	Nm	0.6	0.6
<b>Ambient climatic conditions</b>			
Ambient temperature	Operation	°C	-25 - +55
	Storage	°C	-25 - +70
Condensation		Prevent condensation by means of suitable measures	
Relative humidity, non-condensing (IEC/EN 60068-2-30)	%	5 - 95	5 - 95
Air pressure (in operation)	hPa	795 - 1080	795 - 1080
<b>Ambient mechanical conditions</b>			
Protection type (IEC/EN 60529, EN50178, VBG 4)		IP20	IP20
Pollution degree		2	2
Mounting position		Vertical	Vertical
<b>Electromagnetic compatibility (EMC)</b>			
Electrostatic discharge (IEC/EN 61000-4-2, Level 3, ESD)			
Air discharge	kV	8	8
Contact discharge	kV	–	–
Electromagnetic fields (IEC/EN 61000-4-3, RFI)	V/m	10	10
Radio interference suppression (EN 55011, EN 55022)		Class A	Class A
Burst pulses (IEC/EN 61000-4-4, level 3)			
Supply cables	kV	2	2
Signal cables	kV	–	2
power pulses (surge) (IEC/EN 61000-4-5, level 2)	kV	0.5 (supply cables, symmetrical)	
Emitted RFI (IEC/EN 61000-4-6)	V	10	10
<b>Insulation resistance</b>			
Clearances and creepage distances		EN 50178, EN 60947-1, UL 508, CSA C22.2 No 142	
Insulation resistance		EN 50178, EN 60947-1	
<b>Supply voltage, gateway electronics and SmartWire-DT® station electronics U<sub>gateway</sub></b>			
Rated operational voltage U <sub>gateway</sub>	V DC	–	24, -15 %, +20 %
Permissible range		Supply from gateway or power module	20.4...28.8
Ripple	%	–	≅ 5
Maximum gateway current consumption at 24 V DC	mA	–	500 (normally 100 coupling unit + normally 25 per SmartWire-DT® card)
Voltage dips (IEC/EN 61131-2)	ms	–	10
Heat dissipation at 24 V DC	W	–	Normally 6
Protection against polarity reversal			Yes
Short-circuit protection, SmartWire-DT® side		–	Yes
<b>Power supply U<sub>AUX</sub> (power supply for switching the SmartWire-DT® slaves, e.g. contactor coils)</b>			
Rated operational voltage U <sub>AUX</sub>	V DC	–	24, -15 %, +20 % (Derating from > 40 °C)
Permissible range	V DC	–	20.4...28.8, at 45 °C: 21...28.8, at 50 °C: 21.6...28.8, at 55 °C: 22.2...27.6
Input current U <sub>AUX</sub> at 24 V DC	A	–	Normally 3
Ripple	%	–	≅ 5
Voltage dips (IEC/EN 61131-2)	ms	–	10
Protection against polarity reversal			Yes
Voltage	U <sub>s</sub>	V	–
Short-circuit protection, SmartWire-DT® side		–	No, external 3 A fuse or FAZ-Z3

# 1.4 Connection system SmartWire-DT®

## SWIRE-...

1

	SWIRE-4DI-2DO-R			SWIRE-GW-MB
<b>LED indicators</b>				
Operational				Ready: green
Power supply, SmartWire-DT® contactors				U <sub>Aux</sub> : green
MODBUS status				MODBUS: yellow
SmartWire-DT® status				SmartWire-DT®: green
Output status				Q1, Q2: green
<b>Connection floating contacts</b>				
Number			4	–
Rated voltage (internal supply)	U <sub>e</sub>	V DC	17	–
Input current at "1" signal, typically		mA	5	–
Potential isolation			–	Yes
Max. cable length		m	< 2.8	–
<b>MODBUS</b>				
Terminal type			–	SUB-D, 9 pole, socket RS232/RS485
Station address			–	1 ... 31
Address setting			–	DIP switches
Potential isolation				
From U <sub>AUX</sub> power supply			–	Yes
From U <sub>Gateway</sub> power supply			–	Yes
To SmartWire-DT®			–	Yes
Function			–	MODBUS-RTU Slave
Bus protocol			–	MODBUS-RTU
Bus Terminating Resistors			–	can be connected via plug
Baud rate			–	Adjustable up to 57.6 (9.6/19.2/38.4) kbit/s
<b>SmartWire-DT®</b>				
Terminal type			Plug, 6-pole	Plug, 6-pole
Data/power cable			6-core ribbon cable	6-core ribbon cable
Maximum cable length, SmartWire-DT® system		m	Max. 4	Max. 4
Bus termination			Plug connectors	No
Station address			1...16	Automatic assignment
Station			Max. 4 SmartWire-DT® modules per line.	Max. 16
Address setting			automatically via SmartWire-DT®	None
Potential isolation				
From U <sub>AUX</sub> power supply			No	No
From U <sub>Gateway</sub> power supply			No	No
Function			SmartWire-DT® slave	SmartWire-DT® master
Data transfer time, SmartWire-DT® system				
Write switch			Normally 20 ms for all stations	–
Read status information			Normally 10 ms per station	–
<b>Relay outputs</b>				
Rated impulse withstand voltage	U <sub>imp</sub>	V AC	4000	–
Overvoltage category/pollution degree			III/3	–
Rated insulation voltage	U <sub>i</sub>	V	250	–
Rated operating voltage	U <sub>e</sub>	V	250	–
Making capacity		A	30	–
Breaking capacity	380/400 V	A	10	–
Rated operational current				
AC-15, 250 V	I <sub>e</sub>	A	3	–
DC-12, 30 V	I <sub>e</sub>	A	3	–
Conventional thermal current	I <sub>th</sub>	A	6	6
Short-circuit rating without welding				
max.fuse		AgG/gL	10	–

## MSC-D, MSC-R, MSC-DE(A)

### MSC-D, MSC-R, MSC-DE(A)

1

<b>General</b>	<b>Standards</b>	IEC/EN 60947-4-1, VDE 0660 UL 508 (please enquire) CSA C 22.2 No. 14 (please enquire)		
	Mounting position			
<b>Main contacts</b>	<b>Rated impulse withstand voltage</b>	$U_{imp}$	V AC	6000
	Overvoltage category/pollution degree			III/3
	<b>Rated operating voltage</b>	$U_e$	V	230 - 415
<b>Further technical data</b>	<b>Motor protective circuit breaker</b>	PKZM0, PKE → Chapter 1.3		
	Contactors DILM	→ Chapter 1.1		

## Dimensions

### DOL starters

MSC-D-...-M7[...15]...

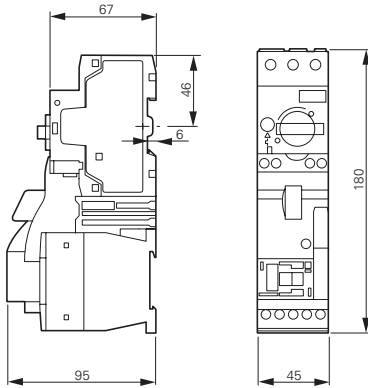

MSC-D-...-M17[...32]...

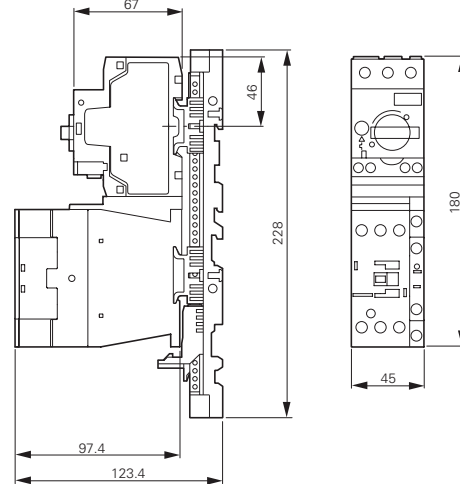

MSC-D-...-M7[...15]BBA...

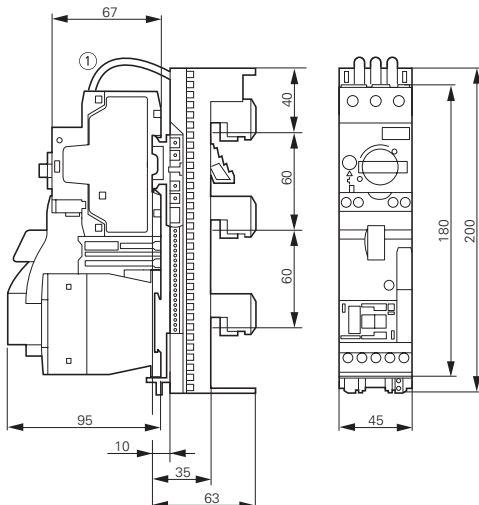

MSC-D-...-M17[...32]BBA...

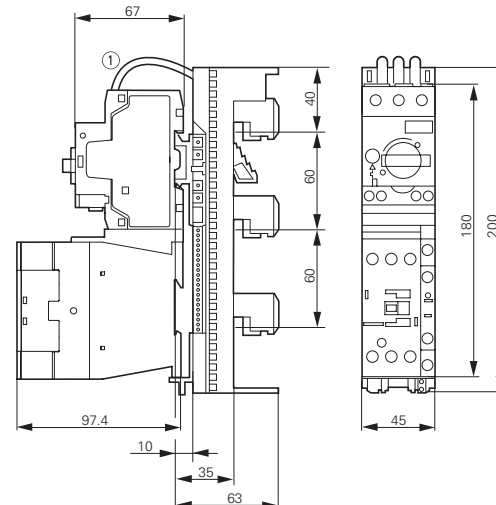

# 1.4 Motor-starter combinations

DOL starters, reversing starters

## Reversing starters

1

MSC-R-...-M7[...12]...



MSC-R-...-M17[...32]...

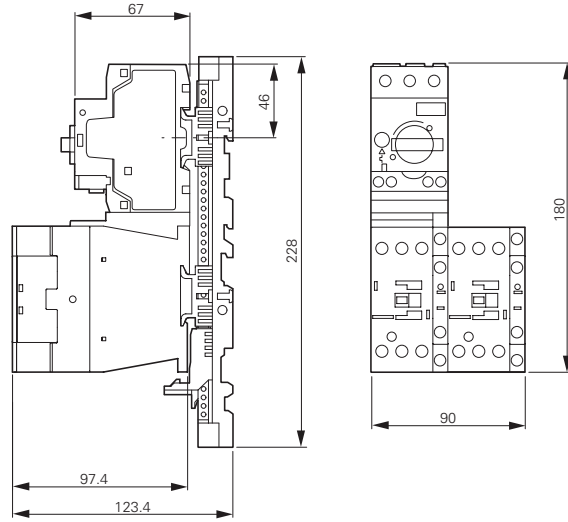

MSC-R-...-M7[...12]BBA...



MSC-R-...-M17[...32]BBA...



## DOL starters

MSC-DE(A)-...-M7[...12]...



MSC-DE(A)-...-M7[...12]...

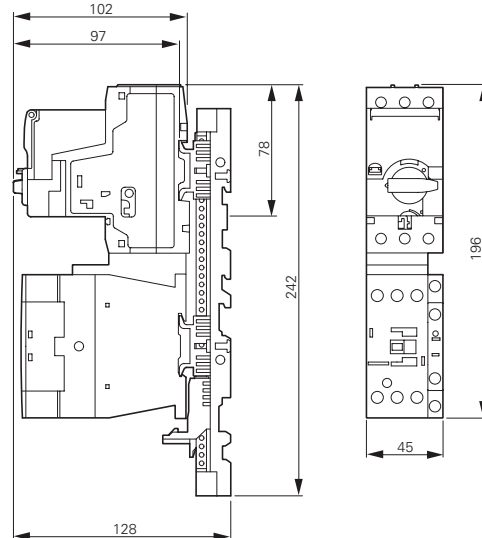



**Modules**

SWIRE-DIL

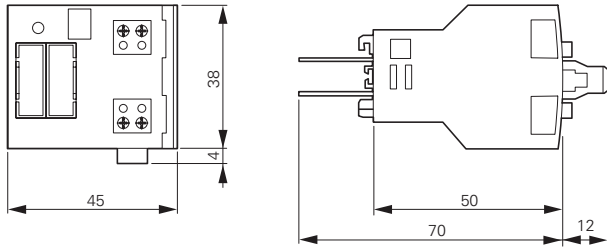

SWIRE-PF, SWIRE-4DI-2DO-R

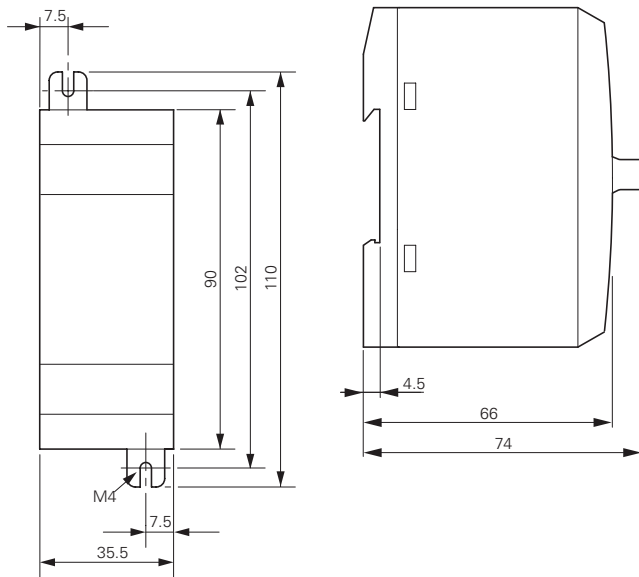

**Gateways**

SWIRE-GW-DP..., SWIRE-GW-MB

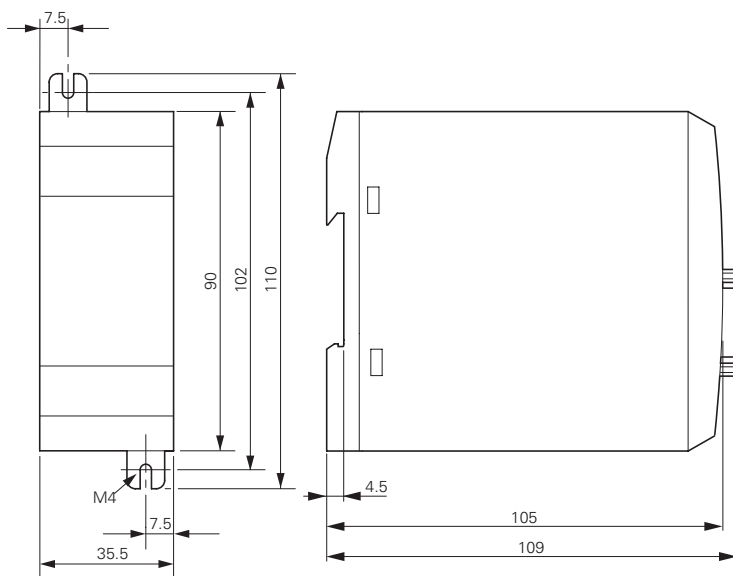

Control relays XTRG



System overview

Control relays XTRG ..... 1

Product selection

Basic devices XTRG ..... 2

Auxiliary contact modules, Actuating voltages / Accessories ..... 3

Technical data

Control relays XTRG ..... 4

Control relays XTRG

Product description

Part of the E Line family of controls, the XTRG control relay offers space savings, enhanced reliability and more efficient use of materials. Rated to operate thermal currents up to 10A, AC voltages up to 660V or DC voltages up to 250V, the XTRG contactor relay offers optimum performance in a compact package.

Features

- 10A Control relay
- 690V Insulation rating
- 660VAC or 250VDC Operational voltage
- Up to 5 sets of normally open or normally closed contacts with add-on blocks
- All common AC control voltages
- DIN rail or panel mount options
- Unique 27mm design

System overview

Control relays are used to remotely switch small loads or in complex control schemes. The XTRG relay can be integrated with contactors from the E Line family of motor controls to create compact, efficient control panels for a multitude of applications.

Standards and certifications

- GB 14048
- IEC/EN 60947
- CCC
- CE

Accessory overview

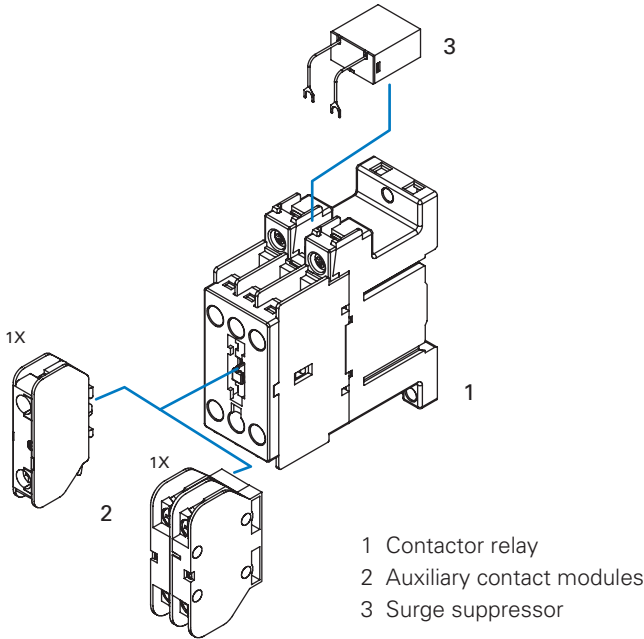

# 2.1

## Control relays XTRG

Product selection

XTRG

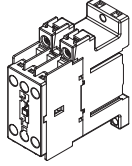

2

### Control relays

Connection type	Contact		Rated operational current AC-15 I <sub>e</sub> (A)		Conventional thermal current, open, 40°C I <sub>th</sub> (A)	Circuit symbol	Can be combined with auxiliary contact module	AC operation	Standard package
	N/O=Normally open	N/C=Normally closed	220V	380 V				Part no. Article no.	
Screw terminals	3 N/O	-	4	1.9	10		XTCGXFAC10 XTCGXFAC..	<b>XTRG10B30DT</b> 168044	1 piece
Screw terminals	2 N/O	1 N/C	4	1.9	10		XTCGXFAC10 XTCGXFAC..	<b>XTRG10B21DT</b> 167927	1 piece
Screw terminals	1 N/O	2 N/C	4	1.9	10		XTCGXFAC10 XTCGXFAC..	<b>XTRG10B12DT</b> 167968	1 piece
Screw terminals	-	3 N/C	4	1.9	10		XTCGXFAC10 XTCGXFAC..	<b>XTRG10B03DT</b> 167978	1 piece

### Actuating voltages

Coil Voltage	3NO	2NO/1NC	1NO/2NC	3NC
24VAC 50Hz	<b>XTRG10B30B5</b> 168040	<b>XTRG10B21B5</b> 167923	<b>XTRG10B12B5</b> 167933	<b>XTRG10B03B5</b> 167974
36VAC 50Hz	<b>XTRG10B30DS</b> 168041	<b>XTRG10B21DS</b> 167924	<b>XTRG10B12DS</b> 167934	<b>XTRG10B03DS</b> 167975
48VAC 50Hz	<b>XTRG10B30C5</b> 168042	<b>XTRG10B21C5</b> 167925	<b>XTRG10B12C5</b> 167966	<b>XTRG10B03C5</b> 167976
110VAC 50Hz	<b>XTRG10B30E5</b> 168043	<b>XTRG10B21E5</b> 167926	<b>XTRG10B12E5</b> 167967	<b>XTRG10B03E5</b> 167977
220VAC 50Hz	<b>XTRG10B30DT</b> 168044	<b>XTRG10B21DT</b> 167927	<b>XTRG10B12DT</b> 167968	<b>XTRG10B03DT</b> 167978
380VAC 50Hz	<b>XTRG10B30DU</b> 168047	<b>XTRG10B21DU</b> 167930	<b>XTRG10B12DU</b> 167971	<b>XTRG10B03DU</b> 167936
24V 50/60Hz	<b>XTRG10B30B2</b> 177675	<b>XTRG10B21B2</b> 177687	<b>XTRG10B12B2</b> 177693	<b>XTRG10B03B2</b> 177681
36V 50/60Hz	<b>XTRG10B30DV</b> 177676	<b>XTRG10B21DV</b> 177688	<b>XTRG10B12DV</b> 177694	<b>XTRG10B03DV</b> 177682
48V 50/60Hz	<b>XTRG10B30C2</b> 177677	<b>XTRG10B21C2</b> 177689	<b>XTRG10B12C2</b> 177695	<b>XTRG10B03C2</b> 177683
110V 50/60Hz	<b>XTRG10B30E2</b> 177678	<b>XTRG10B21E2</b> 177690	<b>XTRG10B12E2</b> 177696	<b>XTRG10B03E2</b> 177684
220V 50/60Hz	<b>XTRG10B30AO</b> 177679	<b>XTRG10B21AO</b> 177691	<b>XTRG10B12AO</b> 177697	<b>XTRG10B03AO</b> 177685
380V 50/60Hz	<b>XTRG10B30AR</b> 177680	<b>XTRG10B21AR</b> 177692	<b>XTRG10B12AR</b> 177698	<b>XTRG10B03AR</b> 177686
24V DC	<b>XTRG10B30B0</b> 178153	<b>XTRG10B21B0</b> 178152	<b>XTRG10B12B0</b> 178154	<b>XTRG10B03B0</b> 178151

Auxiliary contact, top mounting

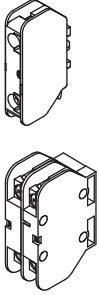

Auxiliary contact modules

Connection type		Conventional thermal current open, 40°C  $I_{th} = I_e$ AC-1 A	Contact  N/O=Normally open N/C=Normal closed		Circuit symbol	Can be combined with control relay	Part no. Article no.	Standard package
Screw terminals	1 pole	10	1 N/O	-		XTRG10B..	<b>XTCGXFAC10</b> 167939	1 piece
Screw terminals	1 pole	10	-	1 N/C		XTRG10B..	<b>XTCGXFAC01</b> 167940	1 piece
Screw terminals	2 pole	10	2 N/O	-		XTRG10B..	<b>XTCGXFAC20</b> 167941	1 piece
Screw terminals	2 pole	10	1 N/O	1 N/C		XTRG10B..	<b>XTCGXFAC11</b> 167942	1 piece
Screw terminals	2 pole	10	-	2 N/C		XTRG10B..	<b>XTCGXFAC02</b> 167943	1 piece

Coil surge supsressor

Coil voltage	RC	Varistor
24-48V	<b>XTCGXRSCN2</b> 167946	<b>XTCGXVSCN2</b> 167949
110-220V	<b>XTCGXRSCDV</b> 167947	<b>XTCGXVSCDV</b> 167950
380-440V	<b>XTCGXRSCCM</b> 167948	<b>XTCGXVSCCM</b> 167951

# 2.1

## Control relays XTRG

### Technical data

#### General

2

			XTRG10B..	XTCGXFAC..
Standards			IEC/EN 60947, GB 14048	
<b>Mechanical lifespan</b>				
AC operated	Operations	x 10 <sup>6</sup>	10	10
<b>Maximum operating frequency</b>				
Maximum operating frequency	Operations/h		3600	3600
Climatic proofing			Damp heat, constant, to IEC 60068-2-78 Damp heat, cyclic, to IEC 60068-2-30	
<b>Ambient temperature</b>				
Operation		°C	-25-55	-25-55
Storage		°C	-40-80	-40-80
Protection type			IP20	IP20
Weight approximate weight		kg	0.17	0.02

#### Contacts





			XTRG10B..	XTCGXFAC..
Rated impulse withstand voltage	U <sub>imp</sub>	VAC	6000	6000
Overvoltage category/degree of pollution			III/3	III/3
Rated insulation voltage	U <sub>i</sub>	VAC	690	690
Rated operational voltage	U <sub>e</sub>	VAC	660	660
Rated operational current				
<b>AC-15</b>				
120V	I <sub>e</sub>	A	6	6
240V	I <sub>e</sub>	A	4	4
380V	I <sub>e</sub>	A	1.9	1.9
480V	I <sub>e</sub>	A	1.5	
500V	I <sub>e</sub>	A	1.4	
600V	I <sub>e</sub>	A	1.2	
<b>DC-13</b>				
125V	I <sub>e</sub>	A	0.55	0.55
250V	I <sub>e</sub>	A	0.27	0.27
Conventional thermal current	I <sub>th</sub>	A	10	10
<b>Electrical lifespan</b>				
at U <sub>e</sub> =230V, AC-15, 3A	Operations	x 10 <sup>6</sup>	1	1

**Magnet system**



			<b>XTRG10B..</b>
Voltage tolerance	Pick-up	$x U_c$	0.85-1.1
Power consumption of coil in a cold state and 1.0 xUc (50Hz)	Pick-up	VA	30
	Sealing	VA	6
	Sealing	W	2
	Sealing	W	2
Power consumption of coil in a cold state and 1.0 xUc (50/60Hz)	50Hz Pick-up	VA	35
	50Hz Sealing	VA	6.5
	50Hz Sealing	W	2.3
Power consumption of coil in a cold state and 1.0 xUc (50/60Hz)	60Hz Pick-up	VA	30
	60Hz Sealing	VA	6
	60Hz Sealing	W	2.1
Power consumption of coil in a cold state and 1.0 xUc (24VDC)	Pick-up	VA	12
	Sealing	W	3

**Terminals**

**XTRG10B..**

	 mm <sup>2</sup>	 mm <sup>2</sup>	Nm
	0.75-2.5	0.75-2.5	0.8
	0.75-2.5	0.75-2.5	

**XTCGXFAC..**

A1 / A2 / Aux	mm <sup>2</sup>	Nm
	0.75-2.5	0.8
		

# 2.1

## Contactors XTCG

### Contents

#### Contactors XTCG

2



#### System overview

Contactors XTCG ..... 6

#### Product selection

Basic devices XTCG ..... 7

Auxiliary contact modules ..... 7

Accessories ..... 8

#### Technical data

Contactors XTCG ..... 10

Auxiliary contact modules ..... 11

### Contactors XTCG

#### Product description

The XTCG is the flagship of the E Line family of motor controls. The XTCG contactor offers space savings, enhanced reliability and more efficient use of materials. Boasting AC-3 ratings up to 95A @ 400V and with a maximum operating voltage of 660V, XTCG offers tremendous performance in a small package.

#### Features

- Technologically advanced contact design
- 690V insulation rating
- Operating voltage up to 660VAC
- Up to (3) add on auxiliary contact modules
- All common AC control voltages
- DIN rail or panel mount options
- Unique space saving design

#### System overview

3 phase contactors are used to start motors or control industrial loads. The E Line family of contactors allows the starting of motors up to 45kW, and when combined with an XTOD overload relay or PKZC motor protective circuit breaker offers a complete package of protection and control for long life and reliable operation.

#### Standards and certifications

- GB 14048
- IEC/EN 60947
- CCC
- CE

### Accessory overview

#### 7-12A Frame

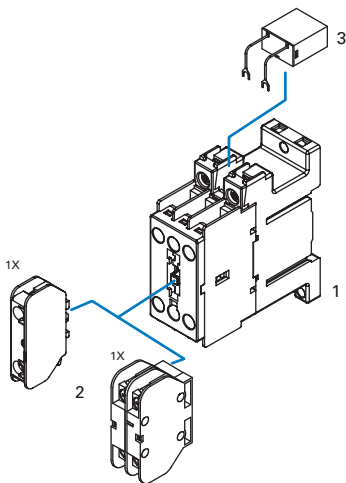

#### 18-38A Frame

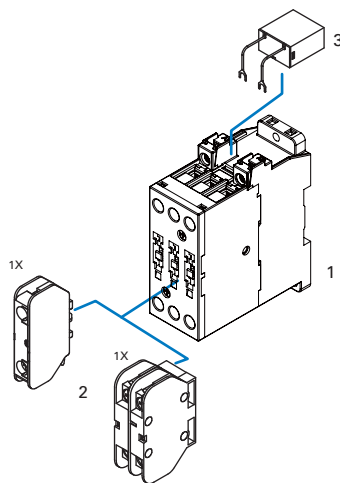

#### 40-95A Frame

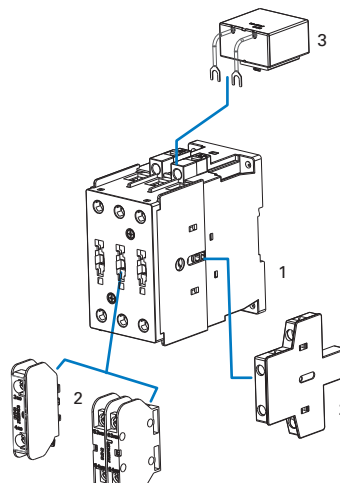

#### With mechanical interlock

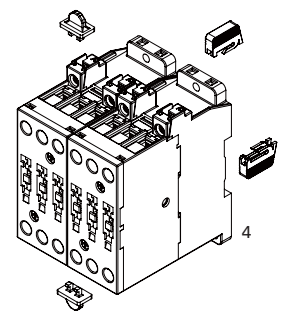

- 1 Contactor relay
- 2 Auxiliary contact modules
- 3 Surge suppressor
- 4 Interlocking kit

XTCG



3-pole contactors

Connection type	Rated operational current AC-3 I <sub>e</sub> (A) 380V	Max motor rating for 3-phase motors, 50-60Hz AC-3 P kW			Conventional thermal current, open, 40 °C I <sub>th</sub> = I <sub>e</sub> AC-1(A)	Circuit symbol	AC operation Part no. Article no. Actuating voltage 220V 50Hz	Standard package
		220V	380V	660V*				
Screw terminals	7	2.2	3	3.5	20		<b>XTCG007B00DT</b> 167984	1 piece
Screw terminals	9	2.5	4	4.5	20		<b>XTCG009B00DT</b> 167994	1 piece
Screw terminals	12	3.5	5.5	5.5	20		<b>XTCG012B00DT</b> 168004	1 piece
Screw terminals	18	5	7.5	7.5	25		<b>XTCG018C00DT</b> 168014	1 piece
Screw terminals	25	7.5	11	11	35		<b>XTCG025C00DT</b> 168024	1 piece
Screw terminals	32	10	15	15	40		<b>XTCG032C00DT</b> 168034	1 piece
Screw terminals	38	11	18.5	22	40		<b>XTCG038C00DT</b> 174459	1 piece
Screw terminals	40	12.5	18.5	22	60		<b>XTCG040D00DT</b> 172214	1 piece
Screw terminals	50	15.5	22	30	70		<b>XTCG050D00DT</b> 172224	1 piece
Screw terminals	65	20	30	37	80		<b>XTCG065D00DT</b> 172234	1 piece
Bolts terminals	80	25	37	37	110		<b>XTCG080E00DT</b> 172244	1 piece
Bolts terminals	95	30	45	45	120		<b>XTCG095E00DT</b> 172254	1 piece

\* 40-95A is 690V.

Auxiliary contact modules

Connection type	Poles	Conventional thermal current open, 40 °C I <sub>th</sub> = I <sub>e</sub> AC-1 A	Contact		Circuit symbol	Can be combined with control relay	Part no. Article no.	Standard package
			N/O=Normally open	N/C=Normal closed				
Screw terminals	1 pole	10	1 N/O	-		XTCG007B00.. XTCG009B00..	<b>XTCGXFAC10</b> 167939	1 piece
	1 pole	10	-	1 N/C		XTCG012B00.. XTCG018C00..	<b>XTCGXFAC01</b> 167940	1 piece
	2 pole	10	2 N/O	-		XTCG025C00.. XTCG032C00..	<b>XTCGXFAC20</b> 167941	1 piece
	2 pole	10	1 N/O	1 N/C		XTCG040D00.. XTCG050D00..	<b>XTCGXFAC11</b> 167942	1 piece
	2 pole	10	-	2 N/C		XTCG065D00.. XTCG080E00.. XTCG095E00..	<b>XTCGXFAC02</b> 167943	1 piece
Screw terminals	2 pole	10	1 N/O	1 N/C		XTCG040D00.. XTCG050D00.. XTCG065D00.. XTCG080E00.. XTCG095E00..	<b>XTCGXSAE11</b> 172260	1 piece

Top mounting

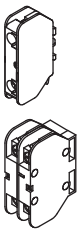

Side mounting





# 2.1

## Contactors XTCG Product Selection

### Actuating voltages

2

Coil voltage	7A	9A	12A	18A	25A	32A	38A
24VAC 50Hz	<b>XTCG007B00B5</b> 167980	<b>XTCG009B00B5</b> 167990	<b>XTCG012B00B5</b> 168000	<b>XTCG018C00B5</b> 168010	<b>XTCG025C00B5</b> 168020	<b>XTCG032C00B5</b> 168030	<b>XTCG038C00B5</b> 174455
36VAC 50Hz	<b>XTCG007B00DS</b> 167981	<b>XTCG009B00DS</b> 167991	<b>XTCG012B00DS</b> 168001	<b>XTCG018C00DS</b> 168011	<b>XTCG025C00DS</b> 168021	<b>XTCG032C00DS</b> 168031	<b>XTCG038C00DS</b> 174456
48VAC 50Hz	<b>XTCG007B00C5</b> 167982	<b>XTCG009B00C5</b> 167992	<b>XTCG012B00C5</b> 168002	<b>XTCG018C00C5</b> 168012	<b>XTCG025C00C5</b> 168022	<b>XTCG032C00C5</b> 168032	<b>XTCG038C00C5</b> 174457
110VAC 50Hz	<b>XTCG007B00E5</b> 167983	<b>XTCG009B00E5</b> 167993	<b>XTCG012B00E5</b> 168003	<b>XTCG018C00E5</b> 168013	<b>XTCG025C00E5</b> 168023	<b>XTCG032C00E5</b> 168033	<b>XTCG038C00E5</b> 174458
220VAC 50Hz	<b>XTCG007B00DT</b> 167984	<b>XTCG009B00DT</b> 167994	<b>XTCG012B00DT</b> 168004	<b>XTCG018C00DT</b> 168014	<b>XTCG025C00DT</b> 168024	<b>XTCG032C00DT</b> 168034	<b>XTCG038C00DT</b> 174459
380VAC 50Hz	<b>XTCG007B00DU</b> 167987	<b>XTCG009B00DU</b> 167997	<b>XTCG012B00DU</b> 168007	<b>XTCG018C00DU</b> 168017	<b>XTCG025C00DU</b> 168027	<b>XTCG032C00DU</b> 168037	<b>XTCG038C00DU</b> 174462
24VAC 50/60Hz	<b>XTCG007B00B2</b> 177208	<b>XTCG009B00B2</b> 177214	<b>XTCG012B00B2</b> 177220	<b>XTCG018C00B2</b> 177226	<b>XTCG025C00B2</b> 177232	<b>XTCG032C00B2</b> 177238	<b>XTCG038C00B2</b> 177639
36VAC 50/60Hz	<b>XTCG007B00DV</b> 177242	<b>XTCG009B00DV</b> 177243	<b>XTCG012B00DV</b> 177244	<b>XTCG018C00DV</b> 177245	<b>XTCG025C00DV</b> 177246	<b>XTCG032C00DV</b> 177247	<b>XTCG038C00DV</b> 177640
48VAC 50/60Hz	<b>XTCG007B00C2</b> 177209	<b>XTCG009B00C2</b> 177215	<b>XTCG012B00C2</b> 177221	<b>XTCG018C00C2</b> 177227	<b>XTCG025C00C2</b> 177233	<b>XTCG032C00C2</b> 177192	<b>XTCG038C00C2</b> 177641
110VAC 50/60Hz	<b>XTCG007B00E2</b> 177210	<b>XTCG009B00E2</b> 177216	<b>XTCG012B00E2</b> 177222	<b>XTCG018C00E2</b> 177228	<b>XTCG025C00E2</b> 177234	<b>XTCG032C00E2</b> 177193	<b>XTCG038C00E2</b> 177642
220VAC 50/60Hz	<b>XTCG007B00AO</b> 177205	<b>XTCG009B00AO</b> 177211	<b>XTCG012B00AO</b> 177217	<b>XTCG018C00AO</b> 177223	<b>XTCG025C00AO</b> 177229	<b>XTCG032C00AO</b> 177235	<b>XTCG038C00AO</b> 177643
380VAC 50/60Hz	<b>XTCG007B00AR</b> 177206	<b>XTCG009B00AR</b> 177212	<b>XTCG012B00AR</b> 177218	<b>XTCG018C00AR</b> 177224	<b>XTCG025C00AR</b> 177230	<b>XTCG032C00AR</b> 177236	<b>XTCG038C00AR</b> 177644
24VDC	<b>XTCG007B00B0</b> 177207	<b>XTCG009B00B0</b> 177213	<b>XTCG012B00B0</b> 177219	<b>XTCG018C00B0</b> 177225	<b>XTCG025C00B0</b> 177231	<b>XTCG032C00B0</b> 177237	<b>XTCG038C00B0</b> 177194

40A	50A	65A	80A	95A
<b>XTCG040D00B5</b> 172210	<b>XTCG050D00B5</b> 172220	<b>XTCG065D00B5</b> 172230	<b>XTCG080E00B5</b> 172240	<b>XTCG095E00B5</b> 172250
<b>XTCG040D00DS</b> 172211	<b>XTCG050D00DS</b> 172221	<b>XTCG065D00DS</b> 172231	<b>XTCG080E00DS</b> 172241	<b>XTCG095E00DS</b> 172251
<b>XTCG040D00C5</b> 172212	<b>XTCG050D00C5</b> 172222	<b>XTCG065D00C5</b> 172232	<b>XTCG080E00C5</b> 172242	<b>XTCG095E00C5</b> 172252
<b>XTCG040D00E5</b> 172213	<b>XTCG050D00E5</b> 172223	<b>XTCG065D00E5</b> 172233	<b>XTCG080E00E5</b> 172243	<b>XTCG095E00E5</b> 172253
<b>XTCG040D00DT</b> 172214	<b>XTCG050D00DT</b> 172224	<b>XTCG065D00DT</b> 172234	<b>XTCG080E00DT</b> 172244	<b>XTCG095E00DT</b> 172254
<b>XTCG040D00DU</b> 172217	<b>XTCG050D00DU</b> 172227	<b>XTCG065D00DU</b> 172237	<b>XTCG080E00DU</b> 172247	<b>XTCG095E00DU</b> 172257
<b>XTCG040D00B2</b> 177645	<b>XTCG050D00B2</b> 177651	<b>XTCG065D00B2</b> 177657	<b>XTCG080E00B2</b> 177663	<b>XTCG095E00B2</b> 177669
<b>XTCG040D00DV</b> 177646	<b>XTCG050D00DV</b> 177652	<b>XTCG065D00DV</b> 177658	<b>XTCG080E00DV</b> 177664	<b>XTCG095E00DV</b> 177670
<b>XTCG040D00C2</b> 177647	<b>XTCG050D00C2</b> 177653	<b>XTCG065D00C2</b> 177659	<b>XTCG080E00C2</b> 177665	<b>XTCG095E00C2</b> 177671
<b>XTCG040D00E2</b> 177648	<b>XTCG050D00E2</b> 177654	<b>XTCG065D00E2</b> 177660	<b>XTCG080E00E2</b> 177666	<b>XTCG095E00E2</b> 177672
<b>XTCG040D00AO</b> 177649	<b>XTCG050D00AO</b> 177655	<b>XTCG065D00AO</b> 177661	<b>XTCG080E00AO</b> 177667	<b>XTCG095E00AO</b> 177673
<b>XTCG040D00AR</b> 177650	<b>XTCG050D00AR</b> 177656	<b>XTCG065D00AR</b> 177662	<b>XTCG080E00AR</b> 177668	<b>XTCG095E00AR</b> 177674
<b>XTCG040D00B0</b> 177195	<b>XTCG050D00B0</b> 177196	<b>XTCG065D00B0</b> 177197	<b>XTCG080E00B0</b> 177198	<b>XTCG095E00B0</b> 177199

# 2.1

## Contactors XTCG

Technical data

### General

2

XT Basic device			CG007	CG009	CG012	CG018	CG025	CG032
Standards			IEC/EN 60947, GB 14048					
<b>Lifespan, mechanical</b>								
AC operated	Operations	x 10 <sup>6</sup>	10	10	10	10	10	10
<b>Operating frequency</b>								
AC operated	Operations/h		3600	3600	3600	3600	3600	3600
Climatic Proofing			Damp heat,constant,to IEC60068-2-78 Damp heat,cyclic,to IEC60068-2-30					
<b>Ambient temperature</b>								
Operation		°C	-25-55	-25-55	-25-55	-25-55	-25-55	-25-55
Storage		°C	-40-80	-40-80	-40-80	-40-80	-40-80	-40-80
Protection type			IP20	IP20	IP20	IP20	IP20	IP20
Weight			kg	0.17	0.17	0.17	0.35	0.35
<b>Terminal capacity of main cable</b>								
Solid/stranded		AWG						
Terminal capacity of control circuit cable		mm <sup>2</sup>	0.75-2.5	0.75-2.5	0.75-2.5	0.75-2.5	0.75-2.5	0.75-2.5
Main cable connection screws / bolts			M3.5	M3.5	M3.5	M5	M5	M5
Tightening torque			Nm	0.8	0.8	0.8	2	2
Control circuit cable connection screws			M3.5	M3.5	M3.5	M3.5	M3.5	M3.5
Tightening torque			Nm	0.8	0.8	0.8	0.8	0.8
<b>Main contacts</b>								
Rated impulse withstand voltage		U <sub>imp</sub> V AC	6000	6000	6000	6000	6000	6000
Overvoltage category / pollution degree			III/3	III/3	III/3	III/3	III/3	III/3
Rated insulation voltage		U <sub>i</sub> V AC	690	690	690	690	690	690
Rated operational voltage		U <sub>e</sub> V AC	660	660	660	660	660	660
Making capacity (cos φ to IEC/EN60947)		380V A	70	90	120	180	250	320
<b>Breaking capacity (cos φ to IEC/EN60947)</b>		380V A	56	72	96	144	200	256
<b>Electrical lifespan</b>								
AC-3		Op.	1,500,000	1,500,000	1,500,000	1,000,000	1,000,000	1,000,000
AC-4		Op.	100,000	100,000	100,000	100,000	100,000	100,000
<b>Magnet systems</b>								
Voltage tolerance AC operated		Pick-up x U <sub>c</sub>	0.85-1.1	0.85-1.1	0.85-1.1	0.85-1.1	0.85-1.1	0.85-1.1
<b>Power consumption of coil in a cold state and 1.0 xU<sub>c</sub></b>		Pick-up VA	30	30	30	80	80	80
		Sealing VA	6	6	6	8.1	8.1	8.1
		Sealing W	2	2	2	2.4	2.4	2.4
<b>Power consumption of coil in a cold state and 1.0 xU<sub>c</sub> ( 50/60Hz )</b>		50Hz Pick-up VA	35	35	35	85	85	85
		50Hz Sealing VA	6.5	6.5	6.5	8.5	8.5	8.5
		50Hz Sealing W	2.3	2.3	2.3	2.6	2.6	2.6
<b>Power consumption of coil in a cold state and 1.0 xU<sub>c</sub> ( 50/60Hz )</b>		60Hz Pick-up VA	30	30	30	80	80	80
		60Hz Sealing VA	6	6	6	8.1	8.1	8.1
		60Hz Sealing W	2.1	2.1	2.1	2.5	2.5	2.5
<b>Power consumption of coil in a cold state and 1.0 xU<sub>c</sub> ( 24VDC )</b>		Pick-up VA	12	12	12	12	12	12
		Sealing W	3	3	3	3	3	3

CG038	CG040	CG050	CG065	CG080	CG095
IEC/EN 60947, GB 14048					
10	5	5	5	5	5
3600	3600	3600	3600	3600	3600
Damp heat,constant,to IEC60068-2-78 Damp heat,cyclic,to IEC60068-2-30					
-25~55	-25~55	-25~55	-25~55	-25~55	-25~55
-40~80	-40~80	-40~80	-40~80	-40~80	-40~80
IP20	IP20	IP20	IP20	IP20	IP20
0.35	0.76	0.76	0.76	1.25	1.25
0.75-2.5	0.75-2.5	0.75-2.5	0.75-2.5	0.75-2.5	0.75-2.5
M5	M6	M6	M6	M8	M8
2	2.5	2.5	2.5	6	6
M3.5	M3.5	M3.5	M3.5	M3.5	M3.5
0.8	0.8	0.8	0.8	0.8	0.8
6000	6000	6000	6000	6000	6000
III/3	III/3	III/3	III/3	III/3	III/3
690	690	690	690	690	690
660	690	690	690	690	690
320	400	500	650	800	950
256	320	400	520	640	760
1,000,000	900,000	900,000	900,000	900,000	900,000
100,000					
0.85-1.1	0.85-1.1	0.85-1.1	0.85-1.1	0.85-1.1	0.85-1.1
80	190	190	190	300	300
8.1	20	20	20	26	26
2.4	4	4	4	6	6
85	220	220	220	350	350
8.5	21	21	21	34	34
2.6	6	6	6	9	9
80	200	200	200	300	300
8.1	20	20	20	26	26
2.5	5	5	5	8	8
12	65	65	65	90	90
3	4	4	4	5	5

# 2.1

## Contactors XTCG



Technical data

### Auxiliary contact



			XTCGXFAC..	XTCGXSAE11
Rated impulse withstand voltage	$U_{imp}$	VAC	6000	6000
Overvoltage category/degree of pollution			III/3	III/3
Rated insulation voltage	$U_i$	VAC	690	690
Rated operational voltage	$U_e$	VAC	660	690
Rated operational current				
<b>AC-15</b>				
120V	$I_e$	A	6	6
240V	$I_e$	A	4	4
380V	$I_e$	A	1.9	1.9
<b>DC-13</b>				
125V	$I_e$	A	0.55	0.55
250V	$I_e$	A	0.27	0.27
Conventional thermal current	$I_{th}$	A	10	10
<b>Electrical lifespan</b>				
at $U_e=230V$ , AC-15, 3A	Operations	$\times 10^6$	1	1

### Terminals



#### 7-12A

	mm <sup>2</sup>	mm <sup>2</sup>	Nm	Aux Contact mm <sup>2</sup>	Nm
	0.75 - 2.5	0.75 - 2.5	0.8	0.75 - 2.5	0.8
	0.75 - 2.5	0.75 - 2.5			



#### 18-38A

	mm <sup>2</sup>	mm <sup>2</sup>	Nm	Aux Contact mm <sup>2</sup>	Nm
	1 - 6 (1 - 10)*	1 - 6 (1 - 10)*	2	0.75 - 2.5	0.8
	1 - 4 (1 - 10)*	1 - 4 (1 - 10)*			

#### 40-65A

	mm <sup>2</sup>	mm <sup>2</sup>	Nm	Aux Contact mm <sup>2</sup>	Nm
	2.5 - 25	2.5 - 16	2.5	0.75 - 2.5	1.2
	2.5 - 25	2.5 - 16			

#### 80-95A

	mm <sup>2</sup>	mm <sup>2</sup>	Nm	Aux Contact mm <sup>2</sup>	Nm
	6 - 50	6 - 25	6	0.75 - 2.5	1.2
	6 - 50	6 - 25			

\* Only for XTCG032...

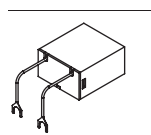

### Coil surge suppressor (7-38A)

Coil voltage	RC	Varistor
24-48V	<b>XTCGXRSCN2</b> 167946	<b>XTCGXVSCN2</b> 167949
110-220V	<b>XTCGXRSCDV</b> 167947	<b>XTCGXVSCDV</b> 167950
380-440V	<b>XTCGXRSCCM</b> 167948	<b>XTCGXVSCCM</b> 167951

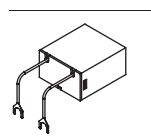

### Coil surge suppressor (40-95A)

Coil voltage	RC	Varistor
24V	<b>XTCGXRSEB5</b> 174132	<b>XTCGXVSEB5</b> 177204
36V	<b>XTCGXRSEDS</b> 174133	<b>XTCGXVSEDS</b> 177239
48V	<b>XTCGXRSEC5</b> 174134	<b>XTCGXVSEC5</b> 177201
110V	<b>XTCGXRSEE5</b> 174129	<b>XTCGXVSEE5</b> 177203
220V	<b>XTCGXRSEDT</b> 174135	<b>XTCGXVSEDT</b> 174142
380V	<b>XTCGXRSEDU</b> 174136	<b>XTCGXVSEDU</b> 174143

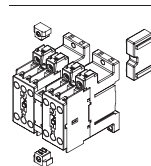

### Mechanical interlock

7-12A	18-38A	40-65A	80-95A
<b>XTCGXMLB</b> 167944	<b>XTCGXMLC</b> 167945	<b>XTCGXMLD</b> 172261	<b>XTCGXMLE</b> 172262

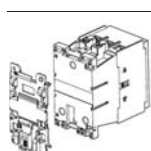

### Din rail plate

80-95A
<b>XTCGXMP</b> 172908

**Thermal overload relays XTOD/XTOG**



**System overview**

Thermal overload relays XTOD/XTOG ..... 13

**Product selection**

Thermal overload relays XTOD/XTOG ..... 14

**Technical data**

Thermal overload relays XTOD/XTOG ..... 16

**Thermal overload relays XTOD/XTOG**

**Product description**

XTOD/XTOG thermal overload relays offer precision motor protection with phase loss protection and ambient temperature compensation. The separate mount design allows for flexibility and the units can be mounted on DIN rail or directly on the panel adjacent the motor contactor.

XTOD... is for separate mounting; XTOG is for direct mounting.

**Features**

- Precision motor protection up to 97A
- Integral 1NO/1NC contact for contactor control and alarm signal
- Phase loss protection
- Ambient temperature compensation
- DIN rail or panel mount options

**System overview**

Thermal overload relays provide protective features for 1 or 3 phase motors. The relay monitors the operating current of the motor and switched the contactor off in the event of an overload situation. It also protects the motor from damage during phase loss.

**Standards and certifications**

- GB 14048
- IEC/EN 60947
- CCC
- CE

# 2.2

## Thermal overload relays XTOD/XTOG

### Product selection

#### Thermal overload relays

2

For use with

Setting range  
of overload  
releases  $I_r$  (A)



Circuit  
symbol

Auxiliary  
contact

N/O =Normally open  
N/C =Normally closed

Part no.  
Article no.

Standard  
package

#### XTOD..CC1S













Model	Mounting	Setting range $I_r$ (A)	Circuit symbol	Auxiliary contact	Part no. Article no.	Standard package
XTCG007	Seperate mounting	0.3~0.45		1 N/O 1 N/C	<b>XTODP45CC1S</b> 167952	1 piece
XTCG009	Seperate mounting	0.45~0.67		1 N/O 1 N/C	<b>XTODP67CC1S</b> 167953	1 piece
XTCG012						
XTCG018	Seperate mounting	0.67~1.0		1 N/O 1 N/C	<b>XTOD001CC1S</b> 167954	1 piece
XTCG025	Seperate mounting	1.0~1.5		1 N/O 1 N/C	<b>XTOD1P5CC1S</b> 167955	1 piece
XTCG032						
XTCG038	Seperate mounting	1.4~2.1		1 N/O 1 N/C	<b>XTOD2P2CC1S</b> 167956	1 piece
	Seperate mounting	1.8~2.7		1 N/O 1 N/C	<b>XTOD2P7CC1S</b> 167957	1 piece
	Seperate mounting	2.4~3.6		1 N/O 1 N/C	<b>XTOD3P6CC1S</b> 167958	1 piece
	Seperate mounting	3.5~5.0		1 N/O 1 N/C	<b>XTOD005CC1S</b> 167959	1 piece
	Seperate mounting	4.0~6.0		1 N/O 1 N/C	<b>XTOD006CC1S</b> 167960	1 piece
	Seperate mounting	5.5~8.5		1 N/O 1 N/C	<b>XTOD8P5CC1S</b> 167961	1 piece
	Seperate mounting	8.5~12.5		1 N/O 1 N/C	<b>XTOD013CC1S</b> 167962	1 piece
	Seperate mounting	12.5~18		1 N/O 1 N/C	<b>XTOD018CC1S</b> 167963	1 piece
	Seperate mounting	17~24		1 N/O 1 N/C	<b>XTOD024CC1S</b> 167964	1 piece
	Seperate mounting	22~30		1 N/O 1 N/C	<b>XTOD030CC1S</b> 167965	1 piece

#### XTOG...



Model	Mounting	Setting range $I_r$ (A)	Circuit symbol	Auxiliary contact	Part no. Article no.	Standard package
XTCG007	Direct mounting	0.1~0.16		1 N/O 1 N/C	<b>XTOGP16BC1</b> 173679	1 piece
XTCG009						
XTCG012	Direct mounting	0.16~0.24		1 N/O 1 N/C	<b>XTOGP24BC1</b> 173680	1 piece
XTCG018	Direct mounting	0.24~0.4		1 N/O 1 N/C	<b>XTOGP40BC1</b> 173681	1 piece
XTCG025						
XTCG032	Direct mounting	0.4~0.6		1 N/O 1 N/C	<b>XTOGP60BC1</b> 173682	1 piece
XTCG038	Direct mounting	0.6~1		1 N/O 1 N/C	<b>XTOG001BC1</b> 173683	1 piece
	Direct mounting	1~1.6		1 N/O 1 N/C	<b>XTOG1P6BC1</b> 173684	1 piece
	Direct mounting	1.6~2.4		1 N/O 1 N/C	<b>XTOG2P4BC1</b> 173685	1 piece
	Direct mounting	2.4~4		1 N/O 1 N/C	<b>XTOG004BC1</b> 173686	1 piece
	Direct mounting	4~6		1 N/O 1 N/C	<b>XTOG006BC1</b> 173687	1 piece
	Direct mounting	6~10		1 N/O 1 N/C	<b>XTOG010BC1</b> 173688	1 piece
	Direct mounting	9-12		1 N/O 1 N/C	<b>XTOG012BC1</b> 173689	1 piece
	Direct mounting	12~16		1 N/O 1 N/C	<b>XTOG016CC1</b> 173690	1 piece
	Direct mounting	16~24		1 N/O 1 N/C	<b>XTOG024CC1</b> 173691	1 piece
	Direct mounting	24~32		1 N/O 1 N/C	<b>XTOG032CC1</b> 173692	1 piece

## Thermal overload relays

For use with		Setting range of overload releases $I_r$ (A)	Circuit symbol	Auxiliary contact		Part no. Article no.	Standard package	
				N/O = Normally open N/C = Normally closed				
<b>XTOG...</b> 	XTCG040	Direct mounting	17~25		1 N/O	1 N/C	<b>XTOG025DC1</b> 173693	1 piece
	XTCG050	Direct mounting	23~32		1 N/O	1 N/C	<b>XTOG032DC1</b> 173694	1 piece
	XTCG065		30~40		1 N/O	1 N/C	<b>XTOG040DC1</b> 173695	1 piece
	XTCG080	Direct mounting	37~50		1 N/O	1 N/C	<b>XTOG050DC1</b> 173696	1 piece
	XTCG095		48~65		1 N/O	1 N/C	<b>XTOG065DC1</b> 173697	1 piece
		Direct mounting	37~50		1 N/O	1 N/C	<b>XTOG050EC1</b> 173698	1 piece
		Direct mounting	48~65		1 N/O	1 N/C	<b>XTOG065EC1</b> 173699	1 piece
		Direct mounting	63~80		1 N/O	1 N/C	<b>XTOG080EC1</b> 173700	1 piece
		Direct mounting	77~97		1 N/O	1 N/C	<b>XTOG097EC1</b> 173701	1 piece



# 2.2

## Thermal overload relays XTOD/XTOG

### Technical data

#### General

		XTOD/XTOG
Standards		IEC/EN 60947, GB 14048
Climatic Proofing		Damp heat, constant, to IEC60068-2-78 Damp heat, cyclic, to IEC60068-2-30

#### Ambient temperature

Open	°C	-25-55
Enclosed	°C	-25-40
Temperature compensation	°C	-5-40
Weight	kg	0.15
Protection type		IP20

#### Main contacts

		XTOD/XTOG
Rated impulse withstand voltage	$U_{imp}$	VAC 6000
Overvoltage category/pollution degree		III/3

#### Rated insulation voltage

AC	$U_i$	VAC 690
Rated operational voltage	$U_e$	VAC 690
Overload release setting range	A	0.1-97

#### Terminal capacity

Solid	mm <sup>2</sup>	1 x (1-6) 2 x (1-6)
Flexible with ferrule	mm <sup>2</sup>	1 x (1-6) 2 x (1-6)
Solid/stranded	AWG	
Terminal screw		M4
Tightening torque	Nm	1.2

#### Auxiliary and control circuits

		XTOD/XTOG
Rated impulse withstand voltage	$U_{imp}$	V 6000
Overvoltage category/pollution degree		III/3

#### Terminal capacity

Solid	mm <sup>2</sup>	1 x (1-6) 2 x (1-6)
Flexible with ferrule	mm <sup>2</sup>	1 x (1-6) 2 x (1-6)
Solid/stranded	AWG	
Terminal screw		M3.5
Tightening torque	Nm	0.8

Rated insulation voltage	$U_i$	VAC 690
Rated operational voltage	$U_e$	VAC 690
Conventional thermal current	$I_{th}$	A 10
Rated operational current		

#### AC-15

120V	$I_e$	A 6
220/240V	$I_e$	A 3
380V	$I_e$	A 1.9
480V	$I_e$	A 1.5
500V	$I_e$	A 1.4
600V	$I_e$	A 1.2

#### DC-13

125V	$I_e$	A 0.55
250V	$I_e$	A 0.27

Contactors

7-12A Frame

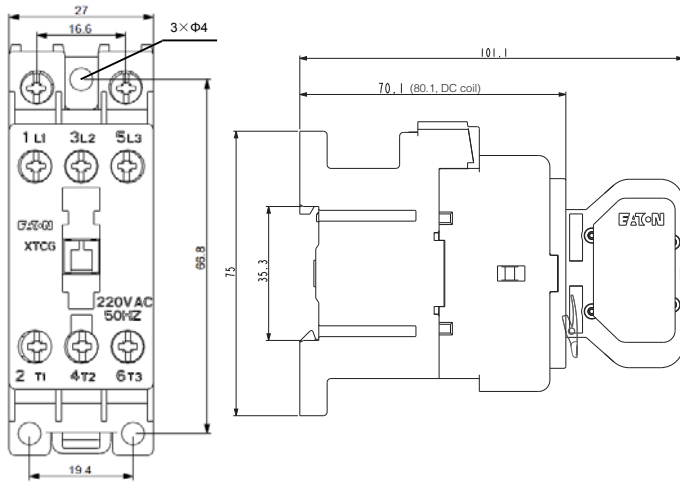

18-38A Frame

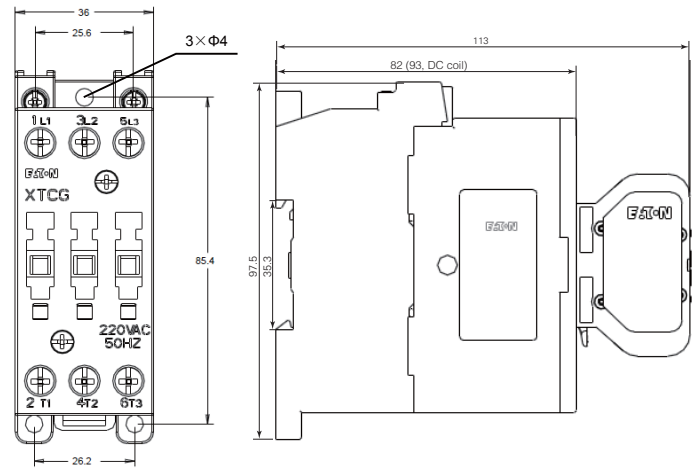

40-65A Frame

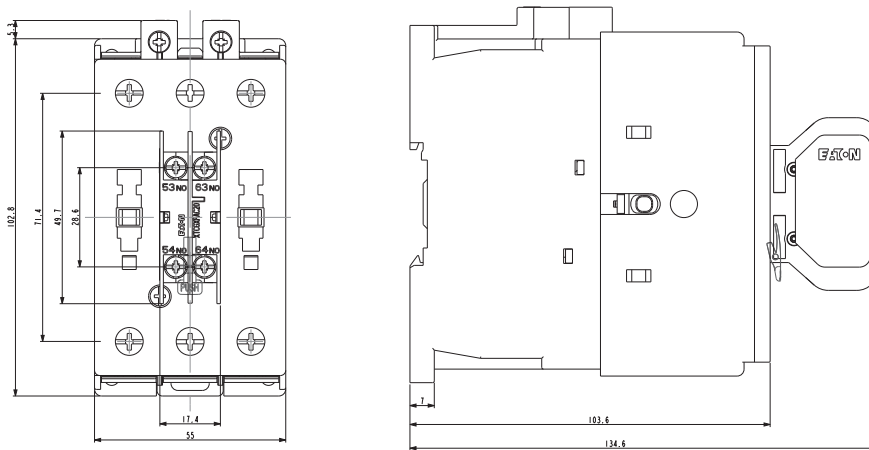

80-95A Frame

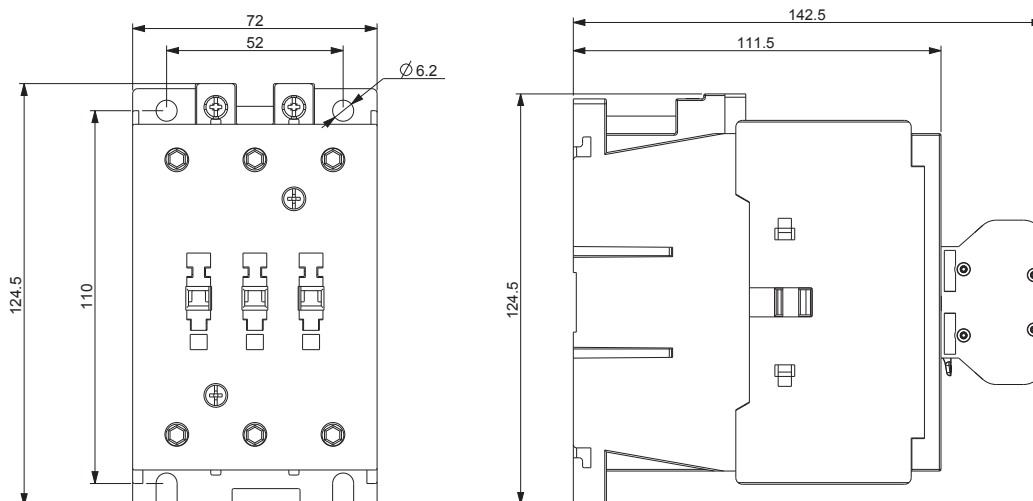

# 2.2

## Dimensions

Thermal overload relay XTOD/XTOG

### Thermal overload relay + mounting adapter

XTOD..CC1S

2

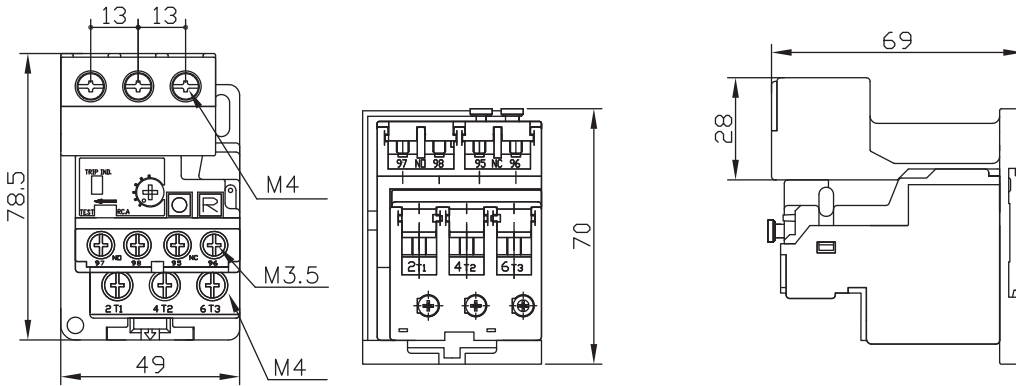

### Thermal overload relays XTOG

17-65A

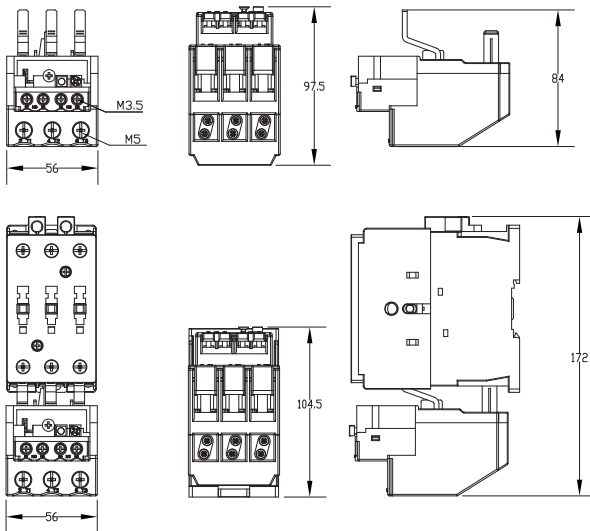

37-97A

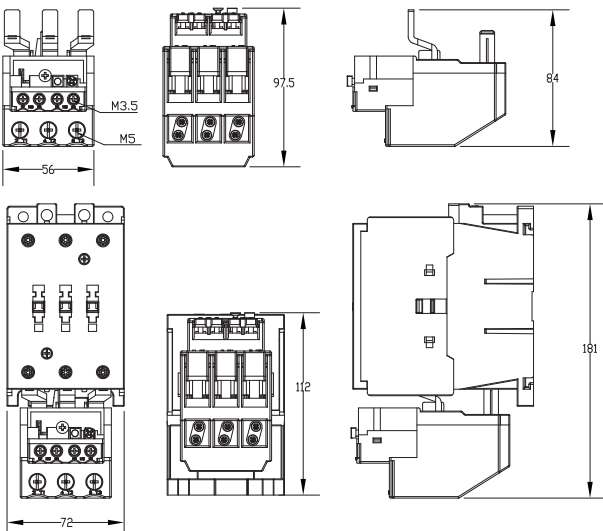

Auxiliary contact module

1 Pole

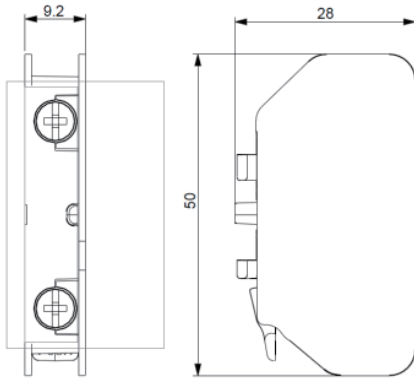

2 Pole

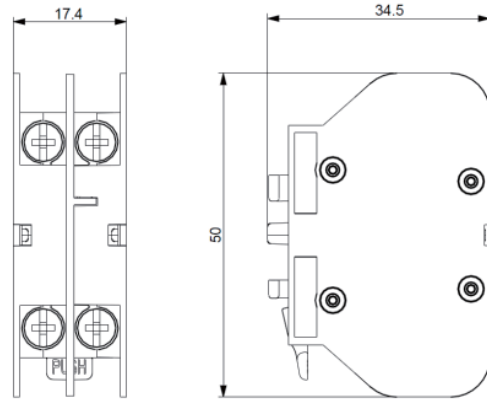

2

Side mounting contact module

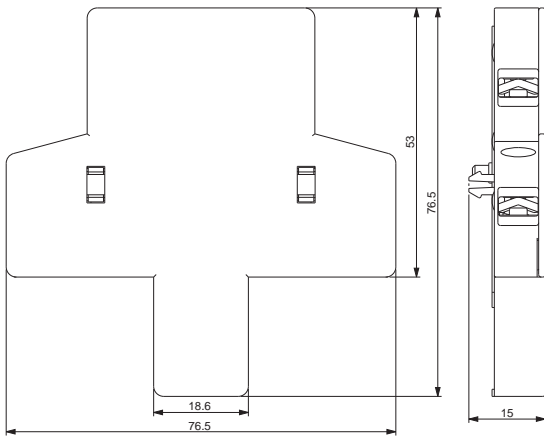

# 2.2

## Dimensions

Control relay XTRG / Surge suppressor

### Control Relay

2

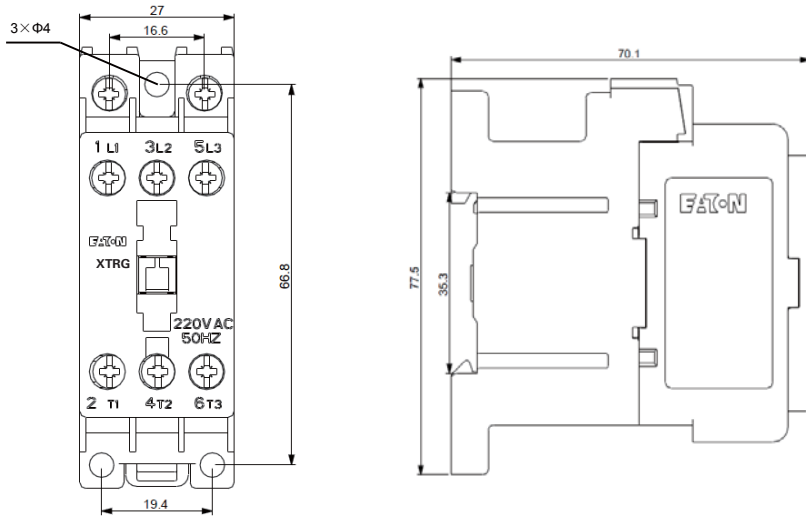

### Surge suppressor

#### 7-38A Surge suppressor

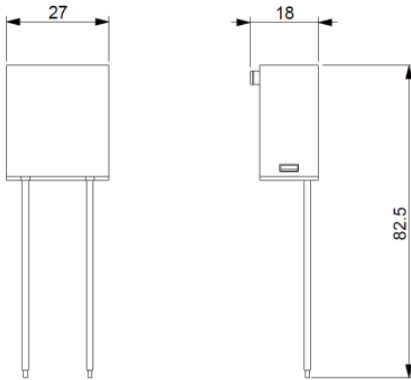

#### 40-95A Surge suppressor

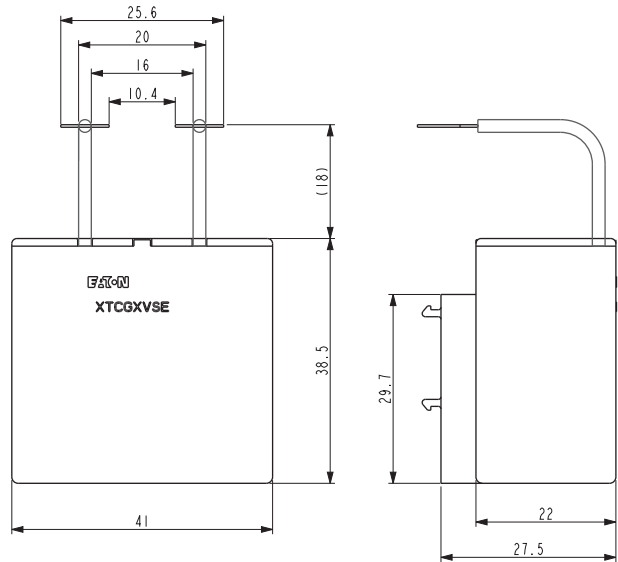

**Mechanical interlock**

**7-12A Frame**

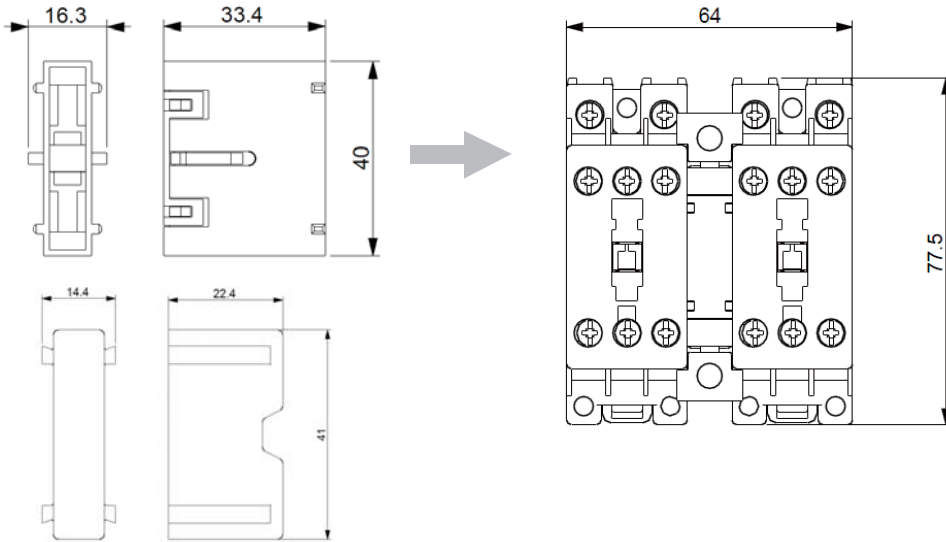

**18-38A Frame**

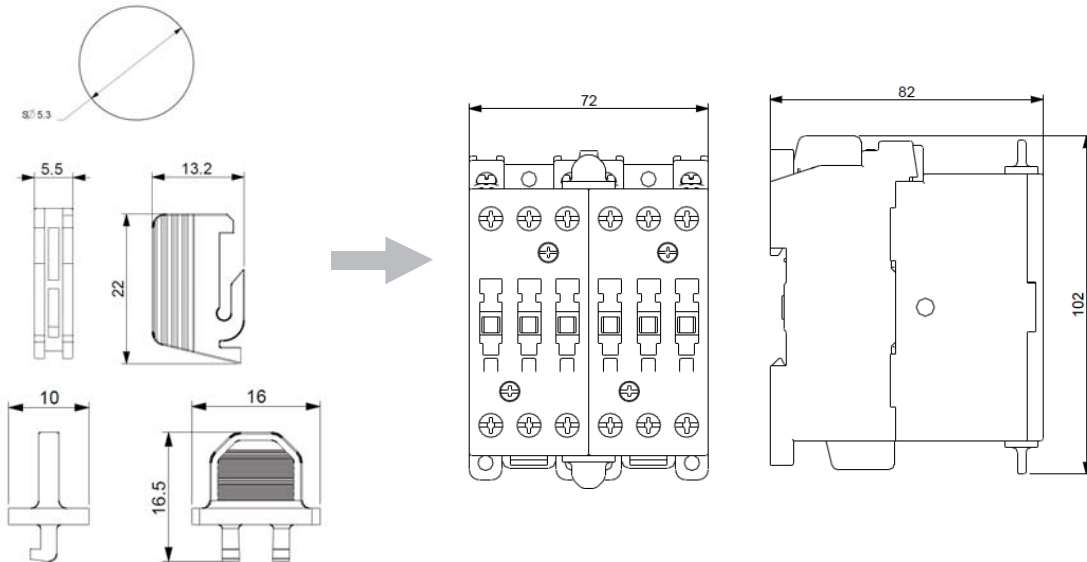

# 2.2

## Dimensions Mechanical interlock

### Mechanical interlock

#### 40-65A Frame

2

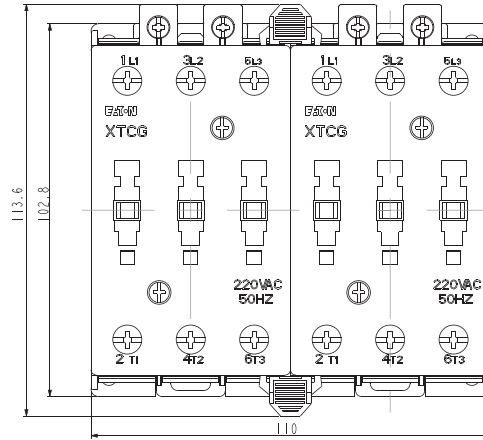
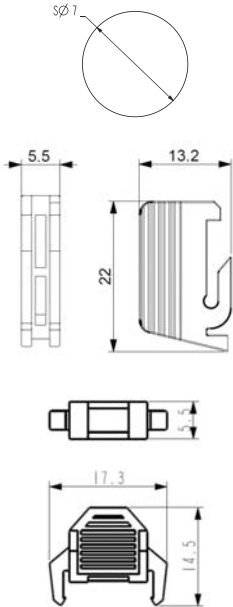

#### 80-95A Frame

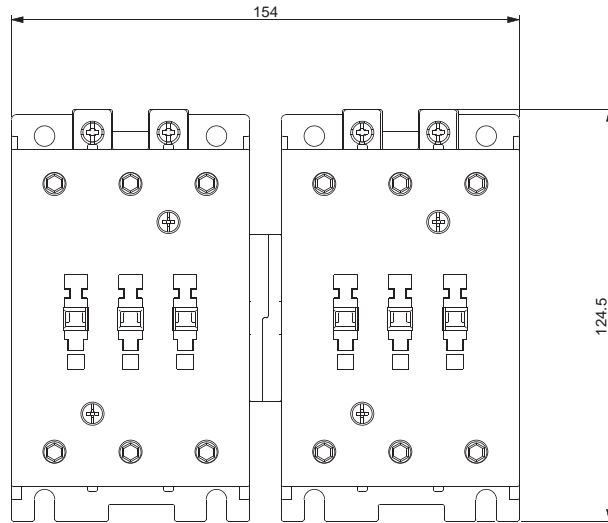
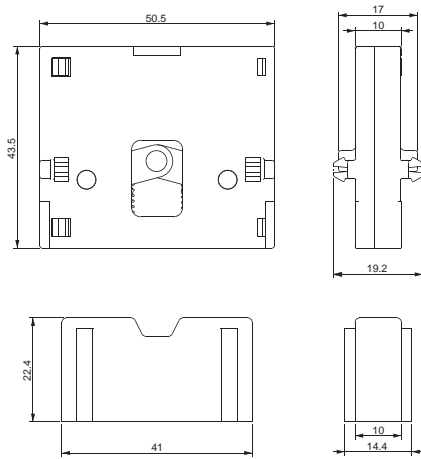

## **X-ON Electronics**

Largest Supplier of Electrical and Electronic Components

*Click to view similar products for [Industrial & Electrical Fuses](#) category:*

*Click to view products by [Eaton](#) manufacturer:*

Other Similar products are found below :

[MTH-4](#) [MTH-8](#) [BCC-1-8/10](#) [BP/FNM-5](#) [BP/NON-30](#) [KTN-R-10](#) [LPS-RK-2SP](#) [ABU-15](#) [ABU-25](#) [ABU-3](#) [ABU-35](#) [ABU-50](#) [ABU-60](#)  
[TCF40RN](#) [BCF-10](#) [3TX4431-0A](#) [BK-SC-20](#) [FNM-6-1-4](#) [FRN-R-6-1-4](#) [FRS-R-3-12](#) [KTK-1-1-2](#) [BBS-610](#) [FNM-6-10](#) [FNQ-R-1-1-4](#) [FRN-](#)  
[R-30ID](#) [FRS-R-20ID](#) [CL03AB00M6](#) [CHSF-80](#) [BBS-1/10](#) [LDFJ350.X](#) [2908361](#) [2908357](#) [2908367](#) [2908365](#) [2908366](#) [BAF-4](#) [KRP-C-](#)  
[1000SP](#) [TIA10](#) [MIC-20](#) [BBS-10](#) [BBS-4/10](#) [BBS-3/4](#) [BBS-1/2](#) [C10G32](#) [C10M20](#) [JJN-100](#) [JJN-15](#) [JJS-2](#) [KRP-C-700SP](#) [KTK-7](#)