

## xStart series contactors



## xStart series overload relays



## Motor protective circuit breaker PKZ



## Motor-starter combinations



## E Line contactors



## E Line thermal overload relay



## xStart series

|            |  |          |
|------------|--|----------|
| <b>1.1</b> | <b>xStart series contactors</b>                        | <b>1</b> |
|            | Mini contactor relays, contactor relay                 | 1        |
|            | Contactors DIL   | 1        |
| <b>1.2</b> | <b>xStart series overload relays</b>                   | <b>2</b> |
|            | Bimetal relay ZE, ZB, Z5                               | 2        |
|            | Overload relay ZW7                                     | 2        |
|            | Electronic overload relays ZEB                         | 4        |
|            | EMT6 thermistor overload relay for machine protection  | 4        |
|            | C441 overload and monitoring relay                     | 37       |
| <b>1.3</b> | <b>xStart series motor-protective circuit-breakers</b> | <b>3</b> |
|            | Motor-protective circuit-breakers PKZ                  | 3        |
|            | Motor-protective circuit-breakers PKE                  | 8        |
|            | DC string circuit-breaker PKZ-SOL                      | 47       |
|            | DC switch-disconnectors P-SOL, SOL                     | 47       |
| <b>1.4</b> | <b>Motor-starter combinations</b>                      | <b>1</b> |
|            | Motor-starter combinations                             | 1        |

## E Line series

|            |                                      |           |
|------------|--------------------------------------|-----------|
| <b>2.1</b> | <b>E Line contactors</b>             | <b>1</b>  |
|            | Control relays XTRG                  | 1         |
|            | Contactors XTCG                      | 6         |
| <b>2.2</b> | <b>E Line thermal overload relay</b> | <b>13</b> |
|            | Thermal overload relays XTOD/XTOG    | 13        |



# Mini contactor relays, contactor relay, contactors

Continual operation requires high operational reliability in the components used. The DILM contactor achieves the best lifespan values in AC-3 applications and is ideal for heavy AC-4 jogging.

## Mini contactor relay DILE..., contactor relays, contactors up to 12 A AC-3 at 400 V

- Compact dimensions for the highest packing densities
- Extended performance range up to 5.5 kW at 400 V

## AC and DC contactor system DILM..., contactor relays, 3 pole contactors up to 170 A AC-3 at 400 V, 4 pole contactors up to 200 A AC-1

- Easier engineering through identical construction sizes for AC- and DC-operated contactors
- Energy savings and higher packing density in control panel due to minimized heat dissipation
- High wiring security through doubled box terminals
- Less coupler relays: direct actuation from the PLC for contactors up to 32 A
- Easy engineering through integrated suppressor circuits for DC
- Uniform accessories for 3- and 4-pole contactors
- Mechanical interlock double conductor run mountable without additional separation gap
- Direct fieldbus connection through the communication system SmartWire-DT®, through plug-in type protective module

## High rated contactors - contactors up to 1600 A AC-3 at 400 V, contactors up to 2600 A AC-1

- Compact dimensions with high switching power
- Direct actuation from the PLC saves coupler relays
- Easy engineering through wide range coils
- Cost and energy savings for control panel ventilation due to reduced heat dissipation
- Long lifespan through vacuum technology from 580 A















### Eaton after sales service





Testing switching devices in compliance with regulations applicable to this technology  
→ See catalog



### SmartWire-DT®

The DIL product range offers contact elements which can be connected to the SmartWire-DT® communication system. → Protective modules, Page 62

|   |  |    |
|---|--|----|
|    | <b>Ordering</b>                            |    |
|   | Mini contactor relays DILER, DILEEM, DILEM |    |
|   | Mini contactor relays, contactors          | 2  |
|   | Auxiliary contact modules                  | 6  |
|   | Accessories                                | 8  |
|   | Actuating voltages                         | 66 |
|    | DILA contactor relays                      |    |
|   | Contactor relays                           | 10 |
|   | Auxiliary contact modules                  | 12 |
|   | Actuating voltages                         | 68 |
|    | <b>Technical overview</b>                  |    |
|   | Contactors DILM, DILH                      | 14 |
|    | <b>System overview</b>                     |    |
|   | Contactors DILM, DILH                      | 16 |
|   | <b>Ordering</b>                            |    |
|   | Contactors DILM, DILH                      |    |
|   | Basic devices up to 170 A                  | 18 |
|   | Complete units up to 170 A                 | 24 |
|   | Standard devices greater than 170 A        | 28 |
|   | Comfort devices greater than 170 A         | 30 |
|   | Basic devices up to 200 A, 4 pole          | 34 |
|   | Auxiliary contact modules                  | 36 |
|  | <b>Engineering</b>                         |    |
|   | Auxiliary contact modules                  | 40 |
|  | <b>Ordering</b>                            |    |
|   | DILK contactors for capacitors             | 41 |
|  | <b>Engineering</b>                         |    |
|   | Contactors for power factor correction     | 42 |
|  | <b>Ordering</b>                            |    |
|   | Star-delta combinations SDAINL             | 44 |
|  | <b>Engineering</b>                         |    |
|   | Star-delta combinations SDAINL             | 46 |
|  | <b>Ordering</b>                            |    |
|   | DIUL reversing combinations                | 48 |
|  | <b>Description</b>                         |    |
|   | CMD contactor monitoring device            | 64 |
|   | <b>Ordering</b>                            |    |
|   | CMD contactor monitoring device            | 64 |

|  |  |     |
|--|--|-----|
|   | <b>Ordering</b>                              |     |
|  | DILM contactor relays, DILM, DILH contactors |     |
|  | suppressor circuit                           | 50  |
|  | Accessories                                  | 52  |
|   | <b>Ordering</b>                              |     |
|  | Actuating voltages contactors DILM, DILH     |     |
|  | Basic devices up to 170 A                    | 69  |
|  | Basic devices up to 200 A, 4 pole            | 74  |
|  | Contactors up to 150 A                       |     |
|  | with electronic actuation                    | 76  |
|  | Replacement coils                            | 71  |
|  | Comfort devices greater than 170 A           | 77  |
|  | Standard devices greater than 170 A          | 77  |
|  | Electronic modules including coil            | 77  |
|  | Contactors for capacitors                    | 77  |
|   | <b>Engineering</b>                           |     |
|  | Contact travel diagrams                      | 78  |
|  | Enclosure                                    | 79  |
|  | UL/CSA-approved rating data                  | 80  |
|  | UL/CSA special purpose ratings               | 81  |
|  | UL/CSA short circuit current rating          | 82  |
|  | Contactors for resistive loads               | 84  |
|  | Electrical life span                         | 86  |
|  | Short-time loading                           | 90  |
|  | Operating frequency                          | 91  |
|  | Switching of DC current                      | 92  |
|   | <b>Technical data</b>                        |     |
|  | Mini contactor relays, contactor relays      | 93  |
|  | Contactor monitoring device                  | 96  |
|  | Basic devices up to 170 A                    | 104 |
|  | Basic devices up to 200 A, 4 pole            | 120 |
|  | Comfort devices greater than 170 A           | 112 |
|  | Standard devices greater than 170 A          | 112 |
|  | Contactors for capacitors                    | 123 |
|  | Contactors up to 150 A                       |     |
|  | with electronic actuation                    | 126 |
|  | Lighting contactors                          | 125 |
|  | Auxiliary contact modules                    | 128 |
|  | Accessories                                  | 128 |
|  | <b>Dimensions</b>                            |     |
|  | Mini contactor relays                        | 130 |
|  | Contactor relays                             | 131 |
|  | Basic devices up to 170 A                    | 131 |
|  | Basic devices up to 200 A, 4 pole            | 133 |
|  | Contactors larger than 170 A                 | 134 |
|  | Contactors for capacitors                    | 136 |
|  | Lighting contactors                          | 136 |
|  | Contactor combinations                       | 137 |
|  | Accessories                                  | 138 |

# 1.1

## Contactors

Mini contactors, relays

### 1 Ordering

#### Screw terminals

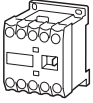

#### DILER mini contactor relays

| Rated operational current<br>AC-15 |       | Conventional free<br>air thermal current | Contact                     |                              | Distinctive<br>number | Circuit symbol | For use with |
|------------------------------------|-------|--|-----------------------------|------------------------------|-----------------------|----------------|--------------|
| 220 V                              | 380 V |  | N/O = normally open contact | NC = normally closed contact |                       |                |              |
| 230 V                              | 400 V |  |                             |                              |                       |                |              |
| 240 V                              | 415 V |  |                             |                              |                       |                |              |
| $I_e$                              | $I_e$ | $I_{th}$                                 |                             |                              |                       |                |              |
| A                                  | A     |  | A                           |                              |                       |                |              |
| 6                                  | 3     | 10                                       | 4 N/O                       | –                            | 40E                   |                | DILE...      |
|                                    |       |  | 3 N/O                       | 1 NC                         | 31E                   |                | DILE...      |
|                                    |       |  | 2 N/O                       | 2 NC                         | 22E                   |                | DILE...      |

#### Notes

- Coil terminal marking as specified in EN 50005
- Contact numbers to EN 50011
- The following applies to DC-operated contactors:
  - Integrated diode-resistor combination
  - Coil rating 2.6 W

#### Information relevant for export to North America



|                   |  |
|-------------------|--|
| Product Standards | IEC/EN 60947-4-1; UL508; CSA-C22.2 No.14-05; |
| UL File No.       | E29184                                       |
| UL CCN            | NKCR   |
| CSA File No.      | 012528                                       |
| CSA Class No.     | 3211-03                                      |
| NA Certification  | UL Listed,<br>CSA certified                  |

| AC operation |                | DC operation |                | Std. pack | Notes |
|--------------|----------------|--------------|----------------|-----------|-------|
| Part no.     | Price          | Part no.     | Price          |           |       |
| Article no.  | See price list | Article no.  | See price list |           |       |

|                                     |                                    |       |   |
|-------------------------------------|------------------------------------|-------|---|
| <b>DILER-40(230V50Hz)</b><br>051759 | <b>DILER-40-G(24VDC)</b><br>010223 | 5 off |  |
| <b>DILER-31(230V50Hz)</b><br>051768 | <b>DILER-31-G(24VDC)</b><br>010157 |       |   |
| <b>DILER-22(230V50Hz)</b><br>051777 | <b>DILER-22-G(24VDC)</b><br>010042 |       |   |

With screw terminals:

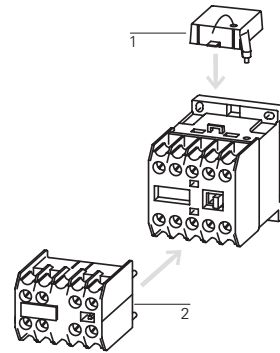

**Accessories**

- 1 Suppressor
- 2 Auxiliary contact modules
- Further actuating voltages

**Page**

- 8
- 6
- 66

# 1.1

## Contactors

Mini contactors, relays

1

### DILEM contactors

| Rated operational current | Max. motor rating for three-phase motors, 50 - 60 Hz |                                   |                     |                     |                                   |                     | Conventional thermal current $I_{th} = I_e$<br>AC-1 at 50 °C |                | Contact   |      | Circuit symbol | For use with        |
|---------------------------|--|-----------------------------------|---------------------|---------------------|-----------------------------------|---------------------|--|----------------|---|------|----------------|---------------------|
|                           | AC-3   |                                   |                     | AC-4                |                                   |                     | Open   | Enclosed       | N/O = normally open contact<br>NC = normally closed contact |      |                |                     |
| 380 V<br>400 V<br>$I_e$   | 220 V<br>230 V<br>P                                  | <b>380 V</b><br><b>400 V</b><br>P | 660 V<br>690 V<br>P | 220 V<br>230 V<br>P | <b>380 V</b><br><b>400 V</b><br>P | 660 V<br>690 V<br>P | $I_{th} = I_e$   | $I_{th} = I_e$ |   |      |                |                     |
| <b>A</b>                  | kW   | <b>kW</b>                         | kW                  | kW                  | <b>kW</b>                         | kW                  | A  | A              |   |      |                |                     |
| <b>6.6</b>                | 1.5  | <b>3</b>                          | 3                   | 1.1                 | <b>2.2</b>                        | 2.2                 | 20   | 16             | 1 N/O   | –    |                | ...DILEM<br>DILE... |
| <b>6.6</b>                | 1.5  | <b>3</b>                          | 3                   | 1.1                 | <b>2.2</b>                        | 2.2                 | 20   | 16             | –   | 1 NC |                | DILE...             |
| <b>9</b>                  | 2.2  | <b>4</b>                          | 4                   | 1.5                 | <b>3</b>                          | 3                   | 20   | 16             | 1 N/O   | –    |                | ...DILEM<br>DILE... |
| <b>9</b>                  | 2.2  | <b>4</b>                          | 4                   | 1.5                 | <b>3</b>                          | 3                   | 20   | 16             | –   | 1 NC |                | DILE...             |
| <b>12</b>                 | 3.5  | <b>5.5</b>                        | 6.5                 | 2                   | <b>3</b>                          | 2.2                 | 20   | 16             | 1 N/O   | –    |                | ...DILEM<br>DILE... |
| <b>12</b>                 | 3.5  | <b>5.5</b>                        | 6.5                 | 2                   | <b>3</b>                          | 2.2                 | 20   | 16             | –   | 1 NC |                | DILE...             |
| <b>9</b>                  | 2.2  | <b>4</b>                          | 4                   | 1.5                 | <b>3</b>                          | 3                   | 20   | 16             | –   | –    |                | ...DILEM<br>DILE... |

3 pole with auxiliary contact  
Screw terminals

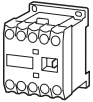

4 pole  
Screw terminals

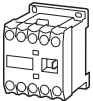

1)

#### Information relevant for export to North America



Product Standards IEC/EN 60947-4-1;  
UL 508; CSA-C22.2  
No.14-05; CE marking  
UL File No. E29096  
UL CC NLDX  
CSA File No. 012528  
CSA Class No. 3211-04  
NA Certification UL Listed, CSA certified  
See also → Page 80



2)

#### Information relevant for export to North America



Product Standards IEC/EN 60947-4-1;  
UL 508; CSA-C22.2 No.14-05; CE marking  
UL File No. E29096  
UL CCN NLDX  
CSA File No. 012528  
CSA Class No. 2411-03,3211-04  
NA Certification UL Listed, request filed for CSA

| AC operation            |                         | DC operation            |                         | Std. pack | Notes |
|-------------------------|-------------------------|-------------------------|-------------------------|-----------|-------|
| Part no.<br>Article no. | Price<br>See price list | Part no.<br>Article no. | Price<br>See price list |           |       |

|   |  |       |   |
|---|--|-------|---|
| <b>DILEEM-10(230V50Hz)</b> <sup>1)</sup><br>051608  | <b>DILEEM-10-G(24VDC)</b> <sup>1)</sup><br>051643  | 5 off |    |
| <b>DILEEM-01(230V50Hz)</b> <sup>1)</sup><br>051633  | <b>DILEEM-01-G(24VDC)</b> <sup>1)</sup><br>051650  |       |   |
| <b>DILEM-10(230V50Hz)</b> <sup>1)</sup><br>051786   | <b>DILEM-10-G(24VDC)</b> <sup>1)</sup><br>010213   |       |   |
| <b>DILEM-01(230V50Hz)</b> <sup>1)</sup><br>051795   | <b>DILEM-01-G(24VDC)</b> <sup>1)</sup><br>010343   |       |   |
| <b>DILEM12-10(230V50Hz)</b> <sup>2)</sup><br>127075 | <b>DILEM12-10-G(24VDC)</b> <sup>2)</sup><br>127132 |       |   |
| <b>DILEM12-01(230V50Hz)</b> <sup>2)</sup><br>127091 | <b>DILEM12-01-G(24VDC)</b> <sup>2)</sup><br>127137 |       |   |
| <b>DILEM4(230V50Hz)</b> <sup>1)</sup><br>051804     | <b>DILEM4-G(24VDC)</b> <sup>1)</sup><br>012701     | 5 off |  |

**With screw terminals:**

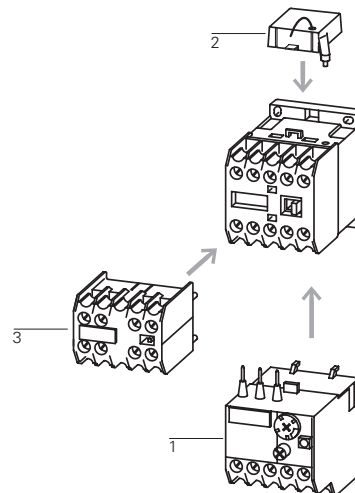

**Accessories**

- 1 Overload relay
- 2 Suppressor
- 3 Auxiliary contact module
- Enclosures totally insulated
- Further actuating voltages
- Accessories

**Page**

- Chapter 1.2
- 8
- 6
- 66
- 8

# 1.1

## Mini contactor relays

### Auxiliary contact modules

1

Screw terminals



### DILE Auxiliary contact modules











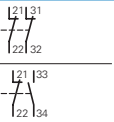







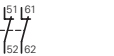

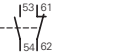





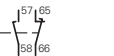

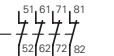

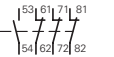

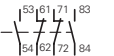
|        | Contact                     |                                |                              |                                | Rated operational current        |                         | Conventional thermal current<br>$I_{th}$<br>A | Distinctive number/type of combinations with basic device |              |          |
|--------|-----------------------------|--------------------------------|------------------------------|--------------------------------|----------------------------------|-------------------------|---|---|--------------|----------|
|        | N/O = normally open contact | S <sub>F</sub> = NO early-make | NC = normally closed contact | Ö <sub>S</sub> = NC late-break | AC-15<br>220 V<br>230 V<br>240 V | 380 V<br>400 V<br>415 V |   | DILER-40(-G)  | DILER-31(-G) | DILER-22 |
| 2 pole | –                           | –                              | 2 NC                         | –                              | 4                                | 2                       | 10  | –   | –            | –        |
|        | 1 N/O                       | –                              | 1 NC                         | –                              | 4                                | 2                       | 10  | –   | –            | –        |
| 4 pole | 2 N/O                       | –                              | 2 NC                         | –                              | 4                                | 2                       | 10  | –   | –            | –        |
| 2 pole | –                           | –                              | 2 NC                         | –                              | 4                                | 2                       | 10  | 42E   | 33           | 24       |
|        | 1 N/O                       | –                              | 1 NC                         | –                              | 4                                | 2                       | 10  | 51E   | 42           | 33       |
|        | 2 N/O                       | –                              | –                            | –                              | 4                                | 2                       | 10  | 60E   | 51           | 42       |
|        | –                           | 1 S <sub>F</sub>               | –                            | 1 Ö <sub>S</sub>               | 4                                | 2                       | 10  | 51  | 42           | 33       |
| 4 pole | –                           | –                              | 4 NC                         | –                              | 4                                | 2                       | 10  | 44E   | 35           | 26       |
|        | 1 N/O                       | –                              | 3 NC                         | –                              | 4                                | 2                       | 10  | 53E   | 44           | 35       |
|        | 2 N/O                       | –                              | 2 NC                         | –                              | 4                                | 2                       | 10  | 62E   | 53           | 44       |
|        | 3 N/O                       | –                              | 1 NC                         | –                              | 4                                | 2                       | 10  | 71E   | 62           | 53       |
|        | 4 N/O                       | –                              | –                            | –                              | 4                                | 2                       | 10  | 80E   | 71           | 62       |
|        | 1 N/O                       | 1 S <sub>F</sub>               | 1 NC                         | 1 Ö <sub>S</sub>               | 4                                | 2                       | 10  | 62  | 53           | 44       |

#### Information relevant for export to North America



|                   |   |
|-------------------|---|
| Product Standards | IEC/EN 60947-4-1; UL 508; CSA-C22.2 No.14-05;<br>CE marking |
| UL File No.       | E29184  |
| UL CCN            | NKCR  |
| CSA File No.      | 012528  |
| CSA Class No.     | 3211-03   |
| NA Certification  | UL Listed,<br>CSA certified                                 |

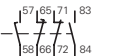

| Circuit symbol  | Can be combined with contactor | Part no.<br>Article no.  | Price<br>See price list | Std. pack   | Notes                              |   |
|---|--------------------------------|--------------------------|-------------------------|---|------------------------------------|---|
|    |                                | <b>02DILEM</b><br>010064 | 5 off                   |       | With interlocked opposing contacts | <p>The following applies to ...DILEM auxiliary contacts:</p> <ul style="list-style-type: none"> <li>• Contacts to EN 50012</li> </ul> <p>The following applies to ...DILE auxiliary contacts:</p> <ul style="list-style-type: none"> <li>• Contacts to EN 50005</li> </ul> <p>Contacts according to EN50012 are to be preferred. Type E combinations comply with EN 50011 and are to be given preference.</p> <p>No interlocked opposing contacts in NO early-makes and NC late-breaks.</p> |
|    |                                | <b>11DILEM</b><br>010080 | 5 off                   |       | With interlocked opposing contacts |   |
|    |                                | <b>22DILEM</b><br>010112 | 5 off                   |       | With interlocked opposing contacts |   |
|    |                                | <b>02DILE</b><br>010240  | 5 off                   |       | With interlocked opposing contacts |   |
|    |                                | <b>11DILE</b><br>010224  | 5 off                   |       | With interlocked opposing contacts |   |
|    |                                | <b>20DILE</b><br>010208  | 5 off                   |       | With interlocked opposing contacts |   |
|   |                                | <b>11DDILE</b><br>049824 | 5 off                   |     | –                                  |   |
|  |                                | <b>04DILE</b><br>010256  | 5 off                   |   | With interlocked opposing contacts |   |
|  |                                | <b>13DILE</b><br>002397  | 5 off                   |   | With interlocked opposing contacts |   |
|  |                                | <b>22DILE</b><br>010288  | 5 off                   |   | With interlocked opposing contacts |   |
|  |                                | <b>31DILE</b><br>048912  | 5 off                   |   | With interlocked opposing contacts |   |
|  |                                | <b>40DILE</b><br>010304  | 5 off                   |   | With interlocked opposing contacts |   |
|  |                                | <b>22DDILE</b><br>049823 | 5 off                   |   | –                                  |   |

# 1.1

## Mini contactor relays Accessories

### 1 VGDILE..., RCDILE..., MVDILE, BT480, P1DILEM

| Actuating voltage<br>$U_s$<br>V AC | Circuit symbol | For use with | Part no.<br>Article no. | Price<br>See price list | Std. pack | Information relevant for export to North America<br> |
|------------------------------------|----------------|--------------|-------------------------|-------------------------|-----------|--|
|------------------------------------|----------------|--------------|-------------------------|-------------------------|-----------|--|

#### Suppressor circuits

Varistor suppressor

|  |              |  |                            |                           |            |  |
|--|--------------|--|----------------------------|---------------------------|------------|--|
|  | 24 - 48 AC   |  | DILE...                    | <b>VGDILE48</b><br>010320 | 10 off<br> | Product Standards<br>IEC/EN 60947-4-1; UL 508;<br>CSA-C22.2 No.14-05;<br>CE marking<br>E29096<br>UL File No.<br>UL CCN<br>CSA File No.<br>CSA Class No.<br>NA Certification<br>NLDX<br>012528<br>3211-03<br>UL Listed, CSA certified |
|  | 110 - 250 AC |  | <b>VGDILE250</b><br>010336 | 10 off<br>                |            |  |
|  | 380 - 415 AC |  | <b>VGDILE415</b><br>010463 | 10 off<br>                |            |  |

RC-Suppressor

|  |              |  |                            |                           |            |   |
|--|--------------|--|----------------------------|---------------------------|------------|---|
|  | 24 - 48 AC   |  | DILE...                    | <b>RCDILE48</b><br>044264 | 10 off<br> | Product Standards<br>IEC/EN 60947-4-1; UL 508;<br>CSA-C22.2 No.14-05;<br>CE marking<br>E29184<br>UL File No.<br>UL CCN<br>CSA File No.<br>NA Certification<br>NKCR2<br>-<br>UL Recognized |
|  | 110 - 250 AC |  | <b>RCDILE250</b><br>046320 | 10 off<br>                |            |   |

**Notes**  
For AC operated contactors 50 - 60 Hz.  
DC operated contactor relays have an integrated suppressor.  
Note drop-out delay.

### VGDILE..., RCDILE..., MVDILE, BT480, P1DILEM

| For use with | Part no.<br>Article no. | Price<br>See price list | Std. pack | Information relevant for export to North America<br> |
|--------------|-------------------------|-------------------------|-----------|--|
|--------------|-------------------------|-------------------------|-----------|--|

#### Mechanical interlocks

For mechanical connection of contactor and timing relays in combinations.  
0 mm distance between contactors.

|  |                     |                         |            |                                   |
|--|---------------------|-------------------------|------------|-----------------------------------|
|  | DILE...<br>DILET... | <b>VODILE</b><br>026634 | 50 off<br> | UL/CSA certification not required |
|--|---------------------|-------------------------|------------|-----------------------------------|

#### Mechanical interlock

For contactors with the same or different magnet system.  
0 mm distance between contactors.  
Mechanical lifespan  $2.5 \times 10^6$  operations.  
Additional auxiliary contact modules possible.

|  |         |                         |           |   |
|--|---------|-------------------------|-----------|---|
|  | DILE... | <b>MVDILE</b><br>010113 | 5 off<br> | Product Standards<br>IEC/EN 60947-4-1; UL 508;<br>CSA-C22.2 No.14-05;<br>CE marking<br>E29184<br>UL File No.<br>UL CCN<br>CSA File No.<br>CSA Class No.<br>NA Certification<br>NKCR2<br>012528<br>3211-07<br>UL Recognized, CSA certified |
|--|---------|-------------------------|-----------|---|

#### Paralleling link

For parallel connection of contacts

|  |                    |                                      |  |  |
|--|--------------------|--------------------------------------|--|--|
|  | DILE...<br>DILE... | <b>BT480</b> <sup>1)</sup><br>052785 | 100 off                                | Product Standards<br>IEC/EN 60947-4-1; UL 508;<br>CSA-C22.2 No.14-05;<br>CE marking<br>E29096<br>UL File No.<br>UL CCN<br>CSA File No.<br>CSA Class No.<br>NA Certification<br>NLDX<br>012528<br>3211-07<br>UL Listed, CSA certified |
| Consisting of two four-pole paralleling links. |                    | DILEEM<br>DILEM12<br>DILEM           | <b>P1DILEM</b> <sup>2)</sup><br>019095 | 5 off<br>  |

**Notes**  
1) Not protected against accidental contact as specified in VDE 0106 Part 100.  
2) 4th pole can be broken off  
4 pole:  $I_{th} = 60$  A open  
3 pole:  $I_{th} = 50$  A open  
AC-1 current carrying capacity of the open contactor increases by a factor of 2.5  
Protected against accidental contact in accordance with VDE 0106 Part 100

## HDILE, ...DILEM, MVS

| Contact sequence | For use with | Part no.<br>Article no. | Price<br>See price list | Std. pack | Information relevant for export to North America |
|------------------|--------------|-------------------------|-------------------------|-----------|--|
|------------------|--------------|-------------------------|-------------------------|-----------|--|



### Sealable shrouds

Transparent  
Snap-fitting on contactor.  
Can be used with open installation or on service distribution board.  
Protection type: IP40 front  
Can be drilled to accommodate timing relay setting dials.

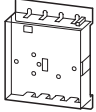

|                     |                        |           |                                   |
|---------------------|------------------------|-----------|-----------------------------------|
| DILE...<br>DILET... | <b>HDILE</b><br>010482 | 1 off<br> | UL/CSA certification not required |
|---------------------|------------------------|-----------|-----------------------------------|

### Start-point bridge



|                            |                                       |        |
|----------------------------|---------------------------------------|--------|
| DILEEM<br>DILEM12<br>DILEM | <b>S1DILEM<sup>1)</sup></b><br>220218 | 20 off |
|----------------------------|---------------------------------------|--------|

### Reversing starter wiring kit

Main current wiring for reversing combinations

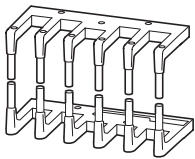

|   |   |           |   |
|---|---|-----------|---|
| DILEEM (+MVDILEM)<br>DILEM12 (+MVDILEM)<br>DILEM (+MVDILEM) | <b>MVS-WB-EM<sup>2)</sup></b><br>220209 | 1 off<br> | <b>Product Standards</b> IEC/EN 60947-4-1; UL 508;<br>CSA-C22.2 No.14-05;<br>CE marking<br><b>UL File No.</b> E36332<br><b>UL CCN</b> NLRV7<br><b>CSA File No.</b> 012528<br><b>CSA Class No.</b> 3211-06<br><b>NA Certification</b> UL Listed, CSA certified |
|---|---|-----------|---|

### Star-delta wiring kit

Main current wiring for star-delta combination incl. star-point bridge

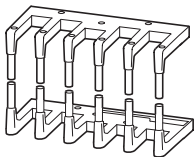

|   |   |           |   |
|---|---|-----------|---|
| DILE(E)M (+MVDILEM)<br>DILE(E)M12 (+MVDILEM)<br>DILE(E)M star contactor | <b>MVS-SB-EM<sup>3)</sup></b><br>220213 | 1 off<br> | <b>Product Standards</b> IEC/EN 60947-4-1; UL 508;<br>CSA-C22.2 No.14-05;<br>CE marking<br><b>UL File No.</b> E36332<br><b>UL CCN</b> NLRV7<br><b>CSA File No.</b> 012528<br><b>CSA Class No.</b> 3211-06<br><b>NA Certification</b> UL Listed, CSA certified |
|---|---|-----------|---|

### Notes

- <sup>1)</sup> Protected against accidental contact in accordance with VDE 0106 Part 100
- <sup>2)</sup> The following control cables are integrated in addition to electrical interlock:
  - Q11: A1 - Q12: 21
  - Q11: 21 - Q12: A1
  - Q11: A2 - Q12: A2
 For use with overload relay separate mounting.
- <sup>3)</sup> The following control cables are integrated in addition to electrical interlock:
  - Q13: A1 - Q15: 21
  - Q13: 21 - Q15: A1
  - Q13: A2 - Q15: A2
 For use with overload relay separate mounting.

# 1.1

## Contactor relays

### Basic devices

1

#### DILA Basic devices with positively driven contacts

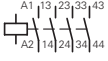
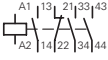
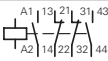
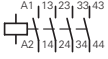
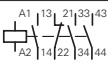
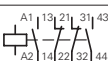
| Contact                        |                              | Rated operational current |       | Conventional thermal current | Distinctive number | Can be combined with auxiliary contact | Circuit symbol  |
|--------------------------------|------------------------------|---------------------------|-------|------------------------------|--------------------|--|---|
| N/O = normally open contact    | NC = normally closed contact | AC-15                     |       | $I_{th}$                     |                    |  |   |
|                                |                              | 220 V                     | 380 V | A                            |                    |  |   |
|                                |                              | 230 V                     | 400 V |                              |                    |  |   |
|                                |                              | 240 V                     | 415 V |                              |                    |  |   |
|                                |                              | $I_e$                     | $I_e$ |                              |                    |  |   |
|                                |                              | A                         | A     |                              |                    |  |   |
| <b>Screw terminals</b>         |                              |                           |       |                              |                    |  |   |
| 4 N/O                          | –                            | 4                         | 4     | 16                           | 40E                | DILA-XHI(V)...                         |    |
| 3 N/O                          | 1 NC                         | 4                         | 4     | 16                           | 31E                | DILA-XHI(V)...                         |    |
| 2 N/O                          | 2 NC                         | 4                         | 4     | 16                           | 22E                | DILA-XHI(V)...                         |    |
| <b>Spring-loaded terminals</b> |                              |                           |       |                              |                    |  |   |
| 4 N/O                          | –                            | 4                         | 4     | 16                           | 40E                | DILA-XHIC(V)...                        |  |
| 3 N/O                          | 1 NC                         | 4                         | 4     | 16                           | 31E                | DILA-XHIC(V)...                        |  |
| 2 N/O                          | 2 NC                         | 4                         | 4     | 16                           | 22E                | DILA-XHIC(V)...                        |  |

#### Screw terminals

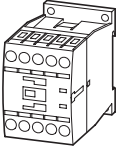

#### Spring-loaded terminals

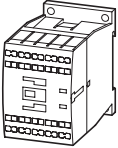

#### Notes

Contact numbers to EN 50011  
Coil terminal markings to EN 50005  
The following applies to DC-operated contactors:

- Integrated suppressor circuit

#### Information relevant for export to North America



|                   |  |
|-------------------|--|
| Product Standards | IEC/EN 60947-4-1; UL 508; CSA-C22.2 No.14-05; CE marking |
| UL File No.       | E29184   |
| UL CCN            | NKCR   |
| CSA File No.      | 012528   |
| CSA Class No.     | 3211-03  |
| NA Certification  | UL Listed, CSA certified                                 |

**AC operation**

**Part no.**  
Article no.

**Price**  
See price list

Std. pack

Circuit symbol

**DC operation**

**Part no.**  
Article no.

**Price**  
See price list

Std. pack

**Notes**

|                                    |           |  |                                 |           |
|------------------------------------|-----------|--|---------------------------------|-----------|
| <b>DILA-40(230V50Hz)</b><br>276329 | 1 off<br> |  | <b>DILA-40(24VDC)</b><br>276344 | 1 off<br> |
| <b>DILA-31(230V50Hz)</b><br>276364 | 1 off<br> |  | <b>DILA-31(24VDC)</b><br>276379 |           |
| <b>DILA-22(230V50Hz)</b><br>276399 | 1 off<br> |  | <b>DILA-22(24VDC)</b><br>276414 |           |

**With screw terminals:**

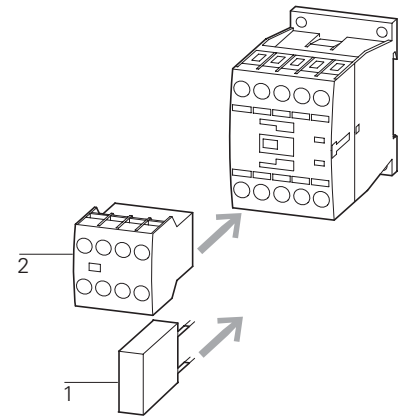

**Accessories**

- 1 Suppressor
- 2 Auxiliary contact modules
- Further actuating voltages

**Page**

- 50
- 36
- 68

|                                     |           |  |                                  |           |
|-------------------------------------|-----------|--|----------------------------------|-----------|
| <b>DILAC-40(230V50Hz)</b><br>276441 | 1 off<br> |  | <b>DILAC-40(24VDC)</b><br>276456 | 1 off<br> |
| <b>DILAC-31(230V50Hz)</b><br>276473 | 1 off<br> |  | <b>DILAC-31(24VDC)</b><br>276488 |           |
| <b>DILAC-22(230V50Hz)</b><br>276505 | 1 off<br> |  | <b>DILAC-22(24VDC)</b><br>276520 |           |

**With spring-loaded terminals:**

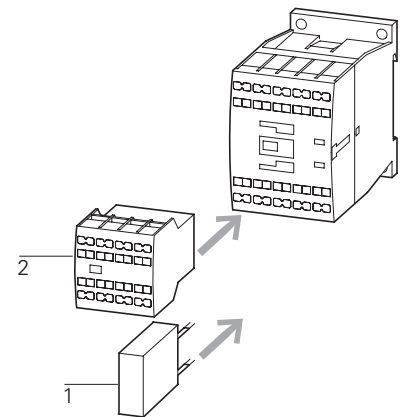

**Accessories**

- 1 Suppressor
- 2 Auxiliary contact modules
- Further actuating voltages

**Page**

- 50
- 36
- 68

# 1.1

## Contactor relays Auxiliary contact modules

1

### DILA...XHI... DILA auxiliary contact modules

| Contact   | Rated operational current  | Conventional thermal current | Circuit symbol |
|---|--|------------------------------|----------------|
| N/O = normally open contact<br>S <sub>F</sub> = NO early-make<br>NC = normally closed contact<br>Ö <sub>S</sub> = NC late-break | AC-15<br>220 V      380 V<br>230 V      400 V<br>240 V      415 V<br>I <sub>e</sub> I <sub>e</sub><br>A              A | I <sub>th</sub><br>A         |                |

#### Screw terminals



|        |       |                  |      |                  |   |   |    |  |
|--------|-------|------------------|------|------------------|---|---|----|--|
| 2 pole | –     | –                | 2 NC | –                | 4 | 4 | 16 |  |
|        | 1 N/O | –                | 1 NC | –                | 4 | 4 | 16 |  |
|        | 2 N/O | –                | –    | –                | 4 | 4 | 16 |  |
|        | –     | 1 S <sub>F</sub> | –    | 1 Ö <sub>S</sub> | 4 | 4 | 16 |  |

#### Screw terminals



|        |       |                  |      |                  |   |   |    |  |
|--------|-------|------------------|------|------------------|---|---|----|--|
| 4 pole | –     | –                | 4 NC | –                | 4 | 4 | 16 |  |
|        | 1 N/O | –                | 3 NC | –                | 4 | 4 | 16 |  |
|        | 2 N/O | –                | 2 NC | –                | 4 | 4 | 16 |  |
|        | 3 N/O | –                | 1 NC | –                | 4 | 4 | 16 |  |
|        | 4 N/O | –                | –    | –                | 4 | 4 | 16 |  |
|        | 1 N/O | 1 S <sub>F</sub> | 1 NC | 1 Ö <sub>S</sub> | 4 | 4 | 16 |  |

#### Spring-loaded terminals



|        |       |                  |      |                  |   |   |    |  |
|--------|-------|------------------|------|------------------|---|---|----|--|
| 2 pole | –     | –                | 2 NC | –                | 4 | 4 | 16 |  |
|        | 1 N/O | –                | 1 NC | –                | 4 | 4 | 16 |  |
|        | 2 N/O | –                | –    | –                | 4 | 4 | 16 |  |
|        | –     | 1 S <sub>F</sub> | –    | 1 Ö <sub>S</sub> | 4 | 4 | 16 |  |

#### Spring-loaded terminals









































|        |       |                  |      |                  |   |   |    |  |
|--------|-------|------------------|------|------------------|---|---|----|--|
| 4 pole | –     | –                | 4 NC | –                | 4 | 4 | 16 |  |
|        | 1 N/O | –                | 3 NC | –                | 4 | 4 | 16 |  |
|        | 2 N/O | –                | 2 NC | –                | 4 | 4 | 16 |  |
|        | 3 N/O | –                | 1 NC | –                | 4 | 4 | 16 |  |
|        | 4 N/O | –                | –    | –                | 4 | 4 | 16 |  |
|        | 1 N/O | 1 S <sub>F</sub> | 1 NC | 1 Ö <sub>S</sub> | 4 | 4 | 16 |  |

#### Information relevant for export to North America



|                   |  |
|-------------------|--|
| Product Standards | IEC/EN 60947-4-1; UL 508; CSA-C22.2 No.14-05; CE marking |
| UL File No.       | E29184   |
| UL CCN            | NKCR   |
| CSA File No.      | 012528   |
| CSA Class No.     | 3211-03  |
| NA Certification  | UL Listed, CSA certified                                 |

| Distinctive number/type of combinations |            |            | Part no.<br>Article no.       | Price<br>See price list | Std. pack  | Description                        | Notes  |  |
|---|------------|------------|-------------------------------|-------------------------|--|------------------------------------|--|--|
| DILA(C)-40                              | DILA(C)-31 | DILA(C)-22 |                               |                         |  |                                    |  |  |
| 42E                                     | 33         | 24         | <b>DILA-XHI02</b><br>276420   |                         | 5 off<br>      | With interlocked opposing contacts | Type E combinations comply with EN 50011 and must be given preference. The other combinations comply with EN 50005<br>The DC operated contactor DILA(C)-22 must only be combined with 2 pole auxiliary contacts. |  |
| 51E                                     | 42         | 33         | <b>DILA-XHI11</b><br>276421   |                         | 5 off<br>      | With interlocked opposing contacts |  |  |
| 60E                                     | 51         | 42         | <b>DILA-XHI20</b><br>276422   |                         | 5 off<br>      | With interlocked opposing contacts |  |  |
| 51                                      | 42         | 33         | <b>DILA-XHIV11</b><br>276423  |                         | 5 off<br>      | –                                  |  |  |
| 44E                                     | 35         | 26         | <b>DILA-XHI04</b><br>276424   |                         | 5 off<br>      | With interlocked opposing contacts |  |  |
| 53E                                     | 44         | 35         | <b>DILA-XHI13</b><br>276425   |                         | 5 off<br>      | With interlocked opposing contacts |  |  |
| 62E                                     | 53         | 44         | <b>DILA-XHI22</b><br>276426   |                         | 5 off<br>      | With interlocked opposing contacts |  |  |
| 71E                                     | 62         | 53         | <b>DILA-XHI31</b><br>276427   |                         | 5 off<br>    | With interlocked opposing contacts |  |  |
| 80E                                     | 71         | 62         | <b>DILA-XHI40</b><br>276428   |                         | 5 off<br>  | With interlocked opposing contacts |  |  |
| 62                                      | 53         | 44         | <b>DILA-XHIV22</b><br>276429  |                         | 5 off<br>  | –                                  |  |  |
| 42E                                     | 33         | 24         | <b>DILA-XHIC02</b><br>276526  |                         | 5 off<br>  | With interlocked opposing contacts |  | Type E combinations comply with EN 50011 and must be given preference. The other combinations comply with EN 50005<br>The DC operated contactor DILA(C)-22 must only be combined with 2 pole auxiliary contacts. |
| 51E                                     | 42         | 33         | <b>DILA-XHIC11</b><br>276527  |                         | 5 off<br>  | With interlocked opposing contacts |  |  |
| 60E                                     | 51         | 42         | <b>DILA-XHIC20</b><br>276528  |                         | 5 off<br>  | With interlocked opposing contacts |  |  |
| 51                                      | 42         | 33         | <b>DILA-XHICV11</b><br>276529 |                         | 5 off<br>  | –                                  |  |  |
| 44E                                     | 35         | 26         | <b>DILA-XHIC04</b><br>276530  |                         | 5 off<br>  | With interlocked opposing contacts |  |  |
| 53E                                     | 44         | 35         | <b>DILA-XHIC13</b><br>276531  |                         | 5 off<br>  | With interlocked opposing contacts |  |  |
| 62E                                     | 53         | 44         | <b>DILA-XHIC22</b><br>276532  |                         | 5 off<br>  | With interlocked opposing contacts |  |  |
| 71E                                     | 62         | 53         | <b>DILA-XHIC31</b><br>276533  |                         | 5 off<br>  | With interlocked opposing contacts |  |  |
| 80E                                     | 71         | 62         | <b>DILA-XHIC40</b><br>276534  |                         | 5 off<br>  | With interlocked opposing contacts |  |  |
| 62                                      | 53         | 44         | <b>DILA-XHICV22</b><br>276535 |                         | 5 off<br>  | –                                  |  |  |

# 1.1 Contactors

## 1 Technical overview

### DILM, DILE(E)M, DILMP

#### Contactors

3 pole

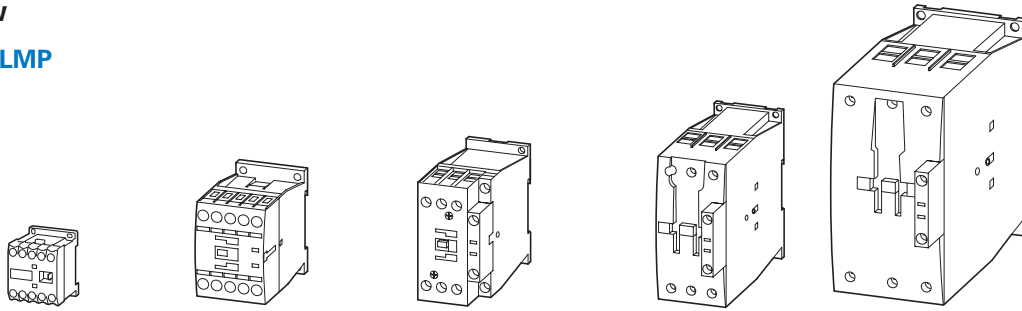

| DIL                       | EEM | EM | EM12 | M7        | M9 | M12 | M15 | M17       | M25 | M32 | M38 | M40       | M50 | M65 | M80       | M95 | M115 | M150 | M170 |
|---------------------------|-----|----|------|-----------|----|-----|-----|-----------|-----|-----|-----|-----------|-----|-----|-----------|-----|------|------|------|
| Basic devices             | → 4 |    |      | → 18      |    |     |     | → 18      |     |     |     | → 20      |     |     | → 46      |     |      |      |      |
| Complete units            |     | -  |      | → Page 24 |    |     |     | → Page 24 |     |     |     | → Page 26 |     |     | → Page 26 |     |      |      |      |
| Rated-operational voltage | kW  | kW | kW   | kW        | kW | kW  | kW  | kW        | kW  | kW  | kW  | kW        | kW  | kW  | kW        | kW  | kW   | kW   | kW   |

| AC-3                 | Rated operational power for 3-phase motors 50–60 Hz |          |            |          |          |            |            |            |           |           |             |             |           |           |           |           |           |           |           |
|----------------------|---|----------|------------|----------|----------|------------|------------|------------|-----------|-----------|-------------|-------------|-----------|-----------|-----------|-----------|-----------|-----------|-----------|
| 220 V – 230 V        | 1.5   | 2.2      | 3          | 2.2      | 2.5      | 3.5        | 4          | 5          | 7.5       | 10        | 11          | 12.5        | 15.5      | 20        | 25        | 30        | 37        | 48        | 52        |
| <b>380 V – 400 V</b> | <b>3</b>  | <b>4</b> | <b>5.5</b> | <b>3</b> | <b>4</b> | <b>5.5</b> | <b>7.5</b> | <b>7.5</b> | <b>11</b> | <b>15</b> | <b>18.5</b> | <b>18.5</b> | <b>22</b> | <b>30</b> | <b>37</b> | <b>45</b> | <b>55</b> | <b>75</b> | <b>90</b> |
| 440 V                | 3.3   | 4.6      | 5.5        | 4.5      | 5.5      | 7.5        | 8.4        | 10.5       | 15.5      | 20        | 21          | 25          | 32        | 41        | 51        | 60        | 75        | 95        | 105       |
| 500 V                | 3   | 4        | 5.5        | 3.5      | 4.5      | 7          | 7.5        | 12         | 17.5      | 23        | 24          | 28          | 36        | 47        | 58        | 70        | 85        | 110       | 120       |
| 660 V/690 V          | 3   | 4        | 4          | 3.5      | 4.5      | 6.5        | 7          | 11         | 14        | 17        | 21          | 23          | 30        | 35        | 63        | 75        | 90        | 96        | 140       |
| 1000 V               | -   | -        | -          | -        | -        | -          | -          | -          | -         | -         | -           | -           | -         | -         | -         | -         | -         | -         | -         |

| AC-4                 | Rated operational power for 3-phase motors 50–60 Hz |          |          |            |            |          |          |            |          |          |          |          |           |           |           |           |           |           |           |
|----------------------|---|----------|----------|------------|------------|----------|----------|------------|----------|----------|----------|----------|-----------|-----------|-----------|-----------|-----------|-----------|-----------|
| 220 V – 230 V        | 1.1   | 1.5      | 1.5      | 1          | 1.5        | 2        | 2        | 2.5        | 3.5      | 4        | 4        | 5        | 6         | 7         | 12        | 16        | 17        | 20        | 20        |
| <b>380 V – 400 V</b> | <b>2.2</b>  | <b>3</b> | <b>3</b> | <b>2.2</b> | <b>2.5</b> | <b>3</b> | <b>3</b> | <b>4.5</b> | <b>6</b> | <b>7</b> | <b>7</b> | <b>9</b> | <b>10</b> | <b>12</b> | <b>20</b> | <b>26</b> | <b>28</b> | <b>33</b> | <b>33</b> |
| 440 V                | 2.4   | 3.3      | 3.3      | 2.4        | 3          | 3.6      | 3.6      | 5.5        | 7        | 8        | 8        | 10       | 12        | 14        | 25        | 32        | 35        | 41        | 41        |
| 500 V                | 2.2   | 3        | 3        | 2.5        | 2.8        | 3.5      | 3.5      | 6          | 8        | 9        | 9        | 11       | 13        | 16        | 29        | 36        | 40        | 47        | 47        |
| 660 V/690 V          | 2.2   | 3        | 3        | 2.9        | 3.6        | 4.4      | 4.4      | 6.5        | 8.5      | 10       | 10       | 12       | 14        | 17        | 26        | 35        | 43        | 48        | 48        |
| 1000 V               | -   | -        | -        | -          | -          | -        | -        | -          | -        | -        | -        | -        | -         | -         | -         | -         | -         | -         | -         |

| AC-1                         | Rated operational power under resistive load, 40 °C |           |           |           |           |           |           |           |           |           |           |           |           |           |           |           |            |            |            |
|------------------------------|---|-----------|-----------|-----------|-----------|-----------|-----------|-----------|-----------|-----------|-----------|-----------|-----------|-----------|-----------|-----------|------------|------------|------------|
| 220 V – 230 V                | 8   | 8         | 8         | 8         | 8         | 8         | 8         | 15        | 17        | 17        | 17        | 22        | 30        | 37        | 42        | 49        | 61         | 72         | 85         |
| <b>380 V – 400 V</b>         | <b>13</b>   | <b>13</b> | <b>13</b> | <b>14</b> | <b>14</b> | <b>14</b> | <b>14</b> | <b>26</b> | <b>29</b> | <b>29</b> | <b>29</b> | <b>39</b> | <b>53</b> | <b>65</b> | <b>72</b> | <b>85</b> | <b>105</b> | <b>125</b> | <b>150</b> |
| 400 V                        | 15  | 15        | 15        | 16        | 16        | 16        | 16        | 30        | 34        | 34        | 34        | 45        | 58        | 71        | 80        | 94        | 116        | 138        | 170        |
| 500 V                        | 18  | 18        | 18        | 19        | 19        | 19        | 19        | 34        | 38        | 38        | 38        | 51        | 66        | 81        | 90        | 107       | 132        | 156        | 194        |
| 660 V/690 V                  | 23  | 23        | 23        | 25        | 25        | 25        | 25        | 45        | 51        | 51        | 51        | 68        | 91        | 111       | 125       | 148       | 182        | 216        | 268        |
| 1000 V                       | -   | -         | -         | -         | -         | -         | -         | -         | -         | -         | -         | -         | -         | -         | -         | -         | -          | -          | -          |
| Conventional thermal Current | A   | A         | A         | A         | A         | A         | A         | A         | A         | A         | A         | A         | A         | A         | A         | A         | A          | A          | A          |
| $I_{th} = I_e$ open at 40 °C | 22  | 22        | 22        | 22        | 22        | 22        | 22        | 40        | 45        | 45        | 45        | 60        | 80        | 98        | 110       | 130       | 160        | 190        | 225        |

### DILM, DILE(E)M, DILMP

#### Contactors

4 pole

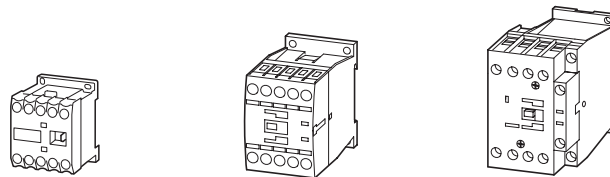

| DIL                       | EM4   | MP20      | MP32      |
|---------------------------|---|-----------|-----------|
| Rated operational voltage | → 4   | → Page 34 | → Page 34 |
| AC-1                      | Conventional free air thermal current $I_{th} = I_e$ open, at 40 °C |           |           |
| up to 690 V               | A   | A         | A         |
|                           | 22  | 22        | 32        |



**DILM, DILH, DILMP**

**Contactors**  
3 pole

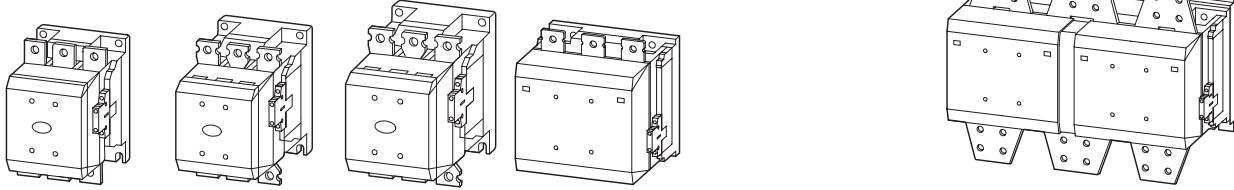

| M185A     | M225A | M250A | M300A | M400      | M500 | M580 | M650 | M750      | M820 | M1000     | M1600 | M1400     | H2000 | H2200 | H2600 |
|-----------|-------|-------|-------|-----------|------|------|------|-----------|------|-----------|-------|-----------|-------|-------|-------|
| -         | -     | -     | -     | -         | -    | -    | -    | -         | -    | -         | -     | -         | -     | -     | -     |
| → Page 30 |       |       |       | → Page 30 |      |      |      | → Page 30 |      | → Page 30 |       | → Page 32 |       |       |       |
| kW        | kW    | kW    | kW    | kW        | kW   | kW   | kW   | kW        | kW   | kW        | kW    | kW        | kW    | kW    | kW    |

|           |            |            |            |            |            |            |            |            |            |            |            |   |   |   |   |
|-----------|------------|------------|------------|------------|------------|------------|------------|------------|------------|------------|------------|---|---|---|---|
| 55        | 70         | 75         | 90         | 125        | 155        | 185        | 205        | 240        | 260        | 315        | 500        | - | - | - | - |
| <b>90</b> | <b>110</b> | <b>132</b> | <b>160</b> | <b>200</b> | <b>250</b> | <b>315</b> | <b>355</b> | <b>400</b> | <b>450</b> | <b>560</b> | <b>900</b> | - | - | - | - |
| 115       | 142        | 157        | 190        | 255        | 345        | 370        | 420        | 480        | 525        | 650        | 1000       | - | - | - | - |
| 132       | 160        | 180        | 215        | 290        | 360        | 420        | 470        | 550        | 600        | 730        | 1180       | - | - | - | - |
| 175       | 215        | 240        | 286        | 344        | 344        | 560        | 630        | 720        | 750        | 1000       | 1600       | - | - | - | - |
| 108       | 108        | 108        | 132        | 132        | 132        | 600        | 600        | 800        | 800        | 1000       | 1770       | - | - | - | - |

|           |           |            |            |            |            |            |            |            |            |            |            |   |   |   |   |
|-----------|-----------|------------|------------|------------|------------|------------|------------|------------|------------|------------|------------|---|---|---|---|
| 41        | 51        | 62         | 75         | 92         | 112        | 143        | 161        | 181        | 209        | 260        | 430        | - | - | - | - |
| <b>75</b> | <b>90</b> | <b>110</b> | <b>132</b> | <b>160</b> | <b>200</b> | <b>250</b> | <b>280</b> | <b>315</b> | <b>355</b> | <b>450</b> | <b>750</b> | - | - | - | - |
| 85        | 102       | 125        | 140        | 186        | 229        | 290        | 326        | 367        | 418        | 520        | 830        | - | - | - | - |
| 96        | 116       | 143        | 172        | 214        | 260        | 330        | 370        | 417        | 474        | 590        | 940        | - | - | - | - |
| 127       | 155       | 189        | 229        | 283        | 344        | 440        | 494        | 556        | 633        | 780        | 1300       | - | - | - | - |
| 108       | 108       | 108        | 132        | 132        | 132        | 509        | 509        | 678        | 678        | 1000       | 1650       | - | - | - | - |

|            |            |            |            |            |            |            |            |            |            |            |             |             |             |             |             |
|------------|------------|------------|------------|------------|------------|------------|------------|------------|------------|------------|-------------|-------------|-------------|-------------|-------------|
| 121        | 139        | 155        | 177        | 221        | 310        | 354        | 376        | 398        | 443        | 443        | 717         | 620         | 886         | 1075        | 1269        |
| <b>210</b> | <b>241</b> | <b>268</b> | <b>306</b> | <b>382</b> | <b>535</b> | <b>612</b> | <b>650</b> | <b>689</b> | <b>766</b> | <b>766</b> | <b>1247</b> | <b>1071</b> | <b>1531</b> | <b>1870</b> | <b>2207</b> |
| 243        | 279        | 310        | 354        | 443        | 620        | 709        | 753        | 797        | 886        | 886        | 1371        | 1240        | 1773        | 2058        | 2427        |
| 277        | 317        | 352        | 403        | 503        | 705        | 806        | 856        | 906        | 1007       | 1007       | 1558        | 1410        | 2015        | 2338        | 2758        |
| 365        | 419        | 465        | 532        | 664        | 930        | 1064       | 1130       | 1196       | 1330       | 1330       | 2151        | 1861        | 2660        | 3227        | 3806        |
| 554        | 635        | 705        | 806        | 1007       | 1410       | 1612       | 1712       | 1813       | 2015       | 2015       | 2420        | 2417        | 3223        | 4676        | 5516        |

|     |     |     |     |     |     |     |      |      |      |      |      |      |      |      |      |
|-----|-----|-----|-----|-----|-----|-----|------|------|------|------|------|------|------|------|------|
| A   | A   | A   | A   | A   | A   | A   | A    | A    | A    | A    | A    | A    | A    | A    | A    |
| 337 | 356 | 400 | 430 | 612 | 857 | 980 | 1041 | 1102 | 1225 | 1225 | 2200 | 1714 | 2450 | 2700 | 3185 |

**DILM, DILE(E)M, DILMP**

**Contactors**  
4 pole

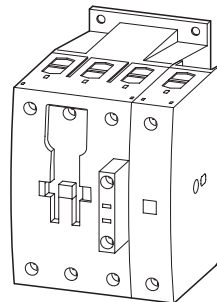
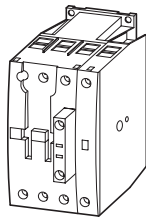

| MP45      | MP63      | MP80 | MP125     | MP160 | MP200 |
|-----------|-----------|------|-----------|-------|-------|
| → Page 34 | → Page 34 |      | → Page 34 |       |       |

|    |    |    |     |     |     |
|----|----|----|-----|-----|-----|
| A  | A  | A  | A   | A   | A   |
| 45 | 63 | 80 | 125 | 160 | 200 |

# 1.1 Contactors

## 1 System overview

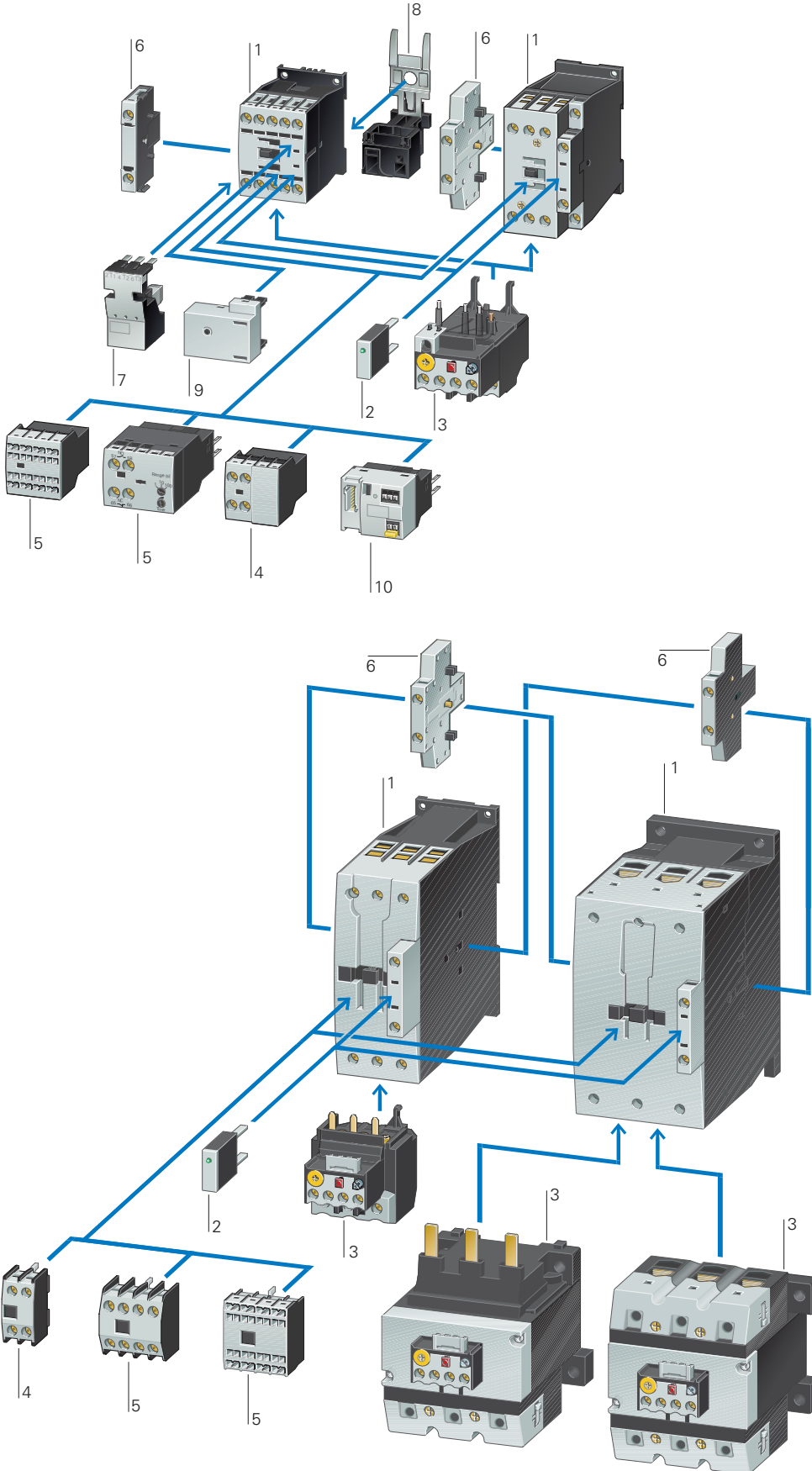

### DILM7...DILM170

#### Contactors up to 90 kW (AC-3/400V) 1

- 3 pole → Page 18
- 4 pole → Page 34

#### Suppressor circuits 2

- Page 50

#### Overload relays 3

- Chapter 1.2 (Page 8)

#### Auxiliary contact modules 4

- Page 36

#### Auxiliary contact modules 5

- Page 36

#### Auxiliary contact modules 6

- Page 39

#### Motor feeder plug 7

- Page 58

#### PE module with contact plate 8

- Page 58

#### Motor suppressor module 9

- Page 59

#### SmartWire-DT® contactor module 10

- Page 58

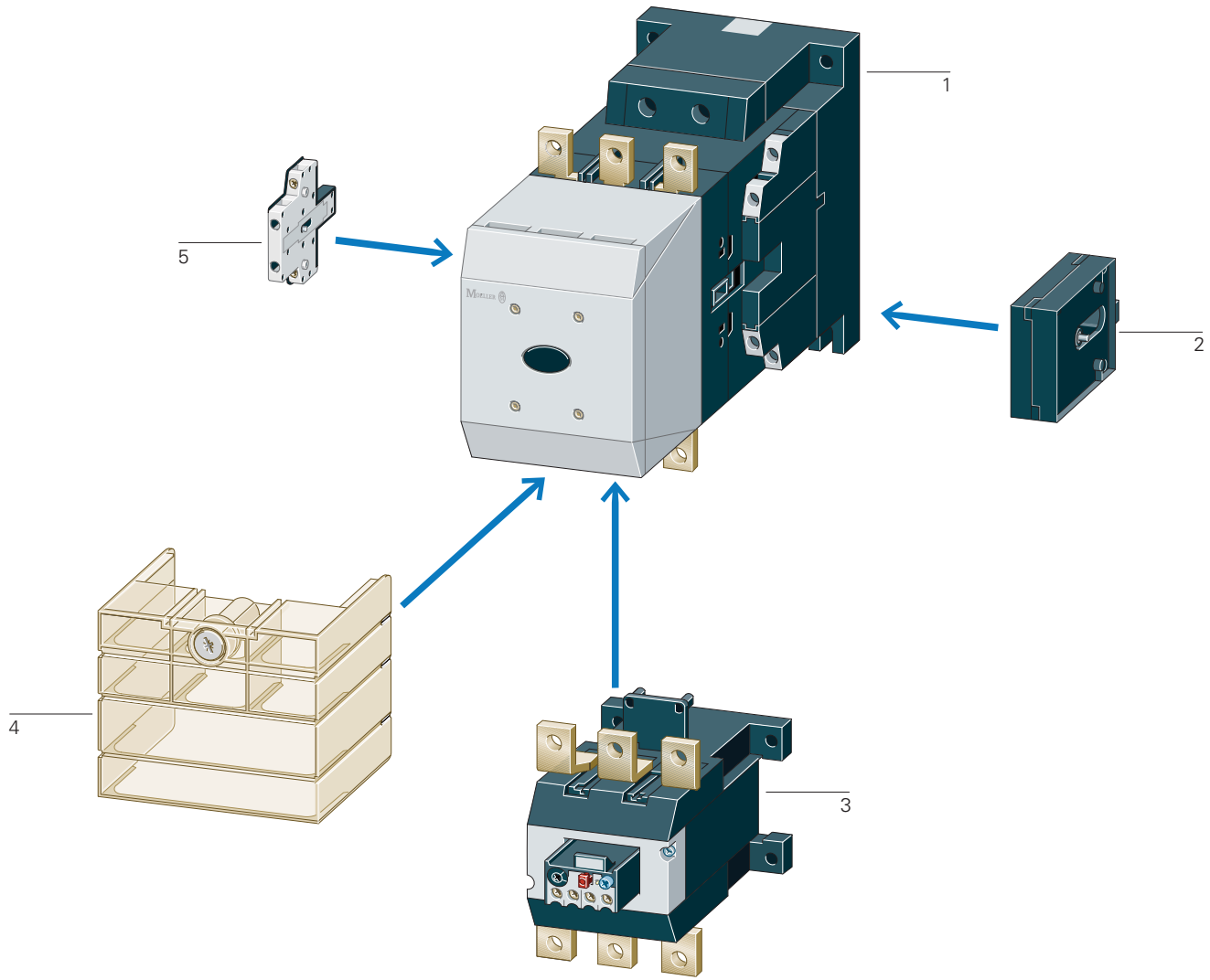

**DILM185... DILH2600**

|   |          |
|---|----------|
| <b>Contactors 90 – 900 kW<br/>(AC-3/400 V)<br/>Comfort series</b> | <b>1</b> |
| → Page 30   |          |
| <b>Standard range 90–250kW</b>                                    | <b>1</b> |
| → Page 28   |          |

|                             |          |
|-----------------------------|----------|
| <b>Mechanical interlock</b> | <b>2</b> |
| → Page 52                   |          |
| <b>Overload relays</b>      | <b>3</b> |
| → Chapter 1.2 (Page 12)     |          |

|                                  |          |
|----------------------------------|----------|
| <b>Terminal shroud</b>           | <b>4</b> |
| → Page 61                        |          |
| <b>Auxiliary contact modules</b> | <b>5</b> |
| → Page 39                        |          |

# 1.1

## Contactors

Basic devices up to 170 A

1

### DILM Basic device

Rated operational current

Max. motor rating for three-phase motors 50 - 60 Hz

Conventional thermal current  $I_{th} = I_e$  AC-1 at 60 °C

Contact configuration

Circuit symbol

| AC-3        | AC-3           |                | AC-4           |                | Open       | $I_{th} = I_e$ | A  | Contact configuration | Circuit symbol |                |
|-------------|----------------|----------------|----------------|----------------|------------|----------------|----|-----------------------|----------------|----------------|
|             | 380 V<br>400 V | 220 V<br>230 V | 380 V<br>400 V | 660 V<br>690 V |            |                |    |                       |                | 220 V<br>230 V |
| <b>7</b>    | 2.2            | <b>3</b>       | 3.5            | 1              | <b>2.2</b> | 2.9            | 20 | 1 N/O                 | –              |                |
| <b>7</b>    | 2.2            | <b>3</b>       | 3.5            | 1              | <b>2.2</b> | 2.9            | 20 | –                     | 1 NC           |                |
| <b>9</b>    | 2.5            | <b>4</b>       | 4.5            | 1.5            | <b>2.5</b> | 3.6            | 20 | 1 N/O                 | –              |                |
| <b>9</b>    | 2.5            | <b>4</b>       | 4.5            | 1.5            | <b>2.5</b> | 3.6            | 20 | –                     | 1 NC           |                |
| <b>12</b>   | 3.5            | <b>5.5</b>     | 6.5            | 2              | <b>3</b>   | 4.4            | 20 | 1 N/O                 | –              |                |
| <b>12</b>   | 3.5            | <b>5.5</b>     | 6.5            | 2              | <b>3</b>   | 4.4            | 20 | –                     | 1 NC           |                |
| <b>15.5</b> | 4              | <b>7.5</b>     | 7              | 2              | <b>3</b>   | 4.4            | 20 | 1 N/O                 | –              |                |
| <b>15.5</b> | 4              | <b>7.5</b>     | 7              | 2              | <b>3</b>   | 4.4            | 20 | –                     | 1 NC           |                |
| <b>18</b>   | 5              | <b>7.5</b>     | 11             | 2.5            | <b>4.5</b> | 6.5            | 35 | 1 N/O                 | –              |                |
| <b>18</b>   | 5              | <b>7.5</b>     | 11             | 2.5            | <b>4.5</b> | 6.5            | 35 | –                     | 1 NC           |                |
| <b>25</b>   | 7.5            | <b>11</b>      | 14             | 3.5            | <b>6</b>   | 8.5            | 40 | 1 N/O                 | –              |                |
| <b>25</b>   | 7.5            | <b>11</b>      | 14             | 3.5            | <b>6</b>   | 8.5            | 40 | –                     | 1 NC           |                |
| <b>32</b>   | 10             | <b>15</b>      | 17             | 4              | <b>7</b>   | 10             | 40 | 1 N/O                 | –              |                |
| <b>32</b>   | 10             | <b>15</b>      | 17             | 4              | <b>7</b>   | 10             | 40 | –                     | 1 NC           |                |
| <b>38</b>   | 11             | <b>18.5</b>    | 21             | 4              | <b>7</b>   | 10             | 40 | 1 N/O                 | –              |                |
| <b>38</b>   | 11             | <b>18.5</b>    | 21             | 4              | <b>7</b>   | 10             | 40 | –                     | 1 NC           |                |

Screw terminals  
3 pole

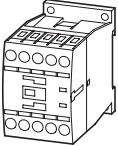

Screw terminals  
3 pole

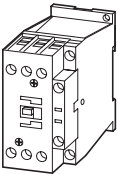

#### Information relevant for export to North America



|                   |  |
|-------------------|--|
| Product Standards | IEC/EN 60947-4-1; UL 508; CSA-C22.2 No.14-05; CE marking |
| UL File No.       | E29096   |
| UL CCN            | NLDX   |
| CSA File No.      | 012528   |
| CSA Class No.     | 2411-03, 3211-04   |
| NA Certification  | UL Listed,<br>CSA certified                              |
| See also          | → Page 80  |

|  | <b>AC operation</b>            | <b>DC operation</b>            |                                |                                |           |
|--|--------------------------------|--------------------------------|--------------------------------|--------------------------------|-----------|
| Can be combined with auxiliary contact | <b>Part no.</b><br>Article no. | <b>Part no.</b><br>Article no. | <b>Price</b><br>See price list | <b>Price</b><br>See price list | Std. pack |

**Notes**

|   |   |  |  |  |  |
|---|---|--|--|--|--|
| DILM32-XHI..<br>DILA-XHI(V)..                   | <b>DILM7-10(230V50Hz)</b><br>276550               | <b>DILM7-10(24VDC)</b><br>276565               |  |  |  |
| DILA-XHI(V)..                                   | <b>DILM7-01(230V50Hz)</b><br>276585               | <b>DILM7-01(24VDC)</b><br>276600               |  |  |  |
| DILM32-XHI..<br>DILA-XHI(V)..                   | <b>DILM9-10(230V50Hz)</b><br>276690               | <b>DILM9-10(24VDC)</b><br>276705               |  |  |  |
| DILA-XHI(V)..                                   | <b>DILM9-01(230V50Hz)</b><br>276725               | <b>DILM9-01(24VDC)</b><br>276740               |  |  |  |
| DILM32-XHI..<br>DILA-XHI(V)..                   | <b>DILM12-10(230V50Hz)</b><br>276830              | <b>DILM12-10(24VDC)</b><br>276845              |  |  |  |
| DILA-XHI(V)..                                   | <b>DILM12-01(230V50Hz)</b><br>276865              | <b>DILM12-01(24VDC)</b><br>276880              |  |  |  |
| DILM32-XHI..<br>DILA-XHI(V)..                   | <b>DILM15-10(230V50Hz)<sup>1)</sup></b><br>290058 | <b>DILM15-10(24VDC)<sup>1)</sup></b><br>290073 |  |  |  |
| DILA-XHI(V)..                                   | <b>DILM15-01(230V50Hz)<sup>1)</sup></b><br>290093 | <b>DILM15-01(24VDC)<sup>1)</sup></b><br>290108 |  |  |  |
| DILM32-XHI..<br>DILA-XHI(V)..<br>DILM32-XHI11-S | <b>DILM17-10(230V50Hz)</b><br>277004              | <b>DILM17-10(RDC24)</b><br>277018              |  |  |  |
| DILA-XHI(V)..<br>DILM32-XHI11-S                 | <b>DILM17-01(230V50Hz)</b><br>277036              | <b>DILM17-01(RDC24)</b><br>277050              |  |  |  |
| DILM32-XHI..<br>DILA-XHI(V)..<br>DILM32-XHI11-S | <b>DILM25-10(230V50Hz)</b><br>277132              | <b>DILM25-10(RDC24)</b><br>277146              |  |  |  |
| DILA-XHI(V)..<br>DILM32-XHI11-S                 | <b>DILM25-01(230V50Hz)</b><br>277164              | <b>DILM25-01(RDC24)</b><br>277178              |  |  |  |
| DILM32-XHI..<br>DILA-XHI(V)..<br>DILM32-XHI11-S | <b>DILM32-10(230V50Hz)</b><br>277260              | <b>DILM32-10(RDC24)</b><br>277274              |  |  |  |
| DILA-XHI(V)..<br>DILM32-XHI11-S                 | <b>DILM32-01(230V50Hz)</b><br>277292              | <b>DILM32-01(RDC24)</b><br>277306              |  |  |  |
| DILM32-XHI..<br>DILA-XHI(V)..<br>DILM32-XHI11-S | <b>DILM38-10(230V50Hz)<sup>1)</sup></b><br>112428 | <b>DILM38-10(RDC24)<sup>1)</sup></b><br>112442 |  |  |  |
| DILA-XHI(V)..<br>DILM32-XHI11-S                 | <b>DILM38-01(230V50Hz)<sup>1)</sup></b><br>112456 | <b>DILM38-01(RDC24)<sup>1)</sup></b><br>112470 |  |  |  |

1 off 

Contacts to EN 50 012.  
For all DC operated contactors DILM7 - DILM15 the following applies:  

- Integrated varistor-suppressor circuit.

For DC operated contactors DILM17 - DILM170 the following applies:  

- Integrated suppressor circuit in actuating electronics

For AC operated contactors DILM115 - DILM170 the following applies:  

- Integrated suppressor circuit in actuating electronics
- With mirror contact.

<sup>1)</sup> Electrical lifespan → 87

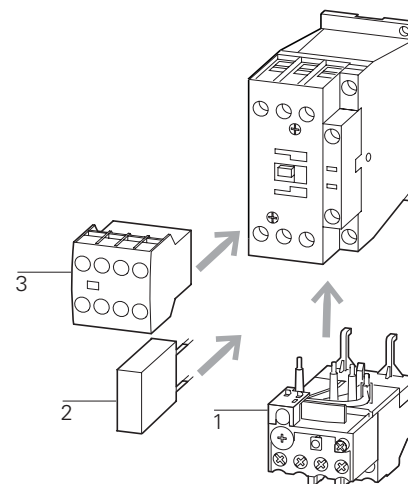

**Accessories**

- 1 Overload relay
- 2 Suppressor
- 3 Auxiliary contact module
- Further actuating voltages
- Accessories

**Page**

- Chapter 1.2
- 50
- 36
- 69
- 52

# 1.1

## Contactors

Basic devices up to 170 A

1

### DILM Basic device

Rated operational current

Max. motor rating for three-phase motors 50 - 60 Hz

Conventional thermal current  $I_{th} = I_e$  AC-1 at 60 °C

Contact configuration

Circuit symbol

| AC-3         | AC-3  |              | AC-4  |       | AC-4         |       |      |
|--------------|-------|--------------|-------|-------|--------------|-------|------|
| <b>380 V</b> | 220 V | <b>380 V</b> | 660 V | 220 V | <b>380 V</b> | 660 V | Open |
| <b>400 V</b> | 230 V | <b>400 V</b> | 690 V | 230 V | <b>400 V</b> | 690 V |      |

N/O = normally open contact  
NC = normally closed contact

Screw terminals  
3 pole

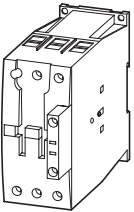

Screw terminals  
3 pole

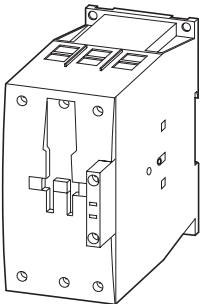

| $I_e$<br>A | P<br>kW | <b>P</b><br>kW | P<br>kW | P<br>kW | <b>P</b><br>kW | P<br>kW | $I_{th} = I_e$<br>A |   |   |  |
|------------|---------|----------------|---------|---------|----------------|---------|---------------------|---|---|--|
| <b>40</b>  | 12.5    | <b>18.5</b>    | 23      | 5       | <b>9</b>       | 12      | 50                  | — | — |  |
| <b>50</b>  | 15.5    | <b>22</b>      | 30      | 6       | <b>10</b>      | 14      | 65                  | — | — |  |
| <b>65</b>  | 20      | <b>30</b>      | 35      | 7       | <b>12</b>      | 17      | 80                  | — | — |  |
| <b>72</b>  | 25      | <b>37</b>      | 35      | 7       | <b>12</b>      | 17      | 80                  | — | — |  |
| <b>80</b>  | 25      | <b>37</b>      | 63      | 12      | <b>20</b>      | 26      | 90                  | — | — |  |
| <b>95</b>  | 30      | <b>45</b>      | 75      | 16      | <b>26</b>      | 35      | 110                 | — | — |  |
| <b>115</b> | 37      | <b>55</b>      | 90      | 17      | <b>28</b>      | 43      | 130                 | — | — |  |
| <b>150</b> | 48      | <b>75</b>      | 96      | 20      | <b>33</b>      | 48      | 160                 | — | — |  |
| <b>170</b> | 52      | <b>90</b>      | 140     | 20      | <b>33</b>      | 48      | 185                 | — | — |  |

#### Information relevant for export to North America



|                   |  |
|-------------------|--|
| Product Standards | IEC/EN 60947-4-1; UL 508; CSA-C22.2 No.14-05; CE marking |
| UL File No.       | E29096   |
| UL CCN            | NLDX   |
| CSA File No.      | 012528   |
| CSA Class No.     | 2411-03, 3211-04   |
| NA Certification  | UL Listed,<br>CSA certified                              |
| See also          | → Page 80  |

| Can be combined with auxiliary contact | AC operation<br>Part no.<br>Article no. | Price<br>See price list | DC operation<br>Part no.<br>Article no. | Price<br>See price list | Std. pack | Notes |
|--|---|-------------------------|---|-------------------------|-----------|-------|
|--|---|-------------------------|---|-------------------------|-----------|-------|

|                                       |  |  |  |  |  |  |
|---------------------------------------|--|--|--|--|--|--|
| DILM150-XHI(V)..<br>DILM1000-XHI(V).. | <b>DILM40(230V50Hz)</b><br>277766              |  | <b>DILM40(RDC24)</b><br>277780               |  |  |  |
| DILM150-XHI(V)..<br>DILM1000-XHI(V).. | <b>DILM50(230V50Hz)</b><br>277830              |  | <b>DILM50(RDC24)</b><br>277844               |  |  |  |
| DILM150-XHI(V)..<br>DILM1000-XHI(V).. | <b>DILM65(230V50Hz)</b><br>277894              |  | <b>DILM65(RDC24)</b><br>277908               |  |  |  |
| DILM150-XHI(V)..<br>DILM1000-XHI(V).. | <b>DILM72(230V50Hz)<sup>1)</sup></b><br>107670 |  | <b>DILM72(RDC24)<sup>1)</sup></b><br>107671  |  |  |  |
| DILM150-XHI(V)..<br>DILM1000-XHI(V).. | <b>DILM80(230V50Hz)</b><br>239402              |  | <b>DILM80(RDC24)</b><br>239416               |  |  |  |
| DILM150-XHI(V)..<br>DILM1000-XHI(V).. | <b>DILM95(230V50Hz)</b><br>239480              |  | <b>DILM95(RDC24)</b><br>239510               |  |  |  |
| DILM150-XHI(V)..<br>DILM1000-XHI(V).. | <b>DILM115(RAC240)</b><br>239548               |  | <b>DILM115(RDC24)</b><br>239555              |  |  |  |
| DILM150-XHI(V)..<br>DILM1000-XHI(V).. | <b>DILM150(RAC240)</b><br>239588               |  | <b>DILM150(RDC24)</b><br>239591              |  |  |  |
| DILM150-XHI(V)..<br>DILM1000-XHI(V).. | <b>DILM170(RAC240)<sup>1)</sup></b><br>107013  |  | <b>DILM170(RDC24)<sup>1)</sup></b><br>107016 |  |  |  |

1 off 

Contacts to EN 50012.  
For all DC operated contactors DILM7 - DILM15 the following applies:  

- Integrated varistor-suppressor circuit.

For DC operated contactors DILM17 - DILM170 the following applies:  

- Integrated suppressor circuit in actuating electronics

For AC operated contactors DILM115 - DILM170 the following applies:  

- Integrated suppressor circuit in actuating electronics

For DILM7-01 – DILM38-01 the following applies:  

- With mirror contact.

<sup>1)</sup> Electrical lifespan → 87

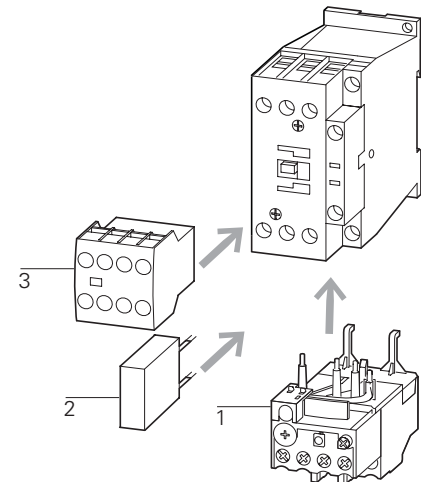

#### Accessories

- 1 Overload relay
- 2 Suppressor
- 3 Auxiliary contact module
- Further actuating voltages
- Accessories

#### Page

- Chapter 1.2
- 50
- 36
- 71
- 52

# 1.1

## Contactors

Basic devices up to 170 A

1

### DILM Basic device

| Rated operational current    | Max. motor rating for three-phase motors 50 - 60 Hz |              |       |       |              |       | Conventional thermal current $I_{th} = I_e$ AC-1 at 60 °C | Contact configuration                                       | Circuit symbol |
|------------------------------|---|--------------|-------|-------|--------------|-------|---|---|----------------|
|                              | AC-3  |              | AC-3  |       | AC-4         |       |   |   |                |
| <b>380 V</b><br><b>400 V</b> | 220 V   | <b>380 V</b> | 660 V | 220 V | <b>380 V</b> | 660 V | Open  | N/O = normally open contact<br>NC = normally closed contact |                |
| $I_e$<br><b>A</b>            | P   | <b>P</b>     | P     | P     | <b>P</b>     | P     |   |   |                |
|                              | kW  | <b>kW</b>    | kW    | kW    | <b>kW</b>    | kW    | $I_{th} = I_e$<br>A                                       |   |                |
| <b>7</b>                     | 2.2   | <b>3</b>     | 3.5   | 1     | <b>2.2</b>   | 2.9   | 20  | 1 N/O –   |                |
| <b>7</b>                     | 2.2   | <b>3</b>     | 3.5   | 1     | <b>2.2</b>   | 2.9   | 20  | – 1 NC  |                |
| <b>9</b>                     | 2.5   | <b>4</b>     | 4.5   | 1.5   | <b>2.5</b>   | 3.6   | 20  | 1 N/O –   |                |
| <b>9</b>                     | 2.5   | <b>4</b>     | 4.5   | 1.5   | <b>2.5</b>   | 3.6   | 20  | – 1 NC  |                |
| <b>12</b>                    | 3.5   | <b>5.5</b>   | 6.5   | 2     | <b>3</b>     | 4.4   | 20  | 1 N/O –   |                |
| <b>12</b>                    | 3.5   | <b>5.5</b>   | 6.5   | 2     | <b>3</b>     | 4.4   | 20  | – 1 NC  |                |
| <b>15.5</b>                  | 4   | <b>7.5</b>   | 7     | 2     | <b>3</b>     | 4.4   | 20  | 1 N/O –   |                |
| <b>15.5</b>                  | 4   | <b>7.5</b>   | 7     | 2     | <b>3</b>     | 4.4   | 20  | – 1 NC  |                |
| <b>18</b>                    | 5   | <b>7.5</b>   | 11    | 2.5   | <b>4.5</b>   | 6.5   | 35  | 1 N/O –   |                |
| <b>18</b>                    | 5   | <b>7.5</b>   | 11    | 2.5   | <b>4.5</b>   | 6.5   | 35  | – 1 NC  |                |
| <b>25</b>                    | 7.5   | <b>11</b>    | 14    | 3.5   | <b>6</b>     | 8.5   | 40  | 1 N/O –   |                |
| <b>25</b>                    | 7.5   | <b>11</b>    | 14    | 3.5   | <b>6</b>     | 8.5   | 40  | – 1 NC  |                |
| <b>32</b>                    | 10  | <b>15</b>    | –     | –     | <b>7</b>     | 10    | 40  | 1 N/O –   |                |
| <b>32</b>                    | 10  | <b>15</b>    | –     | –     | <b>7</b>     | 10    | 40  | – 1 NC  |                |
| <b>40</b>                    | 12.5  | <b>18.5</b>  | –     | –     | <b>9</b>     | 12    | 50  | – –   |                |
| <b>50</b>                    | 15.5  | <b>22</b>    | –     | –     | <b>10</b>    | 14    | 65  | – –   |                |
| <b>65</b>                    | 20  | <b>30</b>    | –     | –     | <b>12</b>    | 17    | 80  | – –   |                |
| <b>80</b>                    | 25  | <b>37</b>    | 63    | 12    | <b>20</b>    | 26    | 90  | – –   |                |
| <b>95</b>                    | 30  | <b>45</b>    | 75    | 16    | <b>26</b>    | 35    | 110   | – –   |                |
| <b>115</b>                   | 37  | <b>55</b>    | 90    | 17    | <b>28</b>    | 43    | 130   | – –   |                |
| <b>150</b>                   | 48  | <b>75</b>    | 96    | 20    | <b>33</b>    | 48    | 160   | – –   |                |

#### Spring-loaded terminals 3 pole

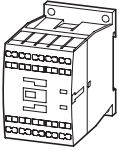

#### Spring-loaded terminals on auxiliary and control circuit terminals 3 pole

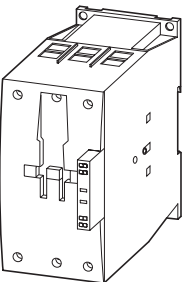
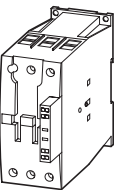
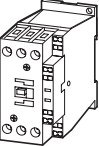

#### Information relevant for export to North America



|                   |  |
|-------------------|--|
| Product Standards | IEC/EN 60947-4-1; UL 508; CSA-C22.2 No.14-05; CE marking |
| UL File No.       | E29096   |
| UL CCN            | NLDX   |
| CSA File No.      | 012528   |
| CSA Class No.     | 2411-03, 3211-04   |
| NA Certification  | UL Listed, CSA certified                                 |
| See also          | → Page 80  |



Can be combined with auxiliary contact

|                                   | AC operation                          | DC operation                       | Std. pack  | Notes  |
|-----------------------------------|---------------------------------------|------------------------------------|--|--|
|                                   | Part no.<br>Article no.               | Part no.<br>Article no.            |  |  |
|                                   | Price<br>See price list               | Price<br>See price list            |  |  |
| DILM32-XHIC..<br>DILA-XHIC(V)..   | <b>DILMC7-10(230V50Hz)</b><br>277389  | <b>DILMC7-10(24VDC)</b><br>277404  | 1 off<br> | <p>Contacts to EN 50 012.</p> <p>For DILMC7 – DILMC15 the following applies:</p> <ul style="list-style-type: none"> <li>• Auxiliary coil, and main current terminals with spring-loaded terminals.</li> </ul> <p>For DILMC17 – DILMC150 the following applies:</p> <ul style="list-style-type: none"> <li>• Auxiliary connections, coil connections with spring-loaded connection terminals.</li> <li>• Main current connections with screw terminals.</li> </ul> <p>For DC operated contactors DILMC7 - DILMC15 the following applies:</p> <ul style="list-style-type: none"> <li>• Integrated varistor-suppressor circuit.</li> </ul> <p>For DC operated contactors DILMC17 - DILMC150 the following applies:</p> <ul style="list-style-type: none"> <li>• Integrated suppressor circuit in actuating electronics</li> </ul> <p>For AC operated contactors DILMC115 - DILMC150 the following applies:</p> <ul style="list-style-type: none"> <li>• Integrated suppressor circuit in actuating electronics</li> </ul> <p>For DILMC7-01 – DILMC32-01 the following applies:</p> <ul style="list-style-type: none"> <li>• With mirror contact.</li> </ul> |
| DILA-XHIC(V)..                    | <b>DILMC7-01(230V50Hz)</b><br>277421  | <b>DILMC7-01(24VDC)</b><br>277436  |  |  |
| DILM32-XHIC..<br>DILA-XHIC(V)..   | <b>DILMC9-10(230V50Hz)</b><br>277453  | <b>DILMC9-10(24VDC)</b><br>277468  |  |  |
| DILA-XHIC(V)..                    | <b>DILMC9-01(230V50Hz)</b><br>277485  | <b>DILMC9-01(24VDC)</b><br>277500  |  |  |
| DILM32-XHIC..<br>DILA-XHIC(V)..   | <b>DILMC12-10(230V50Hz)</b><br>277517 | <b>DILMC12-10(24VDC)</b><br>277532 |  |  |
| DILA-XHIC(V)..                    | <b>DILMC12-01(230V50Hz)</b><br>277549 | <b>DILMC12-01(24VDC)</b><br>277564 |  |  |
| DILM32-XHIC...<br>DILA-XHIC(V)... | <b>DILMC15-10(230V50Hz)</b><br>293911 | <b>DILMC15-10(24VDC)</b><br>293926 |  |  |
| DILA-XHIC(V)...                   | <b>DILMC15-01(230V50Hz)</b><br>293946 | <b>DILMC15-01(24VDC)</b><br>293961 |  |  |
| DILM32-XHIC..<br>DILA-XHIC(V)..   | <b>DILMC17-10(230V50Hz)</b><br>277581 | <b>DILMC17-10(RDC24)</b><br>277595 |  |  |
| DILA-XHIC(V)..                    | <b>DILMC17-01(230V50Hz)</b><br>277611 | <b>DILMC17-01(RDC24)</b><br>277625 |  |  |
| DILM32-XHIC..<br>DILA-XHIC(V)..   | <b>DILMC25-10(230V50Hz)</b><br>277641 | <b>DILMC25-10(RDC24)</b><br>277655 |  |  |
| DILA-XHIC(V)..                    | <b>DILMC25-01(230V50Hz)</b><br>277671 | <b>DILMC25-01(RDC24)</b><br>277685 |  |  |
| DILM32-XHIC..<br>DILA-XHIC(V)..   | <b>DILMC32-10(230V50Hz)</b><br>277701 | <b>DILMC32-10(RDC24)</b><br>277715 |  |  |
| DILA-XHIC(V)..                    | <b>DILMC32-01(230V50Hz)</b><br>277731 | <b>DILMC32-01(RDC24)</b><br>277745 |  |  |
| DILM150-XHIC(V)..                 | <b>DILMC40(230V50Hz)</b><br>277965    | <b>DILMC40(RDC24)</b><br>277979    |  |  |
| DILM1000-XHIC..                   | <b>DILMC50(230V50Hz)</b><br>277995    | <b>DILMC50(RDC24)</b><br>278009    |  |  |
|                                   | <b>DILMC65(230V50Hz)</b><br>278025    | <b>DILMC65(RDC24)</b><br>278039    |  |  |
|                                   | <b>DILMC80(230V50Hz)</b><br>239618    | <b>DILMC80(RDC24)</b><br>239652    |  |  |
|                                   | <b>DILMC95(230V50Hz)</b><br>239685    | <b>DILMC95(RDC24)</b><br>239715    |  |  |
|                                   | <b>DILMC115(RAC240)</b><br>239736     | <b>DILMC115(RDC24)</b><br>239741   |  |  |
|                                   | <b>DILMC150(RAC240)</b><br>239751     | <b>DILMC150(RDC24)</b><br>239765   |  |  |

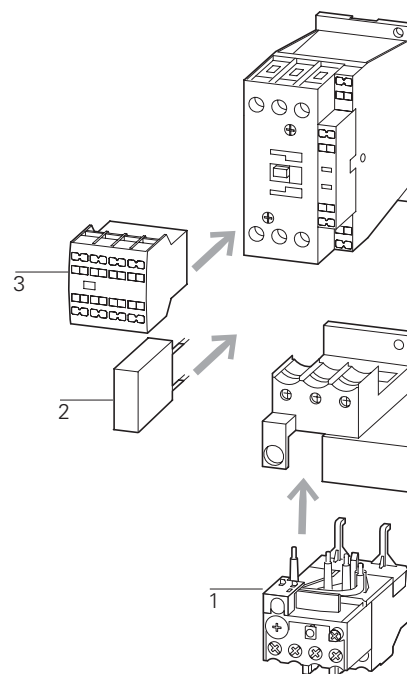

**Accessories**

- 1 Overload relay
- 2 Suppressor
- 3 Auxiliary contact module
- Further actuating voltages
- Accessories

**Page**

- Chapter 1.2
- 50
- 36
- 73
- 52

# 1.1

## Contactors

Complete device up to 170 A

1

### DILM complete device

| Rated operational current<br>AC-3 | Max. motor rating for three-phase motors 50 - 60 Hz |                              |                |                |                              |                | Conventional free air thermal current $I_{th} = I_e$<br>AC-1 at 60 °C | Contact configuration:<br>⊕ = Safety function by positive opening according to IEC/EN 60947-5-1 | Circuit symbol |  |
|-----------------------------------|---|------------------------------|----------------|----------------|------------------------------|----------------|---|---|----------------|--|
|                                   | AC-3  |                              |                | AC-4           |                              |                |   |   |                |  |
| <b>380 V</b><br><b>400 V</b>      | 220 V<br>230 V                                      | <b>380 V</b><br><b>400 V</b> | 660 V<br>690 V | 220 V<br>230 V | <b>380 V</b><br><b>400 V</b> | 660 V<br>690 V | Open<br>$I_{th} = I_e$  | N/O = normally open contact<br>NC = normally closed contact                                     |                |  |
| $I_e$                             | P   | <b>P</b>                     | P              | P              | <b>P</b>                     | P              | A   |   |                |  |
| <b>A</b>                          | kW  | <b>kW</b>                    | kW             | kW             | <b>kW</b>                    | kW             |   |   |                |  |
| <b>7</b>                          | 2.2   | <b>3</b>                     | 3.5            | 1              | <b>2.2</b>                   | 2.9            | 20  | 2 N/O   | 1 NC           |  |
| <b>7</b>                          | 2.2   | <b>3</b>                     | 3.5            | 1              | <b>2.2</b>                   | 2.9            | 20  | 2 N/O   | 1 NC           |  |
| <b>7</b>                          | 2.2   | <b>3</b>                     | 3.5            | 1              | <b>2.2</b>                   | 2.9            | 20  | 3 N/O   | 2 NC           |  |
| <b>9</b>                          | 2.5   | <b>4</b>                     | 4.5            | 1.5            | <b>2.5</b>                   | 3.6            | 20  | 2 N/O   | 1 NC           |  |
| <b>9</b>                          | 2.5   | <b>4</b>                     | 4.5            | 1.5            | <b>2.5</b>                   | 3.6            | 20  | 2 N/O   | 1 NC           |  |
| <b>9</b>                          | 2.5   | <b>4</b>                     | 4.5            | 1.5            | <b>2.5</b>                   | 3.6            | 20  | 3 N/O   | 2 NC           |  |
| <b>12</b>                         | 3.5   | <b>5.5</b>                   | 6.5            | 2              | <b>3</b>                     | 4.4            | 20  | 2 N/O   | 1 NC           |  |
| <b>12</b>                         | 3.5   | <b>5.5</b>                   | 6.5            | 2              | <b>3</b>                     | 4.4            | 20  | 2 N/O   | 1 NC           |  |
| <b>12</b>                         | 3.5   | <b>5.5</b>                   | 6.5            | 2              | <b>3</b>                     | 4.4            | 20  | 3 N/O   | 2 NC           |  |
| <b>15.5</b>                       | 4   | <b>7.5</b>                   | 7              | 2              | <b>3</b>                     | 4.4            | 20  | 2 N/O   | 2 NC           |  |
| <b>18</b>                         | 5   | <b>7.5</b>                   | 11             | 2.5            | <b>4.5</b>                   | 6.5            | 35  | 2 N/O   | 1 NC           |  |
| <b>18</b>                         | 5   | <b>7.5</b>                   | 11             | 2.5            | <b>4.5</b>                   | 6.5            | 35  | 2 N/O   | 1 NC           |  |
| <b>18</b>                         | 5   | <b>7.5</b>                   | 11             | 2.5            | <b>4.5</b>                   | 6.5            | 35  | 3 N/O   | 2 NC           |  |
| <b>25</b>                         | 7.5   | <b>11</b>                    | 14             | 3.5            | <b>6</b>                     | 8.5            | 40  | 2 N/O   | 1 NC           |  |
| <b>25</b>                         | 7.5   | <b>11</b>                    | 14             | 3.5            | <b>6</b>                     | 8.5            | 40  | 2 N/O   | 1 NC           |  |
| <b>25</b>                         | 7.5   | <b>11</b>                    | 14             | 3.5            | <b>6</b>                     | 8.5            | 40  | 3 N/O   | 2 NC           |  |
| <b>32</b>                         | 10  | <b>15</b>                    | 17             | 4              | <b>7</b>                     | 10             | 40  | 2 N/O   | 1 NC           |  |
| <b>32</b>                         | 10  | <b>15</b>                    | 17             | 4              | <b>7</b>                     | 10             | 40  | 2 N/O   | 1 NC           |  |
| <b>32</b>                         | 10  | <b>15</b>                    | 17             | 4              | <b>7</b>                     | 10             | 40  | 3 N/O   | 2 NC           |  |

Screw terminals

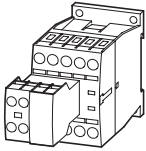

Screw terminals

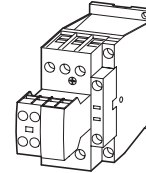

#### Information relevant for export to North America

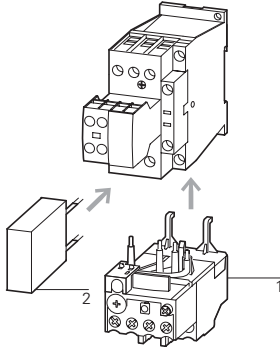

|                   |  |
|-------------------|--|
| Product Standards | IEC/EN 60947-4-1; UL 508; CSA-C22.2 No.14-05; CE marking |
| UL File No.       | E29096   |
| UL CCN            | NLDX   |
| CSA File No.      | 012528   |
| CSA Class No.     | 2411-03, 3211-04   |
| NA Certification  | UL Listed,<br>CSA certified                              |
| See also          | → Page 80  |

| AC operation                         |                            | DC operation                      |                            | Std. pack  | Notes   |
|--------------------------------------|----------------------------|-----------------------------------|----------------------------|--|---|
| Part no.<br>Article no.              | Price<br>See<br>price list | Part no.<br>Article no.           | Price<br>See<br>price list |  |   |
| <b>DILM7-21(230V50Hz)</b><br>276620  |                            | <b>DILM7-21(24VDC)</b><br>276635  |                            | 1 off<br> |  <p><b>Accessories</b></p> <p>1 Overload relay<br/>2 Suppressor<br/>Accessories</p> <p><b>Page</b></p> <p>→ Chapter 1.2<br/>→ 50<br/>→ 52</p> <p>For all DC operated contactors DILM7 - DILM15 the following applies:</p> <ul style="list-style-type: none"> <li>• Integrated varistor suppressor circuit.</li> </ul> <p>For DC operated contactors DILM17 - DILM170 the following applies:</p> <ul style="list-style-type: none"> <li>• Integrated suppressor circuit in actuating electronics</li> </ul> <p>For AC operated contactors DILM115 - DILM170 the following applies:</p> <ul style="list-style-type: none"> <li>• Integrated suppressor circuit in actuating electronics</li> </ul> <p>For DILM7 - DILM150 the following applies:</p> <ul style="list-style-type: none"> <li>• With mirror contact.</li> </ul> <p>Contacts to EN 50012</p> |
| <b>DILM7-22(230V50Hz)</b><br>106360  |                            | <b>DILM7-22(24VDC)</b><br>106367  |                            |  |   |
| <b>DILM7-32(230V50Hz)</b><br>276655  |                            | <b>DILM7-32(24VDC)</b><br>276670  |                            |  |   |
| <b>DILM9-21(230V50Hz)</b><br>276760  |                            | <b>DILM9-21(24VDC)</b><br>276775  |                            |  |   |
| <b>DILM9-22(230V50Hz)</b><br>106361  |                            | <b>DILM9-22(24VDC)</b><br>106368  |                            |  |   |
| <b>DILM9-32(230V50Hz)</b><br>276795  |                            | <b>DILM9-32(24VDC)</b><br>276810  |                            |  |   |
| <b>DILM12-21(230V50Hz)</b><br>276900 |                            | <b>DILM12-21(24VDC)</b><br>276915 |                            |  |   |
| <b>DILM12-22(230V50Hz)</b><br>106362 |                            | <b>DILM12-22(24VDC)</b><br>106369 |                            |  |   |
| <b>DILM12-32(230V50Hz)</b><br>276935 |                            | <b>DILM12-32(24VDC)</b><br>276950 |                            |  |   |
| <b>DILM15-22(230V50Hz)</b><br>106363 |                            | <b>DILM15-22(24VDC)</b><br>106370 |                            |  |   |
| <b>DILM17-21(230V50Hz)</b><br>277068 |                            | <b>DILM17-21(RDC24)</b><br>277082 |                            |  |   |
| <b>DILM17-22(230V50Hz)</b><br>106364 |                            | <b>DILM17-22(RDC24)</b><br>106371 |                            |  |   |
| <b>DILM17-32(230V50Hz)</b><br>277100 |                            | <b>DILM17-32(RDC24)</b><br>277114 |                            |  |   |
| <b>DILM25-21(230V50Hz)</b><br>277196 |                            | <b>DILM25-21(RDC24)</b><br>277210 |                            |  |   |
| <b>DILM25-22(230V50Hz)</b><br>106365 |                            | <b>DILM25-22(RDC24)</b><br>106372 |                            |  |   |
| <b>DILM25-32(230V50Hz)</b><br>277228 |                            | <b>DILM25-32(RDC24)</b><br>277242 |                            |  |   |
| <b>DILM32-21(230V50Hz)</b><br>277324 |                            | <b>DILM32-21(RDC24)</b><br>277338 |                            |  |   |
| <b>DILM32-22(230V50Hz)</b><br>106366 |                            | <b>DILM32-22(RDC24)</b><br>106373 |                            |  |   |
| <b>DILM32-32(230V50Hz)</b><br>277356 |                            | <b>DILM32-32(RDC24)</b><br>277370 |                            |  |   |

# 1.1

## Contactors

Complete device up to 170 A

1

### DILM complete device

| Rated operational current<br>AC-3 | Max. motor rating for three-phase motors 50 - 60 Hz |                              |                |                |                              |                | Conventional free air thermal current $I_{th} = I_e$<br>AC-1 at 60 °C | Contact configuration:<br>☉ = Safety function by positive opening according to IEC/EN 60947-5-1 | Circuit symbol |  |
|-----------------------------------|---|------------------------------|----------------|----------------|------------------------------|----------------|---|---|----------------|--|
|                                   | AC-3  |                              | AC-4           |                |                              |                |   |   |                |  |
| <b>380 V</b><br><b>400 V</b>      | 220 V<br>230 V                                      | <b>380 V</b><br><b>400 V</b> | 660 V<br>690 V | 220 V<br>230 V | <b>380 V</b><br><b>400 V</b> | 660 V<br>690 V | Open<br>$I_{th} = I_e$  | N/O = normally open contact<br>NC = normally closed contact                                     |                |  |
| <b><math>I_e</math></b>           | P   | <b>P</b>                     | P              | P              | <b>P</b>                     | P              | A   |   |                |  |
| <b>A</b>                          | kW  | <b>kW</b>                    | kW             | kW             | <b>kW</b>                    | kW             | A   |   |                |  |
| <b>40</b>                         | 12.5  | <b>18.5</b>                  | 23             | 5              | <b>9</b>                     | 12             | 50  | 2 N/O   | 2 NC           |  |
| <b>50</b>                         | 15.5  | <b>22</b>                    | 30             | 6              | <b>10</b>                    | 14             | 65  | 2 N/O   | 2 NC           |  |
| <b>65</b>                         | 20  | <b>30</b>                    | 35             | 7              | <b>12</b>                    | 17             | 80  | 2 N/O   | 2 NC           |  |
| <b>80</b>                         | 25  | <b>37</b>                    | 63             | 12             | <b>20</b>                    | 26             | 90  | 2 N/O   | 2 NC           |  |
| <b>95</b>                         | 30  | <b>45</b>                    | 75             | 16             | <b>26</b>                    | 35             | 110   | 2 N/O   | 2 NC           |  |
| <b>115</b>                        | 37  | <b>55</b>                    | 90             | 17             | <b>28</b>                    | 43             | 130   | 2 N/O   | 2 NC           |  |
| <b>150</b>                        | 48  | <b>75</b>                    | 96             | 20             | <b>34</b>                    | 48             | 160   | 2 N/O   | 2 NC           |  |

Screw terminals

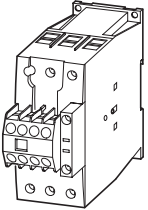

Screw terminals

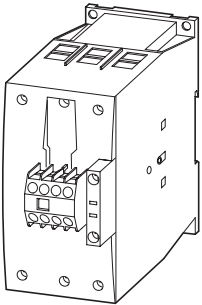

#### Information relevant for export to North America

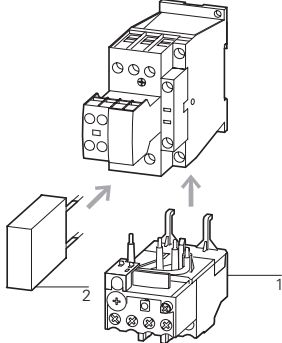

|                   |  |
|-------------------|--|
| Product Standards | IEC/EN 60947-4-1; UL 508; CSA-C22.2 No.14-05; CE marking |
| UL File No.       | E29096   |
| UL CCN            | NLDX   |
| CSA File No.      | 012528   |
| CSA Class No.     | 2411-03, 3211-04   |
| NA Certification  | UL Listed,<br>CSA certified                              |
| See also          | → Page 80  |

| AC operation                         |                            | DC operation                       |                            | Std. pack  | Notes  |
|--------------------------------------|----------------------------|------------------------------------|----------------------------|--|--|
| Part no.<br>Article no.              | Price<br>See<br>price list | Part no.<br>Article no.            | Price<br>See<br>price list |  |  |
| <b>DILM40-22(230V50Hz)</b><br>277798 |                            | <b>DILM40-22(RDC24)</b><br>277812  |                            | 1 off<br> |  |
| <b>DILM50-22(230V50Hz)</b><br>277862 |                            | <b>DILM50-22(RDC24)</b><br>277876  |                            |  |  |
| <b>DILM65-22(230V50Hz)</b><br>277926 |                            | <b>DILM65-22(RDC24)</b><br>277940  |                            |  |  |
| <b>DILM80-22(230V50Hz)</b><br>239449 |                            | <b>DILM80-22(RDC24)</b><br>239463  |                            |  |  |
| <b>DILM95-22(230V50Hz)</b><br>239527 |                            | <b>DILM95-22(RDC24)</b><br>239541  |                            |  |  |
| <b>DILM115-22(RAC240)</b><br>239578  |                            | <b>DILM115-22(RDC24)</b><br>239581 |                            |  |  |
| <b>DILM150-22(RAC240)</b><br>239598  |                            | <b>DILM150-22(RDC24)</b><br>239601 |                            |  |  |

| Accessories      | Page          |
|------------------|---------------|
| 1 Overload relay | → Chapter 1.2 |
| 2 Suppressor     | → 50          |
| Accessories      | → 52          |

For DC operated contactors DILM17 - DILM170 the following applies:

- Integrated suppressor circuit in actuating electronics

For AC operated contactors DILM115 - DILM170 the following applies:

- Integrated suppressor circuit in actuating electronics

For DILM7 - DILM150 the following applies:

- With mirror contact.

Contacts to EN 50012

# 1.1

## Contactors DILM, DILH

Standard devices greater than 150 A

1

### DILM...S/22... Standard device for currents greater than 150 A

| Rated operational current           | Max. motor rating for three-phase motors 50 - 60 Hz |                              |                |                |                              |                | Conventional thermal current<br>$I_{th} = I_e$<br>AC-1 at 40 °C<br>Open<br>$I_{th} = I_e$ | Circuit symbol | For use with   |
|-------------------------------------|---|------------------------------|----------------|----------------|------------------------------|----------------|---|----------------|----------------|
|                                     | AC-3  |                              | AC-3           |                | AC-4                         |                |   |                |                |
| <b>380 V</b><br><b>400 V</b>        | 220 V<br>230 V                                      | <b>380 V</b><br><b>400 V</b> | 660 V<br>690 V | 220 V<br>230 V | <b>380 V</b><br><b>400 V</b> | 660 V<br>690 V |   |                |                |
| <b><math>I_e</math></b><br><b>A</b> | P<br>kW   | <b>P</b><br><b>kW</b>        | P<br>kW        | P<br>kW        | <b>P</b><br><b>kW</b>        | P<br>kW        |   |                |                |
| <b>250</b>                          | 75  | <b>132</b>                   | 240            | 62             | <b>110</b>                   | 189            | 400   |                | DILM820-XHI... |
| <b>300</b>                          | 90  | <b>160</b>                   | 195            | 75             | <b>132</b>                   | 160            | 430   |                | DILM820-XHI... |
| <b>400</b>                          | 125   | <b>200</b>                   | 344            | 92             | <b>160</b>                   | 283            | 612   |                | DILM820-XHI... |
| <b>500</b>                          | 155   | <b>250</b>                   | 344            | 112            | <b>200</b>                   | 344            | 857   |                | DILM820-XHI... |
| <b>580</b>                          | 185   | <b>315</b>                   | 344            | 112            | <b>200</b>                   | 344            | 920   |                | DILM820-XHI... |

DILM complete device

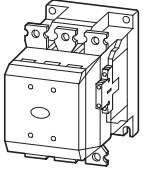

DILM complete device

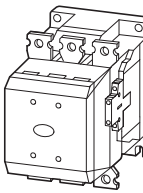

#### Notes

<sup>1)</sup> Availability from August 2010.  
Previous DILM300/22, see Online Catalog at <http://www.eaton.com/seasia-electrical>

For all contactors the following applies:

- 660 V, 690 V or 1000 V: do not reverse directly
- Integrated suppressor circuit in actuating electronics.

DILM...S contactors are actuated conventionally

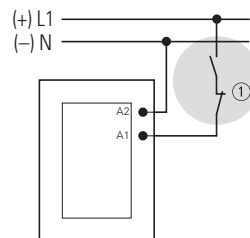





① Stopping in the event of an emergency (emergency switching off)

#### Accessories

Auxiliary contact modules  
Enclosures totally insulated  
Further actuating voltages

#### Page

→ 38  
→ 77

| Part no.<br>Article no.                                       | Price<br>See price list | Std. pack   | Information relevant for export to North America  |  |
|---|-------------------------|---|---|--|
| <b>DILM250-S/22(220-240V50/60Hz)</b><br>274190                | 1 off                   |    | Product Standards<br>UL File No.<br>UL CCN<br>CSA File No.<br>CSA Class No.<br>NA Certification             | IEC/EN 60947-4-1; UL 508; CSA-C22.2 No.14-05; CE marking<br>E29096<br>NLDX<br>1017510<br>3211-04<br>UL Listed, CSA certified |
| <b>DILM300A-S/22(220-240V50/60Hz)</b> <sup>1)</sup><br>139559 | 1 off                   |    | Request filed for UL and CSA  |  |
| <b>DILM400-S/22(220-240V50/60Hz)</b><br>274196                | 1 off                   |    | Product Standards<br>UL File No.<br>UL CCN<br>CSA File No.<br>CSA Class No.<br>NA Certification<br>See also | IEC/EN 60947-4-1; UL 508; CSA-C22.2 No.14-05; CE marking<br>E29096<br>NLDX<br>012528<br>3211-04<br>UL Listed, CSA certified  |
| <b>DILM500-S/22(220-240V50/60Hz)</b><br>274199                | 1 off                   |    | Product Standards<br>UL File No.<br>UL CCN<br>CSA File No.<br>CSA Class No.<br>NA Certification<br>See also | IEC/EN 60947-4-1; UL 508; CSA-C22.2 No.14-05; CE marking<br>E29096<br>NLDX<br>012528<br>3211-04<br>UL Listed, CSA certified  |
| <b>DILM570-S/22(220-240V50/60Hz)</b><br>110744                | 1 off                   |  | See also  | Additional approvals, → Page 82  |

# 1.1

## Contactors DILM, DILH

Comfort devices greater than 150 A

1

### DILM, DILH

Rated operational current

Max. motor rating for three-phase motors 50 - 60 Hz

Conventional thermal current  $I_{th} = I_e$   
AC-1 at 60 °C

Circuit symbol

| AC-3<br>380 V<br>400 V<br>$I_e$<br>A | AC-3           |                |                | AC-4   |                |                | Open<br>$I_{th} = I_e$ | A  |
|--------------------------------------|----------------|----------------|----------------|--------|----------------|----------------|------------------------|----|
|                                      | 220 V<br>230 V | 380 V<br>400 V | 660 V<br>690 V | 1000 V | 220 V<br>230 V | 380 V<br>400 V |                        |    |
|                                      | P              | <b>P</b>       | P              | P      | P              | <b>P</b>       | P                      | P  |
|                                      | kW             | <b>kW</b>      | kW             | kW     | kW             | <b>kW</b>      | kW                     | kW |

#### Contactors, comfort DILM

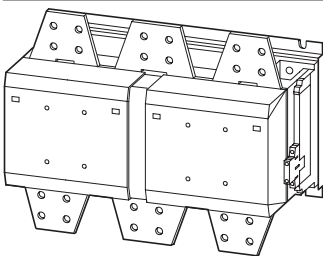
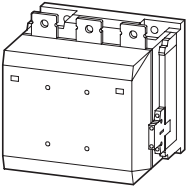
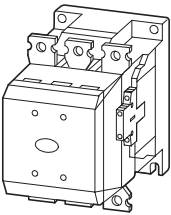
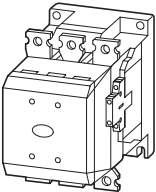
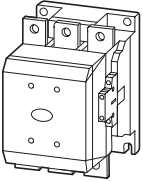

|             |     |            |      |      |     |            |      |      |      |  |
|-------------|-----|------------|------|------|-----|------------|------|------|------|--|
| <b>185</b>  | 55  | <b>90</b>  | 140  | 108  | 41  | <b>75</b>  | 102  | 77   | 275  |  |
| <b>225</b>  | 70  | <b>110</b> | 150  | 108  | 51  | <b>90</b>  | 110  | 77   | 315  |  |
| <b>250</b>  | 75  | <b>132</b> | 195  | 108  | 62  | <b>110</b> | 160  | 109  | 330  |  |
| <b>300</b>  | 90  | <b>160</b> | 195  | 132  | 75  | <b>132</b> | 160  | 109  | 350  |  |
| <b>400</b>  | 125 | <b>200</b> | 344  | 132  | 92  | <b>160</b> | 283  | 132  | 500  |  |
| <b>500</b>  | 155 | <b>250</b> | 344  | 132  | 112 | <b>200</b> | 344  | 132  | 700  |  |
| <b>580</b>  | 185 | <b>315</b> | 560  | 600  | 143 | <b>250</b> | 440  | 509  | 800  |  |
| <b>650</b>  | 205 | <b>355</b> | 630  | 600  | 161 | <b>280</b> | 494  | 509  | 850  |  |
| <b>750</b>  | 240 | <b>400</b> | 720  | 800  | 181 | <b>315</b> | 556  | 678  | 900  |  |
| <b>820</b>  | 260 | <b>450</b> | 750  | 800  | 209 | <b>355</b> | 633  | 678  | 1000 |  |
| <b>1000</b> | 315 | <b>560</b> | 1000 | 1100 | 260 | <b>450</b> | 780  | 1000 | 1000 |  |
| <b>1600</b> | 500 | <b>900</b> | 1600 | 1770 | 430 | <b>750</b> | 1300 | 1650 | 1800 |  |

#### Notes

<sup>1)</sup> Availability from August 2010.

Previous DILM185/22 to DILM300/22, see Online Catalog at <http://www.eaton.com/seasia-electrical>

For all contactors the following applies:

- 660 V, 690 V or 1000 V: do not reverse directly
- Integrated suppressor circuit in actuating electronics.

When operating contactors DILM580 to DILM1600 behind a frequency inverter or mains with strong harmonic loads, the suppressor circuit on the load side must be removed.

During high-voltage tests, the suppressor circuit on the load-side for DILM580 to DILH2600 contactors must be disconnected (see instructional leaflet).

Control voltages

RA250  $\hat{=}$  110 V - 250 V AC/DC

RAW250  $\hat{=}$  230 V - 250 V AC/DC

#### Accessories

Auxiliary contact modules

Suppressor circuits on load side

Enclosures

Further actuating voltages

#### Page

→ 38

→ 61

**totally insulated**

→ 72



**Part no.**  
Article no.

**Price**  
See price list

**Std. pack**

**Notes**

**DILM185A/22(RAC240)**<sup>1)</sup>  
139537



**Conventional**  
A1/A2 are attached to power supply as normal

DILM 185 A, DILM 225 A

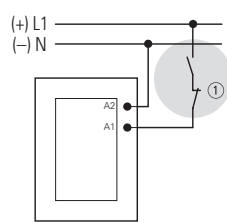

DILM250 to DILM1000, DILH1400

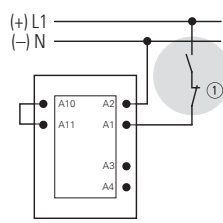

DILM1600 to DILH 2600

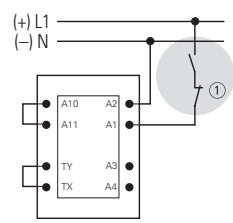

**DILM250/22(RA250)**<sup>2)</sup>  
208201

**DILM300A/22(RA250)**<sup>1) 2)</sup>  
139556

**Directly from the PLC**  
A 24 V output from the PLC can be directly connected to the terminals A4/A24.

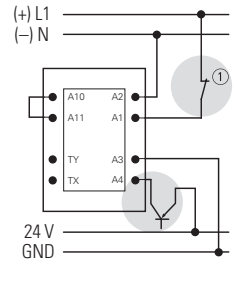
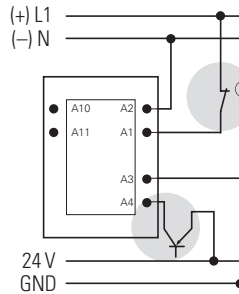
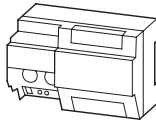

**DILM400/22(RA250)**<sup>3)</sup>  
208209

**DILM500/22(RA250)**<sup>3)</sup>  
208213

**From a low-power command device**

Low-power actuating devices such as PCB relays, pilot devices or position switches can be directly connected to A10/A11.

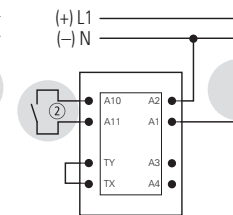
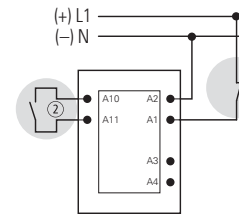

**DILM580/22(RA250)**<sup>3)</sup>  
208216

**DILM650/22(RA250)**<sup>3)</sup>  
208219

**DILM750/22(RA250)**<sup>3)</sup>  
208222

**DILM820/22(RA250)**<sup>3)</sup>  
208225

**DILM1000/22(RA250)**<sup>3)</sup>  
267214

**DILM1600/22(RAW250)**<sup>3)</sup>  
106727

- ① Stopping in the event of an emergency (emergency switching off)
- ② Max. cable capacitance 6 nF

**Information relevant for export to North America**



- 1)  
NA Certification Request filed for UL and CSA
- 2)  
Product Standards IEC/EN 60947-4-1; UL 508; CSA-C22.2 No.14-05; CE marking  
UL File No. E29096  
UL CCN NLDX  
CSA File No. 1017510  
CSA Class No. 3211-04  
NA Certification UL Listed, CSA certified
- 3)  
Product Standards IEC/EN 60947-4-1; UL 508; CSA-C22.2 No.14-05; CE marking  
UL File No. E29096  
UL CCN NLDX  
CSA File No. 012528  
CSA Class No. 3211-04  
NA Certification UL Listed, CSA certified  
See also Additional approvals, → Page 82

# 1.1

## Contactors DILM, DILH Comfort devices greater than 150 A

1

### DILM, DILH

Conventional thermal current  $I_{th} = I_e$   
AC-1 at 60 °C

Open

$I_{th} = I_e$

A

Circuit symbol

**Part no.**  
Article no.

**Price**  
See price  
list

Std. pack

DILH comfort devices AC-1

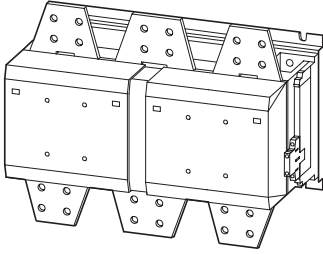

|      |  |   |           |
|------|--|---|-----------|
| 1400 |  | <b>DILH1400/22(RAW250)<sup>1)</sup></b><br>272441 | 1 off<br> |
| 2000 |  | <b>DILH2000/22(RAW250)<sup>1)</sup></b><br>272442 | 1 off<br> |
| 2200 |  | <b>DILH2200/22(RAW250)<sup>1)</sup></b><br>111793 | 1 off<br> |
| 2600 |  | <b>DILH2600/22(RAW250)<sup>2)</sup></b><br>125945 | 1 off<br> |

#### Notes

For all contactors the following applies:

- 660 V, 690 V or 1000 V: do not reverse directly
- Integrated suppressor circuit in actuating electronics.

When operating contactors DILM580 to DILM1600 behind a frequency inverter or mains with strong harmonic loads, the suppressor circuit on the load side must be removed.

During high-voltage tests, the suppressor circuit on the load-side for DILM580 to DILH2600 contactors must be disconnected (see instructional leaflet).

Control voltages

RAW250  $\pm$  230 V - 250 V AC/DC

#### Accessories

Auxiliary contact modules

#### Page

→ 38

Suppressor circuits on load side

→ 61

Enclosures

**totally insulated**

**Notes**

**Conventional**

A1/A2 are attached to power supply as normal

DILH1400

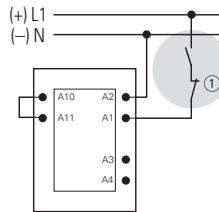

DILM1600 to DILH 2600

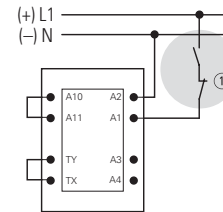

**Directly from the PLC**

A 24 V output from the PLC can be directly connected to the terminals A4/A24.

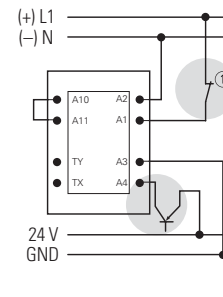
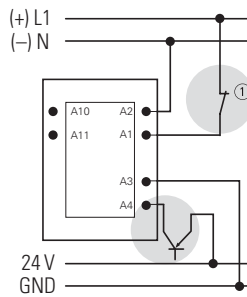
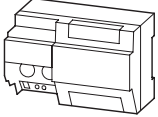

**From a low-power command device**

Low-power actuating devices such as PCB relays, pilot devices or position switches can be directly connected to A10/A11.

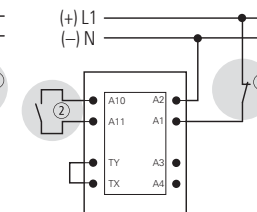
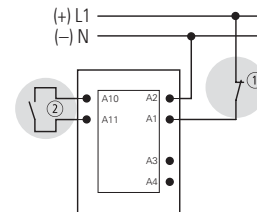

- ① Stopping in case of emergency (Emergency-stop)
- ② Max. cable capacitance 6 nF

**Information relevant for export to North America**



1)

|                   |  |
|-------------------|--|
| Product Standards | IEC/EN 60947-4-1; UL 508; CSA-C22.2 No.14-05; CE marking |
| UL File No.       | E29096   |
| UL CCN            | NLDX   |
| CSA File No.      | 012528   |
| CSA Class No.     | 3211-04  |
| NA Certification  | UL Listed, CSA certified                                 |

2)

|                  |                              |
|------------------|------------------------------|
| NA Certification | Request filed for UL and CSA |
|------------------|------------------------------|

# 1.1

## Leistungsschütze

Basic devices up to 200 A

1

### DILMP 4 pole

Rated operational current open

Conventional thermal current

Circuit symbol

For use with

AC-1

$I_{th} = I_e$  AC-1 at 50 °C

Open

40 °C      55 °C      70 °C

$I_{th} = I_e$

| A  | A  | A  | A  |
|----|----|----|----|
| 22 | 21 | 30 | 20 |

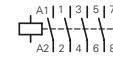

DILM32-XHI(C)...  
DILA-XHI(V)(C)...

Contactors up to 200 A  
4 pole

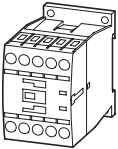

### Notes

<sup>1)</sup> DILM1000-XHI... can only be fitted on the left of DILMP.

Contacts to EN 50012.

For DC operated contactors DILMP20 the following applies:

- Integrated varistor suppressor circuit.

For DC operated contactors DILMP32 - DILMP200 the following applies:

- Integrated suppressor circuit in actuating electronics.

For AC operated contactors DILMP125 - DILMP200 the following applies:

- Integrated suppressor circuit in actuating electronics.

For DILMP32-01 and DILMP45-01 the following applies:

- With mirror contact.

**AC operation**

**Part no.**  
Article no.

**Price**  
See price list

Std. pack

**DC operation**

**Part no.**  
Article no.

**Price**  
See price list

Std. pack

**Notes**

**DILMP20(230V50Hz,240V60Hz)**  
276970

1 off 

**DILMP20(24VDC)**  
276985

1 off 

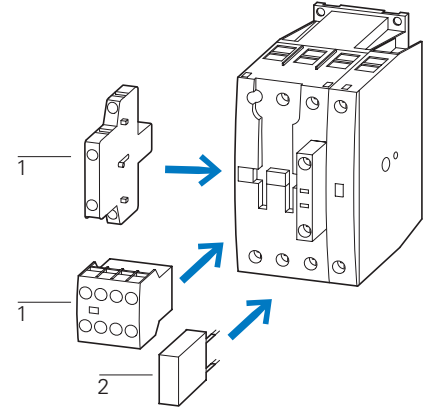

**Accessories**

- 1 Auxiliary contact module
- 2 Suppressor
- Further actuating voltages
- Accessories

- Page**
- 36
  - 50
  - 74
  - 52









































**Information relevant for export to North America**



|                   |  |
|-------------------|--|
| Product Standards | IEC/EN 60947-4-1; UL 508; CSA-C22.2 No.14-05; CE marking |
| UL File No.       | E29096   |
| UL CCN            | NLDX   |
| CSA File No.      | 012528   |
| CSA Class No.     | 2411-03, 3211-04   |
| NA Certification  | UL Listed, CSA certified                                 |
| See also          | → Page 81  |

#### DILM, DILA Auxiliary contact modules

With interlocked opposing contacts, except ...XHI(C)V

| Terminal type  | Pole   | Conventional thermal current<br>$I_{th} = I_e$<br>AC-1 at 60 °C<br><br>Open<br>$I_{th} = I_e$<br>A | Contact configuration                           | Circuit symbol  | For use with   | Part no.<br>Article no.        | Price<br>See price list | Std. pack  |
|--|--------|--|---|---|--|--------------------------------|-------------------------|--|
| <br>Top mounting auxiliary contacts<br>Screw terminals           | 2 pole | 16   | 1 N/O 1 NC                                      |    | DILM(C)7-10...<br>DILM(C)9-10...   | <b>DILM32-XHI11</b><br>277376  |                         | 5 off<br>   |
|  | 2 pole | 16   | — 1 NC  |    | DILM(C)12-10...<br>DILM(C)15-10...<br>DILM(C)17-10...<br>DILM(C)25-10...<br>DILM(C)32-10...<br>DILM38-...10<br>DILMP20...<br>DILMP32-10...<br>DILMP45-10...<br>DILL...       | <b>DILM32-XHI02</b><br>277375  |                         | 5 off<br>   |
| <br>Top mounting auxiliary contacts<br>Screw terminals           | 4 pole | 16   | 2 N/O 2 NC                                      |    |  | <b>DILM32-XHI22</b><br>277377  |                         | 5 off<br>   |
|  | 4 pole | 16   | 3 N/O 1 NC                                      |    |  | <b>DILM32-XHI31</b><br>106112  |                         | 5 off<br>   |
| <br>Top mounting auxiliary contacts<br>Spring-loaded terminals   | 2 pole | 16   | 1 N/O 1 NC                                      |    |  | <b>DILM32-XHIC11</b><br>277751 |                         | 5 off<br>   |
|  | 2 pole | 16   | — 2 NC  |   |  | <b>DILM32-XHIC02</b><br>277750 |                         | 5 off<br>   |
| <br>Top mounting auxiliary contacts<br>Spring-loaded terminals | 4 pole | 16   | 2 N/O 2 NC                                      |  |  | <b>DILM32-XHIC22</b><br>277752 |                         | 5 off<br> |
| <br>Top mounting auxiliary contacts<br>Screw terminals         | 2 pole | 16   | 1 N/O —   |  | DILM(C)9...<br>DILM(C)9...<br>DILM(C)12...<br>DILM(C)15...<br>DILM(C)17...<br>DILM(C)25...<br>DILM(C)32...<br>DILM38...<br>DILMP20...<br>DILMP32...<br>DILMP45...<br>DILL... | <b>DILA-XHI20</b><br>276422    |                         | 5 off<br> |
|  | 2 pole | 16   | 1 N/O 1 NC                                      |  |  | <b>DILA-XHI11</b><br>276421    |                         | 5 off<br> |
|  | 2 pole | 16   | — 2 NC  |  |  | <b>DILA-XHI02</b><br>276420    |                         | 5 off<br> |
|  | 2 pole | 16   | 1 S <sub>F</sub> 1 Ö <sub>S</sub>               |  |  | <b>DILA-XHIV11</b><br>276423   |                         | 5 off<br> |
| <br>Top mounting auxiliary contacts<br>Screw terminals         | 4 pole | 16   | 4 N/O —   |  |  | <b>DILA-XHI40</b><br>276428    |                         | 5 off<br> |
|  | 4 pole | 16   | 3 N/O 1 NC                                      |  |  | <b>DILA-XHI31</b><br>276427    |                         | 5 off<br> |
|  | 4 pole | 16   | 2 N/O 2 NC                                      |  |  | <b>DILA-XHI22</b><br>276426    |                         | 5 off<br> |
|  | 4 pole | 16   | 1 N/O 3 NC                                      |  |  | <b>DILA-XHI13</b><br>276425    |                         | 5 off<br> |
|  | 4 pole | 16   | — 4 NC  |  |  | <b>DILA-XHI04</b><br>276424    |                         | 5 off<br> |
|  | 4 pole | 16   | 1 N/O 1 NC<br>1 S <sub>F</sub> 1 Ö <sub>S</sub> |  |  | <b>DILA-XHIV22</b><br>276429   |                         | 5 off<br> |

#### Notes



- Auxiliary NC usable as mirror contact according to IEC/EN 60947-4-1, Annex F
- Interlocked opposing contacts according to IEC/EN 60947-5-1 Annex L, inside the auxiliary contact modules, also for the integrated auxiliary contacts of the DILM 7 - DILM32

#### Information relevant for export to North America

|   |                   |   |
|---|-------------------|---|
|  | Product Standards | IEC/EN 60947-4-1; UL 508;<br>CSA-C22.2 No.14-05; CE marking |
|   | UL File No.       | E29184  |
|   | UL CCN            | NKCR  |
|   | CSA File No.      | 012528  |
|   | CSA Class No.     | 3211-03   |
|   | NA Certification  | UL Listed, CSA certified                                    |

**DILM, DILA**  
**Auxiliary contact modules**

With interlocked opposing contacts, except ...XHI(C)V

| Terminal type  | Pole   | Conventional thermal current<br>$I_{th} = I_e$<br>AC-1 at 60 °C<br><br>Open<br>$I_{th} = I_e$<br>A | Contact configuration     | Circuit symbol           | For use with   | Part no.<br>Article no.                   | Price<br>See price list | Std. pack |
|--|--------|--|---------------------------|--------------------------|--|---|-------------------------|-----------|
|  <p>Top mounting auxiliary contacts<br/>Spring-loaded terminals</p>   | 2 pole | 16   | 2 N/O                     | —                        | DILM(C)7...<br>DILM(C)9...<br>DILM(C)12...<br>DILM(C)15...<br>DILM(C)17...<br>DILM(C)25...<br>DILM(C)32...<br>DILM38...<br>DILMP20...<br>DILMP32...<br>DILMP45...<br>DILL... | <b>DILA-XHIC20</b><br>276528              | 5 off                   |           |
|  | 2 pole | 16   | 1 N/O                     | 1 NC                     |  | <b>DILA-XHIC11</b><br>276527              | 5 off                   |           |
|  | 2 pole | 16   | —                         | 2 NC                     |  | <b>DILA-XHIC02</b><br>276526              | 5 off                   |           |
|  | 2 pole | 16   | 1 S <sub>F</sub>          | 1 Ö <sub>S</sub>         |  | <b>DILA-XHICV11</b><br>276529             | 5 off                   |           |
|  <p>Top mounting auxiliary contacts<br/>Screw terminals</p>           | 2 pole | 16   | 2 N/O                     | 2 NC                     |  | <b>DILA-XHIR22<sup>1)</sup></b><br>139580 | 5 off                   |           |
|  | 2 pole | 16   | 1 N/O                     | 1 NC                     |  | <b>DILA-XHIR11</b><br>110140              | 5 off                   |           |
|  <p>Top mounting auxiliary contacts<br/>Spring-loaded terminals</p> | 4 pole | 16   | 4 N/O                     | —                        | DILM(C)9...<br>DILM(C)9...<br>DILM(C)12...<br>DILM(C)15...<br>DILM(C)17...<br>DILM(C)25...<br>DILM(C)32...   | <b>DILA-XHIC40</b><br>276534              | 5 off                   |           |
|  | 4 pole | 16   | 3 N/O                     | 1 NC                     |  | <b>DILA-XHIC31</b><br>276533              | 5 off                   |           |
|  | 4 pole | 16   | 2 N/O                     | 2 NC                     |  | <b>DILA-XHIC22</b><br>276532              | 5 off                   |           |
|  | 4 pole | 16   | 1 N/O                     | 3 NC                     |  | <b>DILA-XHIC13</b><br>276531              | 5 off                   |           |
|  | 4 pole | 16   | —                         | 4 NC                     |  | <b>DILA-XHIC04</b><br>276530              | 5 off                   |           |
|  | 4 pole | 16   | 1 N/O<br>1 S <sub>F</sub> | 1 NC<br>1 Ö <sub>S</sub> |  | <b>DILA-XHICV22</b><br>276535             | 5 off                   |           |

**Notes**

- Auxiliary NC usable as mirror contact according to IEC/EN 60947-4-1, Annex F
- Interlocked opposing contacts according to IEC/EN 60947-5-1 Annex L, inside the auxiliary contact modules, also for the integrated auxiliary contacts of the DILM 7 - DILM32

<sup>1)</sup> 1 N/C + 1 N/O above microswitch for electronic applications

































**Information relevant for export to North America**

|  |                   |   |
|--|-------------------|---|
|  | Product Standards | IEC/EN 60947-4-1; UL 508;<br>CSA-C22.2 No.14-05; CE marking |
|  | UL File No.       | E29184  |
|  | UL CCN            | NKCR  |
|  | CSA File No.      | 012528  |
|  | CSA Class No.     | 3211-03   |
|  | NA Certification  | UL Listed, CSA certified                                    |

<sup>1)</sup> NA Certification Request filed for UL and CSA

#### DILM Auxiliary contact modules

With interlocked opposing contacts

| Connection type  | Pole            | conventional thermal current<br>$I_{th} = I_e$<br>AC-1 at 60 °C<br>Open<br>$I_{th} = I_e$<br>A | Contact configuration<br>N/O = normally open contact<br>SF = N/O early make<br>NC = normally closed contact<br>ÖS = NC late-break | Circuit symbol          | For use with  | Part no.<br>Article no.   | Price<br>See price list  | Std. pack  | Notes   |
|--|-----------------|--|---|-------------------------|---|---|--|--|---|
|    | Screw terminals | 2 pole   | 16  | 2 N/O –                 |    | DILM40...<br>DILM50...<br>DILM65...<br>DILM72...<br>DILM80...<br>DILM95...<br>DILM115...<br>DILM150...<br>DILM170...<br>DILMP63...<br>DILMP80...<br>DILMP125...<br>DILMP160...<br>DILMP200... | <b>DILM150-XHI20</b><br>277945   | 5 off<br> | Interlocked opposing contacts according to IEC/EN 60947-5-1 Annex L, inside the auxiliary contact modules<br>Auxiliary NC usable as mirror contact according to IEC/EN 60947-4-1, Annex F |
|  |                 | 2 pole   | 16  | 1 N/O 1 NC              |    | <b>DILM150-XHI11</b><br>277946  | 5 off<br>   |  |   |
|  |                 | 2 pole   | 16  | 1 N/O 1 NC              |    | <b>DILM150-XHIA11</b><br>283463   | 5 off<br>   |  |   |
|  |                 | 2 pole   | 16  | – 2 NC                  |    | <b>DILM150-XHI02</b><br>277947  | 5 off<br>   |  |   |
|   | Screw terminals | 4 pole   | 16  | 4 N/O –                 |    | <b>DILM150-XHI40</b><br>277948  | 5 off<br>   |  |   |
|  |                 | 4 pole   | 16  | 3 N/O 1 NC              |   | <b>DILM150-XHI31</b><br>277949  | 5 off<br>   |  |   |
|  |                 | 4 pole   | 16  | 2 N/O 2 NC              |  | <b>DILM150-XHI22</b><br>277950  | 5 off<br> |  |   |
|  |                 | 4 pole   | 16  | 2 N/O 2 NC              |  | <b>DILM150-XHIA22</b><br>283464   | 5 off<br> |  |   |
|  |                 | 4 pole   | 16  | 1 N/O 3 NC              |  | <b>DILM150-XHI13</b><br>277951  | 5 off<br> |  |   |
|  |                 | 4 pole   | 16  | – 4 NC                  |  | <b>DILM150-XHI04</b><br>277952  | 5 off<br> |  |   |
|  |                 | 4 pole   | 16  | 1 N/O 1 NC<br>1 SF 1 ÖS |  | <b>DILM150-XHIV22</b><br>277953   | 5 off<br> |  |   |
|  |                 |              | Screw terminals   | 2 pole                  | 16  | 2 N/O –   |             |  | DILA-XHIT20<br>101042   |
| 2 pole   | 16              |  |   | 1 N/O 1 NC              |  | <b>DILA-XHIT11</b><br>101043  | 5 off<br> |  |   |
| 2 pole   | 16              |  |   | – 2 NC                  |  | <b>DILA-XHIT02</b><br>101041  | 5 off<br> |  |   |
|  | Screw terminals | 4 pole   | 16  | 2 N/O 2 NC              |  | <b>DILA-XHIT22</b><br>101044  | 5 off<br> |  |   |

**Notes** 1) Suitable for the combination with electrical wiringlinks in tool-less plug connection usable with:

- DILM12-XSL
- DILM12-XRL
- DILM12-XS1
- PKZM0-XDM12
- PKZM0-XRM12
- PKZM0-XSM12

- 1 PKZM0
- 2 DILM7 - DILM15
- 3 DILA-XHIT
- 4 PKZM0-XDM12

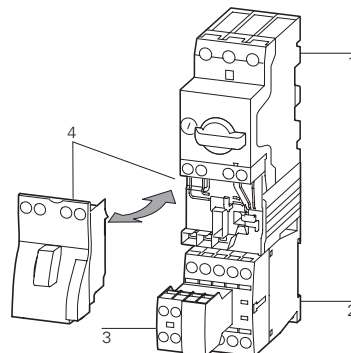

#### Information relevant for export to North America



Product Standards

IEC/EN 60947-4-1; UL 508;  
CSA-C22.2 No.14-05; CE marking

UL File No.

E29184

UL CCN

NKCR

CSA File No.

012528

CSA Class No.











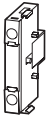























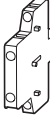

3211-03

NA Certification

UL Listed, CSA certified



### DILM, DILA

| Connection type  | Pole                    | conventional thermal current<br>$I_{th} = I_e$<br>AC-1 at 60 °C<br>Open<br>$I_{th} = I_e$<br>A | Contact configuration<br>N/O = normally open contact<br>SF = N/O early make<br>NC = normally closed contact<br>ÖS = NC late-break | Circuit symbol | For use with  | Part no.<br>Article no.  | Price<br>See price list             | Std. pack  | Notes   |
|--|-------------------------|--|---|----------------|---|--|-------------------------------------|--|---|
| <b>Side-mounting auxiliary contacts</b><br>   | Screw terminals         | 1 pole   | 10  | 1 N/O –        |    | DILM(C)7...<br>DILM(C)9...<br>DILM(C)12...<br>DILM(C)15...<br>DILMP20...<br>DILA(C)... | <b>DILA-XHI10-S</b><br>115948       | 1 off<br>      | 1)<br>  |
|  |                         | 1 pole   | 10  | – 1 NC         |    |  | <b>DILA-XHI01-S</b><br>115949       | 1 off<br>      |   |
|  | Spring-loaded terminals | 1 pole   | 10  | 1 N/O –        |    |  | <b>DILA-XHIC10-S</b><br>115950      | 1 off<br>      |   |
|  |                         | 1 pole   | 10  | – 1 NC         |    |  | <b>DILA-XHIC01-S</b><br>115951      | 1 off<br>      |   |
| <b>Side-mounting auxiliary contacts</b><br>  | Screw terminals         | 2 pole   | 10  | 1 N/O 1 NC     |    | DILM17...<br>DILM25...<br>DILM32...<br>DILM38...                                       | <b>DILM32-XHI11-S</b><br>101371     | 1 off<br>      | Can only be left on the contactor. Cannot be combined with mechanical interlock |
| <b>Side-mounting auxiliary contacts</b><br> | Screw terminals         | 2 pole   | 10  | 1 N/O 1 NC     |  | DILM250 -<br>DILH2600  | <b>DILM820-XHI11-SI</b><br>208281   | 1 off<br>  | 1)<br>  |
|  |                         | 2 pole   | 10  | 1 N/O 1 NC     |  |  | <b>DILM820-XHI11-SA</b><br>208282   | 1 off<br>  |   |
|  |                         | 2 pole   | 10  | 1 SF 1 ÖS      |  |  | <b>DILM820-XHI11V-SI</b><br>208283  | 1 off<br>  |   |
| <b>Side-mounting auxiliary contacts</b><br> | Screw terminals         | 2 pole   | 10  | 1 N/O 1 NC     |  | DILM40 -<br>DILM225A<br>DILMP63 -<br>DILMP200  | <b>DILM1000-XHI11-SI</b><br>278425  | 1 off<br>  |   |
|  |                         | 2 pole   | 10  | 1 SF 1 ÖS      |  |  | <b>DILM1000-XHIV11-SI</b><br>278426 | 1 off<br>  |   |
|  |                         | 2 pole   | 10  | 1 N/O 1 NC     |  |  | <b>DILM1000-XHI11-SA</b><br>278427  | 1 off<br>  |   |

**Notes**

- 1)
  - Interlocked opposing contacts according to IEC/EN 60947-5-1 Annex L, inside the auxiliary contact module, also for the integrated auxiliary contacts of the DILM7 – DILM32 (not NO early-make and NC late-break)
  - Auxiliary NC usable as mirror contact according to IEC/EN 60947-4-1, Annex F (no NC late-breaks)
  - No auxiliary contact is possible between 2 contactors with mechanical interlock.

**Information relevant for export to North America**

2)

Product Standards

UL File No.

UL CCN

CSA File No.

CSA Class No.

NA Certification

 IEC/EN 60947-4-1; UL 508;  
 CSA-C22.2 No.14-05; CE marking  
 E29184  
 NKCR  
 012528  
 3211-03,3211-04  
 UL Listed, CSA certified

# 1.1

## Contactors

### Auxiliary contact modules

#### 1 Engineering

#### DILM, DILH

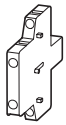

DILM1000-  
XHI(V)11-SI

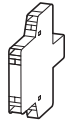

DILM820-  
XHI(V)11-SI



DILM1000-  
XHI(V)11-SA



DILM820-  
XHI(V)11-SA



DILM150-XHI20  
DILM150-XHI11  
DILM150-XHI02



DILM150-XHI40  
DILM150-XHI31  
DILM150-  
XHI(V)22  
DILM150-XHI13  
DILM150-XHI04



DILM150-  
XHIA11



DILM150-  
XHIA22

|                     |     |     |     |     |     |     |     |     |
|---------------------|-----|-----|-----|-----|-----|-----|-----|-----|
| DILM40              | 2 x | -   | -   | -   | -   | -   | 1 x | -   |
| ...<br>DILM72       | -   | -   | 2 x | -   | 1 x | -   | -   | -   |
|                     | 1 x | -   | -   | -   | -   | -   | -   | 1 x |
|                     | -   | -   | 1 x | -   | -   | 1 x | -   | -   |
| DILM80              | 2 x | -   | 2 x | -   | -   | -   | -   | -   |
| ...<br>DILM170      | 2 x | -   | -   | -   | -   | -   | -   | 1 x |
|                     | 2 x | -   | -   | -   | -   | -   | 1 x | -   |
|                     | -   | -   | 2 x | -   | -   | 1 x | -   | -   |
|                     | -   | -   | 2 x | -   | 1 x | -   | -   | -   |
| DILM185A            | 2 x | -   | 2 x | -   | -   | -   | -   | -   |
| DILM222A            | 2 x | -   | -   | -   | -   | -   | -   | -   |
| DILM250<br>DILM1600 | -   | 2 x | -   | 2 x | -   | -   | -   | -   |
| DILH1400            | -   | 2 x | -   | 2 x | -   | -   | -   | -   |
| ...<br>DILH2600     | -   | -   | -   | -   | -   | -   | -   | -   |

#### Notes

#### Side mounting auxiliary contacts

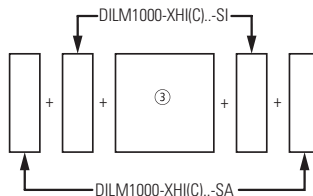
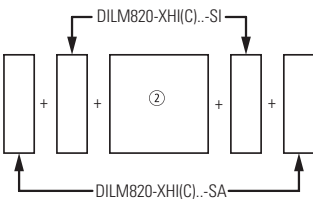
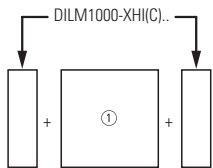

- ① DILM40 – DILM72
- ② DILM250 – DILH2600
- ③ DILM80-DILM225A

- Interlocked opposing contacts according to IEC/EN 60947-5-1 Annex L, inside the auxiliary contact module (not N/O early close and N/C late open)
- Auxiliary contacts can be used as mirror contacts according to IEC/EN 60947-4-1, Annex F (not N/C late open)
- No auxiliary contact is possible between two contactors with mechanical interlock.
- 2 auxiliary contacts DILM820-XHI11-SI are already built into the contactors DILM250 to DILH2600/22.
- 2 DILM1000-XHI11-SI auxiliary contacts are already installed in DILM185A and DILH225A contactors.

### Ordering

#### DILK

Three-phase capacitors  
50 – 60 Hz  
Open

Circuit symbol

**Part no.**  
Article no.

**Price**  
See price list

Std. pack

|       |       |       |       |
|-------|-------|-------|-------|
| 230 V | 400 V | 525 V | 690 V |
|-------|-------|-------|-------|

|      |      |      |      |
|------|------|------|------|
| kvar | kvar | kvar | kvar |
|------|------|------|------|

|     |      |      |    |
|-----|------|------|----|
| 7.5 | 12.5 | 16.7 | 20 |
|-----|------|------|----|

|    |    |    |      |
|----|----|----|------|
| 11 | 20 | 25 | 33.3 |
|----|----|----|------|



|    |    |      |    |
|----|----|------|----|
| 15 | 25 | 33.3 | 40 |
|----|----|------|----|

|    |      |    |    |
|----|------|----|----|
| 20 | 33.3 | 40 | 55 |
|----|------|----|----|

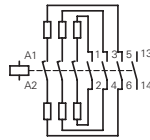
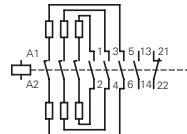
|    |    |    |    |
|----|----|----|----|
| 25 | 50 | 65 | 85 |
|----|----|----|----|



**DILK12-11(230V50Hz,240V60Hz)**  
293988 1 off  

**DILK20-11(230V50Hz,240V60Hz)**  
294010 1 off  

**DILK25-11(230V50Hz,240V60Hz)**  
294032 1 off  

**DILK33-10(230V50Hz,240V60Hz)**  
294054 1 off  

**DILK50-10(230V50Hz,240V60Hz)**  
294076 1 off  

#### With series resistors Basic Units

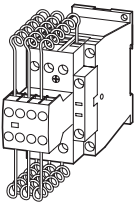

#### Notes

Weld-resistant for capacitors with inrush current peaks up to  $180 \times I_N$

With group compensation multi-stage capacitor banks are connected to the mains as required. This can cause, transient currents of up to  $180 \times I_e$  to flow between the capacitors.

The capacitors are pre-charged via the early-make auxiliary contacts and the fitted wire resistors, thereby reducing the inrush current. The main contacts then close after a time lag and carry the continuous current.

The contactors for capacitors are weld-resistant with inrush current peaks up to  $180 \times I_e$  due to their special contacts.

DILK... cannot be combined with other auxiliary contacts.

For the switching of reactive-power compensation equipment please see Engineering notes on power factor correction → page 33.

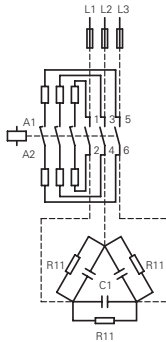

#### Accessories Page

|                            |   |      |
|----------------------------|---|------|
| Enclosures                 |  |      |
| Accessories                |   | → 52 |
| Further actuating voltages |   | → 76 |

#### Information relevant for export to North America



|                   |  |
|-------------------|--|
| Product Standards | IEC/EN 60947-4-1; UL 508; CSA-C22.2 No.14-05; CE marking |
| UL File No.       | E29096   |
| UL CCN            | NLDX   |
| CSA File No.      | 012528   |
| CSA Class No.     | 3211-04  |
| NA Certification  | UL Listed, CSA certified                                 |
| See also          | Further approvals → Page 66                              |

# 1.1

## Contactors

Contactors for power factor correction

### 1 Engineering

#### DILM, DILK

| Part no.   | Page     | Switching power |                         |       |       |
|--|----------|-----------------|-------------------------|-------|-------|
|  |          | 230 V           | 400 V<br>420 V<br>440 V | 525 V | 690 V |
| Ordering data  | Part no. | kvar            | kvar                    | kvar  | kvar  |
| <b>Individual compensation, open version</b>           |          |                 |                         |       |       |
| DILM7-...(...)   | → 18     | 1.5             | 3                       | 3.5   | 5     |
| DILM9-...(...)   | → 18     | 2               | 4                       | 4.5   | 6     |
| DILM12-...(...)  | → 18     | 2.5             | 4.5                     | 5.5   | 7     |
| DILM15-...(...)  | → 18     | 2.5             | 4.5                     | 5.5   | 7     |
| DILM17-...(...)  | → 18     | 6.5             | 12                      | 14.5  | 19    |
| DILM25-...(...)  | → 18     | 7               | 13.5                    | 16    | 21    |
| DILM32-...(...)  | → 18     | 7.5             | 14.5                    | 17    | 22.5  |
| DILM40(...)  | → 20     | 11              | 20.5                    | 24.5  | 32    |
| DILM50(...)  | → 20     | 11.5            | 22                      | 26    | 34.5  |
| DILM65(...)  | → 20     | 12.5            | 23.5                    | 28    | 37    |
| DILM80(...)  | → 20     | 16              | 30.5                    | 36.5  | 48    |
| DILM95(...)  | → 20     | 18              | 34                      | 41    | 54    |
| DILM115(...)   | → 20     | 24              | 46                      | 54.5  | 72    |
| DILM150(...)   | → 20     | 28              | 53                      | 63.5  | 83.5  |
| DILM185A(...)  | → 30     | 87              | 150                     | 190   | 150   |
| DILM300A(...)  | → 30     | 115             | 200                     | 265   | 200   |
| DILM580(...)   | → 30     | 175             | 300                     | 400   | 300   |
| <b>Group compensation, with choke, open version</b>    |          |                 |                         |       |       |
| DILM7-...(...)   | → 18     | 4               | 7                       | 7.5   | 12    |
| DILM9-...(...)   | → 18     | 5               | 8                       | 10    | 14    |
| DILM12-...(...)  | → 18     | 5.5             | 10                      | 12    | 16    |
| DILM15-...(...)  | → 18     | 5.5             | 10                      | 12    | 16    |
| DILM17-...(...)  | → 18     | 7.5             | 18                      | 20    | 28    |
| DILM25-...(...)  | → 18     | 10              | 20                      | 23    | 30    |
| DILM32-...(...)  | → 18     | 12.5            | 25                      | 25    | 32    |
| DILM40(...)  | → 20     | 15              | 30                      | 30    | 40    |
| DILM50(...)  | → 20     | 20              | 40                      | 40    | 48    |
| DILM65(...)  | → 20     | 25              | 50                      | 50    | 57    |
| DILM80(...)  | → 20     | 30              | 60                      | 70    | 90    |
| DILM95(...)  | → 20     | 35              | 70                      | 80    | 104   |
| DILM115(...)   | → 20     | 50              | 95                      | 100   | 125   |
| DILM150(...)   | → 20     | 55              | 115                     | 115   | 152   |
| DILM185A(...)  | → 30     | 80              | 150                     | 200   | 260   |
| DILM225A(...)  | → 30     | 100             | 175                     | 230   | 300   |
| DILM250(...)   | → 30     | 110             | 190                     | 260   | 340   |
| DILM300A(...)  | → 30     | 130             | 225                     | 290   | 390   |
| DILM400(...)   | → 30     | 160             | 280                     | 370   | 480   |
| DILM500(...)   | → 30     | 220             | 390                     | 500   | 680   |
| <b>Group compensation, without choke, open version</b> |          |                 |                         |       |       |
| DILK12-...(...)  | → 41     | 7.5             | 12.5                    | 16.7  | 20    |
| DILK20-...(...)  | → 41     | 11              | 20                      | 25    | 33.3  |
| DILK25-...(...)  | → 41     | 15              | 25                      | 33.3  | 40    |
| DILK33-...(...)  | → 41     | 20              | 33.3                    | 40    | 55    |
| DILK50-...(...)  | → 41     | 25              | 50                      | 65    | 85    |
| DILM185A(...)  | → 30     | 66              | 115                     | 145   | 115   |
| DILM300A(...)  | → 30     | 85              | 150                     | 195   | 150   |
| DILM580(...)   | → 30     | 145             | 250                     | 333   | 250   |

#### Notes

##### Use of the contactors DILM without series resistor for group compensation

When using the contactors for group compensation in a system without chokes each capacitor must have a minimum induction of approx. 6 µH to limit the peak inrush current. This corresponds to an air-cored coil with 5 windings and a coil diameter of approximately Ø 140 mm. The conductor cross section must correspond to the rated operational current.

# 1.1

## Contactor combinations

Star-delta combinations

### Ordering

1

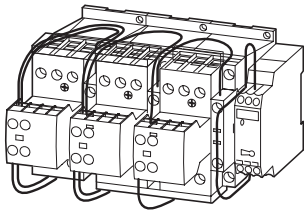
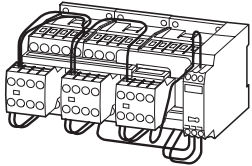
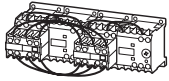

### Star-delta combinations SDAINL

Operating frequency: maximum 30 starts per hour

| Rated operational current<br>AC-3 | Max. rated operational power for<br>three-phase motors, 50 - 60 Hz |         |         |         |         | Max.<br>change-<br>over time<br>s | Part no.<br>Article no.               | Price<br>See price<br>list | Std.<br>pack |
|-----------------------------------|--|---------|---------|---------|---------|-----------------------------------|---------------------------------------|----------------------------|--------------|
|                                   | 400 V  | 230 V   | 400 V   | 500 V   | 690 V   |                                   |                                       |                            |              |
| $I_e$<br>A                        | P<br>kW  | P<br>kW | P<br>kW | P<br>kW | P<br>kW |                                   |                                       |                            |              |
| 12                                | 4  | 5.5     | 5.5     | –       | –       | < 30                              | <b>SDAINLEM(230V50Hz)</b><br>051840   | 1 off                      |              |
| 12                                | 3  | 5.5     | 5.5     | 5.5     | –       | < 20                              | <b>SDAINLM12(230V50Hz)</b><br>278286  | 1 off                      |              |
| 12                                | 3  | 5.5     | 5.5     | 5.5     | –       | < 20                              | <b>SDAINLM12(400V50Hz)</b><br>101380  | 1 off                      |              |
| 12                                | 3  | 5.5     | 5.5     | 5.5     | –       | < 20                              | <b>SDAINLM12(24VDC)</b><br>100416     | 1 off                      |              |
| 16                                | 4  | 7.5     | 7.5     | 7.5     | –       | < 20                              | <b>SDAINLM16(230V50Hz)</b><br>278311  | 1 off                      |              |
| 16                                | 4  | 7.5     | 7.5     | 7.5     | –       | < 20                              | <b>SDAINLM16(400V50Hz)</b><br>101381  | 1 off                      |              |
| 16                                | 4  | 7.5     | 7.5     | 7.5     | –       | < 20                              | <b>SDAINLM16(24VDC)</b><br>100417     | 1 off                      |              |
| 22                                | 5.5  | 11      | 11      | 11      | –       | < 20                              | <b>SDAINLM22(230V50Hz)</b><br>278336  | 1 off                      |              |
| 22                                | 5.5  | 11      | 11      | 11      | –       | < 20                              | <b>SDAINLM22(400V50Hz)</b><br>101382  | 1 off                      |              |
| 22                                | 5.5  | 11      | 11      | 11      | –       | < 20                              | <b>SDAINLM22(24VDC)</b><br>100418     | 1 off                      |              |
| 30                                | 7.5  | 15      | 18.5    | 18.5    | –       | < 20                              | <b>SDAINLM30(230V50Hz)</b><br>278361  | 1 off                      |              |
| 30                                | 7.5  | 15      | 18.5    | 18.5    | –       | < 20                              | <b>SDAINLM30(400V50Hz)</b><br>101383  | 1 off                      |              |
| 30                                | 7.5  | 15      | 18.5    | 18.5    | –       | < 20                              | <b>SDAINLM30(RDC24)</b><br>100419     | 1 off                      |              |
| 45                                | 11   | 22      | 30      | 22      | –       | < 20                              | <b>SDAINLM45(230V50Hz)</b><br>278386  | 1 off                      |              |
| 45                                | 11   | 22      | 30      | 22      | –       | < 20                              | <b>SDAINLM45(400V50Hz)</b><br>101384  | 1 off                      |              |
| 45                                | 11   | 22      | 30      | 22      | –       | < 20                              | <b>SDAINLM45(RDC24)</b><br>100420     | 1 off                      |              |
| 55                                | 15   | 30      | 37      | 30      | –       | < 20                              | <b>SDAINLM55(230V50Hz)</b><br>278411  | 1 off                      |              |
| 55                                | 15   | 30      | 37      | 30      | –       | < 20                              | <b>SDAINLM55(400V50Hz)</b><br>101385  | 1 off                      |              |
| 55                                | 15   | 30      | 37      | 30      | –       | < 20                              | <b>SDAINLM55(RDC24)</b><br>100421     | 1 off                      |              |
| 70                                | 18.5   | 37      | 45      | 37      | –       | < 20                              | <b>SDAINLM70(230V50Hz)</b><br>239895  | 1 off                      |              |
| 70                                | 18.5   | 37      | 45      | 37      | –       | < 20                              | <b>SDAINLM70(400V50Hz)</b><br>101386  | 1 off                      |              |
| 90                                | 22   | 45      | 55      | 45      | –       | < 20                              | <b>SDAINLM90(230V50Hz)</b><br>239937  | 1 off                      |              |
| 115                               | 30   | 55      | 75      | 55      | –       | < 20                              | <b>SDAINLM115(230V50Hz)</b><br>239963 | 1 off                      |              |
| 140                               | 37   | 75      | 90      | 90      | –       | < 20                              | <b>SDAINLM140(230V50Hz)</b><br>240009 | 1 off                      |              |
| 165                               | 45   | 90      | 110     | 132     | –       | < 20                              | <b>SDAINLM165(230V50Hz)</b><br>240035 | 1 off                      |              |
| 200                               | 55   | 110     | 132     | 160     | –       | < 20                              | <b>SDAINLM200(230V50Hz)</b><br>101010 | 1 off                      |              |
| 260                               | 75   | 132     | 160     | 160     | –       | < 20                              | <b>SDAINLM260(230V50Hz)</b><br>101031 | 1 off                      |              |

| Individual components of the combination |                            |                           |                  | Spare auxiliary contacts |     |     | Notes   |
|--|----------------------------|---------------------------|------------------|--------------------------|-----|-----|---|
| Mains contactor Q11                      | Delta contactor Q15        | Star contactor Q13        | Timing relays K1 | Q11                      | Q13 | Q15 |   |
| Part no.                                 | Part no.                   | Part no.                  | Part no.         |                          |     |     |   |
| DILEM-10<br>+ 22DILEM                    | DILEM-01                   | DILEM-10 +<br>02DILEM     | DILET            |                          | —   | —   | <p>Main circuit:<br/>Depending on the type of coordination required (i.e. Type "1" or Type "2") it must be established whether the fuse protection and the input wiring for the mains contactor and delta contactor are to be common or separate.</p> <p>The following applies for SDAINLM 140 – SDAINLM 260:</p> <ul style="list-style-type: none"> <li>On the mounting plate.</li> </ul> <p>Circuit diagrams, Star-delta combinations → page 46</p> |
| DILM7-10<br>+ DILA-XHI20                 | DILM7-01<br>+ DILA-XHI20   | DILM7-01<br>+ DILA-XHI20  | ETR4-51          |                          |     |     |   |
| DILM7-10<br>+ DILA-XHI20                 | DILM7-01<br>+ DILA-XHI20   | DILM7-01<br>+ DILA-XHI20  | ETR4-51          |                          |     |     |   |
| DILM7-10<br>+ DILA-XHI20                 | DILM7-01<br>+ DILA-XHI20   | DILM7-01<br>+ DILA-XHI20  | ETR4-51          |                          |     |     |   |
| DILM9-10<br>+ DILA-XHI20                 | DILM9-01<br>+ DILA-XHI20   | DILM7-01<br>+ DILA-XHI20  | ETR4-51          |                          |     |     |   |
| DILM9-10<br>+ DILA-XHI20                 | DILM9-01<br>+ DILA-XHI20   | DILM7-01<br>+ DILA-XHI20  | ETR4-51          |                          |     |     |   |
| DILM9-10<br>+ DILA-XHI20                 | DILM9-01<br>+ DILA-XHI20   | DILM7-01<br>+ DILA-XHI20  | ETR4-51          |                          |     |     |   |
| DILM12-10<br>+ DILA-XHI20                | DILM12-01<br>+ DILA-XHI20  | DILM7-01<br>+ DILA-XHI20  | ETR4-51          |                          |     |     |   |
| DILM12-10<br>+ DILA-XHI20                | DILM12-01<br>+ DILA-XHI20  | DILM7-01<br>+ DILA-XHI20  | ETR4-51          |                          |     |     |   |
| DILM12-10<br>+ DILA-XHI20                | DILM12-01<br>+ DILA-XHI20  | DILM7-01<br>+ DILA-XHI20  | ETR4-51          |                          |     |     |   |
| DILM17-10<br>+ DILA-XHI20                | DILM17-01<br>+ DILA-XHI20  | DILM17-01<br>+ DILA-XHI20 | ETR4-51          |                          |     |     |   |
| DILM17-10<br>+ DILA-XHI20                | DILM17-01<br>+ DILA-XHI20  | DILM17-01<br>+ DILA-XHI20 | ETR4-51          |                          |     |     |   |
| DILM17-10<br>+ DILA-XHI20                | DILM17-01<br>+ DILA-XHI20  | DILM17-01<br>+ DILA-XHI20 | ETR4-51          |                          |     |     |   |
| DILM25-10<br>+ DILA-XHI20                | DILM25-01<br>+ DILA-XHI20  | DILM17-01<br>+ DILA-XHI20 | ETR4-51          |                          |     |     |   |
| DILM25-10<br>+ DILA-XHI20                | DILM25-01<br>+ DILA-XHI20  | DILM17-01<br>+ DILA-XHI20 | ETR4-51          |                          |     |     |   |
| DILM25-10<br>+ DILA-XHI20                | DILM25-01<br>+ DILA-XHI20  | DILM17-01<br>+ DILA-XHI20 | ETR4-51          |                          |     |     |   |
| DILM32-10<br>+ DILA-XHI20                | DILM32-01<br>+ DILA-XHI20  | DILM25-01<br>+ DILA-XHI20 | ETR4-51          |                          |     |     |   |
| DILM32-10<br>+ DILA-XHI20                | DILM32-01<br>+ DILA-XHI20  | DILM25-01<br>+ DILA-XHI20 | ETR4-51          |                          |     |     |   |
| DILM32-10<br>+ DILA-XHI20                | DILM32-01<br>+ DILA-XHI20  | DILM25-01<br>+ DILA-XHI20 | ETR4-51          |                          |     |     |   |
| DILM40<br>+ DILM150-XHI31                | DILM40<br>+ DILM150-XHI11  | DILM40<br>+ DILM150-XHI11 | ETR4-51          |                          | —   | —   |   |
| DILM40<br>+ DILM150-XHI31                | DILM40<br>+ DILM150-XHI11  | DILM40<br>+ DILM150-XHI11 | ETR4-51          |                          | —   | —   |   |
| DILM50<br>+ DILM150-XHI31                | DILM50<br>+ DILM150-XHI11  | DILM40<br>+ DILM150-XHI11 | ETR4-51          |                          | —   | —   |   |
| DILM65<br>+ DILM150-XHI31                | DILM65<br>+ DILM150-XHI11  | DILM40<br>+ DILM150-XHI11 | ETR4-51          |                          | —   | —   |   |
| DILM80<br>+ DILM150-XHI31                | DILM80<br>+ DILM150-XHI11  | DILM50<br>+ DILM150-XHI11 | ETR4-51          |                          | —   | —   |   |
| DILM95<br>+ DILM150-XHI31                | DILM95<br>+ DILM150-XHI11  | DILM65<br>+ DILM150-XHI11 | ETR4-51          |                          | —   | —   |   |
| DILM115<br>+ DILM150-XHI31               | DILM115<br>+ DILM150-XHI11 | DILM80<br>+ DILM150-XHI11 | ETR4-51          |                          | —   | —   |   |
| DILM150<br>+ DILM150-XHI31               | DILM150<br>+ DILM150-XHI11 | DILM95<br>+ DILM150-XHI11 | ETR4-51          |                          | —   | —   |   |

**Accessories**  
1 Overload relay  
Accessories

**Page**  
→ Chapter 1.2  
→ 52

# 1.1 Contactor combinations

## Star-delta combinations

### 1 Engineering

#### SDAINL Circuit diagrams, Star-delta combinations

SDAINLEM

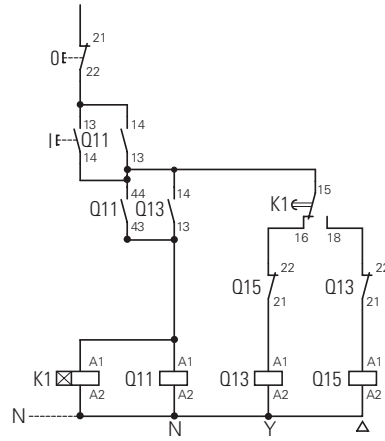
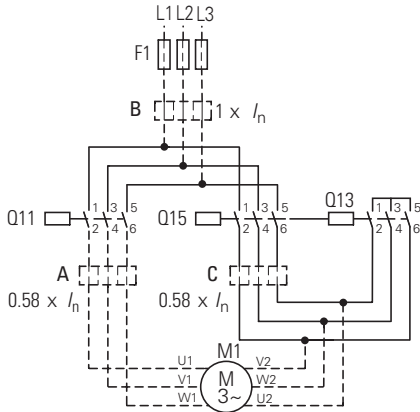

SDAINLM12...SDAINLM55

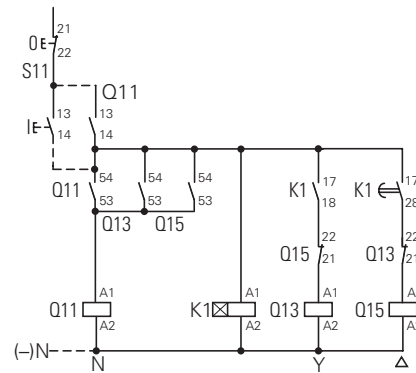
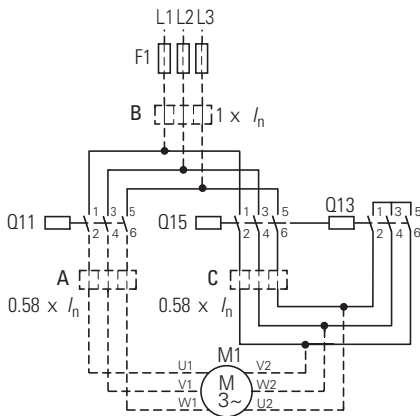

SDAINLM70...SDAINLM260

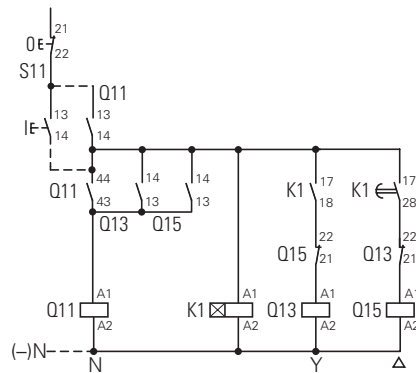
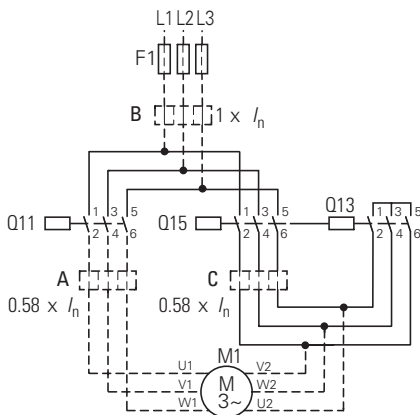

Overload relay settings

- A:**  $I_N \times 0.58$   
Motor protected in Y and  $\Delta$ - positions
- B:**  $I_N \times 1$   
Only partial motor protection in Y position
- C:**  $I_N \times 0.58$   
Motor not protected in Y position
- Timing relay set to approx. 10 s
- Main circuit:

Starting

- $\leq 15$  s
- 15 – 40 s
- > 40 s

Depending on the type of coordination required (i.e. Type "1" or Type "2") it must be established whether the fuse protection and the input wiring for the mains contactor and delta contactor are to be common or separate.

### SDAINL Components for self-assembly of star-delta combinations

Maximum operational rating of AC motors 50 - 60 Hz  
AC-3

Changeover time<sup>1)</sup>

#### Individual components of the combination

Spare auxiliary contacts

| 230 V<br>kW | 400 V<br>kW | 500 V<br>kW | 690 V<br>kW | 1000 V<br>kW | up to<br>12 s | up to<br>20 s | up to<br>30 s | Coil to EN 50005<br>Switching element to EN 50005 and EN 50012 |   |  |                                   | Q11 | Q15 | Q13 |
|-------------|-------------|-------------|-------------|--------------|---------------|---------------|---------------|--|---|--|-----------------------------------|-----|-----|-----|
|             |             |             |             |              |               |               |               | Mains<br>contactor<br>Q11<br>Part no. DIL                      | Delta<br>contactor<br>Q15<br>Part no. DIL | Star<br>contactor<br>Q13<br>Part no. DIL | Timing<br>relay<br>K1<br>Part no. |     |     |     |
| 90          | 160         | 200         | 250         | 132          | ●             | ●             | ●             | M185A/22   | M185A/22                                  | M115/22                                  | ETR4-51                           |     |     |     |
| 110         | 200         | 250         | 315         | 160          | ●             | ●             | —             | M225A/22   | M225A/22                                  | M150/22                                  | ETR4-51                           |     |     |     |
| 132         | 250         | 315         | 400         | 200          | ●             | ●             | ●             | M250/22  | M250/22                                   | M185A/22                                 | ETR4-51                           |     |     |     |
| 160         | 300         | 355         | 450         | 200          | ●             | ●             | ●             | M300A/22   | M300A/22                                  | M185A/22                                 | ETR4-51                           |     |     |     |
| 200         | 355         | 450         | 560         | 220          | ●             | ●             | —             | M400/22  | M400/22                                   | M250/22                                  | ETR4-51                           |     |     |     |
| 250         | 450         | 560         | 600         | 220          | ●             | ●             | ●             | M500/22  | M500/22                                   | M300A/22                                 | ETR4-51                           |     |     |     |
| 300         | 560         | 710         | 900         | 355          | ●             | ●             | ●             | M580/22  | M580/22                                   | M400/22                                  | ETR4-51                           |     |     |     |
| 350         | 630         | 750         | 950         | 355          | ●             | ●             | ●             | M650/22  | M650/22                                   | M400/22                                  | ETR4-51                           |     |     |     |
| 400         | 710         | 900         | 1200        | 1400         | ●             | ●             | ●             | M750/22  | M750/22                                   | M580/22                                  | ETR4-51                           |     |     |     |
| 450         | 800         | 950         | 1300        | 1400         | ●             | ●             | ●             | M820/22  | M820/22                                   | M580/22                                  | ETR4-51                           |     |     |     |
| 560         | 1000        | 1200        | 1700        | 1700         | ●             | ●             | —             | M1000/22   | M1000/22                                  | M650/22                                  | ETR4-51                           |     |     |     |

#### Notes

<sup>1)</sup> Longer changeover times please enquire

#### Components for self-assembly

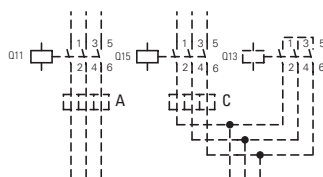
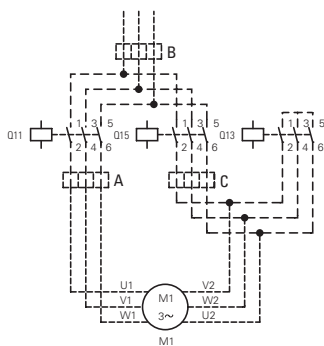

#### Notes

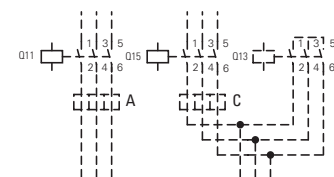

#### Overload relay settings

Timing relay set to approx. 10 s

| $I_N$   | Starting    | Main circuit:<br>Depending on the coordination type required (i.e. Type "1" or Type "2") it must be established whether the fuse protection and the input wiring for the mains contactor and delta contactor are to be common or separate. |
|---|-------------|--|
| <b>A</b> x 0.58<br>Motor protection in Y and $\Delta$ positions | $\leq 15$ s |  |
| <b>B</b> x 1<br>In Y position only limited motor protection     | 15 – 40 s   | Control circuit:<br>If the combinations are to be used within the scope of IEC/EN 60 204 Part 1, VDE 0113 Part 1, then Point 9.1.1 regarding the supply of control circuits, must be observed.   |
| <b>C</b> x 0.58<br>Motor not protected in Y position            | > 40 s      |  |



# 1.1

## Contactors combinations

### Reversing combinations

#### 1 Ordering

#### DIUL reversing combinations

Rated operational current      Max. motor rating for three-phase motors 50 - 60 Hz      **Part no.** Article no.      **Price** See price list      Std. pack

| AC-3<br>400 V       | AC-3           |                |                | AC-4           |                |                | Part no.<br>Article no. | Price<br>See price list | Std. pack |
|---------------------|----------------|----------------|----------------|----------------|----------------|----------------|-------------------------|-------------------------|-----------|
|                     | 220 V<br>230 V | 380 V<br>400 V | 660 V<br>690 V | 220 V<br>230 V | 380 V<br>400 V | 660 V<br>690 V |                         |                         |           |
| I <sub>e</sub><br>A | P<br>kW        | P<br>kW        | P<br>kW        | P<br>kW        | P<br>kW        | P<br>kW        |                         |                         |           |

#### AC operation

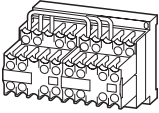

|   |     |   |   |     |   |   |  |       |  |
|---|-----|---|---|-----|---|---|--|-------|--|
| 9 | 2.2 | 4 | 4 | 1.5 | 3 | 3 | <b>DIULEM/21(MV(230V50Hz)<sup>1</sup>)</b><br>051849 | 1 Off |  |
| 9 | 2.2 | 4 | 4 | 1.5 | 3 | 3 | <b>DIULEM/21(MV-G(24VDC)<sup>2</sup>)</b><br>214655  | 1 Off |  |

#### AC operation

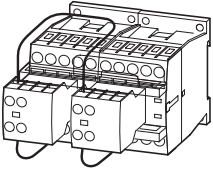

|    |      |      |     |     |     |     |   |       |  |
|----|------|------|-----|-----|-----|-----|---|-------|--|
| 7  | 2.2  | 3    | 3.5 | 1   | 2.2 | 2.9 | <b>DIULM7/21(230V50Hz)<sup>2</sup></b><br>278061  | 1 Off |  |
| 7  | 2.2  | 3    | 3.5 | 1   | 2.2 | 2.9 | <b>DIULM7/21(24VDC)<sup>2</sup></b><br>107021     | 1 Off |  |
| 9  | 2.5  | 4    | 4.5 | 1.5 | 2.5 | 3.6 | <b>DIULM9/21(230V50Hz)<sup>2</sup></b><br>278086  | 1 Off |  |
| 9  | 2.5  | 4    | 4.5 | 1.5 | 2.5 | 3.6 | <b>DIULM9/21(24VDC)<sup>2</sup></b><br>107022     | 1 Off |  |
| 12 | 3.5  | 5.5  | 6.5 | 2   | 3   | 4.4 | <b>DIULM12/21(230V50Hz)<sup>2</sup></b><br>278111 | 1 Off |  |
| 12 | 3.5  | 5.5  | 6.5 | 2   | 3   | 4.4 | <b>DIULM12/21(24VDC)<sup>2</sup></b><br>107023    | 1 Off |  |
| 18 | 5    | 7.5  | 11  | 2.5 | 4.5 | 6.5 | <b>DIULM17/21(230V50Hz)<sup>2</sup></b><br>278136 | 1 Off |  |
| 18 | 5    | 7.5  | 11  | 2.5 | 4.5 | 6.5 | <b>DIULM17/21(RDC24)<sup>2</sup></b><br>107024    | 1 Off |  |
| 25 | 7.5  | 11   | 14  | 3.5 | 6   | 8.5 | <b>DIULM25/21(230V50Hz)<sup>2</sup></b><br>278161 | 1 Off |  |
| 25 | 7.5  | 11   | 14  | 3.5 | 6   | 8.5 | <b>DIULM25/21(RDC24)<sup>2</sup></b><br>107025    | 1 Off |  |
| 32 | 10   | 15   | 17  | 4   | 7   | 10  | <b>DIULM32/21(230V50Hz)<sup>2</sup></b><br>278186 | 1 Off |  |
| 32 | 10   | 15   | 17  | 4   | 7   | 10  | <b>DIULM32/21(RDC24)<sup>2</sup></b><br>107026    | 1 Off |  |
| 40 | 12.5 | 18.5 | 23  | 5   | 9   | 12  | <b>DIULM40/11(230V50Hz)<sup>2</sup></b><br>278211 | 1 Off |  |
| 50 | 15.5 | 22   | 30  | 6   | 10  | 14  | <b>DIULM50/11(230V50Hz)<sup>2</sup></b><br>278236 | 1 Off |  |
| 65 | 20   | 30   | 35  | 7   | 12  | 17  | <b>DIULM65/11(230V50Hz)<sup>2</sup></b><br>278261 | 1 Off |  |

#### AC operation

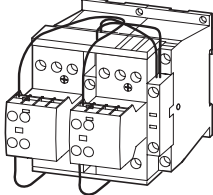

#### Information relevant for export to North America



|                         |   |
|-------------------------|---|
| 1)<br>Product Standards | IEC/EN 60947-4-1; UL 508;<br>CSA-C22.2 No.14-05; CE marking |
| UL File No.             | E29096  |
| UL CCN                  | NLDX  |
| CSA File No.            | 012528  |
| CSA Class No.           | 3211-04   |
| NA Certification        | UL Listed, CSA certified                                    |

#### Information relevant for export to North America



|                         |   |
|-------------------------|---|
| 2)<br>Product Standards | IEC/EN 60947-4-1; UL 508;<br>CSA-C22.2 No.14-05; CE marking |
| UL File No.             | E29096  |
| UL CCN                  | NLDX  |
| CSA File No.            | 012528  |
| CSA Class No.           | 2411-03, 3211-04  |
| NA Certification        | UL Listed, CSA certified                                    |

| Individual components of the combination |                           | Spare auxiliary contacts |     |                      | Circuit diagram | Notes  |
|--|---------------------------|--------------------------|-----|----------------------|-----------------|--|
| Contactor Q11                            | Contactor Q12             | Q11                      | Q12 | Mechanical interlock |                 |  |
| Part no.                                 | Part no.                  |                          |     |                      |                 |  |
| DILEM-10<br>+ 11DILEM                    | DILEM-10<br>+ 11DILEM     |                          |     | +                    |                 | <br><b>Accessories</b><br>1 Overload relay<br>Accessories<br>Reversing contactors  |
| DILEM-10-G<br>+ 11DILEM                  | DILEM-10-G<br>+ 11DILEM   |                          |     | +                    |                 |  |
| DILM7-01<br>+ DILA-XHI20                 | DILM7-01<br>+ DILA-XHI20  |                          |     | +                    |                 | <b>Accessories</b><br>1 Overload relay<br>Accessories<br>Reversing contactors<br><br>DIULM7/21 to DIULM65/11 with mechanical interlock |
| DILM7-01<br>+ DILA-XHI20                 | DILM7-01<br>+ DILA-XHI20  |                          |     | +                    |                 |  |
| DILM9-01<br>+ DILA-XHI20                 | DILM9-01<br>+ DILA-XHI20  |                          |     | +                    |                 |  |
| DILM9-01<br>+ DILA-XHI20                 | DILM9-01<br>+ DILA-XHI20  |                          |     | +                    |                 |  |
| DILM12-01<br>+ DILA-XHI20                | DILM12-01<br>+ DILA-XHI20 |                          |     | +                    |                 |  |
| DILM12-01<br>+ DILA-XHI20                | DILM12-01<br>+ DILA-XHI20 |                          |     | +                    |                 |  |
| DILM17-01<br>+ DILA-XHI20                | DILM17-01<br>+ DILA-XHI20 |                          |     | +                    |                 |  |
| DILM17-01<br>+ DILA-XHI20                | DILM17-01<br>+ DILA-XHI20 |                          |     | +                    |                 |  |
| DILM25-01<br>+ DILA-XHI20                | DILM25-01<br>+ DILA-XHI20 |                          |     | +                    |                 |  |
| DILM25-01<br>+ DILA-XHI20                | DILM25-01<br>+ DILA-XHI20 |                          |     | +                    |                 |  |
| DILM32-01<br>+ DILA-XHI20                | DILM32-01<br>+ DILA-XHI20 |                          |     | +                    |                 |  |
| DILM32-01<br>+ DILA-XHI20                | DILM32-01<br>+ DILA-XHI20 |                          |     | +                    |                 |  |
| DILM40<br>+ DILM150-XHI11                | DILM40<br>+ DILM150-XHI11 | -                        | -   | +                    |                 |  |
| DILM50<br>+ DILM150-XHI11                | DILM50<br>+ DILM150-XHI11 | -                        | -   | +                    |                 |  |
| DILM65<br>+ DILM150-XHI11                | DILM65<br>+ DILM150-XHI11 | -                        | -   | +                    |                 |  |

Page  
 → Chapter 1.2  
 → 52

# 1.1

## Contactor relays, contactors

### Suppressor circuit

#### 1 Ordering

#### DILM...-XSP... Suppressor circuits

##### RC suppressors

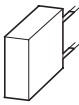

| Voltage<br>$U_s$<br>V | For use with                       | Circuit symbol | Part no.<br>Article no.         | Price<br>See price list | Std. pack  | Notes   |
|-----------------------|------------------------------------|----------------|---------------------------------|-------------------------|------------|---|
| 24 - 48 AC            | DILM7 - DILM15<br>DILMP20          |                | <b>DILM12-XSPR48</b><br>281199  |                         | 10 Off<br> | For AC operated contactors 50 - 60 Hz. DC operated contactors and DILM115 and DILM150 have an integrated suppressor. Note drop-out delay. |
| 110 - 240 AC          | DILA                               |                | <b>DILM12-XSPR240</b><br>281200 |                         | 10 Off<br> |   |
| 240 - 500 AC          |                                    |                | <b>DILM12-XSPR500</b><br>281201 |                         | 10 Off<br> |   |
| 24 - 48 AC            | DILM17 - DILM32<br>DILK12 - DILK25 |                | <b>DILM32-XSPR48</b><br>281202  |                         | 10 Off<br> |   |
| 110 - 240 AC          | DILL...<br>DILMP32 - DILMP45       |                | <b>DILM32-XSPR240</b><br>281203 |                         | 10 Off<br> |   |
| 240 - 500 AC          |                                    |                | <b>DILM32-XSPR500</b><br>281204 |                         | 10 Off<br> |   |
| 24 - 48 AC            | DILM40 - DILM95<br>DILK33 - DILK50 |                | <b>DILM95-XSPR48</b><br>281205  |                         | 10 Off<br> |   |
| 110 - 240 AC          | DILMP63 - DILMP200                 |                | <b>DILM95-XSPR240</b><br>281206 |                         | 10 Off<br> |   |
| 240 - 500 AC          |                                    |                | <b>DILM95-XSPR500</b><br>281207 |                         | 10 Off<br> |   |

##### Varistor suppressors

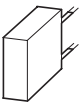

|              |                                    |  |                                 |  |            |   |
|--------------|------------------------------------|--|---------------------------------|--|------------|---|
| 24 - 48 AC   | DILM7 - DILM15<br>DILMP20          |  | <b>DILM12-XSPV48</b><br>281208  |  | 10 Off<br> | For AC operated contactors 50 - 60 Hz. DC operated contactors and DILM115 and DILM150 have an integrated suppressor. Note drop-out delay. |
| 48 - 130 AC  | DILA                               |  | <b>DILM12-XSPV130</b><br>281209 |  | 10 Off<br> |   |
| 130 - 240 AC |                                    |  | <b>DILM12-XSPV240</b><br>281210 |  | 10 Off<br> |   |
| 240 - 500 AC |                                    |  | <b>DILM12-XSPV500</b><br>281211 |  | 10 Off<br> |   |
| 24 - 48 AC   | DILM17 - DILM32<br>DILK12 - DILK25 |  | <b>DILM32-XSPV48</b><br>281212  |  | 10 Off<br> |   |
| 48 - 130 AC  | DILL...<br>DILMP32 - DILMP45       |  | <b>DILM32-XSPV130</b><br>281213 |  | 10 Off<br> |   |
| 130 - 240 AC |                                    |  | <b>DILM32-XSPV240</b><br>281214 |  | 10 Off<br> |   |
| 240 - 500 AC |                                    |  | <b>DILM32-XSPV500</b><br>281215 |  | 10 Off<br> |   |
| 24 - 48 AC   | DILM40 - DILM95<br>DILK33 - DILK50 |  | <b>DILM95-XSPV48</b><br>281216  |  | 10 Off<br> |   |
| 48 - 130 AC  | DILMP63 - DILMP200                 |  | <b>DILM95-XSPV130</b><br>281217 |  | 10 Off<br> |   |
| 130 - 240 AC |                                    |  | <b>DILM95-XSPV240</b><br>281218 |  | 10 Off<br> |   |
| 240 - 500 AC |                                    |  | <b>DILM95-XSPV500</b><br>281219 |  | 10 Off<br> |   |

#### Information relevant for export to North America



|                   |  |
|-------------------|--|
| Product Standards | IEC/EN 60947-4-1; UL 508; CSA-C22.2 No.14-05; CE marking |
| UL File No.       | E29096   |
| UL CCN            | NLDX   |
| CSA File No.      | 227038   |
| CSA Class No.     | 3211-07  |
| NA Certification  | UL Listed, CSA certified                                 |

### Ordering

#### DILM...-XSP... Suppressor circuits

##### Varistor suppressors with integrated LED

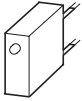

##### Diode suppressor



| Voltage<br>$U_s$<br>V | For use with                       | Circuit symbol | Part no.<br>Article no.          | Price<br>See price list | Std. pack  | Notes   |
|-----------------------|------------------------------------|----------------|----------------------------------|-------------------------|------------|---|
| 24 - 48 AC            | DILM7 - DILM15<br>DILMP20          |                | <b>DILM12-XSPVL48</b><br>281220  |                         | 10 Off<br> | For AC operated contactors 50 - 60 Hz. DC operated contactors and DILM115 and DILM150 have an integrated suppressor. Note drop-out delay. |
| 130 - 240 AC          | DILA                               |                | <b>DILM12-XSPVL240</b><br>281221 |                         | 10 Off<br> |   |
| 24 - 48 AC            | DILM17 - DILM32<br>DILK12 - DILK25 |                | <b>DILM32-XSPVL48</b><br>281222  |                         | 10 Off<br> |   |
| 130 - 240 AC          | DILL...<br>DILMP32 - DILMP45       |                | <b>DILM32-XSPVL240</b><br>281223 |                         | 10 Off<br> |   |
| 24 - 48 AC            | DILM40 - DILM95<br>DILK33 - DILK50 |                | <b>DILM95-XSPVL48</b><br>281224  |                         | 10 Off<br> |   |
| 130 - 240 AC          | DILMP63 - DILMP200                 |                | <b>DILM95-XSPVL240</b><br>281225 |                         | 10 Off<br> |   |
| 12 - 250 DC           | DILM7 - DILM15<br>DILMP20<br>DILA  |                | <b>DILM12-XSPD</b><br>101672     |                         | 10 Off<br> | DC operated contactors. Prevention of negative switch-off voltage when the contactor is used together with a safety PLC.                  |





















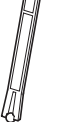

#### Information relevant for export to North America

|  |                   |  |
|--|-------------------|--|
|  | Product Standards | IEC/EN 60947-4-1; UL 508; CSA-C22.2 No.14-05; CE marking |
|  | UL File No.       | E29096   |
|  | UL CCN            | NLDX   |
|  | CSA File No.      | 227038   |
|  | CSA Class No.     | 3211-07  |
|  | NA Certification  | UL Listed, CSA certified                                 |

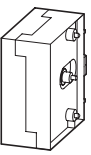

















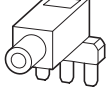

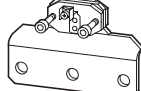





# 1.1 Contactor relays, contactors

## Accessories

### 1 DILM...-XDILM...-XVB, DILM...-XMV





|   | For use with   | Part no.<br>Article no.       | Price<br>See price list | Std. pack  | Notes  | Information relevant for export to North America   |
|---|--|-------------------------------|-------------------------|--|--|--|
| <b>Mechanical interlocks</b>  |  |                               |                         |  |  |  |
| For mechanically linking contactors in combinations 0 mm distance between contactors. |  |                               |                         |  |  |  |
|       | DILM7 - DILM72<br>DILA   | <b>DILM32-XVB</b><br>281227   |                         | 50 Off<br>     | –  | Product Standards IEC/EN 60947-4-1; UL 508; CSA-C22.2 No.14-05; CE marking<br>UL File No. E36332<br>UL CCN NLRV<br>CSA File No. 012528<br>CSA Class No. 3211-05<br>NA Certification UL Listed, CSA certified |
|       | DILM80 - DILM170   | <b>DILM150-XVB</b><br>281226  |                         | 10 Off<br>     | –  | Product Standards IEC/EN 60947-4-1; UL 508; CSA-C22.2 No.14-05; CE marking<br>UL File No. E29184<br>UL CCN NKCR<br>CSA File No. 012528<br>CSA Class No. 3211-03<br>NA Certification UL Listed, CSA certified |
| <b>Mechanical interlocks</b>  |  |                               |                         |  |  |  |
|      | DILM7 - DILM15<br>DILMP20<br>DILA  | <b>DILM12-XMV</b><br>281196   |                         | 1 Off<br>      | For two contactors with AC or DC operation arranged vertically or horizontally.<br>Distance between contactors 0 mm, including contactor connector<br>Mechanical lifespan 2.5 x 10 <sup>6</sup> operations.<br>DILM 150-XMV including mounting plate for contactors.<br>Additional auxiliary contact modules possible. →36 | Product Standards IEC/EN 60947-4-1; UL 508; CSA-C22.2 No.14-05; CE marking<br>UL File No. E29096<br>UL CCN NLDX<br>CSA File No. 012528<br>CSA Class No. 2411-03<br>NA Certification UL Listed, CSA certified |
|     | DILM17 - DILM38  | <b>DILM32-XMV</b><br>281197   |                         | 1 Off<br>  |  |  |
|     | DILM40 - DILM72  | <b>DILM65-XMV</b><br>281198   |                         | 1 Off<br>  |  |  |
|   | DILM80 - DILM170   | <b>DILM150-XMV</b><br>240081  |                         | 1 Off<br>  |  | Product Standards IEC/EN 60947-4-1; UL 508; CSA-C22.2 No.14-05; CE marking<br>UL File No. E29096<br>UL CCN NLDX<br>CSA File No. 012528<br>CSA Class No. 2411-03<br>NA Certification UL Listed, CSA certified |
|     | DILM185A,<br>DILM225A,<br>DILM250,<br>DILM300A,<br>DILM400,<br>DILM500,<br>DILM570 | <b>DILM500-XMV</b><br>208289  |                         | 1 Off<br>  | For contactors with the same or different magnet systems mounted horizontally or vertically, mechanical lifespan 5 x 10 <sup>6</sup> operations. <b>No</b> auxiliary contact permitted between mechanical interlock and contactor. Combination only with consecutive installation sizes or DILM185A - DILM570.             | Product Standards IEC/EN 60947-4-1; UL 508; CSA-C22.2 No.14-05; CE marking<br>UL File No. E29184<br>UL CCN NKCR<br>CSA File No. 012528<br>CSA Class No. 3211-04<br>NA Certification UL Listed, CSA certified |
|   | DILM580,<br>DILM650<br>DILM750,<br>DILM820<br>DILM1000                             | <b>DILM820-XMV</b><br>208288  |                         | 1 Off<br>  |  |  |
| <b>Set of spare parts for mechanical interlock</b>                                    |  |                               |                         |  |  |  |
| Ball for mechanical interlock, incl. contactor connector.                             |  |                               |                         |  |  |  |
| –   | DILM80 - DILM170   | <b>DILM150-XMVE</b><br>107020 |                         | 1 Off<br>  |  | UL/CSA certification not required  |

### DILM...-XP1, DILM...-XS1

| For use with  | Circuit symbol     | Part no.<br>Article no.      | Price<br>See price list | Std. pack   | Notes  | Information relevant for export to North America   |
|---|--------------------|------------------------------|-------------------------|---|--|--|
| <b>Paralleling links for main contacts</b>  |                    |                              |                         |   |  |  |
| Consisting of 2 paralleling links   |                    |                              |                         |   |  |  |
|    | DILM7 - DILM15     | <b>DILM12-XP1</b><br>281193  |                         | 5 Off<br>       | 4th pole can be broken off<br>AC-1 current carrying capacity of the open contactor increases by a factor of 2.5<br>Protected against accidental contact in accordance with VDE 0106 Part 100 | Product Standards<br><br>UL File No.<br>UL CCN<br>CSA File No.<br>CSA Class No.<br>NA Certification                                  |
|    | DILM17 - DILM32    | <b>DILM32-XP1</b><br>281194  |                         | 5 Off<br>       |  | IEC/EN 60947-4-1;<br>UL 508; CSA-C22.2<br>No.14-05; CE marking<br>E29096<br>NLDX<br>012528<br>3211-03<br>UL Listed, CSA certified    |
|    | DILM40 - DILM72    | <b>DILM65-XP1</b><br>281195  |                         | 1 Off<br>       | A cover is included with DILM185-XP1 for protection against accidental contact.  |  |
|    | DILM80 - DILM170   | <b>DILM150-XP1</b><br>284769 |                         | 1 Off<br>       | Connection cross section for DILM...-XP1 Technical data  |  |
|   | DILM185A           | <b>DILM185-XP1</b><br>208292 |                         | 1 Off   |  | –  |
| <b>Star-point bridges</b>   |                    |                              |                         |   |  |  |
|  | DILM7 - DILM15     | <b>DILM12-XS1</b><br>281190  |                         | 20 Off<br>  | <ul style="list-style-type: none"> <li>Designed as tool-less plug connection</li> <li>Use as DILA-XHIT... contactor auxiliary contact → 38</li> </ul>  | Product Standards<br><br>UL File No.<br>UL CCN<br>CSA File No.<br>CSA Class No.<br>NA Certification                                  |
|  | DILM17 - DILM32    | <b>DILM32-XS1</b><br>281191  |                         | 20 Off<br>  | Use as DILA-XHIT... contactor auxiliary contact → 38   | Product Standards<br><br>UL File No.<br>UL CCN<br>CSA File No.<br>CSA Class No.<br>NA Certification                                  |
|   | DILM40 - DILM72    | <b>DILM65-XS1</b><br>281192  |                         | 10 Off<br>  | –  | IEC/EN 60947-4-1;<br>UL 508; CSA-C22.2<br>No.14-05; CE marking<br>E36332<br>NLRV<br>012528<br>3211-04<br>UL Listed,<br>CSA certified |
|   | DILM80 - DILM170   | <b>DILM150-XS1</b><br>284768 |                         | 5 Off<br>   | –  | Product Standards<br><br>UL File No.<br>UL CCN<br>CSA File No.<br>CSA Class No.<br>NA Certification                                  |
|  | DILM185A - DILM400 | <b>DILM400-XS1</b><br>208291 |                         | 1 Off<br>   | A cover is included for protection against accidental contact.   | Product Standards<br><br>UL File No.<br>UL CCN<br>CSA File No.<br>CSA Class No.<br>NA Certification                                  |
|   | DILM500            | <b>DILM500-XS1</b><br>208290 |                         | 1 Off<br>   | A cover is included for protection against accidental contact.   | Product Standards<br><br>UL File No.<br>UL CCN<br>NA Certification   |









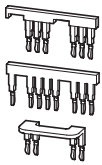

### DILM...-XSL Star-delta wiring kit

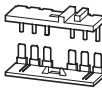
#### Main current wiring for star-delta combination Including star-point bridge







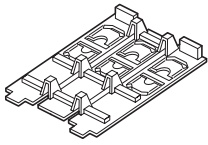

| For use with   | Part no.<br>Article no.   | Price<br>See price list  | Std. pack  | Notes  | Information relevant for export to North America   |
|--|---|--|--|--|--|
|                | DILM7/9/12/15 mains contactors<br>DILM7/9/12/15 delta contactors<br>DILM7/9/12/15 star contactors | <b>DILM12-XSL</b><br>283130  | 1 Off<br> | <ul style="list-style-type: none"> <li>Designed for tool-less plug connection</li> <li>Use as DILA-XHIT... contactor auxiliary contact → 38</li> </ul> <p>The following control cables are integrated in addition to electrical interlock:</p> <ul style="list-style-type: none"> <li>Q13: A1 - Q15: 21</li> <li>Q13: 21 - Q15: A1</li> <li>Q13: A2 - Q15: A2</li> </ul> | <b>Product Standards</b> IEC/EN 60947-4-1; UL 508; CSA-C22.2 No.14-05; CE marking 012528<br><b>CSA File No.</b> 012528<br><b>CSA Class No.</b> 3211-05<br><b>NA Certification</b> UL Listed, CSA certified   |
|  | DILM17/25/32 mains contactors<br>DILM17/25/32 delta contactors<br>DILM17/25/32 star contactors    | <b>DILM32-XSL</b><br>283131  | 1 Off<br> | Consists of the following connection bridges: <ul style="list-style-type: none"> <li>Mains - delta contactors</li> <li>Delta - star contactors</li> <li>Star-point bridge</li> </ul>   | <b>Product Standards</b> IEC/EN 60947-4-1; UL 508; CSA-C22.2 No.14-05; CE marking<br><b>UL File No.</b> E36332<br><b>UL CCN</b> NLRV<br><b>CSA File No.</b> 012528<br><b>CSA Class No.</b> 3211-04<br><b>NA Certification</b> UL Listed, CSA certified |
|  | DILM40/50/65 mains contactors<br>DILM40/50/65 delta contactors<br>DILM40/50/65 star contactors    | <b>DILM65-XSL</b><br>101058  | 1 Off<br> |  | <b>Product Standards</b> IEC/EN 60947-4-1; UL 508; CSA-C22.2 No.14-05; CE marking<br><b>UL File No.</b> E36332<br><b>UL CCN</b> NLRV<br><b>CSA File No.</b> 012528<br><b>CSA Class No.</b> 3211-04<br><b>NA Certification</b> UL Listed, CSA certified |
|  | DILM 80/95 mains contactors<br>DILM80/95 delta contactors<br>DILM50/65 star contactors            | <b>DILM95-XSL</b><br>101486  | 1 Off  |  | –  |
| DILM 115/150 mains contactors<br>DILM115/150 delta contactors<br>DILM80/95/115 star contactors | <b>DILM150-XSL</b><br>101487  | 1 Off<br> |  | <b>Product Standards</b> IEC/EN 60947-4-1; UL 508; CSA-C22.2 No.14-05; CE marking<br><b>UL File No.</b> E36332<br><b>UL CCN</b> NLRV<br><b>CSA File No.</b> 012528<br><b>CSA Class No.</b> 2411-03,3211-04<br><b>NA Certification</b> UL Listed, CSA certified   |  |
| DILM 185/225 mains contactors<br>DILM185/225 delta contactors<br>DILM115/150 star contactors   | <b>DILM225-XSL</b><br>101488  | 1 Off  |  | –  |  |

### DILM...-XRL, DILM...XIP2X Reversing starter wiring kits

#### Main current wiring for reversing combinations

| For use with  | Part no.<br>Article no. | Price<br>See price list      | Std. pack  | Notes  | Information relevant for export to North America  |
|---|-------------------------|------------------------------|--|--|---|
|  | DILM7                   | <b>DILM12-XRL</b><br>283108  | 1 Off<br>  | <ul style="list-style-type: none"> <li>Designed for tool-less plug connection</li> <li>As auxiliary contact DILA-XHIT...use → 38</li> </ul> The following control cables are integrated in addition to electrical interlock: <ul style="list-style-type: none"> <li>Q11: A1 - Q12: 21</li> <li>Q11: 21 - Q12: A1</li> <li>Q11: A2 - Q12: A2</li> </ul> | Product Standards IEC/EN 60947-4-1; UL 508; CSA-C22.2 No.14-05; CE marking E36332<br>UL File No. NLRV<br>UL CCN 012528<br>CSA File No. 3211-05<br>CSA Class No. UL Listed, CSA certified<br>NA Certification          |
|   | DILM9                   |                              |  |  |   |
|   | DILM12                  |                              |  |  |   |
|  | DILM17                  | <b>DILM32-XRL</b><br>283109  | 1 Off<br>  | -  | Product Standards IEC/EN 60947-4-1; UL 508; CSA-C22.2 No.14-05; CE marking E36332<br>UL File No. NLRV<br>UL CCN 012528<br>CSA File No. 3211-04<br>CSA Class No. UL Listed, CSA certified<br>NA Certification          |
|   | DILM25                  |                              |  |  |   |
|   | DILM32                  |                              |  |  |   |
|  | DILM40                  | <b>DILM65-XRL</b><br>101057  | 1 Off<br>  | -  | Product Standards IEC/EN 60947-4-1; UL 508; CSA-C22.2 No.14-05; CE marking E36332<br>UL File No. NLRV<br>UL CCN 012528<br>CSA File No. 3211-04<br>CSA Class No. UL Listed, CSA certified<br>NA Certification          |
|   | DILM50                  |                              |  |  |   |
|   | DILM65                  |                              |  |  |   |
|  | DILM80                  | <b>DILM150-XRL</b><br>101681 | 1 Off<br>  | -  | Product Standards IEC/EN 60947-4-1; UL 508; CSA-C22.2 No.14-05; CE marking E36332<br>UL File No. NLRV<br>UL CCN 012528<br>CSA File No. 2411-03, 3211-04<br>CSA Class No. UL Listed, CSA certified<br>NA Certification |
|   | DILM95                  |                              |  |  |   |
|   | DILM115                 |                              |  |  |   |
|   | DILM150                 |                              |  |  |   |

### DILM...-XRL, DILM...XIP2X IP2X cover set

| For use with  | Part no.<br>Article no. | Price<br>See price list        | Std. pack  | Notes   | Information relevant for export to North America |
|---|-------------------------|--------------------------------|--|---|--|
|  | DILM17                  | <b>DILM32-XIP2X</b><br>118855  | 1 Off<br>  | Each cover set consists of two three-pole and two single-pole covers. | UL/CSA certification not required                |
|   | DILM25                  |                                |  |   |  |
|   | DILM32                  |                                |  |   |  |
|   | DILM38                  |                                |  |   |  |
|   | DILMP32                 |                                |  |   |  |
|   | DILMP45                 |                                |  |   |  |
|  | DILM40                  | <b>DILM65-XIP2X</b><br>106491  | 8 Off<br>  | 2 covers are required per phase<br>The cover set consists of 8 covers | UL/CSA certification not required                |
|   | DILM50                  |                                |  |   |  |
|   | DILM65                  |                                |  |   |  |
|   | DILM72                  |                                |  |   |  |
|   | DILMP63                 |                                |  |   |  |
|   | DILMP80                 |                                |  |   |  |
|  | DILM80                  | <b>DILM150-XIP2X</b><br>106492 | 8 Off<br>  |   | UL/CSA certification not required                |
|   | DILM95                  |                                |  |   |  |
|   | DILM115                 |                                |  |   |  |
|   | DILM150                 |                                |  |   |  |
|   | DILM170                 |                                |  |   |  |
|   | DILMP125                |                                |  |   |  |
|   | DILMP160                |                                |  |   |  |
|   | DILMP200                |                                |  |   |  |
|   | ZB150                   |                                |  |   |  |



#### DILM12-XDSBS Three-phase commoning links

Protected against accidental contact, short-circuit proof,  $U_e = 690\text{ V}$ ,  $I_u = 35\text{ A}$  Can be extended by rotating by mounting



| For use with                       | Part no.<br>Article no.         | Price<br>See price list | Std. pack | Notes                                       | Information relevant for export to North America   |
|------------------------------------|---------------------------------|-------------------------|-----------|---|--|
| DILM7<br>DILM9<br>DILM12<br>DILM15 | <b>DILM12-XDSB0/3</b><br>240084 |                         | 5 Off<br> | Suitable for 3 contactors.<br>Length 112 mm | Product Standards IEC/EN 60947-4-1; UL 508;<br>CSA-C22.2 No.14-05;<br>CE marking<br>UL File No. E36332<br>UL CCN NLRV<br>CSA File No. 012528<br>CSA Class No. 2411-03<br>NA Certification UL Listed, CSA certified |
| DILM7<br>DILM9<br>DILM12<br>DILM15 | <b>DILM12-XDSB0/4</b><br>240085 |                         | 5 Off<br> | Suitable for 4 contactors.<br>Length 157 mm |  |
| DILM7<br>DILM9<br>DILM12<br>DILM15 | <b>DILM12-XDSB0/5</b><br>240086 |                         | 5 Off<br> | Suitable for 5 contactors.<br>Length 202 mm |  |

#### DILM12-XDSBS Incoming connection block

| For use with                       | Part no.<br>Article no.     | Price<br>See price list | Std. pack | Notes   | Information relevant for export to North America   |
|------------------------------------|-----------------------------|-------------------------|-----------|---|--|
| DILM7<br>DILM9<br>DILM12<br>DILM15 | <b>DILM12-XEK</b><br>240083 |                         | 5 Off<br> | For three-phase commoning link, protected against accidental contact,<br>$U_e = 690\text{ V}$ , $I_u = 35\text{ A}$ .<br>Terminal capacities:<br>Stranded 2.5...16 mm <sup>2</sup><br>Flexible with ferrule 2.5...16 mm <sup>2</sup><br>AWG14...8 | Product Standards IEC/EN 60947-4-1; UL 508;<br>CSA-C22.2 No.14-05;<br>CE marking<br>UL File No. E36332<br>UL CCN NLRV<br>CSA File No. 012528<br>CSA Class No. 2411-03<br>NA Certification UL Listed, CSA certified |



#### DILM12-XDSBS Adapter plate

Enables clipping on of switches on to DIN rails

| For use with                                      | Part no.<br>Article no.    | Price<br>See price list | Std. pack | Notes                  | Information relevant for export to North America  |
|---|----------------------------|-------------------------|-----------|------------------------|---|
| DILM80<br>DILM95<br>DILM115<br>DILM150<br>DILM170 | <b>NZM2-XC75</b><br>260215 |                         | 1 Off<br> | For top-hat rail 75 mm | Product Standards IEC/EN 60947-4-1; UL 489;<br>CSA-C22.2 No.14-05;<br>CE marking<br>UL File No. E140305<br>UL CCN DIHS<br>CSA File No. 022086<br>CSA Class No. 1437-01<br>NA Certification UL Listed, CSA certified |

### DILM32-XTE

#### Electronic timer modules

**On-delayed, Cannot be combined with top mounting auxiliary contacts Incl. suppressor circuits**

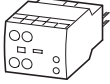

**Off-delayed, auxiliary voltage-free Cannot be combined with top mounting auxiliary contacts Incl. suppressor circuits**

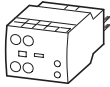

**For star-delta applications Cannot be combined with top mounting auxiliary contacts Incl. suppressor circuits**

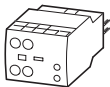

|                  | For use with                       | Circuit symbol | Part no.<br>Article no.                    | Price<br>See price list                | Std. pack | Notes                                       |                             |
|------------------|------------------------------------|----------------|--|--|-----------|---|-----------------------------|
| 24 V AC/DC       | DILM7 - DILM32                     |                | <b>DILM32-XTEE11(RA24)</b><br>101440       |  | 1 Off     | Time range can be selected                  |                             |
| 100 ... 130 V AC | DILMP20<br>DILMP32-DILMP45<br>DILA |                | <b>DILM32-XTEE11(RAC130)</b><br>101441     |  | 1 Off     | 0.05 s...1 s<br>0.5 s...10 s<br>5 s...100 s |                             |
| 200 ... 240 V AC |                                    |                | <b>DILM32-XTEE11(RAC240)</b><br>101442     |  | 1 Off     |   |                             |
| 24 V AC/DC       | DILM7 - DILM32                     |                | <b>DILM32-XTED11-1(RA24)</b><br>105210     |  | 1 Off     | Time range<br>0.05 s...1 s                  |                             |
| 24 V AC/DC       | DILMP20<br>DILMP32-DILMP45<br>DILA |                | <b>DILM32-XTED11-10(RA24)</b><br>104943    |  | 1 Off     | Time range<br>0.5 s...10 s                  |                             |
| 24 V AC/DC       |                                    |                | <b>DILM32-XTED11-100(RA24)</b><br>104946   |  | 1 Off     | Time range<br>5 s...100 s                   |                             |
| 100 ... 130 V AC |                                    |                | <b>DILM32-XTED11-1(RAC130)</b><br>105211   |  | 1 Off     | Time range<br>0.05 s...1 s                  |                             |
| 100 ... 130 V AC |                                    |                | <b>DILM32-XTED11-10(RAC130)</b><br>104944  |  | 1 Off     | Time range<br>0.5 s...10 s                  |                             |
| 100 ... 130 V AC |                                    |                | <b>DILM32-XTED11-100(RAC130)</b><br>104947 |  | 1 Off     | Time range<br>5 s...100 s                   |                             |
| 200 ... 240 V AC |                                    |                | <b>DILM32-XTED11-1(RAC240)</b><br>105212   |  | 1 Off     | Time range<br>0.05 s...1 s                  |                             |
| 200 ... 240 V AC |                                    |                | <b>DILM32-XTED11-10(RAC240)</b><br>104945  |  | 1 Off     | Time range<br>0.5 s...10 s                  |                             |
| 200 ... 240 V AC |                                    |                | <b>DILM32-XTED11-100(RAC240)</b><br>104948 |  | 1 Off     | Time range<br>5 s...100 s                   |                             |
| 24 V AC/DC       | DILM7 - DILM32                     |                |  | <b>DILM32-XTEY20(RA24)</b><br>101446   |           | 1 Off                                       | Changeover time<br>1...30 s |
| 100 ... 130 V AC | DILMP20<br>DILMP32-DILMP45<br>DILA |                |  | <b>DILM32-XTEY20(RAC130)</b><br>101447 |           | 1 Off                                       | 50 ms changeover<br>delay   |
| 200 ... 240 V AC |                                    |                |  | <b>DILM32-XTEY20(RAC240)</b><br>101448 |           | 1 Off                                       | Sample circuit<br>→ Page 92 |

#### Information relevant for export to North America



|                   |  |
|-------------------|--|
| Product Standards | IEC/EN 60947-4-1; UL 508; CSA-C22.2 No.14-05; CE marking |
| UL File No.       | E29184   |
| UL CCN            | NKCR   |
| CSA File No.      | 012528   |
| CSA Class No.     | 3211-03  |
| NA Certification  | UL Listed, CSA certified                                 |

# 1.1

## Contactors relays, contactors



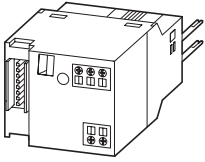

### Accessories

1









### DIL-SWD..., DILM12-XMC SWD contactor modules

SmartWire-DT® module for installation on contactors. One module per contactor

|   | For use with                                 | Part no.<br>Article no.                      | Price<br>See price<br>list | Std. pack  | Notes   |
|---|--|--|----------------------------|--|---|
| Two digital inputs for potential-free contacts.<br>1 electrical interlock for the surface mounting of reversing starters.<br>Messages: Contactor switch status, status of the digital inputs 1 and 2.<br>Commands: Contactor actuation  | DILM(C)7... -<br>DILM(C)32<br>DILM38<br>DILA | <b>DIL-SWD-32-001<sup>1)</sup></b><br>118560 |                            | 5 Off<br>  | <ul style="list-style-type: none"> <li>Take into account the max. current consumption of the contactor coils per SmartWire-DT® line.</li> <li>A2 terminals must not be bridged.</li> <li>Wiring sets DILM 12-XRL and PKZM0-XRM12 cannot be used.</li> <li>Connection terminals for electrical interlocking are not suitable for safety technology.</li> </ul> |
| Two digital inputs for potential-free contacts.<br>1 electrical interlock for the surface mounting of reversing starters.<br>1-0-A switch for manual or automatic operation.<br>Messages: contactor switching position, status of the digital inputs 1 and 2, 1-0-A switch position.<br>Commands: Contactor actuation | DILM(C)7... -<br>DILM(C)32<br>DILM38<br>DILA | <b>DIL-SWD-32-002<sup>1)</sup></b><br>118561 |                            | 5 Off<br>  |   |

### DIL-SWD..., DILM12-XMC Wiring set for motor feeder plug

| For use with  | Part no.<br>Article no.                     | Price<br>See price<br>list | Std. pack  | Notes  |
|---|---|----------------------------|--|--|
| DILM(C)7<br>DILM(C)9<br>DILM(C)12<br>DILM(C)15  | <b>DILM12-XMCE<sup>2)</sup></b><br>121764   |                            | 5 Off<br>  | 35x7.5 (15) mm mounting rail (as per DIN EN 60715) with PE function required.<br>For connection of:<br>PE 0.75 – 4 mm <sup>2</sup>               |
| DILM(C)7<br>DILM(C)9<br>DILM(C)12<br>DILM(C)15  | <b>DILM12-XMCP/E<sup>2)</sup></b><br>121769 |                            | 1 Off<br>  | 35x7.5 (15) mm mounting rail (as per DIN EN 60715) with PE function required.<br>For connection of:<br>L1, L2, L3, PE 0.75 – 2.5 mm <sup>2</sup> |
| PKZM0/PKE + DILM(C)7<br>PKZM0/PKE + DILM(C)9<br>PKZM0/PKE + DILM(C)12<br>PKZM0/PKE + DILM(C)15<br>MSC-D(E)-...-M7...<br>MSC-D(E)-...-M9...<br>MSC-D(E)-...-M15... | <b>DILM12-XMCP/T<sup>2)</sup></b><br>121770 |                            | 1 Off<br>  | For connection of:<br>L1, L2, L3, PE 0.75 – 2.5 mm <sup>2</sup>  |

#### PE module with contact plate

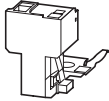

#### Motor plate with PE module and contact plate

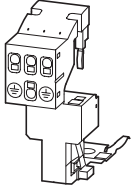

#### Motor plate with PE module and contact plate











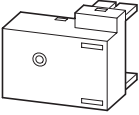

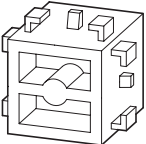
#### Information relevant for export to North America

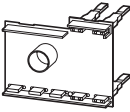

- |  |   |
|--|---|
| 1) NA Certification                      | Request filed for UL and CSA  |
| 2) Product Standards<br>NA Certification | IEC/EN 60947-4-1; UL 508; CSA-C22.2 No. 14-05; CE marking<br>Request filed for UL and CSA |

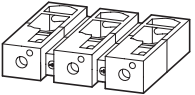
## DILM...-X...

|   | For use with   | Part no.<br>Article no.         | Price<br>See price list | Std. pack   | Notes  | Information relevant for export to<br>North America<br>  |
|---|--|---------------------------------|-------------------------|---|--|---|
| <b>Motor suppressor module</b>  |  |                                 |                         |   |  |   |
| Can be used at 380...575 V 50/60 Hz.  |  |                                 |                         |   |  |   |
|    | DILM7 -<br>DILM15  | <b>DILM12-XMSM</b><br>109399    |                         | 4 Off<br>    | <ul style="list-style-type: none"> <li>• Tool-less version using tool-less plug connection</li> <li>• RC suppressor</li> <li>• Ambient temperature -25...+60 °C, open.</li> <li>• Insulated material, difficult to ignite according to UL 94.</li> <li>• Weight = 0.05 kg.</li> <li>• UL/CSA approval applied for</li> </ul> | Product Standards IEC/EN 60947-4-1;<br>UL 508; CE marking<br>E300273<br>UL File No. NMTR2<br>UL CCN<br>NA Certification UL Listed   |
| <b>Test block</b>   |  |                                 |                         |   |  |   |
| Suitable for switching on contactor off-load  |  |                                 |                         |   |  |   |
|    | DILM7 -<br>DILM38<br>DILA                                  | <b>DILM32-XMAN</b><br>110955    |                         | 1 Off<br>    | –  | UL/CSA certification not required   |
| <b>Printed board contact</b>  |  |                                 |                         |   |  |   |
| For the adaption of a control circuit on a printed-circuit board                    |  |                                 |                         |   |  |   |
|  | DILM7 -<br>DILM15<br>DILA                                  | <b>DILM12-XPBC</b><br>109400    |                         | 4 Off   | –  | –   |
| <b>Load resistor</b>  |  |                                 |                         |   |  |   |
| For DC contactors in order to increase power consumption                            |  |                                 |                         |   |  |   |
|  | DILM17<br>DILM25<br>DILM32<br>DILM38<br>DILMP32<br>DILMP45 | <b>DILM32-XSPLW24</b><br>112419 |                         | 1 Off<br>  | Installed in a suppressor circuit enclosure. Required when using special PLC outputs for actuation, e.g.: Beckhoff safety controllers.   | Product Standards IEC/EN 60947-4-1;<br>CSA-C22.2 No.14-05;<br>CE marking<br>225135<br>CSA File No. 3211-07<br>CSA Class No. CSA certified<br>NA Certification   |
| <b>Extension terminals</b>  |  |                                 |                         |   |  |   |
|   | DILM80<br>DILM95<br>DILM115<br>DILM150<br>DILM170          | <b>DILM150-XZK</b><br>104486    |                         | 10 Off<br> | Can be fitted on every main terminal of the contactor.<br>Connection options:<br>maximum 2 x 4 mm <sup>2</sup> solid<br>maximum 2 x 2.5 mm <sup>2</sup><br>flexible with ferrule   | Product Standards IEC/EN 60947-4-1;<br>UL 508; CSA-C22.2<br>No.14-05;CE marking<br>E29184<br>UL File No. NKCR<br>UL CCN<br>CSA File No. 012528<br>CSA Class No. 2411-03, 2411-04<br>NA Certification UL Listed, CSA certified |
| <b>Cable terminal block</b>   |  |                                 |                         |   |  |   |
| With control circuit terminal<br>Consisting of three flat ribbon terminals          |  |                                 |                         |   |  |   |
|  | DILM250<br>DILM300A<br>DILM400                             | <b>DILM400-XKU-S</b><br>208293  |                         | 1 Off<br>  | Connection options:<br>round conductors,<br>flexible and stranded,<br>ribbon cables.   | Product Standards IEC/EN 60947-4-1;<br>UL 508; CSA-C22.2<br>No.14-05;CE marking<br>E29184<br>UL File No. NKCR<br>UL CCN<br>CSA File No. 012528<br>CSA Class No. 3211-04<br>NA Certification UL Listed, CSA certified          |

# 1.1

## Contactors relays, contactors



### Accessories

1

#### DILM...-XK... Flat strip conductor terminal kit

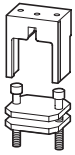





With control cable connection















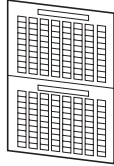

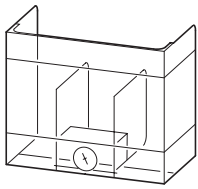



| For use with                             | Part no.<br>Article no.        | Price<br>See price list | Std. pack | Notes                                | Information relevant for export to North America<br>  |
|--|--------------------------------|-------------------------|-----------|--------------------------------------|---|
| DILM580<br>DILM650<br>DILM750<br>DILM820 | <b>DILM820-XKB-S</b><br>208295 |                         | 1 Off     | Connection options:<br>ribbon cables |   |

#### DILM...-XK... Connection terminal sets for North America

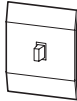
Consist of three individual terminals

| Conductor material  | Cross-section X<br>number of<br>cores<br>mm <sup>2</sup> | For use with   | Part no.<br>Article no.         | Price<br>See price list | Std. pack  | Notes  | Information relevant for export to North America<br>  |
|---------------------|--|--|---------------------------------|-------------------------|--|--|---|
| Copper,<br>aluminum | 2 x (AWG4 ...<br>MCM500)                                 | DILM500/22   | <b>DILM500-XK-CNA</b><br>232192 |                         | 1 Off<br>    | Including cover<br>With control<br>cable connec-<br>tion | Product Standards<br>IEC/EN 60947-4-1; UL 508;<br>CSA-C22.2 No.14-05;<br>CE marking<br>E29184<br>NKCR<br>UL File No.<br>UL CCN<br>CSA File No.<br>CSA Class No.<br>NA Certification   |
| Copper,<br>aluminum | 4 x (AWG2 ...<br>MCM500)                                 | DILM580/22<br>DILM650/22<br>DILM750/22<br>DILM820/22 | <b>DILM820-XK-CNA</b><br>232194 |                         | 1 Off<br>  |  | UL File No.<br>UL CCN<br>CSA File No.<br>CSA Class No.<br>NA Certification  |

## DILM...-XHB, DILM...-XAB

| Description   | For use with  | Part no.<br>Article no.        | Price<br>See price list  | Std. pack   | Notes   | Information relevant for export to<br>North America<br> |
|---|---|--------------------------------|--|---|---|--|
| <b>Sealable shrouds</b>   |   |                                |  |   |   |  |
| Transparent   |   |                                |  |   |   |  |
|    | DILM32-XTE...   | <b>DILM32-XTEPLH</b><br>101449 |  | 1 Off   | -   | -  |
| <b>Device labelling, label sheet</b>  |   |                                |  |   |   |  |
| 7.5 x 17 mm<br>Colour: yellow HKS 3<br>(≈ RAL 1018)                                 |   |                                |  |   |   |  |
|    | Labelling with laser printer, plotter, film plotter, copier | <b>XGKE-GE</b><br>207517       |  | 25 Off<br>   | 1 off = 1 sheet<br>240 labels per sheet<br>1 sheet = DIN A4,<br>Can be split into two DIN A5 sheets | UL/CSA certification not required  |
| <b>Covers</b>   |   |                                |  |   |   |  |
| Terminal cover  |   |                                |  |   |   |  |
|   | DILM185A  | <b>DILM225A-XHB</b><br>139560  |  | 1 Off<br>    | To provide terminals with protection against accidental contact vertical from the front             | UL/CSA certification not required  |
|   | DILM225A  |                                |  |   |   |  |
|   | DILM250   | <b>DILM400-XHB</b><br>208287   |  | 1 Off<br>   |   |  |
|   | DILM300A  |                                |  |   |   |  |
|   | DILM400   |                                |  |   |   |  |
|   | DILM500   | <b>DILM500-XHB</b><br>208286   |  | 1 Off<br>  |   |  |
| DILM580   | <b>DILM650-XHB</b><br>208285                                |                                | 1 Off<br> |   |   |  |
| DILM650   |   |                                |  |   |   |  |
| DILM750   | <b>DILM820-XHB</b><br>208284                                |                                | 1 Off<br> |   |   |  |
| DILM820,  |   |                                |  |   |   |  |
| DILM1000  |   |                                |  |   |   |  |
| <b>Shroud for star-point bridge</b>   |   |                                |  |   |   |  |
|  | DILM400-XS1   | <b>DILM400-XHBS1</b><br>101687 |  | 1 Off<br>  | Can be combined with star-delta wiring kits DILM250-XSL and DILM400-XSL.                            | UL/CSA certification not required  |
| <b>Auxiliary contact seat cover</b>   |   |                                |  |   |   |  |
|  | DILM7 - DILM38<br>DILMP32<br>DILMP45<br>DILA<br>DILL        | <b>DILM32-XAB</b><br>129538    |  | 10 Off<br> | For preventing manual actuation. Cannot be combined with additional surface mounting accessories    | UL/CSA certification not required  |
|  | DILM40 -<br>DILM170<br>DILMP63 -<br>DILMP200                | <b>DILM150-XAB</b><br>121712   |  | 10 Off<br> |   |  |
| <b>Suppressor circuits for vacuum contactors<br/>(on load side)</b>                 |   |                                |  |   |   |  |
|  | DILM580   | <b>DILM1000-XSM</b><br>125947  |  | 1 Off<br>  | For damping the cutout overvoltage when switching off inductive loads.                              | NA Certification Request filed for UL and CSA  |
|   | DILM650   |                                |  |   |   |  |
| DILM750   |   |                                |  |   |   |  |
| DILM820   |   |                                |  |   |   |  |
| DILM1000  |   |                                |  |   |   |  |
| DILH2000  | <b>DILH2600-XSM</b><br>125946                               |                                | 1 Off<br> |   |   |  |
| DILH2200  |   |                                |  |   |   |  |
| DILH2600  |   |                                |  |   |   |  |

# 1.1

## Contactors relays, contactors

### Accessories

1

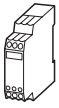

#### DILM...-XSP... Amplifier module for separate mounting

Input with integrated suppressor circuit for overvoltage limitation

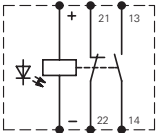
| Rated operational current |       | Actuating voltage | Actuating current | Circuit symbol | For use with  | Part no.<br>Article no.  | Price<br>See price list | Std. pack | Information relevant for export to North America  |
|---------------------------|-------|-------------------|-------------------|----------------|---|--|-------------------------|-----------|---|
| AC-15                     | DC    |                   |                   |                |   |  |                         |           |   |
| 230 V                     | 400 V | 220 V             |                   |                |   |  |                         |           |   |
| $I_e$                     | $I_e$ | $I_e$             | $U_s$             | $I$            |   |  |                         |           |   |
| A                         | A     | A                 | V DC              | mA             |   |  |                         |           |   |
| 2                         | 2     | 0.03              | 24                | 25             |  | ...DILM<br>DIMLP...<br>DILL...<br>DILK...<br><b>ETS4-VS3</b><br>083094 |                         | 1 Off<br> | Product Standards<br>IEC/EN 60947-4-1;<br>UL 508;<br>CSA-C22.2 No. 14-05;<br>CE marking<br>E36332<br>NLRV<br>UL File No.<br>UL CCN<br>CSA File No.<br>CSA Class No.<br>NA Certification<br>UL Listed, CSA certified |

**Notes** Contactor coils with rated operational current > 2 A must be actuated via the DILER-G mini contactor relay.  
Rated operational current DC:  
Making and breaking conditions DC-13, time L/R 300ms

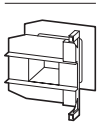

#### DILM...-XSP... Individual coils

| For use with                         | DC voltage | Part no.<br>Article no.                           | Prices<br>See price list | AC voltage   | Part no.<br>Article no. | Price<br>See price list | Std. pack | Notes                                       |
|--------------------------------------|------------|---|--------------------------|--|-------------------------|-------------------------|-----------|---|
| DILM17<br>DILM25<br>DILM32<br>DILM38 |            | <b>DILM32-XSP(RDC24)<sup>1)</sup></b><br>281155   |                          | <b>DILM32-XSP(230V50Hz,240V60Hz)</b><br>281141     |                         |                         | 1 Off<br> | For additional actuating voltages → Page 75 |
| DILM40<br>DILM50<br>DILM65<br>DILM72 |            | <b>DILM65-XSP(RDC24)<sup>1)</sup></b><br>281185   |                          | <b>DILM65-XSP(230V50Hz,240V60Hz)</b><br>281171     |                         |                         | 1 Off<br> |   |
| DILM80<br>DILM95                     |            | <b>DILM95-XSP(RDC24)<sup>1)</sup></b><br>230080   |                          | <b>DILM95-XSP(230V50Hz,240V60Hz)</b><br>230062     |                         |                         | 1 Off<br> |   |
| DILM115<br>DILM150<br>DILM170        |            | <b>DILM150-XSP(RDC24)<sup>1)</sup></b><br>230115  |                          | <b>DILM150-XSP(RAC240)<sup>1)</sup></b><br>230112  |                         |                         | 1 Off<br> |   |
| DILM185A<br>DILM225A                 |            | <b>DILM225A-XSP(RDC24)<sup>1)</sup></b><br>139568 |                          | <b>DILM225A-XSP(RAC240)<sup>1)</sup></b><br>139565 |                         |                         | 1 Off<br> |   |

**Notes** <sup>1)</sup> Incl. electronic module

#### Information relevant for export to North America

|  |                   |  |
|--|-------------------|--|
|  | Product Standards | IEC/EN 60947-4-1; UL 508; CSA-C22.2 No.14-05; CE marking |
|  | UL File No.       | E29096   |
|  | UL CCN            | NLDX   |
|  | CSA File No.      | 012528   |
|  | CSA Class No.     | 2411-03, 3211-04   |
|  | NA Certification  | UL Listed, CSA certified                                 |

## DILM...-XSP/E... Electronic modules including coils

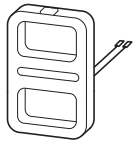
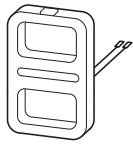

| For use with   | DC voltage<br>Part no.<br>Article no.                | Price<br>See price<br>list | AC voltage<br>Part no.<br>Article no.                           | Price<br>See price<br>list | Std. pack | Notes  |
|--|--|----------------------------|---|----------------------------|-----------|--|
| DILM250<br>DILM300A                                  | <b>DILM250-XSP/E(RA250)</b> <sup>1)</sup><br>208252  |                            | <b>DILM250-XSP/E(RA250)</b> <sup>1)</sup><br>208252             |                            | 1 Off<br> | For additional actuating voltages<br>→ Page 77 |
| DILM400<br>DILM500                                   | <b>DILM500-XSP/E(RA250)</b> <sup>1)</sup><br>208256  |                            | <b>DILM500-XSP/E(RA250)</b> <sup>1)</sup><br>208256             |                            | 1 Off<br> |  |
| DILM580<br>DILM650<br>DILM750<br>DILM820<br>DILM1000 | <b>DILM1000-XSP/E(RA250)</b> <sup>1)</sup><br>289145 |                            | <b>DILM1000-XSP/E(RA250)</b> <sup>1)</sup><br>289145            |                            | 1 Off<br> |  |
| DILH1400   | –  |                            | <b>DILH1400-XSP/E(RAW250)</b> <sup>2)</sup><br>289161           |                            | 1 Off<br> |  |
| DILM250-S<br>DILM300A-S                              | –  |                            | <b>DILM250-S-XSP/E(220-240V50/60Hz)</b> <sup>2)</sup><br>274202 |                            | 1 Off<br> |  |
| DILM400-S<br>DILM500-S                               | –  |                            | <b>DILM500-S-XSP/E(220-240V50/60Hz)</b> <sup>2)</sup><br>274205 |                            | 1 Off<br> |  |

1)

### Information relevant for export to North America



|                   |  |
|-------------------|--|
| Product Standards | IEC/EN 60947-4-1; UL 508; CSA-C22.2 No.14-05; CE marking |
| UL File No.       | E29096   |
| UL CCN            | NLDX   |
| CSA File No.      | 1017510  |
| CSA Class No.     | 3211-04  |
| NA Certification  | UL Listed, CSA certified                                 |

2)

### Information relevant for export to North America



|                   |  |
|-------------------|--|
| Product Standards | IEC/EN 60947-4-1; UL 508; CSA-C22.2 No.14-05; CE marking |
| UL File No.       | E29096   |
| UL CCN            | NLDX   |
| CSA File No.      | 012528   |
| CSA Class No.     | 3211-04  |
| NA Certification  | UL Listed, CSA certified                                 |



# 1.1 Contactor monitoring devices

## 1 Description, ordering



### General

For safety-related off switching to safety category 3 and 4 according to EN 954-1, at present two contactors must be used in series. Especially with larger contactors this is an expensive solution.

### Application

This is where the CMD can be used. The function of the CMD is to monitor the main contacts of a contactor against welding. For this the control voltage of the contactor is compared with the state of the main contacts which is reliably monitored using a mirror contact (IEC EN 60947-4-1 Annex F). If the coil is de-energized and the contactor does not drop out the CMD trips the upstream circuit-breaker/motor protective circuit breaker/switch-disconnector via a shunt release.

### Safety

The CMD has a safety-compliant design so that in safety combinations with a circuit-breaker/motor protective circuit breaker/switch disconnector the reliable switch off in the case of a "welded contactor" can be guaranteed. In this application it replaces the series connection of a second contactor. As a component it conforms to safety category 3 according to EN 954-1 and EN ISO 13849.

### Mounting

The CMD can be combined with the following Eaton components:

- Contactors:
  - DILEM
  - DILM7 to DILM150
  - DILM185(-S) to DILM500(-S):
  - DILM580 to DILM1600
  - DILH1400 ... DILH2000
  - SE-1A-PKZ2 and S-PKZ2
- Motor-protective circuit-breakers/circuit-breakers:
  - PKZ2 + U-PKZ2(18VDC)
  - NZM1 + NZM1-XUVL
  - NZM2 + NZM2/3-XUV
  - NZM3 + NZM2/3-XUV
  - NZM4 + NZM4-XUV
  - N1 + NZM1-XUVL
  - N2 + NZM2/3-XUV
  - N3 + NZM2/3-XUV
  - N4 + NZM4-XUV

For the wiring of the CMD the auxiliary N/C contact, mirror contact must be according to IEC/EN 60947-4-1 and the auxiliary N/O contact must be interlocked and opposing according to IEC/EN 60947-5-1. Also the auxiliary N/C contact for the feedback circuit must have a mirror contact function according to IEC/EN 60947-4-1.

### Auxiliary contact requirements per contactor:

|                   | CMD              | Self maintaining | Feedback circuit | Electrical interlock |
|-------------------|------------------|------------------|------------------|----------------------|
| DOL starter       | 1 N/O +<br>1 N/C | 1S               | 1 B              |                      |
| Reversing starter | 1 N/O +<br>1 N/C | 1S               | 1 B              | 1 B                  |

## Ordering

### CMD contactor monitoring device

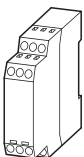

### CMD

| Part no.<br>Article no.          | Price<br>See Price List | Std. pack |
|----------------------------------|-------------------------|-----------|
| <b>CMD(24VDC)</b><br>106170      |                         | 1 Off     |
| <b>CMD(220-240VAC)</b><br>106172 |                         | 1 Off     |

Engineering

DOL starter

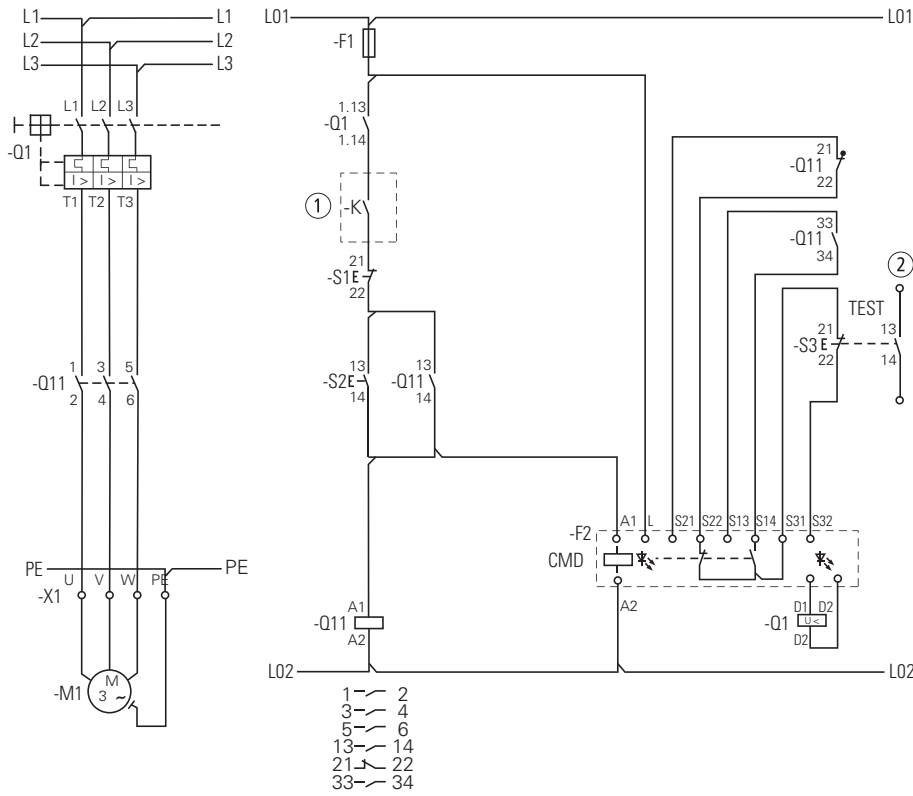

Reversing starter

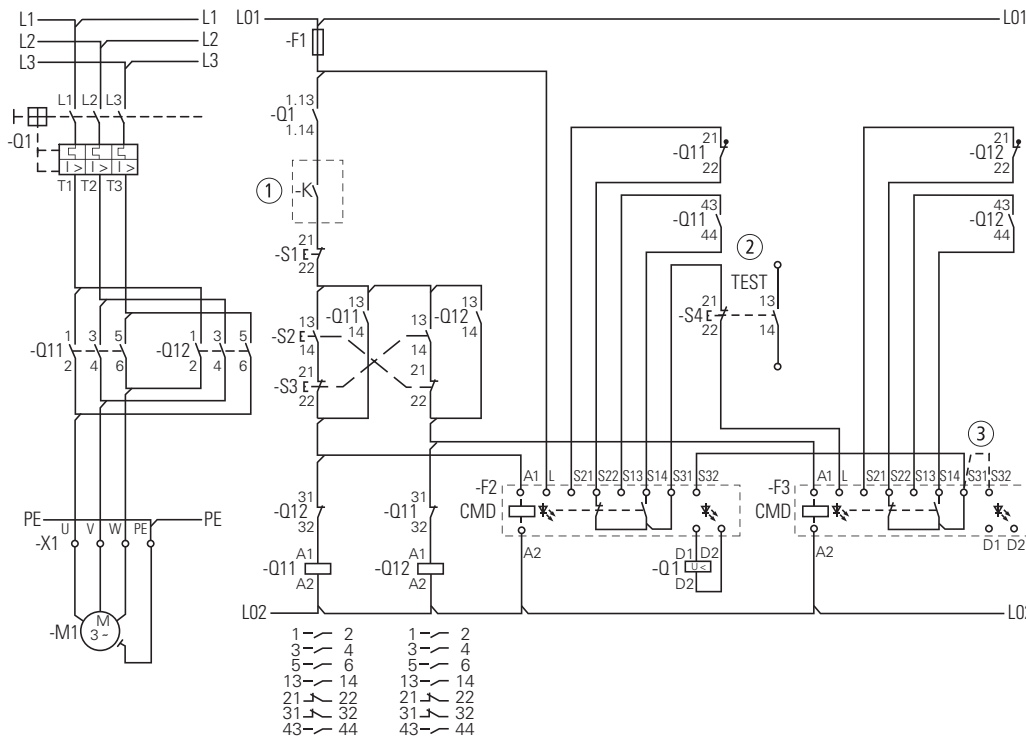

- ① Switching by safety relay of safety PLC
- ② Signal contact to PLC evaluation
- ③ CMD (24VDC)

# 1.1

## Mini contactor relays, contactor relays

Actuating voltages

### 1 Ordering

#### DILER, DILEEM

| AC                              | DILER-40(...)             | DILER-31(...)             | DILER-22(...)             | DILEEM-10(...)            | DILEEM-01(...)            |
|---------------------------------|---------------------------|---------------------------|---------------------------|---------------------------|---------------------------|
|                                 | Article no. <sup>1)</sup> | Article no. <sup>1)</sup> | Article no. <sup>1)</sup> | Article no. <sup>1)</sup> | Article no. <sup>1)</sup> |
| <b>Standard voltages</b>        | See price list            | See price list            | See price list            | See price list            | See price list            |
| <b>24V 50Hz</b>                 | 010094                    | 010251                    | 010344                    | 051604                    | 051629                    |
| <b>48V 50Hz</b>                 | 010190                    | 010044                    | 010201                    | 051603                    | 051628                    |
| <b>240V 50Hz</b>                | 010478                    | 010300                    | 010138                    | 051602                    | 051627                    |
| <b>115V 60Hz</b>                | 010270                    | 010204                    | 010211                    | 051598                    | 051624                    |
| <b>42V 50Hz,<br/>48V 60Hz</b>   | –                         | –                         | –                         | 051612                    | 051637                    |
| <b>110V 50Hz,<br/>120V 60Hz</b> | 051756                    | 051765                    | 051774                    | 051611                    | 051636                    |
| <b>190V 50Hz,<br/>220V 60Hz</b> | 051757                    | 051766                    | 051775                    | 051610                    | 051635                    |
| <b>220V 50Hz,<br/>240V 60Hz</b> | 051758                    | 051767                    | 051776                    | 051609                    | 051634                    |
| <b>230V 50Hz,<br/>240V 60Hz</b> | 051759                    | 051768                    | 051777                    | 051608                    | 051633                    |
| <b>380V 50Hz,<br/>440V 60Hz</b> | 051760                    | 051769                    | 051778                    | 051607                    | 051632                    |
| <b>400V 50Hz,<br/>440V 60Hz</b> | 051761                    | 051770                    | 051779                    | 051606                    | 051631                    |
| <b>415V 50Hz,<br/>480V 60Hz</b> | 051762                    | 051771                    | 051780                    | 051605                    | 051630                    |
| <b>24V 50/60Hz</b>              | 021924                    | 021594                    | 021704                    | 051596                    | 051621                    |
| <b>42V 50/60Hz</b>              | 033459                    | 029869                    | 029433                    | 051595                    | 051620                    |
| <b>110V 50/60Hz</b>             | 021961                    | 021624                    | 021871                    | 051592                    | 051618                    |
| <b>230V 50/60Hz</b>             | 052725                    | 052509                    | 052508                    | 056674                    | 058771                    |

#### DILER, DILEEM

| DC                       | DILER-40-G(...)           | DILER-31-G(...)           | DILER-22-G(...)           | DILEEM-10-G(...)          | DILEEM-01-G(...)          |
|--------------------------|---------------------------|---------------------------|---------------------------|---------------------------|---------------------------|
|                          | Article no. <sup>1)</sup> | Article no. <sup>1)</sup> | Article no. <sup>1)</sup> | Article no. <sup>1)</sup> | Article no. <sup>1)</sup> |
| <b>Standard voltages</b> | See price list            | See price list            | See price list            | See price list            | See price list            |
| <b>12V DC</b>            | 079711                    | 079761                    | 080728                    | 051644                    | 051649                    |
| <b>24V DC</b>            | 010223                    | 010157                    | 010042                    | 051643                    | 051650                    |
| <b>48V DC</b>            | 010255                    | 010205                    | 010346                    | 051642                    | 051648                    |
| <b>110V DC</b>           | 010287                    | 010253                    | 010043                    | 051640                    | 051646                    |
| <b>220V DC</b>           | 010303                    | 010269                    | 010091                    | 051639                    | 051645                    |

#### Notes

<sup>1)</sup> To obtain the article number for ordering, read under selected part number and actuating voltage from the table.  
Devices with dual-voltage coils are to be ordered under a single article number.

## DILEM

| AC                              | DILEM-10(...)             | DILEM-01(...)             | DILEM12-10(...)           | DILEM12-01(...)           | DILEM4(...)               |
|---------------------------------|---------------------------|---------------------------|---------------------------|---------------------------|---------------------------|
|                                 | Article no. <sup>1)</sup> | Article no. <sup>1)</sup> | Article no. <sup>1)</sup> | Article no. <sup>1)</sup> | Article no. <sup>1)</sup> |
| <b>Standard voltages</b>        | See price list            | See price list            | See price list            | See price list            | See price list            |
| <b>24V 50Hz</b>                 | 010005                    | 010086                    | 127067                    | 127083                    | 014754                    |
| <b>48V 50Hz</b>                 | 010020                    | 010294                    | –                         | –                         | –                         |
| <b>240V 50Hz</b>                | 010032                    | 010151                    | –                         | –                         | 014305                    |
| <b>115V 60Hz</b>                | 010024                    | 010470                    | –                         | –                         | –                         |
| <b>42V 50Hz,<br/>48V 60Hz</b>   | 051782                    | 051791                    | –                         | –                         | –                         |
| <b>110V 50Hz,<br/>120V 60Hz</b> | 051783                    | 051792                    | 127072                    | 127088                    | 051801                    |
| <b>190V 50Hz,<br/>220V 60Hz</b> | 051784                    | 051793                    | –                         | –                         | –                         |
| <b>220V 50Hz,<br/>240V 60Hz</b> | 051785                    | 051794                    | –                         | –                         | 051803                    |
| <b>230V 50Hz,<br/>240V 60Hz</b> | 051786                    | 051795                    | –                         | –                         | 051804                    |
| <b>380V 50Hz,<br/>440V 60Hz</b> | 051787                    | 051796                    | –                         | –                         | –                         |
| <b>400V 50Hz,<br/>440V 60Hz</b> | 051788                    | 051797                    | –                         | –                         | 051806                    |
| <b>415V 50Hz,<br/>480V 60Hz</b> | 051789                    | –                         | –                         | –                         | –                         |
| <b>24V 50/60Hz</b>              | 021417                    | 020402                    | 127079                    | 127095                    | 022044                    |
| <b>42V 50/60Hz</b>              | 032174                    | 033233                    | –                         | –                         | –                         |
| <b>110V 50/60Hz</b>             | 021455                    | 020436                    | 127081                    | 127097                    | –                         |
| <b>230V 50/60Hz</b>             | 052302                    | 051114                    | 127082                    | 127098                    | 052506                    |

## DILEM

| DC                       | DILEM-10-G(...)           | DILEM-01-G(...)           | DILEM12-10-G(...)         | DILEM12-01-G(...)         | DILEM4-G(...)             |
|--------------------------|---------------------------|---------------------------|---------------------------|---------------------------|---------------------------|
|                          | Article no. <sup>1)</sup> | Article no. <sup>1)</sup> | Article no. <sup>1)</sup> | Article no. <sup>1)</sup> | Article no. <sup>1)</sup> |
| <b>Standard voltages</b> | See price list            | See price list            | See price list            | See price list            | See price list            |
| <b>12V DC</b>            | 079594                    | 079642                    | –                         | –                         | 079680                    |
| <b>24V DC</b>            | 010213                    | 010343                    | 127132                    | 127137                    | 012701                    |
| <b>48V DC</b>            | 010245                    | 010496                    | –                         | –                         | –                         |
| <b>110V DC</b>           | 010309                    | 010136                    | –                         | –                         | –                         |
| <b>220V DC</b>           | 010325                    | 010168                    | –                         | –                         | –                         |

### Notes

<sup>1)</sup> To obtain the article number for ordering, read under selected part number and actuating voltage from the table. Devices with **dual-voltage coils** are to be ordered under a **single** article number.

# 1.1

## Contactor relays

Actuating voltages

### 1 DILA

AC

|   | With screw terminals      |                           |                           | With Spring-loaded terminals |                           |                           |
|---|---------------------------|---------------------------|---------------------------|------------------------------|---------------------------|---------------------------|
|   | DILA-40(...)              | DILA-31(...)              | DILA-22(...)              | DILAC-40(...)                | DILAC-31(...)             | DILAC-22(...)             |
|   | Article no. <sup>1)</sup> | Article no. <sup>1)</sup> | Article no. <sup>1)</sup> | Article no. <sup>1)</sup>    | Article no. <sup>1)</sup> | Article no. <sup>1)</sup> |
| <b>Standard voltages</b>  | See price list            | See price list            | See price list            | See price list               | See price list            | See price list            |
| <b>24V 50Hz</b>   | 276316                    | 276351                    | 276386                    | 276431                       | 276463                    | 276495                    |
| <b>240V 50Hz</b>  | 276318                    | 276353                    | 276388                    | –                            | –                         | –                         |
| <b>110V 50Hz<br/>120V 60Hz</b>  | 276326                    | 276361                    | 276396                    | 276438                       | 276470                    | 276502                    |
| <b>190V 50Hz<br/>220V 60Hz</b>  | 276327                    | 276362                    | 276397                    | –                            | –                         | –                         |
| <b>220V 50Hz<br/>240V 60Hz</b>  | 276328                    | 276363                    | 276398                    | –                            | –                         | –                         |
| <b>230V 50Hz<br/>240V 60Hz</b>  | 276329                    | 276364                    | 276399                    | 276441                       | 276473                    | 276505                    |
| <b>380V 50Hz<br/>440V 60Hz</b>  | 276330                    | 276365                    | 276400                    | –                            | –                         | –                         |
| <b>400V 50Hz<br/>440V 60Hz</b>  | 276331                    | 276366                    | 276401                    | –                            | –                         | –                         |
| <b>24V 50Hz/60Hz</b>  | 276333                    | 276368                    | 276403                    | 276445                       | 276477                    | 276509                    |
| <b>42V 50Hz/60Hz</b>  | 276334                    | 276369                    | 276404                    | –                            | –                         | –                         |
| <b>110V 50Hz/60Hz</b>   | 276335                    | 276370                    | 276405                    | –                            | –                         | –                         |
| <b>220V 50Hz/60Hz</b>   | 276336                    | 276371                    | 276406                    | –                            | –                         | –                         |
| <b>230V 50Hz/60Hz</b>   | 276337                    | 276372                    | 276407                    | 276449                       | 276481                    | 276513                    |
| Special voltages other than the already shown normal voltages <sup>2)</sup> | See price list            | See price list            | See price list            | See price list               | See price list            | See price list            |
| <b>...V 50Hz(12-500V)<sup>3)</sup></b>                                      | 276341                    | 276376                    | 276411                    | 276453                       | 276485                    | 276517                    |
| <b>...V 60Hz(12-600V)<sup>3)</sup></b>                                      | 276342                    | 276377                    | 276412                    | 276454                       | 276486                    | 276518                    |

### DILA

DC

|   | With screw terminals      |                           |                           | With Spring-loaded terminals |                           |                           |
|---|---------------------------|---------------------------|---------------------------|------------------------------|---------------------------|---------------------------|
|   | DILA-40(...)              | DILA-31(...)              | DILA-22(...)              | DILAC-40(...)                | DILAC-31(...)             | DILAC-22(...)             |
|   | Article no. <sup>1)</sup> | Article no. <sup>1)</sup> | Article no. <sup>1)</sup> | Article no. <sup>1)</sup>    | Article no. <sup>1)</sup> | Article no. <sup>1)</sup> |
| <b>Standard voltages</b>  | See price list            | See price list            | See price list            | See price list               | See price list            | See price list            |
| <b>24V DC</b>   | 276344                    | 276379                    | 276414                    | 276456                       | 276488                    | 276520                    |
| <b>48V DC</b>   | 276345                    | 276380                    | 276415                    | –                            | –                         | –                         |
| <b>110V DC</b>  | 276347                    | 276382                    | 276417                    | 276459                       | 276491                    | 276523                    |
| <b>220V DC</b>  | 276348                    | 276383                    | 276418                    | 276460                       | 276492                    | 276524                    |
| Special voltages other than the already shown normal voltages <sup>2)</sup> | See price list            | See price list            | See price list            | See price list               | See price list            | See price list            |
| <b>...V DC(12-250V)<sup>3)</sup></b>  | 276349                    | 276384                    | 276419                    | 276461                       | 276493                    | 276525                    |

#### Notes

<sup>1)</sup> The article number is a combination of part no. and operating voltage devices with dual-voltage coils can be ordered under a single article no.

<sup>2)</sup> With non-standard voltages the required actuating voltage from the defined range (...-...V) must be stated.

<sup>3)</sup> Minimum order quantity 10 units

**DILM**

| AC  | DILM7-10<br>(...)         | DILM7-01<br>(...)         | DILM9-10<br>(...)         | DILM9-01<br>(...)         | DILM12-10<br>(...)        | DILM12-01<br>(...)        | DILM15-10<br>(...)        | DILM15-01<br>(...)        |
|---|---------------------------|---------------------------|---------------------------|---------------------------|---------------------------|---------------------------|---------------------------|---------------------------|
|   | Article no. <sup>1)</sup> | Article no. <sup>1)</sup> | Article no. <sup>1)</sup> | Article no. <sup>1)</sup> | Article no. <sup>1)</sup> | Article no. <sup>1)</sup> | Article no. <sup>1)</sup> | Article no. <sup>1)</sup> |
| <b>Standard voltages</b>  | See price list            | See price list            | See price list            | See price list            | See price list            | See price list            | See price list            | See price list            |
| <b>24V 50Hz</b>   | 276537                    | 276572                    | 276677                    | 276712                    | 276817                    | 276852                    | 290045                    | 290080                    |
| <b>240V 50Hz</b>  | 276539                    | 276574                    | 276679                    | 276714                    | 276819                    | 276854                    | –                         | –                         |
| <b>42V 50Hz</b>   | 276546                    | –                         | 276686                    | –                         | 276826                    | –                         | –                         | –                         |
| <b>48V 60Hz</b>   |                           |                           |                           |                           |                           |                           |                           |                           |
| <b>110V 50Hz</b>  | 276547                    | 276582                    | 276687                    | 276722                    | 276827                    | 276862                    | 290055                    | 290090                    |
| <b>120V 60Hz</b>  |                           |                           |                           |                           |                           |                           |                           |                           |
| <b>190V 50Hz</b>  | 276548                    | 276583                    | 276688                    | 276723                    | 276828                    | 276863                    | –                         | –                         |
| <b>220V 60Hz</b>  |                           |                           |                           |                           |                           |                           |                           |                           |
| <b>220V 50Hz</b>  | 276549                    | 276584                    | 276689                    | 276724                    | 276829                    | 276864                    | –                         | –                         |
| <b>240V 60Hz</b>  |                           |                           |                           |                           |                           |                           |                           |                           |
| <b>230V 50Hz</b>  | 276550                    | 276585                    | 276690                    | 276725                    | 276830                    | 276865                    | 290058                    | 290093                    |
| <b>240V 60Hz</b>  |                           |                           |                           |                           |                           |                           |                           |                           |
| <b>380V 50Hz</b>  | 276551                    | 276586                    | 276691                    | 276726                    | 276831                    | 276866                    | –                         | –                         |
| <b>440V 60Hz</b>  |                           |                           |                           |                           |                           |                           |                           |                           |
| <b>400V 50Hz</b>  | 276552                    | 276587                    | 276692                    | 276727                    | 276832                    | 276867                    | –                         | –                         |
| <b>440V 60Hz</b>  |                           |                           |                           |                           |                           |                           |                           |                           |
| <b>415V 50Hz</b>  | 276553                    | –                         | 276693                    | –                         | 276833                    | –                         | –                         | –                         |
| <b>480V 60Hz</b>  |                           |                           |                           |                           |                           |                           |                           |                           |
| <b>24V 50Hz/60Hz</b>  | 276554                    | 276589                    | 276694                    | 276729                    | 276834                    | 276869                    | 290062                    | 290097                    |
| <b>42V 50Hz/60Hz</b>  | 276555                    | 276590                    | 276695                    | 276730                    | 276835                    | 276870                    | –                         | –                         |
| <b>110V 50Hz/60Hz</b>   | 276556                    | 276591                    | 276696                    | 276731                    | 276836                    | 276871                    | –                         | –                         |
| <b>220V 50Hz/60Hz</b>   | 276557                    | 276592                    | 276697                    | 276732                    | 276837                    | 276872                    | –                         | –                         |
| <b>230V 50Hz/60Hz</b>   | 276558                    | 276593                    | 276698                    | 276733                    | 276838                    | 276873                    | 290066                    | 290101                    |
| Special voltages other than the already shown normal voltages <sup>2)</sup> | See price list            | See price list            | See price list            | See price list            | See price list            | See price list            | See price list            | See price list            |
| <b>...V 50Hz (12 – 600V)<sup>3)</sup></b>                                   | 276562                    | 276597                    | 276702                    | 276737                    | 276842                    | 276877                    | 290070                    | 290105                    |
| <b>...V 60Hz (12 – 600V)<sup>3)</sup></b>                                   | 276563                    | 276598                    | 276703                    | 276738                    | 276843                    | 276878                    | 290071                    | 290106                    |

**DILM**

| DC  | DILM7-10<br>(...)         | DILM7-01<br>(...)         | DILM9-10<br>(...)         | DILM9-01<br>(...)         | DILM12-10<br>(...)        | DILM12-01<br>(...)        | DILM15-10<br>(...)        | DILM15-01<br>(...)        |
|---|---------------------------|---------------------------|---------------------------|---------------------------|---------------------------|---------------------------|---------------------------|---------------------------|
|   | Article no. <sup>1)</sup> | Article no. <sup>1)</sup> | Article no. <sup>1)</sup> | Article no. <sup>1)</sup> | Article no. <sup>1)</sup> | Article no. <sup>1)</sup> | Article no. <sup>1)</sup> | Article no. <sup>1)</sup> |
| <b>Standard voltages</b>  | See price list            | See price list            | See price list            | See price list            | See price list            | See price list            | See price list            | See price list            |
| <b>24V DC</b>   | 276565                    | 276600                    | 276705                    | 276740                    | 276845                    | 276880                    | 290073                    | 290108                    |
| <b>48V DC</b>   | 276566                    | 276601                    | 276706                    | 276741                    | 276846                    | 276881                    | –                         | –                         |
| <b>110V DC</b>  | 276568                    | 276603                    | 276708                    | 276743                    | 276848                    | 276883                    | –                         | –                         |
| <b>220V DC</b>  | 276569                    | 276604                    | 276709                    | 276744                    | 276849                    | 276884                    | –                         | –                         |
| Special voltages other than the already shown normal voltages <sup>2)</sup> | See price list            | See price list            | See price list            | See price list            | See price list            | See price list            | See price list            | See price list            |
| <b>...V DC (12-250V)<sup>3)</sup></b>                                       | 276570                    | 276605                    | 276710                    | 276745                    | 276850                    | 276885                    | 290078                    | 290113                    |

**Notes**

- <sup>1)</sup> To obtain the article number for ordering, read under selected part number and actuating voltage from the table. devices with dual-voltage coils can be ordered under a single article no.
- <sup>2)</sup> With non-standard voltages the required actuating voltage from the defined range (...–...V) must be stated.
- <sup>3)</sup> Minimum order quantity 10 units

## 1 DILM

| AC  | DILM17-10<br>(...)        | DILM17-01<br>(...)        | DILM25-10<br>(...)        | DILM25-01<br>(...)        | DILM32-10<br>(...)        | DILM32-01<br>(...)        | DILM38-10(...)<br>(...)   | DILM38-01(...)<br>(...)   |
|---|---------------------------|---------------------------|---------------------------|---------------------------|---------------------------|---------------------------|---------------------------|---------------------------|
|   | Article no. <sup>1)</sup> | Article no. <sup>1)</sup> | Article no. <sup>1)</sup> | Article no. <sup>1)</sup> | Article no. <sup>1)</sup> | Article no. <sup>1)</sup> | Article no. <sup>1)</sup> | Article no. <sup>1)</sup> |
| <b>Standard voltages</b>  | See price list            | See price list            | See price list            | See price list            | See price list            | See price list            | See price list            | See price list            |
| <b>24V 50Hz</b>   | 276991                    | 277023                    | 277119                    | 277151                    | 277247                    | 277279                    | 112378                    | 112446                    |
| <b>240V 50Hz</b>  | 276993                    | –                         | 277121                    | –                         | 277249                    | –                         | 112420                    | –                         |
| <b>42V 50Hz</b>   | 277000                    | –                         | 277128                    | –                         | 277256                    | –                         | 112424                    | –                         |
| <b>48V 60Hz</b>   |                           |                           |                           |                           |                           |                           |                           |                           |
| <b>110V 50Hz</b>  | 277001                    | 277033                    | 277129                    | 277161                    | 277257                    | 277289                    | 112425                    | 112454                    |
| <b>120V 60Hz</b>  |                           |                           |                           |                           |                           |                           |                           |                           |
| <b>190V 50Hz</b>  | 277002                    | –                         | 277130                    | –                         | 277258                    | –                         | 112426                    | –                         |
| <b>220V 60Hz</b>  |                           |                           |                           |                           |                           |                           |                           |                           |
| <b>220V 50Hz</b>  | 277003                    | –                         | 277131                    | –                         | 277259                    | –                         | 112427                    | –                         |
| <b>240V 60Hz</b>  |                           |                           |                           |                           |                           |                           |                           |                           |
| <b>230V 50Hz</b>  | 277004                    | 277036                    | 277132                    | 277164                    | 277260                    | 277292                    | 112428                    | 112457                    |
| <b>240V 60Hz</b>  |                           |                           |                           |                           |                           |                           |                           |                           |
| <b>380V 50Hz</b>  | 277005                    | –                         | 277133                    | –                         | 277261                    | –                         | 112429                    | –                         |
| <b>440V 60Hz</b>  |                           |                           |                           |                           |                           |                           |                           |                           |
| <b>400V 50Hz</b>  | 277006                    | 277038                    | 277134                    | 277166                    | 277262                    | 277294                    | 112430                    | 112459                    |
| <b>440V 60Hz</b>  |                           |                           |                           |                           |                           |                           |                           |                           |
| <b>415V 50Hz</b>  | 277007                    | –                         | 277135                    | –                         | 277263                    | –                         | 112431                    | –                         |
| <b>480V 60Hz</b>  |                           |                           |                           |                           |                           |                           |                           |                           |
| <b>24V 50Hz/60Hz</b>  | 277008                    | 277040                    | 277136                    | 277168                    | 277264                    | 277296                    | 112432                    | 112461                    |
| <b>42V 50Hz/60Hz</b>  | 277009                    | –                         | 277137                    | –                         | 277265                    | –                         | 112433                    | –                         |
| <b>110V 50Hz/60Hz</b>   | 277010                    | 277042                    | 277138                    | 277170                    | 277266                    | 277298                    | 112434                    | 112463                    |
| <b>220V 50Hz/60Hz</b>   | 277011                    | 277043                    | 277139                    | 277171                    | 277267                    | 277299                    | 112435                    | 112464                    |
| <b>230V 50Hz/60Hz</b>   | 277012                    | 277044                    | 277140                    | 277172                    | 277268                    | 277300                    | 112436                    | 112465                    |
| Special voltages<br>other than the already<br>shown normal voltages <sup>2)</sup> | See price list            | See price list            | See price list            | See price list            | See price list            | See price list            | See price list            | See price list            |
| <b>...V 50Hz (24 – 600V)</b>  | 277016 <sup>7)</sup>      | 277048 <sup>7)</sup>      | 277144 <sup>7)</sup>      | 277176 <sup>7)</sup>      | 277272 <sup>7)</sup>      | 277304 <sup>8)</sup>      | 112440 <sup>7)</sup>      | 112468 <sup>7)</sup>      |
| <b>...V 60Hz (24 – 600V)</b>  | 277017 <sup>7)</sup>      | 277049 <sup>7)</sup>      | 277145 <sup>7)</sup>      | 277177 <sup>7)</sup>      | 277273 <sup>7)</sup>      | 277305 <sup>8)</sup>      | 112441 <sup>7)</sup>      | 112469 <sup>7)</sup>      |

## DILM

| DC                          | DILM17-10(...)            | DILM17-01(...)            | DILM25-10(...)            | DILM25-01(...)            | DILM32-10(...)            | DILM32-01(...)            | DILM38-10(...)            | DILM38-01(...)            |
|-----------------------------|---------------------------|---------------------------|---------------------------|---------------------------|---------------------------|---------------------------|---------------------------|---------------------------|
|                             | Article no. <sup>1)</sup> | Article no. <sup>1)</sup> | Article no. <sup>1)</sup> | Article no. <sup>1)</sup> | Article no. <sup>1)</sup> | Article no. <sup>1)</sup> | Article no. <sup>1)</sup> | Article no. <sup>1)</sup> |
| <b>Standard voltages</b>    | See price list            | See price list            | See price list            | See price list            | See price list            | See price list            | See price list            | See price list            |
| <b>RDC 24<sup>3)</sup></b>  | 277018                    | 277050                    | 277146                    | 277178                    | 277274                    | 277306                    | 112442                    | 112470                    |
| <b>RDC 60<sup>4)</sup></b>  | 277019                    | 277051                    | 277147                    | 277179                    | 277275                    | 277307                    | 112443                    | 112471                    |
| <b>RDC 130<sup>5)</sup></b> | 277020                    | 277052                    | 277148                    | 277180                    | 277276                    | 277308                    | 112444                    | 112472                    |
| <b>RDC 240<sup>6)</sup></b> | 277021                    | 277053                    | 277149                    | 277181                    | 277277                    | 277309                    | 112445                    | 112473                    |

## Notes

- <sup>1)</sup> To obtain the article number for ordering, read under selected part number and actuating voltage from the table. devices with dual-voltage coils can be ordered under a single article no.
- <sup>2)</sup> With non-standard voltages the required actuating voltage from the defined range (...–...V) must be stated.
- <sup>3)</sup> 24 – 27 V DC
- <sup>4)</sup> 48 – 60 V DC
- <sup>5)</sup> 110 – 130 V DC
- <sup>6)</sup> 200 – 240 V DC
- <sup>7)</sup> Minimum order quantity 10 units
- <sup>8)</sup> Minimum order quantity 5 units

**DILM**

| AC  | DILM40(...)               | DILM50(...)               | DILM65(...)               | DILM72(...)               |
|---|---------------------------|---------------------------|---------------------------|---------------------------|
|   | Article no. <sup>1)</sup> | Article no. <sup>1)</sup> | Article no. <sup>1)</sup> | Article no. <sup>1)</sup> |
| <b>Standard voltages</b>  | See price list            | See price list            | See price list            | See price list            |
| <b>24V 50Hz</b>   | 277753                    | 277817                    | 277881                    | –                         |
| <b>240V 50Hz</b>  | 277755                    | 277819                    | 277883                    | 109183                    |
| <b>42V 50Hz</b><br><b>48V 60Hz</b>  | 277762                    | 277826                    | 277890                    | –                         |
| <b>110V 50Hz</b><br><b>120V 60Hz</b>  | 277763                    | 277827                    | 277891                    | 109191                    |
| <b>190V 50Hz</b><br><b>220V 60Hz</b>  | 277764                    | 277828                    | 277892                    | –                         |
| <b>220V 50Hz</b><br><b>240V 60Hz</b>  | 277765                    | 277829                    | 277893                    | –                         |
| <b>230V 50Hz</b><br><b>240V 60Hz</b>  | 277766                    | 277830                    | 277894                    | 107670                    |
| <b>380V 50Hz</b><br><b>440V 60Hz</b>  | 277767                    | 277831                    | 277895                    | –                         |
| <b>400V 50Hz</b><br><b>440V 60Hz</b>  | 277768                    | 277832                    | 277896                    | 109195                    |
| <b>415V 50Hz</b><br><b>480V 60Hz</b>  | 277769                    | 277833                    | 277897                    | –                         |
| <b>24V 50Hz/60Hz</b>  | 277770                    | 277834                    | 277898                    | 109197                    |
| <b>42V 50Hz/60Hz</b>  | 277771                    | 277835                    | 277899                    | –                         |
| <b>110V 50Hz/60Hz</b>   | 277772                    | 277836                    | 277900                    | 109199                    |
| <b>220V 50Hz/60Hz</b>   | 277773                    | 277837                    | 277901                    | 109200                    |
| <b>230V 50Hz/60Hz</b>   | 277774                    | 277838                    | 277902                    | 109201                    |
| Special voltages other than the already shown normal voltages <sup>2)</sup> | See price list            | See price list            | See price list            | See price list            |
| <b>...V 50Hz (24 – 600V)</b>  | 277778 <sup>8)</sup>      | 277842 <sup>8)</sup>      | 277906 <sup>8)</sup>      | 109205 <sup>7)</sup>      |
| <b>...V 60Hz (24 – 600V)</b>  | 277779 <sup>8)</sup>      | 277843 <sup>8)</sup>      | 277907 <sup>8)</sup>      | 109206 <sup>7)</sup>      |

**DILM**

| DC                          | DILM40(...)               | DILM50(...)               | DILM65(...)               | DILM72(...)               |
|-----------------------------|---------------------------|---------------------------|---------------------------|---------------------------|
|                             | Article no. <sup>1)</sup> | Article no. <sup>1)</sup> | Article no. <sup>1)</sup> | Article no. <sup>1)</sup> |
| <b>Standard voltages</b>    | See price list            | See price list            | See price list            | See price list            |
| <b>RDC 24<sup>3)</sup></b>  | 277780                    | 277844                    | 277908                    | 107671                    |
| <b>RDC 60<sup>4)</sup></b>  | 277781                    | 277845                    | 277909                    | –                         |
| <b>RDC 130<sup>5)</sup></b> | 277782                    | 277846                    | 277910                    | –                         |
| <b>RDC 240<sup>6)</sup></b> | 277783                    | 277847                    | 277911                    | 109209                    |

**Notes**

- <sup>1)</sup> To obtain the article number for ordering, read under selected part number and actuating voltage from the table.  
devices with dual-voltage coils can be ordered under a single article no.
- <sup>2)</sup> With non-standard voltages the required actuating voltage from the defined range (...–...V) must be stated.
- <sup>3)</sup> 24 – 27 V DC
- <sup>4)</sup> 48 – 60 V DC
- <sup>5)</sup> 110 – 130 V DC
- <sup>6)</sup> 200 – 240 V DC
- <sup>7)</sup> Minimum order quantity 10 units



# 1.1

## Contactors Actuating voltages

### 1 DILM

| AC  | DILM80<br>(...)           | DILM95<br>(...)           |
|---|---------------------------|---------------------------|
|   | Article no. <sup>1)</sup> | Article no. <sup>1)</sup> |
| <b>Standard voltages</b>  | See price list            | See price list            |
| <b>24 V 50 Hz</b>   | 235904                    | 239467                    |
| <b>240V 50Hz</b>  | 235910                    | 239469                    |
| <b>42V 50Hz<br/>48V 60Hz</b>  | 239394                    | 239476                    |
| <b>110V 50Hz<br/>120V 60Hz</b>  | 239399                    | 239477                    |
| <b>190V 50Hz<br/>220V 60Hz</b>  | 239400                    | 239478                    |
| <b>220V 50Hz<br/>240V 60Hz</b>  | 239401                    | 239479                    |
| <b>230V 50Hz<br/>240V 60Hz</b>  | 239402                    | 239480                    |
| <b>380V 50Hz<br/>440V 60Hz</b>  | 239403                    | 239481                    |
| <b>400V 50Hz<br/>440V 60Hz</b>  | 239404                    | 239482                    |
| <b>415V 50Hz<br/>480V 60Hz</b>  | 239405                    | 239483                    |
| <b>24V 50Hz/60Hz</b>  | 239406                    | 239484                    |
| <b>42V 50Hz/60Hz</b>  | 239407                    | 239485                    |
| <b>110V 50Hz/60Hz</b>   | 239408                    | 239486                    |
| <b>220V 50Hz/60Hz</b>   | 239409                    | 239487                    |
| <b>230V 50Hz/60Hz</b>   | 239410                    | 239488                    |
| Special voltages<br>other than the already<br>shown normal voltages <sup>2)</sup> | See price list            | list                      |
| <b>...V 50Hz (24 – 600V) <sup>13)</sup></b>                                       | 239414                    | 239504                    |
| <b>...V 60Hz (24 – 600V) <sup>13)</sup></b>                                       | 239415                    | 239509                    |

### DILM

| DC                          | DILM80<br>(...)           | DILM95<br>(...)           |
|-----------------------------|---------------------------|---------------------------|
|                             | Article no. <sup>1)</sup> | Article no. <sup>1)</sup> |
| <b>Standard voltages</b>    | See price list            | See price list            |
| <b>RDC 24<sup>3)</sup></b>  | 239416                    | 239510                    |
| <b>RDC 60<sup>4)</sup></b>  | 239417                    | 239511                    |
| <b>RDC 130<sup>5)</sup></b> | 239418                    | 239512                    |
| <b>RDC 240<sup>6)</sup></b> | 239419                    | 239513                    |

### DILM

| AC                           | DILM115<br>(...)          | DILM150<br>(...)          | DILM170<br>(...)          | DILM185A/<br>22(...)      | DILM225A/<br>22(...)      |
|------------------------------|---------------------------|---------------------------|---------------------------|---------------------------|---------------------------|
|                              | Article no. <sup>1)</sup> | Article no. <sup>1)</sup> | Article no. <sup>1)</sup> | Article no. <sup>1)</sup> | Article no. <sup>1)</sup> |
| <b>Standard voltages</b>     | See price list            | See price list            | See price list            | See price list            | See price list            |
| <b>RAC 24<sup>7)</sup></b>   | 239545                    | 239585                    | 107010                    | 139534                    | 139544                    |
| <b>RAC 48<sup>8)</sup></b>   | 239546                    | 239586                    | 107011                    | 139535                    | 139545                    |
| <b>RAC 120<sup>9)</sup></b>  | 239547                    | 239587                    | 107012                    | 139536                    | 139546                    |
| <b>RAC 240<sup>10)</sup></b> | 239548                    | 239588                    | 107013                    | 139537                    | 139547                    |
| <b>RAC 440<sup>11)</sup></b> | 239549                    | 239589                    | 107014                    | 139538                    | 139548                    |
| <b>RAC 500<sup>12)</sup></b> | 239550                    | 239590                    | 107015                    | 139539                    | 139549                    |

### DILM

| DC                          | DILM115<br>(...)          | DILM150<br>(...)          | DILM170<br>(...)          | DILM185A/<br>22(...)      | DILM225A/<br>22(...)      |
|-----------------------------|---------------------------|---------------------------|---------------------------|---------------------------|---------------------------|
|                             | Article no. <sup>1)</sup> | Article no. <sup>1)</sup> | Article no. <sup>1)</sup> | Article no. <sup>1)</sup> | Article no. <sup>1)</sup> |
| <b>Standard voltages</b>    | See price list            | See price list            | See price list            | See price list            | See price list            |
| <b>RDC 24<sup>3)</sup></b>  | 239555                    | 239591                    | 107016                    | 139540                    | 139550                    |
| <b>RDC 60<sup>4)</sup></b>  | 239560                    | 239592                    | 107017                    | 139541                    | 139551                    |
| <b>RDC 130<sup>5)</sup></b> | 239567                    | 239593                    | 107018                    | 139542                    | 139552                    |
| <b>RDC 240<sup>6)</sup></b> | 239572                    | 239594                    | 107019                    | 139543                    | 139553                    |

#### Notes

- <sup>1)</sup> The article no. results from combining the part no. and the actuating voltage. Devices with dual-voltage coils must be ordered under a single article no.
- <sup>2)</sup> With non-standard voltages the required actuating voltage from the defined range (...-...V) must be stated.
- <sup>3)</sup> 24 - 27 V DC
- <sup>4)</sup> 48 – 60 V DC
- <sup>5)</sup> 110 - 130 V DC
- <sup>6)</sup> 200 - 240 V DC
- <sup>7)</sup> 24 V 50/60 Hz
- <sup>8)</sup> 42 – 48 V 50/60 Hz
- <sup>9)</sup> 100 – 120 V 50/60 Hz
- <sup>10)</sup> 190 – 240 V 50/60 Hz
- <sup>11)</sup> 380 – 440 V 50/60 Hz
- <sup>12)</sup> 480 – 500 V 50/60 Hz
- <sup>13)</sup> Minimum order quantity 5 units

**DILM**

| AC  | DILMC7-10<br>(...)        | DILMC7-01<br>(...)        | DILMC9-10<br>(...)        | DILMC9-01<br>(...)        | DILMC12-10<br>(...)       | DILMC12-01<br>(...)       | DILMC15-10<br>(...)       | DILMC15-01<br>(...)       |
|---|---------------------------|---------------------------|---------------------------|---------------------------|---------------------------|---------------------------|---------------------------|---------------------------|
|   | Article no. <sup>1)</sup> | Article no. <sup>1)</sup> | Article no. <sup>1)</sup> | Article no. <sup>1)</sup> | Article no. <sup>1)</sup> | Article no. <sup>1)</sup> | Article no. <sup>1)</sup> | Article no. <sup>1)</sup> |
| <b>Standard voltages</b>  | See price list            | See price list            | See price list            | See price list            | See price list            | See price list            | See price list            | See price list            |
| <b>24 V 50 Hz</b>   | 277379                    | 277411                    | 277443                    | 277475                    | 277507                    | 277539                    | 293938                    | 293933                    |
| <b>110V 50Hz</b>  | 277386                    | 277418                    | 277450                    | 277482                    | 277514                    | 277546                    | 293908                    | 293943                    |
| <b>120V 60Hz</b>  |                           |                           |                           |                           |                           |                           |                           |                           |
| <b>230V 50Hz</b>  | 277389                    | 277421                    | 277453                    | 277485                    | 277517                    | 277549                    | 293911                    | 293946                    |
| <b>240V 60Hz</b>  |                           |                           |                           |                           |                           |                           |                           |                           |
| <b>24V 50Hz/60Hz</b>  | 277393                    | 277425                    | 277457                    | 277489                    | 277521                    | 277553                    | 293915                    | 293950                    |
| <b>230V 50Hz/60Hz</b>   | 277397                    | 277429                    | 277461                    | 277493                    | 277525                    | 277557                    | 293919                    | 293954                    |
| Special voltages other than the already shown normal voltages <sup>2)</sup> | See price list            | See price list            | See price list            | See price list            | See price list            | See price list            | See price list            | See price list            |
| <b>...V 50Hz (12 – 600V)<sup>6)</sup></b>                                   | 277401                    | 277433                    | 277465                    | 277497                    | 277529                    | 277561                    | 293923                    | 293958                    |
| <b>...V 60Hz (12 – 600V)<sup>6)</sup></b>                                   | 277402                    | 277434                    | 277466                    | 277498                    | 277530                    | 277562                    | 293924                    | 293959                    |

**DILM**

| DC  | DILMC7-10<br>(...)        | DILMC7-01<br>(...)        | DILMC9-10<br>(...)        | DILMC9-01<br>(...)        | DILMC12-10<br>(...)       | DILMC12-01<br>(...)       | DILMC15-10<br>(...)       | DILMC15-01<br>(...)       |
|---|---------------------------|---------------------------|---------------------------|---------------------------|---------------------------|---------------------------|---------------------------|---------------------------|
|   | Article no. <sup>1)</sup> | Article no. <sup>1)</sup> | Article no. <sup>1)</sup> | Article no. <sup>1)</sup> | Article no. <sup>1)</sup> | Article no. <sup>1)</sup> | Article no. <sup>1)</sup> | Article no. <sup>1)</sup> |
| <b>Standard voltages</b>  | See price list            | See price list            | See price list            | See price list            | See price list            | See price list            | See price list            | See price list            |
| <b>24V DC</b>   | 277404                    | 277436                    | 277468                    | 277500                    | 277532                    | 277564                    | 293926                    | 293961                    |
| <b>110V DC</b>  | 277407                    | 277439                    | 277471                    | 277503                    | 277535                    | 277567                    | 293929                    | 293964                    |
| <b>220V DC</b>  | 277408                    | 277440                    | 277472                    | 277504                    | 277536                    | 277568                    | 293930                    | 293965                    |
| Special voltages other than the already shown normal voltages <sup>2)</sup> | See price list            | See price list            | See price list            | See price list            | See price list            | See price list            | See price list            | See price list            |
| <b>...VDC (12 – 250V)<sup>6)</sup></b>                                      | 277409                    | 277441                    | 277473                    | 277505                    | 277537                    | 277569                    | 293931                    | 293966                    |

**DILM**

| AC  | DILMC17-10 (...)          | DILMC17-01(...)           | DILMC25-10 (...)          | DILMC25-01 (...)          | DILMC32-10 (...)          | DILMC32-01 (...)          |
|---|---------------------------|---------------------------|---------------------------|---------------------------|---------------------------|---------------------------|
|   | Article no. <sup>1)</sup> | Article no. <sup>1)</sup> | Article no. <sup>1)</sup> | Article no. <sup>1)</sup> | Article no. <sup>1)</sup> | Article no. <sup>1)</sup> |
| <b>Standard voltages</b>  | See price list            | See price list            | See price list            | See price list            | See price list            | See price list            |
| <b>24 V 50 Hz</b>   | 277570                    | 277600                    | 277630                    | 277660                    | 277690                    | 277720                    |
| <b>110V 50Hz</b>  | 277578                    | 277608                    | 277638                    | 277668                    | 277698                    | 277728                    |
| <b>120V 60Hz</b>  |                           |                           |                           |                           |                           |                           |
| <b>230V 50Hz</b>  | 277581                    | 277611                    | 277641                    | 277671                    | 277701                    | 277731                    |
| <b>240V 60Hz</b>  |                           |                           |                           |                           |                           |                           |
| <b>24V 50Hz/60Hz</b>  | 277585                    | 277615                    | 277645                    | 277675                    | 277705                    | 277735                    |
| <b>220V 50Hz/60Hz</b>   | 277588                    | 277618                    | 277648                    | 277678                    | 277708                    | 277738                    |
| <b>230V 50Hz/60Hz</b>   | 277589                    | 277619                    | 277649                    | 277679                    | 277709                    | 277739                    |
| Special voltages other than the already shown normal voltages <sup>2)</sup> | See price list            | See price list            | See price list            | See price list            | See price list            | See price list            |
| <b>...V 50Hz (24 – 600V)<sup>6)</sup></b>                                   | 277593                    | 277623                    | 277653                    | 277683                    | 277713                    | 277743                    |
| <b>...V 60Hz (24 – 600V)<sup>6)</sup></b>                                   | 277594                    | 277624                    | 277654                    | 277684                    | 277714                    | 277744                    |

**DILM**

| DC                          | DILMC17-10 (...)          | DILMC17-01 (...)          | DILMC25-10 (...)          | DILMC25-01 (...)          | DILMC32-10 (...)          | DILMC32-01 (...)          |
|-----------------------------|---------------------------|---------------------------|---------------------------|---------------------------|---------------------------|---------------------------|
|                             | Article no. <sup>1)</sup> | Article no. <sup>1)</sup> | Article no. <sup>1)</sup> | Article no. <sup>1)</sup> | Article no. <sup>1)</sup> | Article no. <sup>1)</sup> |
| <b>Standard voltages</b>    | See price list            | See price list            | See price list            | See price list            | See price list            | See price list            |
| <b>RDC 24<sup>3)</sup></b>  | 277595                    | 277625                    | 277655                    | 277685                    | 277715                    | 277745                    |
| <b>RDC 130<sup>4)</sup></b> | 277597                    | 277627                    | 277657                    | 277687                    | 277717                    | 277747                    |
| <b>RDC 240<sup>5)</sup></b> | 277598                    | 277628                    | 277658                    | 277688                    | 277718                    | 277748                    |

**Notes**

- <sup>1)</sup> The article no. results from combining the part no. and the actuating voltage. Devices with dual-voltage coils must be ordered under a single article no.
- <sup>2)</sup> With non-standard voltages the required actuating voltage from the defined range (...-...V) must be stated.
- <sup>3)</sup> 24 - 27 V DC
- <sup>4)</sup> 110 - 130 V DC
- <sup>5)</sup> 200 - 240 V DC
- <sup>6)</sup> Minimum order quantity 10 units

# 1.1

## Contactors Actuating voltages

### 1 DILMP20

| AC                       | DILMP20 (...)             | AC                          | DILMP20 (...)             | AC  | DILMP20 (...)             |
|--------------------------|---------------------------|-----------------------------|---------------------------|---|---------------------------|
|                          | Article no. <sup>1)</sup> |                             | Article no. <sup>1)</sup> |   | Article no. <sup>1)</sup> |
| <b>Standard voltages</b> | See price list            | <b>Standard voltages</b>    | See price list            | <b>Non-standard voltages<sup>2)</sup></b> | See price list            |
| <b>240V 50Hz</b>         | –                         | <b>RAC 24<sup>4)</sup></b>  | –                         | <b>...V 50Hz (12 – 600V)<sup>3)</sup></b> | 276982                    |
| <b>110V 50Hz</b>         | 276967                    | <b>RAC 120<sup>5)</sup></b> | –                         | <b>...V 60Hz (12 – 600V)<sup>3)</sup></b> | 276983                    |
| <b>120V 60Hz</b>         | –                         | <b>RAC 240<sup>6)</sup></b> | –                         |   |                           |
| <b>230 V 50Hz</b>        | 276970                    |                             |                           |   |                           |
| <b>240V 60Hz</b>         | –                         |                             |                           |   |                           |
| <b>24V 50/60Hz</b>       | 276974                    |                             |                           |   |                           |
| <b>230V 50/60Hz</b>      | 276978                    |                             |                           |   |                           |

### DILMP20

| DC                         | DILMP20 (...)             | DC  | DILMP20 (...)             |
|----------------------------|---------------------------|---|---------------------------|
|                            | Article no. <sup>1)</sup> |   | Article no. <sup>1)</sup> |
| <b>Standard voltages</b>   | See price list            | <b>Non-standard voltages<sup>2)</sup></b> | See price list            |
| <b>24V DC</b>              | 276985                    | <b>...V DC (12 – 250V)<sup>3)</sup></b>   | 276990                    |
| <b>RDC 24<sup>7)</sup></b> | –                         |   |                           |

#### Notes

- 1) The article number is a combination of part no. and actuating voltage
- 2) For non-standard voltages, state the actuating voltage selected from the range (... – ...V) shown.
- 3) Minimum order quantity: 10 units
- 4) 24 V 50/60 Hz
- 5) 100 – 120 V 50/60 Hz
- 6) 190 – 240 V 50/60 Hz
- 7) 24 – 27 V DC

DILM...XSP...

| AC  | DILM32-XSP<br>(...)       | DILM65-XSP<br>(...)       | DILM95-<br>XSP            |
|---|---------------------------|---------------------------|---------------------------|
|   | Article no. <sup>1)</sup> | Article no. <sup>1)</sup> | Article no. <sup>1)</sup> |
| <b>Standard voltages</b>  | See price list            | See price list            | See price list            |
| <b>24V 50Hz</b>   | 281130                    | 281160                    | 229984                    |
| <b>240V 50Hz</b>  | 281132                    | 281162                    | 229986                    |
| <b>24V 60Hz</b>   | 281134                    | 281164                    | 229988                    |
| <b>115V 60Hz</b>  | 281136                    | 281166                    | 229990                    |
| <b>42V 50Hz<br/>48V 60Hz</b>  | 281137                    | 281167                    | 229994                    |
| <b>110V 50Hz<br/>120V 60Hz</b>  | 281138                    | 281168                    | 230058                    |
| <b>190V 50Hz<br/>220V 60Hz</b>  | 281139                    | 281169                    | 230059                    |
| <b>220V 50Hz<br/>240V 60Hz</b>  | 281140                    | 281170                    | 230061                    |
| <b>230V 50Hz<br/>240V 60Hz</b>  | 281141                    | 281171                    | 230062                    |
| <b>380V 50Hz<br/>440V 60Hz</b>  | 281142                    | 281172                    | 230063                    |
| <b>400V 50Hz<br/>440V 60Hz</b>  | 281143                    | 281173                    | 230064                    |
| <b>415V 50Hz<br/>480V 60Hz</b>  | 281144                    | 281174                    | 230065                    |
| <b>24V 50Hz/60Hz</b>  | 281145                    | 281175                    | 230066                    |
| <b>42V 50Hz/60Hz</b>  | 281146                    | 281176                    | 230067                    |
| <b>110V 50Hz/60Hz</b>   | 281147                    | 281177                    | 230068                    |
| <b>220V 50Hz/60Hz</b>   | 281148                    | 281178                    | 230073                    |
| <b>230V 50Hz/60Hz</b>   | 281149                    | 281179                    | 230074                    |
| Special voltages other than the already shown normal-voltages <sup>2)</sup> | See price list            | See price list            | See price list            |
| <b>...V 50Hz (24 – 600V)</b>  | 281153 <sup>13)</sup>     | 281183 <sup>14)</sup>     | 230078 <sup>14)</sup>     |
| <b>...V 60Hz (24 – 600V)</b>  | 281154 <sup>13)</sup>     | 281184 <sup>14)</sup>     | 230079 <sup>14)</sup>     |

DILM...XSP...

| DC                          | DILM32-XSP<br>(...)       | DILM65-XSP<br>(...)       | DILM95-<br>XSP            |
|-----------------------------|---------------------------|---------------------------|---------------------------|
|                             | Article no. <sup>1)</sup> | Article no. <sup>1)</sup> | Article no. <sup>1)</sup> |
| <b>Standard voltages</b>    | See price list            | See price list            | See price list            |
| <b>RDC 24<sup>3)</sup></b>  | 281155                    | 281185                    | 230080                    |
| <b>RDC 60<sup>4)</sup></b>  | 281156                    | 281186                    | 230081                    |
| <b>RDC 130<sup>5)</sup></b> | 281157                    | 281187                    | 230082                    |
| <b>RDC 240<sup>6)</sup></b> | 281158                    | 281188                    | 230107                    |

DILM...XSP...

| AC                           | DILM150-XSP<br>(...)      | DILM225A-XSP<br>(...)     |
|------------------------------|---------------------------|---------------------------|
|                              | Article no. <sup>1)</sup> | Article no. <sup>1)</sup> |
| <b>Standard voltages</b>     | See price list            | See price list            |
| <b>RAC 24<sup>7)</sup></b>   | 230109                    | 139562                    |
| <b>RAC 48<sup>8)</sup></b>   | 230110                    | 139563                    |
| <b>RAC 120<sup>9)</sup></b>  | 230111                    | 139564                    |
| <b>RAC 240<sup>10)</sup></b> | 230112                    | 139565                    |
| <b>RAC 440<sup>11)</sup></b> | 230113                    | 139566                    |
| <b>RAC 500<sup>12)</sup></b> | 230114                    | 139567                    |

DILM...XSP...

| DC                          | DILM150-XSP<br>(...)      | DILM225A-XSP<br>(...)     |
|-----------------------------|---------------------------|---------------------------|
|                             | Article no. <sup>1)</sup> | Article no. <sup>1)</sup> |
| <b>Standard voltages</b>    | See price list            | See price list            |
| <b>RDC 24<sup>3)</sup></b>  | 230115                    | 139568                    |
| <b>RDC 60<sup>4)</sup></b>  | 230116                    | 139569                    |
| <b>RDC 130<sup>5)</sup></b> | 230117                    | 139570                    |
| <b>RDC 240<sup>6)</sup></b> | 230122                    | 139571                    |

Notes

- 1) To obtain the article number for ordering, read under selected part number and actuating voltage from the table.  
Devices with dual-voltage coils are to be ordered under a single article number.
- 2) With non-standard voltages the required actuating voltage from the defined range (...–...V) must be stated.
- 3) 24 – 27 V DC
- 4) 48 – 60 V DC
- 5) 110 – 130 V DC
- 6) 200 – 240 V DC
- 7) 24 V 50/60 Hz
- 8) 42 – 48 V 50/60 Hz
- 9) 100 – 120 V 50/60 Hz
- 10) 190 – 240 V 50/60 Hz
- 11) 380 – 440 V 50/60 Hz
- 12) 480 – 500 V 50/60 Hz
- 13) Minimum order quantity 10 units
- 14) Minimum order quantity 5 units

# 1.1

## Contactor for capacitors, contactor

Actuating voltages

### 1 DILK, DILMF

| AC  | DILK12-11<br>(...)        | DILK20-11<br>(...)        | DILK25-11<br>(...)        | DILK33-10<br>(...)        | DILK50-10<br>(...)        |
|---|---------------------------|---------------------------|---------------------------|---------------------------|---------------------------|
|   | Article no. <sup>1)</sup> | Article no. <sup>1)</sup> | Article no. <sup>1)</sup> | Article no. <sup>1)</sup> | Article no. <sup>1)</sup> |
| <b>Standard voltages</b>  | See price list            | See price list            | See price list            | See price list            | See price list            |
| <b>110V 50Hz,<br/>120V 60Hz</b>   | 293985                    | 294007                    | 294029                    | 294051                    | 294073                    |
| <b>190V 50Hz,<br/>220V 60Hz</b>   | 293986                    | 294008                    | 294030                    | 294052                    | 294074                    |
| <b>230V 50Hz,<br/>240V 60Hz</b>   | 293988                    | 294010                    | 294032                    | 294054                    | 294076                    |
| <b>400V 50Hz,<br/>440V 60Hz</b>   | 293990                    | 294012                    | 294034                    | 294056                    | 294078                    |
| Special voltages other than the already shown normal voltages <sup>2)</sup> | See price list            | See price list            | See price list            |                           |                           |
| <b>... V 50Hz (24 – 600V)<sup>3)</sup></b>                                  | 293997                    | 294019                    | 294041                    | –                         | –                         |
| <b>... V 60Hz (24 – 600V)<sup>3)</sup></b>                                  | 293998                    | 294020                    | 294042                    | –                         | –                         |

#### Notes

- <sup>1)</sup> The article no. results from combining the part no. and the actuating voltage.  
Devices with dual-voltage coils must be ordered under a single article no.
- <sup>2)</sup> With non-standard voltages the required actuating voltage from the defined range (...–...V) must be stated.
- <sup>3)</sup> Minimum order quantity 10 units

**DILM**

**Complete comfort devices**

|                                | <b>DILM250</b><br><b>/22(...)</b>           | <b>DILM300A</b><br><b>/22(...)</b>          | <b>DILM400</b><br><b>/22(...)</b>           | <b>DILM500</b><br><b>/22(...)</b>           | <b>DILM580</b><br><b>/22(...)</b>           | <b>DILM650</b><br><b>/22(...)</b>           | <b>DILM750</b><br><b>/22(...)</b>           | <b>DILM820</b><br><b>/22(...)</b>           | <b>DILM1000</b><br><b>/22(...)</b>          |
|--------------------------------|---|---|---|---|---|---|---|---|---|
| <b>Voltage variants</b>        | Article no. <sup>1)</sup><br>See price list | Article no. <sup>1)</sup><br>See price list | Article no. <sup>1)</sup><br>See price list | Article no. <sup>1)</sup><br>See price list | Article no. <sup>1)</sup><br>See price list | Article no. <sup>1)</sup><br>See price list | Article no. <sup>1)</sup><br>See price list | Article no. <sup>1)</sup><br>See price list | Article no. <sup>1)</sup><br>See price list |
| <b>RDC 48<sup>2)</sup></b>     | 208199                                      | 139554                                      | 208207                                      | 208211                                      | –   | –   | –   | –   | –   |
| <b>RA 110<sup>3)</sup></b>     | 208200                                      | 139555                                      | 208208                                      | 208212                                      | 208215                                      | 208218                                      | 208221                                      | 208224                                      | –   |
| <b>RA 250<sup>4)</sup></b>     | 208201                                      | 139556                                      | 208209                                      | 208213                                      | 208216                                      | 208219                                      | 208222                                      | 208225                                      | 267214                                      |
| <b>RAC 500<sup>5) 6)</sup></b> | 208202                                      | 139557                                      | 208210                                      | 208214                                      | 208217                                      | 208220                                      | 208223                                      | 208226                                      | –   |

**DILM**

**Complete units  
Standard**

|                         | <b>DILM250</b><br><b>-S/22(...)</b>         | <b>DILM300A</b><br><b>-S/22(...)</b>        | <b>DILM400</b><br><b>-S/22(...)</b>         | <b>DILM500</b><br><b>-S/22(...)</b>         |
|-------------------------|---|---|---|---|
| <b>Voltage variants</b> | Article no. <sup>1)</sup><br>See price list | Article no. <sup>1)</sup><br>See price list | Article no. <sup>1)</sup><br>See price list | Article no. <sup>1)</sup><br>See price list |
| <b>110-120V 50/60Hz</b> | 274189                                      | 139558                                      | 274195                                      | 274198                                      |
| <b>220-240V 50/60Hz</b> | 274190                                      | 139559                                      | 274196                                      | 274199                                      |

**DILM**

**Electronic module, incl. coil, for  
comfort model**

|                                | <b>DILM250-XSP/E(...)</b>                   | <b>DILM500-XSP/E(...)</b>                   | <b>DILM1000-XSP/E(...)</b>                  |
|--------------------------------|---|---|---|
| <b>Voltage variants</b>        | Article no. <sup>1)</sup><br>See price list | Article no. <sup>1)</sup><br>See price list | Article no. <sup>1)</sup><br>See price list |
| <b>RDC 48<sup>2)</sup></b>     | 208250                                      | 208254                                      | –   |
| <b>RA 110<sup>3)</sup></b>     | 208251                                      | 208255                                      | 289146                                      |
| <b>RA 250<sup>4)</sup></b>     | 208252                                      | 208256                                      | 289145                                      |
| <b>RAC 500<sup>5) 6)</sup></b> | 208253                                      | 208257                                      | 289147                                      |

**DILM**

**Electronic module, incl. coil, for  
standard model**

|                         | <b>DILM250-S-XSP/E(...)</b>                 | <b>DILM500-S-XSP/E(...)</b>                 |
|-------------------------|---|---|
| <b>Voltage variants</b> | Article no. <sup>1)</sup><br>See price list | Article no. <sup>1)</sup><br>See price list |
| <b>110-120V 50/60Hz</b> | 274201                                      | 274204                                      |
| <b>220-240V 50/60Hz</b> | 274202                                      | 274205                                      |

**Notes**

- <sup>1)</sup> The article no. results from combining the part no. and the voltage variant.
- <sup>2)</sup> 24 – 48 V DC
- <sup>3)</sup> 48 – 110 V 40 – 60 Hz/48 – 110 V DC
- <sup>4)</sup> 110 – 250 V 40 – 60 Hz/110 – 250 V DC
- <sup>5)</sup> 250 – 500 V 40 – 60 Hz
- <sup>6)</sup> DC on request

## 1 Engineering

### DILM, DILA, DILE, DILH

The diagrams show the closing and opening travel of the contacts at no load.

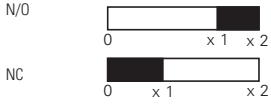

|                         |                        | x1   | x2   |
|-------------------------|------------------------|------|------|
| <b>DILE AC</b>          | N/O                    | 1.9  | 2.8  |
|                         | NC                     | 0.95 | 2.8  |
| ...DILE                 | N/O                    | 1.9  | 2.8  |
|                         | NC                     | 0.9  | 2.8  |
| ...DDILE                | NO early-make          | 1.06 | 2.9  |
|                         | Late-break N/C contact | 1.86 | 2.9  |
|                         | N/O                    | 1.9  | 2.8  |
|                         | NC                     | 0.9  | 2.8  |
| <b>DILE DC</b>          | N/O                    | 1.9  | 2.85 |
|                         | NC                     | 0.95 | 2.85 |
| DILE...                 | N/O                    | 1.9  | 2.8  |
|                         | NC                     | 0.9  | 2.8  |
| ...DDILE                | NO early-make          | 1.06 | 2.9  |
|                         | Late-break N/C contact | 1.86 | 2.9  |
|                         | N/O                    | 1.9  | 2.8  |
|                         | NC                     | 0.9  | 2.8  |
| <b>DILA AC</b>          | N/O                    | 3.3  | 4.5  |
|                         | NC                     | 1.0  | 4.5  |
| DILA-XHI                | N/O                    | 3.2  | 4.5  |
|                         | NC                     | 1.6  | 4.5  |
| DILA-XHIV               | NO early-make          | 2.0  | 4.5  |
|                         | Late-break N/C contact | 2.8  | 4.5  |
|                         | N/O                    | 3.2  | 4.5  |
|                         | NC                     | 1.6  | 4.5  |
| <b>DILA DC</b>          | N/O                    | 2.1  | 2.9  |
|                         | NC                     | 0.7  | 2.9  |
| DILA-XHI                | N/O                    | 2.3  | 2.9  |
|                         | NC                     | 0.7  | 2.9  |
| DILA-XHIV               | NO early-make          | 1.1  | 2.9  |
|                         | Late-break N/C contact | 1.9  | 2.9  |
|                         | N/O                    | 2.3  | 2.9  |
|                         | NC                     | 0.7  | 2.9  |
| <b>DILM7/9 AC</b>       | N/O                    | 3.3  | 4.5  |
|                         | NC                     | 1.0  | 4.5  |
| DILM32-XHI, DILA-XHI    | N/O                    | 3.2  | 4.5  |
|                         | NC                     | 1.6  | 4.5  |
| DILA-XHIV               | NO early-make          | 2.0  | 4.5  |
|                         | Late-break N/C contact | 2.8  | 4.5  |
|                         | N/O                    | 3.2  | 4.5  |
|                         | NC                     | 1.6  | 4.5  |
| <b>DILM7/9 DC</b>       | N/O                    | 2.1  | 2.9  |
|                         | NC                     | 0.7  | 2.9  |
| DILM32-XHI, DILA-XHI    | N/O                    | 2.3  | 2.9  |
|                         | NC                     | 0.7  | 2.9  |
| DILA-XHIV               | NO early-make          | 1.1  | 2.9  |
|                         | Late-break N/C contact | 1.9  | 2.9  |
|                         | N/O                    | 2.3  | 2.9  |
|                         | NC                     | 0.7  | 2.9  |
| <b>DILM12/15/P20 AC</b> | N/O                    | 3.3  | 4.5  |
|                         | NC                     | 1.0  | 4.5  |
| DILM32-XHI, DILA-XHI    | N/O                    | 3.2  | 4.5  |
|                         | NC                     | 1.6  | 4.5  |
| DILA-XHIV               | NO early-make          | 2.0  | 4.5  |
|                         | Late-break N/C contact | 2.8  | 4.5  |
|                         | N/O                    | 3.2  | 4.5  |
|                         | NC                     | 1.6  | 4.5  |
| <b>DILM12/15/P20 DC</b> | N/O                    | 3.3  | 4.4  |
|                         | NC                     | 1.0  | 4.4  |
| DILM32-XHI, DILA-XHI    | N/O                    | 3.2  | 4.4  |
|                         | NC                     | 1.6  | 4.4  |

### DILM, DILA, DILE, DILH

The diagrams show the closing and opening travel of the contacts at no load.

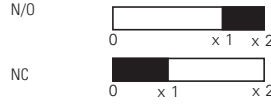

|   |                        | x1   | x2   |
|---|------------------------|------|------|
| DILA-XHIV                                     | NO early-make          | 2.0  | 4.4  |
|   | Late-break N/C contact | 2.8  | 4.4  |
|   | N/O                    | 3.2  | 4.4  |
|   | NC                     | 1.6  | 4.4  |
| <b>DILM17/25/32/P32/P45</b>                   | N/O                    | 4.0  | 6.0  |
|   | Auxiliary N/C          | 1.8  | 6.0  |
|   | Auxiliary N/O          | 3.2  | 6.0  |
| DILM32-XHI, DILA-XHI                          | N/O                    | 3.2  | 6.0  |
|   | NC                     | 1.6  | 6.0  |
| DILA-XHIV                                     | NO early-make          | 2.0  | 6.0  |
|   | Late-break N/C contact | 2.8  | 6.0  |
|   | N/O                    | 3.2  | 6.0  |
|   | NC                     | 1.6  | 6.0  |
| <b>DILM40/50/65/P63/P80</b>                   | N/O                    | 5.1  | 7.5  |
| DILM150-XHI                                   | N/O                    | 5.7  | 7.5  |
|   | NC                     | 3.9  | 7.5  |
| DILM150-XHIV                                  | NO early-make          | 3.8  | 7.5  |
|   | Late-break N/C contact | 5.4  | 7.5  |
|   | N/O                    | 5.7  | 7.5  |
|   | NC                     | 3.9  | 7.5  |
| DILM1000-XHI                                  | N/O                    | 5.5  | 7.5  |
|   | NC                     | 3.6  | 7.5  |
| DILM1000-XHIV                                 | NO early-make          | 4.1  | 7.5  |
|   | Late-break N/C contact | 5.0  | 7.5  |
| <b>DILM80/95/115/150/170/P125/P160/P200</b>   | N/O                    | 8.0  | 11   |
| DILM150-XHI                                   | N/O                    | 9.2  | 11   |
|   | NC                     | 7.4  | 11   |
| DILM150-XHIV                                  | NO early-make          | 7.3  | 11   |
|   | Late-break N/C contact | 8.9  | 11   |
|   | N/O                    | 9.2  | 11   |
|   | NC                     | 7.4  | 11   |
| DILM1000-XHI                                  | N/O                    | 9.0  | 11   |
|   | NC                     | 7.1  | 11   |
| DILM1000-XHIV                                 | NO early-make          | 7.6  | 11   |
|   | Late-break N/C contact | 8.5  | 11   |
| <b>DILM185A/225A</b>                          | N/O                    | 10.0 | 13.0 |
| DILM1000-XHI                                  | N/O                    | 10.0 | 13.0 |
|   | NC                     | 8.1  | 13.0 |
| DILM1000-XHIV                                 | NO early-make          | 8.4  | 13.0 |
|   | Late-break N/C contact | 9.5  | 13.0 |
| <b>DILM250/300A</b>                           | N/O                    | 10.1 | 13.1 |
| DILM820-XHI                                   | N/O                    | 10.3 | 13.1 |
|   | NC                     | 8.4  | 13.1 |
| DILM820-XHIV                                  | NO early-make          | 8.7  | 13.1 |
|   | Late-break N/C contact | 9.8  | 13.1 |
| <b>DILM400/500/570</b>                        | N/O                    | 8.9  | 13.1 |
| DILM820-XHI                                   | N/O                    | 10.3 | 13.1 |
|   | NC                     | 8.4  | 13.1 |
| DILM820-XHIV                                  | NO early-make          | 8.7  | 13.1 |
|   | Late-break N/C contact | 9.8  | 13.1 |
| <b>DILM580/650/750/820</b>                    | N/O                    | 2.0  | 4.1  |
| DILM820-XHI                                   | N/O                    | 7.4  | 10.5 |
|   | NC                     | 5.5  | 10.5 |
| DILM820-XHIV                                  | NO early-make          | 6.0  | 10.5 |
|   | Late-break N/C contact | 6.8  | 10.5 |
| <b>DILM1000/1600, DILH1400/2000/2200/2600</b> | N/O                    | 2.0  | 4.1  |
| DILM820-XHI                                   | N/O                    | 7.4  | 10.5 |
|   | NC                     | 5.5  | 10.5 |
| DILM820-XHIV                                  | NO early-make          | 6.0  | 10.5 |
|   | Late-break N/C contact | 6.8  | 10.5 |

DILE, DILM, SDAINL, DIUL

Components

Contactor selection

| Part no.                | With top mounting auxiliary contacts | With side mounting auxiliary contacts | With overload relay                                | With parallel connector | Insulated enclosures        |
|-------------------------|--------------------------------------|---------------------------------------|--|-------------------------|-----------------------------|
| DILE...(-G)(-C)         | –                                    | –                                     | –  | –                       | CI-K1-95-TS                 |
| DILE...(-G)(-C)         | ●                                    | –                                     | –  | –                       | CI-K2-145-TS                |
| DILE...(-G)             | ●                                    | –                                     | ●  | –                       | CI-K2-145-AD                |
| DILE...(-G)             | –                                    | –                                     | –  | ●                       | CI-K2-100-TS                |
| DILE...(-G)             | ●                                    | –                                     | –  | ●                       | CI-K2-145-TS                |
| DILM7 to DILM15         | ●                                    | –                                     | –  | –                       | CI-K2-145-TS                |
| DILM7 to DILM15         | ●                                    | –                                     | ●  | –                       | CI-K3-160-TS                |
| DILM17 to DILM32        | –                                    | –                                     | –  | –                       | CI-K2-145-TS                |
| DILM17 to DILM32        | ●                                    | –                                     | ●  | –                       | CI23E-150                   |
| DILM40 to DILM65        | –                                    | ●                                     | –  | –                       | CI-K3-160-TS                |
| DILM40 to DILM65        | ●                                    | ●                                     | ●  | –                       | CI43E-150                   |
| DILM80 to DILM170       | ●                                    | ●                                     | –  | –                       | CI43E-200                   |
| DILM80 to DILM170       | ●                                    | ●                                     | ●  | –                       | CI44E-200                   |
| DILM185A                | –                                    | ●                                     | –  | –                       | CI48-250                    |
| DILM225A                | –                                    | ●                                     | –  | –                       | CI48-250                    |
| DILM250                 | –                                    | ●                                     | –  | –                       | CI48-250                    |
| DILM300A                | –                                    | ●                                     | –  | –                       | CI48-250                    |
| DILM400                 | –                                    | ●                                     | –  | –                       | CI48-250                    |
| DILM500                 | –                                    | ●                                     | –  | –                       | CI48-250                    |
| DILM580                 | –                                    | ●                                     | –  | –                       | CI48-250                    |
| DILM650                 | –                                    | ●                                     | –  | –                       | CI48-250                    |
| DILM750                 | –                                    | ●                                     | –  | –                       | CI48-250                    |
| DILM820                 | –                                    | ●                                     | –  | –                       | CI48-250                    |
| DIULE...                | ●                                    | –                                     | –  | –                       | CI-K3-125-TS                |
| DIULE...                | ●                                    | –                                     | ●  | –                       | CI-K3-125-TS                |
| DIULM7 to DIULM12       | ●                                    | –                                     | –  | –                       | CI-K4-160-TS                |
| DIULM17 to DIULM32      | ●                                    | –                                     | –  | –                       | CI23E-150                   |
| DIULM40 to DIULM65      | ●                                    | –                                     | –  | –                       | CI43E-200                   |
| SDAINLEM...             | ●                                    | –                                     | –  | –                       | CI-K5-125-TS<br>CI-K5-125-M |
| SDAINLM12 to SDAINLM22  | ●                                    | –                                     | –  | –                       | CI-K5-160-TS                |
| SDAINLM30 to SDAINLM65  | ●                                    | –                                     | –  | –                       | CI23E-150                   |
| SDAINLM70 to SDAINLM115 | ●                                    | –                                     | –  | –                       | CI43E-200                   |
| <b>Notes</b>            | CI-K small enclosure                 | → See catalog                         | Insulated PE, N or PEN terminal for enclosure CI-K | → See catalog           |                             |
|                         | Terminal for CI-K enclosure          | → See catalog                         |  |                         |                             |
|                         | CI enclosure                         | → See catalog                         |  |                         |                             |



# 1.1

## Contactors

UL/CSA-approved rating data

### 1 for North America

#### DILE, DILA, DILM

##### Rating data for approved types



Maximum alternating current-motor rating

Single-phase

3-phase

| 115 V<br>120 V<br>HP | 230 V<br>240 V<br>HP | 200 V<br>208 V<br>HP | 230 V<br>240 V<br>HP | 460 V<br>480 V<br>HP | 575 V<br>600 V<br>HP |
|----------------------|----------------------|----------------------|----------------------|----------------------|----------------------|
|----------------------|----------------------|----------------------|----------------------|----------------------|----------------------|

##### GENERAL USE

Maximum motor-rated current  
 $I_{th}$   
Open/enclosed

NEMA size

##### Contactors

##### Part no.

|       |       |       |       |      |       | A       |   |    |
|-------|-------|-------|-------|------|-------|---------|---|----|
| 1/2   | 1 1/2 | 2     | 3     | 5    | 5     | 15/13.5 | <b>DILEM(4)</b>                         | 00 |
| 1/4   | 1     | 1 1/2 | 2     | 3    | 5     | 20      | <b>DILM7-...(...)</b>                   | 00 |
| 1/2   | 1 1/2 | 3     | 3     | 5    | 7 1/2 | 20      | <b>DILM9-...(...)</b>                   | 00 |
| 1     | 2     | 3     | 3     | 10   | 10    | 20      | <b>DILM12-...(...)</b>                  | 0  |
| 1     | 3     |       | 5     | 10   | 10    | 20      | <b>DILM15-...(...)</b>                  | 0  |
| 2     | 3     | 5     | 7 1/2 | 10   | 15    | 35      | <b>DILM17-...(...)</b>                  | 0  |
| 2     | 5     | 7 1/2 | 7 1/2 | 15   | 20    | 35      | <b>DILM25-...(...)</b>                  | 1  |
| 3     | 5     | 10    | 10    | 20   | 25    | 40      | <b>DILM32-...(...), DILM38-...(...)</b> | 1  |
| 3     | 7 1/2 | 10    | 15    | 30   | 40    | 55      | <b>DILM40(...)</b>                      | 2  |
| 3     | 10    | 15    | 20    | 40   | 50    | 65      | <b>DILM50(...)</b>                      | 2  |
| 5     | 15    | 20    | 25    | 40   | 60    | 80      | <b>DILM65(...), DILM70(...)</b>         | 2  |
| 7 1/2 | 15    | 25    | 30    | 60   | 75    | 125     | <b>DILM80(...)</b>                      | 3  |
| 7 1/2 | 15    | 25    | 40    | 75   | 100   | 125     | <b>DILM95(...)</b>                      | 3  |
| 10    | 25    | 40    | 50    | 100  | 125   | 160     | <b>DILM115(...)</b>                     | 4  |
| 15    | 30    | 40    | 60    | 125  | 125   | 160     | <b>DILM150(...), DILM170(...)</b>       | 4  |
| –     | –     | 50    | 60    | 125  | 150   | 225     | <b>DILM185(...)</b>                     | 4  |
| –     | –     | 60    | 75    | 150  | 200   | 250     | <b>DILM225(...)</b>                     | 4  |
| –     | –     | 75    | 100   | 200  | 250   | 350     | <b>DILM250(...)</b>                     | 5  |
| –     | –     | 100   | 125   | 250  | 300   | 350     | <b>DILM300(...)</b>                     | 5  |
| –     | –     | 125   | 150   | 300  | 400   | 450     | <b>DILM400(...)</b>                     | 5  |
| –     | –     | 150   | 200   | 400  | 500   | 550     | <b>DILM500(...)</b>                     | 6  |
| –     | –     | 200   | 200   | 400  | 600   | 630     | <b>DILM580(...)</b>                     | 6  |
| –     | –     | 200   | 250   | 500  | 600   | 700     | <b>DILM650(...)</b>                     | 6  |
| –     | –     | 250   | 300   | 600  | 700   | 800     | <b>DILM750(...)</b>                     | 6  |
| –     | –     | 290   | 350   | 700  | 860   | 850     | <b>DILM820(...)</b>                     | 6  |
| –     | –     | 350   | 400   | 800  | 1000  | 1000    | <b>DILM1000(...)</b>                    | 7  |
| –     | –     | 560   | 640   | 1200 | 1300  | 1600    | <b>DILM1600(...)</b>                    | 8  |

#### DILE, DILA, DILM

##### Approved rating data UL - File No. E29184 for auxiliary contacts



Pilot Duty

General Use

| Part no.   | Pilot Duty |      | General Use |    |         |     |
|--|------------|------|-------------|----|---------|-----|
|  | AC         | DC   | AC<br>V     | A  | DC<br>V | A   |
| <b>DIL(E)EM-10(-01)</b><br><b>DILER-40(31)(22)</b><br><b>...(D)DILE</b>        | A600       | P300 | 600         | 10 | 250     | 0.5 |
| <b>DILM7-10(-01)</b><br><b>To</b><br><b>DILM32-10(-01)</b><br><b>DILA...</b>   | A600       | P300 | 600         | 15 | 250     | 1   |
| <b>DILA-XHI...</b><br><b>DILM32-XHI...</b>                                     | A600       | P300 | 600         | 15 | 250     | 1   |
| <b>DILM...-XHI11-SI</b><br><b>DILM...-XHI11-SA</b><br><b>DILM...-XHI11V-SI</b> | A600       | P600 | 600         | 10 | –       | –   |

Further approvals → 81

- Elevator control
- Refrigeration control
- Resistance air heating
- Incandescent lamps
- Electrical discharge lamps
- Capacitive switching

for North America

DILM, DILMP, DILK

Special purpose rating



|   | DIL    | M7       | M9      | M12      | M15      | M17     | M25<br>MP32<br>MP45 | M32       | M40<br>MP63 | M50<br>MP80 | M65<br>M72 | M80<br>MP125 | M95<br>MP160 | M115     | M150<br>M170<br>MP200 |
|---|--------|----------|---------|----------|----------|---------|---------------------|-----------|-------------|-------------|------------|--------------|--------------|----------|-----------------------|
| <b>Electrical discharge lamps (ballast)</b> |        |          |         |          |          |         |                     |           |             |             |            |              |              |          |                       |
| 480V 60Hz 3phase, 277V 60Hz 1phase          | A      | 12       | 18      | 20       | 20       | 27      | 35                  | 40        | 63          | 79          | 88         | 85           | 100          | 136      | 160                   |
| 600V 60Hz 3phase, 347V 60Hz 1phase          | A      | 12       | 18      | 20       | 20       | 27      | 35                  | 40        | 63          | 79          | 88         | 85           | 100          | 136      | 160                   |
| <b>Incandescent lamps (Tungsten)</b>        |        |          |         |          |          |         |                     |           |             |             |            |              |              |          |                       |
| 480V 60Hz 3phase, 277V 60Hz 1phase          | A      | 8        | 11      | 14       | 14       | 23      | 32                  | 40        | 55          | 74          | 88         | 85           | 100          | 136      | 160                   |
| 600V 60Hz 3phase, 347V 60Hz 1phase          | A      | 8        | 11      | 14       | 14       | 23      | 32                  | 40        | 55          | 74          | 88         | 85           | 100          | 136      | 160                   |
| <b>Resistance air heating</b>               |        |          |         |          |          |         |                     |           |             |             |            |              |              |          |                       |
| 480V60Hz 3phase, 277V60Hz 1phase            | A      | 12       | 18      | 20       | 20       | 27      | 35                  | 40        | 63          | 79          | 88         | 94           | 110          | 136      | 160                   |
| 600V60Hz 3phase, 347V60Hz 1phase            | A      | 12       | 18      | 20       | 20       | 27      | 35                  | 40        | 63          | 79          | 88         | 94           | 110          | 136      | 160                   |
| <b>Refrigeration control (CSA only)</b>     |        |          |         |          |          |         |                     |           |             |             |            |              |              |          |                       |
| LRA 480V 60Hz 3phase                        | A      | 60       | 60      | 60       | 60       | 240     | 240                 | 240       | 270         | 270         | 270        | 540          | 540          | 540      | 540                   |
| LRA 600V 60Hz 3phase                        | A      | 60       | 60      | 60       | 60       | 180     | 180                 | 180       | 270         | 270         | 270        | 420          | 420          | 540      | 540                   |
| 480V 60Hz 3phase                            | A      | 6        | 7.5     | 10       | 10       | 23      | 32                  | 40        | 26          | 36          | 45         | 63           | 70           | 84       | 90                    |
| 600V 60Hz 3phase                            | A      | 6        | 7.5     | 10       | 10       | 17      | 24                  | 30        | 26          | 36          | 45         | 63           | 70           | 84       | 90                    |
| <b>Elevator control</b>                     |        |          |         |          |          |         |                     |           |             |             |            |              |              |          |                       |
| 200V 60Hz 3phase                            | HP (A) | ¾ (3.7)  | 2 (7.8) | 2 (7.8)  | 2 (7.8)  | 3 (11)  | 3 (11)              | 7½ (25.3) | 7½ (25.3)   | 10 (32.2)   | 10 (32.2)  | 20 (62.1)    | 20 (62.1)    | 30 (92)  | 30 (92)               |
| 240V 60Hz 3phase                            | HP (A) | 1½ (6.0) | 2 (6.8) | 2 (6.8)  | 3 (9.6)  | 3 (9.6) | 5 (15.2)            | 7½ (22)   | 10 (28)     | 15 (42)     | 15 (42)    | 25 (68)      | 30 (80)      | 40 (104) | 40 (104)              |
| 480V 60Hz 3phase                            | HP (A) | 2 (3.4)  | 3 (4.8) | 7½ (11)  | 7½ (11)  | 7½ (11) | 10 (14)             | 20 (27)   | 25 (34)     | 30 (40)     | 30 (40)    | 50 (65)      | 60 (77)      | 75 (96)  | 75 (96)               |
| 600V 60Hz 3phase                            | HP (A) | 3 (3.9)  | 5 (6.1) | 7½ (9.6) | 7½ (9.6) | 10 (11) | 15 (17)             | 20 (22)   | 30 (32)     | 40 (41)     | 40 (41)    | 60 (62)      | 75 (77)      | 100 (99) | 100 (99)              |

DILM, DILMP, DILK

Special purpose rating



|                            | DIL  | K12  | K20 | K25  | K33 | K50 |
|----------------------------|------|------|-----|------|-----|-----|
| <b>Capacitor Switching</b> |      |      |     |      |     |     |
| 240V 60Hz 3phase           | A    | 18   | 28  | 36   | 48  | 72  |
| 480V 60Hz 3phase           | A    | 18   | 28  | 36   | 48  | 72  |
| 600V 60Hz 3phase           | A    | 14.4 | 28  | 38.4 | 48  | 72  |
| 240V 60Hz 3phase           | kvar | 7.5  | 12  | 15   | 20  | 30  |
| 480V 60Hz 3phase           | kvar | 15   | 20  | 30   | 40  | 60  |
| 600V 60Hz 3phase           | kvar | 15   | 30  | 40   | 50  | 75  |

# 1.1

## Contactors

UL/CSA short circuit current rating

### 1 for North America

#### DILM

##### Short circuit current rating (SCCR)



| Contactor     | Basic Rating |                |              | 480 V High Fault |                |    |              | 600 V High Fault |                |    |              |
|---------------|--------------|----------------|--------------|------------------|----------------|----|--------------|------------------|----------------|----|--------------|
|               | kA           | Max. fuse<br>A | Max. CB<br>A | kA               | Max. fuse<br>A | kA | Max. CB<br>A | kA               | Max. fuse<br>A | kA | Max. CB<br>A |
| DILM7-...(…)  | 5            | 45             | 60           | 100              | 20 Class J     | -  | Fuse only    | 30               | 25             | -  | Fuse only    |
| DILM9-...(…)  | 5            | 45             | 60           | 100              | 20 Class J     | -  | Fuse only    | 30               | 25             | -  | Fuse only    |
| DILM12-...(…) | 5            | 45             | 60           | 100              | 20 Class J     | -  | Fuse only    | 30               | 25             | -  | Fuse only    |
| DILM15-...(…) | 5            | 45             | 60           |                  | 20 Class J     | -  | Fuse only    | 30               | 25             | -  | Fuse only    |
| DILM17-...(…) | 5            | 125            | 125          | 100              | 70 Class J     | 10 | 50           | 10               | 125            | 10 | 50           |
| DILM25-...(…) | 5            | 125            | 125          | 100              | 100 Class J    | 10 | 50           | 10               | 125            | 10 | 50           |
| DILM32-...(…) | 5            | 125            | 125          | 100              | 125 Class J    | 10 | 50           | 10               | 125            | 10 | 50           |
| DILM38-...(…) | 5            | 125            | 125          | 100              | 125 Class J    | 10 | 50           | 10               | 125            | 10 | 50           |
| DILM40(…)     | 10           | 250            | 250          | 100              | 150 Class J    | 65 | 100          | 30               | 250            | 30 | 250          |
| DILM50(…)     | 10           | 250            | 250          | 100              | 150 Class J    | 65 | 100          | 30               | 250            | 30 | 250          |
| DILM65(…)     | 10           | 250            | 250          | 100              | 150 Class J    | 65 | 100          | 30               | 250            | 30 | 250          |
| DILM72(…)     | 10           | 250            | 250          | 100              | 150 Class J    | 65 | 100          | 30               | 250            | 30 | 250          |
| DILM80(…)     | 10           | 600            | 600          | 100              | 300 Class J    | 65 | 250          | 30               | 300            | 30 | 350          |
| DILM95(…)     | 10           | 600            | 600          | 100              | 300 Class J    | 65 | 250          | 30               | 300            | 30 | 350          |
| DILM115(…)    | 10           | 600            | 600          | 100              | 300 Class J    | 65 | 250          | 30               | 300            | 30 | 350          |
| DILM150(…)    | 10           | 600            | 600          | 100              | 300 Class J    | 65 | 250          | 30               | 300            | 30 | 350          |
| DILM170(…)    | 10           | 600            | 600          | 100              | 300 Class J    | 65 | 250          | 30               | 300            | 30 | 350          |
| DILM185(…)    | 18           | 700            | 600          | -                | CB only        | 65 | 250          | -                | -              | -  | -            |
| DILM225(…)    | 18           | 700            | 600          | -                | CB only        | 65 | 250          | -                | -              | -  | -            |
| DILM250(…)    | 18           | 700            | 600          | -                | CB only        | 65 | 250          | -                | -              | -  | -            |
| DILM300(…)    | 30           | 800            | 600          | -                | CB only        | 42 | 600          | 30               | 800            | 30 | 600          |
| DILM400(…)    | 30           | 800            | 600          | -                | CB only        | 42 | 600          | 30               | 800            | 30 | 600          |
| DILM500(…)    | 30           | 800            | 600          | -                | CB only        | 42 | 600          | 30               | 800            | 30 | 600          |
| DILM570(…)    | 30           | 800            | 600          | -                | CB only        | 42 | 600          | 30               | 800            | 30 | 600          |
| DILM580(…)    | 30           | 2000           | 1200         | 85               | 2000           | 85 | 1200         | 85               | 2000           | 85 | 1200         |
| DILM650(…)    | 30           | 2000           | 1200         | 85               | 2000           | 85 | 1200         | 85               | 2000           | 85 | 1200         |
| DILM750(…)    | 42           | 2000           | 1200         | 85               | 2000           | 85 | 1200         | 85               | 2000           | 85 | 1200         |
| DILM820(…)    | 42           | 2000           | 1200         | 85               | 2000           | 85 | 1200         | 85               | 2000           | 85 | 1200         |
| DILM1000(…)   | 85           | 2000           | 1200         | 85               | 2000           | 85 | 1200         | 85               | 2000           | 85 | 1200         |
| DILM1600(…)   | 85           | 2000           | -            | 85               | 2000           | -  | -            | 85               | 2000           | 85 | -            |

# 1.1

## Contactors

Contactors for resistive load

### 1 DILM, DILEM

#### Rating data

##### Single-phase rating AC-1

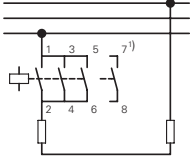

##### Three-phase rating AC-1

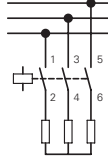

##### Three-phase rating AC-1

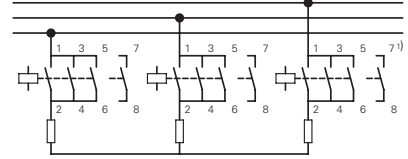

| Voltage in V |     |     | Max. upstream fuse<br>gG/gL | Rated operational current<br>$I_e = I_{th}$<br>or $I_{the}$ |
|--------------|-----|-----|-----------------------------|---|
| 220          | 380 | 660 |                             |   |
| 230          | 400 | 690 |                             |   |
| 240          | 440 |     |                             |   |
| kW           |     |     | A                           | A   |

| Voltage in V |     |     | Max. upstream fuse<br>gG/gL | Rated operational current<br>$I_e = I_{th}$<br>or $I_{the}$ |
|--------------|-----|-----|-----------------------------|---|
| 220          | 380 | 660 |                             |   |
| 230          | 400 | 690 |                             |   |
| 240          | 440 |     |                             |   |
| kW           |     |     | A                           | A   |

| Voltage in V |     |     | Max. upstream fuse<br>gG/gL | Rated operational current<br>$I_e = I_{th}$<br>or $I_{the}$ |
|--------------|-----|-----|-----------------------------|---|
| 220          | 380 | 660 |                             |   |
| 230          | 400 | 690 |                             |   |
| 240          | 440 |     |                             |   |
| kW           |     |     | A                           | A   |

#### Open version

|      |      |      |      |      |     |      |      |      |      |      |      |      |    |      |
|------|------|------|------|------|-----|------|------|------|------|------|------|------|----|------|
| 10   | 18   | 31   | 50   | 50   | 7   | 13   | 20   | 20   | 20   | 18   | 31   | 54   | 50 | 50   |
| 10   | 18   | 31   | 50   | 50   | 7   | 13   | 20   | 20   | 20   | 18   | 31   | 54   | 50 | 50   |
| 12   | 21   | 37   | 63   | 60   | –   | –    | –    | –    | –    | 21   | 37   | 65   | 63 | 60   |
| 10   | 18   | 31   | –    | 50   | 7   | 13   | 22   | –    | 20   | 18   | 31   | 54   | –  | 50   |
| 13   | 22   | 38   | –    | 60   | –   | –    | –    | –    | –    | 22   | 38   | 65   | –  | 60   |
| 18   | 32   | 55   | –    | 88   | 13  | 22   | 38   | –    | 35   | 32   | 55   | 95   | –  | 88   |
| 21   | 36   | 63   | –    | 100  | 14  | 25   | 43   | –    | 40   | 36   | 63   | 109  | –  | 100  |
| 26   | 45   | 78   | –    | 125  | 18  | 31   | 54   | –    | 50   | 45   | 78   | 136  | –  | 125  |
| 34   | 59   | 102  | –    | 163  | 24  | 41   | 71   | –    | 65   | 59   | 102  | 176  | –  | 163  |
| 42   | 72   | 125  | –    | 200  | 29  | 50   | 87   | –    | 80   | 72   | 125  | 217  | –  | 200  |
| 47   | 81   | 141  | –    | 225  | 33  | 56   | 98   | –    | 90   | 81   | 141  | 244  | –  | 225  |
| 57   | 99   | 172  | –    | 275  | 40  | 69   | 119  | –    | 110  | 100  | 172  | 299  | –  | 275  |
| 68   | 117  | 204  | –    | 325  | 47  | 81   | 141  | –    | 130  | 118  | 203  | 353  | –  | 325  |
| 84   | 144  | 251  | –    | 400  | 58  | 100  | 174  | –    | 160  | 145  | 250  | 434  | –  | 400  |
| 101  | 175  | 317  | –    | 460  | 70  | 120  | 220  | –    | 185  | 175  | 302  | 549  | –  | 460  |
| 144  | 248  | 431  | 800  | 688  | 100 | 172  | 299  | 315  | 275  | 262  | 453  | 786  | –  | 688  |
| 165  | 284  | 494  | 800  | 788  | 114 | 197  | 342  | 315  | 315  | 300  | 519  | 900  | –  | 788  |
| 172  | 297  | 516  | 1000 | 825  | 120 | 206  | 357  | 400  | 330  | 333  | 576  | 1000 | –  | 875  |
| 183  | 316  | 548  | 1000 | 875  | 126 | 219  | 380  | 400  | 350  | 381  | 658  | 1143 | –  | 1000 |
| 261  | 451  | 784  | 1250 | 1250 | 181 | 313  | 543  | 500  | 500  | 476  | 825  | 1429 | –  | 1250 |
| 366  | 632  | 1097 | –    | 1750 | 253 | 438  | 760  | 800  | 700  | 667  | 1152 | 2000 | –  | 1750 |
| 418  | 722  | 1254 | –    | 2000 | 290 | 500  | 869  | 800  | 800  | 762  | 1316 | 2286 | –  | 2000 |
| 444  | 767  | 1332 | –    | 2125 | 308 | 531  | 923  | 1000 | 850  | 810  | 1400 | 2429 | –  | 2125 |
| 470  | 812  | 1411 | –    | 2250 | 326 | 563  | 977  | 1000 | 900  | 857  | 1480 | 2572 | –  | 2250 |
| 523  | 903  | 1568 | –    | 2500 | 362 | 625  | 1086 | 1000 | 1000 | 953  | 1646 | 2858 | –  | 2500 |
| 732  | 1264 | 2195 | –    | 3500 | 507 | 875  | 1520 | –    | 1400 | 1334 | 2300 | 4000 | –  | 3500 |
| 1045 | 1805 | 3135 | –    | 5000 | 724 | 1251 | 2172 | –    | 2000 | 1905 | 3290 | 5716 | –  | 5000 |
| 1150 | 1985 | 3449 | –    | 5500 | 796 | 1376 | 2389 | –    | 2200 | 2095 | 3619 | 6288 | –  | 5500 |
| 1358 | 2346 | 4075 | –    | 6500 | 941 | 1626 | 2827 | –    | 2600 | 2476 | 4277 | 7430 | –  | 6500 |

#### Notes

<sup>1)</sup> Contact 7 – 8 only with DILEM4(-G), DILMP20...

**DILM, DILEM**

| Part no. | Ordering data | Required accessories:    | Notes |
|----------|---------------|--------------------------|-------|
|          |               | <b>Paralleling links</b> |       |

| AC operated     | Page | Part no.    | Accessories               | Page |
|-----------------|------|-------------|---------------------------|------|
| DILEM-10(...)   | → 4  | P1DILEM     |                           |      |
| DILEM-01(...)   | → 4  | P1DILEM     |                           |      |
| DILEM4(...)     | → 4  | P1DILEM     |                           |      |
| DILM7-...(...)  | → 18 | DILM12-XP1  | Auxiliary contact modules | → 6  |
| DILMP20(...)    | → 34 | DILM12-XP1  | Set of paralleling links  | → 36 |
| DILM17-...(...) | → 18 | DILM32-XP1  | Enclosure                 | → 53 |
| DILM25-...(...) | → 18 | DILM32-XP1  | Accessories               | → 63 |
| DILM40(...)     | → 20 | DILM65-XP1  |                           | → 52 |
| DILM50(...)     | → 20 | DILM65-XP1  |                           |      |
| DILM65(...)     | → 20 | DILM65-XP1  |                           |      |
| DILM80(...)     | → 20 | DILM150-XP1 |                           |      |
| DILM95(...)     | → 20 | DILM150-XP1 |                           |      |
| DILM115(...)    | → 20 | DILM150-XP1 |                           |      |
| DILM150(...)    | → 20 | DILM150-XP1 |                           |      |
| DILM170(...)    | → 20 | DILM150-KP1 |                           |      |
| DILM185A(...)   | → 30 | DILM185-XP1 |                           |      |
| DILM225A(...)   | → 30 | DILM185-XP1 |                           |      |
| DILM250(...)    | → 30 | –           |                           |      |
| DILM300A(...)   | → 30 | –           |                           |      |
| DILM400(...)    | → 30 | –           |                           |      |
| DILM500(...)    | → 30 | –           |                           |      |
| DILM580(...)    | → 30 | –           |                           |      |
| DILM650(...)    | → 30 | –           |                           |      |
| DILM750(...)    | → 30 | –           |                           |      |
| DILM820(...)    | → 30 | –           |                           |      |
| DILH1400(...)   | → 32 | –           |                           |      |
| DILH2000(...)   | → 32 | –           |                           |      |
| DILH2200(...)   | → 32 | –           |                           |      |
| DILH2600(...)   | → 32 | –           |                           |      |

# 1.1

## Mini contactor relays, contactor relays

Electrical lifespan

### 1 DILA (AC-15)

Component lifespan (operations)  
 $I_e$  = Rated operational current

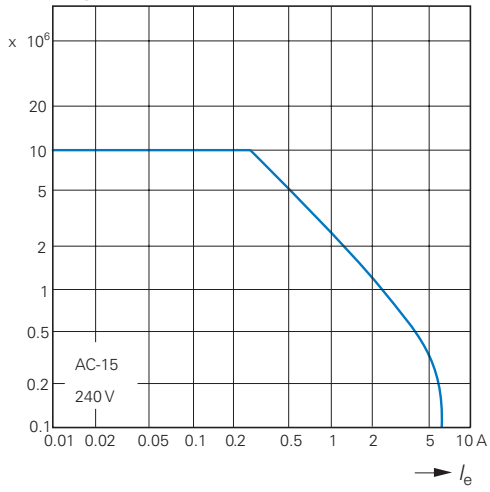

### DILA DC<sup>1)</sup>

Component lifespan (operations)  
 $I_e$  = Rated operational current

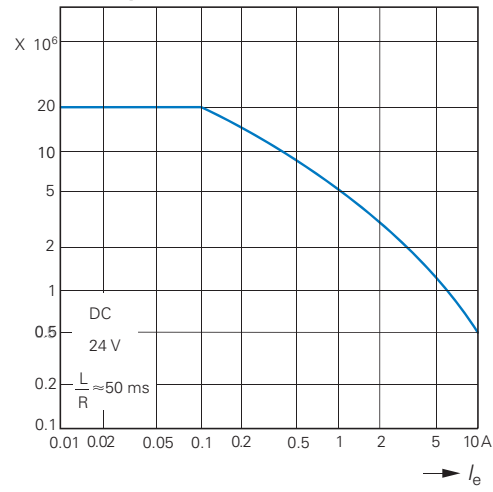

<sup>1)</sup> Three contacts in series

### DILER (AC-15)

Component lifespan (operations)  
 $I_e$  = Rated operational current

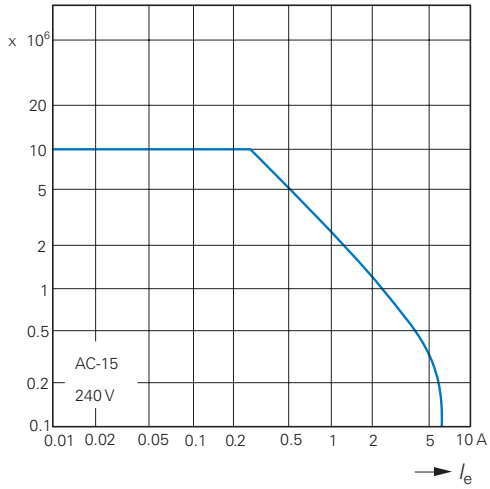

Normal switching duty

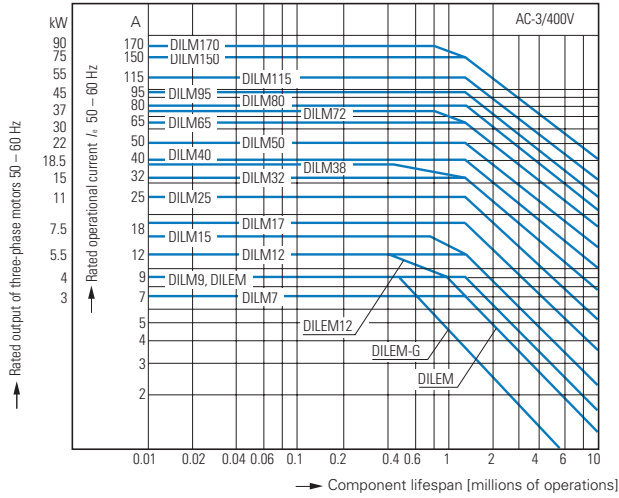

Normal AC induction motor

Operating characteristics

Make: from stop

Break: during run

Electrical characteristics:

Make: up to 6 X rated motor current

Break: 1 X rated motor current

Utilization category

100 % AC-3

Typical applications:

- |  |                 |                       |
|--|-----------------|-----------------------|
| Compressors  | Lifts           | Mixers                |
| Pumps  | Escalators      | Agitators             |
| Fan  | Conveyor belts  | Centrifuges           |
| Hinged flaps   | Bucket-elevator | Air conditioning sys- |
| General drives for manufacturing and processing machines |                 |                       |

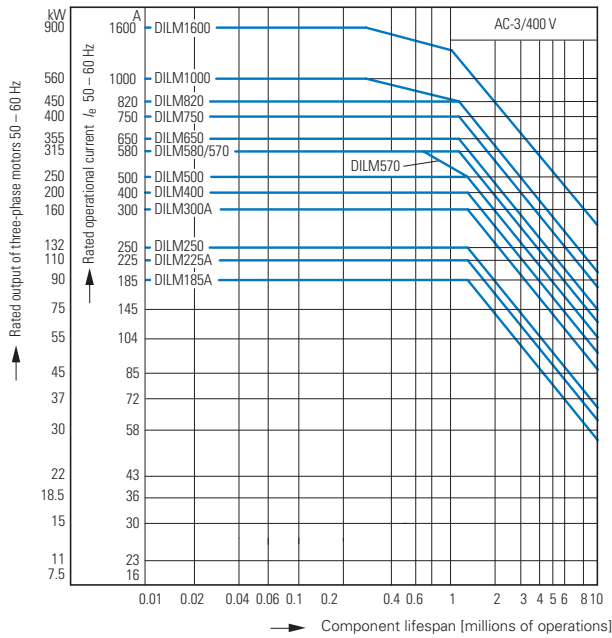

Extreme switching duty

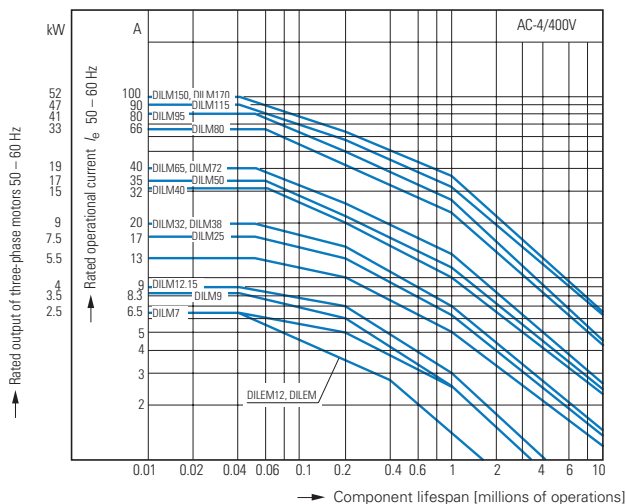

Normal AC induction motor

Operating characteristics

Inching, plugging, reversing

Electrical characteristics:

Make: up to 6 X rated motor current

Break: 6 X rated motor current

Utilization category

100 % AC-4

Typical applications:

- |   |              |             |
|---|--------------|-------------|
| Printing machines                                       | Wire-drawing | Centrifuges |
| Special drives on manufacturing and processing machines |              |             |

# 1.1

## Contactors

Switching conditions

### 1 Extreme switching duty

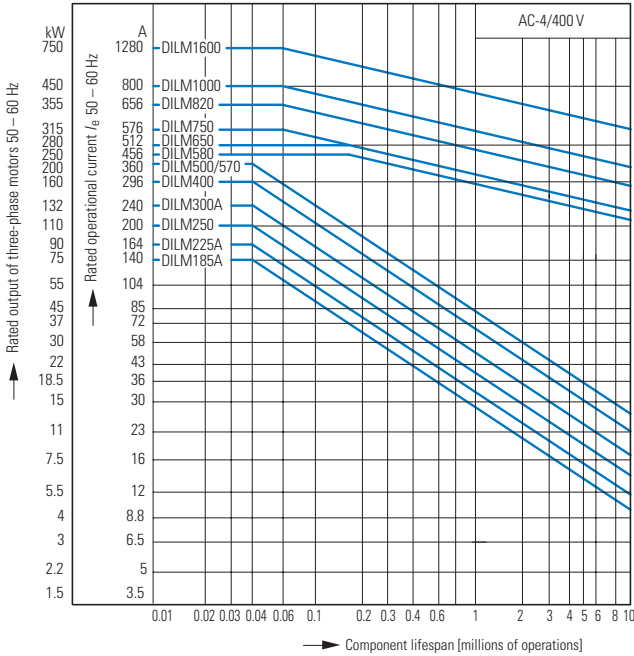

#### Normal AC induction motor

Operating characteristics

Inching, plugging, reversing

Electrical characteristics:

Make: up to 6 X rated motor current

Break: 6 X rated motor current

Utilization category

100% AC-4

Typical applications:

Printing machines    Wire-drawing machines    Centrifuges

Special drives on manufacturing and processing machines

### Switching conditions for 3 pole, non-motor loads

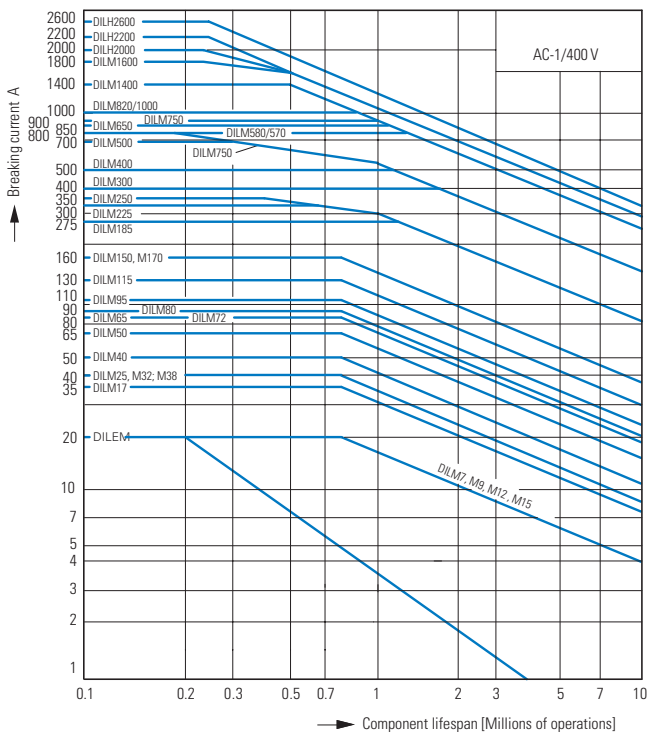

Operating characteristics

Non inductive and slightly inductive loads

Electrical characteristics:

Make: 1 X rated operational current

Break: 1 X rated operational current

Utilization category

100% AC-1

Typical applications:

Electric heat



Switching conditions for 4 pole, non-motor loads

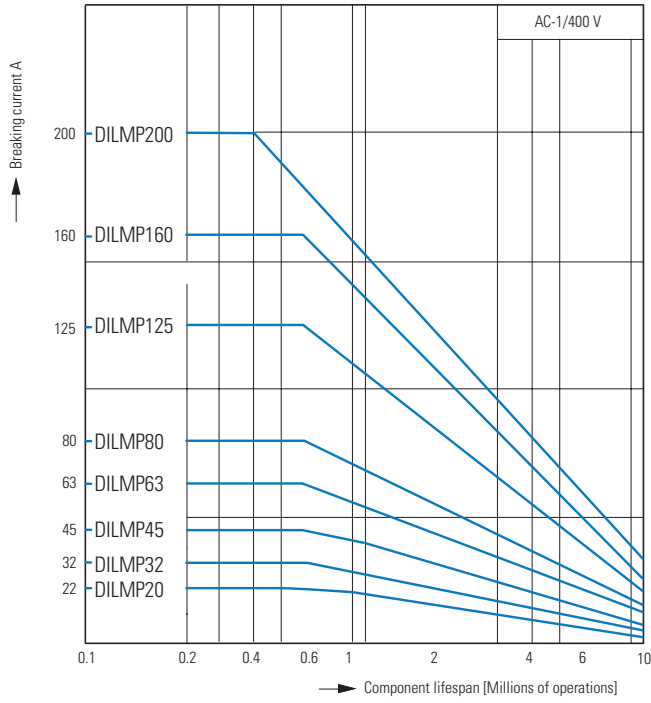

- Operating characteristics
  - Non inductive and slightly inductive loads
- Electrical characteristics:
  - Make: 1 X rated operational current
  - Break: 1 X rated operational current
- Utilization category
  - 100% AC-1
- Typical applications:
  - Electric heat

# 1.1

## Contactors Short-time loading

### 1 Short-time loading 3 pole

Time interval between two loads: 15 minutes

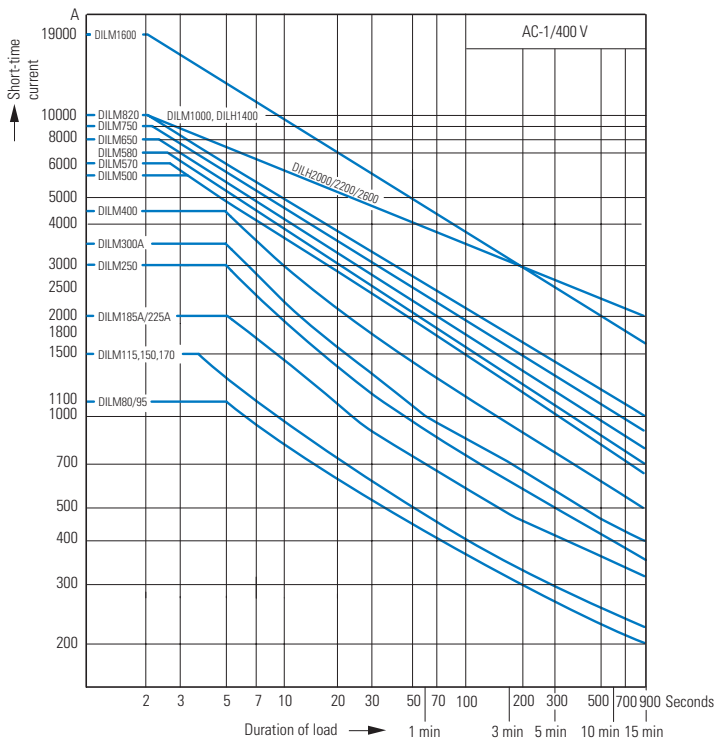
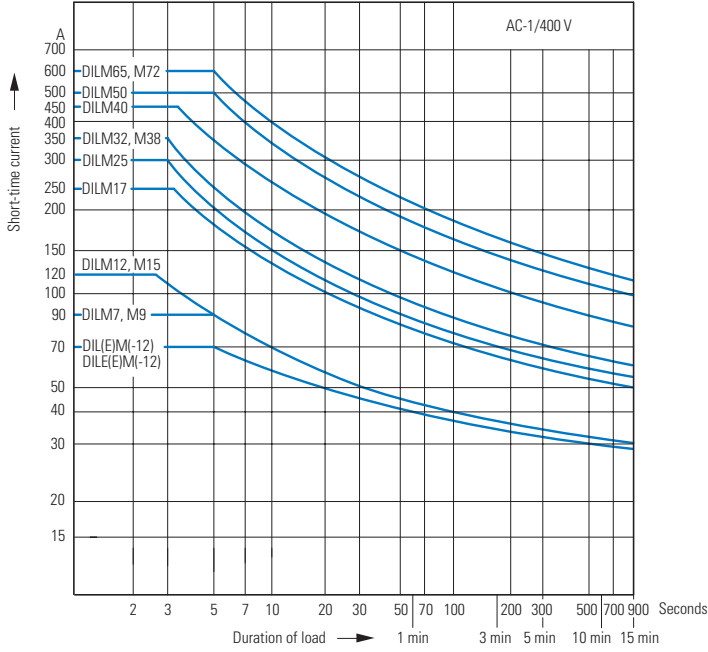

**Determination of the maximum operating frequency dependent on the rating and utilization category (recommended values) for 400 V**

$P_N$  = max. rated motor output (kW) of respective contactor according to → Page 18 and → Page 4

S/h = max. operation per hour

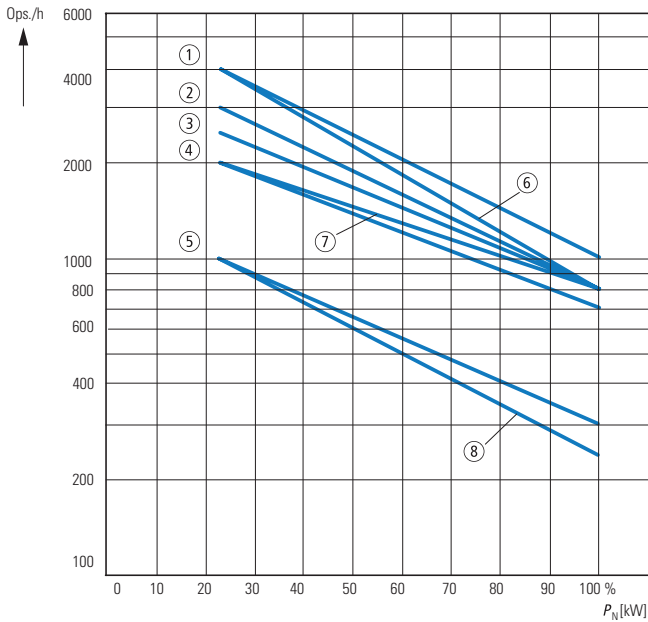

**DILEM, DILM, DILH**

| Part no.                  | Characteristic |      |              |
|---------------------------|----------------|------|--------------|
|                           | AC-1           | AC-3 | AC-2<br>AC-4 |
| DILE(E)M(-12)             | 7              | 6    | 8            |
| DILM7, 9, 12, 15          | 3              | 1    | 5            |
| DILM17, 25, 32, 38        | 3              | 2    | 5            |
| DILM40, 50, 65, 72        | 3              | 2    | 5            |
| DILM80, 95, 115, 150, 170 | 3              | 4    | 5            |

**Determination of the maximum operating frequency dependent on the rating and utilization category (recommended values)**

$P_N$  = max. rated motor output (kW) of respective contactor according to → Page 28 and → Page 32

S/h = max. operation per hour

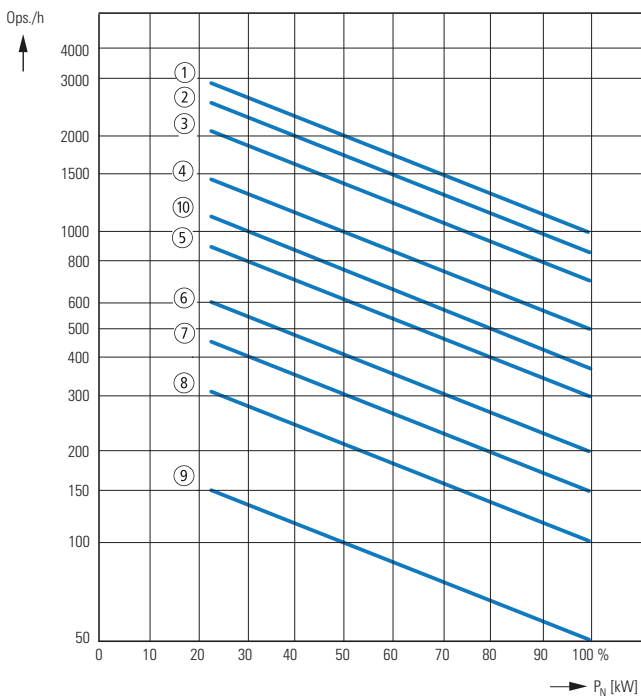

**DILEM, DILM, DILH**

| Part no. | Characteristic |      |      |
|----------|----------------|------|------|
|          | AC-1           | AC-3 | AC-4 |
| DILM185A | 2              | 1    | 8    |
| DILM225A | 2              | 1    | 8    |
| DILM250  | 2              | 1    | 8    |
| DILM300A | 3              | 2    | 9    |
| DILM400  | 3              | 2    | 9    |
| DILM500  | 3              | 2    | 9    |
| DILM580  | 3              | 4    | 7    |
| DILM650  | 3              | 4    | 7    |
| DILM750  | 3              | 4    | 7    |
| DILM820  | 3              | 4    | 7    |
| DILM1000 | 3              | 4    | 7    |
| DILM1600 | 10             | 10   | 7    |
| DILH1400 | 10             | –    | –    |
| DILH2000 | 10             | –    | –    |
| DILH2200 | 10             | –    | –    |
| DILH2600 | 10             | –    | –    |

# 1.1

## Contactors

Switching of DC current

### 1 DC current switching

----- when necessary  
conductor to be  
supplied by customer

#### DILEEM ... DILM700

Without overload relay  
≤ 60 V DC

> 60 V DC

With overload relay  
> 60 V DC

1 pole

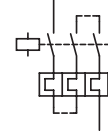

2 pole

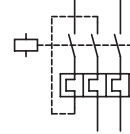

#### DILEM4 DILMP...

1 pole

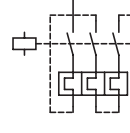
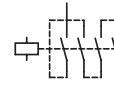

2 pole

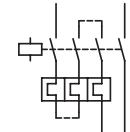

### Wiring, star-delta combination with DILM32-XTEY20

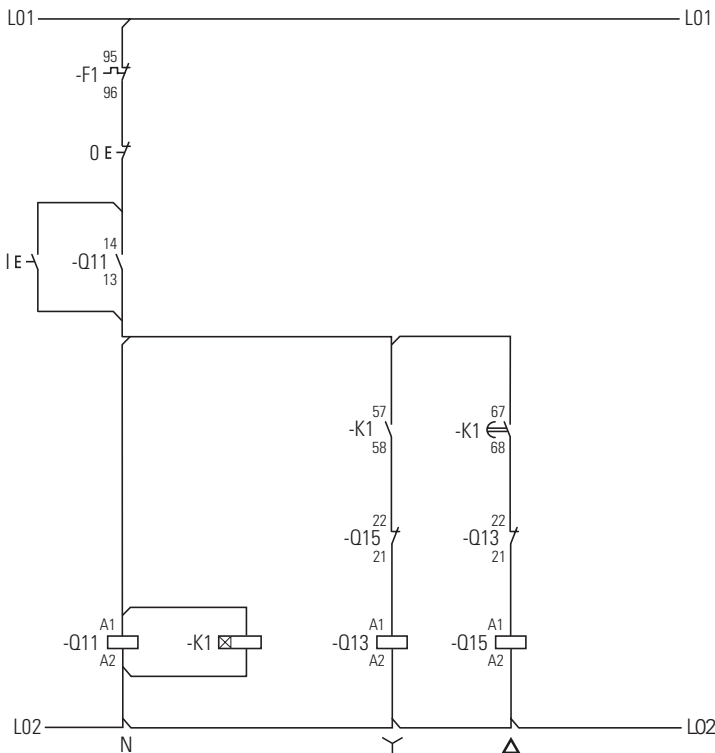

Technical data

DILER, DILA

|   |                                    |                   | DILA  | DILA...XHI                           | DILER                                | DILE...   |
|---|------------------------------------|-------------------|---|--------------------------------------|--------------------------------------|---|
| <b>General</b>  |                                    |                   |   |                                      |                                      |   |
| Standards   |                                    |                   | IEC/EN 60947, VDE 0660, UL, CSA   |                                      |                                      |   |
| Lifespan, mechanical  |                                    |                   |   |                                      |                                      |   |
| AC operated   | Operations                         | x 10 <sup>6</sup> | 20  | 10                                   | 10                                   | 10  |
| DC operated   | Operations                         | x 10 <sup>6</sup> | 20  | 10                                   | 20                                   | 20  |
| Maximum operating frequency   |                                    |                   |   |                                      |                                      |   |
| Maximum operating frequency   | Operations/h                       |                   | 9000  | 9000                                 | 9000                                 | 9000  |
| Climatic proofing   |                                    |                   |   |                                      |                                      |   |
|   |                                    |                   | Damp heat, constant, to IEC 60068-2-78;<br>Damp heat, cyclic, to IEC 60068-2-30 |                                      |                                      |   |
| Ambient temperature   |                                    |                   |   |                                      |                                      |   |
| Open  |                                    | °C                | -25...60  | -25...60                             | -25...50                             | -25...50  |
| Enclosed  |                                    | °C                | -25...40  | -25...40                             | -25...40                             | -25...40  |
| Ambient temperature for storage                                       |                                    | °C                | -40 - 80  | -40 - 80                             |                                      |   |
| Mounting position   |                                    |                   |   |                                      |                                      |   |
|   |                                    |                   |   |                                      |                                      | Any, except vertically with terminals A1/A2 below |
| Mechanical shock resistance (IEC/EN 60068-2-27)                       |                                    |                   |   |                                      |                                      |   |
| Half-sinusoidal shock 10 ms   |                                    |                   |   |                                      |                                      |   |
| Basic devices with auxiliary contact module                           |                                    |                   |   |                                      |                                      |   |
|   |                                    | g                 | 7   | 7                                    | 10                                   | 10  |
|   | N/O                                | g                 | 7   | 7                                    | 10                                   | 10  |
|   | NC                                 | g                 | 5   | 5                                    | 8                                    | 8   |
| Protection type   |                                    |                   |   |                                      |                                      |   |
|   |                                    |                   | IP20  | IP20                                 | IP20                                 | IP20  |
| Protection against direct contact when actuated from front (EN 50274) |                                    |                   |   |                                      |                                      |   |
|   |                                    |                   | Finger- and back-of-hand proof  |                                      |                                      |   |
| Weight  |                                    |                   |   |                                      |                                      |   |
| AC operated   |                                    | kg                | 0.23  | 0.05                                 | 0.17                                 | –   |
| DC operated   |                                    | kg                | 0.28  | 0.05                                 | 0.2                                  | –   |
| Terminal capacity   |                                    |                   |   |                                      |                                      |   |
| Screw terminals   |                                    |                   |   |                                      |                                      |   |
|   | Solid                              | mm <sup>2</sup>   | 1 x (0.75 - 4)<br>2 x (0.75 - 2.5)  | 1 x (0.75 - 4)<br>2 x (0.75 - 2.5)   | 1 x (0.75 - 2.5)<br>2 x (0.75 - 2.5) | 1 x (0.75 - 2.5)<br>2 x (0.75 - 2.5)              |
|   | Flexible with ferrule              | mm <sup>2</sup>   | 1 x (0.75 - 2.5)<br>2 x (0.75 - 2.5)  | 1 x (0.75 - 2.5)<br>2 x (0.75 - 2.5) | 1 x (0.75 - 1.5)<br>2 x (0.75 - 1.5) | 1 x (0.75 - 1.5)<br>2 x (0.75 - 1.5)              |
|   | Solid or stranded                  | AWG               | 18 - 14   | 18 - 14                              | 18 - 14                              | 18 - 14   |
|   | Terminal screw                     |                   | M3.5  | M3.5                                 | M3.5                                 | M3.5  |
|   | Pozidriv screwdriver               | Size              | 2   | 2                                    | 2                                    | 2   |
|   | Flat-blade screwdriver             | mm                | 0.8 x 5.5<br>1 x 6  | 0.8 x 5.5<br>1 x 6                   | 0.8 x 5.5<br>1 x 6                   | 0.8 x 5.5<br>1 x 6                                |
|   | Max. tightening torque             | Nm                | 1.2   | 1.2                                  | 1.2                                  | 1.2   |
| Spring-loaded terminals   |                                    |                   |   |                                      |                                      |   |
|   | Solid                              | mm <sup>2</sup>   | 1 x (0.75 - 2.5)<br>2 x (0.75 - 2.5)  | 1 x (0.75 - 2.5)<br>2 x (0.75 - 2.5) | 1 x (1 - 2.5)<br>2 x (1 - 2.5)       | 1 x (1 - 2.5)<br>2 x (1 - 2.5)                    |
|   | Flexible with ferrule              | mm <sup>2</sup>   | 1 x (0.75 - 1.5)<br>2 x (0.75 - 1.5)  | 1 x (0.75 - 1.5)<br>2 x (0.75 - 1.5) | 1 x (1 - 2.5)<br>2 x (1 - 2.5)       | 1 x (1 - 2.5)<br>2 x (1 - 2.5)                    |
|   | Flexible without ferrule DIN 46228 | mm <sup>2</sup>   | 1 x (0.75 - 2.5)<br>2 x (0.75 - 2.5)  | 1 x (0.75 - 1.5)<br>2 x (0.75 - 1.5) | –                                    | –   |
|   | Solid or stranded                  | AWG               | 18 - 14   | 18 - 14                              | 1 x (16 - 14)<br>2 x (16 - 14)       | 1 x (16 - 14)<br>2 x (16 - 14)                    |
|   | Flat-blade screwdriver             | mm                | 0.6 x 3.5   | 0.6 x 3.5                            | 0.6 x 3.5                            | 0.6 x 3.5   |

# 1.1 Mini contactor relays, contactor relays

## 1 DILER, DILA

|  |           |         | DILA              | DILA...XHI | DILER   | DILE... |
|--|-----------|---------|-------------------|------------|---|---------|
| <b>Contacts</b>  |           |         |                   |            |   |         |
| Interlocked opposing contacts to EN 60947-4-1, Annex L, including auxiliary contact module |           |         | Yes               | Yes        | Yes   | Yes     |
| Rated impulse withstand voltage  | $U_{imp}$ | V AC    | 6000              | 6000       | 6000  | 6000    |
| Overvoltage category/degree of pollution   |           |         | III/3             | III/3      | III/3   | III/3   |
| Rated insulation voltage   | $U_i$     | V AC    | 690               | 690        | 690   | 690     |
| Rated operating voltage  | $U_e$     | V AC    | 690               | 500        | 600   | 600     |
| Safe isolation according to EN 61140   |           |         |                   |            |   |         |
| Between coil and auxiliary contacts  |           |         | V AC              | 400        | 300   | 300     |
| Between the auxiliary contacts   |           |         | V AC              | 400        | 300   | 300     |
| Rated operational current  |           |         |                   |            |   |         |
| AC-15  |           |         |                   |            |   |         |
| 220/240 V  | $I_e$     | A       | 4                 | 4          | 6   | 4       |
| 380/415 V  | $I_e$     | A       | 4                 | 4          | 3   | 2       |
| 500 V  | $I_e$     | A       | 1.5               | 1.5        | 1.5   | 1.5     |
| DC <sup>1)</sup>   |           |         |                   |            |   |         |
| L/R $\leq$ 15 ms   |           |         |                   |            |   |         |
| Contacts in series:  |           |         |                   |            |   |         |
| 1  | 24 V      | A       | 10                | 10         | 2.5   | 2.5     |
| 1  | 60 V      | A       | 6                 | 6          | –   | –       |
| 2  | 60 V      | A       | 10                | 10         | 2.5   | 2.5     |
| 1  | 110 V     | A       | 3                 | 3          | –   | –       |
| 3  | 110 V     | A       | 6                 | 6          | 1.5   | 1.5     |
| 1  | 220 V     | A       | 1                 | 1          | –   | –       |
| 3  | 220 V     | A       | 5                 | 5          | 0.5   | 0.5     |
| L/R $\leq$ 50 ms   |           |         |                   |            |   |         |
| Contacts in series:  |           |         |                   |            |   |         |
| 3  | 24 V      | A       | 4                 | 2.5        | –   | –       |
| 3  | 60 V      | A       | 4                 | 1          | –   | –       |
| 3  | 110 V     | A       | 2                 | 0.5        | –   | –       |
| 3  | 220 V     | A       | 1                 | 0.25       | –   | –       |
| DC-13 (6xP)  |           |         |                   |            |   |         |
| Contacts in series:  |           |         |                   |            |   |         |
| 3  | 24 V      | A       | 2.5               | 2.5        | –   | –       |
| 3  | 60 V      | A       | 1                 | 1          | –   | –       |
| 3  | 110 V     | A       | 0.5               | 0.5        | –   | –       |
| 3  | 220 V     | A       | 0.25              | 0.25       | –   | –       |
| Control circuit reliability<br>(at $U_e = 24$ V DC, $U_{min} = 17$ V, $I_{min} = 5.4$ mA)  |           |         | Fault probability | $\lambda$  | <10 <sup>-8</sup> , < one failure in 100 million operations |         |
| Conventional thermal current   |           |         | $I_{th}$          | A          | 16  | 10      |
| Short-circuit strength without welding   |           |         |                   |            |   |         |
| Maximum overcurrent protection device  |           |         |                   |            |   |         |
| 220/240 V  |           | PKZM0   | 4                 | –          | 4   | 4       |
| 380/415 V  |           | PKZM0   | 4                 | –          | 4   | 4       |
| Short-circuit protection rating maximum fuse <sup>2)</sup>                                 |           |         |                   |            |   |         |
| 500 V  |           | A gG/gL | 10                | 10         | 6   | 6       |
| 500 V  |           | A fast  | –                 | –          | 10  | 10      |
| Current heat loss at load of $I_{th}$  |           |         |                   |            |   |         |
| AC operated  |           |         | W                 | 0.3        | 0.2   | 0.2     |
| DC operated  |           |         | W                 | 0.3        | 0.3   | 0.3     |

### Notes

<sup>1)</sup> Switch-on and switch-off conditions based on DC-13, time constant as specified

<sup>2)</sup> See characteristic curve "Fuses" for time/current characteristics (please enquire)

**DILER, DILA**

|  |   |                   | DILA    | DILA...XHI | DILER | DILE...    |    |
|--|---|-------------------|---------|------------|-------|------------|----|
| <b>Magnet systems</b>                                |   |                   |         |            |       |            |    |
| Voltage tolerance                                    |   |                   |         |            |       |            |    |
| AC operated  |   |                   |         |            |       |            |    |
|  | Single-voltage coil 50 Hz and dual-voltage coil 50 Hz, 60 Hz  | Pick-up           | $x U_c$ | 0.8...1.1  | –     | 0.8...1.1  | –  |
|  | Dual-frequency coil 50/60 Hz                                  | Pick-up           | $x U_c$ | 0.8...1.1  | –     | 0.85...1.1 | –  |
| DC operated <sup>1)</sup>                            |   |                   |         |            |       |            |    |
|  | Starting voltage  | Pick-up           | $x U_c$ | 0.8...1.1  | –     | 0.85...1.3 | –  |
|  | At 24 V: without auxiliary contact module (40 °C)             | Pick-up           | $x U_c$ | 0.7 - 1.3  | –     | 0.7 - 1.3  | –  |
| Power consumption                                    |   |                   |         |            |       |            |    |
|  | 50 Hz   | Pick-up           | VA      | 24         | –     | 25         | –  |
|  | 50 Hz   | Sealing           | VA      | 3.4        | –     | 4.6        | –  |
|  | 50 Hz   | Sealing           | W       | 1.2        | –     | 1.3        | –  |
|  | 60 Hz   | Pick-up           | VA      | 30         | –     | 25         | –  |
|  | 60 Hz   | Sealing           | VA      | 4.4        | –     | 4.6        | –  |
|  | 60 Hz   | Sealing           | W       | 1.4        | –     | 1.3        | –  |
|  | 50/60 Hz  | Pick-up           | VA      | 27<br>25   | –     | 30<br>29   | –  |
|  | 50/60 Hz  | Sealing           | VA      | 4.2<br>3.3 | –     | 5.4<br>3.9 | –  |
|  | 50/60 Hz  | Sealing           | W       | 1.4<br>1.2 | –     | 1.6<br>1.1 | –  |
|  | DC operated   | Pick-up = sealing | W       | 3          | –     | 2.6        | –  |
| Duty factor  |   |                   | % DF    | 100        | –     | 100        | –  |
| Changeover times at 100 % $U_c$ (recommended values) |   |                   |         |            |       |            |    |
|  | AC operated closing delay                                     |                   | ms      | 15 - 21    | –     | 14 - 21    | –  |
|  | AC operated normally open contact opening delay               |                   | ms      | 9 - 18     | –     | 8 - 18     | –  |
|  | AC operated with auxiliary contact module, max. closing delay |                   | ms      | –          | –     | 45         | 45 |
|  | DC operated closing delay                                     |                   | ms      | 31         | –     | 26 - 35    | –  |
|  | DC operated normally open contact opening delay               |                   | ms      | 12         | –     | 15 - 25    | –  |
|  | DC operated with auxiliary contact module, max. closing delay |                   | ms      | –          | –     | 70         | 70 |

**Notes**
<sup>1)</sup> Smoothed DC, three-phase bridge rectifier or smoothed two-phase bridge rectifier

# 1.1

## Contactors

Amplifier modules, electronic timer module, contactor monitoring device

### 1 ETS-VS3, DILM, CMD

|   |              |                   | ETS4-VS3   | DILM32-XTE                                    | CMD(24VDC)<br>CMD(220-240VAC)        |
|---|--------------|-------------------|--|---|--------------------------------------|
| <b>General</b>  |              |                   |  |   |                                      |
| Standards   |              |                   | IEC/EN 60947, VDE 0660, UL, CSA  | DIN EN 61812, IEC/EN 60947, VDE 0660, UL, CSA | IEC/EN 60947 UL CSA                  |
| Lifespan, mechanical  |              |                   |  |   |                                      |
| AC operated   | c (contacts) | x 10 <sup>6</sup> | –  | 3   | 10                                   |
| DC operated   | c (contacts) | x 10 <sup>6</sup> | 30   | 3   | 3                                    |
| Maximum operating frequency   |              |                   |  |   |                                      |
| DC operated   | c (contacts) | x 10 <sup>6</sup> | 72000  | –   | 9000                                 |
| Climatic proofing   |              |                   |  |   |                                      |
|   |              |                   | Damp heat, constant, to IEC 60068-2-78<br>Damp heat, cyclic, to IEC 60068-2-30 |   |                                      |
| Ambient temperature   |              |                   |  |   |                                      |
| Storage   |              | °C                | –  | -40 - 80                                      | -40 - 80                             |
| Open  |              | °C                | -25 - 60   | -25 - 60                                      | -25 - 50                             |
| Enclosed  |              | °C                | -25 - 45   | -25 - 40                                      | –                                    |
| Mounting position   |              |                   | Any  | As required, except suspended                 | Any                                  |
| Mechanical shock resistance (IEC/EN 60068-2-27)                       |              |                   |  |   |                                      |
| Half-sinusoidal shock 20 ms   |              |                   |  |   |                                      |
| N/O   |              | g                 | 10   | –   | –                                    |
| Half-sinusoidal shock 10 ms   |              |                   |  |   |                                      |
| N/O   |              | g                 | –  | 6   | 4                                    |
| NC  |              | g                 | –  | 6   | 4                                    |
| Protection type   |              |                   | IP20   | IP20  | IP20                                 |
| Protection against direct contact when actuated from front (EN 50274) |              |                   | Finger- and back-of-hand proof   |   |                                      |
| Weight  |              | kg                | 0.09   | 0.08  | 0.1                                  |
| Terminal capacity   |              |                   |  |   |                                      |
| Solid   |              | mm <sup>2</sup>   | 1 x (0.75 - 2.5)<br>2 x (0.75 - 2.5) <sup>1)</sup>                             | 1 x (0.75 - 2.5)<br>2 x (0.75 - 1.5)          | 1 x (0.75...2.5)<br>2 x (0.75...1.5) |
| Flexible with ferrule   |              | mm <sup>2</sup>   | 1 x (0.75 - 2.5)<br>2 x (0.75 - 1.5) <sup>1)</sup>                             | 1 x (0.75 - 1.5)<br>2 x (0.75 - 1.5)          | 1 x (0.75...1.5)<br>2 x (0.75...1.5) |
| Solid or stranded   |              | AWG               | 16 - 14  | 18 - 14                                       | 18...14                              |
| Terminal screw  |              |                   | M3.5   | M3.5  | M3.5                                 |
| Pozidriv screwdriver  |              | Size              | 2  | 2   | 2                                    |
| Flat-blade screwdriver  |              | mm                | 0.8 x 5.5<br>1 x 6   | 0.8 x 5.5<br>1 x 6                            | 0.8 x 5.5<br>1 x 6                   |
| Max. tightening torque  |              | Nm                | 1.2  | 1.2   | 1.2                                  |

#### Notes

<sup>1)</sup> Use equal cross-sections only



## ETS-VS3, DILM, CMD

1

|   |                   |               | ETS4-VS3   | DILM32-XTE | CMD(24VDC) | CMD(220-240VAC) |
|---|-------------------|---------------|--|------------|------------|-----------------|
| <b>Contacts</b>   |                   |               |  |            |            |                 |
| Rated impulse withstand voltage   | $U_{imp}$         | V AC          | 6000   | 6000       | 8000       | 4000            |
| Overvoltage category/degree of pollution  |                   |               | III/2  | III/3      | III/3      | III/3           |
| Rated insulation voltage  | $U_i$             | V AC          | 440  | 600        | 100        | 250             |
| Rated operating voltage   | $U_e$             | V             | 440 AC   | 400 AC     | 24 DC      | 250 AC          |
| Rated operational current   |                   |               |  |            |            |                 |
| AC-15   |                   |               |  |            |            |                 |
| 220/240 V   | $I_e$             | A             | 2  | 3          | –          | –               |
| 280/415 V   | $I_e$             | A             | 2  | –          | –          | –               |
| DC-13 <sup>1)</sup>   |                   |               |  |            |            |                 |
| DC-13 L/R $\leq 15$ ms  |                   |               |  |            |            |                 |
| Contacts in series:   |                   |               |  |            |            |                 |
| 1   | 24 V              | A             | 2.6  | 1          | –          | –               |
| 1   | 60 V              | A             | 1  | 0.2        | –          | –               |
| 1   | 110 V             | A             | 0.6  | 0.2        | –          | –               |
| 1   | 220 V             | A             | 0.2  | 0.1        | –          | –               |
| DC-13 L/R $\leq 50$ ms  |                   |               |  |            |            |                 |
| Contacts in series:   |                   |               |  |            |            |                 |
| 1   | 24 V              | A             | 2  | 1          | –          | –               |
| 1   | 60 V              | A             | 0.6  | 0.2        | –          | –               |
| 1   | 110 V             | A             | 0.08   | 0.2        | –          | –               |
| 1   | 220 V             | A             | 0.08   | 0.1        | –          | –               |
| DC-13 L/R $\leq 300$ ms   |                   |               |  |            |            |                 |
| Contacts in series:   |                   |               |  |            |            |                 |
| 1   | 24 V              | A             | 0.6  | 1          | –          | –               |
| 1   | 60 V              | A             | 0.2  | 0.2        | –          | –               |
| 1   | 110 V             | A             | 0.08   | 0.2        | –          | –               |
| 1   | 220 V             | A             | 0.03   | 0.1        | –          | –               |
| Safe isolation according to EN 61140  |                   |               |  |            |            |                 |
| Between coil and auxiliary contacts   |                   | V AC          | –  | 250        | –          | –               |
| Between the auxiliary contacts  |                   | V AC          | –  | 250        | –          | –               |
| Control circuit reliability<br>(at $U_e = 24$ V DC, $U_{min} = 17$ V, $I_{min} = 5.4$ mA) | Fault probability | $\lambda$     | $<10^{-8}$ , < one failure in 100 million operations | –          | –          | –               |
| Conventional thermal current  | $I_{th}$          | A             | 6  | 4          | –          | –               |
| Component lifespan  |                   |               |  |            |            |                 |
| AC-15   |                   |               |  |            |            |                 |
| 230 V, $I_e = 0.1$ A  | Switch operations | $\times 10^6$ | 7  | –          | –          | –               |
| 230 V, $I_e = 1.2$ A  | Switch operations | $\times 10^6$ | 1  | –          | –          | –               |
| Short-circuit rating without welding  |                   |               |  |            |            |                 |
| Short-circuit protection rating maximum fuse <sup>2)</sup>                                |                   |               |  |            |            |                 |
| 500 V   |                   | A gG/gL       | –  | 4          | 2          | 2               |
| 500 V   |                   | A fast        | 4  | –          | –          | –               |

### Notes

<sup>1)</sup> Switch-on and switch-off conditions based on DC-13, time constant as specified

<sup>2)</sup> See transparent overlay "Fuses" for time/current characteristics (please enquire)

# 1.1

## Contactors

Amplifier modules, electronic timer module, contactor monitoring device

### 1 ETS-VS3, DILM, CMD

|  |                             |                   | ETS4-VS3  | DILM32-XTE | CMD(24VDC)<br>CMD(220-240VAC) |
|--|-----------------------------|-------------------|-----------|------------|-------------------------------|
| <b>Magnet systems</b>                                |                             |                   |           |            |                               |
| Voltage tolerance                                    |                             |                   |           |            |                               |
| Starting voltage                                     |                             |                   |           |            |                               |
|  | AC operated                 |                   |           |            |                               |
|  |                             | Pick-up           | $x U_c$   | –          | 0.85 - 1.1                    |
|  | DC operated <sup>1)</sup>   |                   |           |            | 0.85 - 1.1                    |
|  |                             | Pick-up           | $x U_c$   | 0.85 - 1.2 | 0.7 - 1.2                     |
| Power consumption                                    |                             |                   |           |            |                               |
|  | AC operated                 | Sealing           | VA        | –          | 2                             |
|  | AC operated                 | Sealing           | W         | –          | 1.8                           |
|  | DC operated                 | Pick-up = sealing | W         | 0.6        | –                             |
|  |                             |                   |           |            | 4                             |
| Duty factor  |                             |                   | % DF      | 100        | 100                           |
| Changeover times at 100 % $U_c$ (recommended values) |                             |                   |           |            |                               |
|  | DC operated closing delay   |                   | ms        | 7          | –                             |
|  | DC operated opening delay   |                   | ms        | 3          | –                             |
| Maximum operating frequency                          |                             |                   |           |            |                               |
|  | Max. operating frequency    |                   | Ops/h     | –          | 3600                          |
|  | 6 A/250 V                   |                   | Ops/h     | –          | 360                           |
| Minimum on duration                                  |                             |                   |           |            |                               |
|  | On-delayed                  |                   | ms        | –          | < 50                          |
|  | Off-delayed                 |                   | ms        | –          | < 200                         |
| Repetition accuracy (with constant parameters)       |                             |                   | Deviation | %          | –                             |
| Recovery time (after 100% time delay)                |                             |                   |           | ms         | –                             |
| Recovery time (after 100% time delay)                |                             |                   |           |            | 70                            |
| Contact changeover time                              |                             |                   |           |            |                               |
|  | DILM32-XTEE11/DILM32-XTED11 | $t_u$             | ms        | –          | 10                            |
|  | DILM32-XTEY20               | $t_u$             | ms        | –          | 50                            |
|  | CMD                         | $t_u$             | ms        | –          | –                             |
|  |                             |                   |           |            | 100 ± 20%                     |

#### Notes

<sup>1)</sup> Smoothed DC, three-phase bridge rectifier or smoothed two-phase bridge rectifier

DILEEM, DILEM

|   |                                | DILEEM<br>DILEM<br>DILEM12   | DILEEM-G<br>DILEM-G<br>DILEM12-G     | DILEM4 | DILEM4-G  |
|---|--------------------------------|--|--------------------------------------|--------|---|
| <b>General</b>  |                                |  |                                      |        |   |
| Standards   |                                | IEC/EN 60947, VDE 0660, CSA, UL  |                                      |        |   |
| Lifespan, mechanical; Coil 50/60 Hz                                   | at 50 Hz                       | 7  | –                                    | 7      | –   |
| Lifespan, mechanical  | c (contacts) x 10 <sup>6</sup> | 10   | 20                                   | 20     | –   |
| Maximum operating frequency   |                                |  |                                      |        |   |
| Mechanical  |                                | Ops/h  | 9000                                 |        |   |
| Electrical (Contactor without overload relay)                         |                                | → Characteristic curves Page 91  |                                      |        |   |
| Climatic proofing   |                                | Damp heat, constant, to IEC 60068-2-78<br>Damp heat, cyclic, to IEC 60068-2-30 |                                      |        |   |
| Ambient temperature   |                                |  |                                      |        |   |
| Open  |                                | °C   | -25 - 50                             |        |   |
| Enclosed  |                                | °C   | -25 - 40                             |        |   |
| Mounting position   |                                | Any, except for vertically with terminals A1/A2 below                          |                                      |        |  |
| Mechanical shock resistance (IEC/EN 60068-2-27)                       |                                |  |                                      |        |   |
| Half-sinusoidal shock 10 ms   |                                |  |                                      |        |   |
| Basic device without auxiliary contact module                         |                                |  |                                      |        |   |
| Main circuit normally open contact                                    |                                | g  | 10                                   |        |   |
| Auxiliary contacts NC/Normally open contact                           |                                | g  | 10/8                                 | 10/8   | –   |
| Basic devices with auxiliary contact module                           |                                |  |                                      |        |   |
| Main circuit normally open contact                                    |                                | g  | 10                                   |        |   |
| Auxiliary contacts Normally open contact/NC                           |                                | g  | 20/20                                |        |   |
| Protection type   |                                | IP20   |                                      |        |   |
| Protection against direct contact when actuated from front (EN 50274) |                                | Finger- and back-of-hand proof   |                                      |        |   |
| Weight  |                                | kg   | 0.2                                  | 0.17   | 0.2   |
| Terminal capacity: main and auxiliary contacts                        |                                |  |                                      |        |   |
| Solid   |                                | mm <sup>2</sup>  | 1 x (0.75 - 2.5)<br>2 x (0.75 - 2.5) |        |   |
| Flexible with ferrule   |                                | mm <sup>2</sup>  | 1 x (0.75 - 1.5)<br>2 x (0.75 - 1.5) |        |   |
| Solid or stranded   |                                | AWG  | 18 - 14                              |        |   |
| Terminal screw  |                                | M3.5   |                                      |        |   |
| Pozidriv screwdriver  |                                | Size   | 2                                    |        |   |
| Flat-blade screwdriver  |                                | mm   | 0.8 x 5.5<br>1 x 6                   |        |   |
| Max. tightening torque  |                                | Nm   | 1.2                                  |        |   |
| Terminal capacity springloaded terminals main and control circuits    |                                |  |                                      |        |   |
| Solid   |                                | mm <sup>2</sup>  | 1 x (1 - 2.5)<br>2 x (1 - 2.5)       |        |   |
| Flexible with ferrule   |                                | mm <sup>2</sup>  | 1 x (1 - 2.5)<br>2 x (1 - 2.5)       |        |   |
| Flat-blade screwdriver  |                                | mm   | 0.6 x 3.5                            |        |   |

# 1.1

## Mini contactor relays

### DILEEM, DILEM

1

|  |   |           |          | DILEEM<br>DILEEM-G    | DILEM<br>DILEM-G | DILEM4 | DILEM4-G | DILEM12<br>DILEM12-G |     |
|--|---|-----------|----------|-----------------------|------------------|--------|----------|----------------------|-----|
| <b>Main contacts</b>   |   |           |          |                       |                  |        |          |                      |     |
| Rated impulse withstand voltage  | $U_{imp}$   | V AC      |          | 6000                  | 6000             | 6000   | 6000     | 6000                 |     |
| Overvoltage category/pollution degree                                    |   |           |          | III/3                 | III/3            | III/3  | III/3    | III/3                |     |
| Rated insulation voltage   | $U_i$   | V AC      |          | 690                   | 690              | 690    | 690      | 690                  |     |
| Rated operating voltage  | $U_e$   | V AC      |          | 690                   | 690              | 690    | 690      | 690                  |     |
| Safe isolation according to EN 61140                                     |   |           |          |                       |                  |        |          |                      |     |
| Between coil and contacts  |   | V AC      |          | 300                   | 300              | 300    | 300      | 300                  |     |
| Between the contacts   |   | V AC      |          | 300                   | 300              | 300    | 300      | 300                  |     |
| Making capacity of up to 440 V (cos $\phi$ as specified in IEC/EN 60947) |   |           |          | A                     | 110              | 110    | 110      | 120                  |     |
| Breaking capacity  | 220/230 V   | A         |          | 90                    | 90               | 90     | 90       | 96                   |     |
|  | 380/400 V   | A         |          | 90                    | 90               | 90     | 90       | 96                   |     |
|  | 500 V   | A         |          | 64                    | 64               | 64     | 64       | 72                   |     |
|  | 660/690 V   | A         |          | 42                    | 42               | 42     | 42       | 42                   |     |
| Devices lifespan   | AC-1  |           |          | → Engineering Page 88 |                  |        |          |                      |     |
|  | AC-3  |           |          | → Engineering Page 87 |                  |        |          |                      |     |
|  | AC-4  |           |          | → Engineering Page 87 |                  |        |          |                      |     |
| Short-circuit protection rating maximum fuse                             |   |           |          |                       |                  |        |          |                      |     |
|  | Type "2" coordination 500 V                               | gL/gG     | A        | 10                    | 10               | 10     | 10       | 20                   |     |
|  | Type "1" coordination 500 V                               | gL/gG     | A        | 20                    | 20               | 20     | 20       | 35                   |     |
| <b>AC voltage</b>  |   |           |          |                       |                  |        |          |                      |     |
| AC-1 operation   |   |           |          |                       |                  |        |          |                      |     |
| Conventional thermal current 3 pole 50 - 60 Hz                           |   |           |          |                       |                  |        |          |                      |     |
| Open   |   | at 40 °C  | $I_{th}$ | A                     | 22               | 22     | 22       | 22                   |     |
|  |   | at 50 °C  | $I_{th}$ | A                     | 20               | 20     | 20       | 20                   |     |
|  |   | at 55 °C  | $I_{th}$ | A                     | 19               | 19     | 19       | 19                   |     |
| Enclosed <sup>1)</sup>   |   | $I_{th}$  | A        | 16                    | 16               | 16     | 16       |                      |     |
| Conventional thermal current, 1-pole                                     |   |           |          |                       |                  |        |          |                      |     |
| Open <sup>1)</sup>   |   | $I_{th}$  | A        | 50                    | 50               | 60     | 60       | 50                   |     |
| Enclosed <sup>1)</sup>   |   | $I_{th}$  | A        | 40                    | 40               | 50     | 50       | 40                   |     |
| AC-3 operation   |   |           |          |                       |                  |        |          |                      |     |
| Rated operational current AC-3 open, 50 - 60 Hz, 3-pole1)                | 220/230 V   | $I_e$     | A        | 6.6                   | 9                | 9      | 9        | 12                   |     |
|  | 240 V   | $I_e$     | A        | 6.6                   | 9                | 9      | 9        | 12                   |     |
|  | 380/400 V   | $I_e$     | A        | 6.6                   | 9                | 9      | 9        | 12                   |     |
|  | 415 V   | $I_e$     | A        | 6.6                   | 9                | 9      | 9        | 12                   |     |
|  | 440 V   | $I_e$     | A        | 6.6                   | 9                | 9      | 9        | 10.5                 |     |
|  | 500 V   | $I_e$     | A        | 5                     | 6.4              | 6.4    | 6.4      | 9                    |     |
| Motor rating   | 660/690 V   | $I_e$     | A        | 3.5                   | 4.8              | 4.8    | 4.8      | 5.2                  |     |
|  | 220/230 V   | P         | kW       | 1.5                   | 2.2              | 2.2    | 2.2      | 3.5                  |     |
|  | 240 V   | P         | kW       | 1.8                   | 2.5              | 2.5    | 2.5      | 3                    |     |
|  | 380/400 V   | P         | kW       | 3                     | 4                | 4      | 4        | 5.5                  |     |
|  | 415 V   | P         | kW       | 3.1                   | 4.3              | 4.3    | 4.3      | 5.5                  |     |
|  | 440 V   | P         | kW       | 3.3                   | 4.6              | 4.6    | 4.6      | 5.5                  |     |
| AC-4 operation   | 500 V   | P         | kW       | 3                     | 4                | 4      | 4        | 5.5                  |     |
|  | 660/690 V   | P         | kW       | 3                     | 4                | 4      | 4        | 4                    |     |
|  | Rated operational current AC-4 open, 50 - 60 Hz, 3-pole1) | 220/230 V | $I_e$    | A                     | 5                | 6.6    | 6.6      | 6.6                  | 6.6 |
|  |   | 240 V     | $I_e$    | A                     | 5                | 6.6    | 6.6      | 6.6                  | 6.6 |
|  |   | 280/400 V | $I_e$    | A                     | 5                | 6.6    | 6.6      | 6.6                  | 6.6 |
|  |   | 415 V     | $I_e$    | A                     | 5                | 6.6    | 6.6      | 6.6                  | 6.6 |
| 440 V  |   | $I_e$     | A        | 5                     | 6.6              | 6.6    | 6.6      | 6.6                  |     |
| 500 V  |   | $I_e$     | A        | 3.7                   | 5                | 5      | 5        | 5                    |     |
| Rated operational power  | 660/690 V   | $I_e$     | A        | 2.9                   | 3.4              | 3.4    | 3.4      | 3.4                  |     |
|  | 220/230 V   | P         | kW       | 1.1                   | 1.5              | 1.5    | 1.5      | 1.5                  |     |
|  | 240 V   | P         | kW       | 1.3                   | 1.8              | 1.8    | 1.8      | 1.8                  |     |
|  | 380/400 V   | P         | kW       | 2.2                   | 3                | 3      | 3        | 3                    |     |
|  | 415 V   | P         | kW       | 2.3                   | 3.1              | 3.1    | 3.1      | 3.1                  |     |
|  | 440 V   | P         | kW       | 2.4                   | 3.3              | 3.3    | 3.3      | 3.3                  |     |
| 500 V  | P   | kW        | 2.2      | 3                     | 3                | 3      | 2.2      |                      |     |
| 660/690 V  | P   | kW        | 2.2      | 3                     | 3                | 3      | 2.2      |                      |     |

#### Notes

<sup>1)</sup> At maximum permissible ambient air temperature

DILEEM, DILEM

|  |   |         |                               | DILEEM                | DILEEM-G  | DILEM      | DILEM-G   | DILEM4     | DILEM4-G   | DILEM12   | DILEM12-G |
|--|---|---------|-------------------------------|-----------------------|-----------|------------|-----------|------------|------------|-----------|-----------|
| <b>DC voltage</b>  |   |         |                               |                       |           |            |           |            |            |           |           |
| Operations   |   |         |                               | → Engineering Page 92 |           |            |           |            |            |           |           |
| Rated operational current open                               |   |         |                               |                       |           |            |           |            |            |           |           |
| DC-1   | 12 V  | $I_e$   | A                             | 20                    | 20        | 20         | 20        | 20         | 20         | 20        | 20        |
|  | 24 V  | $I_e$   | A                             | 20                    | 20        | 20         | 20        | 20         | 20         | 20        | 20        |
|  | 60 V  | $I_e$   | A                             | 20                    | 20        | 20         | 20        | 20         | 20         | 20        | 20        |
|  | 110 V   | $I_e$   | A                             | 20                    | 20        | 20         | 20        | 20         | 20         | 20        | 20        |
|  | 220 V   | $I_e$   | A                             | 20                    | 20        | 20         | 20        | 20         | 20         | 20        | 20        |
| DC-3   | 12 V  | $I_e$   | A                             | 6                     | 6         | 8          | 8         | 8          | 8          | 8         | 8         |
|  | 24 V  | $I_e$   | A                             | 6                     | 6         | 8          | 8         | 8          | 8          | 6         | 8         |
|  | 60 V  | $I_e$   | A                             | 3                     | 3         | 4          | 4         | 4          | 4          | 4         | 4         |
|  | 110 V   | $I_e$   | A                             | 2                     | 2         | 3          | 3         | 3          | 3          | 3         | 3         |
|  | 220 V   | $I_e$   | A                             | –                     | –         | –          | –         | 1          | 1          | –         | –         |
| DC-5   | 12 V  | $I_e$   | A                             | 1.8                   | 1.8       | 2.5        | 2.5       | 2.5        | 2.5        | 2.5       | 2.5       |
|  | 24 V  | $I_e$   | A                             | 1.8                   | 1.8       | 2.5        | 2.5       | 2.5        | 2.5        | 2.5       | 2.5       |
|  | 60 V  | $I_e$   | A                             | 1.8                   | 1.8       | 2.5        | 2.5       | 2.5        | 2.5        | 2.5       | 2.5       |
|  | 110 V   | $I_e$   | A                             | 1.8                   | 1.8       | 1.5        | 1.5       | 2.5        | 2.5        | 1.5       | 1.5       |
|  | 220 V   | $I_e$   | A                             | 0.2                   | 0.2       | 0.3        | 0.3       | 1          | 1          | 0.3       | 0.3       |
| Current heat loss (3-pole or 4-pole)                         |   |         |                               |                       |           |            |           |            |            |           |           |
| At $I_{th}$  |   |         | W                             | 2                     | 3.5       | 2          | 3.5       | 2.7        | 4.7        | 2         | 3.5       |
| At $I_e$ to AC-3/400 V                                       |   |         | W                             | 0.5                   | 0.7       | 0.5        | 0.7       | –          | –          | 0.5       | 0.7       |
| <b>Magnet systems</b>  |   |         |                               |                       |           |            |           |            |            |           |           |
| Voltage tolerance  |   |         |                               |                       |           |            |           |            |            |           |           |
| Single-voltage coil 50 Hz and dual-voltage coil 50 Hz, 60 Hz |   | Pick-up | $x U_c$                       | 0.8 - 1.1             | –         | 0.8 - 1.1  | –         | 0.8 - 1.1  | –          | 0.8 - 1.1 | –         |
| Dual-frequency coil 50/60 Hz                                 |   | Pick-up | $x U_c$                       | 0.8 - 1.1             | –         | 0.85 - 1.1 | –         | 0.85 - 1.1 | –          | 0.8 - 1.1 | –         |
| DC operated  |   | Pick-up | $x U_c$                       | –                     | 0.8 - 1.1 | –          | 0.8 - 1.1 | –          | 0.85 - 1.1 | –         | 0.8 - 1.1 |
| Power consumption  |   |         |                               |                       |           |            |           |            |            |           |           |
| AC operation   | Single-voltage coil, 50 Hz, and dual-voltage coil, 50 Hz, 60 Hz | Pick-up | VA                            | 25                    | –         | 25         | –         | 25         | –          | 25        | –         |
|  |   | Pick-up | W                             | 22                    | –         | 22         | –         | 22         | –          | 22        | –         |
|  |   | Sealing | VA                            | 4.6                   | –         | 4.6        | –         | 4.6        | –          | 4.6       | –         |
|  |   | Sealing | W                             | 1.3                   | –         | 1.3        | –         | 1.3        | –          | 1.3       | –         |
|  | Dual-frequency coil 50/60 Hz at 50 Hz                           | Pick-up | VA                            | 30                    | –         | 30         | –         | 30         | –          | 30        | –         |
|  |   | Pick-up | W                             | 26                    | –         | 26         | –         | 26         | –          | 26        | –         |
|  |   | Sealing | VA                            | 5.4                   | –         | 5.4        | –         | 5.4        | –          | 5.4       | –         |
|  |   | Sealing | W                             | 1.6                   | –         | 1.6        | –         | 1.6        | –          | 1.6       | –         |
|  | Dual-frequency coil 50/60 Hz at 60 Hz                           | Pick-up | VA                            | 29                    | –         | 29         | –         | 29         | –          | 29        | –         |
|  |   | Pick-up | W                             | 24                    | –         | 24         | –         | 24         | –          | 24        | –         |
|  |   | Sealing | VA                            | 3.9                   | –         | 3.9        | –         | 3.9        | –          | 3.9       | –         |
|  |   | Sealing | W                             | 1.1                   | –         | 1.1        | –         | 1.1        | –          | 1.1       | –         |
|  | Single-voltage coil, 50 Hz, and dual-voltage coil, 50 Hz, 60 Hz | Pick-up | VA                            | 25                    | –         | 25         | –         | 25         | –          | 25        | –         |
|  |   | Pick-up | VA                            | 30                    | –         | 30         | –         | 30         | –          | 30        | –         |
| Pick-up  |   | VA      | 29                            | –                     | 29        | –          | 29        | –          | 29         | –         |           |
| Pick-up  |   | VA      | 29                            | –                     | 29        | –          | 29        | –          | 29         | –         |           |
| DC operation <sup>1)</sup>                                   | Power consumption pick-up = sealing                             |         | VA/W                          | –                     | 2.6       | –          | 2.6       | –          | 2.6        | –         | 2.6       |
| Duty fac tor   |   |         | % DF                          | 100                   | 100       | 100        | 100       | 100        | 100        | 100       | 100       |
| Switching times at 100 % $U_c$                               |   |         |                               |                       |           |            |           |            |            |           |           |
| N/O  | Closing delay min.  |         | ms                            | 14                    | 26        | 14         | 26        | 14         | 26         | 14        | 26        |
|  | Closing delay max.  |         | ms                            | 21                    | 35        | 21         | 35        | 21         | 35         | 21        | 35        |
|  | Opening delay min.  |         | ms                            | 8                     | 15        | 8          | 15        | 8          | 15         | 8         | 15        |
|  | Opening delay max.  |         | ms                            | 18                    | 25        | 18         | 25        | 18         | 25         | 18        | 25        |
|  | Closing delay with top mounting auxiliary contact               |         | ms                            | Max. 45               | Max. 70   | Max. 45    | Max. 70   | Max. 45    | Max. 70    | Max. 45   | Max. 70   |
| Reversing con-   | Changeover time at 110 % $U_c$ factors                          |         |                               |                       |           |            |           |            |            |           |           |
|  | Changeover time min.  |         | ms                            | 16                    | 40        | 16         | 40        | 16         | 40         | 16        | 40        |
|  | Changeover time maX.  |         | ms                            | 21                    | 50        | 21         | 50        | 21         | 50         | 21        | 50        |
| Arcing time at 690 V AC                                      |   | ms      | Max. 12                       | Max. 12               | Max. 12   | Max. 12    | Max. 12   | Max. 12    | Max. 12    | Max. 12   | Max. 12   |
| Coil   | Lifespan, mechanical; Coil 50/60 Hz                             |         | c(contacts) x 10 <sup>6</sup> | 7                     | –         | 7          | –         | 7          | –          | 7         | –         |

Notes

<sup>1)</sup> Smoothed DC or three-phase bridge rectifier

# 1.1 Mini contactor relays

## DILEEM, DILEM

1

|   |  | DILE(E)M(-12)...  |               | ...DILEM   |
|---|--|-------------------|---------------|--|
| <b>Auxiliary contact</b>  |  |                   |               |  |
| Interlocked opposing contacts to EN 60947-5-1 Annex L, including auxiliary contact module |  | Yes               |               | Yes  |
| Rated impulse withstand voltage   | $U_{imp}$  | V AC              | 6000          | 6000   |
| Overvoltage category/pollution degree   |  | III/3             |               | III/3  |
| Rated insulation voltage  | $U_i$  | V AC              | 690           | 690  |
| Rated operating voltage   | $U_e$  | V AC              | 600           | 600  |
| Safe isolation according to EN 61140  |  |                   |               |  |
| Between coil and auxiliary contacts   |  | V AC              | 300           | 300  |
| Between the auxiliary contacts  |  | V AC              | 300           | 300  |
| Rated operational current   |  |                   |               |  |
| AC-15   |  |                   |               |  |
|   | 220/240 V  | $I_e$             | A             | 6  |
|   | 380/415 V  | $I_e$             | A             | 3  |
|   | 500 V  | $I_e$             | A             | 1.5  |
| DC  | $L/R \leq 15$ ms                                     |                   |               |  |
| Contacts in series:   |  |                   |               |  |
|   | 1  | 24 V              | A             | 2.5  |
|   | 2  | 60 V              | A             | 2.5  |
|   | 3  | 100 V             | A             | 1.5  |
|   | 3  | 220 V             | A             | 0.5  |
| Conventional thermal current  |  | $I_{th}$          | A             | 10   |
| Control circuit reliability (at $U_e = 24$ V DC, $U_{min} = 17$ V, $I_{min} = 5.4$ mA)    |  | Fault probability | $\lambda$     | $<10^{-8}$ , < one failure in 100 million operations |
| Component lifespan at $U_e = 240$ V   |  |                   |               |  |
| AC-15   |  | c (contacts)      | $\times 10^6$ | 0.2  |
| DC <sup>1)</sup>  |  |                   |               |  |
|   | $L/R = 50$ ms: 2 contacts in series at $I_e = 0.5$ A | c (contacts)      | $\times 10^6$ | 0.15   |
| Short-circuit rating without welding  |  |                   |               |  |
| Maximum overcurrent protective device   |  | PKZM0-4           |               | PKZM0-4  |
| Short-circuit protection rating maximum fuse  |  |                   |               |  |
|   | 500 V  | A gG/gL           | 6             | 6  |
|   | 500 V  | A fast            | 10            | 10   |
| Current heat loss at load of $I_{th}$   |  |                   |               |  |
|   | Per contact  | W                 | 0.2           | 0.2  |

**Notes** <sup>1)</sup> Switch-on and switch-off conditions based on DC-13, time constant as specified

### DILM7 ... DILM170

1

|   |                                 |                                      | DILM7  | DILM9    | DILM12   | DILM15   | DILM17                               | DILM25   |
|---|---------------------------------|--------------------------------------|--|----------|----------|----------|--------------------------------------|----------|
| <b>General</b>  |                                 |                                      |  |          |          |          |                                      |          |
| Standards   | IEC/EN 60947, VDE 0660, UL, CSA |                                      |  |          |          |          |                                      |          |
| Lifespan, mechanical  |                                 |                                      |  |          |          |          |                                      |          |
| AC operated   | c (contacts)                    | x 10 <sup>6</sup>                    | 10   | 10       | 10       | 10       | 10                                   | 10       |
| DC operated   | c (contacts)                    | x 10 <sup>6</sup>                    | 10   | 10       | 10       | 10       | 10                                   | 10       |
| Operating frequency, mechanical                                       |                                 |                                      |  |          |          |          |                                      |          |
| Mechanical, AC operated   | Operations/h                    |                                      | 9000   | 9000     | 9000     | 5000     | 5000                                 | 5000     |
| DC operated   | Operations/h                    |                                      | 9000   | 9000     | 9000     | 5000     | 5000                                 | 5000     |
| Maximum operating frequency   |                                 |                                      |  |          |          |          |                                      |          |
| Electrical (Contactor without overload relay)                         | → Characteristic curves Page 74 |                                      |  |          |          |          |                                      |          |
| Climatic proofing   |                                 |                                      |  |          |          |          |                                      |          |
| Damp heat, constant, to IEC 60068-2-78                                |                                 |                                      |  |          |          |          |                                      |          |
| Damp heat, cyclic, to IEC 60068-2-30                                  |                                 |                                      |  |          |          |          |                                      |          |
| Ambient temperature   |                                 |                                      |  |          |          |          |                                      |          |
| Open  | °C                              |                                      | -25...60   | -25...60 | -25...60 | -25...60 | -25...60                             | -25...60 |
| Enclosed  | °C                              |                                      | -25...40   | -25...40 | -25...40 | -25...40 | -25...40                             | -25...40 |
| Storage   | °C                              |                                      | -40 - 80   | -40 - 80 | -40 - 80 | -40 - 80 | -40 - 80                             | -40 - 80 |
| Mounting position AC- and DC operated                                 |                                 |                                      |  |          |          |          |                                      |          |
|   |                                 |                                      |  |          |          |          |                                      |          |
| Mechanical shock resistance (IEC/EN 60068-2-27)                       |                                 |                                      |  |          |          |          |                                      |          |
| Half-sinusoidal shock 10 ms   |                                 |                                      |  |          |          |          |                                      |          |
| Main contacts   |                                 |                                      |  |          |          |          |                                      |          |
|   | N/O                             | g                                    | 10   | 10       | 10       | 10       | 10                                   | 10       |
| Auxiliary contacts  |                                 |                                      |  |          |          |          |                                      |          |
|   | N/O                             | g                                    | 7  | 7        | 7        | 7        | 7                                    | 7        |
|   | NC                              | g                                    | 5  | 5        | 5        | 5        | 5                                    | 5        |
| Mechanical shock resistance (IEC/EN 60068-2-27) with table mounting   |                                 |                                      |  |          |          |          |                                      |          |
| Half-sinusoidal shock 10 ms   |                                 |                                      |  |          |          |          |                                      |          |
| Main contacts   |                                 |                                      |  |          |          |          |                                      |          |
|   | N/O                             | g                                    | 5.7  | 5.7      | 5.7      | 5.7      | 6.9                                  | 6.9      |
| Auxiliary contacts  |                                 |                                      |  |          |          |          |                                      |          |
|   | N/O                             | g                                    | 3.4  | 3.4      | 3.4      | 3.4      | 5.3                                  | 5.3      |
|   | NC                              | g                                    | 3.4  | 3.4      | 3.4      | 3.4      | 3.5                                  | 3.5      |
| Protection type   |                                 |                                      |  |          |          |          |                                      |          |
| Protection against direct contact when actuated from front (EN 50274) |                                 |                                      | IP20   | IP20     | IP20     | IP20     | IP00                                 | IP00     |
| Finger- and back-of-hand proof  |                                 |                                      |  |          |          |          |                                      |          |
| Weight  |                                 |                                      |  |          |          |          |                                      |          |
| AC operated   | kg                              |                                      | 0.23   | 0.23     | 0.23     | 0.23     | 0.42                                 | 0.42     |
| DC operated   | kg                              |                                      | 0.28   | 0.28     | 0.28     | 0.28     | 0.48                                 | 0.48     |
| Terminal type, screw connection                                       |                                 |                                      |  |          |          |          |                                      |          |
| Terminal capacity of main cable                                       |                                 |                                      |  |          |          |          |                                      |          |
| Solid   | mm <sup>2</sup>                 |                                      | 1 x (0.75 - 4)<br>2 x (0.75 - 2.5)                 |          |          |          | 1 x (0.75 - 16)<br>2 x (0.75 - 10)   |          |
| Flexible with ferrule   | mm <sup>2</sup>                 |                                      | 1 x (0.75 - 2.5)<br>2 x (0.75 - 2.5) <sup>1)</sup> |          |          |          | 1 x (0.75 - 16)<br>2 x (0.75 - 10)   |          |
| Stranded  | mm <sup>2</sup>                 |                                      | –  | –        | –        | –        | 1 x 16                               | 1 x 16   |
| Solid or stranded   | AWG                             |                                      | 18 - 10  | 18 - 10  | 18 - 10  | 18 - 10  | 18 - 6                               | 18 - 6   |
| Flat conductor  | mm                              | Number of layers x width x thickness | –  | –        | –        | –        | –                                    | –        |
| Terminal capacity of control circuit cable                            |                                 |                                      |  |          |          |          |                                      |          |
| Solid   | mm <sup>2</sup>                 |                                      | 1 x (0.75 - 4)<br>2 x (0.75 - 2.5)                 |          |          |          | 1 x (0.75 - 4)<br>2 x (0.75 - 4)     |          |
| Flexible with ferrule   | mm <sup>2</sup>                 |                                      | 1 x (0.75 - 2.5)<br>2 x (0.75 - 2.5)               |          |          |          | 1 x (0.75 - 2.5)<br>2 x (0.75 - 2.5) |          |
| Solid or stranded   | AWG                             |                                      | 18 - 10  | 18 - 10  | 18 - 10  | 18 - 10  | 18 - 14                              | 18 - 14  |

**Notes**

<sup>1)</sup> Also without ferrule.

| DILM32 | DILM38 | DILM40 | DILM50 | DILM65 | DILM72 | DILM80 | DILM95 | DILM115 | DILM150 | DILM170 |
|--------|--------|--------|--------|--------|--------|--------|--------|---------|---------|---------|
|--------|--------|--------|--------|--------|--------|--------|--------|---------|---------|---------|

IEC/EN 60947, VDE 0660, UL, CSA

|      |      |      |      |      |      |      |      |      |      |      |
|------|------|------|------|------|------|------|------|------|------|------|
| 10   | 10   | 10   | 10   | 10   | 10   | 10   | 10   | 10   | 10   | 10   |
| 10   | 10   | 10   | 10   | 10   | 10   | 10   | 10   | 10   | 10   | 10   |
| 5000 | 5000 | 5000 | 5000 | 5000 | 5000 | 3600 | 3600 | 3600 | 3600 | 3000 |
| 5000 | 5000 | 5000 | 5000 | 5000 | 5000 | 3600 | 3600 | 3600 | 3600 | 3000 |

→ Characteristic curves Page 74

Damp heat, constant, to IEC 60068-2-78

Damp heat, cyclic, to IEC 60068-2-30

|          |          |          |          |          |          |          |          |          |          |          |
|----------|----------|----------|----------|----------|----------|----------|----------|----------|----------|----------|
| -25...60 | -25...60 | -25...60 | -25...60 | -25...60 | -25...60 | -25...60 | -25...60 | -25...60 | -25...60 | -25...60 |
| -25...40 | -25...40 | -25...40 | -25...40 | -25...40 | -25...40 | -25...40 | -25...40 | -25...40 | -25...40 | -25...40 |
| -40 - 80 | -40 - 80 | -40 - 80 | -40 - 80 | -40 - 80 | -40 - 80 | -40 - 80 | -40 - 80 | -40 - 80 | -40 - 80 | -40 - 80 |

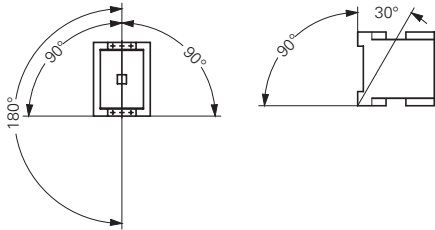

|    |    |    |    |    |    |    |    |    |    |    |
|----|----|----|----|----|----|----|----|----|----|----|
| 10 | 10 | 10 | 10 | 10 | 10 | 10 | 10 | 10 | 10 | 10 |
| 7  | 7  | 7  | 7  | 7  | 7  | 7  | 7  | 7  | 7  | 7  |
| 5  | 5  | 5  | 5  | 5  | 5  | 5  | 5  | 5  | 5  | 5  |

|      |      |      |      |      |      |      |      |      |      |      |
|------|------|------|------|------|------|------|------|------|------|------|
| 6.9  | 6.9  | 10   | 10   | 10   | 10   | 10   | 10   | 10   | 10   | 10   |
| 5.3  | 5.3  | 7    | 7    | 7    | 7    | 7    | 7    | 7    | 7    | 7    |
| 3.5  | 3.5  | 5    | 5    | 5    | 5    | 5    | 5    | 5    | 5    | 5    |
| IP00 | IP00 | IP00 | IP00 | IP00 | IP00 | IP00 | IP00 | IP00 | IP00 | IP00 |

Finger- and back-of-hand proof

|      |      |     |     |     |     |     |     |     |     |     |
|------|------|-----|-----|-----|-----|-----|-----|-----|-----|-----|
| 0.42 | 0.42 | 0.9 | 0.9 | 0.9 | 0.9 | 2   | 2   | 2   | 2   | 2   |
| 0.48 | 0.48 | 1.1 | 1.1 | 1.1 | 1.1 | 2.1 | 2.1 | 2.1 | 2.1 | 2.1 |

|                                    |        |                                    |        |        |        |                                |         |         |         |         |
|------------------------------------|--------|------------------------------------|--------|--------|--------|--------------------------------|---------|---------|---------|---------|
| 1 x (0.75 - 16)<br>2 x (0.75 - 10) |        | 1 x (0.75 - 16)<br>2 x (0.75 - 16) |        |        |        |                                |         |         |         |         |
| 1 x (0.75 - 16)<br>2 x (0.75 - 10) |        | 1 x (0.75 - 35)<br>2 x (0.75 - 25) |        |        |        | 1 x (10 - 95)<br>2 x (10 - 70) |         |         |         |         |
| 1 x 16                             | 1 x 16 | 1 x (16 - 50)<br>2 x (16 - 35)     |        |        |        | 1 x (16 - 95)<br>2 x (16 - 70) |         |         |         |         |
| 18 - 6                             | 18 - 6 | 12 - 2                             | 12 - 2 | 12 - 2 | 12 - 2 | 8...3/0                        | 8...3/0 | 8...3/0 | 8...3/0 | 8...3/0 |
| -                                  | -      | 2 x (6 x 9 x 0.8)                  |        |        |        | 2 x (6 x 16 x 0.8)             |         |         |         |         |

1 x (0.75 - 4)  
2 x (0.75 - 4)  
1 x (0.75 - 2.5)  
2 x (0.75 - 2.5)

|         |         |         |         |         |         |         |         |         |         |         |
|---------|---------|---------|---------|---------|---------|---------|---------|---------|---------|---------|
| 18 - 14 | 18 - 14 | 18 - 14 | 18 - 14 | 18 - 14 | 18 - 14 | 18 - 14 | 18 - 14 | 18 - 14 | 18 - 14 | 18 - 14 |
|---------|---------|---------|---------|---------|---------|---------|---------|---------|---------|---------|



## 1 DILM7 ... DILM170

|  |             |                 | DILM7                                | DILM9              | DILM12             | DILM15             | DILM17             | DILM25             |
|--|-------------|-----------------|--------------------------------------|--------------------|--------------------|--------------------|--------------------|--------------------|
| <b>General</b>                               |             |                 |                                      |                    |                    |                    |                    |                    |
| Main cable connection screw/bolt             |             |                 | M3.5                                 | M3.5               | M3.5               | M3.5               | M5                 | M5                 |
| Tightening torque                            | Nm          |                 | 1.2                                  | 1.2                | 1.2                | 1.2                | 3.2                | 3.2                |
| Control circuit cable connection screw/bolt  |             |                 | M3.5                                 | M3.5               | M3.5               | M3.5               | M3.5               | M3.5               |
| Tightening torque                            | Nm          |                 | 1.2                                  | 1.2                | 1.2                | 1.2                | 1.2                | 1.2                |
| <b>Tools</b>                                 |             |                 |                                      |                    |                    |                    |                    |                    |
| Main conductors                              |             |                 |                                      |                    |                    |                    |                    |                    |
| Pozidriv screwdriver                         |             | Size            | 2                                    | 2                  | 2                  | 2                  | 2                  | 2                  |
| Internal hexagon                             | SW          | mm              | –                                    | –                  | –                  | –                  | –                  | –                  |
| Flat-blade screwdriver                       |             | mm              | 0.8 x 5.5<br>1 x 6                   | 0.8 x 5.5<br>1 x 6 | 0.8 x 5.5<br>1 x 6 | 0.8 x 5.5<br>1 x 6 | 0.8 x 5.5<br>1 x 6 | 0.8 x 5.5<br>1 x 6 |
| Auxiliary conductors                         |             |                 |                                      |                    |                    |                    |                    |                    |
| Pozidriv screwdriver                         |             | Size            | 2                                    | 2                  | 2                  | 2                  | 2                  | 2                  |
| Flat-blade screwdriver                       |             | mm              | 0.8 x 5.5<br>1 x 6                   | 0.8 x 5.5<br>1 x 6 | 0.8 x 5.5<br>1 x 6 | 0.8 x 5.5<br>1 x 6 | 0.8 x 5.5<br>1 x 6 | 0.8 x 5.5<br>1 x 6 |
| Terminal type spring-cage terminal           |             |                 |                                      |                    |                    |                    |                    |                    |
| Terminal capacity of main cable              |             |                 |                                      |                    |                    |                    |                    |                    |
| Solid  |             | mm <sup>2</sup> | 1 x (0.75 - 2.5)<br>2 x (0.75 - 2.5) |                    |                    |                    | –                  | –                  |
| Flexible                                     |             | mm <sup>2</sup> | 1 x (0.75 - 2.5)<br>2 x (0.75 - 2.5) |                    |                    |                    | –                  | –                  |
| Flexible with ferrule                        |             | mm <sup>2</sup> | 1 x (0.75 - 1.5)<br>2 x (0.75 - 1.5) |                    |                    |                    | –                  | –                  |
| Flexible without ferrule                     |             | mm <sup>2</sup> | 1 x (0.75 - 2.5)<br>2 x (0.75 - 2.5) |                    |                    |                    | –                  | –                  |
| Solid or stranded                            |             | AWG             | 18 - 14                              | 18 - 14            | 18 - 14            | 18 - 14            | –                  | –                  |
| Terminal capacity of control circuit cable   |             |                 |                                      |                    |                    |                    |                    |                    |
| Solid  |             | mm <sup>2</sup> | 1 x (0.75 - 2.5)<br>2 x (0.75 - 2.5) |                    |                    |                    |                    |                    |
| Flexible                                     |             | mm <sup>2</sup> | 1 x (0.75 - 2.5)<br>2 x (0.75 - 2.5) |                    |                    |                    |                    |                    |
| Flexible with ferrule                        |             | mm <sup>2</sup> | 1 x (0.75 - 1.5)<br>2 x (0.75 - 1.5) |                    |                    |                    |                    |                    |
| Flexible without ferrule                     |             | mm <sup>2</sup> | 1 x (0.75 - 2.5)<br>2 x (0.75 - 2.5) |                    |                    |                    | –                  | –                  |
| Solid or stranded                            |             | AWG             | 18 - 14                              | 18 - 14            | 18 - 14            | 18 - 14            | 18 - 14            | 18 - 14            |
| <b>Tools</b>                                 |             |                 |                                      |                    |                    |                    |                    |                    |
| Strip length                                 |             | mm              | 10                                   | 10                 | 10                 | 10                 | 10                 | 10                 |
| Screwdriver blade width                      |             | mm              | 3.5                                  | 3.5                | 3.5                | 3.5                | 3.5                | 3.5                |
| <b>Main contacts</b>                         |             |                 |                                      |                    |                    |                    |                    |                    |
| Rated impulse withstand voltage              | $U_{imp}$   | V AC            | 8000                                 | 8000               | 8000               | 8000               | 8000               | 8000               |
| Overvoltage category/pollution degree        |             |                 | III/3                                | III/3              | III/3              | III/3              | III/3              | III/3              |
| Rated insulation voltage                     | $U_i$       | V AC            | 690                                  | 690                | 690                | 690                | 690                | 690                |
| Rated operating voltage                      | $U_e$       | V AC            | 690                                  | 690                | 690                | 690                | 690                | 690                |
| Safe isolation according to EN 61140         |             |                 |                                      |                    |                    |                    |                    |                    |
| Between coil and contacts                    |             | V AC            | 400                                  | 400                | 400                | 400                | 440                | 440                |
| Between the contacts                         |             | V AC            | 400                                  | 400                | 400                | 400                | 440                | 440                |
| Making capacity (cos $\Phi$ to IEC/EN 60947) | To 690 V    | A               | 112                                  | 112                | 144                | 155                | 238                | 350                |
| Breaking capacity                            |             |                 |                                      |                    |                    |                    |                    |                    |
| 230 V  |             | A               | 70                                   | 90                 | 120                | 124                | 170                | 250                |
| 280/400 V                                    |             | A               | 70                                   | 90                 | 120                | 124                | 170                | 250                |
| 500 V  |             | A               | 50                                   | 70                 | 100                | 100                | 170                | 250                |
| 660/690 V                                    |             | A               | 40                                   | 50                 | 70                 | 70                 | 120                | 150                |
| Short-circuit rating                         |             |                 |                                      |                    |                    |                    |                    |                    |
| Short-circuit protection rating maximum fuse |             |                 |                                      |                    |                    |                    |                    |                    |
| Type "2" coordination                        |             |                 |                                      |                    |                    |                    |                    |                    |
| 400 V  | gG/gL 500 V | A               | 20                                   | 20                 | 20                 | 20                 | 35                 | 35                 |
| 690 V  | gG/gL 690 V | A               | 16                                   | 16                 | 20                 | 20                 | 35                 | 35                 |
| Type "1" coordination                        |             |                 |                                      |                    |                    |                    |                    |                    |
| 400 V  | gG/gL 500 V | A               | 35                                   | 35                 | 35                 | 63                 | 63                 | 100                |
| 690 V  | gG/gL 690 V | A               | 20                                   | 20                 | 25                 | 50                 | 50                 | 50                 |

| DILM32                               | DILM38             | DILM40             | DILM50             | DILM65             | DILM72             | DILM80             | DILM95             | DILM115            | DILM150            | DILM170            |
|--------------------------------------|--------------------|--------------------|--------------------|--------------------|--------------------|--------------------|--------------------|--------------------|--------------------|--------------------|
| M5                                   | M5                 | M6                 | M6                 | M6                 | M6                 | M10                | M10                | M10                | M10                | M10                |
| 3.2                                  | 3.2                | 3.3                | 3.3                | 3.3                | 3.3                | 14                 | 14                 | 14                 | 14                 | 14                 |
| M3.5                                 | M3.5               | M3.5               | M3.5               | M3.5               | M3.5               | M3.5               | M3.5               | M3.5               | M3.5               | M3.5               |
| 1.2                                  | 1.2                | 1.2                | 1.2                | 1.2                | 1.2                | 1.2                | 1.2                | 1.2                | 1.2                | 1.2                |
| 2                                    | 2                  | 2                  | 2                  | 2                  | 2                  | –                  | –                  | –                  | –                  | –                  |
| –                                    | –                  | –                  | –                  | –                  | –                  | 5                  | 5                  | 5                  | 5                  | 5                  |
| 0.8 x 5.5<br>1 x 6                   | 0.8 x 5.5<br>1 x 6 | 0.8 x 5.5<br>1 x 6 | 0.8 x 5.5<br>1 x 6 | 0.8 x 5.5<br>1 x 6 | 0.8 x 5.5<br>1 x 6 | –                  | –                  | –                  | –                  | –                  |
| 2                                    | 2                  | 2                  | 2                  | 2                  | 2                  | 2                  | 2                  | 2                  | 2                  | 2                  |
| 0.8 x 5.5<br>1 x 6                   | 0.8 x 5.5<br>1 x 6 | 0.8 x 5.5<br>1 x 6 | 0.8 x 5.5<br>1 x 6 | 0.8 x 5.5<br>1 x 6 | 0.8 x 5.5<br>1 x 6 | 0.8 x 5.5<br>1 x 6 | 0.8 x 5.5<br>1 x 6 | 0.8 x 5.5<br>1 x 6 | 0.8 x 5.5<br>1 x 6 | 0.8 x 5.5<br>1 x 6 |
| –                                    | –                  | –                  | –                  | –                  | –                  | –                  | –                  | –                  | –                  | –                  |
| –                                    | –                  | –                  | –                  | –                  | –                  | –                  | –                  | –                  | –                  | –                  |
| –                                    | –                  | –                  | –                  | –                  | –                  | –                  | –                  | –                  | –                  | –                  |
| –                                    | –                  | –                  | –                  | –                  | –                  | –                  | –                  | –                  | –                  | –                  |
| –                                    | –                  | –                  | –                  | –                  | –                  | –                  | –                  | –                  | –                  | –                  |
| 1 x (0.75 - 2.5)<br>2 x (0.75 - 2.5) |                    |                    |                    |                    |                    |                    |                    |                    |                    |                    |
| 1 x (0.75 - 2.5)<br>2 x (0.75 - 2.5) |                    |                    |                    |                    |                    |                    |                    |                    |                    |                    |
| 1 x (0.75 - 1.5)<br>2 x (0.75 - 1.5) |                    |                    |                    |                    |                    |                    |                    |                    |                    |                    |
| –                                    | –                  | –                  | –                  | –                  | –                  | –                  | –                  | –                  | –                  | –                  |
| 18 - 14                              | 18 - 14            | 18 - 14            | 18 - 14            | 18 - 14            | 18 - 14            | 18 - 14            | 18 - 14            | 18 - 14            | 18 - 14            | 18 - 14            |
| 10                                   | 10                 | 10                 | 10                 | 10                 | 10                 | 10                 | 10                 | 10                 | 10                 | 10                 |
| 3.5                                  | 3.5                | 3.5                | 3.5                | 3.5                | 3.5                | 3.5                | 3.5                | 3.5                | 3.5                | 3.5                |
| 8000                                 | 8000               | 8000               | 8000               | 8000               | 8000               | 8000               | 8000               | 8000               | 8000               | 8000               |
| III/3                                | III/3              | III/3              | III/3              | III/3              | III/3              | III/3              | III/3              | III/3              | III/3              | III/3              |
| 690                                  | 690                | 690                | 690                | 690                | 690                | 690                | 690                | 690                | 690                | 690                |
| 690                                  | 690                | 690                | 690                | 690                | 690                | 690                | 690                | 690                | 690                | 690                |
| 440                                  | 440                | 440                | 440                | 440                | 440                | 690                | 690                | 690                | 690                | 690                |
| 440                                  | 440                | 440                | 440                | 440                | 440                | 690                | 690                | 690                | 690                | 690                |
| 384                                  | 384                | 560                | 700                | 910                | 910                | 1120               | 1330               | 1610               | 2100               | 2100               |
| 320                                  | 320                | 400                | 500                | 650                | 650                | 800                | 950                | 1150               | 1500               | 1500               |
| 320                                  | 320                | 400                | 500                | 650                | 650                | 800                | 950                | 1150               | 1500               | 1500               |
| 320                                  | 320                | 400                | 500                | 650                | 650                | 800                | 950                | 1150               | 1500               | 1500               |
| 180                                  | 180                | 250                | 320                | 370                | 370                | 650                | 800                | 1100               | 1200               | 1320               |
| 63                                   | 63                 | 63                 | 80                 | 125                | 125                | 160                | 160                | 250                | 250                | 250                |
| 35                                   | 35                 | 50                 | 63                 | 80                 | 80                 | 160                | 160                | 250                | 250                | 250                |
| 125                                  | 125                | 125                | 160                | 250                | 250                | 250                | 250                | 250                | 250                | 250                |
| 63                                   | 63                 | 80                 | 80                 | 100                | 100                | 200                | 200                | 250                | 250                | 250                |

# 1.1

## Contactors

Basic devices up to 170 A

### 1 DILM7 ... DILM170

|  |           |          |          | DILM7 | DILM9 | DILM12 | DILM15 | DILM17 | DILM25 |     |
|--|-----------|----------|----------|-------|-------|--------|--------|--------|--------|-----|
| <b>AC voltage</b>  |           |          |          |       |       |        |        |        |        |     |
| AC-1 operation   |           |          |          |       |       |        |        |        |        |     |
| Conventional free air thermal current 3 pole 50 - 60 Hz  | Open      | at 50 °C | $I_{th}$ | A     | 22    | 22     | 22     | 22     | 40     | 45  |
|  |           | at 50 °C | $I_{th}$ | A     | 21    | 21     | 21     | 21     | 38     | 43  |
|  |           | at 55 °C | $I_{th}$ | A     | 21    | 21     | 21     | 21     | 37     | 42  |
|  |           | at 60 °C | $I_{th}$ | A     | 20    | 20     | 20     | 20     | 35     | 40  |
|  | Enclosed  |          | $I_{th}$ | A     | 18    | 18     | 18     | 18     | 32     | 36  |
| Conventional free air thermal current 1 pole             | Open      |          | $I_{th}$ | A     | 50    | 50     | 50     | 50     | 88     | 100 |
|  | Enclosed  |          | $I_{th}$ | A     | 45    | 45     | 45     | 45     | 80     | 90  |
| AC-3 operation   |           |          |          |       |       |        |        |        |        |     |
| Rated operational current AC -3 open, 50 - 60 Hz, 3 pole | 220/230 V |          | $I_e$    | A     | 7     | 9      | 12     | 15.5   | 18     | 25  |
|  | 240 V     |          | $I_e$    | A     | 7     | 9      | 12     | 15.5   | 18     | 25  |
|  | 380/400 V |          | $I_e$    | A     | 7     | 9      | 12     | 15.5   | 18     | 25  |
|  | 415 V     |          | $I_e$    | A     | 7     | 9      | 12     | 15.5   | 18     | 25  |
|  | 440 V     |          | $I_e$    | A     | 7     | 9      | 12     | 15.5   | 18     | 25  |
|  | 500 V     |          | $I_e$    | A     | 5     | 7      | 10     | 12.5   | 18     | 25  |
|  | 660/690 V |          | $I_e$    | A     | 4     | 5      | 7      | 9      | 12     | 15  |
| Rated operational power                                  | 220/230 V | P        | kW       | 2.2   | 2.5   | 3.5    | 4      | 5      | 7.5    |     |
|  | 240 V     | P        | kW       | 2.2   | 3     | 4      | 4.6    | 5.5    | 8.5    |     |
|  | 380/400 V | P        | kW       | 3     | 4     | 5.5    | 7.5    | 7.5    | 11     |     |
|  | 415 V     | P        | kW       | 4     | 5.5   | 7      | 8      | 10     | 14.5   |     |
|  | 440 V     | P        | kW       | 4.5   | 5.5   | 7.5    | 8.4    | 10.5   | 15.5   |     |
|  | 500 V     | P        | kW       | 3.5   | 4.5   | 7      | 7.5    | 12     | 17.5   |     |
|  | 660/690 V | P        | kW       | 3.5   | 4.5   | 6.5    | 7      | 11     | 14     |     |
| AC-4 operation   |           |          |          |       |       |        |        |        |        |     |
| Rated operational current AC-4 open, 50 - 60 Hz, 3 pole  | 220/230 V |          | $I_e$    | A     | 5     | 6      | 7      | 7      | 10     | 13  |
|  | 240 V     |          | $I_e$    | A     | 5     | 6      | 7      | 7      | 10     | 13  |
|  | 380/400 V |          | $I_e$    | A     | 5     | 6      | 7      | 7      | 10     | 13  |
|  | 415 V     |          | $I_e$    | A     | 5     | 6      | 7      | 7      | 10     | 13  |
|  | 440 V     |          | $I_e$    | A     | 5     | 6      | 7      | 7      | 10     | 13  |
|  | 500 V     |          | $I_e$    | A     | 4.5   | 5      | 6      | 6      | 10     | 13  |
|  | 660/690 V |          | $I_e$    | A     | 4     | 4.5    | 5      | 5      | 8      | 10  |
| Rated operational power                                  | 220/230 V | P        | kW       | 1     | 1.5   | 2      | 2      | 2.5    | 3.5    |     |
|  | 240 V     | P        | kW       | 1.5   | 1.6   | 2.2    | 2.2    | 3      | 4      |     |
|  | 380/400 V | P        | kW       | 2.2   | 2.5   | 3      | 3      | 4.5    | 6      |     |
|  | 415 V     | P        | kW       | 2.3   | 2.8   | 3.4    | 3.4    | 5      | 6.5    |     |
|  | 440 V     | P        | kW       | 2.4   | 3     | 3.6    | 3.6    | 5.5    | 7      |     |
|  | 500 V     | P        | kW       | 2.5   | 2.8   | 3.5    | 3.5    | 6      | 8      |     |
|  | 660/690 V | P        | kW       | 2.9   | 3.6   | 4.4    | 4.4    | 6.5    | 8.5    |     |
| <b>DC voltage</b>  |           |          |          |       |       |        |        |        |        |     |
| Operations → Switching of DC current Page 92             |           |          |          |       |       |        |        |        |        |     |
| Rated operational current $I_e$ open                     |           |          |          |       |       |        |        |        |        |     |
| DC-1 operation   | 60 V      |          | $I_e$    | A     | 20    | 20     | 20     | 20     | 35     | 40  |
|  | 110 V     |          | $I_e$    | A     | 20    | 20     | 20     | 20     | 35     | 40  |
|  | 220 V     |          | $I_e$    | A     | 15    | 15     | 15     | 15     | 35     | 40  |
|  | 440 V     |          | $I_e$    | A     | 1     | 1.3    | 1.3    | 1.3    | 2.9    | 2.9 |
| DC-3 operation   | 660 V     |          | $I_e$    | A     | 20    | 20     | 20     | 20     | 35     | 35  |
|  | 110 V     |          | $I_e$    | A     | 20    | 20     | 20     | 20     | 35     | 35  |
|  | 220 V     |          | $I_e$    | A     | 1.5   | 1.5    | 1.5    | 1.5    | 10     | 10  |
|  | 440 V     |          | $I_e$    | A     | 0.2   | 0.2    | 0.2    | 0.2    | 0.6    | 0.6 |
| DC-5 operation   | 60 V      |          | $I_e$    | A     | 20    | 20     | 20     | 20     | 35     | 35  |
|  | 110 V     |          | $I_e$    | A     | 20    | 20     | 20     | 20     | 35     | 35  |
|  | 220 V     |          | $I_e$    | A     | 1.5   | 1.5    | 1.5    | 1.5    | 10     | 10  |
|  | 440 V     |          | $I_e$    | A     | 0.2   | 0.2    | 0.2    | 0.2    | 0.6    | 0.6 |

| DILM32 | DILM38 | DILM40 | DILM50 | DILM65 | DILM72 | DILM80 | DILM95 | DILM115 | DILM150 | DILM170 |
|--------|--------|--------|--------|--------|--------|--------|--------|---------|---------|---------|
| 45     | 45     | 60     | 80     | 98     | 98     | 110    | 130    | 160     | 190     | 225     |
| 43     | 43     | 57     | 71     | 88     | 88     | 98     | 125    | 142     | 180     | 200     |
| 42     | 42     | 55     | 68     | 83     | 83     | 94     | 115    | 135     | 170     | 190     |
| 40     | 40     | 50     | 65     | 80     | 80     | 90     | 110    | 130     | 160     | 185     |
| 36     | 36     | 45     | 58     | 72     | 72     | 80     | 100    | 115     | 144     | 166     |
| 100    | 100    | 125    | 162    | 200    | 200    | 225    | 275    | 325     | 400     | 460     |
| 90     | 90     | 112    | 145    | 180    | 180    | 200    | 250    | 285     | 360     | 415     |
| 32     | 38     | 40     | 50     | 65     | 72     | 80     | 95     | 115     | 150     | 170     |
| 32     | 38     | 40     | 50     | 65     | 72     | 80     | 95     | 115     | 150     | 170     |
| 32     | 38     | 40     | 50     | 65     | 72     | 80     | 95     | 115     | 150     | 170     |
| 32     | 38     | 40     | 50     | 65     | 72     | 80     | 95     | 115     | 150     | 170     |
| 32     | 38     | 40     | 50     | 65     | 72     | 80     | 95     | 115     | 150     | 170     |
| 32     | 38     | 40     | 50     | 65     | 72     | 80     | 95     | 115     | 150     | 170     |
| 18     | 22.5   | 25     | 32     | 37     | 37     | 65     | 80     | 93      | 100     | 150     |
| 10     | 11     | 12.5   | 15.5   | 20     | 22     | 25     | 30     | 37      | 48      | 52      |
| 11     | 12     | 13.5   | 17     | 22     | 25     | 27.5   | 32     | 40      | 52      | 57      |
| 15     | 18.5   | 18.5   | 22     | 30     | 37     | 37     | 45     | 55      | 75      | 90      |
| 19     | 20     | 24     | 30     | 39     | 41     | 48     | 57     | 70      | 91      | 100     |
| 20     | 21     | 25     | 32     | 41     | 44     | 51     | 60     | 75      | 95      | 105     |
| 23     | 24     | 28     | 36     | 47     | 50     | 58     | 70     | 85      | 110     | 120     |
| 17     | 21     | 23     | 30     | 35     | 35     | 63     | 75     | 90      | 96      | 140     |
| 15     | 15     | 18     | 21     | 25     | 25     | 40     | 50     | 55      | 65      | 65      |
| 15     | 15     | 18     | 21     | 25     | 25     | 40     | 50     | 55      | 65      | 65      |
| 15     | 15     | 18     | 21     | 25     | 25     | 40     | 50     | 55      | 65      | 65      |
| 15     | 15     | 18     | 21     | 25     | 25     | 40     | 50     | 55      | 65      | 65      |
| 15     | 15     | 18     | 21     | 25     | 25     | 40     | 50     | 55      | 65      | 65      |
| 12     | 12     | 14     | 17     | 20     | 20     | 27     | 37     | 45      | 50      | 50      |
| 4      | 4      | 5      | 6      | 7      | 7      | 12     | 16     | 17      | 20      | 20      |
| 4.5    | 4.5    | 5.5    | 6.5    | 7.5    | 7.5    | 13     | 17     | 19      | 22      | 22      |
| 7      | 7      | 9      | 10     | 12     | 12     | 20     | 26     | 28      | 33      | 33      |
| 7.5    | 7.5    | 9.5    | 11     | 13     | 13     | 24     | 30     | 33      | 39      | 39      |
| 8      | 8      | 10     | 12     | 14     | 14     | 25     | 32     | 35      | 41      | 41      |
| 9      | 9      | 11     | 13     | 16     | 16     | 29     | 36     | 40      | 47      | 47      |
| 10     | 10     | 12     | 14     | 17     | 17     | 26     | 35     | 43      | 48      | 48      |
| 40     | 40     | 50     | 60     | 72     | 72     | 110    | 110    | 160     | 160     | 160     |
| 40     | 40     | 50     | 50     | 72     | 72     | 110    | 110    | 160     | 160     | 160     |
| 40     | 40     | 45     | 45     | 65     | 65     | 70     | 70     | 90      | 90      | 90      |
| 2.9    | 2.9    | 2.9    | 2.9    | 2.9    | 2.9    | 4.5    | 4.5    | 4.5     | 4.5     | 4.5     |
| 40     | 40     | 50     | 60     | 72     | 72     | 110    | 110    | 160     | 160     | 160     |
| 40     | 40     | 50     | 50     | 72     | 72     | 110    | 110    | 160     | 160     | 160     |
| 25     | 25     | 25     | 25     | 35     | 35     | 35     | 35     | 40      | 40      | 40      |
| 0.6    | 0.6    | 0.6    | 0.6    | 0.6    | 0.6    | 1      | 1      | 1       | 1       | 1       |
| 40     | 40     | 50     | 60     | 72     | 72     | 110    | 110    | 160     | 160     | 160     |
| 40     | 40     | 50     | 50     | 72     | 72     | 110    | 110    | 160     | 160     | 160     |
| 10     | 10     | 25     | 25     | 35     | 35     | 35     | 35     | 40      | 40      | 40      |
| 0.6    | 0.6    | 0.6    | 0.6    | 0.6    | 0.6    | 1      | 1      | 1       | 1       | 1       |

## 1 DILM7 ... DILM170

|   |               |          | DILM7  | DILM9                   | DILM12                  | DILM15                  | DILM17                  | DILM25                  |
|---|---------------|----------|--|-------------------------|-------------------------|-------------------------|-------------------------|-------------------------|
| <b>Current heat loss (3 pole)</b>   |               |          |  |                         |                         |                         |                         |                         |
| Current heat loss at $I_{th}$   | W             |          | 3  | 3                       | 3                       | 3                       | 7.3                     | 9.6                     |
| Current heat loss at $I_e$ to AC-3/400 V  | W             |          | 0.37   | 0.6                     | 1.1                     | 1.8                     | 1.9                     | 3.8                     |
| Impedance per pole  | mΩ            |          | 2.5  | 2.5                     | 2.5                     | 2.5                     | 2                       | 2                       |
| <b>Magnet systems</b>   |               |          |  |                         |                         |                         |                         |                         |
| Voltage tolerance   |               |          |  |                         |                         |                         |                         |                         |
| AC operated   | Pick-up       | x $U_c$  | 0.8 - 1.1  | 0.8 - 1.1               | 0.8 - 1.1               | 0.8 - 1.1               | 0.8 - 1.1               | 0.8 - 1.1               |
| AC operated   | Drop-out      | x $U_c$  | 0.3 - 0.6  | 0.3 - 0.6               | 0.3 - 0.6               | 0.3 - 0.6               | 0.3 - 0.6               | 0.3 - 0.6               |
| DC operated <sup>3)</sup>   | Pick-up       | x $U_c$  | 0.8 - 1.1  | 0.8 - 1.1 <sup>1)</sup> | 0.8 - 1.1 <sup>1)</sup> | 0.8 - 1.1 <sup>1)</sup> | 0.7 - 1.2 <sup>2)</sup> | 0.7 - 1.2 <sup>2)</sup> |
| DC operated <sup>3)</sup>   | Drop-out      | x $U_c$  | 0.15 - 0.6   | 0.15 - 0.6              | 0.15 - 0.6              | 0.15 - 0.6              | 0.15 - 0.6              | 0.15 - 0.6              |
| Power consumption of the coil in a cold state and 1.0 x $U_c$                                     |               |          |  |                         |                         |                         |                         |                         |
| 50 Hz   | Pick-up       | VA       | 24   | 24                      | 24                      | 24                      | 52                      | 52                      |
| 50 Hz   | Sealing       | VA       | 3.4  | 3.4                     | 3.4                     | 3.4                     | 7.1                     | 7.1                     |
| 50 Hz   | Sealing       | W        | 1.2  | 1.2                     | 1.2                     | 1.2                     | 2.1                     | 2.1                     |
| 60 Hz   | Pick-up       | VA       | 30   | 30                      | 30                      | 30                      | 67                      | 67                      |
| 60 Hz   | Sealing       | VA       | 4.4  | 4.4                     | 4.4                     | 4.4                     | 8.7                     | 8.7                     |
| 60 Hz   | Sealing       | W        | 1.4  | 1.4                     | 1.4                     | 1.4                     | 2.6                     | 2.6                     |
| 50/60 Hz  | Pick-up       | VA       | 27   | 27                      | 27                      | 27                      | 62                      | 62                      |
|   |               |          | 25   | 25                      | 25                      | 25                      | 58                      | 58                      |
| 50/60 Hz  | Sealing       | VA       | 4.2  | 4.2                     | 4.2                     | 4.2                     | 9.1                     | 9.1                     |
|   |               |          | 3.3  | 3.3                     | 3.3                     | 3.3                     | 6.5                     | 6.5                     |
| 50/60 Hz  | Sealing       | W        | 1.4  | 1.4                     | 1.4                     | 1.4                     | 2.5                     | 2.5                     |
|   |               |          | 1.2  | 1.2                     | 1.2                     | 1.2                     | 2                       | 2                       |
| DC operated   | Pick-up       | W        | 3  | 3                       | 4.5                     | 4.5                     | 12                      | 12                      |
| DC operated   | Sealing       | W        | 3  | 3                       | 4.5                     | 4.5                     | 0.5                     | 0.5                     |
| Duty factor   | % DF          |          | 100  | 100                     | 100                     | 100                     | 100                     | 100                     |
| Changeover times at 100 % $U_c$ (recommended values)  |               |          |  |                         |                         |                         |                         |                         |
| Main contacts   |               |          |  |                         |                         |                         |                         |                         |
| AC operated   | Closing delay | ms       | 15...21  | 15...21                 | 15...21                 | 15...21                 | 16...22                 | 16...22                 |
|   | Opening delay | ms       | 9...18   | 9...18                  | 9...18                  | 9...18                  | 8...14                  | 8...14                  |
| DC operated   | Closing delay | ms       | 31   | 31                      | 31                      | 31                      | 47                      | 47                      |
|   | Opening delay | ms       | 12   | 12                      | 12                      | 12                      | 30                      | 30                      |
| Arcing time   |               | ms       | 10   | 10                      | 10                      | 10                      | 10                      | 10                      |
| Permissible residual current when A1 - A2 are actuated from the electronic system (with 0 signal) |               | mA       | –  | –                       | –                       | –                       | –                       | –                       |
| Lifespan, mechanical; Coil 50/60 Hz   |               | At 50 Hz | Mechanical lifespan at 50 Hz approx. 30% lower than under → Technical data general |                         |                         |                         |                         |                         |
| <b>Electromagnetic compatibility (EMC)</b>  |               |          |  |                         |                         |                         |                         |                         |
| Emitted interference  |               |          | To EN 60947-1  |                         |                         |                         |                         |                         |
| Interference immunity   |               |          | To EN 60947-1  |                         |                         |                         |                         |                         |

**Notes**

<sup>1)</sup> At 24 V DC: 0.7 – 1.3 without auxiliary contact module and at ambient temperature + 40 °C

<sup>2)</sup> RDC 24 (Umin 24 V DC/Umax 27 V DC)  
RDC 60 (Umin 48 V DC/Umax 60 V DC)  
RDC 130 (Umin 110 V DC/Umax 130 V DC)  
RDC 240 (Umin 200 V DC/Umax 240 V DC)

Example:  $U_c = 0.7 \times U_{min} - 1.2 \times U_{max} / U_c = 0.7 \times 24 \text{ V} - 1.2 \times 27 \text{ V DC}$

<sup>3)</sup> At least: smoothed two-phase bridge rectifier or three-phase rectifier

| DILM32                  | DILM38                  | DILM40                  | DILM50                  | DILM65                  | DILM72                  | DILM80                  | DILM95                  | DILM115                 | DILM150                 | DILM170                 |
|-------------------------|-------------------------|-------------------------|-------------------------|-------------------------|-------------------------|-------------------------|-------------------------|-------------------------|-------------------------|-------------------------|
| 12.1                    | 12.1                    | 11.3                    | 19                      | 28.8                    | 28.8                    | 12.2                    | 18.2                    | 20.3                    | 30.7                    | 41.1                    |
| 6.1                     | 6.1                     | 7.2                     | 11.3                    | 19                      | 23                      | 9.6                     | 13.5                    | 15.9                    | 27                      | 34.7                    |
| 2                       | 2                       | 1.5                     | 1.5                     | 1.5                     | 1.5                     | 0.5                     | 0.5                     | 0.4                     | 0.4                     | 0.4                     |
| 0.8 - 1.1               | 0.8 - 1.1               | 0.8 - 1.1               | 0.8 - 1.1               | 0.8 - 1.1               | 0.8 - 1.1               | 0.8 - 1.1               | 0.8 - 1.1               | 0.8 - 1.15              | 0.8 - 1.15              | 0.8 - 1.15              |
| 0.3 - 0.6               | 0.3 - 0.6               | 0.3 - 0.6               | 0.3 - 0.6               | 0.3 - 0.6               | 0.3 - 0.6               | 0.3 - 0.6               | 0.3 - 0.6               | 0.25 - 0.6              | 0.25 - 0.6              | 0.25 - 0.6              |
| 0.7 - 1.2 <sup>2)</sup> | 0.7 - 1.2 <sup>2)</sup> | 0.7 - 1.2 <sup>2)</sup> | 0.7 - 1.2 <sup>2)</sup> | 0.7 - 1.2 <sup>2)</sup> | 0.7 - 1.2 <sup>2)</sup> | 0.7 - 1.2 <sup>2)</sup> | 0.7 - 1.2 <sup>2)</sup> | 0.7 - 1.2 <sup>2)</sup> | 0.7 - 1.2 <sup>2)</sup> | 0.7 - 1.2 <sup>2)</sup> |
| 0.15 - 0.6              | 0.15 - 0.6              | 0.15 - 0.6              | 0.15 - 0.6              | 0.15 - 0.6              | 0.15 - 0.6              | 0.15 - 0.6              | 0.15 - 0.6              | 0.15 - 0.6              | 0.15 - 0.6              | 0.15 - 0.6              |
| 52                      | 52                      | 149                     | 149                     | 149                     | 149                     | 310                     | 310                     | 180                     | 180                     | 180                     |
| 7.1                     | 7.1                     | 16                      | 16                      | 16                      | 16                      | 26                      | 26                      | 3.1                     | 3.1                     | 3.1                     |
| 2.1                     | 2.1                     | 4.3                     | 4.3                     | 4.3                     | 4.3                     | 5.8                     | 5.8                     | 2.1                     | 2.1                     | 2.1                     |
| 67                      | 67                      | 178                     | 178                     | 178                     | 178                     | 345                     | 345                     | 170                     | 170                     | 170                     |
| 8.7                     | 8.7                     | 19                      | 19                      | 19                      | 19                      | 30                      | 30                      | 3.1                     | 3.1                     | 3.1                     |
| 2.6                     | 2.6                     | 5.3                     | 5.3                     | 5.3                     | 5.3                     | 7.1                     | 7.1                     | 2.1                     | 2.1                     | 2.1                     |
| 62                      | 62                      | 168                     | 168                     | 168                     | 168                     | 372                     | 372                     | 170                     | 170                     | 170                     |
| 58                      | 58                      | 154                     | 154                     | 154                     | 154                     | 328                     | 328                     | 170                     | 170                     | 170                     |
| 9.1                     | 9.1                     | 22                      | 22                      | 22                      | 22                      | 37.1                    | 37.1                    | 3.1                     | 3.1                     | 3.1                     |
| 6.5                     | 6.5                     | 14                      | 14                      | 14                      | 14                      | 22.6                    | 22.6                    | 3.1                     | 3.1                     | 3.1                     |
| 2.5                     | 2.5                     | 5.3                     | 5.3                     | 5.3                     | 5.3                     | 7.5                     | 7.5                     | 2.1                     | 2.1                     | 2.1                     |
| 2                       | 2                       | 4.3                     | 4.3                     | 4.3                     | 4.3                     | 6.1                     | 6.1                     | 2.1                     | 2.1                     | 2.1                     |
| 12                      | 12                      | 24                      | 24                      | 24                      | 24                      | 90                      | 90                      | 149                     | 149                     | 149                     |
| 0.5                     | 0.5                     | 0.5                     | 0.5                     | 0.5                     | 0.5                     | 1.3                     | 1.3                     | 2.1                     | 2.1                     | 2.1                     |
| 100                     | 100                     | 100                     | 100                     | 100                     | 100                     | 100                     | 100                     | 100                     | 100                     | 100                     |
| 16...22                 | 16...22                 | 12...18                 | 12...18                 | 12...18                 | 12...18                 | 14...20                 | 14...20                 | 28...33                 | 28...33                 | 28...33                 |
| 8...14                  | 8...14                  | 8...13                  | 8...13                  | 8...13                  | 8...13                  | 9...14                  | 9...14                  | 35...41                 | 35...41                 | 35...41                 |
| 47                      | 47                      | 54                      | 54                      | 54                      | 54                      | 45                      | 45                      | 35                      | 35                      | 35                      |
| 30                      | 30                      | 24                      | 24                      | 24                      | 24                      | 34                      | 34                      | 30                      | 30                      | 30                      |
| 10                      | 10                      | 10                      | 10                      | 10                      | 10                      | 15                      | 15                      | 15                      | 15                      | 15                      |
| -                       | -                       | -                       | -                       | -                       | -                       | ≤1                      | ≤1                      | ≤1                      | ≤1                      | ≤1                      |

Mechanical lifespan at 50 Hz approx. 30% lower than under → Technical data general

To EN 60947-1

To EN 60947-1

# 1.1

## Contactors

Comfort devices and standard devices greater than 170 A

### 1 DILM185...DILM1600, DILH

#### Contactors

DILM185A DILM225A DILM250 DILM300A DILM400 DILM500 DILM570

| General   |              |                   | DILM185A   | DILM225A      | DILM250       | DILM300A      | DILM400       | DILM500       | DILM570       |
|---|--------------|-------------------|--|---------------|---------------|---------------|---------------|---------------|---------------|
| Standards   |              |                   | IEC/EN 60947, VDE 0660, UL, CSA  |               |               |               |               |               |               |
| Lifespan, mechanical  |              |                   |  |               |               |               |               |               |               |
| AC operated   | c (contacts) | x 10 <sup>6</sup> | 10   | 10            | 10            | 10            | 7             | 7             | 7             |
| DC operated   | c (contacts) | x 10 <sup>6</sup> | 10   | 10            | 10            | 10            | 7             | 7             | 7             |
| Operating frequency, mechanical                                       |              |                   |  |               |               |               |               |               |               |
| AC operated   | Operations/h |                   | 3000   | 3000          | 3000          | 3000          | 2000          | 2000          | 2000          |
| DC operated   | Operations/h |                   | 3000   | 3000          | 3000          | 3000          | 2000          | 2000          | 2000          |
| Maximum operating frequency   |              |                   | → Engineering Page 91  |               |               |               |               |               |               |
| Electrical (Contactor without overload relay)                         |              |                   | → Engineering Page 91  |               |               |               |               |               |               |
| Climatic proofing   |              |                   | Damp heat, constant, to IEC 60068-2-78<br>Damp heat, cyclic, to IEC 60068-2-30 |               |               |               |               |               |               |
| Ambient temperature   |              |                   |  |               |               |               |               |               |               |
| Open  |              | °C                | -25...60   | -25...60      | -25...60      | -25...60      | -25...60      | -25...60      | -25...60      |
| Enclosed  |              | °C                | -25...40   | -25...40      | -25...40      | -25...40      | -25...40      | -25...40      | -25...40      |
| Storage   |              | °C                | -40 - 80   | -40 - 80      | -40 - 80      | -40 - 80      | -40 - 80      | -40 - 80      | -40 - 80      |
| Mounting position: AC and DC-actuated                                 |              |                   |  |               |               |               |               |               |               |
| Mechanical shock resistance (IEC/EN 60068-2-27)                       |              |                   |  |               |               |               |               |               |               |
| Half-sinusoidal shock 10 ms   |              |                   |  |               |               |               |               |               |               |
| Main contacts   |              |                   |  |               |               |               |               |               |               |
| N/O   |              | g                 | 10   | 10            | 10            | 10            | 10            | 10            | 10            |
| Auxiliary contacts  |              |                   |  |               |               |               |               |               |               |
| N/O   |              | g                 | 10   | 10            | 10            | 10            | 10            | 10            | 10            |
| NC  |              | g                 | 8  | 8             | 8             | 8             | 8             | 8             | 8             |
| Protection type   |              |                   | IP00 IP00 IP00 IP00 IP00 IP00 IP00   |               |               |               |               |               |               |
| Protection against direct contact when actuated from front (EN 90274) |              |                   | Finger- and back-of-hand proof with cover or terminal block                    |               |               |               |               |               |               |
| Weight  |              |                   |  |               |               |               |               |               |               |
| Weight  |              | kg                | 3.2  | 3.2           | 6.5           | 6.5           | 8             | 8             | 8             |
| Terminal capacity of main cable                                       |              |                   |  |               |               |               |               |               |               |
| Flexible with cable lug   |              | mm <sup>2</sup>   | 50 - 185   | 50 - 185      | 50 - 240      | 50 - 240      | 50 - 240      | 50 - 240      | 50 - 240      |
| Stranded with cable lug   |              | mm <sup>2</sup>   | 50 - 185   | 70 - 185      | 70 - 240      | 70 - 240      | 70 - 240      | 70 - 240      | 70 - 240      |
| Solid or stranded   |              | AWG               | 1/0 - 350  | 2/0 - 250     | 2/0 - 500     | 2/0 - 500     | 2/0 - 500     | 2/0 - 500     | 2/0 - 500     |
|   |              | MCM               |  | MCM           | MCM           | MCM           | MCM           | MCM           | MCM           |
| Busbar  | Width        | mm                | 32   | 32            | 25            | 25            | 25            | 30            | 30            |
| Main cable connection screw/bolt                                      |              |                   | M10 M10 M10 M10 M10 M10 M10  |               |               |               |               |               |               |
| Tightening torque   |              |                   | Nm 24 24 24 24 24 24 24  |               |               |               |               |               |               |
| Terminal capacity of control circuit cable                            |              |                   |  |               |               |               |               |               |               |
| Solid   |              | mm <sup>2</sup>   | 1 x (0.75 - 2.5)<br>2 x (0.75 - 2.5)   |               |               |               |               |               |               |
| Flexible with ferrule   |              | mm <sup>2</sup>   | 1 x (0.75 - 2.5)<br>2 x (0.75 - 2.5)   |               |               |               |               |               |               |
| Solid or stranded   |              | AWG               | 2 x (18 - 12)  | 2 x (18 - 12) | 2 x (18 - 12) | 2 x (18 - 12) | 2 x (18 - 12) | 2 x (18 - 12) | 2 x (18 - 12) |
| Control circuit cable connection screw/bolt                           |              |                   | M3.5 M3.5 M3.5 M3.5 M3.5 M3.5 M3.5   |               |               |               |               |               |               |
| Tightening torque   |              |                   | Nm 1.2 1.2 1.2 1.2 1.2 1.2 1.2   |               |               |               |               |               |               |
| Tools   |              |                   |  |               |               |               |               |               |               |
| Main conductors   |              |                   |  |               |               |               |               |               |               |
| Wrench  |              | mm                | 16   | 16            | 16            | 16            | 16            | 16            | 16            |
| Auxiliary conductors  |              |                   |  |               |               |               |               |               |               |
| Pozidriv screwdriver  |              | Size              | 2  | 2             | 2             | 2             | 2             | 2             | 2             |

| DILM580   | DILM650       | DILM750       | DILM820       | DILM1000      | DILM1600      | DILH1400      | DILH2000      | DILH2200      | DILH2600      |
|---|---------------|---------------|---------------|---------------|---------------|---------------|---------------|---------------|---------------|
| IEC/EN 60947, VDE 0660, UL, CSA                             |               |               |               |               |               |               |               |               |               |
| 5   | 5             | 5             | 5             | 5             | 5             | 5             | 5             | 5             | 5             |
| 5   | 5             | 5             | 5             | 5             | 5             | 5             | 5             | 5             | 5             |
| 1000  | 1000          | 1000          | 1000          | 1000          | 1000          | 1000          | 1000          | 1000          | 1000          |
| 1000  | 1000          | 1000          | 1000          | 1000          | 1000          | 1000          | 1000          | 1000          | 1000          |
| → Engineering Page 91                                       |               |               |               |               |               |               |               |               |               |
| Damp heat, constant, to IEC 60068-2-78                      |               |               |               |               |               |               |               |               |               |
| Damp heat, cyclic, to IEC 60068-2-30                        |               |               |               |               |               |               |               |               |               |
| -25...60  | -25...60      | -25...60      | -25...60      | -25...60      | -25...60      | -25...60      | -25...60      | -25...60      | -25...60      |
| -25...40  | -25...40      | -25...40      | -25...40      | -25...40      | -25...40      | -25...40      | -25...40      | -25...40      | -25...40      |
| -40 - 80  | -40 - 80      | -40 - 80      | -40 - 80      | -40 - 80      | -40 - 80      | -40 - 80      | -40 - 80      | -40 - 80      | -40 - 80      |
|   |               |               |               |               |               |               |               |               |               |
| 10  | 10            | 10            | 10            | 10            | 10            | 10            | 10            | 10            | 10            |
| 10  | 10            | 10            | 10            | 10            | 10            | 10            | 10            | 10            | 10            |
| 8   | 8             | 8             | 8             | 8             | 8             | 8             | 8             | 8             | 8             |
| IP00  | IP00          | IP00          | IP00          | IP00          | IP00          | IP00          | IP00          | IP00          | IP00          |
| Finger- and back-of-hand proof with cover or terminal block |               |               |               |               |               |               |               |               |               |
| 15  | 15            | 15            | 15            | 15            | 32            | 15            | 32            | 32            | 32            |
| 50 - 240  | 50 - 240      | 50 - 240      | 50 - 240      | 50 - 240      | –             | –             | –             | –             | –             |
| 70 - 240  | 70 - 240      | 70 - 240      | 70 - 240      | 70 - 240      | –             | –             | –             | –             | –             |
| 2/0 - 500 MCM   | 2/0 - 500 MCM | 2/0 - 500 MCM | 2/0 - 500 MCM | 2/0 - 500 MCM | –             | –             | –             | –             | –             |
| 50  | 50            | 60            | 60            | 60            | 100           | 80            | 100           | 100           | 100           |
| M10   | M10           | M12           | M12           | M12           | M12           | M12           | M12           | M12           | M12           |
| 24  | 24            | 35            | 35            | 35            | 35            | 35            | 35            | 35            | 35            |
| 1 x (0.75 - 2.5)  |               |               |               |               |               |               |               |               |               |
| 2 x (0.75 - 2.5)  |               |               |               |               |               |               |               |               |               |
| 1 x (0.75 - 2.5)  |               |               |               |               |               |               |               |               |               |
| 2 x (0.75 - 2.5)  |               |               |               |               |               |               |               |               |               |
| 2 x (18 - 12)   | 2 x (18 - 12) | 2 x (18 - 12) | 2 x (18 - 12) | 2 x (18 - 12) | 2 x (18...12) | 2 x (18 - 12) | 2 x (18 - 12) | 2 x (18 - 12) | 2 x (18 - 12) |
| M3.5  | M3.5          | M3.5          | M3.5          | M3.5          | M3.5          | M3.5          | M3.5          | M3.5          | M3.5          |
| 1.2   | 1.2           | 1.2           | 1.2           | 1.2           | 1.2           | 1.2           | 1.2           | 1.2           | 1.2           |
| 16  | 16            | 18            | 18            | 18            | 18            | 18            | 18            | 18            | 18            |
| 2   | 2             | 2             | 2             | 2             | 2             | 2             | 2             | 2             | 2             |



## 1 DILM185...DILM1600, DILH

## Contactors

DILM185A DILM225A DILM250 DILM300A DILM400 DILM500 DILM570

## Main contacts

|  |           |      | DILM185A | DILM225A | DILM250 | DILM300A | DILM400 | DILM500 | DILM570 |
|--|-----------|------|----------|----------|---------|----------|---------|---------|---------|
| Rated impulse withstand voltage              | $U_{imp}$ | V AC | 8000     | 8000     | 8000    | 8000     | 8000    | 8000    | 8000    |
| Overvoltage category/pollution degree        |           |      | III/3    | III/3    | III/3   | III/3    | III/3   | III/3   | III/3   |
| Rated insulation voltage                     | $U_i$     | V AC | 1000     | 1000     | 1000    | 1000     | 1000    | 1000    | 1000    |
| Rated operating voltage                      | $U_e$     | V AC | 1000     | 1000     | 1000    | 1000     | 1000    | 1000    | 1000    |
| Safe isolation according to EN 61140         |           |      |          |          |         |          |         |         |         |
| Between coil and contacts                    |           | V AC | 500      | 500      | 500     | 500      | 500     | 500     | 500     |
| Between the contacts                         |           | V AC | 500      | 500      | 500     | 500      | 500     | 500     | 500     |
| Making capacity (cos $\Phi$ to IEC/EN 60947) |           | A    | 2700     | 2700     | 3000    | 3600     | 5500    | 5500    | 6000    |
| Breaking capacity                            |           |      |          |          |         |          |         |         |         |
| 220/230 V                                    |           | A    | 2250     | 2250     | 2500    | 3000     | 5000    | 5000    | 5800    |
| 380/440 V                                    |           | A    | 2250     | 2250     | 2500    | 3000     | 5000    | 5000    | 5800    |
| 500 V  |           | A    | 2250     | 2250     | 2500    | 3000     | 5000    | 5000    | 5800    |
| 660/690 V                                    |           | A    | 2250     | 2250     | 2500    | 3000     | 5000    | 5000    | 5800    |
| 1000 V                                       |           | A    | 760      | 760      | 760     | 950      | 950     | 950     | 950     |

Component lifespan

→ Page 87

Short-circuit rating

| Short-circuit protection rating maximum fuse |              |   |     |     |     |     |     |     |     |
|--|--------------|---|-----|-----|-----|-----|-----|-----|-----|
| Type "2" coordination                        |              |   |     |     |     |     |     |     |     |
| 400 V  | gG/gL 500 V  | A | 250 | 250 | 315 | 315 | 500 | 500 | 500 |
| 690 V  | gG/gL 690 V  | A | 250 | 250 | 315 | 315 | 500 | 500 | 500 |
| 1000 V                                       | gG/gL 1000 V | A | 160 | 160 | 160 | 160 | 200 | 200 | 200 |
| Type "1" coordination                        |              |   |     |     |     |     |     |     |     |
| 400 V  | gG/gL 500 V  | A | 400 | 400 | 400 | 400 | 630 | 630 | 800 |
| 690 V  | gG/gL 690 V  | A | 315 | 315 | 400 | 400 | 630 | 630 | 630 |
| 1000 V                                       | gG/gL 1000 V | A | 200 | 200 | 200 | 200 | 250 | 250 | 250 |

## AC voltage

AC-1 operation

| Conventional thermal current 3 pole 50 - 60 Hz |          |   |     |     |     |     |      |      |      |
|--|----------|---|-----|-----|-----|-----|------|------|------|
| Open   |          |   |     |     |     |     |      |      |      |
| at 40 °C                                       | $I_{th}$ | A | 337 | 356 | 400 | 430 | 612  | 857  | 920  |
| at 50 °C                                       | $I_{th}$ | A | 301 | 310 | 360 | 385 | 548  | 767  | 821  |
| at 55 °C                                       | $I_{th}$ | A | 287 | 295 | 340 | 365 | 522  | 731  | 783  |
| at 60 °C                                       | $I_{th}$ | A | 275 | 285 | 330 | 350 | 500  | 700  | 750  |
| Enclosed <sup>1)</sup>                         | $I_{th}$ | A | 245 | 275 | 300 | 315 | 450  | 650  | –    |
| Conventional thermal current, 1-pole           |          |   |     |     |     |     |      |      |      |
| Open <sup>1)</sup>                             | $I_{th}$ | A | 685 | 707 | 825 | 875 | 1250 | 1750 | 1875 |
| Enclosed <sup>1)</sup>                         | $I_{th}$ | A | 625 | 636 | 742 | 785 | 1125 | 1600 | –    |

AC-3 operation

| Rated operational current AC -3 open, 50 – 60 Hz, 3 pole |       |    |     |     |     |     |     |     |     |
|--|-------|----|-----|-----|-----|-----|-----|-----|-----|
| 220/230 V  | $I_e$ | A  | 185 | 225 | 250 | 300 | 400 | 500 | 580 |
| 240 V  | $I_e$ | A  | 185 | 225 | 250 | 300 | 400 | 500 | 580 |
| 380/400 V  | $I_e$ | A  | 185 | 225 | 250 | 300 | 400 | 500 | 580 |
| 415 V  | $I_e$ | A  | 185 | 225 | 250 | 300 | 400 | 500 | 580 |
| 440 V  | $I_e$ | A  | 185 | 225 | 250 | 300 | 400 | 500 | 580 |
| 500 V  | $I_e$ | A  | 185 | 225 | 250 | 300 | 400 | 500 | 500 |
| 660/690 V  | $I_e$ | A  | 150 | 160 | 250 | 210 | 360 | 360 | 360 |
| 1000 V   | $I_e$ | A  | 76  | 76  | 76  | 95  | 95  | 95  | 95  |
| Rated operational power                                  |       |    |     |     |     |     |     |     |     |
| 220/230 V  | P     | kW | 55  | 70  | 75  | 90  | 125 | 155 | 185 |
| 240 V  | P     | kW | 62  | 75  | 85  | 100 | 132 | 170 | 200 |
| 380/400 V  | P     | kW | 90  | 110 | 132 | 160 | 200 | 250 | 315 |
| 415 V  | P     | kW | 110 | 132 | 148 | 180 | 240 | 300 | 348 |
| 440 V  | P     | kW | 115 | 138 | 132 | 185 | 200 | 250 | 370 |
| 500 V  | P     | kW | 132 | 160 | 180 | 215 | 290 | 360 | 360 |
| 660/690 V  | P     | kW | 140 | 150 | 240 | 195 | 344 | 344 | 344 |
| 1000 V   | P     | kW | 108 | 108 | 108 | 132 | 132 | 132 | 132 |

Notes

<sup>1)</sup> At maximum permissible ambient air temperature<sup>2)</sup> To 690 V

| DILM580   | DILM650 | DILM750 | DILM820 | DILM1000 | DILM1600           | DILH1400           | DILH2000           | DILH2200           | DILH2600           |
|-----------|---------|---------|---------|----------|--------------------|--------------------|--------------------|--------------------|--------------------|
| 8000      | 8000    | 8000    | 8000    | 8000     | 8000               | 8000               | 8000               | 8000               | 8000               |
| III/3     | III/3   | III/3   | III/3   | III/3    | III/3              | III/3              | III/3              | III/3              | III/3              |
| 1000      | 1000    | 1000    | 1000    | 1000     | 1000               | 1000               | 1000               | 1000               | 1000               |
| 1000      | 1000    | 1000    | 1000    | 1000     | 1000               | 1000               | 1000               | 1000               | 1000               |
| 500       | 500     | 500     | 500     | 500      | 500                | 500                | 500                | 500                | 500                |
| 500       | 500     | 500     | 500     | 500      | 500                | 500                | 500                | 500                | 500                |
| 7800      | 7800    | 9840    | 9840    | 9840     | 19000              | 9840               | 9840               | 9840               | 9840               |
| 6500      | 6500    | 8200    | 8200    | 8200     | 16000              | 8200               | 8200               | 8200               | 8200               |
| 6500      | 6500    | 8200    | 8200    | 8200     | 16000              | 8200               | 8200               | 8200               | 8200               |
| 6500      | 6500    | 8200    | 8200    | 8200     | 16000              | 8200               | 8200               | 8200               | 8200               |
| 6500      | 6500    | 8200    | 8200    | 8200     | 16000              | 8200               | 8200               | 8200               | 8200               |
| 4350      | 4350    | 5800    | 5800    | 5800     | 5800               | 5800               | 5800               | 5800               | 5800               |
| → Page 87 |         |         |         |          |                    |                    |                    |                    |                    |
| 630       | 630     | 630     | 630     | 630      | -                  | -                  | -                  | -                  | -                  |
| 630       | 630     | 630     | 630     | 630      | -                  | -                  | -                  | -                  | -                  |
| 500       | 500     | 630     | 630     | 630      | -                  | -                  | -                  | -                  | -                  |
| 1000      | 1000    | 1200    | 1200    | 1200     | -                  | -                  | -                  | -                  | -                  |
| 1000      | 1000    | 1200    | 1200    | 1200     | -                  | -                  | -                  | -                  | -                  |
| 630       | 630     | 800     | 800     | 800      | -                  | -                  | -                  | -                  | -                  |
| 980       | 1041    | 1102    | 1225    | 1225     | 2200 <sup>2)</sup> | 1714 <sup>2)</sup> | 2450 <sup>2)</sup> | 2700 <sup>2)</sup> | 3185 <sup>2)</sup> |
| 876       | 931     | 986     | 1095    | 1095     | 1970 <sup>2)</sup> | 1533 <sup>2)</sup> | 2190 <sup>2)</sup> | 2400 <sup>2)</sup> | 2847 <sup>2)</sup> |
| 836       | 888     | 940     | 1044    | 1044     | 1880 <sup>2)</sup> | 1462 <sup>2)</sup> | 2089 <sup>2)</sup> | 2300 <sup>2)</sup> | 2716 <sup>2)</sup> |
| 800       | 850     | 900     | 1000    | 1000     | 1800 <sup>2)</sup> | 1400 <sup>2)</sup> | 2000 <sup>2)</sup> | 2200 <sup>2)</sup> | 2600 <sup>2)</sup> |
| -         | -       | -       | -       | -        | -                  | -                  | -                  | -                  | -                  |
| 2000      | 2125    | 2250    | 2500    | 2500     | 4500               | 3500               | 5000               | 5500               | 6500 <sup>2)</sup> |
| -         | -       | -       | -       | -        | -                  | -                  | -                  | -                  | -                  |
| 580       | 650     | 750     | 820     | 1000     | 1600               | -                  | -                  | -                  | -                  |
| 580       | 650     | 750     | 820     | 1000     | 1600               | -                  | -                  | -                  | -                  |
| 580       | 650     | 750     | 820     | 1000     | 1600               | -                  | -                  | -                  | -                  |
| 580       | 650     | 750     | 820     | 1000     | 1600               | -                  | -                  | -                  | -                  |
| 580       | 650     | 750     | 820     | 1000     | 1600               | -                  | -                  | -                  | -                  |
| 580       | 650     | 750     | 820     | 1000     | 1600               | -                  | -                  | -                  | -                  |
| 580       | 650     | 750     | 820     | 1000     | 1600               | -                  | -                  | -                  | -                  |
| 435       | 435     | 580     | 580     | 750      | 1200               | -                  | -                  | -                  | -                  |
| 185       | 205     | 240     | 260     | 315      | 500                | -                  | -                  | -                  | -                  |
| 200       | 225     | 260     | 285     | 340      | 550                | -                  | -                  | -                  | -                  |
| 315       | 355     | 400     | 450     | 560      | 900                | -                  | -                  | -                  | -                  |
| 348       | 390     | 455     | 500     | 610      | 930                | -                  | -                  | -                  | -                  |
| 370       | 420     | 480     | 450     | 650      | 1000               | -                  | -                  | -                  | -                  |
| 420       | 470     | 550     | 600     | 730      | 1180               | -                  | -                  | -                  | -                  |
| 560       | 630     | 720     | 750     | 1000     | 1600               | -                  | -                  | -                  | -                  |
| 600       | 600     | 800     | 800     | 1100     | 1770               | -                  | -                  | -                  | -                  |

# 1.1

## Contactors

Comfort devices and standard devices greater than 170 A

### 1 DILM185...DILM1600, DILH

#### Contactors

DILM185A DILM225A DILM250 DILM300A DILM400 DILM500 DILM570

#### AC voltage

AC-4 operation

| Rated operational current AC -4 open, 50 – 60 Hz, 3 pole |       |    | DILM185A | DILM225A | DILM250 | DILM300A | DILM400 | DILM500 | DILM570 |
|--|-------|----|----------|----------|---------|----------|---------|---------|---------|
| 220/230 V  | $I_e$ | A  | 136      | 164      | 200     | 240      | 296     | 360     | 360     |
| 240 V  | $I_e$ | A  | 136      | 164      | 200     | 240      | 296     | 360     | 360     |
| 380/400 V  | $I_e$ | A  | 136      | 164      | 200     | 240      | 296     | 360     | 360     |
| 415 V  | $I_e$ | A  | 136      | 164      | 200     | 240      | 296     | 360     | 360     |
| 440 V  | $I_e$ | A  | 136      | 164      | 200     | 240      | 296     | 360     | 360     |
| 500 V  | $I_e$ | A  | 136      | 164      | 200     | 240      | 296     | 360     | 360     |
| 660/690 V  | $I_e$ | A  | 110      | 120      | 200     | 170      | 296     | 296     | 296     |
| 1000 V   | $I_e$ | A  | 55       | 55       | 76      | 76       | 95      | 95      | 95      |
| Rated operational power                                  |       |    | DILM185A | DILM225A | DILM250 | DILM300A | DILM400 | DILM500 | DILM570 |
| 220/230 V  | P     | kW | 41       | 51       | 62      | 75       | 92      | 112     | 112     |
| 240 V  | P     | kW | 45       | 54       | 68      | 82       | 101     | 122     | 122     |
| 380/400 V  | P     | kW | 75       | 90       | 110     | 132      | 160     | 200     | 200     |
| 415 V  | P     | kW | 80       | 96       | 117     | 142      | 176     | 216     | 216     |
| 440 V  | P     | kW | 85       | 102      | 125     | 150      | 186     | 229     | 229     |
| 500 V  | P     | kW | 96       | 116      | 143     | 172      | 214     | 260     | 260     |
| 660/690 V  | P     | kW | 102      | 110      | 189     | 160      | 283     | 344     | 344     |
| 1000 V   | P     | kW | 77       | 77       | 108     | 109      | 132     | 132     | 132     |

#### Capacitor operation

Individual compensation rated operational current  $I_e$  of alternating current capacitor

| Open                     |              |          | DILM185A | DILM225A | DILM250 | DILM300A | DILM400 | DILM500 | DILM570 |
|--------------------------|--------------|----------|----------|----------|---------|----------|---------|---------|---------|
| To 525 V                 |              | A        | 220      | 220      | 220     | 307      | 307     | 307     | 307     |
| 690 V                    |              | A        | 133      | 133      | 133     | 177      | 177     | 177     | 177     |
| Max. peak inrush current | $x I_e$      |          | 30       | 30       | 30      | 30       | 30      | 30      | 30      |
| Component lifespan       | c (contacts) | $x 10^6$ | 0.1      | 0.1      | 0.1     | 0.1      | 0.1     | 0.1     | 0.1     |
| Max. operating frequency |              | Ops/h    | 200      | 200      | 200     | 200      | 200     | 200     | 200     |

#### DC voltage

Operations

→ Engineering Page 92

Rated operational current  $I_e$  open

| DC-1 operation |       |   | DILM185A | DILM225A | DILM250 | DILM300A | DILM400 | DILM500 | DILM570 |
|----------------|-------|---|----------|----------|---------|----------|---------|---------|---------|
| 60 V           | $I_e$ | A | 300      | 300      | 300     | 400      | 400     | 400     | 400     |
| 110 V          | $I_e$ | A | 300      | 300      | 300     | 400      | 400     | 400     | 400     |
| 220 V          | $I_e$ | A | 300      | 300      | 300     | 400      | 400     | 400     | 400     |
| 440 V          | $I_e$ | A | 11       | 11       | 11      | 11       | 11      | 11      | 11      |
| DC-3 operation |       |   | DILM185A | DILM225A | DILM250 | DILM300A | DILM400 | DILM500 | DILM570 |
| 60 V           | $I_e$ | A | 300      | 300      | 300     | 400      | 400     | 400     | 400     |
| 110 V          | $I_e$ | A | 300      | 300      | 300     | 400      | 400     | 400     | 400     |
| 220 V          | $I_e$ | A | 300      | 300      | 300     | 400      | 400     | 400     | 400     |
| DC-5 operation |       |   | DILM185A | DILM225A | DILM250 | DILM300A | DILM400 | DILM500 | DILM570 |
| 60 V           | $I_e$ | A | 300      | 300      | 300     | 400      | 400     | 400     | 400     |
| 110 V          | $I_e$ | A | 300      | 300      | 300     | 400      | 400     | 400     | 400     |
| 220 V          | $I_e$ | A | 300      | 300      | 300     | 400      | 400     | 400     | 400     |

#### Current heat loss (3 pole)

|  |   |    |    |    |    |    |     |     |
|--|---|----|----|----|----|----|-----|-----|
| Current heat loss at $I_{th}$            | W | 34 | 45 | 55 | 37 | 58 | 113 | 130 |
| Current heat loss at $I_e$ to AC-3/400 V | W | 16 | 23 | 28 | 21 | 37 | 58  | 78  |

| DILM580 | DILM650 | DILM750 | DILM820 | DILM1000 | DILM1600 | DILH1400 | DILH2000 | DILH2200 | DILH2600 |
|---------|---------|---------|---------|----------|----------|----------|----------|----------|----------|
| 456     | 512     | 576     | 656     | 800      | 1280     | -        | -        | -        | -        |
| 456     | 512     | 576     | 656     | 800      | 1280     | -        | -        | -        | -        |
| 456     | 512     | 576     | 656     | 800      | 1280     | -        | -        | -        | -        |
| 456     | 512     | 576     | 656     | 800      | 1280     | -        | -        | -        | -        |
| 456     | 512     | 576     | 656     | 800      | 1280     | -        | -        | -        | -        |
| 456     | 512     | 576     | 656     | 800      | 1280     | -        | -        | -        | -        |
| 456     | 512     | 576     | 656     | 800      | 1280     | -        | -        | -        | -        |
| 348     | 348     | 464     | 464     | 700      | 1120     | -        | -        | -        | -        |
| 143     | 161     | 181     | 209     | 260      | 430      | -        | -        | -        | -        |
| 156     | 176     | 200     | 228     | 280      | 450      | -        | -        | -        | -        |
| 250     | 280     | 315     | 355     | 450      | 750      | -        | -        | -        | -        |
| 274     | 307     | 346     | 394     | 490      | 770      | -        | -        | -        | -        |
| 290     | 326     | 367     | 418     | 520      | 830      | -        | -        | -        | -        |
| 330     | 370     | 417     | 474     | 590      | 940      | -        | -        | -        | -        |
| 440     | 494     | 556     | 633     | 780      | 1300     | -        | -        | -        | -        |
| 509     | 509     | 678     | 678     | 1000     | 1650     | -        | -        | -        | -        |
| 463     | 463     | 463     | 463     | 463      | -        | -        | -        | -        | -        |
| 265     | 265     | 265     | 265     | 265      | -        | -        | -        | -        | -        |
| 30      | 30      | 30      | 30      | 30       | -        | -        | -        | -        | -        |
| 0.1     | 0.1     | 0.1     | 0.1     | 0.1      | -        | -        | -        | -        | -        |
| 200     | 200     | 200     | 200     | 200      | -        | -        | -        | -        | -        |
| -       | -       | -       | -       | -        | -        | -        | -        | -        | -        |
| -       | -       | -       | -       | -        | -        | -        | -        | -        | -        |
| -       | -       | -       | -       | -        | -        | -        | -        | -        | -        |
| -       | -       | -       | -       | -        | -        | -        | -        | -        | -        |
| -       | -       | -       | -       | -        | -        | -        | -        | -        | -        |
| -       | -       | -       | -       | -        | -        | -        | -        | -        | -        |
| -       | -       | -       | -       | -        | -        | -        | -        | -        | -        |
| -       | -       | -       | -       | -        | -        | -        | -        | -        | -        |
| -       | -       | -       | -       | -        | -        | -        | -        | -        | -        |
| -       | -       | -       | -       | -        | -        | -        | -        | -        | -        |
| -       | -       | -       | -       | -        | -        | -        | -        | -        | -        |
| -       | -       | -       | -       | -        | -        | -        | -        | -        | -        |
| 61      | 69      | 78      | 96      | 96       | 155      | 188      | 192      | 232      | 250      |
| 32      | 41      | 54      | 65      | 96       | 123      | -        | -        | -        | -        |

### DILM185...DILM1600, DILH

|   |  |          |            | Contactors                         |            |  |                   |                   |                   |                   |
|---|--|----------|------------|------------------------------------|------------|--|-------------------|-------------------|-------------------|-------------------|
|   |  |          |            | DILM185A                           | DILM225A   | DILM250                                | DILM300A          | DILM400           | DILM500           | DILM570           |
| <b>Magnet systems</b>   |  |          |            |                                    |            |  |                   |                   |                   |                   |
| Voltage tolerance <sup>1)</sup>   | AC operated                              | Pick-up  | $x U_c$    | 0.8 - 1.15                         | 0.8 - 1.15 |  |                   |                   |                   |                   |
|   | AC operated                              | Drop-out | $x U_c$    | 0.25 - 0.6                         | 0.25 - 0.6 |  |                   |                   |                   |                   |
|   | DC operated                              | Pick-up  | $x U_c$    | 0.7 - 1.2                          | 0.7 - 1.2  |  |                   |                   |                   |                   |
|   | DC operated                              | Drop-out | $x U_c$    | 0.15 - 0.6                         | 0.15 - 0.6 |  |                   |                   |                   |                   |
| Power consumption of the coil in a cold state and $1.0 x U_c$   | 50/60 Hz                                 | Pick-up  | VA         | 210                                | 210        | –                                      | –                 | –                 | –                 | –                 |
|   | 50/60 Hz                                 | Sealing  | VA         | 2.6                                | 2.6        | –                                      | –                 | –                 | –                 | –                 |
|   | 50/60 Hz                                 | Sealing  | W          | 2.6                                | 2.6        | –                                      | –                 | –                 | –                 | –                 |
|   | DC operated                              | Pick-up  | W          | 180                                | 180        | –                                      | –                 | –                 | –                 | –                 |
|   | DC operated                              | Sealing  | W          | 2.1                                | 2.1        | –                                      | –                 | –                 | –                 | –                 |
| Voltage tolerance   | Comfort series DILM...                   | Pick-up  | $x U_c$    | –                                  | –          | $0.7 x U_{c\ min} - 1.15 x U_{c\ max}$ |                   |                   |                   |                   |
|   | Standard range DILM...-S                 | Pick-up  | $x U_c$    | –                                  | –          | $0.85 x U_{c\ min} - 1.1 x U_{c\ max}$ |                   |                   |                   |                   |
|   | Comfort series DILM...                   | Drop-out | $x U_c$    | –                                  | –          | $0.2 x U_{c\ min} - 0.6 x U_{c\ min}$  |                   |                   |                   |                   |
|   | Standard range DILM...-S                 | Drop-out | $x U_c$    | –                                  | –          | $0.2 x U_{c\ min} - 0.4 x U_{c\ min}$  |                   |                   |                   |                   |
| Power consumption of the coil in a cold state and $1.0 x U_c$   | Comfort series DILM...                   | Pick-up  | VA         | –                                  | –          | 380 <sup>2)</sup>                      | 380 <sup>2)</sup> | 450 <sup>2)</sup> | 450 <sup>2)</sup> | 450 <sup>2)</sup> |
|   | Comfort series DILM...                   | Pick-up  | W          | –                                  | –          | 250                                    | 250               | 350               | 350               | 350               |
|   | Comfort series DILM...                   | Sealing  | VA         | –                                  | –          | 4.3                                    | 4.3               | 4.3               | 4.3               | 4.3               |
|   | Comfort series DILM...                   | Sealing  | W          | –                                  | –          | 3.3                                    | 3.3               | 3.3               | 3.3               | 3.3               |
|   | Standard range DILM...-S                 | Pick-up  | VA         | –                                  | –          | 360 <sup>4)</sup>                      | 360 <sup>4)</sup> | 715 <sup>4)</sup> | 715 <sup>4)</sup> | 715 <sup>4)</sup> |
|   | Standard range DILM...-S                 | Pick-up  | W          | –                                  | –          | 325                                    | 625               | 645               | 645               | 645               |
|   | Standard range DILM...-S                 | Sealing  | VA         | –                                  | –          | 4.3                                    | 4.3               | 4.3               | 4.3               | 4.3               |
|   | Standard range DILM...-S                 | Sealing  | W          | –                                  | –          | 3.3                                    | 3.3               | 3.3               | 3.3               | 3.3               |
| Duty factor   |  |          | % DF       | –                                  | –          | 100                                    | 100               | 100               | 100               | 100               |
| Changeover time at 100 % $U_c$ (recommended values), main circuit   |  |          |            |                                    |            |  |                   |                   |                   |                   |
| Comfort series DILM...  | Closing delay                            | ms       |            | –                                  | –          | < 100                                  | < 80              | < 80              | < 80              | < 80              |
|   | Opening delay                            | ms       |            | –                                  | –          | < 110                                  | < 110             | < 110             | < 110             | < 110             |
| Standard range DILM...-S  | Closing delay                            | ms       |            | < 60                               | < 60       | < 55                                   | < 55              | < 55              | < 55              | < 55              |
|   | Opening delay                            | ms       |            | < 40                               | < 40       | < 40                                   | < 40              | < 50              | < 50              | < 50              |
| Behavior in limit range and transition area, hold state   |  |          |            |                                    |            |  |                   |                   |                   |                   |
| Voltage interruption  | $(0 - 0.2 x U_{c\ min}) \leq 10\ ms$     |          |            | –                                  | –          | Targeted bridging during this time     |                   |                   |                   |                   |
|   | $(0 - 0.2 x U_{c\ min}) > 10\ ms$        |          |            | Drop-out of the contactor          |            |  |                   |                   |                   |                   |
| Voltage drops   | $(0 - 0.2 x U_{c\ min}) \leq 12\ ms$     |          |            | Targeted bridging during this time |            |  |                   |                   |                   |                   |
|   | $(0.2 - 0.6 x U_{c\ min}) > 12\ ms$      |          |            | Drop-out of the contactor          |            |  |                   |                   |                   |                   |
|   | $(0.6 - 0.7 x U_{c\ min})$               |          |            | Contactor remains switched on      |            |  |                   |                   |                   |                   |
| Excess voltage  | $(1.15 - 1.3 x U_{c\ max})$              |          |            | Contactor remains switched on      |            |  |                   |                   |                   |                   |
|   | $(> 1.3 x U_{c\ max}) \leq 3\ s$         |          |            | Contactor remains switched on      |            |  |                   |                   |                   |                   |
|   | $(> 1.3 x U_{c\ max}) > 3\ s$            |          |            | Drop-out of the contactor          |            |  |                   |                   |                   |                   |
| Pick-up phase   | $(0.7 x U_{c\ min})$                     |          |            | Contactor does not switch on       |            |  |                   |                   |                   |                   |
|   | $(0.7 x U_{c\ min} - 1.15 x U_{c\ max})$ |          |            | Contactor switches on safely       |            |  |                   |                   |                   |                   |
|   | $(> 1.15 x U_{c\ max})$                  |          |            | Contactor switches on safely       |            |  |                   |                   |                   |                   |
| Permissible transitional contact resistance (of external control unit when A11 is actuated)               |  |          | m $\Omega$ | –                                  | –          | $\leq 500$                             | $\leq 500$        | $\leq 500$        | $\leq 500$        | –                 |
| Permissible residual current (when A11 is actuated from the electronic system in the event of a 0 signal) |  |          | mA         | –                                  | –          | $\leq 1$                               | $\leq 1$          | $\leq 1$          | $\leq 1$          | –                 |
| PLC signal level (A3 - A4) to IEC/EN 61131-2 (part no. 2)   |  |          |            |                                    |            |  |                   |                   |                   |                   |
| High  |  |          | V          | 15                                 | 15         | 15                                     | 15                | 15                | 15                | –                 |
| Low   |  |          | V          | 5                                  | 5          | 5                                      | 5                 | 5                 | 5                 | –                 |

### Electromagnetic compatibility (EMC)

Electromagnetic compatibility

This product is designed for operation in industrial environments (environment 2). The use in residential environments (environment 1) could cause electrical interference so that addition suppression must be planned.

### Notes

- <sup>1)</sup>  $U_{c\ min}$ ,  $U_{c\ max}$ ,
- <sup>2)</sup> Control transformer with  $u_k \leq 0.6$
- <sup>3)</sup> Control transformer with  $u_k \leq 0.7$
- <sup>4)</sup>  $u_k \leq 10\ %$

| DILM580  | DILM650           | DILM750           | DILM820           | DILM1000          | DILM1600           | DILH1400          | DILH2000           | DILH2200           | DILH2600 |
|--|-------------------|-------------------|-------------------|-------------------|--------------------|-------------------|--------------------|--------------------|----------|
| -  | -                 | -                 | -                 | -                 | -                  | -                 | -                  | -                  | -        |
| -  | -                 | -                 | -                 | -                 | -                  | -                 | -                  | -                  | -        |
| -  | -                 | -                 | -                 | -                 | -                  | -                 | -                  | -                  | -        |
| -  | -                 | -                 | -                 | -                 | -                  | -                 | -                  | -                  | -        |
| -  | -                 | -                 | -                 | -                 | -                  | -                 | -                  | -                  | -        |
| -  | -                 | -                 | -                 | -                 | -                  | -                 | -                  | -                  | -        |
| -  | -                 | -                 | -                 | -                 | -                  | -                 | -                  | -                  | -        |
| -  | -                 | -                 | -                 | -                 | -                  | -                 | -                  | -                  | -        |
| $0.7 \times U_{c \min} - 1.15 \times U_{c \max}$ |                   |                   |                   |                   |                    |                   |                    |                    |          |
| $0.85 \times U_{c \min} - 1.1 \times U_{c \max}$ |                   |                   |                   |                   |                    |                   |                    |                    |          |
| $0.2 \times U_{c \min} - 0.6 \times U_{c \min}$  |                   |                   |                   |                   |                    |                   |                    |                    |          |
| $0.2 \times U_{c \min} - 0.4 \times U_{c \min}$  |                   |                   |                   |                   |                    |                   |                    |                    |          |
| 800 <sup>3)</sup>                                | 800 <sup>3)</sup> | 800 <sup>3)</sup> | 800 <sup>3)</sup> | 800 <sup>3)</sup> | 1600 <sup>3)</sup> | 800 <sup>3)</sup> | 1600 <sup>3)</sup> | 1600 <sup>3)</sup> | -        |
| 700  | 700               | 700               | 700               | 700               | 1400               | 700               | 1400               | 1400               | -        |
| 7.5  | 7.5               | 7.5               | 7.5               | 7.5               | 15                 | 7.5               | 15                 | 15                 | -        |
| 6.5  | 6.5               | 6.5               | 6.5               | 6.5               | 13                 | 6.5               | 13                 | 13                 | -        |
| -  | -                 | -                 | -                 | -                 | -                  | -                 | -                  | -                  | -        |
| -  | -                 | -                 | -                 | -                 | -                  | -                 | -                  | -                  | -        |
| -  | -                 | -                 | -                 | -                 | -                  | -                 | -                  | -                  | -        |
| -  | -                 | -                 | -                 | -                 | -                  | -                 | -                  | -                  | -        |
| 100  | 100               | 100               | 100               | 100               | 100                | 100               | 100                | 100                | 100      |
| < 70   | < 70              | < 70              | < 70              | < 70              | < 70               | < 70              | < 70               | < 70               | -        |
| < 110  | < 110             | < 110             | < 110             | < 110             | < 40               | < 40              | < 40               | < 40               | -        |
| -  | -                 | -                 | -                 | -                 | -                  | -                 | -                  | -                  | -        |
| -  | -                 | -                 | -                 | -                 | -                  | -                 | -                  | -                  | -        |
| Targeted bridging during this time               |                   |                   |                   |                   |                    |                   |                    |                    |          |
| Drop-out of the contactor                        |                   |                   |                   |                   |                    |                   |                    |                    |          |
| Targeted bridging during this time               |                   |                   |                   |                   |                    |                   |                    |                    |          |
| Drop-out of the contactor                        |                   |                   |                   |                   |                    |                   |                    |                    |          |
| Contactors remains switched on                   |                   |                   |                   |                   |                    |                   |                    |                    |          |
| Contactors remains switched on                   |                   |                   |                   |                   |                    |                   |                    |                    |          |
| Contactors remains switched on                   |                   |                   |                   |                   |                    |                   |                    |                    |          |
| Drop-out of the contactor                        |                   |                   |                   |                   |                    |                   |                    |                    |          |
| Contactors does not switch on                    |                   |                   |                   |                   |                    |                   |                    |                    |          |
| Contactors switches on safely                    |                   |                   |                   |                   |                    |                   |                    |                    |          |
| Contactors switches on safely                    |                   |                   |                   |                   |                    |                   |                    |                    |          |
| ≅ 500  | ≅ 500             | ≅ 500             | ≅ 500             | ≅ 500             | ≅ 500              | ≅ 500             | ≅ 500              | ≅ 500              | ≅ 500    |
| ≅ 1  | ≅ 1               | ≅ 1               | ≅ 1               | ≅ 1               | ≅ 1                | ≅ 1               | ≅ 1                | ≅ 1                | ≅ 1      |
| 15   | 15                | 15                | 15                | 15                | 15                 | 15                | 15                 | 15                 | 15       |
| 5  | 5                 | 5                 | 5                 | 5                 | 5                  | 5                 | 5                  | 5                  | 5        |

This product is designed for operation in industrial environments (environment 2). The use in residential environments (environment 1) could cause electrical interference so that addition suppression must be planned.

# 1.1

## Contactors

Basic devices up to 200 A, 4 pole

### DILMP20 ... DILMP200

1

DILMP20      DILMP32      DILMP63      DILMP125  
 DILMP45      DILMP80      DILMP160      DILMP200

| General   |                                      |                                      |   |                                      |                                      |
|---|--------------------------------------|--------------------------------------|---|--------------------------------------|--------------------------------------|
| Standards   | IEC/EN 60947, VDE 0660, UL, CSA      |                                      |   |                                      |                                      |
| Lifespan, mechanical  |                                      |                                      |   |                                      |                                      |
| AC operated   | c (contacts)                         | x 10 <sup>6</sup>                    | 10  |                                      |                                      |
| DC operated   | c (contacts)                         | x 10 <sup>6</sup>                    | 10  |                                      |                                      |
| Operating frequency, mechanical                                       |                                      |                                      |   |                                      |                                      |
| Mechanical, AC operated   | Operations/h                         |                                      | 5000  |                                      | 3600                                 |
| DC operated   | Operations/h                         |                                      | 5000  |                                      | 3600                                 |
| Maximum operating frequency   |                                      |                                      |   |                                      |                                      |
| Electrical (Contactor without overload relay)                         | 600                                  |                                      |   |                                      |                                      |
| Climatic proofing   |                                      |                                      |   |                                      |                                      |
|   |                                      |                                      | Damp heat, constant, to IEC 60068-2-3<br>Damp heat, cyclic, to IEC 60068-2-30 |                                      |                                      |
| Ambient temperature   |                                      |                                      |   |                                      |                                      |
| Open  | °C                                   | -25...60                             |   |                                      |                                      |
| Enclosed  | °C                                   | -25...40                             |   |                                      |                                      |
| Storage   | °C                                   | -40 - 80                             |   |                                      |                                      |
| Mounting position AC- and DC operated                                 |                                      |                                      |   |                                      |                                      |
|   |                                      |                                      |   |                                      |                                      |
| Mechanical shock resistance (IEC/EN 60068-2-27)                       |                                      |                                      |   |                                      |                                      |
| Half-sinusoidal shock 10 ms   |                                      |                                      |   |                                      |                                      |
| Main contacts   |                                      |                                      |   |                                      |                                      |
| N/O   | g                                    | 10                                   |   |                                      |                                      |
| Auxiliary contacts  |                                      |                                      |   |                                      |                                      |
| N/O   | g                                    | 7                                    |   |                                      |                                      |
| NC  | g                                    | 5                                    |   |                                      |                                      |
| Protection type   |                                      |                                      |   |                                      |                                      |
|   |                                      | IP20                                 | IP00  |                                      |                                      |
| With accessories  |                                      |                                      |   |                                      |                                      |
|   |                                      | –                                    | IP20  |                                      |                                      |
| Protection against direct contact when actuated from front (EN 50274) |                                      |                                      |   |                                      |                                      |
| Finger- and back-of-hand proof  |                                      |                                      |   |                                      |                                      |
| <b>Terminal type, screw connection</b>                                |                                      |                                      |   |                                      |                                      |
| Terminal capacity of main cable                                       |                                      |                                      |   |                                      |                                      |
| Solid   | mm <sup>2</sup>                      | 1 x (0.75 - 4)<br>2 x (0.75 - 2.5)   | 1 x (0.75 - 16)<br>2 x (0.75 - 10)  | 1 x (2.5 - 16)<br>2 x (2.5 - 16)     | –                                    |
| Flexible with ferrule   | mm <sup>2</sup>                      | 1 x (0.75 - 2.5)<br>2 x (0.75 - 2.5) | 1 x (0.75 - 16)<br>2 x (0.75 - 10)  | 1 x (2.5 - 35)<br>2 x (2.5 - 25)     | 1 x (10 - 95)<br>2 x (10 - 70)       |
| Stranded  | mm <sup>2</sup>                      | –                                    | 1 x 16  | 1 x (16 - 50)<br>2 x (16 - 35)       | 1 x (16 - 120)<br>2 x (16 - 95)      |
| Solid or stranded   | AWG                                  | 18 - 14                              | 18 - 6  | 12 - 2                               | 8 - 250MCM                           |
| Flat conductor  | Number of layers x width x thickness | mm                                   | –   | 2 x<br>(6 x 9 x 0.8)                 | 2 x<br>(6 x 16 x 0.8)                |
| Terminal capacity of control circuit cable                            |                                      |                                      |   |                                      |                                      |
| Solid   | mm <sup>2</sup>                      | 1 x (0.75 - 4)<br>2 x (0.75 - 2.5)   | 1 x (0.75 - 4)<br>2 x (0.75 - 2.5)  | 1 x (0.75 - 4)<br>2 x (0.75 - 4)     | 1 x (0.75 - 4)<br>2 x (0.75 - 4)     |
| Flexible with ferrule   | mm <sup>2</sup>                      | 1 x (0.75 - 2.5)<br>2 x (0.75 - 2.5) | 1 x (0.75 - 2.5)<br>2 x (0.75 - 2.5)  | 1 x (0.75 - 2.5)<br>2 x (0.75 - 2.5) | 1 x (0.75 - 2.5)<br>2 x (0.75 - 2.5) |
| Solid or stranded   | AWG                                  | 18 - 14                              | 18 - 14   | 18 - 14                              | 18 - 14                              |
| Main cable connection screw/bolt                                      |                                      |                                      |   |                                      |                                      |
|   |                                      | M3.5                                 | M5  | M6                                   | M10                                  |
| Tightening torque   |                                      |                                      |   |                                      |                                      |
|   | Nm                                   | 1.2                                  | 3   | 3.3                                  | 14                                   |
| Control circuit cable connection screw/bolt                           |                                      |                                      |   |                                      |                                      |
|   |                                      | M3.5                                 | M3.5  | M3.5                                 | M3.5                                 |
| Tightening torque   |                                      |                                      |   |                                      |                                      |
|   | Nm                                   | 1.2                                  | 1.2   | 1.2                                  | 1.2                                  |
| Tools   |                                      |                                      |   |                                      |                                      |
| Main conductors   |                                      |                                      |   |                                      |                                      |
| Pozidriv screwdriver  | Size                                 | 2                                    | 2   | 2                                    | –                                    |
| Internal hexagon  | SW                                   | mm                                   | –   | –                                    | 5                                    |
| Flat-blade screwdriver  | mm                                   | 0.8 x 5.5<br>1 x 6                   | 0.8 x 5.5<br>1 x 6  | 0.8 x 5.5<br>1 x 6                   | –                                    |
| Auxiliary conductors  |                                      |                                      |   |                                      |                                      |
| Pozidriv screwdriver  | Size                                 | 2                                    | 2   | 2                                    | 2                                    |
| Flat-blade screwdriver  | mm                                   | 0.8 x 5.5<br>1 x 6                   | 0.8 x 5.5<br>1 x 6  | 0.8 x 5.5<br>1 x 6                   | 0.8 x 5.5<br>1 x 6                   |

## DILMP20 ... DILMP200

|  |                           |             |          | DILMP20 | DILMP32<br>DILMP45 | DILMP63<br>DILMP80 | DILMP125<br>DILMP160 | DILMP200 |      |      |      |     |
|--|---------------------------|-------------|----------|---------|--------------------|--------------------|----------------------|----------|------|------|------|-----|
| <b>Main contacts</b>                                     |                           |             |          |         |                    |                    |                      |          |      |      |      |     |
| Rated impulse withstand voltage                          | $U_{imp}$                 | V AC        |          | 8000    |                    |                    |                      |          |      |      |      |     |
| Overvoltage category/pollution degree                    |                           |             |          | III/3   |                    |                    |                      |          |      |      |      |     |
| Rated insulation voltage                                 | $U_i$                     | V AC        |          | 690     |                    |                    |                      |          |      |      |      |     |
| Rated operating voltage                                  | $U_e$                     | V AC        |          | 690     |                    |                    |                      |          |      |      |      |     |
| Safe isolation according to EN 61140                     |                           |             |          |         |                    |                    |                      |          |      |      |      |     |
|  | Between coil and contacts | V AC        |          | 400     | 440                |                    |                      |          |      |      |      |     |
|  | Between the contacts      | V AC        |          | 400     | 440                |                    |                      |          |      |      |      |     |
| Making capacity (cos $\varphi$ to IEC/EN 60947)          | To 690 V                  | A           |          | 144     | 238                | 350                | 560                  | 700      | 1120 | 1330 | 1800 |     |
| Breaking capacity  |                           |             |          |         |                    |                    |                      |          |      |      |      |     |
|  | 220/230 V                 | A           |          | 120     | 180                | 250                | 400                  | 500      | 800  | 950  | 1150 |     |
|  | 380/400 V                 | A           |          | 120     | 180                | 250                | 400                  | 500      | 800  | 950  | 1150 |     |
|  | 500 V                     | A           |          | 100     | 180                | 250                | 400                  | 500      | 800  | 950  | 1150 |     |
|  | 660/690 V                 | A           |          | 70      | 120                | 144                | 250                  | 296      | 650  | 750  | 800  |     |
| Short-circuit rating                                     |                           |             |          |         |                    |                    |                      |          |      |      |      |     |
| Short-circuit protection rating maximum fuse             |                           |             |          |         |                    |                    |                      |          |      |      |      |     |
| Type "2" coordination                                    |                           |             |          |         |                    |                    |                      |          |      |      |      |     |
|  | 400 V                     | gG/gL 500 V | A        | 20      | 35                 | 35                 | 63                   | 80       | 160  | 160  | 250  |     |
|  | 690 V                     | gG/gL 690 V | A        | 20      | 35                 | 35                 | 50                   | 63       | 160  | 160  | 200  |     |
| Type "1" coordination                                    |                           |             |          |         |                    |                    |                      |          |      |      |      |     |
|  | 400 V                     | gG/gL 500 V | A        | 35      | 63                 | 100                | 125                  | 160      | 250  | 250  | 250  |     |
|  | 690 V                     | gG/gL 690 V | A        | 25      | 50                 | 50                 | 80                   | 80       | 200  | 200  | 200  |     |
| <b>AC voltage</b>  |                           |             |          |         |                    |                    |                      |          |      |      |      |     |
| AC-1 operation   |                           |             |          |         |                    |                    |                      |          |      |      |      |     |
| Conventional thermal current 3 pole 50 - 60 Hz           |                           |             |          |         |                    |                    |                      |          |      |      |      |     |
|  | Open                      | at 40 °C    | $I_{th}$ | A       | 22                 | 32                 | 45                   | 63       | 80   | 125  | 160  | 200 |
|  |                           | at 50 °C    | $I_{th}$ | A       | 21                 | 30                 | 41                   | 60       | 76   | 116  | 150  | 188 |
|  |                           | at 60 °C    | $I_{th}$ | A       | 20                 | 28                 | 39                   | 54       | 69   | 108  | 138  | 172 |
|  | Enclosed                  |             | $I_{th}$ | A       | 18                 | 27                 | 36                   | 50       | 64   | 100  | 128  | 160 |
| Conventional thermal current, 1 pole                     |                           |             |          |         |                    |                    |                      |          |      |      |      |     |
|  | Open                      |             | $I_{th}$ | A       | 60                 | 84                 | 117                  | 162      | 207  | 325  | 415  | 516 |
|  | Enclosed                  |             | $I_{th}$ | A       | 54                 | 76                 | 105                  | 146      | 186  | 292  | 373  | 464 |
| Rated operational power                                  |                           |             |          |         |                    |                    |                      |          |      |      |      |     |
|  | 220/230 V                 | P           | kW       | 8       | 12                 | 16                 | 23                   | 29       | 45   | 58   | 72   |     |
|  | 240 V                     | P           | kW       | 9       | 13                 | 18                 | 25                   | 32       | 49   | 63   | 79   |     |
|  | 380 V                     | P           | kW       | 14      | 20                 | 28                 | 39                   | 50       | 78   | 100  | 125  |     |
|  | 415 V                     | P           | kW       | 15      | 22                 | 31                 | 43                   | 55       | 85   | 109  | 137  |     |
|  | 440 V                     | P           | kW       | 16      | 23                 | 33                 | 46                   | 58       | 90   | 116  | 145  |     |
|  | 500 V                     | P           | kW       | 18      | 26                 | 37                 | 52                   | 66       | 103  | 132  | 165  |     |
|  | 690 V                     | P           | kW       | 24      | 35                 | 49                 | 68                   | 87       | 136  | 174  | 217  |     |
| AC-3 operation   |                           |             |          |         |                    |                    |                      |          |      |      |      |     |
| Rated operational current AC -3 open, 50 – 60 Hz, 3 pole |                           |             |          |         |                    |                    |                      |          |      |      |      |     |
|  | 220/230 V                 | $I_e$       | A        | 12      | 18                 | 25                 | 40                   | 50       | 80   | 95   | 115  |     |
|  | 240 V                     | $I_e$       | A        | 12      | 18                 | 25                 | 40                   | 50       | 80   | 95   | 115  |     |
|  | 380/400 V                 | $I_e$       | A        | 12      | 18                 | 25                 | 40                   | 50       | 80   | 95   | 115  |     |
|  | 415 V                     | $I_e$       | A        | 12      | 18                 | 25                 | 40                   | 50       | 80   | 95   | 115  |     |
|  | 440 V                     | $I_e$       | A        | 12      | 18                 | 25                 | 40                   | 50       | 80   | 95   | 115  |     |
|  | 500 V                     | $I_e$       | A        | 10      | 18                 | 25                 | 40                   | 50       | 80   | 95   | 115  |     |
|  | 660/690 V                 | $I_e$       | A        | 7       | 12                 | 15                 | 25                   | 32       | 65   | 80   | 93   |     |
| Rated operational power                                  |                           |             |          |         |                    |                    |                      |          |      |      |      |     |
|  | 220/230 V                 | P           | kW       | 3.5     | 5                  | 7.5                | 12.5                 | 15.5     | 25   | 30   | 37   |     |
|  | 240 V                     | P           | kW       | 4       | 5.5                | 8.5                | 13.5                 | 17       | 27.5 | 33   | 40   |     |
|  | 380/400 V                 | P           | kW       | 5.5     | 7.5                | 11                 | 18.5                 | 22       | 37   | 45   | 55   |     |
|  | 415 V                     | P           | kW       | 7       | 10                 | 14.5               | 24                   | 30       | 48   | 57   | 70   |     |
|  | 440 V                     | P           | kW       | 7.5     | 10.5               | 15.5               | 25                   | 32       | 51   | 60   | 75   |     |
|  | 500 V                     | P           | kW       | 7       | 12                 | 17.5               | 28                   | 36       | 58   | 70   | 85   |     |
|  | 660/690 V                 | P           | kW       | 6.5     | 11                 | 14                 | 23                   | 30       | 63   | 75   | 90   |     |



# 1.1

## Contactors

Basic devices up to 200 A, 4 pole

### 1 DILMP20 ... DILMP200

|   |   |         |           | DILMP20    | DILMP32    |            | DILMP63    |            | DILMP125   |            |     |
|---|---|---------|-----------|------------|------------|------------|------------|------------|------------|------------|-----|
|   |   |         |           |            | DILMP45    |            | DILMP80    |            | DILMP160   |            |     |
|   |   |         |           |            | DILMP200   |            |            |            |            |            |     |
| <b>DC voltage</b>   |   |         |           |            |            |            |            |            |            |            |     |
| Rated operational current $I_e$ open                          |   |         |           |            |            |            |            |            |            |            |     |
| DC-1 operation  |   |         |           |            |            |            |            |            |            |            |     |
| 60 V  | $I_e$   | A       | 22        | 32         | 45         | 63         | 80         | 125        | 160        | 200        |     |
| 110 V   | $I_e$   | A       | 22        | 32         | 45         | 63         | 80         | 125        | 160        | 200        |     |
| 220 V   | $I_e$   | A       | 6         | 32         | 45         | 63         | 80         | 125        | 160        | 200        |     |
| 440 V   | $I_e$   | A       | 1.3       | 3          | 3          | 5          | 5          | 10         | 10         | 10         |     |
| DC-3 operation  |   |         |           |            |            |            |            |            |            |            |     |
| 60 V  | $I_e$   | A       | 20        | 32         | 45         | 63         | 80         | 125        | 160        | 200        |     |
| 110 V   | $I_e$   | A       | 20        | 32         | 45         | 63         | 80         | 125        | 160        | 200        |     |
| 220 V   | $I_e$   | A       | 1.5       | 32         | 45         | 63         | 80         | 125        | 160        | 200        |     |
| 440 V   | $I_e$   | A       | 0.2       | 6          | 6          | 8          | 8          | 9          | 9          | 9          |     |
| DC-5 operation  |   |         |           |            |            |            |            |            |            |            |     |
| 60 V  | $I_e$   | A       | 20        | 32         | 45         | 63         | 80         | 125        | 160        | 200        |     |
| 110 V   | $I_e$   | A       | 20        | 25         | 32         | 50         | 80         | 125        | 160        | 200        |     |
| 220 V   | $I_e$   | A       | 1.5       | 15         | 22         | 38         | 70         | 100        | 125        | 150        |     |
| 440 V   | $I_e$   | A       | 0.2       | 4          | 4          | 8          | 8          | 8          | 8          | 8          |     |
| <b>Current heat loss (3 pole)</b>                             |   |         |           |            |            |            |            |            |            |            |     |
| Current heat loss at $I_{th}$                                 |   |         | W         | 4.7        | 8.2        | 12         | 16         | 23         | 29         | 46         | 60  |
| Impedance per pole  |   |         | mΩ        | 2.5        | 2          | 1.5        | 1          | 0.7        | 0.6        | 0.6        | 0.5 |
| <b>Magnet systems</b>   |   |         |           |            |            |            |            |            |            |            |     |
| Voltage tolerance   |   |         |           |            |            |            |            |            |            |            |     |
| AC operated 50 Hz   | Pick-up   | $x U_c$ | 0.8 - 1.1 | 0.8 - 1.1  | 0.8 - 1.1  | 0.8 - 1.1  | 0.8 - 1.1  | 0.8 - 1.1  | 0.8 - 1.1  | 0.8 - 1.1  |     |
| AC operated 50/60 Hz  |   | $x U_c$ | 0.8 - 1.1 | 0.85 - 1.1 | 0.85 - 1.1 | 0.85 - 1.1 | 0.85 - 1.1 | 0.85 - 1.1 | 0.85 - 1.1 | 0.85 - 1.1 |     |
| AC operated   | Drop-out  | $x U_c$ | 0.4 - 0.6 | 0.4 - 0.6  | 0.4 - 0.6  | 0.4 - 0.6  | 0.4 - 0.6  | 0.4 - 0.6  | 0.4 - 0.6  | 0.4 - 0.6  |     |
| DC operated <sup>1)</sup>                                     | Pick-up   | $x U_c$ | 0.8 - 1.1 | 0.7 - 1.2  | 0.7 - 1.2  | 0.7 - 1.2  | 0.7 - 1.2  | 0.7 - 1.2  | 0.7 - 1.2  | 0.7 - 1.2  |     |
| DC operated <sup>1)</sup>                                     | Drop-out  | $x U_c$ | 0.2 - 0.6 | 0.2 - 0.6  | 0.2 - 0.6  | 0.2 - 0.6  | 0.2 - 0.6  | 0.2 - 0.6  | 0.2 - 0.6  | 0.2 - 0.6  |     |
| Power consumption of the coil in a cold state and $1.0 x U_c$ |   |         |           |            |            |            |            |            |            |            |     |
| AC operated 50/60 Hz  | Pick-up   | VA      | 24        | 50         | 150        | 180        | 180        | 180        | 180        | 180        |     |
| AC operated 50/60 Hz  | Pick-up   | W       | 19        | 40         | 95         | 150        | 150        | 150        | 150        | 150        |     |
| AC operated 50/60 Hz  | Sealing   | VA      | 4         | 8          | 16         | 3.1        | 3.1        | 3.1        | 3.1        | 3.1        |     |
| AC operated 50/60 Hz  | Sealing   | W       | 1.2       | 2.4        | 4          | 2.1        | 2.1        | 2.1        | 2.1        | 2.1        |     |
| DC operated <sup>1)</sup>                                     | Pick-up   | W       | 4.5       | 12         | 24         | 149        | 149        | 149        | 149        | 149        |     |
| DC operated <sup>1)</sup>                                     | Sealing   | W       | 4.5       | 0.5        | 0.5        | 2.1        | 2.1        | 2.1        | 2.1        | 2.1        |     |
| Duty factor   |   |         | % DF      | 100        | 100        | 100        | 100        | 100        | 100        | 100        |     |
| Changeover times at 100 % $U_c$ (recommended values)          |   |         |           |            |            |            |            |            |            |            |     |
| Main contacts   |   |         |           |            |            |            |            |            |            |            |     |
| AC operated   |   |         |           |            |            |            |            |            |            |            |     |
|   | Closing delay   | ms      | 15...21   | 16...22    | 12...18    | 28...33    | 28...33    | 28...33    | 28...33    | 28...33    |     |
|   | Opening delay   | ms      | 9...18    | 8...14     | 8...13     | 35...41    | 35...41    | 35...41    | 35...41    | 35...41    |     |
| DC operated <sup>1)</sup>                                     |   |         |           |            |            |            |            |            |            |            |     |
|   | Closing delay   | ms      | 31        | 47         | 54         | 35         | 35         | 35         | 35         | 35         |     |
|   | Opening delay   | ms      | 12        | 30         | 24         | 30         | 30         | 30         | 30         | 30         |     |
| Arcing time   |   |         |           |            |            |            |            |            |            |            |     |
|   | Permissible residual current when A1 - A2 are actuated from the electronic system (with 0 signal) | mA      | ≤ 1       | ≤ 1        | ≤ 1        | ≤ 1        | ≤ 1        | ≤ 1        | ≤ 1        | ≤ 1        |     |

#### Notes

<sup>1)</sup> At least double-pulse bridge rectifier

**DILK**

|   |                                      |    | DILK12                         | DILK20            | DILK25          | DILK33            | DILK50            |      |
|---|--------------------------------------|----|--------------------------------|-------------------|-----------------|-------------------|-------------------|------|
| <b>General</b>  |                                      |    |                                |                   |                 |                   |                   |      |
| Standards   |                                      |    | IEC/EN 60947, VDE 0660         |                   |                 |                   |                   |      |
| Ambient temperature   |                                      |    |                                |                   |                 |                   |                   |      |
| Open  | °C                                   |    | -25...60                       | -25...60          | -25...60        | -25...60          | -25...60          |      |
| Enclosed  | °C                                   |    | -25...40                       | -25...40          | -25...40        | -25...40          | -25...40          |      |
| Mounting position   |                                      |    |                                |                   |                 |                   |                   |      |
| Protection type   |                                      |    | IP00                           | IP00              | IP00            | IP00              | IP00              |      |
| Protection against direct contact when actuated from front (EN 50274) |                                      |    | Finger- and back-of-hand proof |                   |                 |                   |                   |      |
| Weight basic device   |                                      |    |                                |                   |                 |                   |                   |      |
| AC operated   | kg                                   |    | 0.55                           | 0.55              | 0.55            | 1                 | 1                 |      |
| Terminal capacity of main cable                                       |                                      |    |                                |                   |                 |                   |                   |      |
| Solid   | mm <sup>2</sup>                      |    | 1 x (0.75 - 16)                | 1 x (0.75 - 16)   | 1 x (0.75 - 16) | 1 x (2.5 - 16)    | 1 x (2.5 - 16)    |      |
| Flexible with ferrule   | mm <sup>2</sup>                      |    | 1 x (0.75 - 16)                | 1 x (0.75 - 16)   | 1 x (0.75 - 16) | 1 x (2.5 - 35)    | 1 x (2.5 - 35)    |      |
| Stranded  | mm <sup>2</sup>                      |    | 1 x 16                         | 1 x 16            | 1 x 16          | 1 x (16 - 50)     | 1 x (16 - 50)     |      |
| Solid or stranded   | AWG                                  |    | 18 - 16                        | 18 - 6            | 18 - 6          | 12 - 2            | 12 - 2            |      |
| Flat conductor  | Number of layers x width x thickness | mm | -                              | -                 | -               | 1 x (6 x 9 x 0.8) | 1 x (6 x 9 x 0.8) |      |
| <b>Group compensation</b>   |                                      |    |                                |                   |                 |                   |                   |      |
| 60 Hz   |                                      |    |                                |                   |                 |                   |                   |      |
| 230 V   | kvar                                 |    | 7.5                            | 11                | 15              | 20                | 25                |      |
| 400 V   | kvar                                 |    | 12.5                           | 20                | 25              | 33.3              | 50                |      |
| 525 V   | kvar                                 |    | 16.7                           | 25                | 33.3            | 40                | 65                |      |
| 690 V   | kvar                                 |    | 20                             | 33.3              | 40              | 55                | 85                |      |
| 50/60 Hz  |                                      |    |                                |                   |                 |                   |                   |      |
| Open  |                                      |    |                                |                   |                 |                   |                   |      |
| 230 V   | $I_e$                                | A  | 18                             | 29                | 38              | 50                | 72                |      |
| 400 V   | $I_e$                                | A  | 18                             | 29                | 38              | 50                | 72                |      |
| 525 V   | $I_e$                                | A  | 18                             | 29                | 38              | 50                | 72                |      |
| 690 V   | $I_e$                                | A  | 18                             | 29                | 38              | 50                | 72                |      |
| Enclosed  |                                      |    |                                |                   |                 |                   |                   |      |
| 230 V   | $I_e$                                | A  | 16                             | 26                | 34              | 45                | 65                |      |
| 400 V   | $I_e$                                | A  | 16                             | 26                | 34              | 45                | 65                |      |
| 525 V   | $I_e$                                | A  | 16                             | 26                | 34              | 45                | 65                |      |
| 690 V   | $I_e$                                | A  | 16                             | 26                | 34              | 45                | 65                |      |
| Making capacity (i-peak value) without damping                        |                                      |    | x $I_e$                        | 180               | 180             | 180               | 180               | 180  |
| Component lifespan  |                                      |    | c (contacts)                   | x 10 <sup>6</sup> | 0.15            | 0.15              | 0.15              | 0.15 |
| Maximum operating frequency   |                                      |    | Ops/h                          | 120               | 120             | 120               | 120               | 120  |

# 1.1

## Contactors

Contactor for capacitors

### 1 DILK

|  |               |                  | DILK12        | DILK20        | DILK25        | DILK33        | DILK50        |
|--|---------------|------------------|---------------|---------------|---------------|---------------|---------------|
| <b>Magnet systems</b>  |               |                  |               |               |               |               |               |
| Voltage tolerance  |               |                  |               |               |               |               |               |
| AC operated  | Pick-up       | x U <sub>c</sub> | 0.8 - 1.1     | 0.8 - 1.1     | 0.8 - 1.1     | 0.8 - 1.15    | 0.8 - 1.15    |
| AC operated  | Drop-out      | x U <sub>c</sub> | 0.3 - 0.6     | 0.3 - 0.6     | 0.3 - 0.6     | 0.3 - 0.6     | 0.3 - 0.6     |
| Power consumption of the coil in a cold state and 1.0 x U <sub>c</sub> |               |                  |               |               |               |               |               |
| 50 Hz  | Pick-up       | VA               | 58            | 58            | 58            | 45            | 45            |
| 50 Hz  | Sealing       | VA               | 7.6           | 7.6           | 7.6           | 1.5           | 1.5           |
| 50 Hz  | Sealing       | W                | 2.3           | 2.3           | 2.3           | 1.5           | 1.5           |
| 60 Hz  | Pick-up       | VA               | 71            | 71            | 71            | 45            | 45            |
| 60 Hz  | Sealing       | VA               | 9.3           | 9.3           | 9.3           | 1.5           | 1.5           |
| 60 Hz  | Sealing       | W                | 2.8           | 2.8           | 2.8           | 1.5           | 1.5           |
| 50/60 Hz   | Pick-up       | VA               | 65            | 65            | 65            | 45            | 45            |
|  |               |                  | 59            | 59            | 59            | 45            | 45            |
| 50/60 Hz   | Sealing       | VA               | 9.6           | 9.6           | 9.6           | 1.5           | 1.5           |
|  |               |                  | 7             | 7             | 7             | 1.5           | 1.5           |
| 50/60 Hz   | Sealing       | W                | 2.7           | 2.7           | 2.7           | 1.5           | 1.5           |
|  |               |                  | 2.2           | 2.2           | 2.2           | 1.5           | 1.5           |
| Duty factor  |               | % DF             | 100           | 100           | 100           | 100           | 100           |
| Changeover times at 100 % U <sub>c</sub> (recommended values)          |               |                  |               |               |               |               |               |
| Main contacts  |               |                  |               |               |               |               |               |
| AC operated  |               |                  |               |               |               |               |               |
|  | Closing delay | ms               | 16...22       | 16...22       | 16...22       | 50            | 50            |
|  | Opening delay | ms               | 8...14        | 8...14        | 8...14        | 40            | 40            |
| Arcing time  |               | ms               | 10            | 10            | 10            | 10            | 10            |
| <b>Electromagnetic compatibility (EMC)</b>                             |               |                  |               |               |               |               |               |
| Emitted interference   |               |                  | To EN 60947-1 | To EN 60947-1 | To EN 60947-1 | To EN 60947-1 | To EN 60947-1 |
| Interference immunity  |               |                  | To EN 60947-1 | To EN 60947-1 | To EN 60947-1 | To EN 60947-1 | To EN 60947-1 |
| <b>Further technical data</b>  |               |                  |               |               |               |               |               |
| As per contactor   |               | DIL              | M17           | M25           | M32           | M50           | M65           |

DILL

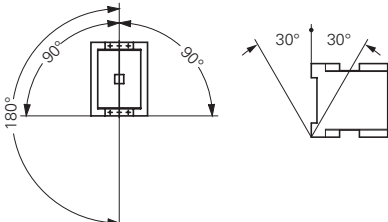
|   |          |                  |                   | DILL12   | DILL18   | DILL20   |
|---|----------|------------------|-------------------|--|----------|----------|
| <b>General</b>                                  |          |                  |                   |  |          |          |
| Standards                                       |          |                  |                   | IEC/EN 60947, VDE 0660, UL, CSA  |          |          |
| Lifespan, mechanical                            |          |                  |                   |  |          |          |
| AC operated                                     |          | c (contacts)     | x 10 <sup>6</sup> | 1  | 1        | 1        |
| Operating frequency, mechanical                 |          |                  |                   |  |          |          |
| Mechanical, AC operated                         |          | Operations/h     |                   | 60   | 60       | 60       |
| Maximum operating frequency                     |          |                  |                   |  |          |          |
| Electrical                                      |          | Operations/h     |                   | 60   | 60       | 60       |
| Climatic proofing                               |          |                  |                   | Damp heat, constant, to IEC 60068-2-78;<br>Damp heat, cyclic, to IEC 60068-2-30    |          |          |
| Ambient temperature                             | Open     | °C               |                   | -25...60   | -25...60 | -25...60 |
|   | Enclosed | °C               |                   | -25...40   | -25...40 | -25...40 |
|   | Storage  | °C               |                   | -40 - 80   | -40 - 80 | -40 - 80 |
| Mounting position                               |          |                  |                   |  |          |          |
| Mechanical shock resistance (IEC/EN 60068-2-27) |          |                  |                   |  |          |          |
| Half-sinusoidal shock 10 ms                     |          |                  |                   | 6.9  | 6.9      | 6.9      |
| Protection type                                 |          |                  |                   | IP00   | IP00     | IP00     |
| Weight  |          |                  |                   |  |          |          |
| AC operated                                     |          | kg               |                   | 0.42   | 0.42     | 0.42     |
| <b>Main contacts</b>                            |          |                  |                   |  |          |          |
| Rated impulse withstand voltage                 |          | U <sub>imp</sub> | V AC              | 8000   | 8000     | 8000     |
| Overvoltage category/pollution degree           |          |                  |                   | III/3  | III/3    | III/3    |
| Rated insulation voltage                        |          | U <sub>i</sub>   | V AC              | 690  | 690      | 690      |
| Rated operating voltage                         |          | U <sub>e</sub>   | V AC              | 690  | 690      | 690      |
| Making capacity                                 |          | A                |                   | 238  | 350      | 550      |
| Breaking capacity                               |          | 380/400 V        | A                 | 170  | 250      | 320      |
| Lifespan, electrical                            |          | c (contacts)     |                   | 10000  | 10000    | 10000    |
| Short-circuit protection rating maximum fuse    |          |                  |                   |  |          |          |
| 400 V   |          | gG/gL 500 V      | A                 | 63   | 100      | 125      |
| <b>AC voltage</b>                               |          |                  |                   |  |          |          |
| AC-1 operation                                  |          |                  |                   |  |          |          |
| Conventional thermal current                    |          |                  |                   |  |          |          |
| at 40 °C  |          | I <sub>th</sub>  | A                 | 27   | 40       | 45       |
| at 60 °C  |          | I <sub>th</sub>  | A                 | 24   | 35       | 40       |
| 230 V   |          | I <sub>e</sub>   | A                 | 12   | 18       | 20       |
| 400 V   |          | I <sub>e</sub>   | A                 | 12   | 18       | 20       |
| AC-1 operation                                  |          |                  |                   |  |          |          |
| 220/230 V                                       |          | I <sub>e</sub>   | A                 | 14   | 21       | 27       |
| 400 V   |          | I <sub>e</sub>   | A                 | 14   | 21       | 27       |
| Electric lamps                                  |          |                  |                   |  |          |          |
| Filament bulbs                                  |          | A                |                   | 14   | 21       | 27       |
| Mercury blended lamps                           |          | A                |                   | 12   | 16       | 23       |
| Fluorescent lamp load                           |          |                  |                   |  |          |          |
| Conventional reactor starter connection         |          | A                |                   | 20   | 26       | 35       |
| Duo circuit                                     |          | A                |                   | 20   | 26       | 35       |
| Electronic upstream devices                     |          | A                |                   | 12   | 18       | 20       |
| High-pressure mercury vapour lamps              |          | A                |                   | 12   | 18       | 20       |
| Metal-halide lamps                              |          | A                |                   | 12   | 18       | 20       |
| High-pressure sodium lamps                      |          | A                |                   | 12   | 18       | 20       |
| Low-pressure sodium lamps                       |          | A                |                   | 7.5  | 10       | 12       |
| Maximum permissible compensation capacitance    |          | µF               |                   | 470  | 470      | 470      |
| <b>Further technical data</b>                   |          |                  |                   |  |          |          |
| As per contactor                                |          | DIL              |                   | M17  | M25      | M32      |

# 1.1

## Contactors

Contactors up to 150 A with electronic actuation

### 1 DILMF

DILMF8      DILMF11      DILMF14      DILMF17

**General**  
Mounting position

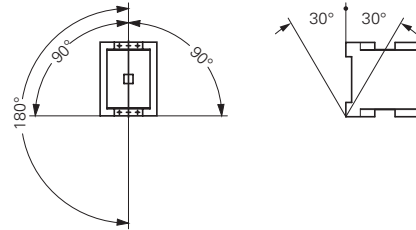

**AC voltage**

AC-3 operation

|   |           |       |    |     |     |     |      |
|---|-----------|-------|----|-----|-----|-----|------|
| Rated operational current AC-3 open, 50 – 60 Hz, 3 pole | 220/230 V | $I_e$ | A  | 7   | 9   | 12  | 18   |
|   | 240 V I   | $I_e$ | A  | 7   | 9   | 12  | 18   |
|   | 380/400 V | $I_e$ | A  | 7   | 9   | 12  | 18   |
|   | 415 V     | $I_e$ | A  | 7   | 9   | 12  | 18   |
|   | 440 V     | $I_e$ | A  | 7   | 9   | 12  | 18   |
|   | 500 V     | $I_e$ | A  | 5   | 7   | 10  | 18   |
|   | 660/690 V | $I_e$ | A  | 4   | 5   | 7   | 12   |
| Rated operational power                                 | 220/230 V | P     | kW | 2.2 | 2.5 | 3.5 | 5    |
|   | 240 V     | P     | kW | 2.2 | 3   | 4   | 5.5  |
|   | 380/400 V | P     | kW | 3   | 4   | 5.5 | 7.5  |
|   | 415 V     | P     | kW | 4   | 5.5 | 7   | 10   |
|   | 440 V     | P     | kW | 4.5 | 5.5 | 7.5 | 10.5 |
|   | 500 V     | P     | kW | 3.5 | 4.5 | 7   | 12   |
|   | 660/690 V | P     | kW | 3.5 | 4.5 | 6.5 | 11   |

AC-4 operation

|   |             |       |    |     |     |     |     |
|---|-------------|-------|----|-----|-----|-----|-----|
| Rated operational current AC-4 open, 50 - 60 Hz, 3 pole | 220/230 V I | $I_e$ | A  | 5   | 6   | 7   | 10  |
|   | 240 V       | $I_e$ | A  | 5   | 6   | 7   | 10  |
|   | 380/400 V   | $I_e$ | A  | 5   | 6   | 7   | 10  |
|   | 415 V       | $I_e$ | A  | 5   | 6   | 7   | 10  |
|   | 440 V       | $I_e$ | A  | 5   | 6   | 7   | 10  |
|   | 500 V       | $I_e$ | A  | 4.5 | 5   | 6   | 10  |
|   | 660/690 V   | $I_e$ | A  | 4   | 4.5 | 5   | 8   |
| Rated operational power                                 | 220/230 V   | P     | kW | 1   | 1.5 | 2   | 2.5 |
|   | 240 V       | P     | kW | 1.5 | 1.6 | 2.2 | 3   |
|   | 380/400 V   | P     | kW | 2.2 | 2.5 | 3   | 4.5 |
|   | 415 V       | P     | kW | 2.3 | 2.8 | 3.4 | 5   |
|   | 440 V       | P     | kW | 2.4 | 3   | 3.6 | 5.5 |
|   | 500 V       | P     | kW | 2.5 | 2.8 | 3.5 | 6   |
|   | 660/690 V   | P     | kW | 2.9 | 3.6 | 4.4 | 6.5 |

**Current heat loss (3 pole)**

|  |  |   |     |     |     |     |
|--|--|---|-----|-----|-----|-----|
| Current heat loss at $I_{th}$            |  | W | 2.4 | 2.4 | 2.4 | 7.3 |
| Current heat loss at $I_e$ to AC-3/400 V |  | W | 0.3 | 0.6 | 1   | 1.9 |

**Magnet systems**

|  |                      |          |         |            |            |            |            |
|--|----------------------|----------|---------|------------|------------|------------|------------|
| Voltage tolerance  | AC operated          | Pick-up  | $x U_c$ | 0.8 - 1.15 | 0.8 - 1.15 | 0.8 - 1.15 | 0.8 - 1.15 |
|  | AC operated          | Drop-out | $x U_c$ | 0.2 - 0.5  | 0.2 - 0.5  | 0.2 - 0.5  | 0.2 - 0.5  |
| Power consumption of the coil in a cold state and $1.0 \times U_c$ | Electronic actuation | Pick-up  | VA      | 14         | 14         | 14         | 14         |
|  | Electronic actuation | Sealing  | VA      | 0.7        | 0.7        | 0.7        | 0.7        |
|  | Electronic actuation | Sealing  | W       | 0.7        | 0.7        | 0.7        | 0.7        |
| Duty factor  |                      | % DF     | 100     | 100        | 100        | 100        |            |
| Switching times  | Closing delay        | ms       | 40      | 40         | 40         | 40         |            |
|  | Opening delay        | ms       | 45      | 45         | 45         | 45         |            |

suitable according to SEMI F47      SEMI F47      SEMI F47      SEMI F47

**Electromagnetic compatibility (EMC)**

|                       |               |
|-----------------------|---------------|
| Emitted interference  | To EN 60947-1 |
| Interference immunity | To EN 60947-1 |

**Further technical data**

|                  |     |    |    |     |     |
|------------------|-----|----|----|-----|-----|
| As per contactor | DIL | M7 | M9 | M12 | M17 |
|------------------|-----|----|----|-----|-----|

**Terminal type**

|                  |     |     |     |     |     |
|------------------|-----|-----|-----|-----|-----|
| As per contactor | DIL | M17 | M17 | M17 | M17 |
|------------------|-----|-----|-----|-----|-----|

| DILMF25 | DILMF32 | DILMF40 | DILMF50 | DILMF65 | DILMF80 | DILMF95 | DILMF115 | DILMF150 |
|---------|---------|---------|---------|---------|---------|---------|----------|----------|
|---------|---------|---------|---------|---------|---------|---------|----------|----------|

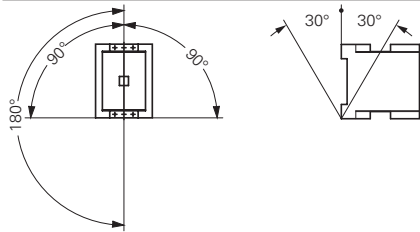

|      |    |      |      |    |      |    |     |     |
|------|----|------|------|----|------|----|-----|-----|
| 25   | 32 | 40   | 50   | 65 | 80   | 95 | 115 | 150 |
| 25   | 32 | 40   | 50   | 65 | 80   | 95 | 115 | 150 |
| 25   | 32 | 40   | 50   | 65 | 80   | 95 | 115 | 150 |
| 25   | 32 | 40   | 50   | 65 | 80   | 95 | 115 | 150 |
| 25   | 32 | 40   | 50   | 65 | 80   | 95 | 115 | 150 |
| 15   | 18 | 25   | 32   | 37 | 65   | 80 | 93  | 100 |
| 7.5  | 10 | 12.5 | 15.5 | 20 | 25   | 30 | 37  | 48  |
| 8.5  | 11 | 13.5 | 17   | 22 | 27.5 | 4  | 40  | 52  |
| 11   | 15 | 18.5 | 22   | 30 | 37   | 45 | 55  | 75  |
| 14.5 | 19 | 24   | 30   | 39 | 48   | 57 | 70  | 91  |
| 15.5 | 20 | 25   | 32   | 41 | 51   | 60 | 75  | 95  |
| 17.5 | 23 | 28   | 36   | 47 | 58   | 70 | 85  | 110 |
| 14   | 17 | 23   | 30   | 35 | 63   | 75 | 90  | 96  |

|     |     |     |     |     |    |    |    |    |
|-----|-----|-----|-----|-----|----|----|----|----|
| 13  | 15  | 18  | 21  | 25  | 40 | 50 | 55 | 65 |
| 13  | 15  | 18  | 21  | 25  | 40 | 50 | 55 | 65 |
| 13  | 15  | 18  | 21  | 25  | 40 | 50 | 55 | 65 |
| 13  | 15  | 18  | 21  | 25  | 40 | 50 | 55 | 65 |
| 13  | 15  | 18  | 21  | 25  | 40 | 50 | 55 | 65 |
| 13  | 15  | 18  | 21  | 25  | 40 | 50 | 55 | 65 |
| 10  | 12  | 14  | 17  | 20  | 27 | 37 | 45 | 50 |
| 3.5 | 4   | 5   | 6   | 7   | 12 | 16 | 17 | 20 |
| 4   | 4.5 | 5.5 | 6.5 | 7.5 | 13 | 17 | 19 | 22 |
| 6   | 7   | 9   | 10  | 12  | 20 | 26 | 28 | 33 |
| 6.5 | 7.5 | 9.5 | 11  | 13  | 24 | 30 | 33 | 39 |
| 7   | 8   | 10  | 12  | 14  | 25 | 32 | 35 | 41 |
| 8   | 9   | 11  | 13  | 16  | 29 | 36 | 40 | 47 |
| 8.5 | 10  | 12  | 14  | 17  | 26 | 35 | 43 | 48 |

|     |      |      |      |      |      |      |      |      |
|-----|------|------|------|------|------|------|------|------|
| 9.6 | 12.1 | 11.3 | 19   | 28.8 | 14.6 | 21.8 | 30.4 | 46.1 |
| 3.8 | 6.1  | 7.2  | 11.3 | 19   | 11.5 | 16.2 | 23.8 | 40.5 |

|            |            |            |            |            |            |            |            |            |
|------------|------------|------------|------------|------------|------------|------------|------------|------------|
| 0.8 - 1.15 | 0.8 - 1.15 | 0.8 - 1.15 | 0.8 - 1.15 | 0.8 - 1.15 | 0.8 - 1.15 | 0.8 - 1.15 | 0.8 - 1.15 | 0.8 - 1.15 |
| 0.2 - 0.5  | 0.2 - 0.5  | 0.2 - 0.5  | 0.2 - 0.5  | 0.2 - 0.5  | 0.2 - 0.5  | 0.2 - 0.5  | 0.2 - 0.5  | 0.2 - 0.5  |
| 14         | 14         | 45         | 45         | 45         | 75         | 75         | 180        | 180        |
| 0.7        | 0.7        | 1.5        | 1.5        | 1.5        | 2          | 2          | 3.1        | 3.1        |
| 0.7        | 0.7        | 1.5        | 1.5        | 1.5        | 2          | 2          | 2.1        | 2.1        |
| 100        | 100        | 100        | 100        | 100        | 100        | 100        | 100        | 100        |
| 40         | 40         | 50         | 50         | 50         | 55         | 55         | 40         | 40         |
| 45         | 45         | 45         | 45         | 45         | 40         | 40         | 40         | 40         |
| SEMI F47   | SEMI F47   | SEMI F47   | SEMI F47   | SEMI F47   | SEMI F47   | SEMI F47   | SEMI F47   | SEMI F47   |

To EN 60947-1

To EN 60947-1

|     |     |     |     |     |     |     |      |      |
|-----|-----|-----|-----|-----|-----|-----|------|------|
| M25 | M32 | M40 | M50 | M65 | M80 | M95 | M115 | M150 |
|-----|-----|-----|-----|-----|-----|-----|------|------|

|     |     |     |     |     |     |     |      |      |
|-----|-----|-----|-----|-----|-----|-----|------|------|
| M25 | M32 | M40 | M50 | M65 | M80 | M95 | M115 | M150 |
|-----|-----|-----|-----|-----|-----|-----|------|------|

# 1.1

## Contactors

### Auxiliary contact modules

#### 1 DILM..., DILA...

|   |                   |                | DILM7-... -<br>DILM38-...                                      | DILA-<br>XHI(C)...(-S) | DILM32-<br>XHI(C)...(-S) | DILM150-<br>XHI...  | DILM1000-XHI...<br>DILM820-XHI...       |
|---|-------------------|----------------|--|------------------------|--------------------------|---------------------|---|
| <b>Auxiliary contact</b>  |                   |                |  |                        |                          |                     |   |
| Interlocked opposing contacts within an auxiliary contact module (to IEC 60947-5-1 Annex L) <sup>1)</sup>     |                   |                | -  | Yes                    | Yes                      | Yes                 | Yes                                     |
| Normally closed (not late-normally closed) suitable as a mirror contact (to IEC/EN 60947-4-1, Annex F)        |                   |                | DILM7 -<br>DILM38  | DILM7 -<br>DILM38      | DILM7 -<br>DILM38        | DILM40 -<br>DILM170 | DILM40 - DILM225A<br>DILM250 - DILM1000 |
| Rated impulse withstand voltage   | U <sub>imp</sub>  | V AC           | 6000   | 6000                   | 6000                     | 6000                | 6000                                    |
| Overvoltage category/pollution degree   |                   |                | III/3  | III/3                  | III/3                    | III/3               | III/3                                   |
| Rated insulation voltage  | U <sub>i</sub>    | V AC           | 690  | 690                    | 690                      | 690                 | 690                                     |
| Rated operating voltage   | U <sub>e</sub>    | V AC           | 500  | 500                    | 500                      | 500                 | 500                                     |
| Safe isolation according to EN 61140  |                   |                |  |                        |                          |                     |   |
| Between coil and auxiliary contacts   |                   | V AC           | 400  | 400                    | 400                      | 440                 | 440                                     |
| Between the auxiliary contacts  |                   | V AC           | 400  | 400                    | 400                      | 440                 | 440                                     |
| Rated operational current   |                   |                |  |                        |                          |                     |   |
| AC-15   |                   |                |  |                        |                          |                     |   |
|   | 230 V             | I <sub>e</sub> | A  | 4                      | 4                        | 4                   | 4                                       |
|   | 380/415 V         | I <sub>e</sub> | A  | 4                      | 4                        | 4                   | 4                                       |
|   | 500 V             | I <sub>e</sub> | A  | 1.5                    | –                        | 1.5                 | 1.5                                     |
| DC L/R ≅ 15 ms <sup>2)</sup>  |                   |                |  |                        |                          |                     |   |
|   | 24 V              | I <sub>e</sub> | A  | 10                     | 10                       | 10                  | 10                                      |
|   | 60 V              | I <sub>e</sub> | A  | 6                      | 6                        | 6                   | 6                                       |
|   | 110 V             | I <sub>e</sub> | A  | 3                      | 3                        | 3                   | 3                                       |
|   | 220 V             | I <sub>e</sub> | A  | 1                      | 1                        | 1                   | 1                                       |
| DC-13 (6xP)   |                   |                |  |                        |                          |                     |   |
| Contacts in series:   |                   |                |  |                        |                          |                     |   |
|   | 3                 | 24 V           | A  | 2.5                    | 2.5                      | 2.5                 | –                                       |
|   | 3                 | 60 V           | A  | 1                      | 1                        | 1                   | –                                       |
|   | 3                 | 110 V          | A  | 0.5                    | 0.5                      | 0.5                 | –                                       |
|   | 3                 | 220 V          | A  | 0.25                   | 0.25                     | 0.25                | –                                       |
| Conventional thermal current  | I <sub>th</sub>   | A              | 10   | 16                     | 16                       | 16                  | 10                                      |
| Control circuit reliability (at U <sub>e</sub> = 24 V DC, U <sub>min</sub> = 17 V, I <sub>min</sub> = 5.4 mA) | Fault probability | λ              | < 10 <sup>-8</sup> , < 1 one failure in 100 million operations |                        |                          |                     |   |
| Component lifespan  |                   |                |  |                        |                          |                     |   |
| at U <sub>e</sub> = 230 V, AC-15, 3 A   |                   | c (contacts)   | x 10 <sup>6</sup>  | 1.3                    | 1.3                      | 1.3                 | 1.3                                     |
| Short-circuit rating without welding  |                   |                |  |                        |                          |                     |   |
| Max. fuse   |                   | A gG/gL        | 10   | 10                     | 10                       | 16                  | 16                                      |

#### Notes

<sup>1)</sup> Not with DIL...-XHIV and DIL...-XHICV.

<sup>2)</sup> Switch-on and switch-off conditions based on DC-13, time constant as specified.

P1SIL...M, DILM...-XP1

1

|  |                                      |                 | P1DILEM<br>DILM12-XP1            | DILM32-XP1    | DILM65-XP1     | DILM150-XP1                      | DILM185-XP1  |
|--|--------------------------------------|-----------------|----------------------------------|---------------|----------------|----------------------------------|--|
| <b>Parallel connector</b>                  |                                      |                 |                                  |               |                |                                  |  |
| Terminal capacity                          |                                      |                 |                                  |               |                |                                  |  |
| Solid                                      |                                      | mm <sup>2</sup> | 1 - 16                           | 16            | 16             | –                                | –  |
| Flexible with ferrule                      |                                      | mm <sup>2</sup> | 1 x (0.5 - 25)<br>2 x (0.5 - 16) | 1 x (16 - 35) | 1 x (16 - 120) | –                                | –  |
| Stranded                                   |                                      | mm <sup>2</sup> | 1 x (0.5 - 25)<br>2 x (0.5 - 16) | 1 x (16 - 50) | 1 x (16 - 120) | 1 x (35 - 300)<br>2 x (35 - 120) | –  |
| Flat conductor                             | Number of layers x width x thickness | mm              | 6 x 9 x 0.8                      | –             | –              | 2 x (11 x 21 x 1)                | 1 x (6 x 16 x 0.8)<br>2 x (20 x 32 x 0.5)<br>2 x (11 x 21 x 1) |
| Tightening torque                          |                                      | Nm              | 4                                | 4             | 14             | 14                               | 6  |
| Terminal capacity of control circuit cable |                                      |                 |                                  |               |                |                                  |  |
| Solid                                      |                                      | mm <sup>2</sup> | –                                | –             | –              | –                                | 1 x (0.75 - 4)<br>2 x (0.75 - 4)                               |
| Flexible with ferrule                      |                                      | mm <sup>2</sup> | –                                | –             | –              | –                                | 1 x (0.75 - 2.5)<br>2 x (0.75 - 2.5)                           |
| Tools                                      |                                      |                 |                                  |               |                |                                  |  |
| Pozidriv screwdriver                       |                                      | Size            | 2                                | 2             | –              | –                                | –  |
| Internal hexagon                           | SW                                   | mm              | –                                | –             | 5              | 6                                | 5  |
| Conventional thermal current               |                                      |                 |                                  |               |                |                                  |  |
| 3 pole                                     | I <sub>th</sub>                      | A               | 50                               | 100           | 180            | 400                              | 700  |
| 4 pole                                     | I <sub>th</sub>                      | A               | 60                               | –             | –              | –                                | –  |



# 1.1

## Contactors

Minicontactor relay, contactor combination

### Dimensions

#### 1 Mini contactor relays

DILER-...(-C)  
DILER-...-G(-C)

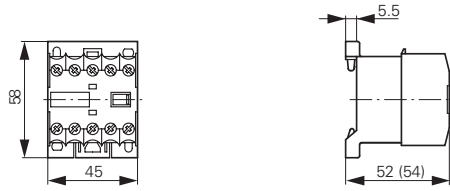

DILER-...(-C) + ...DILE(-C)  
DILER-...-G(-C) + ...DILE(-C)

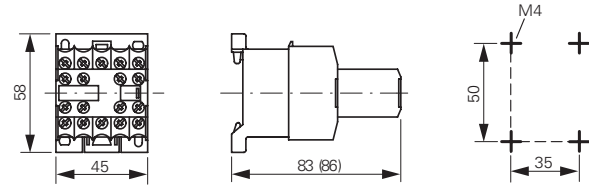

DILEEM-..., DILEM-...(-C), DILEM-12-...  
DILEEM-...-G, DILEM-...-G(-C), DILEM-12-...-G

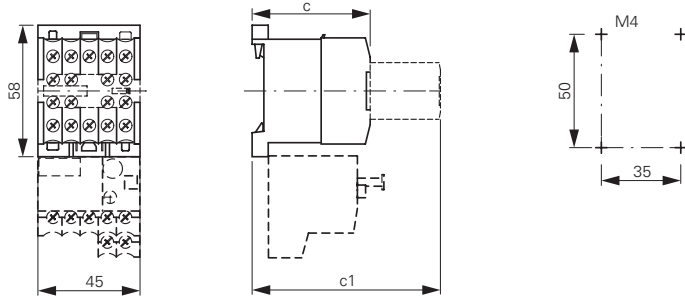

| Part no.           | c  | c1 |
|--------------------|----|----|
| DILE(E)M-...(-G)   | 52 | 83 |
| DILE(E)M-...-G(-C) | 54 | 86 |

DILER-... + HDILE  
DILER-...-G + HDILE



### Suppressor circuit

RCDILE...  
VGDILE

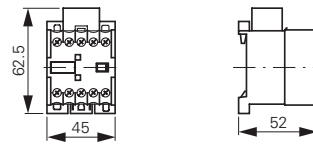

2DILE-... + MVDILE  
2DILE-...-G + MVDILE

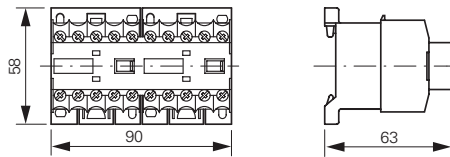

2DILE-... + MVDILE + ...DILE  
2DILE-...-G + MVDILE + ...DILE

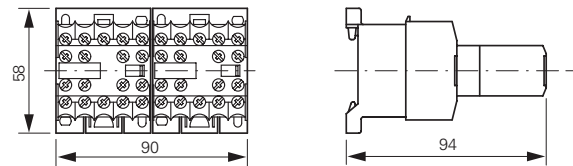

### Star-delta contactors

DIULEM

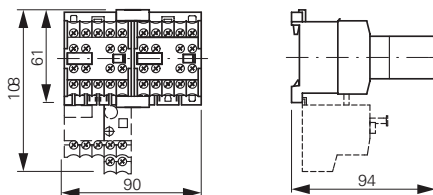

### Star-delta contactors

SDAINLEM

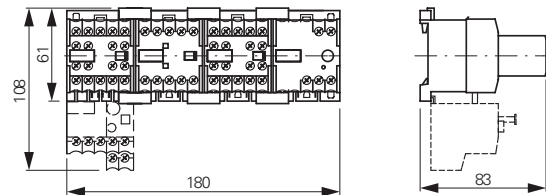

DILER-... + TDDILE24

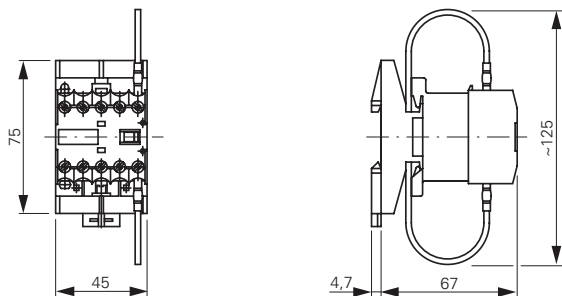

### Parallel connector

P1DILEM

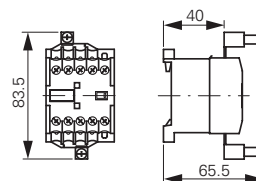

## Contactor with auxiliary contact module

DILM7...DILM15

DILA...

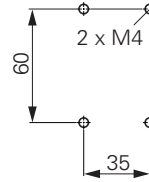
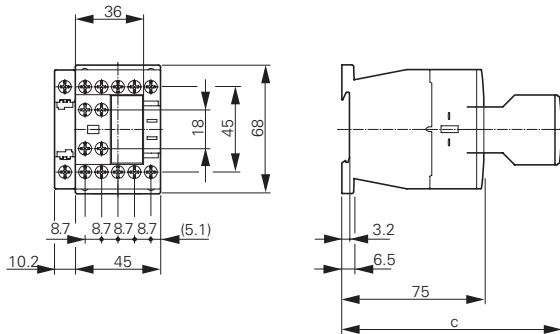

| Part no.     | c   |
|--------------|-----|
| DILM32-XHI   | 117 |
| DILA-XHI     | 117 |
| DILA-XHI...T | 125 |

DILMC7...DILMC15

DILAC...

DILA-XHIC...

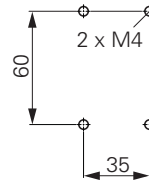
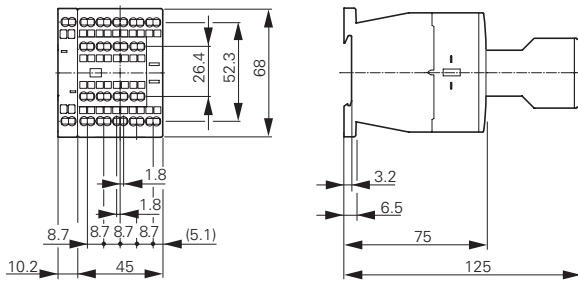

DILM17...DILM38

DILMC17...DILMC32

DILMF8...DILMF32

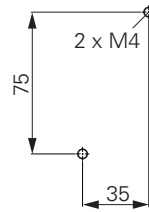
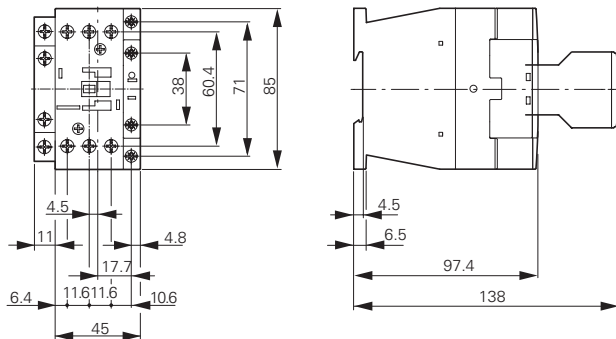

Clearance at side to grounded parts: 6 mm

# 1.1

## Contactors

Basic devices up to 170 A, suppressor circuit

### 1 Contactors

DILM40...DILM72  
DILMC40...DILMC65  
DILMF40...DILMF65

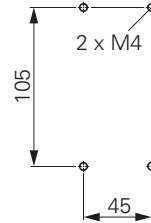
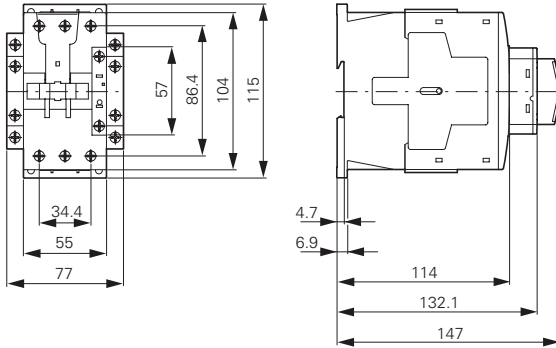

Clearance at side to grounded parts: 6 mm

DILM80...DILM170  
DILMC80...DILMC150  
DILMF80...DILMF150

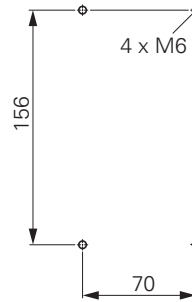
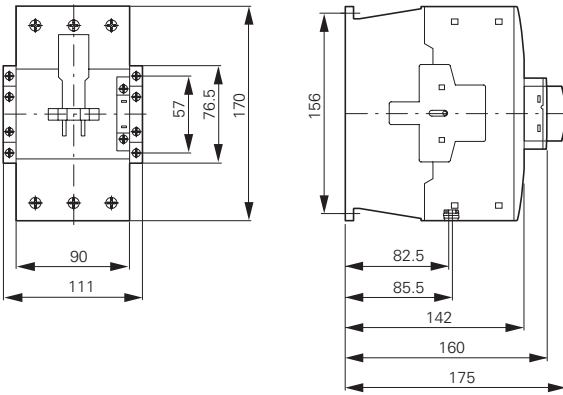

Clearance at side to grounded parts: 10 mm

### Suppressor circuits

DILM...XSP...

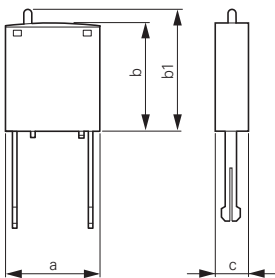

| Part no.      | a  | b  | b1  | c |
|---------------|----|----|-----|---|
| DILM12-XSP... | 25 | 28 | ≈32 | 9 |
| DILM32-XSP... | 25 | 28 | ≈32 | 9 |
| DILM95-XSP... | 25 | 28 | ≈32 | 9 |

**Contactor with auxiliary contact module**

DILMP20

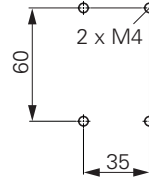
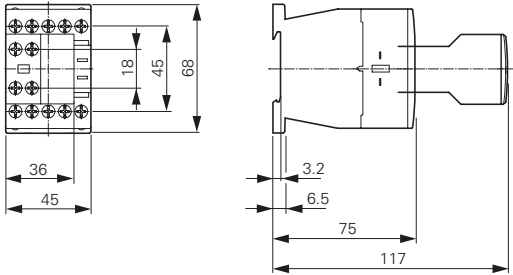

DILMP32 DILMP45

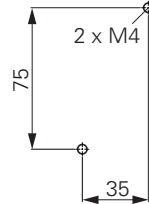
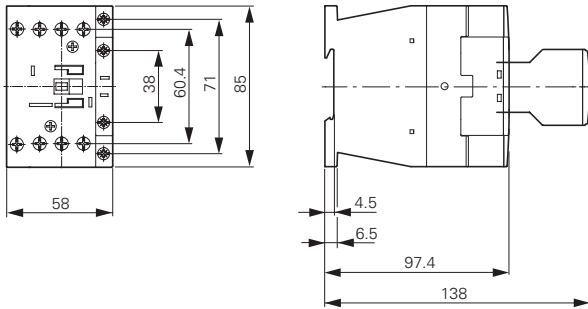

Distance at side to grounded parts: 6 mm

**Contactors**

DILMP63 DILMP80

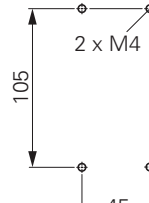
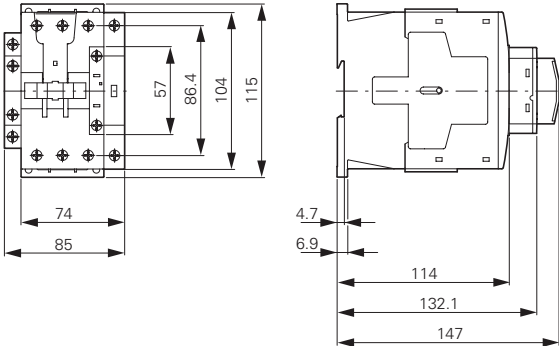

Distance at side to grounded parts: 6 mm

DILMP125 DILMP160 DILMP200

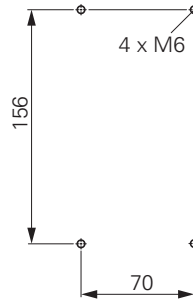
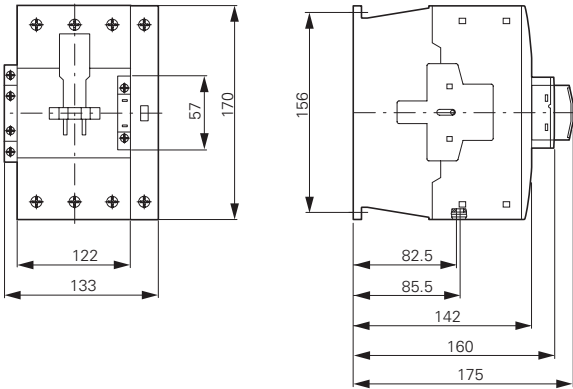

Clearance at side to earthed parts: 10 mm

**Motor suppressor module**

DILM12-XMSM

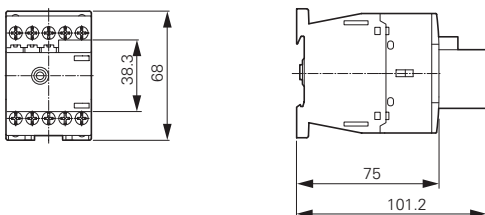

# 1.1

## Contactors

Complete units for currents greater than 170 A

### 1 Complete units

DILM185A...DILM500  
DILM250-S...DILM570-S

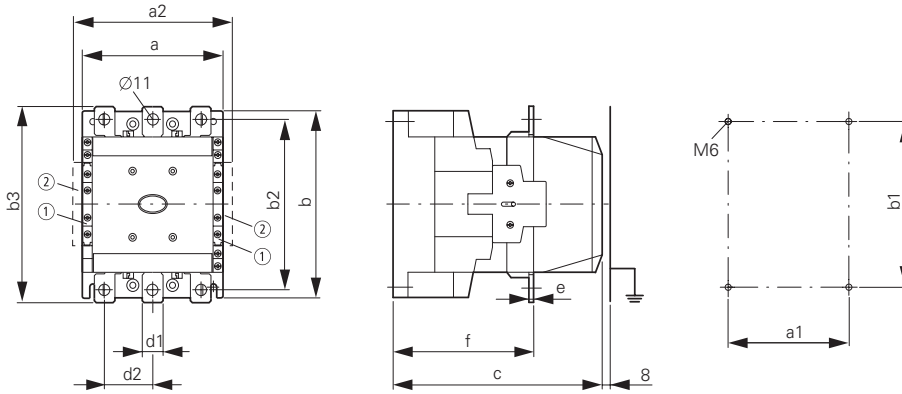

- ① DILM1000-XHI...-SI
- ② DILM1000-XHI11-SA

| Part no. | a   | a1  | a2  | b   | b1  | b2  | b3  | d1 | d2 | e | c   | f   |
|----------|-----|-----|-----|-----|-----|-----|-----|----|----|---|-----|-----|
| DILM185A | 140 | 120 | 160 | 180 | 160 | 165 | 190 | 20 | 41 | 5 | 158 | 83  |
| DILM225A | 140 | 120 | 160 | 180 | 160 | 165 | 190 | 20 | 41 | 5 | 158 | 83  |
| DILM250  | 140 | 120 | 160 | 180 | 160 | 164 | 189 | 25 | 48 | 5 | 208 | 140 |
| DILM300A | 140 | 120 | 160 | 180 | 160 | 164 | 189 | 25 | 48 | 5 | 208 | 140 |
| DILM400  | 160 | 130 | 180 | 200 | 180 | 184 | 209 | 25 | 48 | 6 | 216 | 140 |
| DILM500  | 160 | 130 | 180 | 200 | 180 | 189 | 219 | 38 | 57 | 6 | 216 | 140 |
| DILM570  | 160 | 130 | 180 | 200 | 180 | 189 | 219 | 38 | 57 | 6 | 216 | 140 |

DILM580...DILM1000

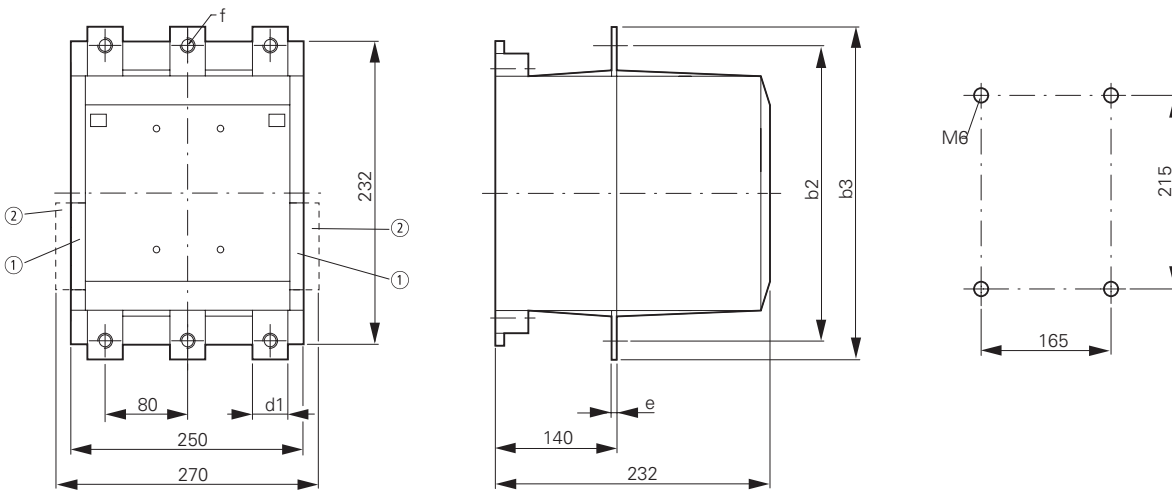

- ① DILM820-XHI...-SI
- ② DILM820-XHI11-SA

| Part no. | b2  | b3  | d1 | e  | f    |
|----------|-----|-----|----|----|------|
| DILM580  | 256 | 296 | 45 | 6  | 13.5 |
| DILM650  | 256 | 296 | 45 | 6  | 13.5 |
| DILM750  | 256 | 296 | 45 | 6  | 13.5 |
| DILM820  | 256 | 296 | 45 | 6  | 13.5 |
| DILM1000 | 256 | 296 | 45 | 10 | 13.5 |

AC-1 contactors greater than 1000 A

DILH1400

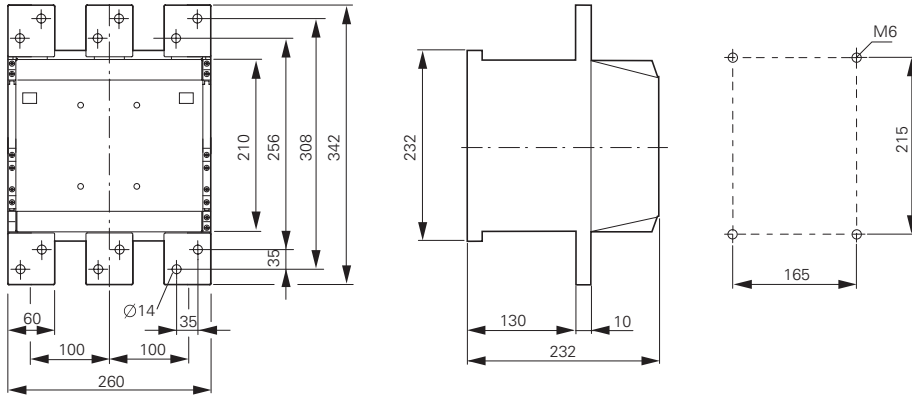

DILM1600

DILH2000

DILH2200

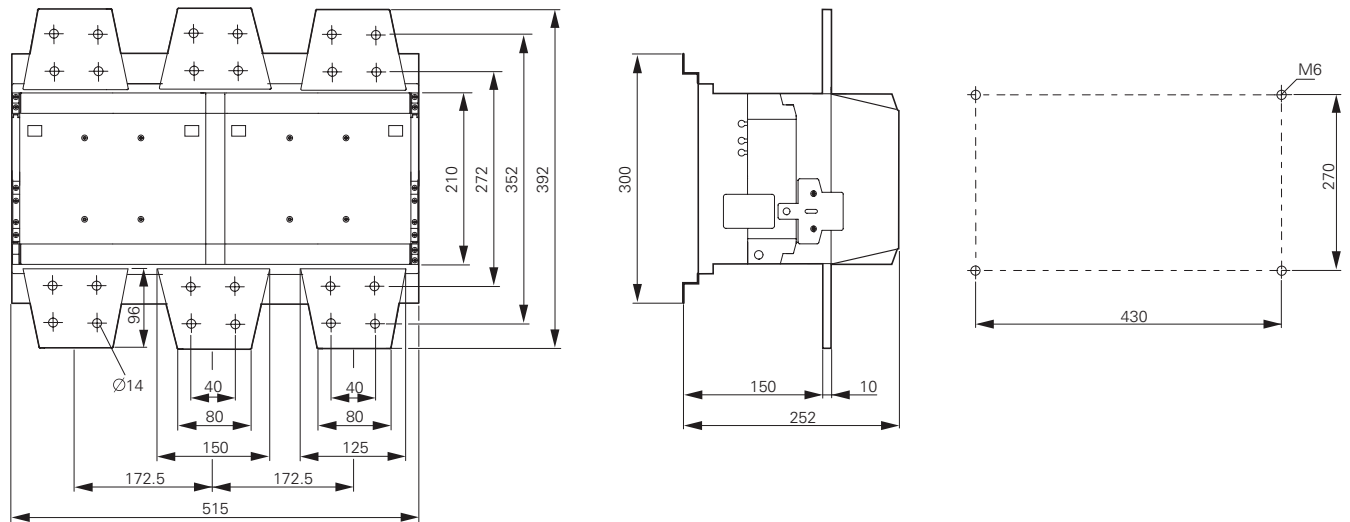

DILH2600

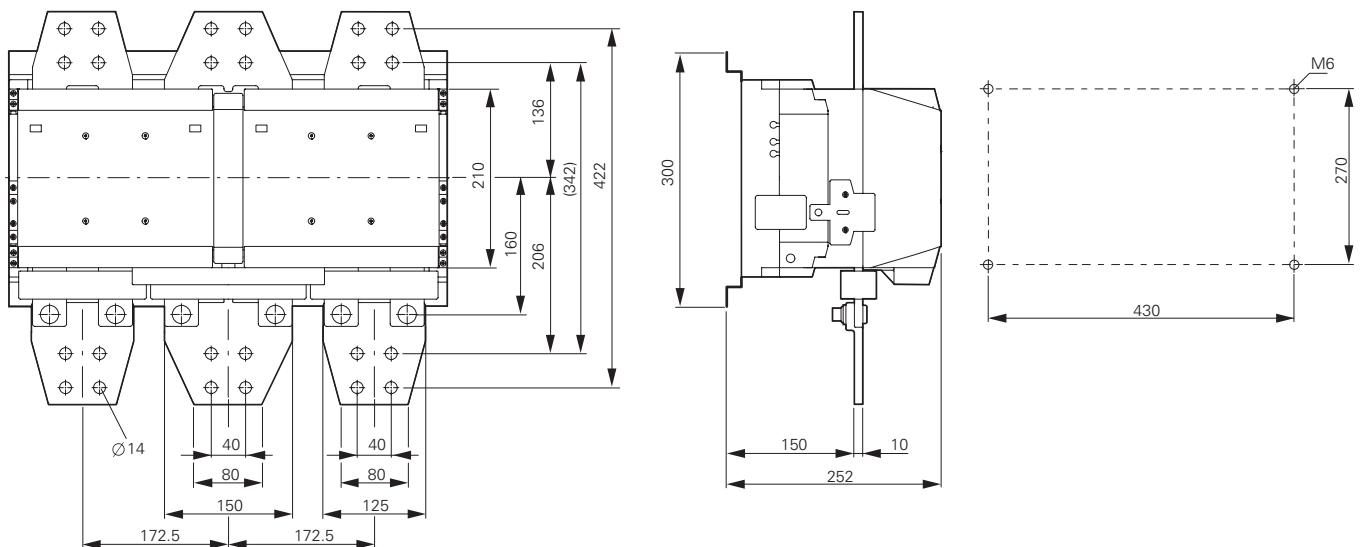

# 1.1

## Contactors

Capacitor contactors, lamp contactors, contactor monitoring devices, SWD contactor modules

### 1 Contactor for capacitors

DILK...

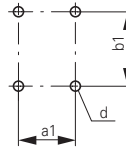
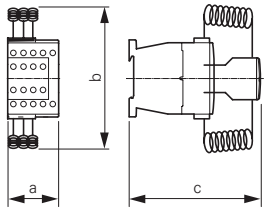

| Part no. | a  | b   | c   | a1 | b1  | d      |
|----------|----|-----|-----|----|-----|--------|
| DILK12   | 45 | 135 | 138 | 35 | 75  | 2 x M4 |
| DILK20   | 45 | 135 | 138 | 35 | 75  | 2 x M4 |
| DILK25   | 45 | 135 | 138 | 35 | 75  | 2 x M4 |
| DILK33   | 55 | 190 | 147 | 45 | 105 | 2 x M4 |
| DILK50   | 55 | 190 | 147 | 45 | 105 | 2 x M4 |

### Illumination contactors

DILL...

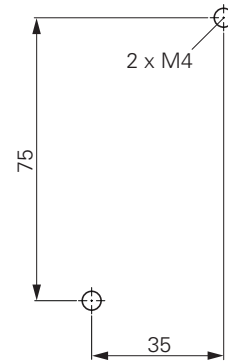
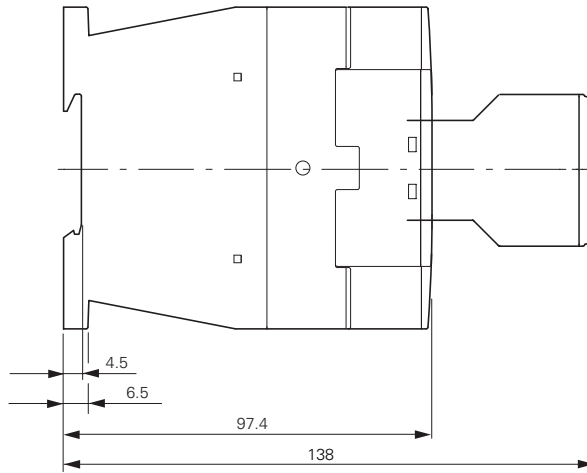
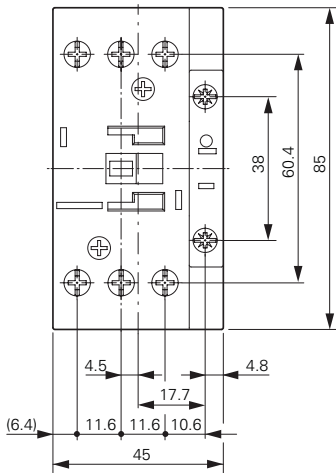

Clearance at side to grounded parts: 6 mm

### Contactor monitoring devices

CMD(...)

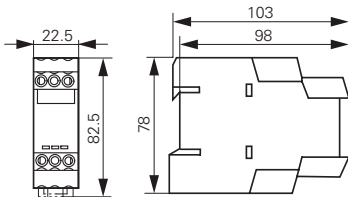

### SWD contactor modules

DIL-SWD-32...

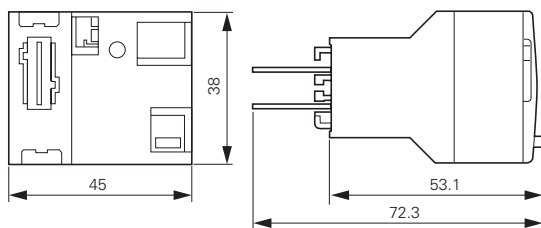

**Star-delta contactors**

SDAINLM12...SDAINLM115

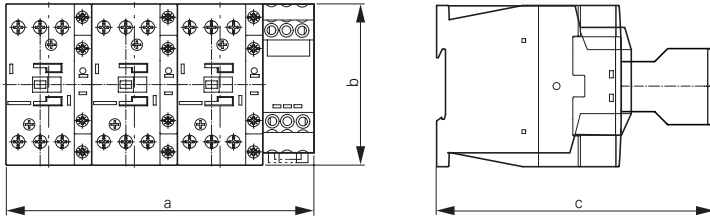

| Part no.        | a   | b   | c   |
|-----------------|-----|-----|-----|
| SDAINLM12...22  | 158 | 68  | 117 |
| SDAINLM30...55  | 158 | 85  | 138 |
| SDAINLM70...115 | 188 | 115 | 147 |

SDAINLM140...SDAINLM260

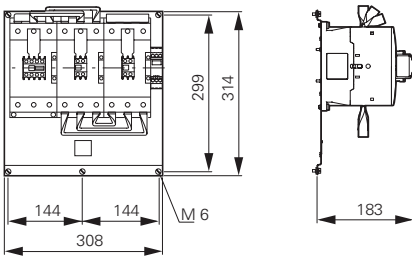

**Reversing contactors**

DIULM7...DIULM65

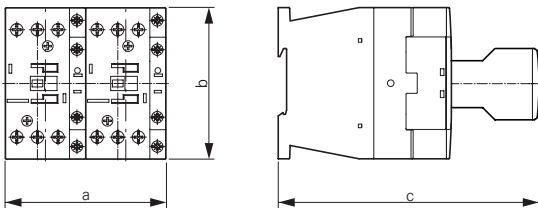

| Part no.           | a   | b   | c   |
|--------------------|-----|-----|-----|
| DIULM7/21...12/21  | 90  | 68  | 117 |
| DIULM17/21...32/21 | 90  | 85  | 138 |
| DIULM40/11...65/11 | 110 | 115 | 147 |

DIULM80...DIULM150

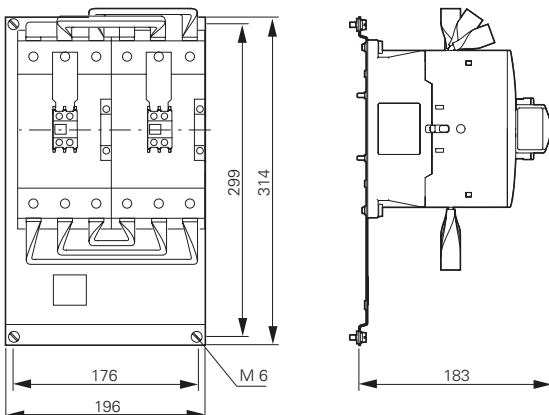



# 1.1 Contactors

## Accessories

### 1 Three-phase commoning links

DILM12-XDSB...

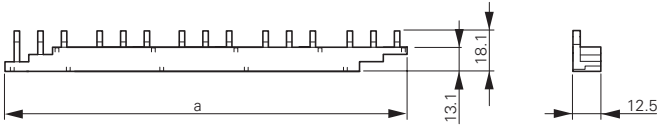

| Part no.       | a   |
|----------------|-----|
| DILM12-XDSB0/3 | 112 |
| DILM12-XDSB0/4 | 157 |
| DILM12-XDSB0/5 | 202 |

### Electronic timer modules

DILM...XTE

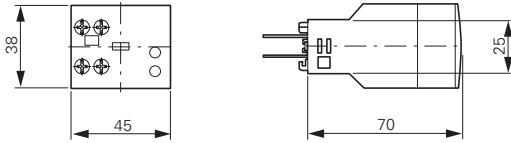

### Amplifier module

ETS4-VS3

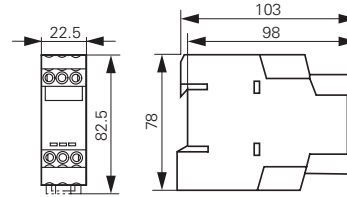

### Wiring set for motor feeder plug

DILM12-XMCE

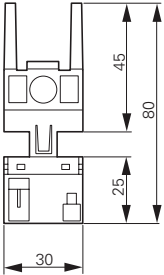
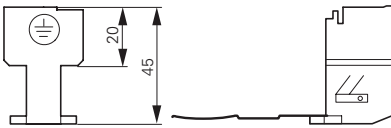

DILM12-XMCP/T

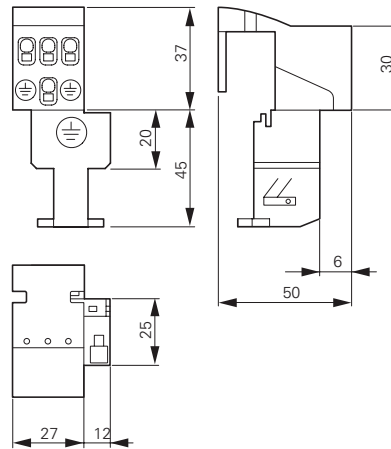

DILM12-XMCP/E

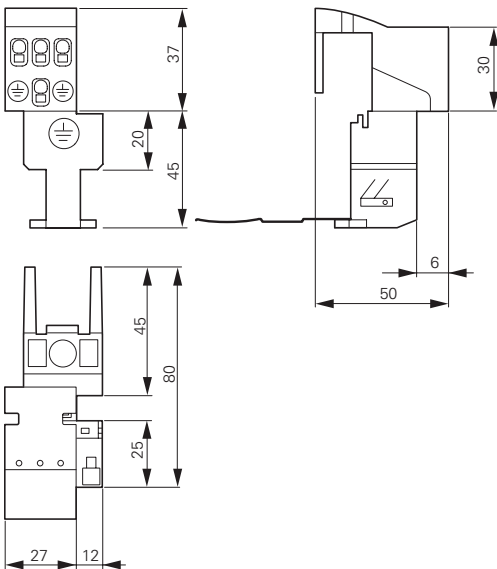

**Contactors with terminal shrouds**

DILM250...DILM1000 + DILM...-XHB

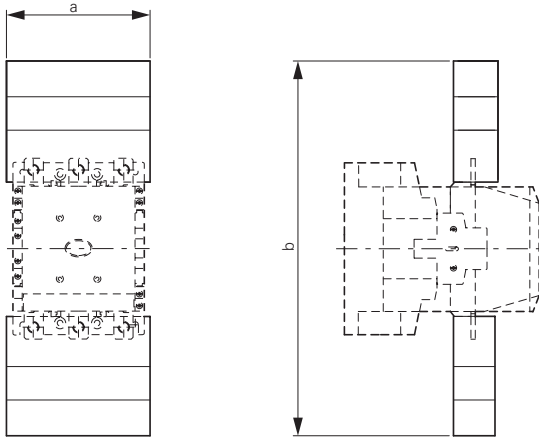

| for part no.      | a   | b   |
|-------------------|-----|-----|
| DILM250, DILM300A | 150 | 384 |
| DILM400           | 150 | 404 |
| DILM500           | 174 | 426 |
| DILM580...1000    | 236 | 506 |

DILM250 + Z5-.../FF250

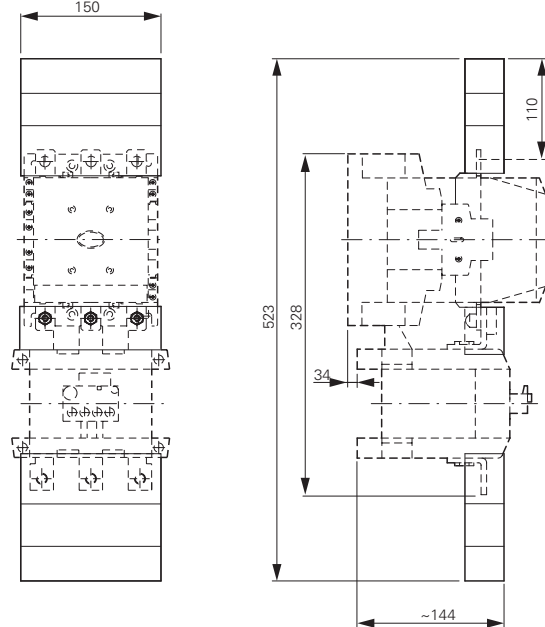

DILM185A...DILM225A + DILM225A-XHB

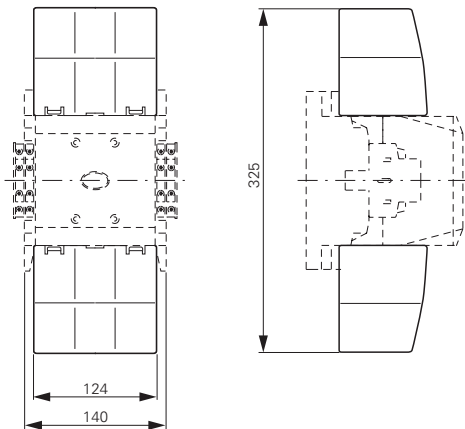

**Contactor with star-point bridge and terminal shroud**

DILM...XS1

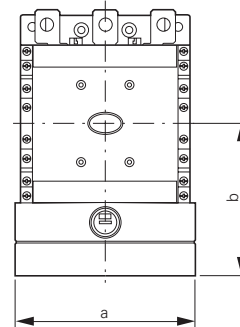

| for part no.  | a   | b   |
|---------------|-----|-----|
| DILM185...250 | 150 | 127 |
| DILM300...400 | 150 | 137 |
| DILM500       | 176 | 146 |

**Mechanical interlock**

DILM500-XMV

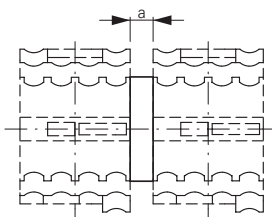

| for part no.  | a  |
|---------------|----|
| DILM185...500 | 15 |

DILM820-XMV

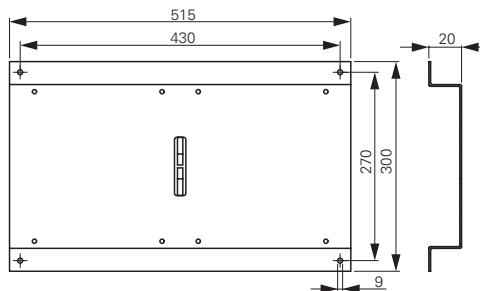



# Overload relay

Motor protection is a central task of electrical equipment for machinery. From cost-effective bimetal solutions to demanding full motor protection with cross-linkage - we offer the right solution for each application.

**ATEX** 

## Bimetal relay - overload relay up to 630 A

- Direct mounting on contactor saves mounting time.
- ATEX approval for the protection of EEx e motors up to 250 A.
- Comprehensive motor protection through phase failure sensitivity.
- Integrated test pushbutton facilitates high safety → Page 6.



## ZEB electronic overload relay - overload relay up to 1500 A

- ATEX approval for protection of EEx e motors up to 1500 A.
- Adjustable tripping classes.
- Phase failure and unbalance protection.
- Optional earth fault detection.
- Additional current setting range (5:1) → Page 14.

## EMT6 thermistor overload relay for machine protection

- Overload protection through direct evaluation of winding temperature.
- Quick detection of operating state through LED display.
- Suitable for overload monitoring of motors in EEx e range.
- Wide range power supply reduces amount of types → Page 19.



## Technical overview

|   |   |
|---|---|
| Bimetal relay ZE, ZB, Z5 . . . . .                              | 2 |
| Overload relay ZW7 . . . . .                                    | 2 |
| Electronic overload relays ZEB . . . . .                        | 4 |
| EMT6 thermistor overload relay for machine protection . . . . . | 4 |

## Ordering

|  |    |
|--|----|
| Bimetal relays for mini-contactor relays . . . . . | 6  |
| Bimetal relays up to 150 A . . . . .               | 8  |
| Bimetal relay greater than 150 A . . . . .         | 12 |
| Overload relays . . . . .                          | 12 |
| Bimetal relay accessories . . . . .                | 21 |
| ZEB electronic overload relay . . . . .            | 14 |

## Ordering

|   |    |
|---|----|
| EMT6 thermistor overload relay for machine protection . . . . . | 19 |
|---|----|

## Engineering

|   |    |
|---|----|
| EMT6 thermistor overload relay for machine protection . . . . . | 20 |
| Selection criteria ZE, ZB, Z5, ZW7 . . . . .                    | 23 |
| Characteristic curve ZB, Z5, ZW7 . . . . .                      | 23 |
| UL/CSA short-circuit strength ZE, ZB, Z5 . . . . .              | 24 |

## Technical data

|   |    |
|---|----|
| Bimetal relay for mini-contactor relays . . . . .               | 25 |
| Bimetal relays up to 150A . . . . .                             | 25 |
| Overload relays greater than 150 A . . . . .                    | 26 |
| Overload relays . . . . .                                       | 26 |
| ZEB electronic overload relay . . . . .                         | 28 |
| EMT6 thermistor overload relay for machine protection . . . . . | 29 |

## Dimensions

|   |    |
|---|----|
| Bimetal relays for mini-contactor relays . . . . .              | 30 |
| Bimetal relays up to 150A . . . . .                             | 30 |
| Bimetal relays greater than 150 A . . . . .                     | 32 |
| Overload relay . . . . .  | 32 |
| ZEB electronic overload relay . . . . .                         | 33 |
| EMT6 thermistor overload relay for machine protection . . . . . | 35 |

# 1.2

## Overload relays

Overload relays, CT-operated overload relays

### 1 Technical overview

#### Overload relays, CT-operated overload relays

Setting ranges (A)  
(note max. current of the contactor)



DILEM

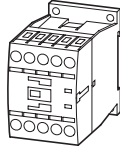

DILM7 DILM12  
DILM9 DILM15

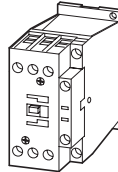

DILM17 DILM32  
DILM25 DILM38

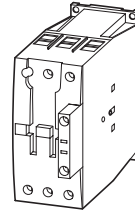

DILM40 DILM65  
DILM50 DILM72

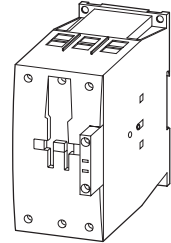

DILM80 DILM150  
DILM95 DILM170  
DILM115

#### Overload relays

**ZE**  
0.1-12

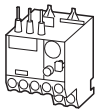

**ZB12**  
0.1-16

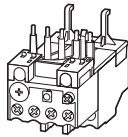

**ZB32**  
0.1-38

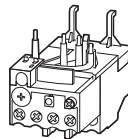

**ZB65**  
6-75

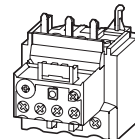

**ZB150**  
35-175

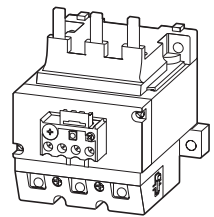

**Z5-.../FF225A**  
70-250

**Z5-.../FF250**  
50-300

#### Current transformer-operated overload relay

**ZW7-...**  
42-630

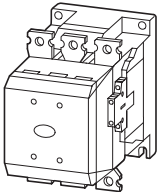

**DILM185A**  
**DILM225A**

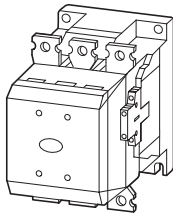

**DILM250**  
**DILM300**

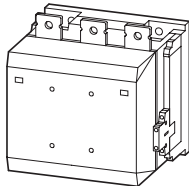

**DILM400 DILM580**  
**DILM500**

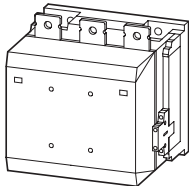

**DILM650**

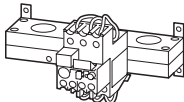
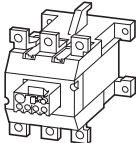
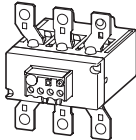

# 1.2

## Overload relays

Electronic overload relays, thermistor overload relay for machine protection

### 1 Electronic overload relays, thermistor overload relay for machine protection

Setting ranges (A)  
(note max. current of the contactor)



**DILEM**

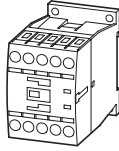

**DILM7 DILM12  
DILM9 DILM15**

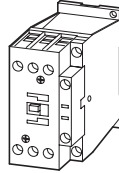

**DILM17 DILM32  
DILM25 DILM38**

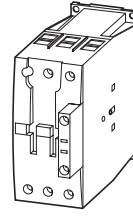

**DILM40 DILM65  
DILM50 DILM72**

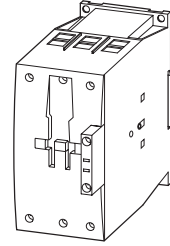

**DILM80 DILM150  
DILM95 DILM170  
DILM115**

#### Electronic overload relays

**ZEB12**  
0.33-20

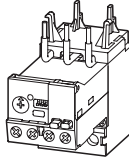

**ZEB32**  
0.33-45

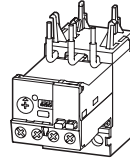

**ZEB65**  
9-100

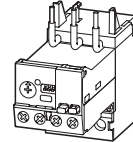

**ZEB150**  
20-100

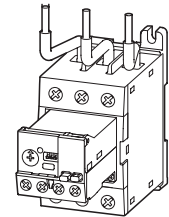

#### ZEB32-5-(GF)/KK combined with

**ZEB-XCT300**  
60-300

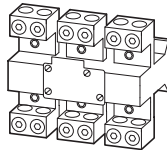

**ZEB-XCT600**  
120-600

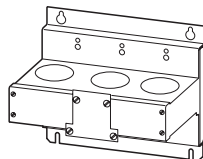

**ZEB-XCT1000**  
200-1000

**ZEB-XCT1500**  
300-1500

#### Thermistor overload relay for machine protection

**EMT6((DB)K)**

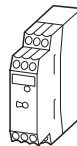

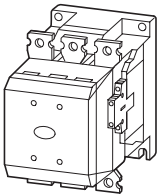

DILM185A  
DILM225A

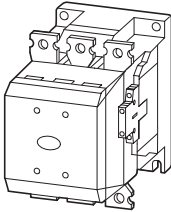

DILM250  
DILM300

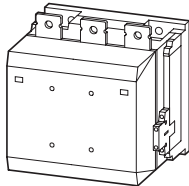

DILM400 DILM500  
DILM580 DILM650

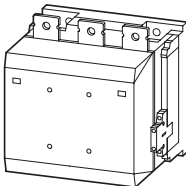

DILM750 DILM820

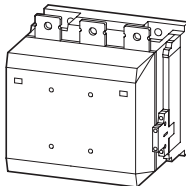

DILM1000

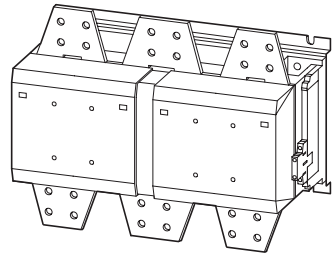

DILM1600





# 1.2

## Overload relays

Bimetal relays for mini-contactor relays

### 1 Ordering

#### ZE overload relays for mini contactor relays

- Phase failure sensitivity to IEC/EN 60947, VDE 0660 Part 102
- Test/off pushbutton
- Reset pushbutton manual/auto
- Trip-free release
- Direct mounting

| Setting range of overload releases | Circuit symbol | Auxiliary contact   |      | For use with                      | Short-circuit protection            |                                     |
|------------------------------------|----------------|---|------|-----------------------------------|-------------------------------------|-------------------------------------|
|                                    |                | N/O = normally open contact<br>NC = normally closed contact |      |                                   | Type "1" coordination<br>gG/gL<br>A | Type "2" coordination<br>gG/gL<br>A |
| $I_r$<br>A<br>                     |                |   |      |                                   |                                     |                                     |
| 0.1 – 0.16                         |                | 1 N/O   | 1 NC | DILEM<br>DIULEM/21/MV<br>SDAINLEM | 20                                  | 0.5                                 |
| 0.16 – 0.24                        |                | 1 N/O   | 1 NC |                                   | 20                                  | 1                                   |
| 0.24 – 0.4                         |                | 1 N/O   | 1 NC |                                   | 20                                  | 2                                   |
| 0.4 – 0.6                          |                | 1 N/O   | 1 NC |                                   | 20                                  | 2                                   |
| 0.6 – 1                            |                | 1 N/O   | 1 NC |                                   | 20                                  | 4                                   |
| 1 – 1.6                            |                | 1 N/O   | 1 NC |                                   | 20                                  | 6                                   |
| 1.6 – 2.4                          |                | 1 N/O   | 1 NC |                                   | 20                                  | 6                                   |
| 2.4 – 4                            |                | 1 N/O   | 1 NC |                                   | 20                                  | 10                                  |
| 4 – 6                              |                | 1 N/O   | 1 NC |                                   | 20                                  | 10                                  |
| 6 – 9                              |                | 1 N/O   | 1 NC |                                   | 20                                  | 10                                  |
| 9 – 12                             |                | 1 N/O   | 1 NC |                                   | 20                                  | 10                                  |



#### Information relevant for export to North America

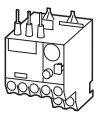

|                      |   |
|----------------------|---|
| Product Standards    | UL 508; CSA-C22.2 No.14; IEC/EN 60947-4-1; CE marking |
| UL File No.          | E29184  |
| UL CCN               | NKCR  |
| CSA File No.         | 12528   |
| CSA Class No.        | 3211-03   |
| NA Certification     | UL Listed, CSA certified                              |
| Suitable for         | Branch circuits                                       |
| Max. Voltage Rating  | 600 V AC  |
| Degree of Protection | IEC: IP20, UL/CSA Type: -                             |
| See also             | → Page 24   |



| Part no.<br>Article no. | Price<br>See price list | Std. pack | Notes |
|-------------------------|-------------------------|-----------|-------|
|-------------------------|-------------------------|-----------|-------|

|                          |   |       |   |
|--------------------------|---|-------|---|
| <b>ZE-0.16</b><br>014263 |  | 1 Off | Overload release: tripping class 10 A<br>Short-circuit protection: With direct mounting, observe the maximum permissible fuse of the contactor. |
| <b>ZE-0.24</b><br>014285 |   |       |   |
| <b>ZE-0.4</b><br>014300  |   |       | Suitable for protection of EEx e motors   |
| <b>ZE-0.6</b><br>014333  |   |       |  II (2) GD<br>PTB 01 ATEX 3331                                 |
| <b>ZE-1.0</b><br>014376  |   |       | Observe manual AWB2300-1425D/GB.  |
| <b>ZE-1.6</b><br>014432  |   |       |   |
| <b>ZE-2.4</b><br>014479  |   |       |   |
| <b>ZE-4</b><br>014518    |   |       |   |
| <b>ZE-6</b><br>014565    |   |       |   |
| <b>ZE-9</b><br>014708    |   |       |   |
| <b>ZE-12</b><br>014752   |   |       |   |

With side-by-side mounting, there must be a minimum clearance of 5 mm between overload relays.

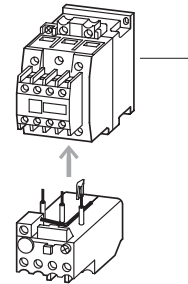

1 Contactor → Chapter 1.1  
 Accessories → Page 21  
 Manual → Page 21

# 1.2

## Overload relays

Overload relays up to 150A

1

### ZB12, ZB32

Setting range of overload releases

Circuit symbol

Auxiliary contact

For use with

Short-circuit protection

$I_r$

A



N/O = normally open contact  
NC = normally closed contact

Contactors

Soft starters

Type "1" coordination

gG/gL

A



Type "2" coordination

gG/gL

A



#### ZB12 overload relay

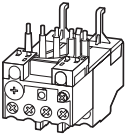

| Setting range of overload releases | Circuit symbol | Auxiliary contact | For use with   | Soft starters | Type "1" coordination | Type "2" coordination |
|------------------------------------|----------------|-------------------|--|---------------|-----------------------|-----------------------|
| 0.1 – 0.16                         |                | 1 N/O 1 NC        | DILM7, DILM9, DILM12, DILM15, DIULM7, DIULM9, DIULM12, SDAINLM12, SDAINLM16, SDAINLM22 | –             | 25                    | 0.5                   |
| 0.16 – 0.24                        |                | 1 N/O 1 NC        | –  | 25            | 1                     |                       |
| 0.24 – 0.4                         |                | 1 N/O 1 NC        | –  | 25            | 2                     |                       |
| 0.4 – 0.6                          |                | 1 N/O 1 NC        | –  | 25            | 4                     |                       |
| 0.6 – 1                            |                | 1 N/O 1 NC        | –  | 25            | 4                     |                       |
| 1 – 1.6                            |                | 1 N/O 1 NC        | –  | 25            | 6                     |                       |
| 1.6 – 2.4                          |                | 1 N/O 1 NC        | –  | 25            | 10                    |                       |
| 2.4 – 4                            |                | 1 N/O 1 NC        | DS7-34...SX004...  | 25            | 16                    |                       |
| 4 – 6                              |                | 1 N/O 1 NC        | DS7-34...SX005...  | 25            | 20                    |                       |
| 6 – 10                             |                | 1 N/O 1 NC        | DS7-34...SX007...<br>DS7-34...SX009...   | 50            | 25                    |                       |
| 9 – 12                             |                | 1 N/O 1 NC        | DS7-34...SX012...  | 50            | 25                    |                       |
| 12 – 16                            |                | 1 N/O 1 NC        | –  | 50            | 25                    |                       |

#### ZB32 overload relay

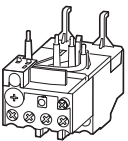

| Setting range of overload releases | Circuit symbol | Auxiliary contact | For use with  | Soft starters | Type "1" coordination | Type "2" coordination |
|------------------------------------|----------------|-------------------|---|---------------|-----------------------|-----------------------|
| 0.1 – 0.16                         |                | 1 N/O 1 NC        | DILM17, DILM25, DILM32, DILM38, DILMF8, DILMF11, DILMF14, DILMF17, DILMF25, DILMF32, DIULM17, DIULM25, DIULM32, SDAINLM30, SDAINLM45, SDAINLM55 | –             | 25                    | 0.5                   |
| 0.16 – 0.24                        |                | 1 N/O 1 NC        | –   | 25            | 1                     |                       |
| 0.24 – 0.4                         |                | 1 N/O 1 NC        | –   | 25            | 2                     |                       |
| 0.4 – 0.6                          |                | 1 N/O 1 NC        | –   | 25            | 4                     |                       |
| 0.6 – 1                            |                | 1 N/O 1 NC        | –   | 25            | 4                     |                       |
| 1 – 1.6                            |                | 1 N/O 1 NC        | –   | 25            | 6                     |                       |
| 1.6 – 2.4                          |                | 1 N/O 1 NC        | –   | 25            | 10                    |                       |
| 2.4 – 4                            |                | 1 N/O 1 NC        | –   | 25            | 16                    |                       |
| 4 – 6                              |                | 1 N/O 1 NC        | –   | 25            | 20                    |                       |
| 6 – 10                             |                | 1 N/O 1 NC        | –   | 50            | 25                    |                       |
| 10 – 16                            |                | 1 N/O 1 NC        | DS7-34...SX016...   | 63            | 35                    |                       |
| 16 – 24                            |                | 1 N/O 1 NC        | DS7-34...SX024...   | 100           | 35                    |                       |
| 24 – 32                            |                | 1 N/O 1 NC        | DS7-34...SX032...   | 125           | 63                    |                       |
| 32 – 38                            |                | 1 N/O 1 NC        | –   | 125           | 63                    |                       |

#### Information relevant for export to North America



Product Standards  
UL File No.  
UL CCN  
CSA File No.  
CSA Class No.

UL 508; CSA-C22.2 No.14; IEC/EN  
60947-4-1; CE marking  
E29184  
NKCR  
12528  
3211-03

NA Certification  
Suitable for  
Max. Voltage Rating  
Degree of Protection  
See also



UL Listed, CSA certified  
Branch circuits  
600 V AC  
IEC: IP20, UL/CSA Type: -  
→ Page 24

**Part no.**  
Article no.

**Price**  
See price list

**Std. pack**

**Notes**

|                            |   |  |
|----------------------------|---|--|
| <b>ZB12-0,16</b><br>278431 |  | <p>1 Off</p> <p>Overload release: tripping class 10 A<br/>Short-circuit protection: With direct mounting, observe the maximum permissible fuse of the contactor.</p> <p>Suitable for protection of EEx e motors.</p> <p> II (2) GD<br/>PTB 04 ATEX 3022</p> <p>Observe manual AWB2300-1527D/GB.</p> <ul style="list-style-type: none"> <li>Phase failure sensitivity to IEC/EN 60947, VDE 0660 Part 102</li> <li>Test/off pushbutton</li> <li>Reset pushbutton manual/auto</li> <li>Trip-free release</li> <li>Direct mounting</li> </ul> |
| <b>ZB12-0,24</b><br>278432 |   |  |
| <b>ZB12-0,4</b><br>278433  |   |  |
| <b>ZB12-0,6</b><br>278434  |   |  |
| <b>ZB12-1</b><br>278435    |   |  |
| <b>ZB12-1,6</b><br>278436  |   |  |
| <b>ZB12-2,4</b><br>278437  |   |  |
| <b>ZB12-4</b><br>278438    |   |  |
| <b>ZB12-6</b><br>278439    |   |  |
| <b>ZB12-10</b><br>278440   |   |  |
| <b>ZB12-12</b><br>278441   |   |  |
| <b>ZB12-16</b><br>290168   |   |  |
| <b>ZB32-0,16</b><br>278442 |   |  |
| <b>ZB32-0,24</b><br>278443 |   |  |
| <b>ZB32-0,4</b><br>278444  |   |  |
| <b>ZB32-0,6</b><br>278445  |   |  |
| <b>ZB32-1</b><br>278446    |   |  |
| <b>ZB32-1,6</b><br>278447  |   |  |
| <b>ZB32-2,4</b><br>278448  |   |  |
| <b>ZB32-4</b><br>278449    |   |  |
| <b>ZB32-6</b><br>278450    |   |  |
| <b>ZB32-10</b><br>278451   |   |  |
| <b>ZB32-16</b><br>278452   |   |  |
| <b>ZB32-24</b><br>278453   |   |  |
| <b>ZB32-32</b><br>278454   |   |  |
| <b>ZB32-38</b><br>112474   |   |  |

Fitted directly to the contactor

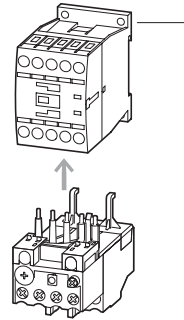

1 Contactor → Chapter 1.1  
Accessories → Page 21  
Manual → Page 21

Fitted directly to the contactor

Separate mounting

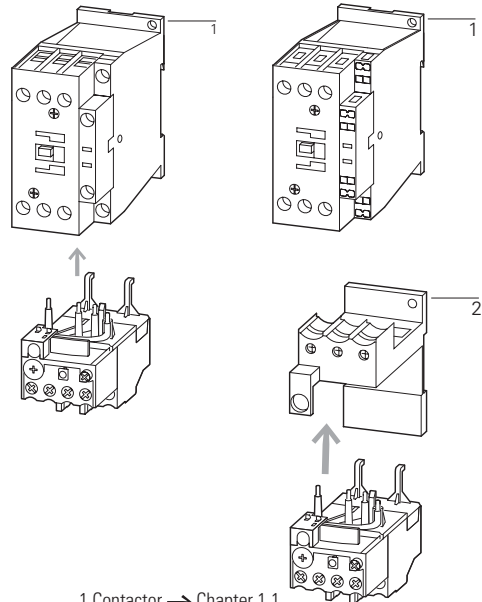

1 Contactor → Chapter 1.1  
2 Base → Page 21  
Manual → Page 21

# 1.2

## Overload relays

Overload relays up to 150A

1

### ZB65, ZB150

Setting range of overload releases

Circuit symbol

Auxiliary contact

For use with

Short-circuit protection



N/O = normally open contact  
NC = normally closed contact

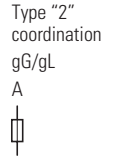
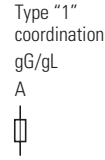

#### ZB65 overload relay

- Phase failure sensitivity to IEC/EN 60947, VDE 0660 Part 102
- Test/off pushbutton
- Reset pushbutton manual/auto
- Trip-free release
- Direct mounting

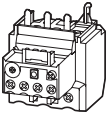

| Setting range of overload releases | Circuit symbol | Auxiliary contact | For use with   | Type "1" coordination gG/gL A | Type "2" coordination gG/gL A |
|------------------------------------|----------------|-------------------|--|-------------------------------|-------------------------------|
| 6 – 10                             |                | 1 N/O 1 NC        | DILM40, DILM50, DILM65, DILM72, DILMF40, DILMF50, DILMF65, DIULM40, DIULM50, DIULM65, SDAINLM70, SDAINLM90, SDAINLM115 | 50                            | 25                            |
| 10 – 16                            |                | 1 N/O 1 NC        |  | 63                            | 35                            |
| 16 – 24                            |                | 1 N/O 1 NC        |  | 63                            | 50                            |
| 24 – 40                            |                | 1 N/O 1 NC        |  | 125                           | 63                            |
| 40 – 57                            |                | 1 N/O 1 NC        |  | 160                           | 80                            |
| 50 – 65                            |                | 1 N/O 1 NC        |  | 160                           | 100                           |
| 65 – 75                            |                | 1 N/O 1 NC        |  | 250                           | 160                           |

#### ZB150 overload relay

- Phase failure sensitivity to IEC/EN 60947, VDE 0660 Part 102
- Test/off pushbutton
- Reset pushbutton manual/auto
- Trip-free release
- Direct mounting

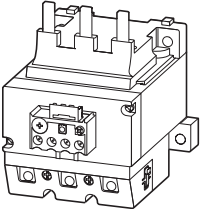

|           |  |            |   |     |     |
|-----------|--|------------|---|-----|-----|
| 35 – 50   |  | 1 N/O 1 NC | DILM80, DILM95, DILM115, DILM150, DILM170, DILMF80, DILMF95, DILMF115, DILMF150, DIULM80, DIULM95, DIULM115, DIULM150, SDAINLM140, SDAINLM165, SDAINLM200, SDAINLM260 | 160 | 125 |
| 50 – 70   |  | 1 N/O 1 NC |   | 250 | 160 |
| 70 – 100  |  | 1 N/O 1 NC |   | 315 | 200 |
| 95 – 125  |  | 1 N/O 1 NC |   | 315 | 250 |
| 120 – 150 |  | 1 N/O 1 NC |   | 315 | 250 |
| 145 – 175 |  | 1 N/O 1 NC |   | 315 | 250 |

#### ZB150 overload relay

- Phase failure sensitivity to IEC/EN 60947, VDE 0660 Part 102
- Test/off pushbutton
- Reset pushbutton manual/auto
- Trip-free release
- Separate mounting

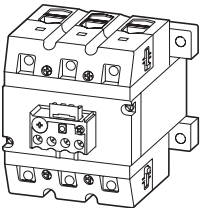

|           |  |            |   |     |     |
|-----------|--|------------|---|-----|-----|
| 35 – 50   |  | 1 N/O 1 NC | DILM80, DILM95, DILM115, DILM150, DILM170, DILMF80, DILMF95, DILMF115, DILMF150, DIULM80, DIULM95, DIULM115, DIULM150, SDAINLM140, SDAINLM165, SDAINLM200, SDAINLM260 | 160 | 125 |
| 50 – 70   |  | 1 N/O 1 NC |   | 250 | 160 |
| 70 – 100  |  | 1 N/O 1 NC |   | 315 | 200 |
| 95 – 125  |  | 1 N/O 1 NC |   | 315 | 250 |
| 120 – 150 |  | 1 N/O 1 NC |   | 315 | 250 |
| 145 – 175 |  | 1 N/O 1 NC |   | 400 | 315 |

#### Information relevant for export to North America



Product Standards  
UL File No.  
UL CCN  
CSA File No.  
CSA Class No.  
NA Certification  
Suitable for  
Max. Voltage Rating  
Degree of Protection  
See also





UL 508; CSA-C22.2 No.14; IEC/EN 60947-4-1; CE marking  
E29184  
NKCR  
12528  
3211-03  
UL Listed, CSA certified  
Branch circuits  
600 V AC  
IEC: IP00, UL/CSA Type: -  
→ Page 24

**Part no.**  
Article no.

**Price**  
See price list

**Std. pack**



**Notes**

|                            |   |   |
|----------------------------|---|---|
| <b>ZB65-10</b><br>278455   | 1 Off   | Overload release: tripping class 10 A<br>Short-circuit protection: With direct mounting, observe the maximum permissible fuse of the contactor. |
| <b>ZB65-16</b><br>278456   |  |   |
| <b>ZB65-24</b><br>278457   |   | Suitable for protection of EExe motors.   |
| <b>ZB65-40</b><br>278458   |   |  II (2) GD<br>PTB 04 ATEX 3022                                 |
| <b>ZB65-57</b><br>278459   |   | Observe manual AWB2300-1545D/GB.  |
| <b>ZB65-65</b><br>278460   |   |   |
| <b>ZB65-75</b><br>108792   |   |   |
| <b>ZB150-50</b><br>278462  | 1 Off   | Overload release: tripping class 10 A<br>Short-circuit protection: With direct mounting, observe the maximum permissible fuse of the contactor. |
| <b>ZB150-70</b><br>278463  |  |   |
| <b>ZB150-100</b><br>278464 |   | Suitable for protection of EEx e motors.  |
| <b>ZB150-125</b><br>278465 |   |  II (2) GD<br>PTB 04 ATEX 3022                               |
| <b>ZB150-150</b><br>278466 |   | Observe manual AWB2300-1545D/GB.  |
| <b>ZB150-175</b><br>107316 |   |   |

Fitted directly to the contactor

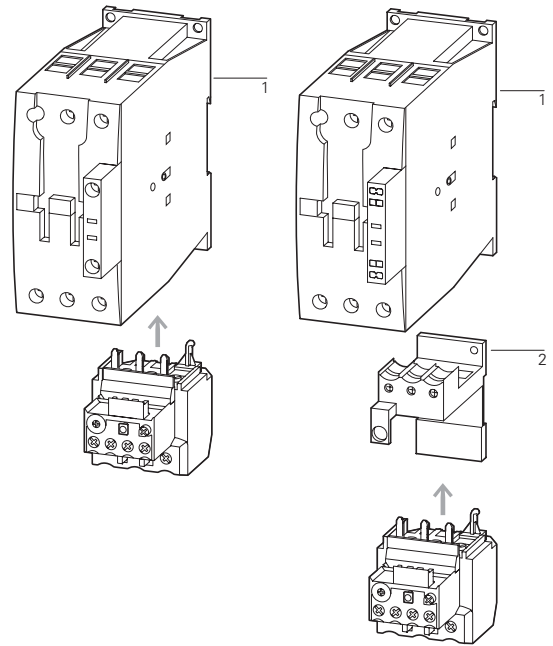
Separate mounting



|                               |   |   |
|-------------------------------|---|---|
| <b>ZB150-50/KK</b><br>278468  | 1 Off   | Overload release: tripping class 10 A<br>Short-circuit protection: With direct mounting, observe the maximum permissible fuse of the contactor. |
| <b>ZB150-70/KK</b><br>278469  |  |   |
| <b>ZB150-100/KK</b><br>278470 |   | Suitable for protection of EEx e motors.  |
| <b>ZB150-125/KK</b><br>278471 |   |  II (2) GD<br>PTB 04 ATEX 3022                               |
| <b>ZB150-150/KK</b><br>278472 |   | Observe manual AWB2300-1545D/GB.  |
| <b>ZB150-175/KK</b><br>107317 |   |   |

1 Contactor → Chapter 1.1  
2 Base → Page 21  
Manual → Page 21

# 1.2

## Overload relays

Overload relays greater than 150 A, CT-operated overload relays

1

### Z5, ZW7

Setting range of overload releases

Circuit symbol

Auxiliary contacts

For use with

Short-circuit protection

N/O = normally open contact  
NC = normally closed contact

Type "1" coordination  
gG/gL

Type "2" coordination  
gG/gL



#### Z5 overload relays greater than 150A

- Phase failure sensitivity to IEC/EN 60947, VDE 0660 Part 102
- Test/off pushbutton
- Reset pushbutton manual/auto
- Trip-free release

Direct mounting  
Separate mounting

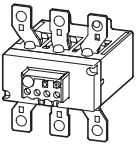

50 – 70

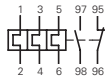

1 N/O 1 NC

DILM185A  
DILM225A

250

160

70 – 100

1 N/O 1 NC

250

160

95 – 125

1 N/O 1 NC

315

200

120 – 160

1 N/O 1 NC

315

200

160 – 220

1 N/O 1 NC

400

250

200 – 250

1 N/O 1 NC

400

250

500

400

#### Z5 overload relays greater than 150A

- Phase failure sensitivity to IEC/EN 60947, VDE 0660 Part 102
- Test/off pushbutton
- Reset pushbutton manual/auto
- Trip-free release

Direct mounting  
Separate mounting

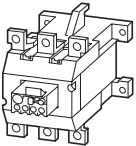

70 – 100

1 N/O 1 NC

DILM250A

250

160

70 – 100

1 N/O 1 NC

250

160

95 – 125

1 N/O 1 NC

315

200

120 – 160

1 N/O 1 NC

315

200

160 – 220

1 N/O 1 NC

315

250

200 – 250

1 N/O 1 NC

315

250

400

315

200 – 300

1 N/O 1 NC

DILM300A

500

400

500

400

#### ZW7 current transformer-operated overload relays

- Test/off button
- Reset pushbutton manual/auto
- Trip-free release
- Protection with heavy starting duty

Separate mounting

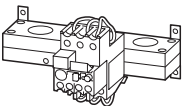

42 – 63

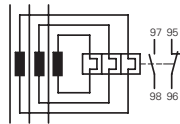

1 N/O 1 NC

–

–

–

60 – 90

1 N/O 1 NC

–

–

–

85 – 125

1 N/O 1 NC

–

–

–

110 – 160

1 N/O 1 NC

–

–

–

160 – 240

1 N/O 1 NC

–

–

–

190 – 290

1 N/O 1 NC

–

–

–

270 – 400

1 N/O 1 NC

–

–

–

360 – 540

1 N/O 1 NC

–

–

–



420 – 630

1 N/O 1 NC

–

–

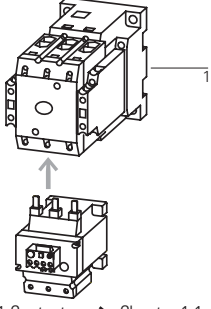
–

| Part no.<br>Article no.        | Price<br>See price list | Std. pack   | Notes  | Information relevant for export to North America                              |
|--------------------------------|-------------------------|---|--|---|
| <b>Z5-70/FF225A</b><br>139572  |                         | 1 Off   | Overload release:<br>tripping class 10 A   | Product Standards<br>UL 508; CSA-C22.2 No.14;<br>IEC/EN 60947-4-1; CE marking |
| <b>Z5-100/FF225A</b><br>139573 |                         |    | Short-circuit protection: With direct mounting,<br>observe the maximum permissible fuse of the<br>contactor. | NA Certification<br>Suitable for<br>Branch circuits                           |
| <b>Z5-125/FF225A</b><br>139574 |                         |   |  | Max. Voltage Rating<br>600 V AC   |
| <b>Z5-160/FF225A</b><br>139575 |                         |   | Z5-.../FF225A for protecting<br>EEx electric motors in preparation.  | Degree of Protection<br>IEC: IP00, UL/CSA Type: -<br>→ Page 24                |
| <b>Z5-220/FF225A</b><br>139576 |                         |   | Fitted directly to the contactor   |   |
| <b>Z5-250/FF225A</b><br>139577 |                         |   |                            |   |
| <b>Z5-70/FF250</b><br>210070   |                         |   |  | Product Standards<br>UL 508; CSA-C22.2 No.14;<br>IEC/EN 60947-4-1; CE marking |
| <b>Z5-100/FF250</b><br>210071  |                         |   |  | UL File No.<br>E29184   |
| <b>Z5-125/FF250</b><br>210072  |                         |   |  | UL CCN<br>NKCR  |
| <b>Z5-160/FF250</b><br>210073  |                         |   |  | CSA File No.<br>12528   |
| <b>Z5-220/FF250</b><br>210074  |                         |   |  | CSA Class No.<br>3211-03  |
| <b>Z5-250/FF250</b><br>210075  |                         |   |  | NA Certification<br>UL Listed, CSA certified                                  |
| <b>Z5-300/FF250</b><br>139578  |                         |   |  | Suitable for<br>Branch circuits   |
|                                |                         |   | 1 Contactor → Chapter 1.1<br>Accessories → Page 22   | Max. Voltage Rating<br>600 V AC   |
|                                |                         |   |  | Degree of Protection<br>IEC: IP00, UL/CSA Type: -<br>→ Page 24                |
| <b>ZW7-63</b><br>000245        |                         | 1 Off   | The main current characteristic values are defined<br>by the main current wiring being used.                 | Product Standards<br>UL 508; CSA-C22.2 No.14;<br>IEC/EN 60947-4-1; CE marking |
| <b>ZW7-90</b><br>002618        |                         |  | Adjustment for smaller rated motor currents<br>→ Page 23   | NA Certification<br>Request filed for UL and CSA<br>Branch circuits           |
| <b>ZW7-125</b><br>004991       |                         |   |  | Suitable for<br>Branch circuits   |
| <b>ZW7-160</b><br>007364       |                         |   |  | Max. Voltage Rating<br>600 V AC   |
| <b>ZW7-240</b><br>009737       |                         |   |  | Degree of Protection<br>IEC: IP00, UL/CSA Type: -                             |
| <b>ZW7-290</b><br>052448       |                         |   |  |   |
| <b>ZW7-400</b><br>045329       |                         |   |  |   |
| <b>ZW7-540</b><br>047702       |                         |   |  |   |
| <b>ZW7-630</b><br>050075       |                         | 1 Off   |  |   |



# 1.2 Electronic overload relays to 1500 A

## Basic devices

1

### ZEB12, ZEB32

Ground fault detection

Setting range of overload releases



Circuit symbol

Auxiliary contact

N/O = normally open contact  
NC = normally closed contact

For use with

#### ZEB12 electronic overload relay

- Phase-failure sensitivity
- Test/off pushbutton
- Reset button
- Manual/Auto reset selectable
- Protection with heavy starting duty (Class 5-30)

Direct mounting

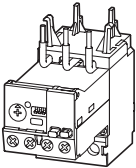

| Ground fault detection | Setting range of overload releases | Circuit symbol | Auxiliary contact | For use with |                                    |
|------------------------|------------------------------------|----------------|-------------------|--------------|------------------------------------|
| Without                | 0.33 – 1.65                        |                | 1 N/O             | 1 NC         | DILM7<br>DILM9<br>DILM12<br>DILM15 |
| Without                | 1 – 5                              |                | 1 N/O             | 1 NC         | DIULM7<br>DIULM9<br>DIULM12        |
| Without                | 4 – 20                             |                | 1 N/O             | 1 NC         | SDAINLM16<br>SDAINLM22             |
| With                   | 0.33 – 1.65                        |                | 1 N/O             | 1 NC         |                                    |
| With                   | 1 – 5                              |                | 1 N/O             | 1 NC         |                                    |
| With                   | 4 – 20                             |                | 1 N/O             | 1 NC         |                                    |

#### ZEB32 electronic overload relay

- Phase-failure sensitivity
- Test/off pushbutton
- Reset button
- Manual/Auto reset selectable
- Protection with heavy starting duty (Class 5-30)

Direct mounting

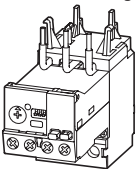

|         |             |       |       |      |                                      |
|---------|-------------|-------|-------|------|--------------------------------------|
| Without | 0.33 – 1.65 |       | 1 N/O | 1 NC | DILM17<br>DILM25<br>DILM32<br>DILM38 |
| Without | 1 – 5       |       | 1 N/O | 1 NC | DIULM17<br>DIULM25<br>DIULM32        |
| Without | 4 – 20      |       | 1 N/O | 1 NC | SDAINLM30<br>SDAINLM45<br>SDAINLM55  |
| Without | 9 – 45      |       | 1 N/O | 1 NC |                                      |
| With    | 0.33 – 1.65 |       | 1 N/O | 1 NC |                                      |
| With    | 1 – 5       |       | 1 N/O | 1 NC |                                      |
| With    | 4 – 20      | 1 N/O | 1 NC  |      |                                      |
| With    | 9 – 45      | 1 N/O | 1 NC  |      |                                      |

#### ZEB32 electronic overload relay

- Phase-failure sensitivity
- Test/off pushbutton
- Reset button
- Manual/Auto reset selectable
- Protection with heavy starting duty (Class 5-30)

Separate mounting

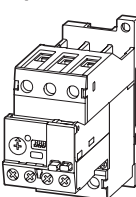







|         |             |       |       |      |                                      |
|---------|-------------|-------|-------|------|--------------------------------------|
| Without | 0.33 – 1.65 |       | 1 N/O | 1 NC | DILM17<br>DILM25<br>DILM32<br>DILM38 |
| Without | 1 – 5       |       | 1 N/O | 1 NC | DIULM17<br>DIULM25<br>DIULM32        |
| Without | 4 – 20      |       | 1 N/O | 1 NC | SDAINLM30<br>SDAINLM45<br>SDAINLM55  |
| Without | 9 – 45      |       | 1 N/O | 1 NC |                                      |
| With    | 0.33 – 1.65 |       | 1 N/O | 1 NC |                                      |
| With    | 1 – 5       |       | 1 N/O | 1 NC |                                      |
| With    | 4 – 20      | 1 N/O | 1 NC  |      |                                      |
| With    | 9 – 45      | 1 N/O | 1 NC  |      |                                      |

#### Information relevant for export to North America

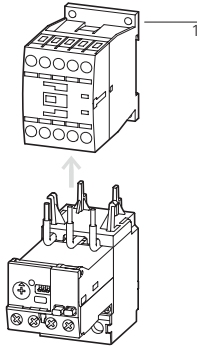

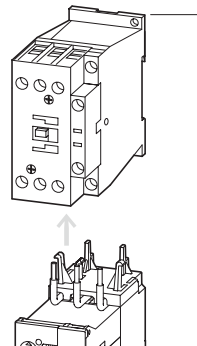
|                      |  |
|----------------------|--|
| Product Standards    | UL 508; CSA-C22.2 No. 14; IEC/EN 60947-4-1; CE marking |
| NA Certification     | Request filed for UL and CSA                           |
| Suitable for         | Branch circuits  |
| Max. Voltage Rating  | 600 V AC   |
| Degree of Protection | IEC: IP20, UL/CSA Type: -                              |

| Part no.<br>Article no.           | Price<br>See price list | Std. pack   | Notes  |   |
|-----------------------------------|-------------------------|---|--|---|
| <b>ZEB12-1,65</b><br>136480       |                         | 1 Off   | Suitable for protection of EEx e motors.   | Fitted directly to the contactor  |
| <b>ZEB12-5</b><br>136481          |                         |    |  II (2) GD<br>PTB ATEX starting 08/2010   |  <p>1 Contactor → Chapter 1.1<br/>Accessories → Page 18</p>  |
| <b>ZEB12-20</b><br>136482         |                         |   | Observe manual AWB2320-1633D/GB.   |   |
| <b>ZEB12-1,65-GF</b><br>136483    |                         |   | Switchgear and cable dimensioning according to CLASS   |   |
| <b>ZEB12-5-GF</b><br>136484       |                         |   | → Page 18  |   |
| <b>ZEB12-20-GF</b><br>136485      |                         |   |  |   |
| <b>ZEB32-1,65</b><br>136486       |                         | 1 Off   | Suitable for protection of EEx e motors.   | Fitted directly to the contactor  |
| <b>ZEB32-5</b><br>136487          |                         |   |  II (2) GD<br>PTB ATEX starting 08/2010  |  <p>1 Contactor → Chapter 1.1<br/>Accessories → Page 18</p> |
| <b>ZEB32-20</b><br>136488         |                         |   | Observe manual AWB2320-1633D/GB.   |   |
| <b>ZEB32-45</b><br>136489         |                         |   | Switchgear and cable dimensioning according to CLASS   |   |
| <b>ZEB32-1,65-GF</b><br>136490    |                         |   | → Page 18  |   |
| <b>ZEB32-5-GF</b><br>136491       |                         |   |  |   |
| <b>ZEB32-20-GF</b><br>136492      |                         |   |  |   |
| <b>ZEB32-45-GF</b><br>136493      |                         |   |  |   |
| <b>ZEB32-1,65/KK</b><br>136494    |                         | 1 Off   | Suitable for protection of EEx e motors.   |   |
| <b>ZEB32-5/KK</b><br>136495       |                         |  |  II (2) GD<br>PTB ATEX starting 08/2010 |   |
| <b>ZEB32-20/KK</b><br>136496      |                         |   | Observe manual AWB2320-1633D/GB.   |   |
| <b>ZEB32-45/KK</b><br>136497      |                         |   | Switchgear and cable dimensioning according to CLASS   |   |
| <b>ZEB32-1,65-GF/KK</b><br>136498 |                         |   | → Page 18  |   |
| <b>ZEB32-5-GF/KK</b><br>136499    |                         |   |  |   |
| <b>ZEB32-20-GF/KK</b><br>136500   |                         |   |  |   |
| <b>ZEB32-45-GF/KK</b><br>136501   |                         |   |  |   |

# 1.2

## Electronic overload relays to 1500 A

Basic devices

1

### ZEB65, ZEB150

| Ground fault detection | Setting range of overload releases<br>$I_r$<br>A | Circuit symbol | Auxiliary contact   | For use with |
|------------------------|--|----------------|---|--------------|
|                        |  |                | N/O = normally open contact<br>NC = normally closed contact |              |

#### ZEB65 electronic overload relay

- Phase-failure sensitivity
- Test/off pushbutton
- Reset button
- Manual/Auto reset selectable
- Protection with heavy starting duty (Class 5-30)

#### Direct mounting

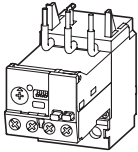

|         |          |  |       |      |   |
|---------|----------|--|-------|------|---|
| Without | 9 – 45   |  | 1 N/O | 1 NC | DILM40<br>DILM50                                |
| With    | 9 – 45   |  | 1 N/O | 1 NC | DILM65<br>DILM72                                |
| Without | 20 – 100 |  | 1 N/O | 1 NC | DIULM40<br>DIULM50                              |
| With    | 20 – 100 |  | 1 N/O | 1 NC | DIULM65<br>SDAINLM70<br>SDAINLM90<br>SDAINLM115 |

#### ZEB150 electronic overload relay

- Phase-failure sensitivity
- Test/off pushbutton
- Reset button
- Manual/Auto reset selectable
- Protection with heavy starting duty (Class 5-30)

#### Direct mounting

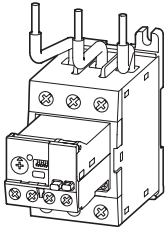

|         |          |  |       |      |  |
|---------|----------|--|-------|------|--|
| Without | 20 – 100 |  | 1 N/O | 1 NC | DILM80<br>DILM95   |
| With    | 20 – 100 |  | 1 N/O | 1 NC | DILM115<br>DILM150<br>DIULM80<br>DIULM95                                     |
|         |          |  |       |      | DIULM115<br>DIULM150<br>SDAINLM140<br>SDAINLM165<br>SDAINLM200<br>SDAINLM260 |

#### ZEB150 electronic overload relay

- Phase-failure sensitivity
- Test/off pushbutton
- Reset button
- Manual/Auto reset selectable
- Protection with heavy starting duty (Class 5-30)

#### Separate mounting

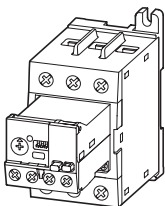









|         |          |  |       |      |  |
|---------|----------|--|-------|------|--|
| Without | 20 – 100 |  | 1 N/O | 1 NC | DILM80<br>DILM95   |
| With    | 20 – 100 |  | 1 N/O | 1 NC | DILM115<br>DILM150<br>DIULM80<br>DIULM95                                     |
|         |          |  |       |      | DIULM115<br>DIULM150<br>SDAINLM140<br>SDAINLM165<br>SDAINLM200<br>SDAINLM260 |

#### Information relevant for export to North America

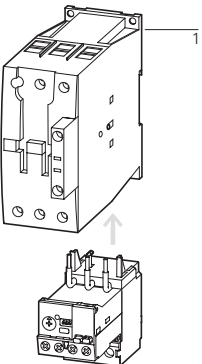

Product Standards  
NA Certification  
Suitable for  
Max. Voltage Rating  
Degree of Protection

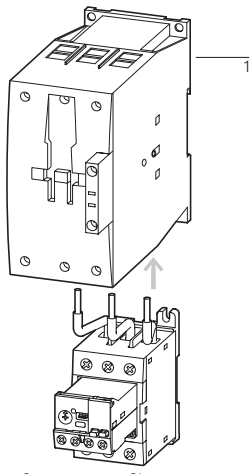









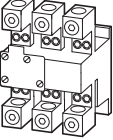

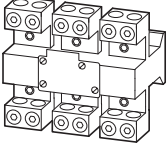

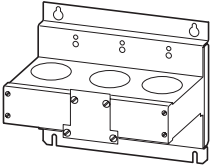
UL 508; CSA-C22.2 No.14; IEC/EN 60947-4-1; CE marking  
Request filed for UL and CSA  
Branch circuits  
600 V AC  
IEC: IP20, UL/CSA Type: -

| Part no.<br>Article no.           | Price<br>See price list | Std. pack   | Notes  |  |
|-----------------------------------|-------------------------|---|--|--|
| <b>ZEB65-45</b><br>136502         |                         | 1 Off   | Suitable for protection of EEx e motors.   | Fitted directly to the contactor   |
| <b>ZEB65-45-GF</b><br>136503      |                         |    |  II (2) GD<br>PTB ATEX starting 08/2010   |  <p>1 Contactor → Chapter 1.1<br/>Accessories → Page 18</p>   |
| <b>ZEB65-100</b><br>136504        |                         |   | Observe manual AWB2320-1633D/GB.   |  |
| <b>ZEB65-100-GF</b><br>136505     |                         |   | Switchgear and cable dimensioning according to CLASS<br>→ Page 18  |  |
| <b>ZEB150-100</b><br>136506       |                         | 1 Off   | Suitable for protection of EEx e motors.   | Fitted directly to the contactor   |
| <b>ZEB150-100-GF</b><br>136507    |                         |   |  II (2) GD<br>PTB ATEX starting 08/2010  |  <p>1 Contactor → Chapter 1.1<br/>Accessories → Page 18</p> |
|                                   |                         |   | Observe manual AWB2320-1633D/GB.   |  |
|                                   |                         |   | Switchgear and cable dimensioning according to CLASS<br>→ Page 18  |  |
| <b>ZEB150-100/KK</b><br>136508    |                         | 1 Off   | Suitable for protection of EEx e motors.   |  |
| <b>ZEB150-100-GF/KK</b><br>136509 |                         |  |  II (2) GD<br>PTB ATEX starting 08/2010 |  <p>1 Contactor → Chapter 1.1<br/>Accessories → Page 18</p> |
|                                   |                         |   | Observe manual AWB2320-1633D/GB.   |  |
|                                   |                         |   | Switchgear and cable dimensioning according to CLASS<br>→ Page 18  |  |

# 1.2 Electronic overload relays to 1500 A

## Accessories

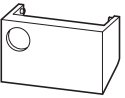
### 1 ZEB-XCT...

|  | Setting range of overload releases | Language           | Can be used with                  | Part no. Article no.                       | Price See price list | Std. pack  |
|--|------------------------------------|--------------------|-----------------------------------|--|----------------------|--|
|  | $I_r$<br>A                         |                    |                                   |  |                      |  |
| <b>Current sensors</b>   |                                    |                    |                                   |  |                      |  |
|    | 60 – 300                           | –                  | ZEB32-5-GF/KK<br>ZEB32-5/KK       | <b>ZEB-XCT300</b> <sup>1)</sup><br>136511  |                      | 1 off<br>      |
|    | 120 – 600                          | –                  | ZEB32-5-GF/KK<br>ZEB32-5/KK       | <b>ZEB-XCT600</b> <sup>1)</sup><br>136512  |                      | 1 off<br>      |
|    | 200 – 1000                         | –                  | ZEB32-5-GF/KK<br>ZEB32-5/KK       | <b>ZEB-XCT1000</b> <sup>1)</sup><br>136517 |                      | 1 off<br>      |
|  | 300 – 1500                         | –                  |                                   | <b>ZEB-XCT1500</b> <sup>1)</sup><br>136513 |                      | 1 off<br>      |
| <b>Sealable shroud</b>   |                                    |                    |                                   |  |                      |  |
| Cover to prevent adjustment of motor current (tamper-proof)                        |                                    |                    |                                   |  |                      |  |
|  | –                                  | –                  | –                                 | <b>ZEB-XSC</b> <sup>2)</sup><br>136514     |                      | 1 off<br>  |
| <b>Reset adapter</b>   |                                    |                    |                                   |  |                      |  |
| Cover to prevent adjustment of motor current (tamper-proof)                        |                                    |                    |                                   |  |                      |  |
|  | –                                  | –                  | –                                 | <b>ZEB-XRB</b> <sup>2)</sup><br>136515     |                      | 1 off<br>  |
| <b>Documentation</b>   |                                    |                    |                                   |  |                      |  |
| ZEB electronic overload relay<br>Overload monitoring of EEx e motors               |                                    |                    |                                   |  |                      |  |
|  | –                                  | Deutsch<br>English | ZEB12<br>ZEB32<br>ZEB65<br>ZEB150 | <b>AWB2320-1633DE/EN</b><br>136516         |                      | 1 off  |

1)

#### Information relevant for export to North America



Product Standards UL 508; CSA-C22.2 No.14; IEC/EN 60947-4-1; CE marking  
NA Certification Request filed for UL and CSA  
Suitable for Branch circuits  
Max. Voltage Rating 600 V AC  
Degree of Protection IEC: IP00, UL/CSA Type: -

2)

#### Information relevant for export to North America



Product Standards UL 508; CSA-C22.2 No.14; IEC/EN 60947-4-1; CE marking  
NA Certification Request filed for UL and CSA  
Max. Voltage Rating 600 V AC  
Degree of Protection IEC: IP20, UL/CSA Type: -

### Switchgear and cable sizing corresponding to the respective starting inertia (CLASS) for ZEB

Switchgear is designed according to "CLASS 10" requirements for both normal and overload operation conditions. In order for the switchgear (circuit-breaker and contactor) and the cables not to be overloaded with long tripping times, they must be oversized accordingly. The rated operational current,  $I_e$ , for switchgear and cables can be calculated with the following current factor taking the tripping class into account:

| Tripping class                                    | Class 5 | Class 10 | Class 15 | Class 20 | Class 25 | Class 30 | Class 35 | Class 40 |
|---|---------|----------|----------|----------|----------|----------|----------|----------|
| Current factor of rated operational current $I_e$ | 1.00    | 1.00     | 1.22     | 1.41     | 1.58     | 1.73     | 1.89     | 2.00     |

## Ordering

### EMT6

| Function | Rated operational current | Conventional thermal current | Rated control voltage | Part no. Article no. | Price See price list | Std. pack | Notes |
|----------|---------------------------|------------------------------|-----------------------|----------------------|----------------------|-----------|-------|
|          | AC-15<br>240 V            | AC-14<br>400 V               |                       |                      |                      |           |       |
|          | $I_e$<br>A                | $I_e$<br>A                   | $I_{th}$<br>A         | $U_s$<br>V           |                      |           |       |

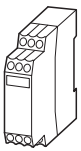

#### EMT6 thermistor machine protection overload relays

|   |   |   |   |                                       |   |       |   |
|---|---|---|---|---------------------------------------|---|-------|---|
| Without automatic reset<br>Mains and fault LED display  | 3 | 3 | 6 | 24 - 240 V 50/60 Hz,<br>24 - 240 V DC | <b>EMT6</b> <sup>1) 2)</sup><br>066166          | 1 off | II (2) G  |
|   |   |   |   | 230 V 50/60 Hz                        | <b>EMT6(230V)</b> <sup>1) 2)</sup><br>066400    |       | II (2) GD only for EMT6-K   |
| Without automatic reset<br>Mains and fault LED display<br>Tripped in the event of a short-circuit in the sensor-cable   | 3 | 3 | 6 | 24 - 240 V 50/60 Hz,<br>24 - 240 V DC | <b>EMT6-K</b> <sup>2)</sup><br>269470           |       | PTB 02 ATEX 3162  |
| Selector switch with/without automatic reset<br>For manual or remote resetting<br>Test button<br>Mains and fault LED display  | 3 | 3 | 6 | 24 - 240 V 50/60 Hz,<br>24 - 240 V DC | <b>EMT6-DB</b> <sup>1) 2)</sup><br>066167       |       | Observe the manual<br>AWB 2327-1446<br>→ Page 19<br>Can be snap fitted on a top-hat rail to IEC/EN 60715.<br>Device clearance ≧ 3 mm. |
|   |   |   |   | 230 V 50/60 Hz                        | <b>EMT6-DB(230V)</b> <sup>1) 2)</sup><br>066401 |       |   |
| Selector switch with/without automatic reset<br>For manual or remote resetting<br>Test button<br>Mains and fault LED display<br>Trip with short-circuit in the sensor cable   | 3 | 3 | 6 | 24 - 240 V 50/60 Hz,<br>24 - 240 V DC | <b>EMT6-KDB</b> <sup>2)</sup><br>269471         |       |   |
| All-in-one device<br>Selector switch with/without automatic reset<br>Trip with short-circuit in the sensor cable<br>Zero-voltage safe<br>For manual or remote resetting<br>Test button<br>Short-circuit detection and retention can be deactivated<br>Mains and fault LED display | 3 | 3 | 6 | 24 - 240 V 50/60 Hz,<br>24 - 240 V DC | <b>EMT6-DBK</b> <sup>2)</sup><br>066168         |       |   |

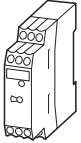
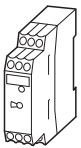

#### Accessories

##### Screw adapters for screw fixing

|  |  |  |  |  |                                      |        |   |
|--|--|--|--|--|--------------------------------------|--------|---|
|  |  |  |  |  | <b>CS-TE</b> <sup>3)</sup><br>095853 | 10 off | – |
|  |  |  |  |  |                                      |        |   |

#### Documentation

##### EMT6 thermistor overload relay Overload monitoring of machines in the EEx e area

|         |  |  |  |  |                                 |       |  |
|---------|--|--|--|--|---------------------------------|-------|--|
| German  |  |  |  |  | <b>AWB2327-1446D</b><br>264853  | 1 off |  |
| English |  |  |  |  | <b>AWB2327-1446GB</b><br>267010 | 1 off |  |

#### Notes

<sup>1)</sup> For EMT6, EMT6(230V), EMT6-DB and EMT6-DB(230V) applies:  
Provide additional short-circuit protection in the sensor circuit with a current monitoring relay.

<sup>2)</sup>

#### Information relevant for export to North America

|                      |  |
|----------------------|--|
|                      |  |
| Product Standards    | UL 508; CSA-C22.2 No.14;<br>IEC/EN 60947-4-1; CE marking |
| UL File No.          | E29184   |
| UL CCN               | NKCR   |
| CSA File No.         | 12528  |
| CSA Class No.        | 3211-03  |
| NA Certification     | UL Listed, CSA certified                                 |
| Max. Voltage Rating  | 600 V AC   |
| Degree of Protection | IEC: IP20, UL/CSA Type: -                                |

<sup>3)</sup>

#### Information relevant for export to North America

|  |                                   |
|--|-----------------------------------|
|  |                                   |
|  | UL/CSA certification not required |

# 1.2 Overload relays for machine protection

Selection aid

## 1 Engineering

### Terminal marking according to EN 50005

EMT6(-K), EMT6(-K)DB, EMT6-DBK  
Auto

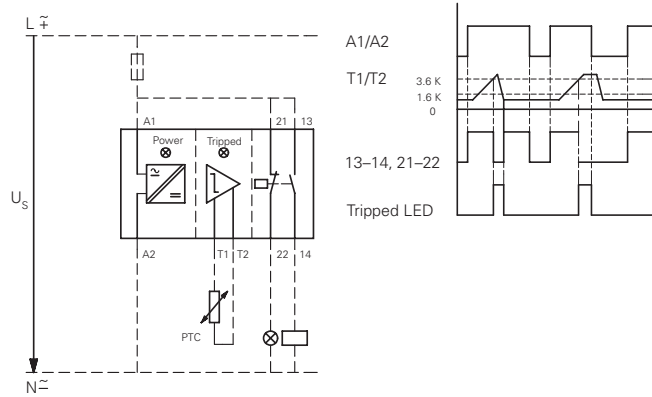

EMT6(-K)DB, EMT6-DBK  
Manual

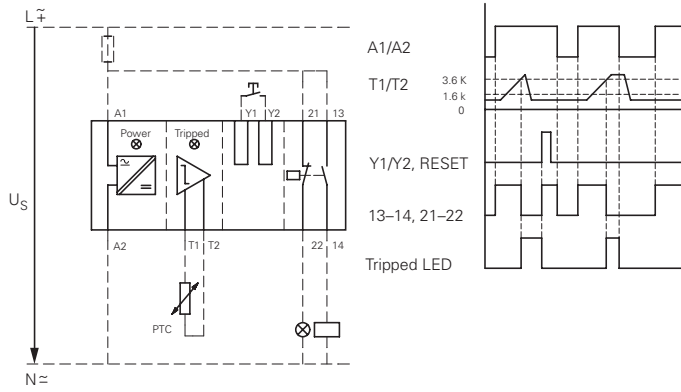

### EMT6-DBK

Zero-voltage safe operation

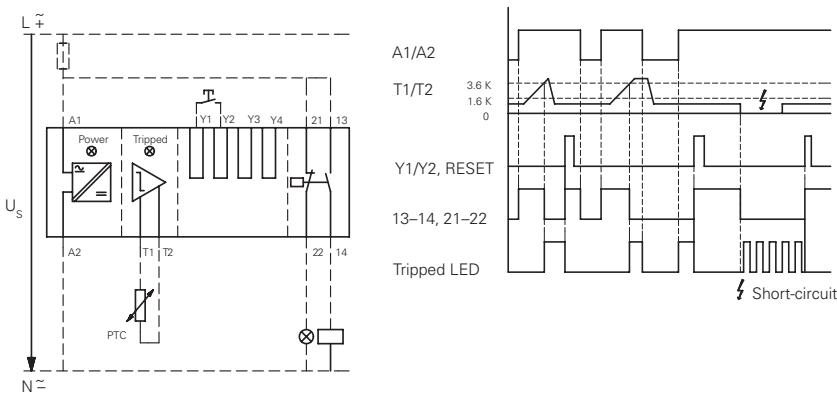

#### LED display

- Supply voltage present
- Device has tripped
- Device has tripped/short-circuit in the sensor circuit

### Sensor circuit

At  $R_K \cong 250 \Omega$  per sensor; at  $R_K \cong 100 \Omega$  per sensor: 9 sensors in the winding (provided by user), max. cable length to sensor 250 m (not shielded); Total PTC thermistor resistance  $\sum R_K \cong 1500 \Omega$

Sensor circuit characteristic values at  $U_S$  and  $+20^\circ\text{C}$

|                        | EMT6...                  |                        |
|------------------------|--------------------------|------------------------|
| $R_{T1-T2}$            | $U_{T1-T2}$<br>V DC max. | $I_{T1-T2}$<br>mA max. |
| T1, T2 short-circuited | -                        | 1.9                    |
| 4 k $\Omega$           | 3                        | 0.8                    |
| T1-T2 open             | 5.1                      | -                      |





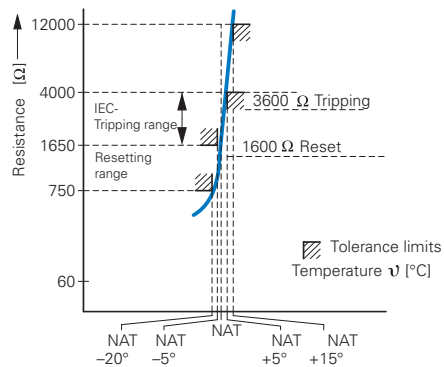





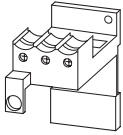



Functions that can be disconnected on the EMT6-DBK:

| Function                 | Disconnection by link           |
|--------------------------|---------------------------------|
| Short-circuit monitoring | Y <sub>1</sub> - Y <sub>3</sub> |
| Zero-voltage safety      | Y <sub>1</sub> - Y <sub>4</sub> |



Ordering

ZB, Z5, ZW7

|   | For use with  | Part no.<br>Article no.           | Price<br>See price<br>list | Std. pack   | Notes  | Information relevant for export to<br>North America   |
|---|---|-----------------------------------|----------------------------|---|--|---|
|   |   |                                   |                            |   |  |   |
| <b>Documentation</b><br>Overload relays<br>Overload monitoring of<br>EEx e motors                                 | ZE...   | <b>AWB2300-1425D</b><br>258704    |                            | 1 off   | German   |   |
|   | ZB12...<br>ZB32...                                  | <b>AWB2300-1527D/GB</b><br>284910 |                            | 1 off   | German/English   |   |
|   | ZB65...<br>ZB150...                                 | <b>AWB2300-1545D/GB</b><br>102065 |                            | 1 off   | German/English   |   |
| <b>Bases</b><br>For separate mounting   | ZB32  | <b>ZB32-XEZ</b><br>278473         |                            | 5 off<br>       | Can be snap fitted on a top-hat rail to IEC/EN 60715 or can be screw fitted. | Product Standards<br>UL 508; CSA-C22.2 No.14; IEC/EN 60947-4-1; CE marking E29184   |
|   | ZB65  | <b>ZB65-XEZ</b><br>278474         |                            | 2 off<br>       | For ZB32-38, use BK25/3-PKZ0 additionally.                                   | UL File No.<br>UL CCN<br>CSA File No.<br>CSA Class No.<br>NA Certification<br>Max. Voltage Rating<br>Degree of Protection<br>600 V AC<br>IEC: IP00, UL/CSA Type: -      |
| <b>Pushbuttons</b><br>For enclosed<br>Overload relay<br>Mounting diameter: 22.3 mm<br>External reset button, IP65 | ZW7...<br>ZE<br>Z5<br>ZB12<br>ZB32<br>ZB65<br>ZB150 | <b>M22-DZ-B</b><br>254833         |                            | 10 off<br>      | Button plate, blue   | Product Standards<br>UL 508; CSA-C22.2 No.14; IEC/EN 60947-4-1; CE marking E29184   |
|   | ZW7...<br>ZE<br>Z5<br>ZB12<br>ZB32<br>ZB65<br>ZB150 | <b>M22-DZ-B-GB14</b><br>254834    |                            | 10 off<br>  | Button plate, blue RESET   | UL File No.<br>UL CCN<br>CSA File No.<br>CSA Class No.<br>NA Certification<br>NKCR<br>12528<br>3211-03<br>UL Listed, CSA certified                                      |
| <b>Pushbuttons</b><br>For enclosed<br>Overload relay<br>Mounting diameter: 22.3 mm<br>Off button, IP65            | ZW7...<br>ZE<br>Z5<br>ZB12<br>ZB32<br>ZB65<br>ZB150 | <b>M22-DZ-X</b><br>254835         |                            | 10 off<br>  | Without button plate, add button plate.                                      | Product Standards<br>UL 508; CSA-C22.2 No.14; IEC/EN 60947-4-1; CE marking E29184   |
|   | ZW7...<br>ZE<br>Z5<br>ZB12<br>ZB32<br>ZB65<br>ZB150 | <b>M22-DZ-X-GB14</b><br>254836    |                            | 10 off<br>  | Without button plate, add button plate.                                      | UL File No.<br>UL CCN<br>CSA File No.<br>CSA Class No.<br>NA Certification<br>NKCR<br>12528<br>3211-03<br>UL Listed, CSA certified                                      |
| <b>Pushbuttons</b><br>For enclosed<br>Overload relay<br>Mounting diameter: 22.3 mm<br>Button plates               | M22-DZ-X  | <b>M22-XD-R</b><br>216423         |                            | 10 off<br>  | Button plate, red  | UL/CSA certification not required   |
|   | M22-DZ-X  | <b>M22-XD-R-X0</b><br>218153      |                            |   | Red button plate with white circle   |   |
|   | M22-DZ-X  | <b>M22-XD-R-GB0</b><br>218194     |                            |   | Button plate red STOP  |   |

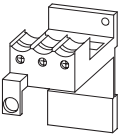



# 1.2 Overload relays

## Accessories

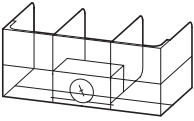
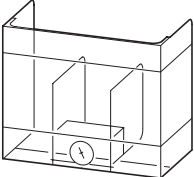
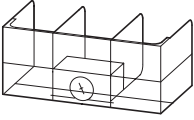

1

### Z5..., K-B..., KS-B...

|   | For use with  | Part no.<br>Article no.          | Price<br>See price list | Std. pack | Notes                            |                                  |                                  |
|---|---|----------------------------------|-------------------------|-----------|----------------------------------|----------------------------------|----------------------------------|
| <b>Covers</b><br>   | Direct mounting Z5-.../FF225 to<br>DILM185A<br>DILM225A | <b>Z5/FF225A-XHB-Z</b><br>139579 |                         | 1 off     | Fitted directly to the contactor |                                  |                                  |
|   |   |                                  |                         |           | DILM400-XHB                      |                                  |                                  |
|   |   |                                  |                         |           | DILM185A/225A                    |                                  |                                  |
|   |   |                                  |                         |           | Z5/FF225A-XHB-Z                  |                                  |                                  |
| <b>Covers</b><br>   | Z5-.../FF225A<br>Z5-.../FF250                           | <b>Z5/FF250-XHB</b><br>215217    |                         | 1 off     | Separate mounting                |                                  |                                  |
|   |   |                                  |                         |           | Z5/FF250-XHB                     | Fitted directly to the contactor | Fitted directly to the contactor |
|   |   |                                  |                         |           | Z5-.../FF250/FF225A              | DILM400-XHB                      | DILM400-XHB                      |
|   |   |                                  |                         |           | Z5/FF250-XHB                     | DILM250/300A                     | DILM185A/225A                    |
|   |   |                                  |                         |           |                                  | Z5/FF250-XHB-Z                   | Z5/FF225A-XHB-Z                  |
|   |   |                                  |                         |           |                                  | Z5-.../FF250                     | Z5-.../FF225A                    |
| <b>Covers</b><br> | Direct mounting Z5-.../FF250 to<br>DILM250<br>DILM300A  | <b>Z5/FF250-XHB-Z</b><br>215218  |                         | 1 off     | Fitted directly to the contactor |                                  |                                  |
|   |   |                                  |                         |           | DILM400-XHB                      |                                  |                                  |
|   |   |                                  |                         |           | DILM250/300A                     |                                  |                                  |
|   |   |                                  |                         |           | Z5/FF250-XHB-Z                   |                                  |                                  |
|   |   |                                  |                         |           | Z5-.../FF250                     |                                  |                                  |

### Box terminals kit

Consisting of 3 individual clamps

|   | For use with | For connection of copper flat strip max. W x H mm | Part no.<br>Article no.      | Price<br>See price list | Std. pack | Notes  |
|---|--------------|---|------------------------------|-------------------------|-----------|--|
| <b>With protective cover</b><br>                              | Z5-.../FF250 | 24 x 26   | <b>K-B-DIL6AM</b><br>064062  |                         | 1 off     | When using box terminals the protective covers must be used. |
| <b>With control circuit terminal and protective cover</b><br> | Z5-.../FF250 | 24 x 26   | <b>KS-B-DIL6AM</b><br>064063 |                         | 1 off     | When using box terminals the protective covers must be used. |

Engineering

Protection of single-phase and DC current motors:

1 pole

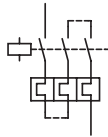

2 pole

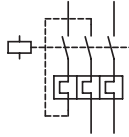

Mounting position:

ZE

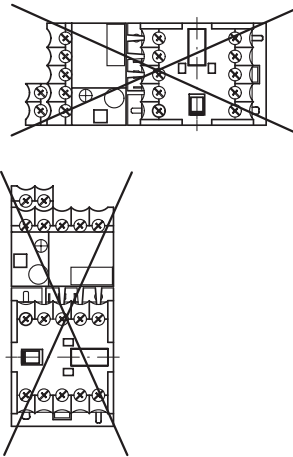

ZB12, ZB32, ZB65, ZB150, Z5

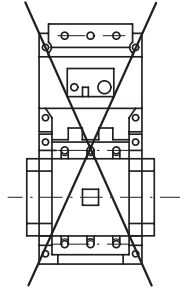

Tripping characteristics

These tripping characteristics are mean values of the spread at 20 °C ambient temperature in a cold state. They show the tripping times in relation to the response current. When the devices are at operational temperature the tripping time of the overload relay drops to approx. 25% of the value shown. Specific characteristics for each individual setting range can be found in the manual on → Page 21

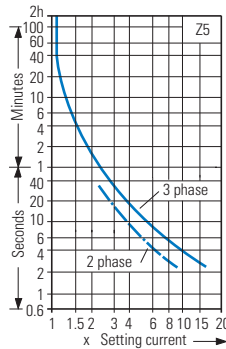
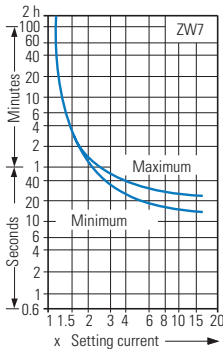
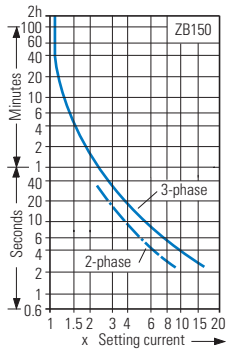
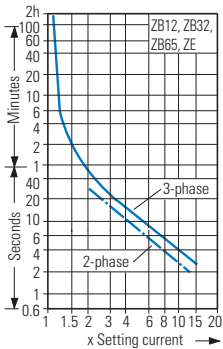

Adaption of ZW7 to smaller rated motor currents

| Number of loops | ZW7 -63                                      | -90     | -125      | -160      | -240    | -290      | -400     | -540    | -630      |
|-----------------|--|---------|-----------|-----------|---------|-----------|----------|---------|-----------|
|                 | <b>Rated motor current I<sub>N</sub> [A]</b> |         |           |           |         |           |          |         |           |
| 1               | 42-63  | 60-90   | 85-125    | 110-160   | 160-240 | 190-290   | 270-400  | 360-540 | 420-630   |
| 2               | 21-31,5                                      | 30-45   | 42,5-62,5 | 55-80     | 80-120  | 95-145    | 135-200  | 180-270 | 210-315   |
| 3               | 14-21  | 20-30   | 28,3-41,7 | 36,7-53,3 | 53,3-80 | 63,3-96,7 | 90-133,3 | 120-180 | 140-210   |
| 4               | 10,5-15,8                                    | 15-22,5 | 21,3-31,3 | 27,5-40   | 40-60   | 47,5-72,5 | 67,5-100 | 90-135  | 105-157,5 |
| 5               | 8,4-12,6                                     | 12-18   | 17-25     | 22-32     | 32-48   | 38-58     | 54-80    | 72-108  | 84-126    |

# 1.2

## Overload relays UL/CSA-short-circuit strength

1

### ZE, ZB, Z5

#### Overload relay short-circuit strength



UL508, CSA-C22,2 No. 14/SCCR values

|               | Fuse acc. to NEC, CEC |     | CB      |    |
|---------------|-----------------------|-----|---------|----|
|               | A                     | kA  | A       | kA |
|               | 600V AC               |     | 480V AC |    |
| ZE-0,16       | 1                     | 5   | 15      | 5  |
| ZE-0,24       | 1                     | 5   | 15      | 5  |
| ZE-0,4        | 1                     | 5   | 15      | 5  |
| ZE-0,6        | 1                     | 5   | 15      | 5  |
| ZE-1,0        | 3                     | 5   | 15      | 5  |
| ZE-1,6        | 6                     | 5   | 15      | 5  |
| ZE-2,4        | 6                     | 5   | 15      | 5  |
| ZE-4          | 15                    | 5   | 15      | 5  |
| ZE-6          | 20                    | 5   | 15      | 5  |
| ZE-9          | 35                    | 5   | 15      | 5  |
| ZE-12         | 45                    | 5   | -       | -  |
|               | 600V AC               |     |         |    |
| ZB12(32)-0,16 | 1 CLASS J/CC          | 100 | -       | -  |
| ZB12(32)-0,24 | 1 CLASS J/CC          | 100 | -       | -  |
| ZB12(32)-0,4  | 1 CLASS J/CC          | 100 | -       | -  |
| ZB12(32)-0,6  | 1 CLASS J/CC          | 100 | -       | -  |
| ZB-12(32)-1,0 | 1 CLASS J/CC          | 100 | -       | -  |
| ZB-12(32)-1,6 | 3 CLASS J/CC          | 100 | -       | -  |
| ZB-12(32)-2,4 | 3 CLASS J/CC          | 100 | -       | -  |
| ZB-12(32)-4   | 6 CLASS J/CC          | 100 | -       | -  |
| ZB-12(32)-6   | 10 CLASS J/CC         | 100 | -       | -  |
| ZB-12(32)-10  | 15 CLASS J/CC         | 100 | -       | -  |
| ZB12-12       | 15 CLASS J/CC         | 100 | -       | -  |
| ZB12-16       | 30 CLASS J/CC         | 100 | -       | -  |
| ZB32-16       | 35 CLASS J            | 100 | -       | -  |
| ZB32-24       | 45 CLASS J            | 100 | -       | -  |
| ZB32-32       | 60 CLASS J            | 100 | -       | -  |
|               | 600V AC               |     | 600V AC |    |
| ZB65-10       | 15 CLASS J            | 100 | 40      | 5  |
| ZB65-16       | 35 CLASS J            | 100 | 60      | 5  |
| ZB65-24       | 45 CLASS J            | 100 | 90      | 5  |
| ZB65-40       | 60 CLASS J            | 100 | 125     | 5  |
| ZB65-57       | 110 CLASS J           | 100 | 150     | 10 |
| ZB65-65       | 125 CLASS J           | 100 | 150     | 10 |
| ZB65-75       | 125 CLASS J           | 100 | 150     | 10 |

|               | Fuse acc. to NEC, CEC |     | CB       |    |
|---------------|-----------------------|-----|----------|----|
|               | A                     | kA  | A        | kA |
|               | 600V AC               |     | 600 V AC |    |
| ZB150-50      | 225                   | 5   | 200      | 5  |
| ZB150-70      | 250                   | 10  | 250      | 10 |
| ZB150-100     | 400 CLASS J           | 10  | 400      | 10 |
| ZB150-125     | 500 CLASS J           | 10  | 500      | 10 |
| ZB150-150     | 600 CLASS J           | 10  | 600      | 10 |
| ZB150-175     | 600 CLASS J           | 10  | 600      | 10 |
| ZB150-50(KK)  | 110 CLASS J           | 100 | 200      | 5  |
| ZB150-70(KK)  | 125 CLASS J           | 100 | 250      | 10 |
| ZB150-100(KK) | 200 CLASS J           | 100 | 400      | 10 |
| ZB150-125(KK) | 250 CLASS J           | 100 | 500      | 10 |
| ZB150-150(KK) | 300 CLASS J           | 100 | 600      | 10 |
| ZB150-175(KK) | 300 CLASS J           | 100 | 600      | 10 |
|               | 600V AC               |     | 600V AC  |    |
| Z5-70/...     | 250                   | 10  | 250      | 10 |
| Z5-100/...    | 400 CLASS J           | 10  | 400      | 10 |
| Z5-125/...    | 500 CLASS J           | 10  | 500      | 10 |
| Z5-160/...    | 600 CLASS J           | 10  | 600      | 10 |
| Z5-220/...    | 800 CLASS J           | 10  | 800      | 10 |
| Z5-250/...    | 700 CLASS J           | 10  | 600      | 10 |
| Z5-70/...     | 125 CLASS J           | 100 | -        | -  |
| Z5-100/...    | 200 CLASS J           | 100 | -        | -  |
| Z5-125/...    | 250 CLASS J           | 100 | -        | -  |
| Z5-160/...    | 300 CLASS J           | 100 | -        | -  |

Technical data

ZE, ZB

|  |           |                 | ZE   | ZB12, ZB32   | ZB65   | ZB150(KK)                      |
|--|-----------|-----------------|--|--|--|--------------------------------|
| <b>General</b>   |           |                 |  |  |  |                                |
| Standards  |           |                 | IEC/EN 60947, VDE 0660, UL, CSA  |  |  |                                |
| Climatic proofing  |           |                 | Damp heat, constant, to IEC 60068-2-78<br>Damp heat, cyclic, to IEC 60068-2-30 |  |  |                                |
| Ambient temperature  |           |                 |  |  |  |                                |
| Open <sup>1)</sup>   | °C        |                 | -25...50   | -25...55   | -25...55   | -25...55                       |
| Enclosed <sup>1)</sup>   | °C        |                 | -25...40   | -25...40   | -25...40   | -25...40                       |
| Temperature compensation   |           |                 | Continuous   |  |  |                                |
| Mounting position  |           |                 | → Page 23  |  |  |                                |
| Weight   | kg        |                 | 0.07   | 0.15   | 0.25   | 1.64                           |
| Mechanical shock resistance half-sinusoidal shock, 10 ms to IEC 60068-2-27 | g         |                 | 10   | 10   | 10   | 10                             |
| Protection type  |           |                 | IP20   | IP20   | IP00   | IP00                           |
| Protection against direct contact when actuated from front (EN 50274)      |           |                 | Finger- and back-of-hand proof   |  |  |                                |
| <b>Main contacts</b>   |           |                 |  |  |  |                                |
| Rated impulse withstand voltage  | $U_{imp}$ | V AC            | 6000   | 6000   | 6000   | 8000                           |
| Overtoltage category/pollution degree                                      |           |                 | III/3  | III/3  | III/3  | III/3                          |
| Rated insulation voltage   |           |                 |  |  |  |                                |
| AC   | $U_i$     | V AC            | 690  | 690  | 690  | 1000                           |
| Rated operating voltage  | $U_e$     | V AC            | 690  | 690  | 690  | 1000                           |
| Safe isolation according to EN 61140                                       |           |                 |  |  |  |                                |
| Between auxiliary contacts and main contacts                               |           | V AC            | 300  | 440  | 440  | 440                            |
| Between the main contacts  |           | V AC            | 300  | 440  | 440  | 440                            |
| Overload relay setting range   |           | A               | 0.1...12   | 0.1...38   | 6...75   | 25...175                       |
| Temperature compensation residual error > 40 °C                            |           | %/K             | ≅ 0.25   | ≅ 0.25   | ≅ 0.25   | ≅ 0.25                         |
| Short-circuit protection rating maximum fuse                               |           |                 | → Page 6   | → Page 8   | → Page 10  | → Page 10                      |
| Current heat loss (3 conductors)   |           |                 |  |  |  |                                |
| Lower value of setting range   |           | W               | 2.5  | 2.5  | 3  | 16                             |
| Upper value of setting range   |           | W               | 6  | 6  | 7.5  | 18                             |
| Terminal capacity  |           |                 |  |  |  |                                |
| Solid  |           | mm <sup>2</sup> | 2 x (0.75 - 2.5)   | 2 x (1 - 6) <sup>5)</sup>                              | 2 x (1 - 16) <sup>4)</sup>                               | 2 x (4 - 16)                   |
| Flexible with ferrule  |           | mm <sup>2</sup> | 2 x (0.5 - 1.5)  | 2 x (1 - 4) <sup>5)</sup><br>2 x (1 - 6) <sup>3)</sup> | 1 x (1...25) <sup>2)</sup><br>2 x (1...10) <sup>2)</sup> | 1 x (4 - 70)<br>2 x (4 - 50)   |
| Stranded   |           | mm <sup>2</sup> | –  | –  | 1 x (16...25)  | 1 x (16...50)<br>2 x (16...50) |
| Solid or stranded  |           | AWG             | 18 - 14  | 14 - 8 <sup>5)</sup>                                   | 14 - 2   | 3/0                            |
| Busbar   | Width     | mm              | –  | –  | –  | –                              |
| Terminal screw   |           |                 | M3.5   | M4   | M6   | M10                            |
| Tightening torque  |           | Nm              | 1.2  | 1.8 <sup>5)</sup>                                      | 3.5  | 10                             |
| <b>Tools</b>   |           |                 |  |  |  |                                |
| Pozi driv screwdriver  |           | Size            | 2  | 2  | 2  | –                              |
| Flat-blade screwdriver   |           | mm              | 0.8 x 5.5  | 1 x 6  | 1 x 6  | –                              |
| Hexagon socket   | SW        | mm              | –  | –  | –  | 5                              |

Notes

- <sup>1)</sup> Ambient temperature: Operating range to IEC/EN 60947, PTB: -5°C to +55°C
- <sup>2)</sup> Use identical cross-section when using two conductors
- <sup>3)</sup> 6 mm flexible with ferrules to DIN 46228
- <sup>4)</sup> With ZB65-XEZ max 1 x (1... 16)
- <sup>5)</sup> ZB32-38: solid and flexible with ferrule, 2.5 - 25 mm<sup>2</sup>, 3 Nm tightening torque. AWG10-b, 27 lb-in tightening torque for solid or stranded conductors.

# 1.2

## Overload relays

### Overload relays, CT-operated overload relays

#### 1 Z5, ZW7

|  |  | Z5-.../FF225A(250)   |                            | ZW7   |
|--|--|--|----------------------------|---|
| <b>General</b>   |  |  |                            |   |
| Standards  |  | IEC/EN 60947, VDE 0660, UL, CSA  |                            | IEC/EN 60947, VDE 0660, UL, CSA   |
| Climatic proofing  |  | Damp heat, constant, to IEC 60068-2-78<br>Damp heat, cyclic, to IEC 60068-2-30 |                            |   |
| Ambient temperature  |  |  |                            |   |
| Open <sup>1)</sup>   | °C                                     | -25...50   |                            | -25...50  |
| Enclosed <sup>1)</sup>   | °C                                     | -25...40   |                            | -25...40  |
| Temperature compensation   |  | Continuous   |                            | Continuous  |
| Mounting position  |  | → Page 23  |                            | Any   |
| Weight   | kg                                     | 1.55   |                            | 0.8   |
| Mechanical shock resistance half-sinusoidal shock, 10 ms to IEC 60068-2-27 | g                                      | 10   |                            | 10  |
| Protection type  |  | IP00   |                            | IP00  |
| Protection against direct contact when actuated from front (EN 50274)      |  | With terminal cover  |                            | Finger- and back-of-hand proof  |
| <b>Main contacts</b>   |  |  |                            |   |
| Rated impulse withstand voltage  | $U_{imp}$                              | V AC   | 8000                       | 6000  |
| Overvoltage category/pollution degree                                      |  |  | III/3                      | III/3   |
| Rated insulation voltage   |  |  |                            |   |
| AC   | $U_i$                                  | V AC   | 1000                       | 690   |
| Rated operating voltage  | $U_e$                                  | V AC   | 1000                       | 690   |
| Safe isolation according to EN 61140                                       |  |  |                            |   |
| Between auxiliary contacts and main contacts                               |  | V AC   | 440                        | 440   |
| Between the main contacts  |  | V AC   | 440                        | 440   |
| Overload relay setting range   |  | A  | 50...300                   | 42...630  |
| Temperature compensation residual error > 40 °C                            |  | %/K  | ≤ 0.25                     | –   |
| Short-circuit protection rating maximum fuse                               |  |  | → Page 12                  | With overload relay in conjunction with a transformer as required for the contactor |
| Current heat loss (3 conductors)   |  |  |                            |   |
| Lower value of setting range   |  | W  | 16                         | 3   |
| Upper value of setting range   |  | W  | 28                         | 10  |
| Terminal capacity  |  |  |                            |   |
| Flexible with ferrule  |  | mm <sup>2</sup>  | 95                         | –   |
| Stranded with ferrule  |  | mm <sup>2</sup>  | 120                        | –   |
| Solid or stranded  |  | AWG  | 250 MCM                    | –   |
| Flat conductor.  | Number of segments x width x thickness | mm   | 6 x 16 x 0.8 <sup>2)</sup> | –   |
| Busbar   | Width                                  | mm   | 20 x 3                     | –   |
| Push-through opening   | ∅                                      | mm   | –                          | 27  |
| Terminal screw   |  |  | M8 x 25                    | –   |
| Tightening torque  |  | Nm   | 24                         | –   |
| Tools  |  |  |                            |   |
| Hexagonal socket   |  | SW   | mm                         | 13  |

#### Notes

<sup>1)</sup> Ambient temperature: Operating range to IEC/EN 60947, PTB: -5°C to +50°C

<sup>2)</sup> Fixing with box terminals

## ZE, ZB, Z5, ZW7

1

|  |           |                 | ZE               | ZB12, ZB32                               | ZB65                                     | ZB150(KK)                                | Z5-.../FF225<br>Z5-.../FF250             | ZW7                                      |
|--|-----------|-----------------|------------------|--|--|--|--|--|
| <b>Auxiliary and control circuits</b>      |           |                 |                  |  |  |  |  |  |
| Rated impulse withstand voltage            | $U_{imp}$ | V               | 6000             | 6000                                     | 6000                                     | 6000                                     | 6000                                     | 6000                                     |
| Overvoltage category/Pollution degree      |           |                 | III/3            | III/3                                    | III/3                                    | III/3                                    | III/3                                    | III/3                                    |
| Terminal capacity                          |           |                 |                  |  |  |  |  |  |
| Solid                                      |           | mm <sup>2</sup> | 2 x (0.75 - 2.5) | 2 x (0.75 - 4)                           | 2 x (0.75 - 4)                           | 2 x (0.75 - 4)                           | 2 x (0.75 - 4)                           | 2 x (0.75 - 4)                           |
| Flexible with ferrule                      |           | mm <sup>2</sup> | 2 x (0.5 - 1.5)  | 2 x (0.75 - 2.5)                         | 2 x (0.75 - 2.5)                         | 2 x (0.75 - 2.5)                         | 2 x (0.75 - 2.5)                         | 2 x (0.75 - 2.5)                         |
| Solid or stranded                          |           | AWG             | 2 x (18 - 12)    | 2 x (18 - 12)                            | 2 x (18 - 12)                            | 2 x (18 - 12)                            | 2 x (18 - 12)                            | 2 x (18 - 12)                            |
| Terminal screw                             |           |                 | M3.5             | M3.5                                     | M3.5                                     | M3.5                                     | M3.5                                     | M3.5                                     |
| Tightening torque                          |           | Nm              | 0.8 - 1.2        | 0.8 - 1.2                                | 0.8 - 1.2                                | 0.8 - 1.2                                | 0.8 - 1.2                                | 0.8 - 1.2                                |
| Tools                                      |           |                 |                  |  |  |  |  |  |
| Pozidriv screwdriver                       |           | Size            | 2                | 2  | 2  | 2  | 2  | 2  |
| Flat-blade screwdriver                     |           | mm              | 0.8 x 5.5        | 1 x 6                                    | 1 x 6                                    | 1 x 6                                    | 1 x 6                                    | 1 x 6                                    |
| Auxiliary circuit rated insulation voltage | $U_i$     | V AC            | 690              | 500                                      | 500                                      | 500                                      | 500                                      | 500                                      |
| Rated operating voltage                    | $U_e$     | V AC            | 500              | 500                                      | 500                                      | 500                                      | 500                                      | 500                                      |
| Safe isolation according to EN 61140       |           |                 |                  |  |  |  |  |  |
| Between the auxiliary contacts             |           | V AC            | 300              | 240                                      | 240                                      | 240                                      | 240                                      | 240                                      |
| Conventional thermal current               | $I_{th}$  | A               | 6                | 6  | 6  | 6  | 6  | 6  |
| Rated operational current                  |           |                 |                  |  |  |  |  |  |
| AC-15                                      |           |                 |                  |  |  |  |  |  |
| N/O  |           |                 |                  |  |  |  |  |  |
| 120 V                                      | $I_e$     | A               | 1.5              | 1.5                                      | 1.5                                      | 1.5                                      | 1.5                                      | 1.5                                      |
| 240 V                                      | $I_e$     | A               | 1.5              | 1.5                                      | 1.5                                      | 1.5                                      | 1.5                                      | 1.5                                      |
| 415 V                                      | $I_e$     | A               | 0.5              | 0.5                                      | 0.5                                      | 0.5                                      | 0.5                                      | 0.5                                      |
| 500 V                                      | $I_e$     | A               | 0.3              | 0.5                                      | 0.5                                      | 0.5                                      | 0.5                                      | 0.5                                      |
| NC   |           |                 |                  |  |  |  |  |  |
| 120 V                                      | $I_e$     | A               | 1.5              | 1.5                                      | 1.5                                      | 1.5                                      | 1.5                                      | 1.5                                      |
| 240 V                                      | $I_e$     | A               | 1.5              | 1.5                                      | 1.5                                      | 1.5                                      | 1.5                                      | 1.5                                      |
| 415 V                                      | $I_e$     | A               | 0.7              | 0.9                                      | 0.9                                      | 0.9                                      | 0.9                                      | 0.9                                      |
| 500 V                                      | $I_e$     | A               | 0.5              | 0.8                                      | 0.8                                      | 0.8                                      | 0.8                                      | 0.8                                      |
| DC-13 L/R $\leq 15$ ms <sup>1)</sup>       |           |                 |                  |  |  |  |  |  |
| 24 V                                       | $I_e$     | A               | 0.9              | 0.9                                      | 0.9                                      | 0.9                                      | 0.9                                      | 0.9                                      |
| 60 V                                       | $I_e$     | A               | 0.75             | 0.75 <sup>3)</sup>                       | 0.75 <sup>3)</sup>                       | 0.75 <sup>3)</sup>                       | 0.75 <sup>3)</sup>                       | 0.75 <sup>3)</sup>                       |
| 110 V                                      | $I_e$     | A               | 0.4              | 0.4                                      | 0.4                                      | 0.4                                      | 0.4                                      | 0.4                                      |
| 220 V                                      | $I_e$     | A               | 0.2              | 0.2                                      | 0.2                                      | 0.2                                      | 0.2                                      | 0.2                                      |
| General Use                                |           |                 |                  |  |  |  |  |  |
| AC operated                                |           | V               | 240<br>600       | –  | –  | –  | –  | –  |
| AC operated                                |           | A               | 1.5<br>0.6       | –  | –  | –  | –  | –  |
| DC operated                                |           | V               | –                | –  | –  | –  | –  | –  |
| DC operated                                |           | A               | –                | –  | –  | –  | –  | –  |
| Pilot Duty                                 |           |                 |                  |  |  |  |  |  |
| AC operated                                |           |                 | D300             | B300 <sup>4)</sup><br>B600 <sup>5)</sup> | B300 <sup>4)</sup><br>B600 <sup>5)</sup> | B300 <sup>4)</sup><br>B600 <sup>5)</sup> | B300 <sup>4)</sup><br>B600 <sup>5)</sup> | B300 <sup>4)</sup><br>B600 <sup>5)</sup> |
| DC operated                                |           |                 | R300             | R300                                     | R300                                     | R300                                     | R300                                     | R300                                     |
| Short-circuit rating without welding       |           |                 |                  |  |  |  |  |  |
| Max. fuse <sup>2)</sup>                    |           | A gG/gL         | 4                | 6  | 6  | 6  | 6  | 6  |

### Notes

- <sup>1)</sup> Making and breaking conditions to DC-13, time constant as stated
- <sup>2)</sup> See transparent overlay "Fuses" for time/current characteristics (please enquire)
- <sup>3)</sup> Rated operational current DC-13, 60 V: N/O auxiliary contact 0.6 A
- <sup>4)</sup> With opposite polarity
- <sup>5)</sup> With same polarity

# 1.2 Electronic overload relays to 1500 A

## ZEB

1

|  |  |                 |                  | ZEB12, ZEB32     | ZEB65-45         | ZEB65-100        | ZEB150           |
|--|--|-----------------|------------------|------------------|------------------|------------------|------------------|
| <b>General</b>   |  |                 |                  |                  |                  |                  |                  |
| Standards  | IEC/EN 60947, VDE 0660, UL, CSA  |                 |                  |                  |                  |                  |                  |
| Climatic proofing  | Damp heat, constant, to IEC 60068-2-78<br>Damp heat, cyclic, to IEC 60068-2-30 |                 |                  |                  |                  |                  |                  |
| Ambient temperature  |  |                 |                  |                  |                  |                  |                  |
| Open   | °C   |                 | -25...65         | -25...65         | -25...65         | -25...65         | -25...65         |
| Enclosed   | °C   |                 | -25...65         | -25...40         | -25...40         | -25...40         | -25...40         |
| Temperature compensation   | Continuous   |                 |                  |                  |                  |                  |                  |
| Mounting position  | Any  |                 |                  |                  |                  |                  |                  |
| Mechanical shock resistance half-sinusoidal shock, 10 ms to IEC 60068-2-27 | g  |                 | 15               | 15               | 15               | 15               | 15               |
| Protection type  | IP20   |                 |                  |                  |                  |                  |                  |
| Protection against direct contact when actuated from front (EN 50274)      | Finger- and back-of-hand proof   |                 |                  |                  |                  |                  |                  |
| <b>Main contacts</b>   |  |                 |                  |                  |                  |                  |                  |
| Rated impulse withstand voltage  | $U_{imp}$  | V AC            | 6000             | 6000             | 6000             | 6000             | 6000             |
| Overvoltage category/pollution degree                                      | III / 3  |                 |                  |                  |                  |                  |                  |
| Rated insulation voltage   |  |                 |                  |                  |                  |                  |                  |
| AC   | $U_i$  | V AC            | 690              | 690              | 690              | 690              | 690              |
| Rated operating voltage  | $U_e$  | V AC            | 690              | 690              | 690              | 690              | 690              |
| Safe isolation according to EN 61140                                       |  |                 |                  |                  |                  |                  |                  |
| Between auxiliary contacts and main contacts                               |  | V AC            | 600              | 600              | 600              | 600              | 600              |
| Between the main contacts  |  | V AC            | 600              | 600              | 600              | 600              | 600              |
| Overload relay setting range   |  | A               | 0.3...45         | 9...45           | 20...100         | 20...100         | 20...100         |
| Terminal capacity  |  |                 |                  |                  |                  |                  |                  |
| Solid  |  | mm <sup>2</sup> | 1 x 2.5 - 16     | 1 x 2.5 - 16     | 1 x 6 - 50       | 1 x 6 - 50       | 1 x 6 - 50       |
| Solid or stranded  |  | AWG             | 1 x 14 - 4       | 1 x 14 - 4       | 1 x 10 - 1       | 1 x 10 - 1       | 1 x 10 - 1       |
| <b>Auxiliary and control circuits</b>                                      |  |                 |                  |                  |                  |                  |                  |
| Rated impulse withstand voltage  | $U_{imp}$  | V               | 6000             | 6000             | 6000             | 6000             | 6000             |
| Overvoltage category/pollution degree                                      | III / 3  |                 |                  |                  |                  |                  |                  |
| Terminal capacity  |  |                 |                  |                  |                  |                  |                  |
| Solid  |  | mm <sup>2</sup> | 2 x (0.75 - 4)   | 2 x (0.75 - 4)   | 2 x (0.75 - 4)   | 2 x (0.75 - 4)   | 2 x (0.75 - 4)   |
| Flexible with ferrule  |  | mm <sup>2</sup> | 2 x (0.75 - 2.5) | 2 x (0.75 - 2.5) | 2 x (0.75 - 2.5) | 2 x (0.75 - 2.5) | 2 x (0.75 - 2.5) |
| Solid or stranded  |  | AWG             | 2 x (18 - 12)    | 2 x (18 - 12)    | 2 x (18 - 12)    | 2 x (18 - 12)    | 2 x (18 - 12)    |
| Terminal screw   |  |                 | M3.5             | M3.5             | M3.5             | M3.5             | M3.5             |
| Terminal screw   |  | Nm              | 0.8 - 1.2        | 0.8 - 1.2        | 0.8 - 1.2        | 0.8 - 1.2        | 0.8 - 1.2        |
| Tightening torque  |  | lb-in           | 7 - 10.6         | 7 - 10.6         | 7 - 10.6         | 7 - 10.6         | 7 - 10.6         |
| Tools  |  |                 |                  |                  |                  |                  |                  |
| Pozidriv screwdriver   |  | Size            | 2                | 2                | 2                | 2                | 2                |
| Flat-blade screwdriver   |  | mm              | 1 x 6            | 1 x 6            | 1 x 6            | 1 x 6            | 1 x 6            |
| Auxiliary circuit rated insulation voltage                                 | $U_i$  | V AC            | 500              | 500              | 500              | 500              | 500              |
| Rated operating voltage  | $U_e$  | V AC            | 500              | 500              | 500              | 500              | 500              |
| Safe isolation according to EN 61140                                       |  |                 |                  |                  |                  |                  |                  |
| Between the auxiliary contacts   |  | V AC            | 240              | 240              | 240              | 240              | 240              |
| Conventional thermal current   | $I_{th}$   | A               | 5                | 5                | 5                | 5                | 5                |
| Rated operational current  |  |                 |                  |                  |                  |                  |                  |
| AC-15  |  |                 |                  |                  |                  |                  |                  |
| N/O  |  |                 |                  |                  |                  |                  |                  |
| 120 V  | $I_e$  | A               | 1.5              | 1.5              | 1.5              | 1.5              | 1.5              |
| 240 V  | $I_e$  | A               | 1.5              | 1.5              | 1.5              | 1.5              | 1.5              |
| 415 V  | $I_e$  | A               | 0.5              | 0.5              | 0.5              | 0.5              | 0.5              |
| 500 V  | $I_e$  | A               | 0.5              | 0.5              | 0.5              | 0.5              | 0.5              |
| NC   |  |                 |                  |                  |                  |                  |                  |
| 120 V  | $I_e$  | A               | 1.5              | 1.5              | 1.5              | 1.5              | 1.5              |
| 240 V  | $I_e$  | A               | 1.5              | 1.5              | 1.5              | 1.5              | 1.5              |
| 415 V  | $I_e$  | A               | 0.9              | 0.9              | 0.9              | 0.9              | 0.9              |
| 500 V  | $I_e$  | A               | 0.8              | 0.8              | 0.8              | 0.8              | 0.8              |
| DC-13 L/R $\leq$ 15 ms   |  |                 |                  |                  |                  |                  |                  |
| 24 V   | $I_e$  | A               | 0.9              | 0.9              | 0.9              | 0.9              | 0.9              |
| 60 V   | $I_e$  | A               | 0.75             | 0.75             | 0.75             | 0.75             | 0.75             |
| 110 V  | $I_e$  | A               | 0                | 0                | 0.4              | 0.4              | 0.4              |
| 220 V  | $I_e$  | A               | 0.2              | 0.2              | 0.2              | 0.2              | 0.2              |
| Short-circuit rating without welding                                       |  |                 |                  |                  |                  |                  |                  |
| Max. fuse  |  | A gG/gL         | 6                | 6                | 6                | 6                | 6                |

EMT6

EMT6

1

| <b>General</b>  |                 |          |   |
|---|-----------------|----------|---|
| Standards   |                 |          | IEC/EN 60947, VDE 0660, EN 55011  |
| Climatic proofing   |                 |          | Damp heat, constant, to IEC 60068-2-78;<br>Damp heat, cyclic, to IEC 60068-2-30 |
| Ambient temperature   |                 |          |   |
| Open  | °C              |          | -25...60  |
| Enclosed  | °C              |          | -25...45  |
| Storage   | °C              |          | -45 - 60  |
| Mounting position   |                 |          | Any   |
| Weight  | kg              |          | 0.15  |
| Shock resistance half-sinusoidal shock 10 ms to IEC 60068-2-27        | g               |          | 10  |
| Protection type   |                 |          | IP20  |
| Protection against direct contact when actuated from front (EN 50274) |                 |          | Finger- and back-of-hand proof  |
| Safe isolation according to EN 61140                                  |                 |          |   |
| Between the contacts  | V AC            |          | 250   |
| Between contacts and supply voltage                                   | V AC            |          | 250   |
| <b>Auxiliary and control circuits</b>                                 |                 |          |   |
| Rated impulse withstand voltage                                       | $U_{imp}$       | V AC     | 6000  |
| Overtoltage category/pollution degree                                 |                 |          | III/3   |
| Auxiliary and control circuit terminal capacity                       |                 |          |   |
| Solid   | mm <sup>2</sup> |          | 1 x 2.5<br>2 x (0.5 - 1.5)  |
| Flexible with ferrule   | mm <sup>2</sup> |          | 1 x 2.5<br>2 x (0.5 - 1.5)  |
| Solid or stranded   | AWG             |          | 20 - 14   |
| Terminal screw  |                 |          | M3.5  |
| Tightening torque   | Nm              |          | 1.2   |
| Tools   |                 |          |   |
| Pozidriv screwdriver  | Size            |          | 2   |
| Flat-blade screwdriver  | mm              |          | 1 x 6   |
| <b>Auxiliary circuit</b>  |                 |          |   |
| Rated insulation voltage  | $U_i$           | V        | 400   |
| Rated operational current   |                 |          |   |
| AC-14   |                 |          |   |
| N/O   |                 |          |   |
| 415 V   | $I_e$           | A        | 3   |
| NC  |                 |          |   |
| 415 V   | $I_e$           | A        | 3   |
| AC-15   |                 |          |   |
| N/O   |                 |          |   |
| 240 V   | $I_e$           | A        | 3   |
| 415 V   | $I_e$           | A        | 1   |
| NC  |                 |          |   |
| 240 V   | $I_e$           | A        | 3   |
| 415 V   | $I_e$           | A        | 1   |
| Max. short-circuit protective device                                  |                 |          |   |
| Fuse  | gG/gL           |          | 6   |
| <b>Control circuit</b>  |                 |          |   |
| Rated insulation voltage  | $U_i$           | V        | 240   |
| Rated operational voltage   | $U_e$           | V        | 240 <sup>1)</sup>   |
| Voltage tolerance   |                 | x $U_e$  | 0.85 - 1.1  |
| Power consumption   |                 |          |   |
| AC  |                 | VA       | 3.5   |
| DC  |                 | W        | 2   |
| Trip at approx.   |                 | $\Omega$ | $\cong$ 3600  |
| Reset at approx.  |                 | $\Omega$ | $\cong$ 1600  |

Notes

<sup>1)</sup> EMT6(-DB)230V:  $U_e = 230$  V



# 1.2

## Overload relays

Overload relays

### 1 Dimensions

#### Overload relays

ZE-...

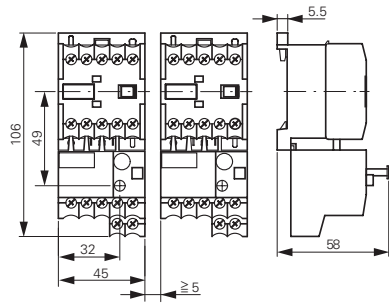

#### Base

ZB32-XEZ

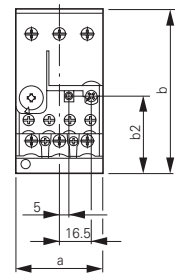

ZB65-XEZ

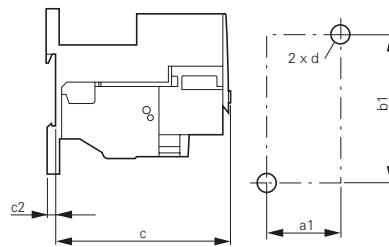

|    | ZB32 | ZB65 |
|----|------|------|
| a  | 45   | 60   |
| b  | 85   | 86   |
| c  | 90.5 | 112  |
| c2 | 3.8  | 4.7  |
| a1 | 35   | 50   |
| b1 | 75   | 75   |
| b2 | 40.5 | 47   |
| d  | M4   | M5   |

ZB12

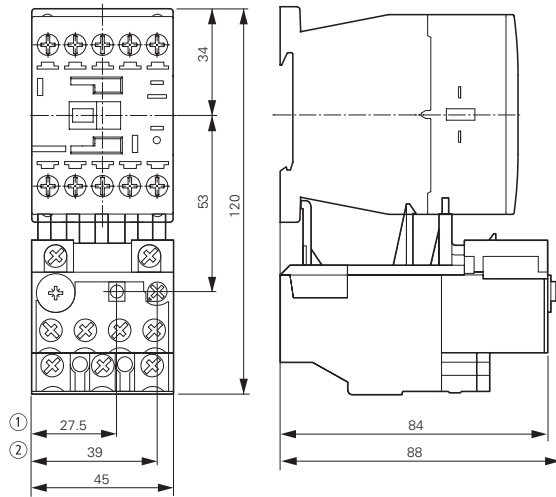

- ① OFF
- ② Reset/ON

ZB32

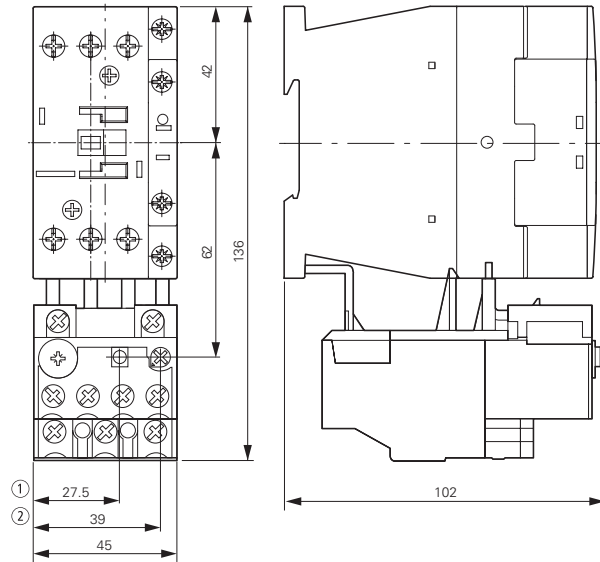

ZB32-38

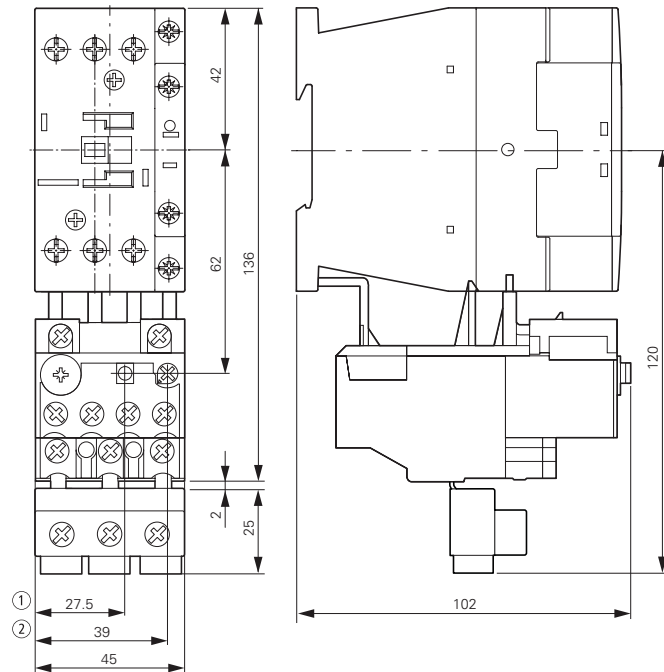

- ① OFF
- ② Reset/ON

Overload relays

ZB65

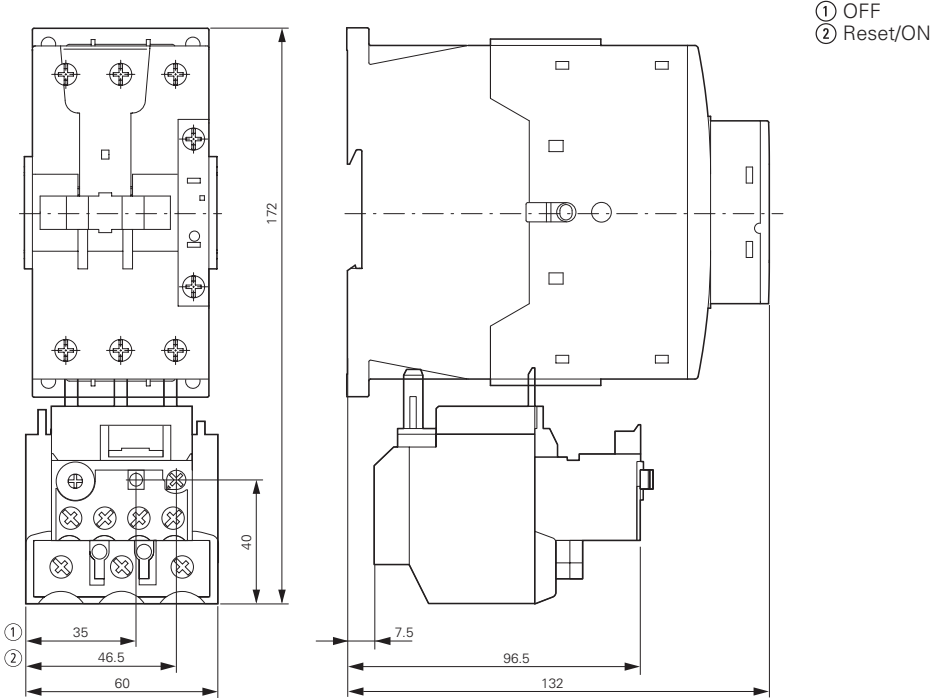

ZB150

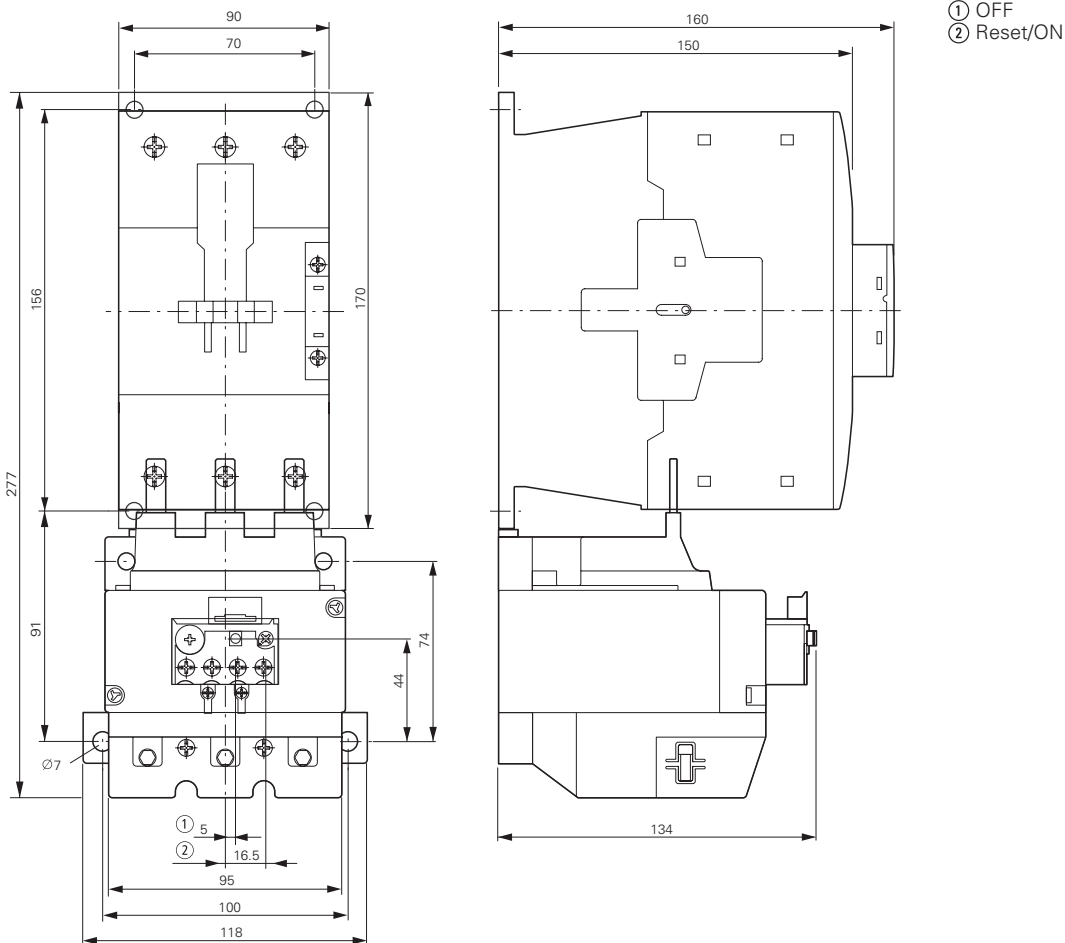

# 1.2

## Overload relays

Overload relays, CT-operated overload relays

### 1 Overload relays

ZB150-50/KK

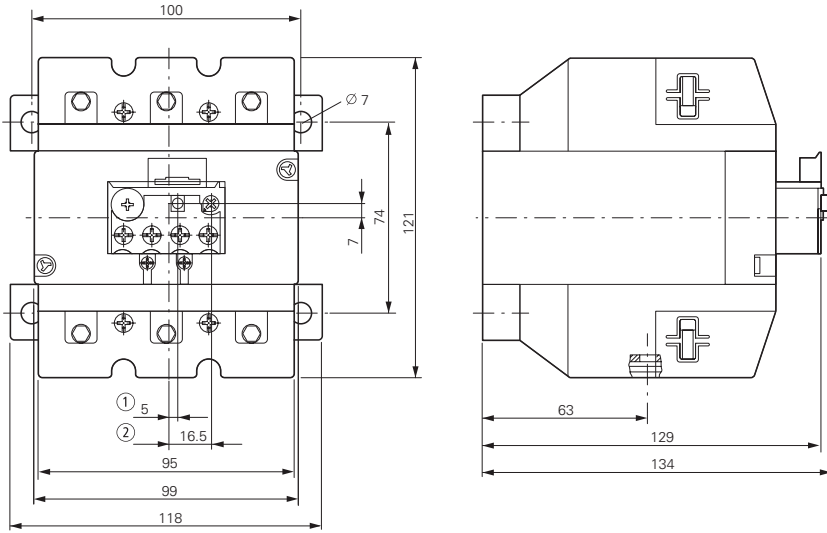

- ① OFF
- ② Reset/ON

### Z5 overload relays greater than 150A

Z5.../FF250

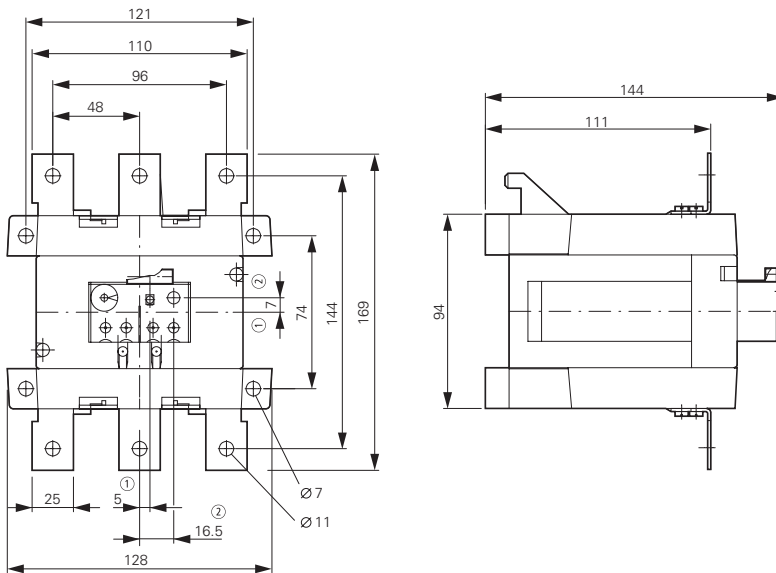

- ① OFF
- ② Reset/ON

### Current transformer-operated overload relays

ZW7-...

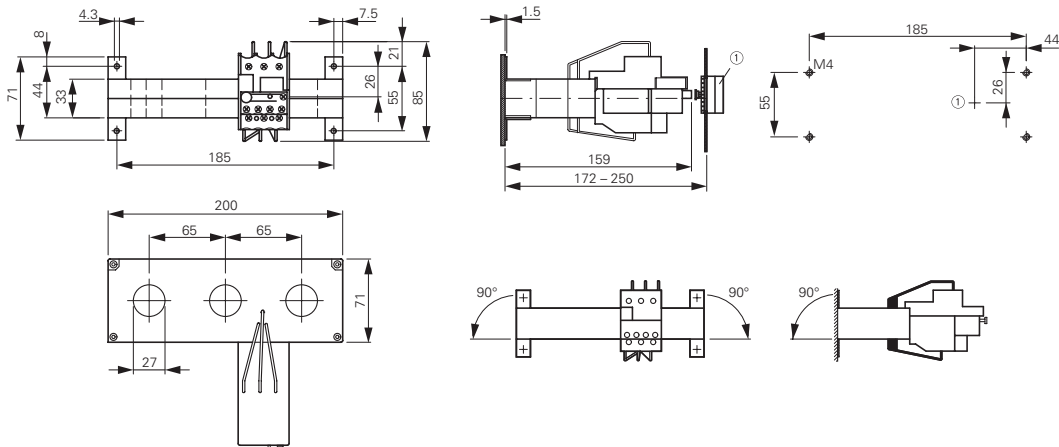

- ① Reset/ON

Electronic overload relays

ZEB12

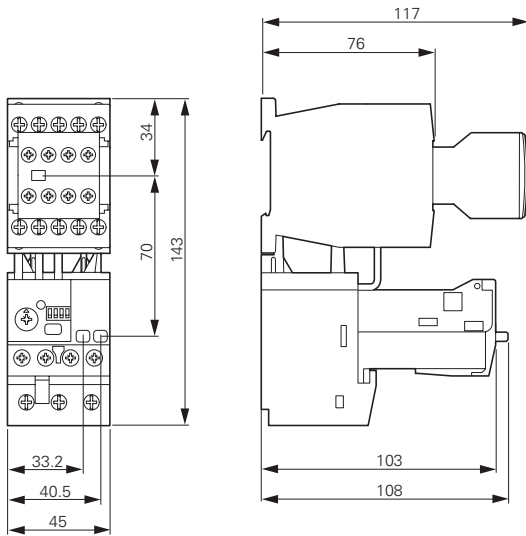

ZEB32

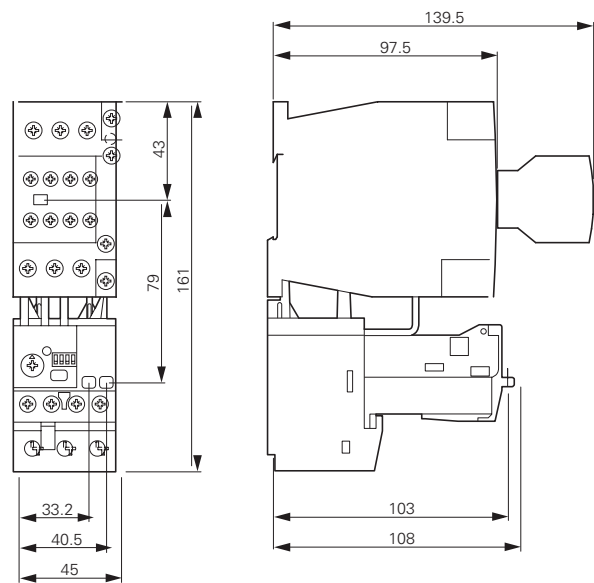

ZEB65-45

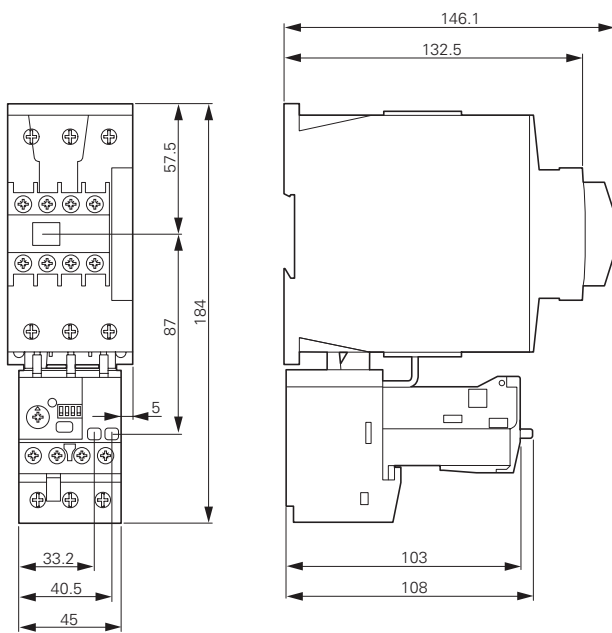

ZEB65-100

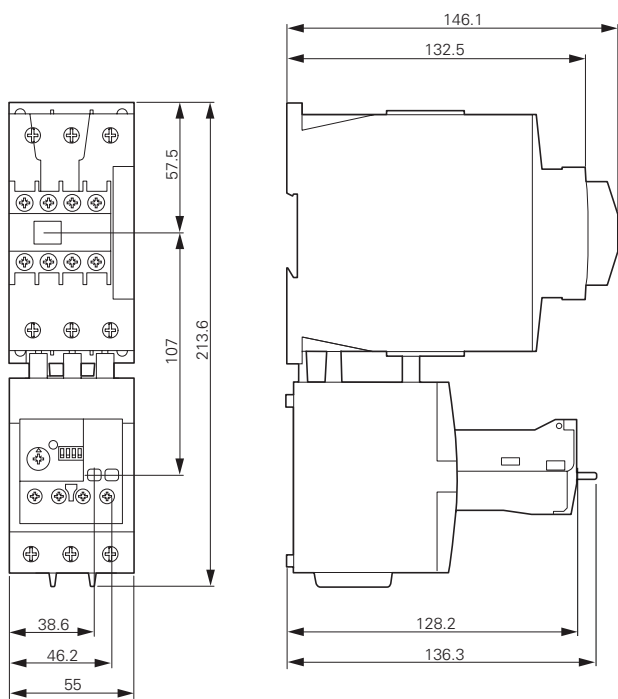

# 1.2

## Overload relays

Electronic overload relays

### 1 Electronic overload relays

ZEB150-100

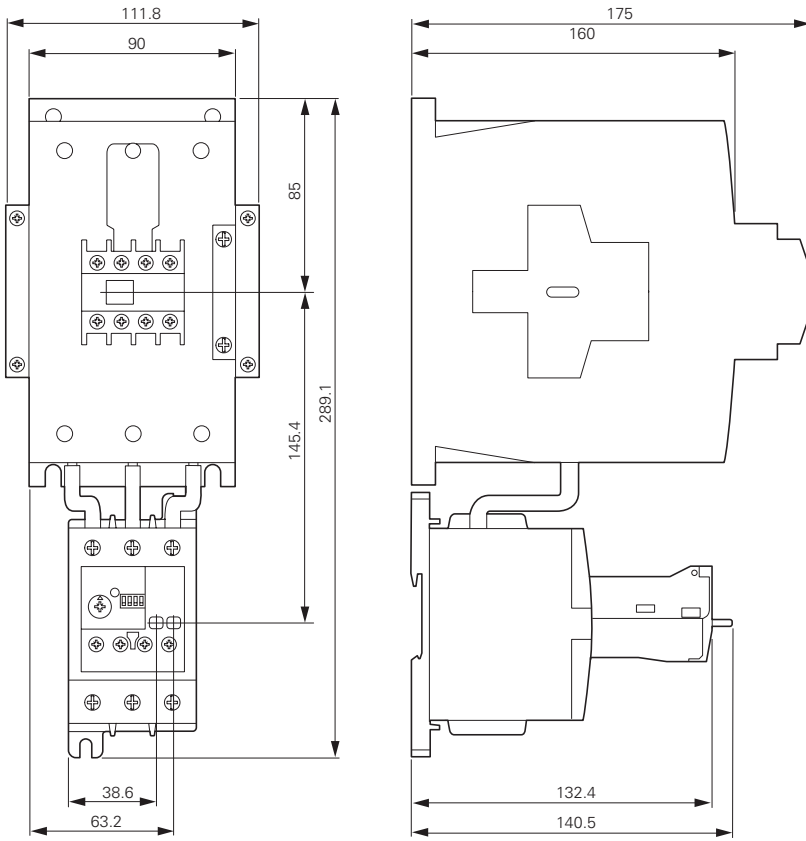

ZEB150-100/KK

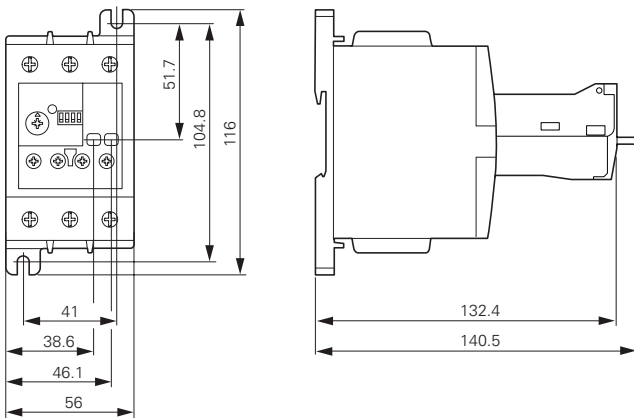

Current sensors

ZEB-XCT300

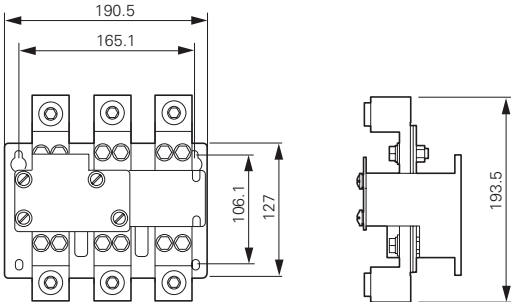

ZEB-XCT600

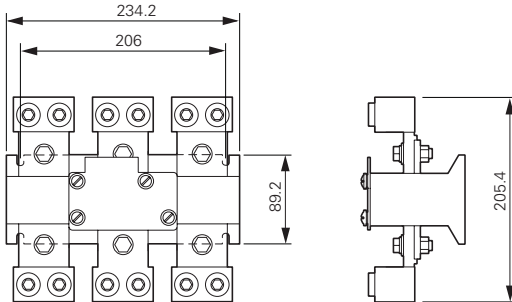

ZEB-XCT1000  
ZEB-XCT1500

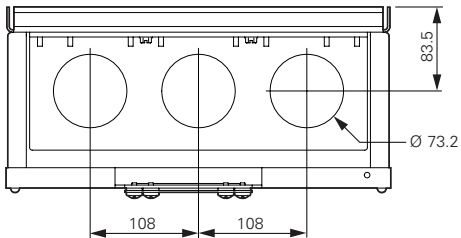
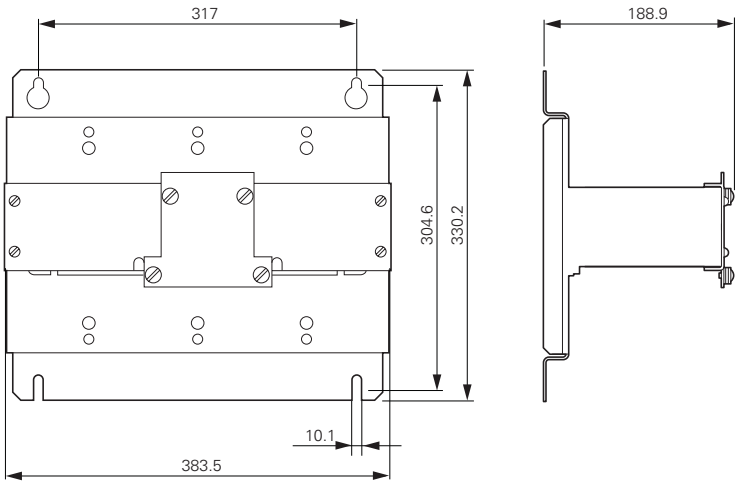

EMT6 thermistor overload relays for machine protection

EMT6...

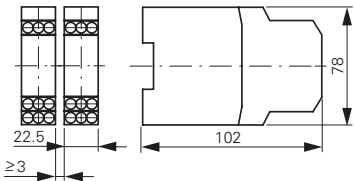

External reset button

M22-DZ-B  
M22-DZ-X

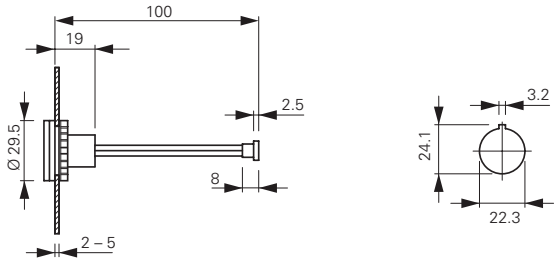

**C441 overload and monitoring relay**



**C441 overload and monitoring relay**

|   |    |
|---|----|
| Features and benefits . . . . .             | 38 |
| Catalog number selection . . . . .          | 41 |
| Product selection . . . . .                 | 42 |
| Accessories . . . . .                       | 43 |
| Technical data and specifications . . . . . | 48 |
| Dimensions . . . . .                        | 60 |

1

**C441 overload and monitoring relay**

**Product description**

Eaton’s Motor Insight, the first product in the Intelligent Power Control Solutions family, is a highly configurable motor, load and line protection device with power monitoring, diagnostics and flexible communications allowing the customer to save energy, optimize their maintenance schedules and configure greater system protection, thus reducing overall costs and downtime.

Motor Insight is available in either a line-powered or 120 Vac control powered design, capable of monitoring voltages up to 660 Vac. Each of these units is available in a 1–9 amp or a 5–90 amp FLA model. With external CTs, Motor Insight can protect motors up to 540 amps FLA. Available add-on accessories include communication modules for Modbus RTU, DeviceNet, PROFIBUS, Modbus TCP, EtherNet/IP and HTTP web services all with I/O options. For ease-of-use and operator safety, Motor Insight offers a remote display that mounts easily with two 30 mm knockouts.

# 1.2

## C441 overload and monitoring relay

### Features and benefits

#### 1 Features and Benefits

##### Features

###### Size/Range

- Broad FLA range of 1–540A
- Selectable trip class (5–30)
- Four operating voltage options
  - Line-powered from 240 Vac, 480 Vac, 600 Vac
  - Control-powered from 120 Vac

###### Motor Control

- Two output relays
  - One B300 Form C fault relay and one B300 ground fault shunt relay
  - Other relay configurations are available, including one Form A and one Form B SPST (fault and auxiliary relays) allowing programmable isolated relay behavior and unique voltages
- One external remote reset terminal
- Trip status indicator

###### Motor Protection

- Thermal overload
- Jam protection
- Current imbalance
- Current phase loss
- Ground fault
- Phase reversal

###### Load Protection

- Under current
- Low power (kW)
- High power (kW)

###### Standards and Certifications

- cULus listed NKCR, NKCR7, 508
- UL® 1053 applicable sections for ground fault detection
- CSA® certified (Class 3211-02)
- CE
- NEMA®

##### Benefits

###### Reliability and Improved Uptime

- Advanced diagnostics allows for quick and accurate identification of the root source of a motor, pump or power quality fault; reducing troubleshooting time and the loss of productivity, reducing repeat faults due to misdiagnosis, and increasing process output and profitability
- Provides superior protection of motors and pumps before catastrophic failure occurs
- Increases profitability with greater process uptime and throughput, reduced costs per repair, reduced energy consumption and extended equipment life
- Adjustments to overload configuration can be made at any time

###### Safety

- IP20 rated terminal blocks
- Terminal blocks are set back from the display to reduce operator shock hazard
- Remote display (optional) does not require that the operator open the panel to configure the device

###### Flexibility

- Communications modules
  - Offered in a variety of configurations
  - External snap-on modules provide support for multiple communications protocols
- Advanced power, voltage and current monitoring capabilities
- Communications modules and remote display can be used simultaneously
- Highly configurable fault and reset characteristics for numerous applications
- Fully programmable isolated fault and auxiliary relays

###### Ease of Use

- Bright LED display with easy-to-understand setting and references
- Powered from line voltage or 120 Vac control power
- Remote display powered from base unit
- Full word descriptions and units on user interface

- IEC EN 60947-4-1
- RoHS
- CCC





### Advanced Overload Education

| Description                             | Definition   | Source  | Result   | Motor Insight Protection  |
|---|--|---|--|---|
| <b>Motor Protection</b>                 |  |   |  |   |
| Thermal overload                        | Overload is a condition in which current draw to a motor exceeds 115% of the full load amperage rating over a period of time for an inductive motor. | <p>An increase in the load or torque that is being driven by the motor.</p> <p>A low voltage supply to the motor would cause the current to go high to maintain the power needed.</p> <p>A poor power factor would cause above normal current draw.</p> | Increase in current draw. Current leads to heat and insulation breakdown, which can cause system failure. Additionally, an increase in current can increase power consumption and waste valuable energy.                                       | <p>Thermal trip behavior is defined by UL, CSA and IEC standards.</p> <p>Trip class is settable from 5–30 by 1</p> <p>Provides power factor monitoring and low voltage protection features.</p>   |
| Jam                                     | Jam is similar to thermal overload in that it is a current draw on the motor above normal operating conditions.                                      | Mechanical stall, interference, jam or seizure of the motor or motor load.  | The motor attempts to drive the load, which has more resistive force due to the mechanical interference. In order to drive the load, the motor draws an abnormal amount of current, which can lead to insulation breakdown and system failure. | <p>Provides a configurable Jam setting that is active during “motor run state” to avoid nuisance trips.</p> <p>Trip Threshold 150–400% of FLA.</p> <p>Trip Delay 1–20 seconds.</p>  |
| Ground fault                            | A line to ground fault.  | A current leakage path to ground.   | An undetected ground fault can burn through multiple insulation windings, ultimately leading to motor failure.   | <p>Motor Insight has ground fault protection capability down to 0.15 amps estimated from the existing three-phase CTs using the residual current method. That is, the three-phase current signals should sum to zero unless a ground fault (GF) condition is present. In the case of a GF, Motor Insight can alarm, trip the starter, or trip an alternative relay that can be used to shunt trip a breaker or light up a warning light. GF current can also be monitored in real-time through the advanced monitoring capabilities.</p> <p><b>Note:</b> GF settable thresholds vary with motor FLA. 0.15 amps may not be available in all cases.</p> |
| Imbalanced phases (voltage and current) | Uneven voltage or currents between phases in a three-phase system.   | When a three-phase load is powered with a poor quality line, the voltage per phase may be imbalanced.   | Imbalanced voltage causes large imbalanced currents and as a result this can lead to motor stator windings being overloaded, causing excessive heating, reduced motor efficiency and reduced insulation life.                                  | Provides two protection settings that address this problem. The user can choose to set current imbalance thresholds or voltage imbalance thresholds, each of which can trip the starter. Additionally, both of these may be monitored through Motor Insight’s advanced monitoring capabilities, allowing the customer to notice in real-time when and where a condition is present.   |
| Phase loss—current (single-phasing)     | One of the three-phase current is not present.   | Multiple causes, loose wire, improper wiring, grounded phase, open fuse, and so on.   | Single-phasing can lead to unwanted motor vibrations in addition to the results of imbalanced phases as listed above.  | Fixed protective setting that takes the starter offline if a phase drops below 60% of the other two phases.   |
| Phase rotation (phase-reversal)         | Improper wiring, leading to phases being connected to the motor improperly.  | A miswired motor. Inadvertent phase-reversal by the utility.  | Phase-reversal can cause unwanted directional rotation of a motor. In the event that the load attached to the motor can only be driven in one direction, the result could be significant mechanical failure and/or injury to an operator.      | Configurable phase protection, allowing the user to define the phase sequencing intended for that application. If no phase sequence is required, the user has the ability to disable this feature.  |
| Frequency variance                      | When line frequency is inconsistent.   | Malfunctioning alternator speed regulator, or poor line quality caused by an overload of a supply powered by individual sources.  | Variations in frequency can cause increases in losses, decreasing the efficiency of the motor. In addition, this can result in interference with synchronous devices.  | Advanced monitoring capabilities allow the user to monitor frequency in real-time.  |

# 1.2

## C441 overload and monitoring relay

### Features and benefits

#### 1 Advanced Overload Education, continued

| Description                | Definition  | Source  | Result  | Motor Insight Protection   |
|----------------------------|---|---|---|--|
| <b>Load Protection</b>     |   |   |   |  |
| Under current or low power | Average rms current provided to the motor falls below normal operating conditions.  | Under current is usually associated with a portion of the user's load disappearing. Examples of this would be a broken belt, a dry-pump (low suction head) or a dead-headed centrifugal pump.   | If under current goes undetected, a mechanical failure can and has occurred. In the case of a pump, running a pump dry or running a pump in a dead-headed condition can cause excessive heating, damaging expensive seals and breaking down desired fluid properties.   | Motor Insight has two protection settings to detect this: under current and low power. Low power is a more consistent way of ensuring detection as power is linear with motor load, where as current is not. An unloaded motor may draw 50% of its rated current, but the power draw will be less than 10% of rated power due to a low power factor. |
| High power                 | The motor load is drawing more power than it should at normal operating conditions. | This is typical of batch processing applications where several ingredients flow into a mixer. When a substance's consistency changes and viscosity increases from what is expected, the motor may use more power to blend the mixture. Out-of-tolerance conditions can be detected using the High Power and Low Power settings. | If a high-power fault goes undetected, the result may be a batch of material that does not meet specification.  | Monitors the three-phase real power. If the real power value is estimated above the set threshold for the set length of time, a fault is detected and the overload will trip the starter. Additionally, power can be monitored in real-time.   |
| <b>Line Protection</b>     |   |   |   |  |
| Over voltage               | When the line voltage to the motor exceeds the specified rating.                    | Poor line quality.  | An over voltage condition leads to a lower than rated current draw and a poor power factor. A trip limit of 110% of rated voltage is recommended. Over voltage can also lead to exceeding insulation ratings.   | Monitors the maximum rms value of the three-phase voltages. If the rms value rises above the set threshold for the set length of time, a fault is detected and the overload can trip the starter or send and display an alarm of the condition. All line-related faults have an "alarm-no-trip" mode.  |
| Under voltage              | When the line voltage to the motor is below the specified rating.                   | Poor line quality.  | An under voltage condition leads to excessive current draw. This increases the heating of the motor windings and can shorten insulation life. A trip limit set to 90% of rated voltage is recommended.  | Monitors the minimum rms value of the three-phase voltages. If the rms value drops below the set threshold for the set length of time, a fault is detected and the overload can trip the starter or send and display an alarm of the condition. All line-related faults have an "alarm-no-trip" mode.  |
| Power-up delay             | Allows for starting motors and loads in a deliberate fashion.                       | When there is a power failure, or power cycle, multiple loads come online simultaneously.   | Multiple loads starting simultaneously can cause sags affecting the operation of devices that may prevent successful startup.<br><br>If power is lost to a motor driving a pump, it may be necessary to delay a restart to allow the pump to come to a complete stop to prevent starting a motor during backspin. | Configurable to delay closing the fault relay on power-up. For each Motor Insight controlling a motor, a different setting can be programmed, helping to maintain the integrity of your line power.  |

## Catalog Number Selection

### Motor Insight Overload Relays

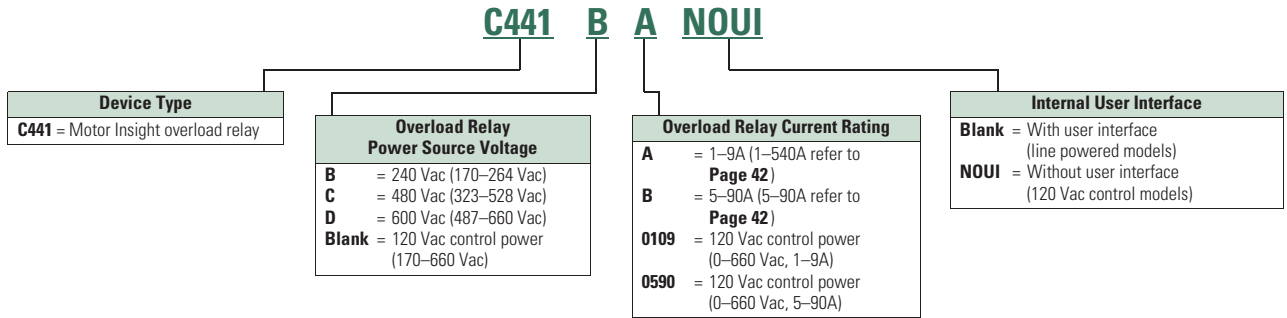

### Motor Insight Overload Relays—Communications Modules and Accessory Types

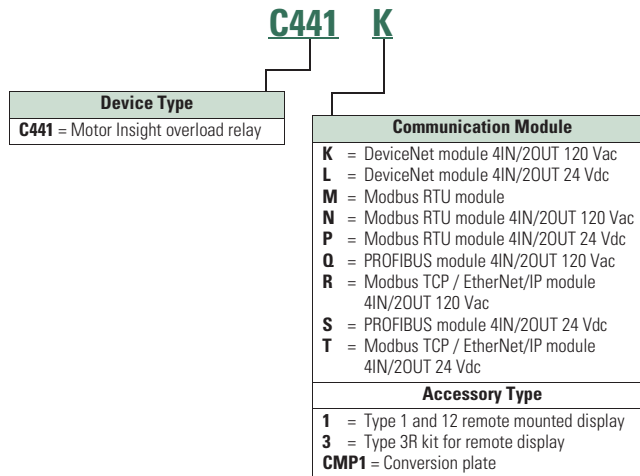

# 1.2

## C441 overload and monitoring relay

Product selection

### 1 Product Selection

#### Motor Insight



#### Motor Insight

| Power Source       | Monitoring Range | Current Range | Catalog Number      |
|--------------------|------------------|---------------|---------------------|
| 240 Vac (170–264)  | 170–264 Vac      | 1–9A          | <b>C441BA</b>       |
|                    |                  | 5–90A         | <b>C441BB</b>       |
| 480 Vac (323–528)  | 323–528 Vac      | 1–9A          | <b>C441CA</b>       |
|                    |                  | 5–90A         | <b>C441CB</b>       |
| 600 Vac (489–660)  | 489–660 Vac      | 1–9A          | <b>C441DA</b>       |
|                    |                  | 5–90A         | <b>C441DB</b>       |
| 120 Vac (93.5–132) | 170–660 Vac      | 1–9A          | <b>C4410109NOUI</b> |
|                    |                  | 5–90A         | <b>C4410590NOUI</b> |

#### Motor Insight CT Multiplier and Wire Wrap Schedule

| Catalog Number <sup>①</sup>    | Motor FLA | Number of Loops | Number of Conductors Through CT Primary | CT Multiplier Setting | External CT Kit Catalog Number <sup>②</sup> |
|--------------------------------|-----------|-----------------|---|-----------------------|---|
| <b>Current Range: 5–90A</b>    |           |                 |   |                       |   |
| <b>C441_B and C4410590NOUI</b> | 5–22.5A   | 3               | 4                                       | 4                     | —   |
|                                | 6.67–30A  | 2               | 3                                       | 3                     | —   |
|                                | 10–45A    | 1               | 2                                       | 2                     | —   |
|                                | 20–90A    | 0               | 1                                       | 1                     | —   |
| <b>Current Range: 1–9A</b>     |           |                 |   |                       |   |
| <b>C441_A and C4410109NOUI</b> | 1–5A      | 1               | 2                                       | 2                     | —   |
|                                | 2–9A      | 0               | 1                                       | 1                     | —   |
|                                | 60–135A   | 0               | 1                                       | 150–(150:5)           | <b>C441CTKIT150</b>                         |
|                                | 120–270A  | 0               | 1                                       | 300–(300:5)           | <b>C441CTKIT300</b>                         |
| 240–540A                       | 0         | 1               | 600–(600:5)                             | <b>C441CTKIT600</b>   |   |

#### Notes

① Underscore indicates Operating Voltage Code required.  
Operating Voltage Codes:

| Code                 | Voltage               |
|----------------------|-----------------------|
| <b>B</b>             | 240 Vac               |
| <b>C</b>             | 480 Vac               |
| <b>D</b>             | 600 Vac               |
| <b>&lt;empty&gt;</b> | 120 Vac Control Power |

② Any manufacturer's CTs may be used.

## Accessories

### Modbus Communication Module

The Motor Insight Modbus Communication Module is a side-mounted device providing Modbus communication capability to the Motor Insight overload relay.

The Modbus Communication Module with I/O provides communication, monitoring and control for the Motor Insight overload relay.

#### Features and Benefits

- The Modbus communication module is capable of baud rates up to 115K
- The Modbus address and baud rate configuration can be easily changed using the Motor Insight user interface (C441M only)
- Modbus address and baud rate are set via convenient DIP switches (C441N and C441P); LEDs are provided to display Modbus traffic
- Configuration with common Modbus configuration tools
- Terminals
  - Unique locking mechanism provides for easy removal of the terminal block with the field wiring installed
  - Each terminal is marked for ease of wiring and troubleshooting
- Selectable I/O assemblies
  - 4IN/2OUT
  - Signal types include 24 Vdc I/O and 120 Vac I/O
- Each I/O module is optically isolated between the field I/O and the network adapter to protect the I/O and communication circuits from possible damage due to transients and ground loops
- Input Module features a user-definable input debounce, which limits the effects of transients and electrical noise
- Output Module supports a user-definable safe state for loss of communication; hold last state, ON or OFF

### Modbus Communication Module

|                               | Description                          | I/O     | Catalog Number |
|-------------------------------|--------------------------------------|---------|----------------|
| <b>Modbus Module</b>          | Modbus Communication Module          | None    | <b>C441M</b>   |
| <b>Modbus with I/O Module</b> | Modbus Communication Module 4IN/2OUT | 120 Vac | <b>C441N</b>   |
|                               | Modbus Communication Module 4IN/2OUT | 24 Vdc  | <b>C441P</b>   |



# 1.2

## C441 overload and monitoring relay

### Product selection

1

#### DeviceNet Communication Modules

The DeviceNet Communication Module provides monitoring and control for the Motor Insight overload relay from a single DeviceNet node. These modules also offer convenient I/O in two voltage options, 24 Vdc and 120 Vac.

#### Features and Benefits

- Communication to DeviceNet uses only one DeviceNet MAC ID
- Configuration
  - DeviceNet MAC ID and Baud rate are set via convenient DIP switches with an option to set from the network
  - Advanced configuration available using common DeviceNet tools
- Terminals
  - Unique locking mechanism provides for easy removal of the terminal block with the field wiring installed
  - Each terminal is marked for ease of wiring and troubleshooting
- Selectable I/O assemblies
  - 4IN/2OUT
  - Signal types include 24 Vdc I/O and 120 Vac I/O
  - Each I/O module is optically isolated between the field I/O and the network adapter to protect the I/O and communication circuits from possible damage due to transients and ground loops
- Input Module features a user-definable input debounce, which limits the effects of transients and electrical noise
- Output Module supports a user-definable safe state for loss of communication; hold last state, ON or OFF
- Combined status LED

#### DeviceNet Module



#### DeviceNet Modules

| Description                    | I/O     | Catalog Number |
|--------------------------------|---------|----------------|
| DeviceNet Communication Module | 120 Vac | C441K          |
| DeviceNet Communication Module | 24 Vdc  | C441L          |

**PROFIBUS Communication Module**

The Motor Insight PROFIBUS Communication Module is a side-mounted device providing PROFIBUS communication capability to the Motor Insight overload relay.

The PROFIBUS Communication Module with I/O provides communication, monitoring and control for the Motor Insight overload relay.

**Features and Benefits**

- The PROFIBUS communication module is capable of baud rates up to 12 Mb
- PROFIBUS address is set via convenient DIP switches (C441Q and C441S); LEDs are provided to display PROFIBUS status
- Intuitive configuration with common PROFIBUS configuration tools
- Terminals
  - Unique locking mechanism provides for easy removal of the terminal block with the field wiring installed
  - Each terminal is marked for ease of wiring and troubleshooting
- Selectable I/O assemblies
  - 4IN/2OUT
  - Signal types include 24 Vdc I/O and 120 Vac I/O
- Each I/O module is optically isolated between the field I/O and the network adapter to protect the I/O and communication circuits from possible damage due to transients and ground loops
- Input Module features a user-definable input debounce, which limits the effects of transients and electrical noise
- Output Module supports a user-definable safe state for loss of communication; hold last state, ON or OFF

**PROFIBUS with I/O Module**



**PROFIBUS Communication Module**

| Description                            | I/O     | Catalog Number |
|--|---------|----------------|
| PROFIBUS Communication Module 4IN/2OUT | 120 Vac | <b>C441S</b>   |
| PROFIBUS Communication Module 4IN/2OUT | 24 Vdc  | <b>C441Q</b>   |

# 1.2 C441 overload and monitoring relay

Accessories

## 1 Ethernet Communication Module

The Motor Insight Ethernet Communication Module is a side-mounted device providing both Modbus TCP and EtherNet/IP communication capabilities with built-in HTTP web services to the Motor Insight overload relay.

The Ethernet Communication Module with I/O provides communication, monitoring and control for the Motor Insight overload relay.

### Features and Benefits

- Supports Modbus TCP or EtherNet/IP in a single device
- Contains internal embedded switch which provides two Ethernet ports allowing linear or ring network configurations
- Embedded web services allow for simple configuration and monitoring through Internet Explorer
- IP Address is set via convenient DIP Switches located on the device
- Terminals
  - Unique locking mechanism provides for easy removal of the terminal block with the field wiring installed
  - Each terminal is marked for ease of wiring and troubleshooting
- Selectable I/O assemblies
  - 4IN/2OUT
  - Signal types include 24 Vdc I/O and 120 Vac I/O
- Each I/O module is optically isolated between the field I/O and the network adapter to protect the I/O and communication circuits from possible damage due to transients and ground loops
- Input Module features a user-definable input debounce, which limits the effects of transients and electrical noise
- Output Module supports a user-definable safe state for loss of communication; hold last state, ON or OFF

Ethernet with I/O Module



### Ethernet Communication Module

| Description  | I/O     | Catalog Number |
|--|---------|----------------|
| Modbus TCP / EtherNet/IP Communication Module 4IN/2OUT | 120 Vac | <b>C441R</b>   |
| Modbus TCP / EtherNet/IP Communication Module 4IN/2OUT | 24 Vdc  | <b>C441T</b>   |



### Type 3R Kit with Remote Display Mounted Inside



Motor Insight offers several accessories for the customer's ease of use and safety:

- Types 1 and 12 remote display
- Type 3R remote display kit
- Mounting plate adapter

### Features and Benefits

- Remote display unit:
  - Same user interface as the overload relay
  - Enhanced operator safety—operator can configure the overload without opening the enclosure door
- Type 3R kit mounts with standard 30 mm holes
- Mounting plate for retrofit in existing installations

### Type 3R Kit with Remote Display Mounted Inside

|  | Description                                   | Catalog Number |
|--|---|----------------|
|   | C4411 Remote display Types 1 and 12 (UL 508)  | C4411          |
|  | C4413 Type 3R kit for remote display (UL 508) | C4413          |
|  | Conversion plate (not shown)                  | C441CMP1       |

### Communication Cables

The Remote Display requires a communication cable to connect to the Motor Insight overload relay:

### Communication Cable Lengths

| Length in Inches (meters) | Catalog Number |
|---------------------------|----------------|
| 9.8 (0.25)                | D77E-QPIP25    |
| 39.4 (1.0)                | D77E-QPIP100   |
| 78.7 (2.0)                | D77E-QPIP200   |
| 118.1 (3.0)               | D77E-QPIP300   |

### Current Transformer Kits

| Description                                   | Catalog Number |
|---|----------------|
| Three 150:5 CTs to be used with Motor Insight | C441CTKIT150   |
| Three 300:5 CTs to be used with Motor Insight | C441CTKIT300   |
| Three 600:5 CTs to be used with Motor Insight | C441CTKIT600   |

#### 1 Technical Data and Specifications

##### Motor Insight

| Description                                   | Specification C441B_  | C441C_  | C441D_  | C441_ _ _ _NOUI   |   |  |
|---|---|---|---|---|---|--|
| <b>Electrical Ratings</b>                     |   |   |   |   |   |  |
| <b>Feature</b>                                | <b>Range</b>  |   |   |   |   |  |
| Operating voltage (three-phase) and frequency | 170–264 Vac 50/60 Hz  | 323–528 Vac 50/60 Hz  | 489–660 Vac 50/60 Hz  | 170–660 Vac 50/60 Hz  |   |  |
| <b>Trip Class</b>                             |   |   |   |   |   |  |
| 5–30  | Selectable  | Selectable  | Selectable  | Selectable  |   |  |
| <b>FLA Range</b>                              |   |   |   |   |   |  |
| C441_A and C4410109NOUI                       | 1–9A  | Up to 540A with external CTs Refer to <b>Page 42</b> for CT multiplier and wire wrap schedule.  | Up to 540A with external CTs Refer to <b>Page 42</b> for CT multiplier and wire wrap schedule.  | Up to 540A with external CTs Refer to <b>Page 42</b> for CT multiplier and wire wrap schedule.  |   |  |
| C441_B and C4410590NOUI                       | 5–90A   |   |   |   |   |  |
| <b>Monitoring Capabilities</b>                |   |   |   |   |   |  |
| <b>Feature</b>                                | <b>Value</b>  |   |   |   |   |  |
| Current                                       | Per phase rms (1A, 1B, 1C), 2% accuracy<br>Average rms, 2% accuracy<br>Imbalance percent (0–100%)<br>Ground fault current, 10% accuracy | Per phase rms (1A, 1B, 1C), 2% accuracy<br>Average rms, 2% accuracy<br>Imbalance percent (0–100%)<br>Ground fault current, 10% accuracy | Per phase rms (1A, 1B, 1C), 2% accuracy<br>Average rms, 2% accuracy<br>Imbalance percent (0–100%)<br>Ground fault current, 10% accuracy | Per phase rms (1A, 1B, 1C), 2% accuracy<br>Average rms, 2% accuracy<br>Imbalance percent (0–100%)<br>Ground fault current, 10% accuracy | Per phase rms (1A, 1B, 1C), 2% accuracy<br>Average rms, 2% accuracy<br>Imbalance percent (0–100%)<br>Ground fault current, 10% accuracy |  |
| Voltage                                       | Per phase rms (1A, 1B, 1C), 2% accuracy<br>Average rms, 2% accuracy<br>Imbalance percent (0–100%)                                       | Per phase rms (1A, 1B, 1C), 2% accuracy<br>Average rms, 2% accuracy<br>Imbalance percent (0–100%)                                       | Per phase rms (1A, 1B, 1C), 2% accuracy<br>Average rms, 2% accuracy<br>Imbalance percent (0–100%)                                       | Per phase rms (1A, 1B, 1C), 2% accuracy<br>Average rms, 2% accuracy<br>Imbalance percent (0–100%)                                       | Per phase rms (1A, 1B, 1C), 2% accuracy<br>Average rms, 2% accuracy<br>Imbalance percent (0–100%)                                       |  |
| Power   | Motor kW, 5% accuracy<br>Motor power factor, inductive 0–1.0, 1% accuracy   | Motor kW, 5% accuracy<br>Motor power factor, inductive 0–1.0, 1% accuracy   | Motor kW, 5% accuracy<br>Motor power factor, inductive 0–1.0, 1% accuracy   | Motor kW, 5% accuracy<br>Motor power factor, inductive 0–1.0, 1% accuracy   | Motor kW, 5% accuracy<br>Motor power factor, inductive 0–1.0, 1% accuracy   |  |
| Thermal capacity                              | 0% cold, 100% trip  | 0% cold, 100% trip  | 0% cold, 100% trip  | 0% cold, 100% trip  | 0% cold, 100% trip  |  |
| Motor run hours                               | 0–65,535 hours  | 0–65,535 hours  | 0–65,535 hours  | 0–65,535 hours  | 0–65,535 hours  |  |
| Frequency                                     | 47–63 Hz, 1% accuracy   | 47–63 Hz, 1% accuracy   | 47–63 Hz, 1% accuracy   | 47–63 Hz, 1% accuracy   | 47–63 Hz, 1% accuracy   |  |
| <b>Motor Protection</b>                       |   |   |   |   |   |  |
| Thermal overload setting                      | 1.05 x FLA: Does not trip<br>1.15 x FLA: Overload trip  | 1.05 x FLA: Does not trip<br>1.15 x FLA: Overload trip  | 1.05 x FLA: Does not trip<br>1.15 x FLA: Overload trip  | 1.05 x FLA: Does not trip<br>1.15 x FLA: Overload trip  | 1.05 x FLA: Does not trip<br>1.15 x FLA: Overload trip  |  |
| <b>Feature</b>                                | <b>Range</b>  |   |   |   | <b>Fault Delay Setting</b>  |  |
| Jam   | 150–400% of motor FLA, OFF  | 150–400% of motor FLA, OFF  | 150–400% of motor FLA, OFF  | 50–400% of motor FLA, OFF   | 1–20 seconds  |  |
| Current imbalance                             | 1–30%, OFF  | 1–30%, OFF  | 1–30%, OFF  | 1–30%, OFF  | 1–20 seconds  |  |
| Current phase loss                            | Fixed threshold 60%   | Fixed threshold 60%   | Fixed threshold 60%   | Fixed threshold 60%   | 1–20 seconds  |  |
| <b>Ground fault current</b>                   |   |   |   |   |   |  |
| C441_A and C4410109NOUI<br>1–9A               | 0.3–2.0A with one pass through the CTs <sup>①</sup>   | 0.3–2.0A with one pass through the CTs <sup>①</sup>   | 0.3–2.0A with one pass through the CTs <sup>①</sup>   | 0.3–2.0A with one pass through the CTs <sup>①</sup>   | <150%, 1–60 seconds<br>>150%, 2 seconds<br>>250%, 1 second  |  |
| C441_B and C4410590NOUI<br>5–90A              | 3.0–20A with one pass through the CTs <sup>①</sup>  | 3.0–20A with one pass through the CTs <sup>①</sup>  | 3.0–20A with one pass through the CTs <sup>①</sup>  | 3.0–20A with one pass through the CTs <sup>①</sup>  | <150%, 1–60 seconds<br>>150%, 2 seconds<br>>250%, 1 second  |  |
| Phase reversal                                | OFF = Ignore, 1 = ACB, 2 = ABC  | OFF = Ignore, 1 = ACB, 2 = ABC  | OFF = Ignore, 1 = ACB, 2 = ABC  | OFF = Ignore, 1 = ACB, 2 = ABC  |   |  |
| Fault reset delay                             | 2–500 minutes, auto <sup>②</sup>  | 2–500 minutes, auto <sup>②</sup>  | 2–500 minutes, auto <sup>②</sup>  | 2–500 minutes, auto <sup>②</sup>  |   |  |
| Fault reset attempts                          | 0–4 restarts allowed or automatic reset <sup>②</sup>  | 0–4 restarts allowed or automatic reset <sup>②</sup>  | 0–4 restarts allowed or automatic reset <sup>②</sup>  | 0–4 restarts allowed or automatic reset <sup>②</sup>  |   |  |

##### Notes

<sup>①</sup> Lower levels are achievable with multiple passes.

<sup>②</sup> Motor fault reset characteristics can be programmed as a group or for motor overloads only. Reference the user manual for more detailed information.

**Motor Insight, continued**

| Description   | Specification<br>C441B_  | C441C_   | C441D_   | C441_ _ _ _NOUI  |  |
|---|--|--|--|--|--|
| <b>Load Protection</b>  |  |  |  |  |  |
| <b>Feature</b>  | <b>Range</b>   |  |  |  | <b>Fault Delay Setting</b>   |
| Under current   | 50–90% of motor FLA  | 50–90% of motor FLA  | 50–90% of motor FLA  | 50–90% of motor FLA  | 1–60 seconds   |
| Low power (kW)  | 20–80% of rated kW   | 20–80% of rated kW   | 20–80% of rated kW   | 20–80% of rated kW   | 1–60 seconds   |
| High power (kW)   | 50–110% of rated kW  | 50–110% of rated kW  | 50–110% of rated kW  | 50–110% of rated kW  | 1–60 seconds   |
| Load reset delay  | 2–500 minutes, auto  | 2–500 minutes, auto  | 2–500 minutes, auto  | 2–500 minutes, auto  |  |
| Load reset attempts   | 0–4, auto  | 0–4, auto  | 0–4, auto  | 0–4, auto  |  |
| <b>Supply Protection</b>  |  |  |  |  |  |
| <b>Feature</b>  | <b>Range</b>   |  |  |  | <b>Fault Delay Setting</b>   |
| Over voltage  | 170–264 Vac  | 323–528 Vac  | 489–660 Vac  | 0–660 Vac  | 1–20 seconds   |
| Under voltage   | 170–264 Vac  | 323–528 Vac  | 489–660 Vac  | 0–660 Vac  | 1–20 seconds   |
| Voltage imbalance   | 1–20% imbalance  | 1–20% imbalance  | 1–20% imbalance  | 1–20% imbalance  | 1–20% imbalance  |
| Restart delay setting   | 1–500 seconds  | 1–500 seconds  | 1–500 seconds  | 1–500 seconds  | 1–500 seconds  |
| <b>Electrical/EMC</b>   |  |  |  |  |  |
| Radiated emissions<br>IEC 60947-4-1—Table 15,<br>EN 55011 (CISPR 11)<br>Group 1, Class A  | 30–1000 mHz  | 30–1000 mHz  | 30–1000 mHz  | 30–1000 mHz  | 30–1000 mHz  |
| Conducted emissions<br>IEC 60947-4-1—Table 14,<br>EN 55011 (CISPR 11)<br>Group 1, Class A | 0.15–30 mHz  | 0.15–30 mHz  | 0.15–30 mHz  | 0.15–30 mHz  | 0.15–30 mHz  |
| ESD immunity<br>IEC 60947-4-1 (Table 13)  | ±8 kV air, ±4 kV contact   | ±8 kV air, ±4 kV contact   | ±8 kV air, ±4 kV contact   | ±8 kV air, ±4 kV contact   | ±8 kV air, ±4 kV contact   |
| Radiated immunity<br>IEC 60947-4-1  | 10 V/m 80–1000 mHz<br>80% amplitude modulated<br>1 kHz sine wave   | 10 V/m 80–1000 mHz<br>80% amplitude modulated<br>1 kHz sine wave   | 10 V/m 80–1000 mHz<br>80% amplitude modulated<br>1 kHz sine wave   | 10 V/m 80–1000 mHz<br>80% amplitude modulated<br>1 kHz sine wave   | 10 V/m 80–1000 mHz<br>80% amplitude modulated<br>1 kHz sine wave   |
| Conducted immunity<br>IEC 60947-4-1   | 140 dBuV (10V rms)<br>150 kHz–80 mHz   | 140 dBuV (10V rms)<br>150 kHz–80 mHz   | 140 dBuV (10V rms)<br>150 kHz–80 mHz   | 140 dBuV (10V rms)<br>150 kHz–80 mHz   | 140 dBuV (10V rms)<br>150 kHz–80 mHz   |
| Fast transient immunity<br>IEC 60947-4-1 (Table 13)<br>IEC 61000-4-4                      | ±2 kV using direct method  | ±2 kV using direct method  | ±2 kV using direct method  | ±2 kV using direct method  | ±2 kV using direct method  |
| Surge immunity<br>IEC 60947-4-1 (Table 13)<br>IEC 61000-4-4                               | Three-phase power inputs:<br>±2 kV line-to-line (DM)<br>±4 kV line-to-ground (CM)<br><br>IEC 61000-4-5 Class 3 User IO<br>and communication lines:<br>±1 kV line-to-line (DM)<br>±2 kV line-to-ground (CM) | Three-phase power inputs:<br>±2 kV line-to-line (DM)<br>±4 kV line-to-ground (CM)<br><br>IEC 61000-4-5 Class 3 User IO<br>and communication lines:<br>±1 kV line-to-line (DM)<br>±2 kV line-to-ground (CM) | Three-phase power inputs:<br>±2 kV line-to-line (DM)<br>±4 kV line-to-ground (CM)<br><br>IEC 61000-4-5 Class 3 User IO<br>and communication lines:<br>±1 kV line-to-line (DM)<br>±2 kV line-to-ground (CM) | Three-phase power inputs:<br>±2 kV line-to-line (DM)<br>±4 kV line-to-ground (CM)<br><br>IEC 61000-4-5 Class 3 User IO<br>and communication lines:<br>±1 kV line-to-line (DM)<br>±2 kV line-to-ground (CM) | Three-phase power inputs:<br>±2 kV line-to-line (DM)<br>±4 kV line-to-ground (CM)<br><br>IEC 61000-4-5 Class 3 User IO<br>and communication lines:<br>±1 kV line-to-line (DM)<br>±2 kV line-to-ground (CM) |
| Voltage variations<br>immunity<br>IEC 60947-4-1   | 30% dip, at 100 ms<br>60% dip at 10 ms<br>>95% interrupt at 5 ms   | 30% dip, at 100 ms<br>60% dip at 10 ms<br>>95% interrupt at 5 ms   | 30% dip, at 100 ms<br>60% dip at 10 ms<br>>95% interrupt at 5 ms   | 30% dip, at 100 ms<br>60% dip at 10 ms<br>>95% interrupt at 5 ms   | 30% dip, at 100 ms<br>60% dip at 10 ms<br>>95% interrupt at 5 ms   |
| Electromagnetic field<br>IEC 60947-4-1 (Table 13)<br>IEC 61000-4-3                        | 10 V/m   | 10 V/m   | 10 V/m   | 10 V/m   | 10 V/m   |
| Ground fault  | UL 508, UL 1053<br>Sections 21 and 27  | UL 508, UL 1053<br>Sections 21 and 27  | UL 508, UL 1053<br>Sections 21 and 27  | UL 508, UL 1053<br>Sections 21 and 27  | UL 508, UL 1053<br>Sections 21 and 27  |

# 1.2

## C441 overload and monitoring relay

Technical data and specifications

### 1 Motor Insight, continued

| Description  | Specification<br>C441B_  | C441C_   | C441D_   | C441_ _ _ _NOUI   |
|--|--|--|--|---|
| <b>Environmental Ratings</b>   |  |  |  |   |
| <b>Feature</b>   | <b>Range</b>   |  |  |   |
| Ambient temperature (operating)  | −4° to 122°F (−20° to 50°C)  | −4° to 122°F (−20° to 50°C)  | −4° to 122°F (−20° to 50°C)  | −4° to 122°F (−20° to 50°C)   |
| Ambient temperature (storage)  | −40° to 85°C   | −40° to 85°C   | −40° to 85°C   | −40° to 85°C  |
| Operating humidity   | 5% to 95% noncondensing  | 5% to 95% noncondensing  | 5% to 95% noncondensing  | 5% to 95% noncondensing   |
| Altitude (no derating)   | 2000m  | 2000m  | 2000m  | 2000m   |
| Shock (IEC 60068-2-27)   | 15G any direction  | 15G any direction  | 15G any direction  | 15G any direction   |
| Vibration (IEC 60068-2-6)  | 3G any direction   | 3G any direction   | 3G any direction   | 3G any direction  |
| Pollution degree per IEC 60947-1   | 3  | 3  | 3  | 3   |
| Ingress protection   | IP20   | IP20   | IP20   | IP20  |
| <b>Capacity</b>  |  |  |  |   |
| Input, auxiliary contact and external reset terminals                                      |  |  |  |   |
| Terminal capacity  | 18–12 AWG  | 18–12 AWG  | 18–12 AWG  | 18–12 AWG   |
| Tightening torque  | 5.3 lb-in (0.6 Nm)   | 5.3 lb-in (0.6 Nm)   | 5.3 lb-in (0.6 Nm)   | 5.3 lb-in (0.6 Nm)  |
| <b>Voltages</b>  |  |  |  |   |
| Monitoring voltage   | 170–264 Vac 50/60Hz  | 323–528 Vac 50/60Hz  | 489–660 Vac 60Hz   | 0–660 Vac 50/60Hz   |
| Insulation voltage $U_i$ (three-phase voltage)   | 600 Vac  | 600 Vac  | 600 Vac  | 600 Vac   |
| Insulation voltage $U_i$ (control)   | 240 Vac  | 240 Vac  | 240 Vac  | 240 Vac   |
| Impulse withstand $U_{imp}$ (main/control)   | 6 kV   | 6 kV   | 6 kV   | 6 kV  |
| <b>Expected Life</b>   |  |  |  |   |
| Mechanical/electrical  | 10 years   | 10 years   | 10 years   | 10 years  |
| <b>Output Contact Ratings</b>  |  |  |  |   |
| Two output relays<br>One Form C SPDT (fault relay)<br>One Form A SPST (ground fault relay) | B300 pilot duty<br>5A thermal continuous current<br>30A make 3.00A break<br>at 120 Vac and<br>15A make 1.50A break<br>at 240 Vac | B300 pilot duty<br>5A thermal continuous current<br>30A make 3.00A break<br>at 120 Vac and<br>15A make 1.50A break<br>at 240 Vac | B300 pilot duty<br>5A thermal continuous current<br>30A make 3.00A break<br>at 120 Vac and<br>15A make 1.50A break<br>at 240 Vac | B300 pilot duty<br>5A thermal continuous current<br>30A make 3.00A break<br>at 120 Vac and<br>30A make 1.50A break<br>at 240 Vac <sup>①</sup> |
| C441_ _ _ _NOUI models:<br>One Form A SPST<br>One Form B SPST                              |  |  |  |   |
| External remote reset terminal   | Isolated 120 Vac digital input<br>IEC 61131-2 Section 5 Type 1   | Isolated 120 Vac digital input<br>IEC 61131-2 Section 5 Type 1   | Isolated 120 Vac digital input<br>IEC 61131-2 Section 5 Type 1   | Isolated 120 Vac digital input<br>IEC 61131-2 Section 5 Type 1  |
| <b>Indications</b>   |  |  |  |   |
| Trip   | Fault  | Fault  | Fault  | Fault   |
| Reset  | Ready  | Ready  | Ready  | Ready   |
| Autoreset  | Trip faulted/Ready flashing  | Trip faulted/Ready flashing  | Trip faulted/Ready flashing  | Trip faulted/Ready flashing   |
| <b>Power Consumption</b>   |  |  |  |   |
| Maximum  | 5W   | 5W   | 5W   | 5W  |
| <b>Options</b>   |  |  |  |   |
| Remote display   | Type 1, 12 and Type 3R kit   | Type 1, 12 and Type 3R kit   | Type 1, 12 and Type 3R kit   | Type 1, 12 and Type 3R kit  |
| Communications modules   | Modbus, DeviceNet and<br>PROFIBUS with I/O   | Modbus, DeviceNet and<br>PROFIBUS with I/O   | Modbus, DeviceNet and<br>PROFIBUS with I/O   | Modbus, DeviceNet and<br>PROFIBUS with I/O  |

#### Note

① In this model, there are two isolated relays: one Form A and one Form B SPST. One is the fault relay, and one is a programmable auxiliary relay.

## Motor Insight Short Circuit Ratings (North America CSA and UL)

1

| Overload FLA Range | Maximum Operating Voltage | Standard-Fault Short Circuit Data |                    |  | Maximum Withstand Rating | Maximum Fuse (RK5) | Eaton Thermal-Magnetic Circuit Breaker | Catalog Number      |
|--------------------|---------------------------|-----------------------------------|--------------------|--|--------------------------|--------------------|--|---------------------|
|                    |                           | Withstand Rating                  | Maximum Fuse (RK5) | Maximum Thermal-Magnetic Circuit Breaker |                          |                    |  |                     |
| 1-9A               | 264 Vac                   | 5000A at 240 Vac                  | 35A                | 35A                                      | 100 kA at 240 Vac        | 35A                | —                                      | <b>C441BA</b>       |
|                    |                           |                                   |                    |  | 100 kA at 240 Vac        | —                  | FDC3035L                               |                     |
| 1-9A               | 528 Vac                   | 5000A at 480 Vac                  | 35A                | 35A                                      | 100 kA at 480 Vac        | 35A                | —                                      | <b>C441CA</b>       |
|                    |                           |                                   |                    |  | 100 kA at 480 Vac        | —                  | FDC3035L                               |                     |
| 1-9A               | 660 Vac                   | 5000A at 600 Vac                  | 35A                | 35A                                      | 100 kA at 600 Vac        | 35A                | —                                      | <b>C441DA</b>       |
|                    |                           |                                   |                    |  | 35 kA at 600 Vac         | —                  | FDC3035L                               |                     |
| 1-9A               | 660 Vac                   | 5000A at 600 Vac                  | 35A                | 35A                                      | 100 kA at 240 Vac        | 35A                | —                                      | <b>C4410109NOUI</b> |
|                    |                           |                                   |                    |  | 100 kA at 240 Vac        | —                  | FDC3035L                               |                     |
|                    |                           |                                   |                    |  | 100 kA at 480 Vac        | 35A                | —                                      |                     |
|                    |                           |                                   |                    |  | 100 kA at 480 Vac        | —                  | FDC3035L                               |                     |
|                    |                           |                                   |                    |  | 100 kA at 600 Vac        | 35A                | —                                      |                     |
| 35 kA at 600 Vac   | —                         | FDC3035L                          |                    |  |                          |                    |  |                     |
| 5-90A              | 264 Vac                   | 10,000A at 240 Vac                | 350A               | 350A                                     | 100 kA at 240 Vac        | 350A               | —                                      | <b>C441BB</b>       |
|                    |                           |                                   |                    |  | 100 kA at 240 Vac        | —                  | KDC3350                                |                     |
| 5-90A              | 528 Vac                   | 10,000A at 480 Vac                | 350A               | 350A                                     | 100 kA at 480 Vac        | 350A               | —                                      | <b>C441CB</b>       |
|                    |                           |                                   |                    |  | 100 kA at 480 Vac        | —                  | KDC3350                                |                     |
| 5-90A              | 660 Vac                   | 10,000A at 600 Vac                | 350A               | 350A                                     | 100 kA at 600 Vac        | 350A               | —                                      | <b>C441DB</b>       |
|                    |                           |                                   |                    |  | 65 kA at 600 Vac         | —                  | KDC3350                                |                     |
| 5-90A              | 660 Vac                   | 10,000A at 600 Vac                | 350A               | 350A                                     | 100 kA at 240 Vac        | 350A               | —                                      | <b>C4410590NOUI</b> |
|                    |                           |                                   |                    |  | 100 kA at 240 Vac        | —                  | KDC3350                                |                     |
|                    |                           |                                   |                    |  | 100 kA at 480 Vac        | 350A               | —                                      |                     |
|                    |                           |                                   |                    |  | 100 kA at 480 Vac        | —                  | KDC3350                                |                     |
|                    |                           |                                   |                    |  | 100 kA at 600 Vac        | 350A               | —                                      |                     |
| 35 kA at 600 Vac   | —                         | KDC3350                           |                    |  |                          |                    |  |                     |

# 1.2 C441 overload and monitoring relay

Technical data and specifications

## 1 Line Powered Models

### Terminal Connection Diagram

Use 75C CU wire only

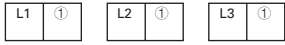

18–12 AWG; Torque 5.3 lb-in/0.6 Nm  
B300 Pilot Duty Only

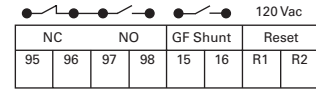

For C441BA, BB, CA, CB, DA and DB



### Terminal Connection Specifications

| Name         | Designation                      | Input        | Description  |
|--------------|----------------------------------|--------------|--|
| Line voltage | L1, L2, L3                       | Line voltage | Three-phase line voltage input<br>L1, L2, L3 connections must correspond to the respective CT1, CT2, CT3 current leads                     |
| Fault relay  | 95/96<br>96/97 (common)<br>97/98 | B300 UL 508  | Form C contact:<br>95/96 Contact opens when the unit is faulted or unpowered<br>97/98 Contact closes when the unit is faulted or unpowered |
| GF shunt     | 15<br>16                         | B300 UL 508  | Form A contact:<br>Contact closes when a ground fault is active  |
| Reset input  | R1, R2                           | 120 Vac      | Fault reset input IEC 61131-2 Type 1   |

## Control Powered Models

### Terminal Connection Diagram

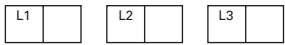

For C4410109NOUI and C441059NOUI



### Terminal Connection Specifications

| Name          | Designation  | Input                             | Description   |
|---------------|--|-----------------------------------|---|
| Line voltage  | L1, L2, L3   | Line voltage                      | Three-phase line voltage input<br>L1, L2, L3 connections must correspond to the respective CT1, CT2, CT3 current leads<br>Terminal provided for wiring control power transformer (9A maximum capacity)                            |
| Control power | X1, X2   | 110–120 Vac<br>50–60Hz (+10/–15%) | Control power option for C441____NOUI   |
| Fault relay   | 95/96<br>For C441____NOUI, the fault relay and auxiliary relay are isolated and do not share a common. By default they will behave like a Form C, but they can be programmed to act independently from one another.<br>96/97 (isolated)<br>97/98 | B300 UL 508                       | Form C contact:<br>95/96 Contact opens when the unit is faulted or unpowered<br>97/98 Contact closes when the unit is faulted or unpowered<br>Can be programmed to act independently of the 95/96 only in the C441____NOUI models |
| GF shunt      | 97/98  | B300 UL 508                       | Form A contact:<br>Contact closes when a ground fault is active<br>Separate GF control can still be achieved by programming auxiliary relay 97/98 to act independently of the 95/96 relay   |
| Reset input   | R1, R2   | 120 Vac                           | Fault reset input IEC 61131-2 Type 1  |

#### Note

① No motor loads, 9A maximum.

## Modbus Communication Modules

| Description   | Specification  |                 |
|---|--|-----------------|
| <b>Electrical/EMC</b>   |  |                 |
| Radiated emissions<br>IEC 60947-4-1—Table 15, EN 55011 (CISPR 11) Group 1, Class A  | 30–1000 mHz  |                 |
| Conducted emissions<br>IEC 60947-4-1—Table 14, EN 55011 (CISPR 11) Group 1, Class A | 0.15–30 mHz  |                 |
| ESD immunity<br>IEC 60947-4-1 (Table 13) IEC 61000-4-2                              | ±8 kV air, ±4 kV contact   |                 |
| Radiated immunity<br>IEC 60947-4-1  | 10 V/m 80–1000 mHz<br>80% amplitude modulated 1 kHz sine wave  |                 |
| Conducted immunity<br>IEC 60947-4-1   | 140 dBuV (10V rms)<br>150 kHz–80 mHz   |                 |
| Fast transient immunity<br>IEC 60947-4-1 (Table 13) IEC 61000-4-4                   | ±2 kV using direct method  |                 |
| Surge immunity<br>IEC 60947-4-1 (Table 13)<br>IEC 61000-4-5 Class 3                 | User IO and communication lines <sup>①</sup> :<br>±1 kV line-to-line (DM)<br>±2 kV line-to-ground (CM) |                 |
| Electromagnetic field <sup>1</sup><br>IEC 60947-4-1 (Table 13) IEC 61000-4-3        | 10 V/m   |                 |
| <b>Environmental Ratings</b>  |  |                 |
| Ambient temperature (operating)   | –20° to 50°C   |                 |
| Ambient temperature (storage)   | –40° to 85°C   |                 |
| Operating humidity  | 5 to 95% noncondensing   |                 |
| Altitude (no derating)  | 2000m  |                 |
| Shock (IEC 60068-2-27)  | 15G any direction  |                 |
| Vibration (IEC 60068-2-6)   | 3G any direction   |                 |
| Pollution degree per IEC 60947-1  | 3  |                 |
| Degree of protection  | IP20   |                 |
| Over voltage category per UL 508  | III  |                 |
| <b>C441P 24 Vdc Input</b>   |  |                 |
| Nominal input voltage   | 24 Vdc   |                 |
| Operating voltage   | 18–30 Vdc  |                 |
| Number of inputs  | 4  |                 |
| Signal delay  | 5 ms (programmable to 65 sec)  |                 |
| OFF-state voltage   | < 6 Vdc  |                 |
| ON-state voltage  | > 18 Vdc   |                 |
| Nominal input current   | 5 mA   |                 |
| Isolation   | 1500V  |                 |
| Terminal screw torque   | 7–9 in-lb  |                 |
| 24 Vdc source current   | 50 mA  |                 |
| <b>Operating Voltage Range—DC Input Modules</b>                                     |  |                 |
| <b>OFF State</b>  | <b>Transition Region</b>   | <b>ON State</b> |
| 0–6 Vdc   | 6–18 Vdc   | 18–30 Vdc       |
| <b>C441N 120 Vac Input</b>  |  |                 |
| Nominal input voltage   | 120 Vac  |                 |
| Operating voltage   | 80–140 Vac   |                 |
| Number of inputs  | 4  |                 |
| OFF-state voltage   | < 30 Vac   |                 |
| ON-state voltage  | > 80 Vac   |                 |
| Nominal input current   | 15 mA  |                 |
| Signal delay  | 1/2 cycle  |                 |
| Isolation   | 1500V  |                 |
| Terminal screw torque   | 7–9 in-lb  |                 |

**Note**

<sup>①</sup> Relates to C441M only.

# 1.2

## C441 overload and monitoring relay

Technical data and specifications

1

### Modbus Communication Modules, continued

| Description                                      | Specification   |
|--|---|
| <b>Operating Voltage Range— AC Input Modules</b> |   |
| <b>OFF State</b>                                 | <b>Transition Region</b> <b>ON State</b>                  |
| 0–30 Vac   | 30–80 Vac                                      80–140 Vac |
| <b>Output Modules</b>                            |   |
| Nominal voltage                                  | 120 Vac<br>24 Vdc   |
| Number of outputs                                | (2) 1NO Form A<br>1NO/NC Form C                           |
| Relay OFF time                                   | 3 ms  |
| Relay ON time                                    | 7 ms  |
| Max. current per point <sup>①</sup>              | 5A (B300 rated)   |
| Electrical life                                  | 100,000 cycles  |
| Mechanical life                                  | 1,000,000 cycles  |

### DeviceNet Communication Modules

| Description   | Specification   |
|---|---|
| <b>Electrical/EMC</b>   |   |
| Radiated emissions<br>IEC 60947-4-1—Table 15, EN 55011<br>(CISPIR 11) Group 1, Class A  | 30–1000 mHz   |
| Conducted emissions<br>IEC 60947-4-1—Table 14, EN 55011<br>(CISPIR 11) Group 1, Class A | 0.15–30 mHz   |
| ESD immunity<br>IEC 60947-4-1 (Table 13) IEC 61000-4-2                                  | ±8 kV air, ±4 kV contact  |
| Radiated immunity<br>IEC 60947-4-1  | 10 V/m 80–1000 mHz<br>80% amplitude modulated 1 kHz sine wave                             |
| Conducted immunity<br>IEC 60947-4-1   | 140 dBuV (10V rms)<br>150 kHz–80 mHz  |
| Fast transient immunity<br>IEC 60947-4-1 (Table 13) IEC 61000-4-4                       | ±2 kV using direct method   |
| Surge immunity<br>IEC 60947-4-1 (Table 13)<br>IEC 61000-4-5 Class 2                     | User I/O and communication lines:<br>±1 kV line-to-line (DM)<br>±2 kV line-to-ground (CM) |
| Electromagnetic field<br>IEC 60947-4-1 Table 13, IEC 61000-4-3                          | 10 V/m  |
| <b>Environmental Ratings</b>  |   |
| Ambient temperature (operating)   | –20° to 50°C  |
| Ambient temperature (storage)   | –40° to 85°C  |
| Operating humidity  | 5–95% noncondensing   |
| Altitude (no derating)  | 2000m   |
| Shock (IEC 60068-2-27)  | 15G any direction   |
| Vibration (IEC 60068-2-6)   | 3G any direction  |
| Pollution degree per IEC 60947-1  | 3   |
| Degree of protection  | IP20  |
| <b>DeviceNet</b>  |   |
| DeviceNet connections   | Group 2, polling, bit strobe, explicit, no UCMM   |
| DeviceNet baud rate   | 125K, 250K, 500K  |

**Note**

<sup>①</sup> Resistive current at 55°C ambient.



## DeviceNet Communication Modules, continued

| Description                                     | Specification                   |                 |
|---|---------------------------------|-----------------|
| <b>C441L 24 Vdc Input</b>                       |                                 |                 |
| Nominal input voltage                           | 24 Vdc                          |                 |
| Operating voltage                               | 18–30 Vdc                       |                 |
| Number of inputs                                | 4                               |                 |
| Signal delay                                    | 5 ms (programmable to 65 sec)   |                 |
| OFF-state voltage                               | < 6 Vdc                         |                 |
| ON-state voltage                                | > 18 Vdc                        |                 |
| Nominal input current                           | 5 mA                            |                 |
| Isolation                                       | 250V                            |                 |
| Terminal screw torque                           | 7–9 in-lb                       |                 |
| 24V source current                              | 50 mA                           |                 |
| <b>Operating Voltage Range—DC Input Modules</b> |                                 |                 |
| <b>OFF State</b>                                | <b>Transition Region</b>        | <b>ON State</b> |
| 0–6 Vdc   | 6–18 Vdc                        | 18–30 Vdc       |
| <b>C441K 120 Vac Input</b>                      |                                 |                 |
| Nominal input voltage                           | 120 Vac                         |                 |
| Operating voltage                               | 80–140 Vac                      |                 |
| Number of inputs                                | 4                               |                 |
| OFF-state voltage                               | < 30 Vac                        |                 |
| ON-state voltage                                | > 80 Vac                        |                 |
| Nominal input current                           | 15 mA                           |                 |
| Signal delay                                    | 1/2 cycle                       |                 |
| Isolation                                       | 250V                            |                 |
| Terminal screw torque                           | 7–9 in-lb                       |                 |
| <b>Operating Voltage Range—AC Input Modules</b> |                                 |                 |
| <b>OFF State</b>                                | <b>Transition Region</b>        | <b>ON State</b> |
| 0–30 Vac  | 30–80 Vac                       | 80–140 Vac      |
| <b>Output Modules</b>                           |                                 |                 |
| Nominal voltage                                 | 120 Vac<br>24 Vdc               |                 |
| Number of outputs                               | (2) 1NO Form A<br>1NO/NC Form C |                 |
| Relay OFF time                                  | 3 ms                            |                 |
| Relay ON time                                   | 7 ms                            |                 |
| Max. current per point <sup>①</sup>             | 5A (B300 rated)                 |                 |
| Electrical life                                 | 100,000 cycles                  |                 |
| Mechanical life                                 | 1,000,000 cycles                |                 |

**Note**

<sup>①</sup> Resistive current at 55°C ambient.

# 1.2

## C441 overload and monitoring relay

### Technical data and specifications

1

#### PROFIBUS Communication Modules

| Description   | Specification   |
|---|---|
| <b>Electrical/EMC</b>   |   |
| Radiated emissions<br>IEC 60947-4-1—Table 15, EN 55011<br>(CISPIR 11) Group 1, Class A  | 30–1000 mHz   |
| Conducted emissions<br>IEC 60947-4-1—Table 14, EN 55011<br>(CISPIR 11) Group 1, Class A | 0.15–30 mHz   |
| ESD immunity<br>IEC 60947-4-1 (Table 13) IEC 61000-4-2                                  | ±8 kV air, ±4 kV contact  |
| Radiated immunity<br>IEC 60947-4-1 Table 13, IEC 61000-4-3                              | 10 V/m 80–1000 mHz<br>80% amplitude modulated 1 kHz sine wave                             |
| Conducted immunity<br>IEC 60947-4-1   | 140 dBuV (10V rms)<br>150 kHz–80 mHz  |
| Fast transient immunity<br>IEC 60947-4-1 (Table 13) IEC 61000-4-4                       | ±2 kV using direct method   |
| Surge immunity<br>IEC 60947-4-1 (Table 13)<br>IEC 61000-4-5 Class 2                     | User I/O and communication lines:<br>±1 kV line-to-line (DM)<br>±2 kV line-to-ground (CM) |
| <b>Environmental Ratings</b>  |   |
| Ambient temperature (operating)   | –20° to 50°C  |
| Ambient temperature (storage)   | –40° to 85°C  |
| Operating humidity  | 5–95% noncondensing   |
| Altitude (no derating)  | 2000m   |
| Shock (IEC 60068-2-27)  | 15G any direction   |
| Vibration (IEC 60068-2-6)   | 3G any direction  |
| Pollution degree per IEC 60947-1  | 3   |
| Degree of protection  | IP20  |
| <b>PROFIBUS</b>   |   |
| PROFIBUS connections  | Group 2, polling, bit strobe, explicit, no UCMM   |
| PROFIBUS baud rate  | 9.6K, 19.2K, 45.45K, 93.75K, 187.5K, 500K, 1.5M, 3M, 6M, 12M                              |
| <b>C441Q 24 Vdc Input</b>   |   |
| Nominal input voltage   | 24 Vdc  |
| Operating voltage   | 18–30 Vdc   |
| Number of inputs  | 4   |
| Signal delay  | 5 ms (programmable to 65 sec)   |
| OFF-state voltage   | <6 Vdc  |
| ON-state voltage  | >10 Vdc   |
| Nominal input current   | 5 mA  |
| Isolation   | 1500V   |
| Terminal screw torque   | 7–9 in-lb   |
| 24V source current  | 50 mA   |

## PROFIBUS Communication Modules, continued

| Description                                     | Specification   |
|---|---|
| <b>Operating Voltage Range—DC Input Modules</b> |   |
| <b>OFF State</b>                                | <b>Transition Region</b> <b>ON State</b>                  |
| 0–6 Vdc   | 6–18 Vdc                                      18–30 Vdc   |
| <b>C441S 120 Vac Input</b>                      |   |
| Nominal input voltage                           | 120 Vac   |
| Operating voltage                               | 80–140 Vac  |
| Number of inputs                                | 4   |
| OFF-state voltage                               | < 20 Vac  |
| ON-state voltage                                | > 70 Vac  |
| Nominal input current                           | 15 mA   |
| Signal delay                                    | 1/2 cycle   |
| Isolation                                       | 1500V   |
| Terminal screw torque                           | 7–9 in-lb   |
| <b>Operating Voltage Range—AC Input Modules</b> |   |
| <b>OFF State</b>                                | <b>Transition Region</b> <b>ON State</b>                  |
| 0–30 Vac  | 30–80 Vac                                      80–140 Vac |
| <b>Output Modules</b>                           |   |
| Nominal voltage                                 | 120 Vac<br>24 Vdc   |
| Number of outputs                               | (2) 1NO Form A<br>1NO/NC Form C                           |
| Relay OFF time                                  | 3 ms  |
| Relay ON time                                   | 7 ms  |
| Max. current per point <sup>①</sup>             | 5A (B300 rated)   |
| Electrical life                                 | 100,000 cycles  |
| Mechanical life                                 | 1,000,000 cycles  |

**Note**

<sup>①</sup> Resistive current at 55°C ambient.

# 1.2

## C441 overload and monitoring relay

### Technical data and specifications

#### 1 Ethernet (Modbus TCP / EtherNet/IP) Communication Modules

| Description  | Specification  |
|--|--|
| <b>Electrical/EMC</b>  |  |
| Radiated emissions<br>IEC 60947-4-1, Table 15, EN 55011<br>(CISPIR 11) Group 1, Class A  | 30–1000 mHz  |
| Conducted emissions<br>IEC 60947-4-1, Table 15, EN 55011<br>(CISPIR 11) Group 1, Class A | 0.15–30 mHz  |
| ESD immunity<br>IEC 60947-4-1 (Table 13) IEC 61000-4-2                                   | ±8 kV air, ±4 kV contact   |
| Radiated immunity<br>IEC 60947-4-1 (Table 13) IEC 61000-4-3                              | 10 V/m 80–1000 mHz<br>80% amplitude modulated 1 kHz sine wave                            |
| Conducted immunity<br>IEC 60947-4-1  | 140 dBuV (10V rms)<br>150 kHz to 80 mHz  |
| Fast transient immunity<br>IEC 60947-4-1 (Table 13) IEC 61000-4-4                        | ±2 kV using direct method  |
| Surge immunity<br>IEC 60947-4-1 (Table 13)<br>IEC 61000-4-5 Class 2                      | User IO and communication lines:<br>±1 kV line-to-line (DM)<br>±2 kV line-to-ground (CM) |
| <b>Environmental Ratings</b>   |  |
| Ambient temperature (operating)  | –20° to 50°C   |
| Ambient temperature (storage)  | –40° to 85°C   |
| Operating humidity   | 5–95% noncondensing  |
| Altitude (no derating)   | 2000m  |
| Shock (IEC 60068-2-27)   | 15G any direction  |
| Vibration (IEC 60068-2-6)  | 3G any direction   |
| Pollution degree per IEC 60947-1   | 3  |
| Degree of protection   | IP20   |
| <b>Ethernet</b>  |  |
| Ethernet connections   | Integrated two-port switch with dual RJ45 Ethernet connections                           |
| Ethernet type  | Ethernet 10/100 Mbps, AutoMDX, Auto Negotiation  |
| <b>C441T 24 Vdc Input</b>  |  |
| Nominal input voltage  | 24 Vdc   |
| Operating voltage  | 18–30 Vdc  |
| Number of inputs   | 4  |
| Signal delay   | 5 ms (programmable to 65 sec)  |
| OFF-state voltage  | <6 Vdc   |
| ON-state voltage   | >18 Vdc  |
| Nominal input current  | 5 mA   |
| Isolation  | 1500V  |
| Terminal screw torque  | 7–9 in-lb  |
| 24V source current   | 50 mA  |

**Ethernet (Modbus TCP / EtherNet/IP) Communication Modules, continued**

| Description                                     | Specification                   |                 |
|---|---------------------------------|-----------------|
| <b>Operating Voltage Range—DC Input Modules</b> |                                 |                 |
| <b>OFF State</b>                                | <b>Transition Region</b>        | <b>ON State</b> |
| 0–6 Vdc   | 6–18 Vdc                        | 18–30 Vdc       |
| <b>C441R 120 Vac Input</b>                      |                                 |                 |
| Nominal input voltage                           | 120 Vac                         |                 |
| Operating voltage                               | 80–140 Vac                      |                 |
| Number of inputs                                | 4                               |                 |
| OFF-state voltage                               | < 30 Vac                        |                 |
| ON-state voltage                                | > 80 Vac                        |                 |
| Nominal input current                           | 15 mA                           |                 |
| Signal delay                                    | 1/2 cycle                       |                 |
| Isolation                                       | 1500V                           |                 |
| Terminal screw torque                           | 7–9 in-lb                       |                 |
| <b>Operating Voltage Range—AC Input Modules</b> |                                 |                 |
| <b>OFF State</b>                                | <b>Transition Region</b>        | <b>ON State</b> |
| 0–30 Vac  | 30–80 Vac                       | 80–140 Vac      |
| Nominal voltage                                 | 120 Vac<br>24 Vdc               |                 |
| Number of outputs                               | (2) 1NO Form A<br>1NO/NC Form C |                 |
| Relay OFF time                                  | 3 ms                            |                 |
| Relay ON time                                   | 7 ms                            |                 |
| Maximum current per point <sup>①</sup>          | 5A (B300 rated)                 |                 |
| Electrical life                                 | 100,000 cycles                  |                 |
| Mechanical life                                 | 1,000,000 cycles                |                 |

**Note**

<sup>①</sup> Resistive current at 55°C ambient.

# 1.2 C441 overload and monitoring relay

## Dimensions

### 1 Dimensions

Approximate Dimensions in mm

#### Motor Insight Overload Relay

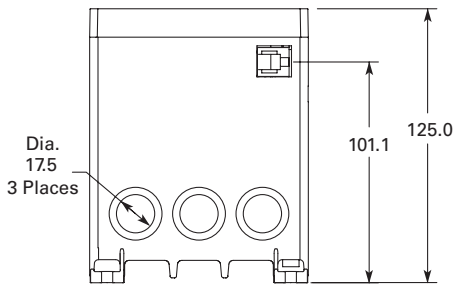
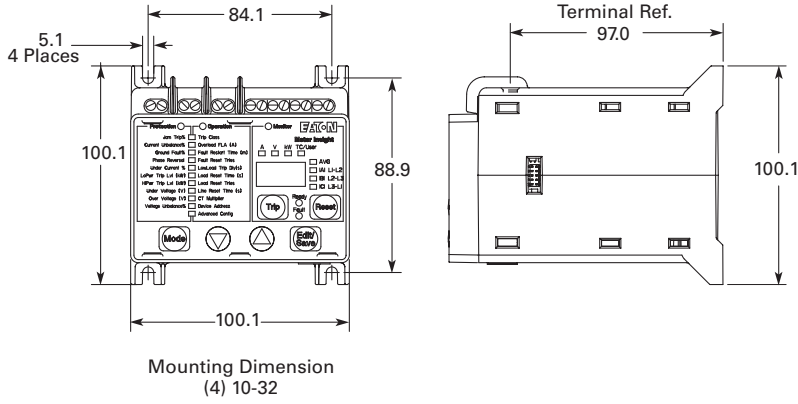

#### Motor Insight with Mounted DeviceNet, PROFIBUS or Modbus with I/O Communication Module

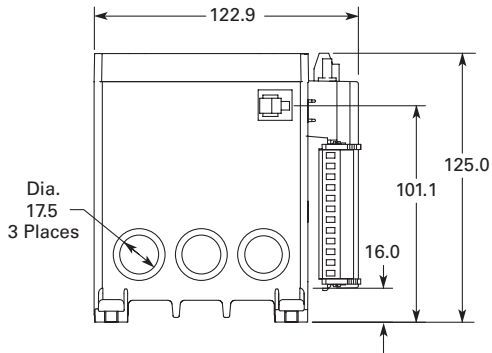
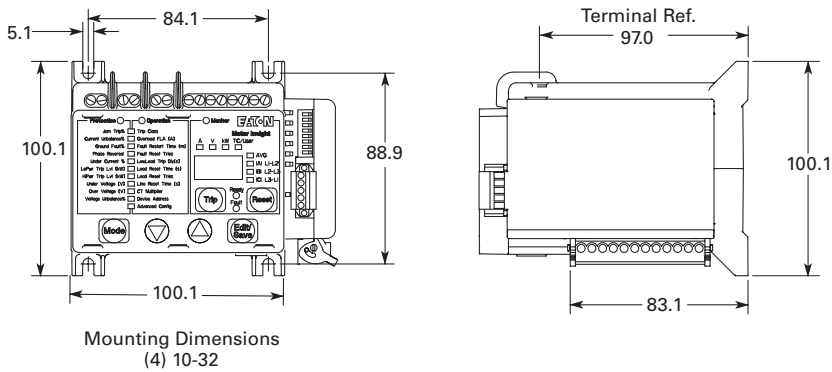

Approximate Dimensions in mm

## Motor Insight with Mounted Modbus Communication Module

1

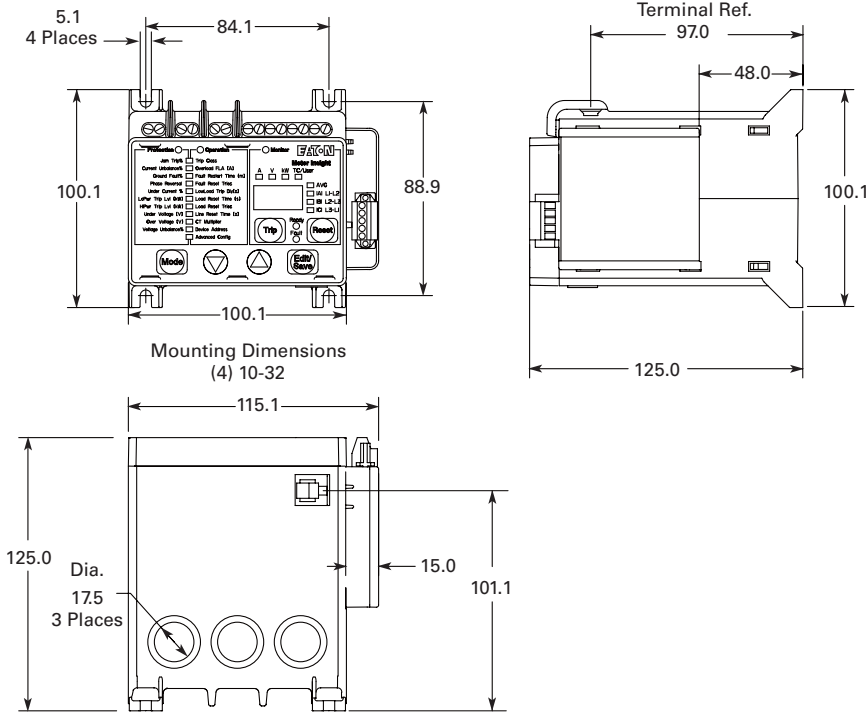

## Motor Insight Remote Display

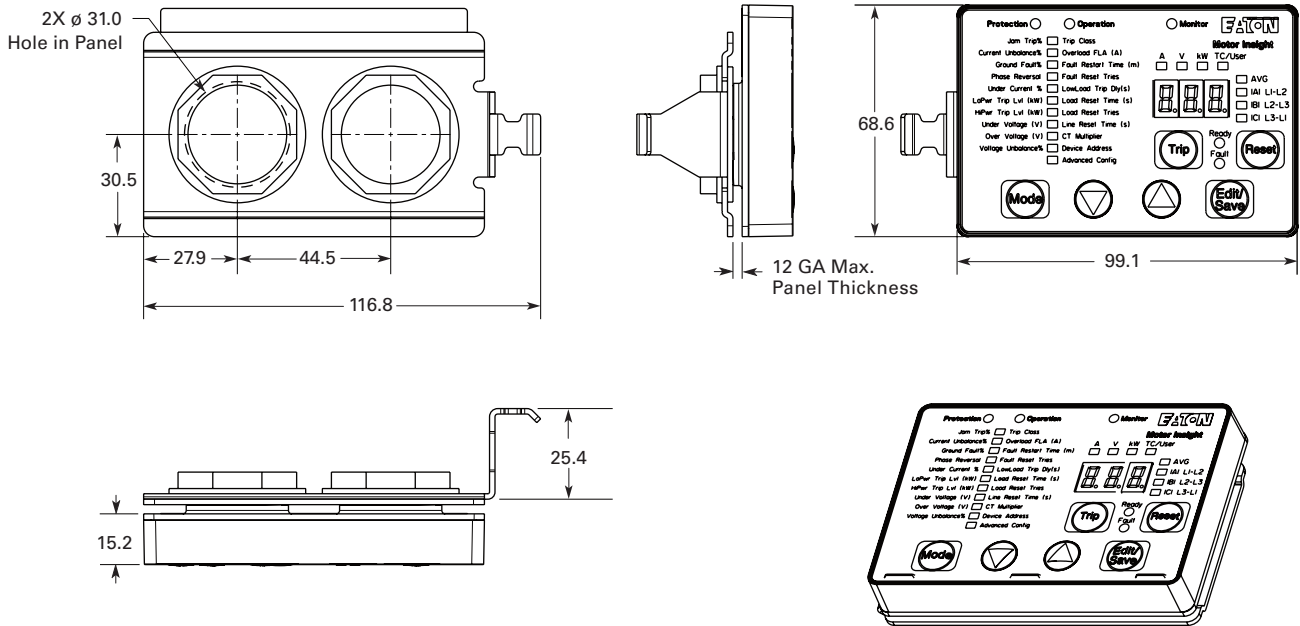

# 1.2 C441 overload and monitoring relay

## Dimensions

1 Approximate Dimensions in mm

### Motor Insight Cover Assembly

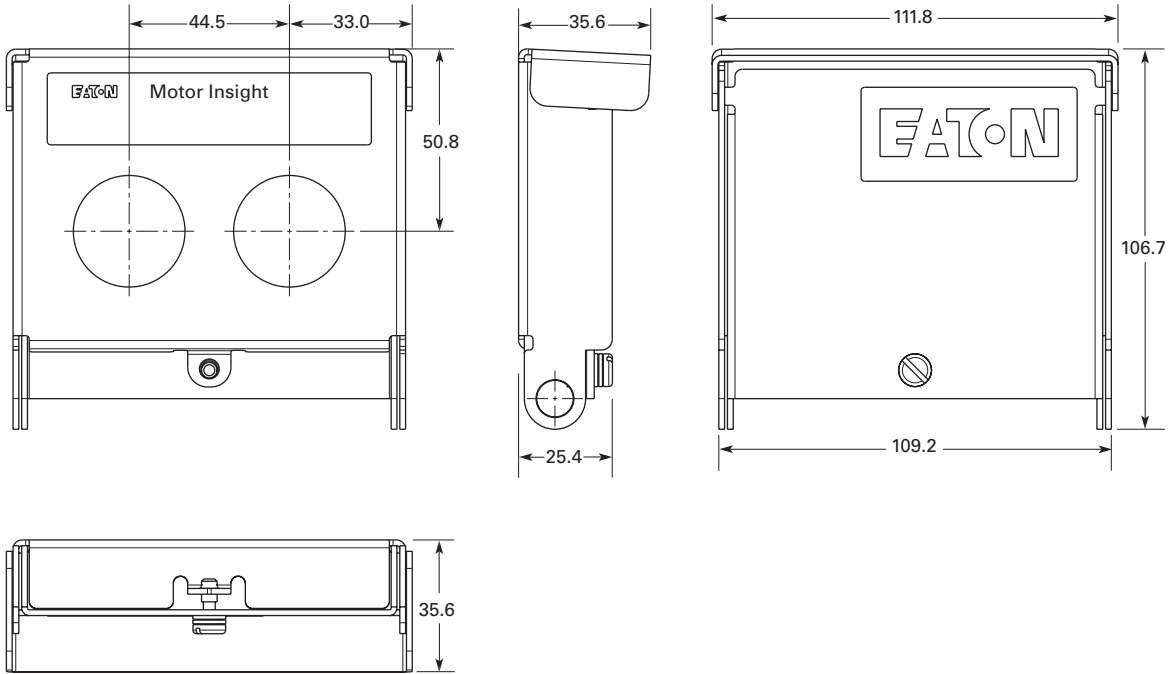

### Motor Insight Conversion Plate

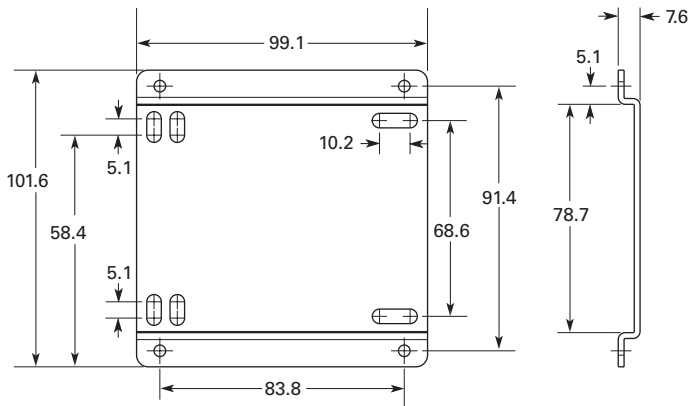





# PKZ and PKE motor-protective circuit-breakers

Machinery and installation downtimes should be kept as short as possible. The PKZ fuseless motor-protective circuit-breakers combine short-circuit and overload protection in one device, allowing fast restart readiness. PKZM01, PKZM0, PKZM4 and PKE have the same accessories. Combines easily with DILM contactors and DS7 soft starters. Connecting PKE to SmartWire-DT® facilitates high data transparency.



## PKZM01 (up to 16 A) motor-protective circuit-breaker with pushbuttons

- Motor-protective circuit-breaker in housing for protection types IP40 and IP65.
- Integrated EMERGENCY STOP and EMERGENCY OFF pushbuttons reduce wiring.

## PKZM0 (up to 32 A) and PKZM4 (up to 65 A) motor-protective circuit-breakers with rotary handle

- Short-circuit proof up to at least 50 kA for easy engineering
- Trip-indicating auxiliary contact enables remote diagnosis
- High safety through application as main switch or repair and maintenance switch
- ATEX approval for protection of EEx e motors up to 65 A



## PKE (up to 65 A) motor-protective circuit-breakers with electronic wide-range overload protection

- High flexibility through plug-in trip block
- Wide current setting ranges enable only five trip blocks up to 65 A
- Precise and extremely long-term stable characteristic curves
- Individual supply through integrated current converter
- ATEX approval for protection of EEx e motors up to 65 A
- Adjustable tripping classes

## DC string circuit-breakers PKZ-SOL and DC switch-disconnectors P-SOL (up to 63 A) for installations

- High string circuit-breaker flexibility due to wide current setting range
- Enclosed switch-disconnector for external mounting (IP65)
- Remote shutdown through optional secondary voltage and shunt trip
- Voltage up to 1000 V DC
- TÜV certified

**Motor-protective circuit-breaker  
PKZM01, PKZM0, PKZM4, PKE**



**DC string circuit-breaker PKZ-SOL,  
DC switch-disconnectors P-SOL, SOL**



**System overview**

PKZM01, PKZM0, PKZM4, PKE motor-protective circuit-breakers . . . . . 2

**Ordering**

Motor-protective circuit-breakers . . . . . 3  
 Motor-protective circuit-breakers for starter combinations . . . . . 6  
 Transformer-protective circuit-breakers . . . . . 6  
 PKE electronic motor-protective circuit-breaker . . . . . 8  
 Standard auxiliary contacts . . . . . 10  
 Auxiliary contacts, shunt releases, undervoltage release . . . . . 12

**Engineering**

Accessories for motor-protective circuit-breakers in enclosures . . . . . 14

**Ordering**

Insulated enclosures . . . . . 16  
 Accessories . . . . . 20  
 Busbar adapters . . . . . 22  
 Wiring sets . . . . . 25  
 Motor feeder plugs, three-phase commoning links . . . . . 26  
 Actuating voltages . . . . . 29

**Engineering**

Motor-protective circuit-breakers . . . . . 30  
 Characteristic curves . . . . . 30  
 Switching capacity . . . . . 32

**Technical data**

Motor-protective circuit-breakers . . . . . 36  
 Auxiliary contacts . . . . . 38

**Dimensions**

PKZM01, PKZM0 motor-protective circuit-breaker . . . . . 39  
 Accessories . . . . . 40  
 PKZM4 motor-protective circuit-breaker . . . . . 45  
 Accessories . . . . . 46

**Description**

DC switches P-SOL, PKZ-SOL, SOL . . . . . 47

**Ordering**

DC switch-disconnector SOL, ready-to-install . . . . . 48  
 DC switch-disconnector P-SOL, open . . . . . 49  
 DC string circuit-breaker PKZ-SOL . . . . . 49

**Engineering**

Circuit P-SOL, PKZ-SOL Interior circuit SOL . . . . . 50  
 Characteristic curves . . . . . 51

**Technical data**

DC switch-disconnectors P-SOL, SOL . . . . . 52  
 DC string circuit-breaker PKZ-SOL . . . . . 53

**Dimensions**

DC switches P-SOL, PKZ-SOL, SOL . . . . . 54

# 1.3

## Motor-protective circuit-breakers PKZM01, PKZM0, PKZM4, PKE

Motor-protective circuit-breaker

### 1 System overview

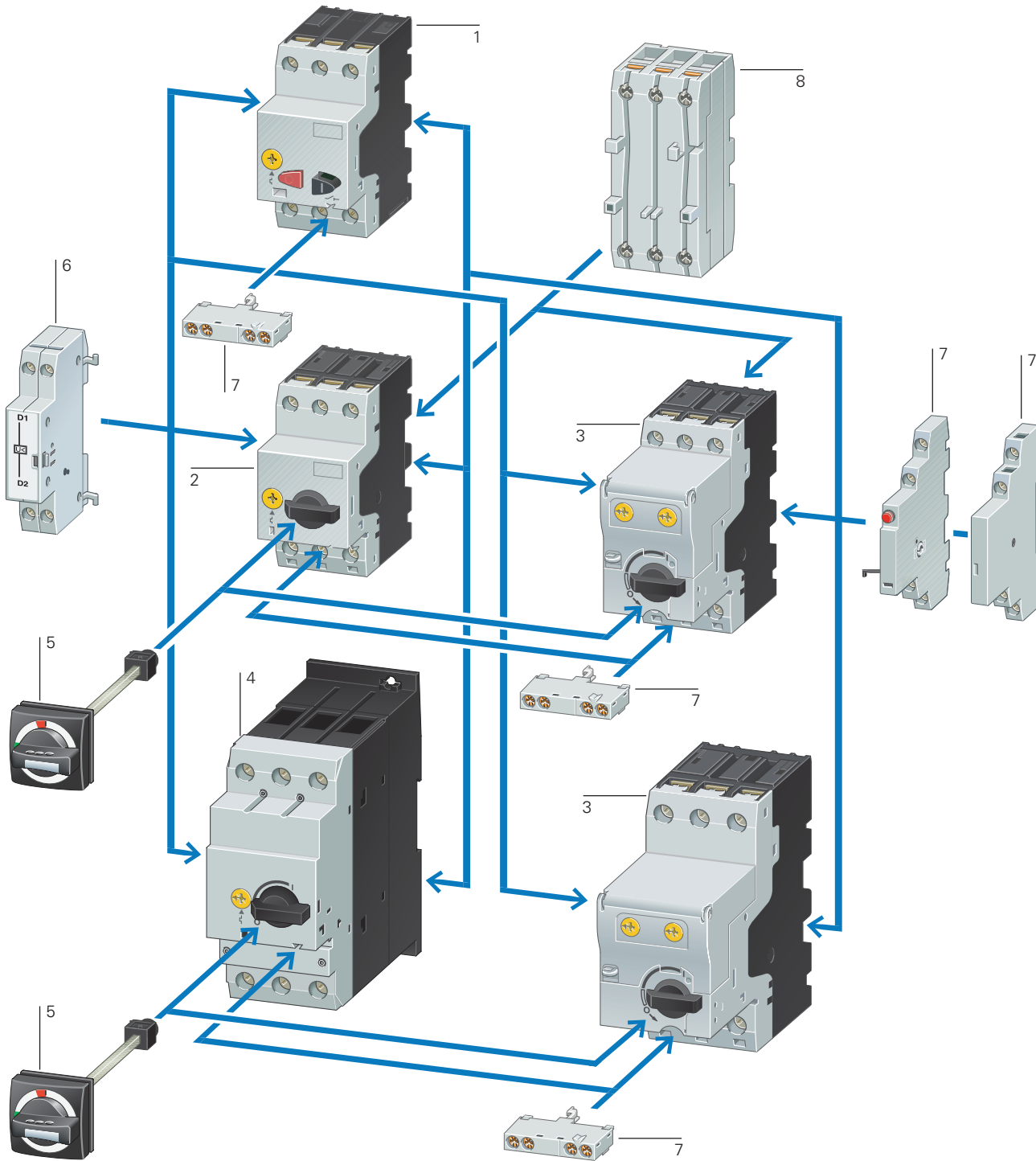

#### Basic devices

|   |   |
|---|---|
| Motor-protective circuit-breaker PKZM01 | 1 |
| → Page 3                                |   |
| Motor-protective circuit-breaker PKZM0  | 2 |
| → Page 4                                |   |

|  |   |
|--|---|
| Motor-protective circuit-breaker with wide-range overload protection | 3 |
| → Page 8   |   |
| Motor-protective circuit-breaker PKZM4                               | 4 |
| → Page 4   |   |

#### Add-on functions

|                             |   |
|-----------------------------|---|
| Standard auxiliary contacts | 7 |
| → Page 10                   |   |
| Shunt release               | 6 |
| → Page 29                   |   |
| Current limiters            | 8 |
| → Page 12                   |   |

#### Mounting accessories

|                            |   |
|----------------------------|---|
| Door coupling handles IP65 | 5 |
| → Page 20                  |   |
| Insulated enclosure        |   |
| → Page 16                  |   |
| Mounting/wiring            |   |
| → Page 22                  |   |

Ordering

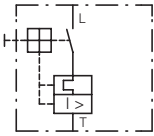
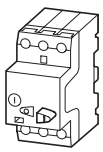

PKZM01

Max. motor rating  
AC-3

|       |       |       |
|-------|-------|-------|
| 220 V | 380 V | 440 V |
| 230 V | 400 V |       |
| 240 V | 415 V |       |

Rated uninter-  
rupted  
current

Setting range

Overload  
releases

Short-  
circuit  
releases

|    |    |    |       |       |          |
|----|----|----|-------|-------|----------|
| P  | P  | P  | $I_u$ | $I_r$ | $I_{rm}$ |
| kW | kW | kW | A     | A     | A        |

Screw terminals

Part no.  
Article no.

Price  
See price  
list

Std. pack

Information relevant for export to  
North America



Motor-protective circuit-breakers, type "1"; and type "2" coordination

| Max. motor rating (kW) | Max. motor rating (kW) | Max. motor rating (kW) | Rated uninter-rupted current (A) | Setting range (A) | Setting range (A) | Part no. / Article no.       | Std. pack | Information relevant for export to North America  |
|------------------------|------------------------|------------------------|----------------------------------|-------------------|-------------------|------------------------------|-----------|---|
| -                      | -                      | -                      | 0.16                             | 0.1...0.16        | 2.2               | <b>PKZM01-0.16</b><br>278475 | 1 off     | Product Standards<br>UL 508; CSA-C22.2 No.14; IEC60947-4-1; CE marking                            |
| -                      | 0.06                   | 0.06                   | 0.25                             | 0.16...0.25       | 3.5               | <b>PKZM01-0.25</b><br>278476 | 1 off     | UL File No.<br>UL CCN<br>E36332   |
| 0.06                   | 0.09                   | 0.12                   | 0.4                              | 0.25...0.4        | 5.6               | <b>PKZM01-0.4</b><br>278477  | 1 off     | CSA File No.<br>12528   |
| 0.09                   | 0.12                   | 0.18                   | 0.63                             | 0.4...0.63        | 8.8               | <b>PKZM01-0.63</b><br>278478 | 1 off     | CSA Class No.<br>3211-05  |
| 0.12                   | 0.25                   | 0.25                   | 1                                | 0.63...1          | 14                | <b>PKZM01-1</b><br>278479    | 1 off     | NA Certification<br>UL Listed, CSA certified  |
| 0.25                   | 0.55                   | 0.55                   | 1.6                              | 1...1.6           | 22                | <b>PKZM01-1.6</b><br>278480  | 1 off     | Suitable for<br>Branch circuits, or<br>suitable for group<br>installations<br>→ Page 34           |
| 0.37                   | 0.75                   | 1.1                    | 2.5                              | 1.6...2.5         | 35                | <b>PKZM01-2.5</b><br>278481  | 1 off     | See also  |
| 0.75                   | 1.5                    | 1.5                    | 4                                | 2.5...4           | 56                | <b>PKZM01-4</b><br>278482    | 1 off     |   |
| 1.1                    | 2.2                    | 3                      | 6.3                              | 4...6.3           | 88                | <b>PKZM01-6.3</b><br>278483  | 1 off     |   |
| 2.2                    | 4                      | 4                      | 10                               | 6.3...10          | 140               | <b>PKZM01-10</b><br>278484   | 1 off     |   |
| 3                      | 5.5                    | 5.5                    | 12                               | 8...12            | 168               | <b>PKZM01-12</b><br>278485   | 1 off     |   |
| 4                      | 7.5                    | 9                      | 16                               | 10...16           | 224               | <b>PKZM01-16</b><br>283390   | 1 off     |   |
| 5.5                    | 9                      | 11                     | 20                               | 16...20           | 280               | <b>PKZM01-20</b><br>283383   | 1 off     | Product Standards<br>UL 508; CSA-C22.2 No.14; IEC/EN 60947-4-1; CE marking                        |
| 5.5                    | 12.5                   | 12.5                   | 25                               | 20...25           | 350               | <b>PKZM01-25</b><br>288893   | 1 off     | UL File No.<br>UL CCN<br>E36332<br>UL CCN<br>NLRV<br>12528<br>3211-05<br>UL Listed, CSA certified |

Notes

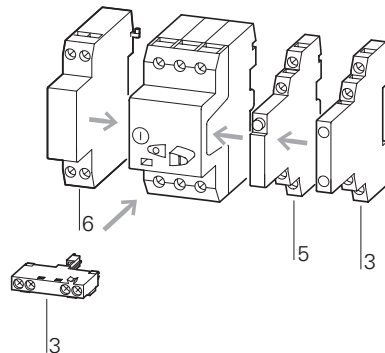

Accessories

- 3 Standard auxiliary contacts
- 5 Trip-indicating auxiliary contact
- 6 Shunt release, undervoltage release

Page

- 10
- 12
- 29

Phase failure sensitivity to IEC/EN 60947-4-1, VDE 0660 Part 102.

Can be snap-fitted to IEC/EN 60715 top-hat rail with 7.5 or 15 mm height

# 1.3

## Motor-protective circuit-breakers PKZM01, PKZM0, PKZM4, PKE

### Motor-protective circuit-breaker

1

Circuit diagrams

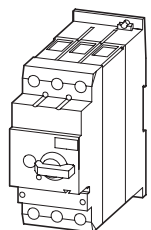
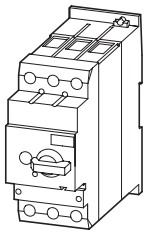
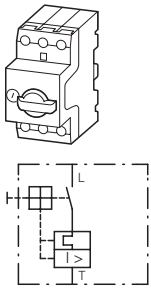

### PKZM0, PKZM4

| Max. motor rating AC-3  |       |       |       |       | Rated uninter-rupted current | Setting range     |                        | Part no. Article no.         | Price See price list | Screw terminals on feed side, spring-loaded terminals on output side |
|---|-------|-------|-------|-------|------------------------------|-------------------|------------------------|------------------------------|----------------------|--|
| 220 V   | 380 V | 440 V | 500 V | 660 V |                              | Overload releases | Short-circuit releases |                              |                      |  |
| 230 V   | 400 V |       |       | 690 V | $I_u$                        | $I_r$             |                        |                              |                      |  |
| 240 V   | 415 V |       |       |       | A                            | A                 |                        |                              |                      |  |
| P kW  | P kW  | P kW  | P kW  | P kW  |                              |                   |                        |                              |                      |  |
| <b>Motor-protective circuit-breakers, type "1" and type "2" coordination<sup>1)</sup></b> |       |       |       |       |                              |                   |                        |                              |                      |  |
| -   | -     | -     | -     | 0.06  | 0.16                         | 0.1...0.16        | 2.2                    | <b>PKZM0-0.16</b><br>072730  |                      | <b>PKZM0-0.16-SC</b><br>229828                                       |
| -   | 0.06  | 0.06  | 0.06  | 0.12  | 0.25                         | 0.16...0.25       | 3.5                    | <b>PKZM0-0.25</b><br>072731  |                      | <b>PKZM0-0.25-SC</b><br>229829                                       |
| 0.06  | 0.09  | 0.12  | 0.12  | 0.18  | 0.4                          | 0.25...0.4        | 5.6                    | <b>PKZM0-0.4</b><br>072732   |                      | <b>PKZM0-0.4-SC</b><br>229830  |
| 0.09  | 0.12  | 0.18  | 0.25  | 0.25  | 0.63                         | 0.4...0.63        | 8.8                    | <b>PKZM0-0.63</b><br>072733  |                      | <b>PKZM0-0.63-SC</b><br>229831                                       |
| 0.12  | 0.25  | 0.25  | 0.37  | 0.55  | 1                            | 0.63...1          | 14                     | <b>PKZM0-1</b><br>072734     |                      | <b>PKZM0-1-SC</b><br>229832  |
| 0.25  | 0.55  | 0.55  | 0.75  | 1.1   | 1.6                          | 1...1.6           | 22                     | <b>PKZM0-1.6</b><br>072735   |                      | <b>PKZM0-1.6-SC</b><br>229833  |
| 0.37  | 0.75  | 1.1   | 1.1   | 1.5   | 2.5                          | 1.6...2.5         | 35                     | <b>PKZM0-2.5</b><br>072736   |                      | <b>PKZM0-2.5-SC</b><br>229834  |
| 0.75  | 1.5   | 1.5   | 2.2   | 3     | 4                            | 2.5...4           | 56                     | <b>PKZM0-4</b><br>072737     |                      | <b>PKZM0-4-SC</b><br>229835  |
| 1.1   | 2.2   | 3     | 3     | 4     | 6.3                          | 4...6.3           | 88                     | <b>PKZM0-6.3</b><br>072738   |                      | <b>PKZM0-6.3-SC</b><br>229836  |
| 2.2   | 4     | 4     | 4     | 7.5   | 10                           | 6.3...10          | 140                    | <b>PKZM0-10</b><br>072739    |                      | <b>PKZM0-10-SC</b><br>229837   |
| 3   | 5.5   | 5.5   | 5.5   | 11    | 12                           | 8...12            | 168                    | <b>PKZM0-12</b><br>278486    |                      | <b>PKZM0-12-SC</b><br>278487   |
| 4   | 7.5   | 9     | 9     | 12.5  | 16                           | 10...16           | 224                    | <b>PKZM0-16</b><br>046938    |                      | <b>PKZM0-16-SC</b><br>229838   |
| 5.5   | 9     | 11    | 12.5  | 15    | 20                           | 16...20           | 280                    | <b>PKZM0-20</b><br>046988    |                      |  |
| 5.5   | 12.5  | 12.5  | 15    | 22    | 25                           | 20...25           | 350                    | <b>PKZM0-25</b><br>046989    |                      |  |
| 7.5   | 15    | 15    | 22    | 30    | 32                           | 25...32           | 448                    | <b>PKZM0-32</b><br>278489    |                      |  |
| <b>Motor-protective circuit-breakers, type "1" and type "2" coordination<sup>1)</sup></b> |       |       |       |       |                              |                   |                        |                              |                      |  |
| 4   | 7.5   | 9     | 9     | 12.5  | 16                           | 10...16           | 224                    | <b>PKZM4-16</b><br>222350    |                      |  |
| 5.5   | 12.5  | 12.5  | 15    | 22    | 25                           | 16...25           | 350                    | <b>PKZM4-25</b><br>222352    |                      |  |
| 7.5   | 15    | 17.5  | 22    | 22    | 32                           | 25...32           | 448                    | <b>PKZM4-32</b><br>222353    |                      |  |
| 11  | 20    | 22    | 24    | 30    | 40                           | 32...40           | 560                    | <b>PKZM4-40</b><br>222354    |                      |  |
| 14  | 25    | 30    | 30    | 45    | 50                           | 40...50           | 700                    | <b>PKZM4-50</b><br>222355    |                      |  |
| 17  | 30    | 37    | 37    | 55    | 58                           | 50...58           | 812                    | <b>PKZM4-58</b><br>222394    |                      |  |
| 18.5  | 34    | 37    | 45    | 55    | 65                           | 55...65           | 882                    | <b>PKZM4-63</b><br>222413    |                      |  |
| <b>Circuit-breakers<sup>2)</sup></b>  |       |       |       |       |                              |                   |                        |                              |                      |  |
| <b>For line and cable protection</b>  |       |       |       |       |                              |                   |                        |                              |                      |  |
| -   | -     | -     | -     | -     | 16                           | 10...16           | 224                    | <b>PKZM4-16-CB</b><br>132591 |                      |  |
| -   | -     | -     | -     | -     | 25                           | 16...25           | 350                    | <b>PKZM4-25-CB</b><br>132592 |                      |  |
| -   | -     | -     | -     | -     | 32                           | 25...32           | 448                    | <b>PKZM4-32-CB</b><br>132593 |                      |  |

### Spring-loaded terminals

**Part no.**      **Price**      **Std. pack**      **Notes**  
 Article no.      See price list

### Information relevant for export to North America



|                               |           |
|-------------------------------|-----------|
| <b>PKZM0-0,16-C</b><br>229669 | 1 off<br> |
| <b>PKZM0-0,25-C</b><br>229670 |           |
| <b>PKZM0-0,4-C</b><br>229671  |           |
| <b>PKZM0-0,63-C</b><br>229672 |           |
| <b>PKZM0-1-C</b><br>229673    |           |
| <b>PKZM0-1,6-C</b><br>229674  |           |
| <b>PKZM0-2,5-C</b><br>229675  |           |
| <b>PKZM0-4-C</b><br>229676    |           |
| <b>PKZM0-6,3-C</b><br>229677  |           |
| <b>PKZM0-10-C</b><br>229678   |           |
| <b>PKZM0-12-C</b><br>278488   |           |
| <b>PKZM0-16-C</b><br>229679   |           |

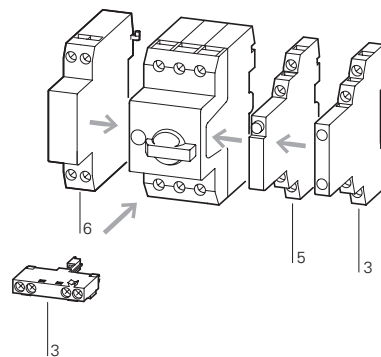

#### Accessories

- 3 Standard auxiliary contacts
- 5 Trip-indicating auxiliary contact
- 6 Shunt release, undervoltage release

#### Page

- 10
- 12
- 29

Phase failure sensitivity to IEC/EN 60947-4-1, VDE 0660 Part 102.  
 Can be snap-fit to IEC/EN 60715 top-hat rail with 7.5 or 15 mm height  
 PTB 02 ATEX 3151, see manual → 21

1)  
 Product Standards      UL 508; CSA-C22.2 No.14; IEC60947-4-1; CE marking  
 UL File No.              E36332  
 UL CCN                    NLRV  
 CSA File No.              12528  
 CSA Class No.            3211-05  
 NA Certification        UL Listed, CSA certified  
 Suitable for              Branch circuit: Manual type E if used with terminal, or suitable for group installations  
 See also                    → Page 34

1 off

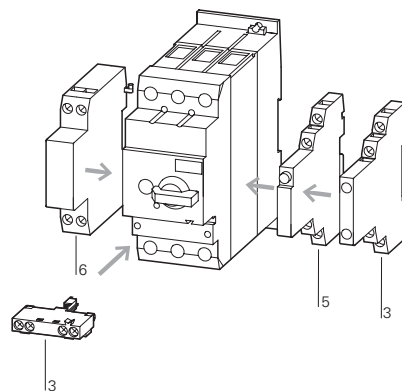

#### Accessories

- 3 Standard auxiliary contacts → 10
- 5 Trip-indicating auxiliary contact → 12
- 6 Shunt release, undervoltage release → 29

Only motor-protective circuit-breaker:  
 Phase failure sensitivity to IEC/EN 60947-4-1, VDE 0660 Part 102  
 Can be snap-fitted to IEC/EN 60715 top-hat rail with 7.5 or 15 mm height  
 PTB 02 ATEX 3153, see manual → 21

1 off

Not usable as a main switch  
 Phase failure sensitivity to IEC/EN 60947-4-1, VDE 0660 Part 102.  
 Switching capacity of SCCR  
 65 kA (480 Y/277 V)  
 22 kA (600 Y/347 V)

2)  
 Product Standards      UL 489; CSA-C22.2 No.5-09; IEC 60947-4-1; CE marking  
 NA Certification        Request filed for UL and CSA  
 Specially designed for NA Yes  
 Suitable for              Feeder and branch circuit as BCPD

# 1.3

## Motor-protective circuit-breakers PKZM01, PKZM0, PKZM4, PKE

Motor-protective circuit-breaker for starter combinations and transformers

1

### PKZM0

| Max. motor rating<br>AC-3 |                         |         |         |                | Rated<br>uninterrupted<br>current<br>$I_u$ | Setting range                 |                                    | Screw terminals<br>Part no.<br>Article no. | Price<br>See price<br>list | Std.<br>pack |
|---------------------------|-------------------------|---------|---------|----------------|--|-------------------------------|------------------------------------|--|----------------------------|--------------|
| 220 V<br>230 V<br>240 V   | 380 V<br>400 V<br>415 V | 440 V   | 500 V   | 660 V<br>690 V |  | Overload<br>releases<br>$I_r$ | Short-circuit<br>releases<br>$I_m$ |  |                            |              |
| P<br>kW                   | P<br>kW                 | P<br>kW | P<br>kW | P<br>kW        | A  | A                             | A                                  |  |                            |              |
|                           |                         |         |         | 0.06           | 0.16                                       |                               | 2.2                                | <b>PKM0-0,16</b><br>072720                 |                            | 1 off        |
|                           | 0.06                    | 0.06    | 0.06    | 0.12           | 0.25                                       |                               | 3.5                                | <b>PKM0-0,25</b><br>072721                 |                            | 1 off        |
| 0.06                      | 0.09                    | 0.12    | 0.12    | 0.18           | 0.4  |                               | 5.6                                | <b>PKM0-0,4</b><br>072722                  |                            | 1 off        |
| 0.09                      | 0.12                    | 0.18    | 0.25    | 0.25           | 0.63                                       |                               | 8.8                                | <b>PKM0-0,63</b><br>072723                 |                            | 1 off        |
| 0.12                      | 0.25                    | 0.25    | 0.38    | 0.55           | 1  |                               | 14                                 | <b>PKM0-1</b><br>072724                    |                            | 1 off        |
| 0.25                      | 0.37                    | 0.55    | 0.75    | 1.1            | 1.6  |                               | 22                                 | <b>PKM0-1,6</b><br>072725                  |                            | 1 off        |
| 0.37                      | 0.75                    | 1.1     | 1.1     | 1.5            | 2.5  |                               | 35                                 | <b>PKM0-2,5</b><br>072726                  |                            | 1 off        |
| 0.75                      | 1.5                     | 1.5     | 2.2     | 3              | 4  |                               | 56                                 | <b>PKM0-4</b><br>072727                    |                            | 1 off        |
| 1.1                       | 2.2                     | 3       | 3       | 4              | 6.3  |                               | 88                                 | <b>PKM0-6,3</b><br>072728                  |                            | 1 off        |
| 2.2                       | 4                       | 4       | 4       | 7.5            | 10   |                               | 140                                | <b>PKM0-10</b><br>072729                   |                            | 1 off        |
| 3                         | 5.5                     | 5.5     | 5.5     | 11             | 12   |                               | 168                                | <b>PKM0-12</b><br>278490                   |                            | 1 off        |
| 4                         | 7.5                     | 9       | 9       | 12.5           | 16   |                               | 224                                | <b>PKM0-16</b><br>044502                   |                            | 1 off        |
| 5.5                       | 9                       | 11      | 12.5    | 15             | 20   |                               | 280                                | <b>PKM0-20</b><br>203594                   |                            | 1 off        |
| 5.5                       | 12.5                    | 12.5    | 15      | 22             | 25   |                               | 350                                | <b>PKM0-25</b><br>044503                   |                            | 1 off        |
| 7.5                       | 15                      | 15      | 22      | 30             | 32   |                               | 448                                | <b>PKM0-32</b><br>278491                   |                            | 1 off        |
|                           |                         |         |         | 0.16           | 0.16                                       | 0.1...0.16                    | 2.4                                | <b>PKZM0-0,16-T</b><br>088907              |                            | 1 off        |
|                           |                         |         |         | 0.25           | 0.25                                       | 0.16...0.25                   | 4.25                               | <b>PKZM0-0,25-T</b><br>088908              |                            | 1 off        |
|                           |                         |         |         | 0.4            | 0.4  | 0.25...0.4                    | 6.8                                | <b>PKZM0-0,4-T</b><br>088909               |                            | 1 off        |
|                           |                         |         |         | 0.63           | 0.63                                       | 0.4...0.63                    | 12                                 | <b>PKZM0-0,63-T</b><br>088910              |                            | 1 off        |
|                           |                         |         |         | 1              | 1  | 0.63...1                      | 20                                 | <b>PKZM0-1-T</b><br>088911                 |                            | 1 off        |
|                           |                         |         |         | 1.6            | 1.6  | 1...1.6                       | 32                                 | <b>PKZM0-1,6-T</b><br>088912               |                            | 1 off        |
|                           |                         |         |         | 2.5            | 2.5  | 1.6...2.5                     | 50                                 | <b>PKZM0-2,5-T</b><br>088913               |                            | 1 off        |
|                           |                         |         |         | 4              | 4  | 2.5...4                       | 84                                 | <b>PKZM0-4-T</b><br>088914                 |                            | 1 off        |
|                           |                         |         |         | 6.3            | 6.3  | 4...6.3                       | 141                                | <b>PKZM0-6,3-T</b><br>088915               |                            | 1 off        |
|                           |                         |         |         | 10             | 10   | 6.3...10                      | 224                                | <b>PKZM0-10-T</b><br>088916                |                            | 1 off        |
|                           |                         |         |         | 12             | 12   | 8...12                        | 224                                | <b>PKZM0-12-T</b><br>278492                |                            | 1 off        |
|                           |                         |         |         | 16             | 16   | 10...16                       | 280                                | <b>PKZM0-16-T</b><br>088917                |                            | 1 off        |
|                           |                         |         |         | 20             | 20   | 16...20                       | 350                                | <b>PKZM0-20-T</b><br>088918                |                            | 1 off        |
|                           |                         |         |         | 25             | 25   | 20...25                       | 437                                | <b>PKZM0-25-T</b><br>278493                |                            | 1 off        |

Motor-protective circuit-breakers for starter combinations  
Short-circuit protective breakers without overload function

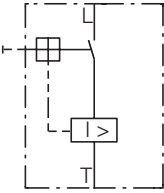
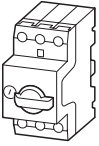

Transformer-protective circuit-breakers

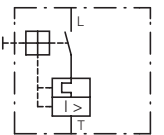
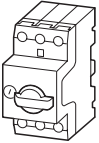

**Notes**

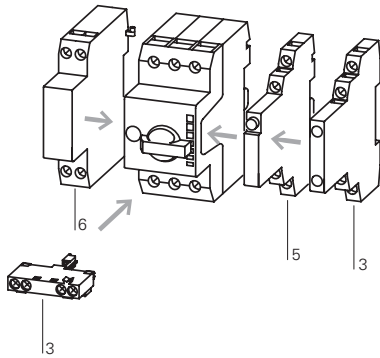

When using the PKM0 as short-circuit protection for motors with heavy starting duty, a device must be selected whose rated operational current  $I_e$  is higher by the following factors:

- CLASS 5 = 1.0
- CLASS 10 = 1.0
- CLASS 15 = 1.22
- CLASS 20 = 1.41
- CLASS 25 = 1.58
- CLASS 30 = 1.73
- CLASS 35 = 1.89
- CLASS 40 = 2.0

**Accessories**

- 3 Standard auxiliary contacts
- 5 Trip-indicating auxiliary contact
- 6 Shunt release, undervoltage release
- Additional accessories

**Page**

- 10
- 12
- 29
- 46

Can be snap-fitted to IEC/EN 60715 top-hat rail with 7.5 or 15 mm height

Assignment of the short-circuit protective breakers and contactors in "Fuseless motor-starter combinations" section.

An appropriate overload relay must be fitted to protect motors against overload.

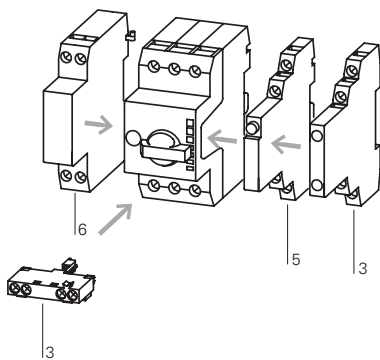

**Accessories**

- 3 Standard auxiliary contacts
- 5 Trip-indicating auxiliary contact
- 6 Shunt release, undervoltage release

**Page**

- 10
- 12
- 29

For the protection of transformers with a high inrush current

Can be snap-fitted to IEC/EN 60715 top-hat rail with 7.5 or 15 mm height

Phase failure sensitivity to IEC/EN 60947-4-1, VDE 0660 Part 102.















# 1.3

## Motor-protective circuit-breakers PKZM01, PKZM0, PKZM4, PKE

### Motor-protective circuit-breaker

#### PKE

1

| Motor rating   | Motor full-load current         |                         |       |       |                | Setting range<br>Overload releases | Basic device<br>Part no.<br>Article no. | See price<br>list | Std. pack   |
|--|---------------------------------|-------------------------|-------|-------|----------------|------------------------------------|---|-------------------|---|
|  | AC-3<br>220 V<br>230 V<br>240 V | 380 V<br>400 V<br>415 V | 440 V | 500 V | 660 V<br>690 V |                                    |   |                   |   |
| P  | I                               | I                       | I     | I     | I              |                                    |   |                   |   |
| kW   | A                               | A                       | A     | A     | A              |                                    |   |                   |   |
| <b>Motor-protective circuit-breakers, type "1" and type "2" coordination</b> |                                 |                         |       |       |                |                                    |   |                   |   |
| 0.06   | 0.37                            | –                       | –     | –     | –              | 0.3...1.2 A                        | <b>PKE12</b><br>121721                  |                   | 1off<br>      |
| 0.09   | 0.54                            | 0.31                    | –     | –     | –              |                                    |   |                   |   |
| 0.12   | 0.72                            | 0.41                    | 0.37  | 0.33  | –              |                                    |   |                   |   |
| 0.18   | 1.04                            | 0.6                     | 0.54  | 0.48  | 0.35           |                                    |   |                   |   |
| 0.25   | –                               | 0.8                     | 0.76  | 0.7   | 0.5            |                                    |   |                   |   |
| 0.37   | –                               | 1.1                     | 1.02  | 0.9   | 0.7            |                                    |   |                   |   |
| 0.55   | –                               | –                       | –     | –     | 0.9            |                                    |   |                   |   |
| 0.75   | –                               | –                       | –     | –     | 1.1            |                                    |   |                   |   |
| 0.18   | 1.04                            | –                       | –     | –     | –              | 1...4 A                            | <b>PKE12</b><br>121721                  |                   | 1off<br>      |
| 0.25   | 1.4                             | –                       | –     | –     | –              |                                    |   |                   |   |
| 0.37   | 2                               | 1.1                     | 1.02  | –     | –              |                                    |   |                   |   |
| 0.55   | 2.7                             | 1.5                     | 1.39  | 1.2   | –              |                                    |   |                   |   |
| 0.75   | 3.2                             | 1.9                     | 1.68  | 1.5   | 1.1            |                                    |   |                   |   |
| 1.1  | –                               | 2.6                     | 2.41  | 2.1   | 1.5            |                                    |   |                   |   |
| 1.5  | –                               | 3.6                     | 3.28  | 2.9   | 2.1            |                                    |   |                   |   |
| 2.2  | –                               | –                       | –     | 4     | 2.9            |                                    |   |                   |   |
| 3  | –                               | –                       | –     | –     | 3.8            |                                    |   |                   |   |
| 0.75   | 3.2                             | –                       | –     | –     | –              | 3...12 A                           | <b>PKE12</b><br>121721                  |                   | 1off<br>  |
| 1.1  | 4.6                             | –                       | –     | –     | –              |                                    |   |                   |   |
| 1.5  | 6.3                             | 3.6                     | 3.3   | –     | –              |                                    |   |                   |   |
| 2.2  | 8.7                             | 5                       | 4.6   | 4     | –              |                                    |   |                   |   |
| 3  | 11.5                            | 6.6                     | 6     | 5.3   | 3.8            |                                    |   |                   |   |
| 4  | –                               | 8.5                     | 7.7   | 6.8   | 4.9            |                                    |   |                   |   |
| 5.5  | –                               | 11.3                    | 10.2  | 9     | 6.5            |                                    |   |                   |   |
| 7.5  | –                               | –                       | –     | –     | 8.8            |                                    |   |                   |   |
| 2.2  | 8.7                             | –                       | –     | –     | –              | 8...32 A                           | <b>PKE32</b><br>121722                  |                   | 1off<br>  |
| 3  | 11.5                            | –                       | –     | –     | –              |                                    |   |                   |   |
| 4  | 14.8                            | 8.5                     | –     | –     | –              |                                    |   |                   |   |
| 5.5  | 19.6                            | 11.3                    | 10.2  | 9     | –              |                                    |   |                   |   |
| 7.5  | 26.4                            | 15.2                    | 13.8  | 12.1  | 8.8            |                                    |   |                   |   |
| 11   | –                               | 21.7                    | 19.8  | 17.4  | 12.6           |                                    |   |                   |   |
| 15   | –                               | 29.3                    | 26.6  | 23.4  | 17             |                                    |   |                   |   |
| 18.5   | –                               | –                       | –     | 28.9  | 20.9           |                                    |   |                   |   |
| 22   | –                               | –                       | –     | –     | 23.8           |                                    |   |                   |   |
| 30   | –                               | –                       | –     | –     | 32             |                                    |   |                   |   |
| 5.5  | 19.6                            | –                       | –     | –     | –              | 16...65 A                          | <b>PKE65</b><br>138258                  |                   | 1off<br>  |
| 7.5  | 26.4                            | –                       | –     | –     | –              |                                    |   |                   |   |
| 11   | 38                              | 21.7                    | 19.7  | 17.4  | –              |                                    |   |                   |   |
| 15   | 51                              | 29.3                    | 26.6  | 23.4  | 17             |                                    |   |                   |   |
| 18.5   | 63                              | 36                      | 32.9  | 28.9  | 20.9           |                                    |   |                   |   |
| 22   | –                               | 41                      | 37.4  | 33    | 23.8           |                                    |   |                   |   |
| 30   | –                               | 55                      | 50.3  | 44    | 32             |                                    |   |                   |   |
| 37   | –                               | –                       | 61.4  | 54    | 39             |                                    |   |                   |   |
| 45   | –                               | –                       | –     | 65    | 47             |                                    |   |                   |   |
| 55   | –                               | –                       | –     | –     | 58             |                                    |   |                   |   |
| 2.2  | 8.7                             | –                       | –     | –     | –              | 8...32 A                           | <b>PKE65</b><br>138258                  |                   | 1off<br>  |
| 3  | 11.5                            | –                       | –     | –     | –              |                                    |   |                   |   |
| 4  | 14.8                            | 8.5                     | –     | –     | –              |                                    |   |                   |   |
| 5.5  | 19.6                            | 11.3                    | 10.2  | 9     | –              |                                    |   |                   |   |
| 7.5  | 26.4                            | 15.2                    | 13.8  | 12.1  | 8.8            |                                    |   |                   |   |
| 11   | –                               | 21.7                    | 19.8  | 17.4  | 12.6           |                                    |   |                   |   |
| 15   | –                               | 29.3                    | 26.6  | 23.4  | 17             |                                    |   |                   |   |
| 18.5   | –                               | –                       | –     | 28.9  | 20.9           |                                    |   |                   |   |
| 22   | –                               | –                       | –     | –     | 23.8           |                                    |   |                   |   |
| 30   | –                               | –                       | –     | –     | 32             |                                    |   |                   |   |
|  |                                 |                         |       |       |                |                                    | Start of delivery<br>07/2010            |                   |   |
|  |                                 |                         |       |       |                |                                    | Start of delivery<br>07/2010            |                   |   |

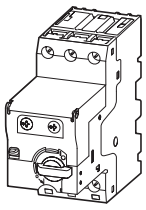
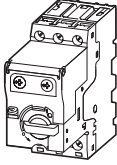

























**Notes** Select switchgear and cables according to Class as shown in the table on Chapter 1.2 (Page 22)  
<sup>1)</sup> For communications, module PKE-SWD-32 for contactors is required in addition, → See catalog

# Motor-protective circuit-breakers PKZM01, PKZM0, PKZM4, PKE

## Motor-protective circuit-breaker

# 1.3

1

| Trip module Standard |                              |                              |   | Trip module Expanded <sup>1)</sup> |                              |                              |   | Motor-protective circuit-breakers Standard Complete device |                              |   |  |
|----------------------|------------------------------|------------------------------|---|------------------------------------|------------------------------|------------------------------|---|--|------------------------------|---|--|
| usable for           | Part no.<br>Article no.      | See price list               | Std. pack   | usable for                         | Part no.<br>Article no.      | See price list               | Std. pack   | Part no.<br>Article no.                                    | See price list               | Std. pack   |  |
|                      | <b>PKE12</b>                 |                              | 1off<br>      | <b>PKE12</b>                       | <b>PKE-XTU-1,2</b><br>121723 |                              | 1off<br>      | <b>PKE12/XTU-1,2</b><br>121731                             |                              | 1off<br>      |  |
|                      |                              | Start of delivery<br>07/2010 |   |                                    |                              | Start of delivery<br>07/2010 |   |  | Start of delivery<br>07/2010 |   |  |
|                      | <b>PKE12</b>                 |                              | 1off<br>      | <b>PKE12</b>                       | <b>PKE-XTU-4</b><br>121724   |                              | 1off<br>      | <b>PKE12/XTU-4</b><br>121732                               |                              | 1off<br>      |  |
|                      |                              |                              |   |                                    |                              | Start of delivery<br>05/2010 |   |  |                              |   |  |
|                      | <b>PKE12</b><br><b>PKE32</b> |                              | 1off<br>  | <b>PKE12</b><br><b>PKE32</b>       | <b>PKE-XTU-12</b><br>121725  |                              | 1off<br>  | <b>PKE12/XTU-12</b><br>121733                              |                              | 1off<br>  |  |
|                      |                              |                              |   |                                    |                              | Start of delivery<br>05/2010 |   |  |                              |   |  |
|                      | <b>PKE32</b>                 |                              | 1off<br>  | <b>PKE32</b>                       | <b>PKE-XTU-32</b><br>121726  |                              | 1off<br>  | <b>PKE32/XTU-32</b><br>121734                              |                              | 1off<br>  |  |
|                      |                              |                              |   |                                    |                              | Start of delivery<br>05/2010 |   |  |                              |   |  |
|                      | <b>PKE65</b>                 |                              | 1off<br>  | <b>PKE65</b>                       | <b>PKE-XTU-65</b><br>138259  |                              | 1off<br>  | <b>PKE65/XTU-65</b><br>138516                              |                              | 1off  |  |
|                      |                              | Start of delivery<br>10/2010 |   |                                    |                              | Start of delivery<br>10/2010 |   |  | Start of delivery<br>10/2010 |   |  |
|                      | <b>PKE65</b>                 |                              | 1off<br>  | <b>PKE65</b>                       | <b>PKE-XTUW-32</b><br>138261 |                              | 1off<br>  | <b>PKE65/XTUW-32</b><br>138517                             |                              | 1 off   |  |
|                      |                              | Start of delivery<br>10/2010 |   |                                    |                              | Start of delivery<br>10/2010 |   |  | Start of delivery<br>10/2010 |   |  |

Information relevant for export to North America  
 

Product Standards  
NA Certification

UL 508; CSA-C22.2 No. 14; IEC60947-4-1; CE marking  
Request filed for UL and CSA

# 1.3

## Motor-protective circuit-breakers PKZM01, PKZM0, PKZM4, PKE Standard auxiliary contacts

1

### NHI...-PKZ0... Standard auxiliary contacts

For motor-protective circuit-breakers

| Contact configuration                | Contact sequence                     | Circuit diagrams | Connection method | For use with            | Part no.<br>Article no.                               | Price<br>See price list          | Std. pack |
|--------------------------------------|--------------------------------------|------------------|-------------------|-------------------------|---|----------------------------------|-----------|
| 1 N/O<br>N/O = normally open contact | 1 NC<br>NC = normally closed contact |                  |                   | Screw terminals         | PKZM01<br>PKZM0<br>PKZM4<br>PKZM0-T<br>PKM0<br>PKE 1) | <b>NHI11-PKZ0</b><br>072896      | 5 off<br> |
| 1 N/O                                | 1 NC                                 |                  |                   | Spring-loaded terminals | PKZM01<br>PKZM0<br>PKZM4<br>PKZM0-T<br>PKM0<br>PKE 1) | <b>NHI11-PKZ0-C</b><br>229680    | 5 off<br> |
| 1 N/O                                | 2 NC                                 |                  |                   | Screw terminals         | PKZM01<br>PKZM0<br>PKZM4<br>PKZM0-T<br>PKM0<br>PKE 1) | <b>NHI12-PKZ0</b><br>072895      | 5 off<br> |
| 2 N/O                                | 1 NC                                 |                  |                   | Screw terminals         | PKZM01<br>PKZM0<br>PKZM4<br>PKZM0-T<br>PKM0<br>PKE 1) | <b>NHI21-PKZ0</b><br>072894      | 5 off<br> |
| 1 N/O                                | 1 NC                                 |                  |                   | Screw terminals         | PKZM01<br>PKZM0<br>PKZM4<br>PKZM0-T<br>PKM0<br>PKE 1) | <b>NHI-E-11-PKZ0</b><br>082882   | 5 off<br> |
| 1 N/O                                | -                                    |                  |                   | Screw terminals         | PKZM01<br>PKZM0<br>PKZM4<br>PKZM0-T<br>PKM0<br>PKE 1) | <b>NHI-E-10-PKZ0</b><br>082884   | 5 off<br> |
| 1 N/O                                | -                                    |                  |                   | Spring-loaded terminals | PKZM01<br>PKZM0<br>PKZM4<br>PKZM0-T<br>PKM0<br>PKE 1) | <b>NHI-E-10-PKZ0-C</b><br>229681 | 5 off<br> |
| -                                    | 1 NC                                 |                  |                   | Spring-loaded terminals | PKZM01<br>PKZM0<br>PKZM4<br>PKZM0-T<br>PKM0<br>PKE 1) | <b>NHI-E-01-PKZ0-C</b><br>229682 | 5 off     |
| 1 N/O                                | 1 NC                                 |                  |                   | Screw terminals         | PKZM01<br>PKZM0<br>PKZM4<br>PKZM0-T<br>PKM0<br>PKE 1) | <b>NHI-B-11-PKZ0</b><br>208277   | 5 off     |

**Notes**

1) Only standard auxiliary contacts manufactured on or after CW 36/2009 are for use with PKE.

### Notes

Can be fitted to the right side of: motor-protective circuit-breakers, transformer protective circuit breakers and motor-protective circuit-breakers for starter combinations

Can be combined with:  
Trip-indicating auxiliary contact AGM, NHI-E...

### Notes

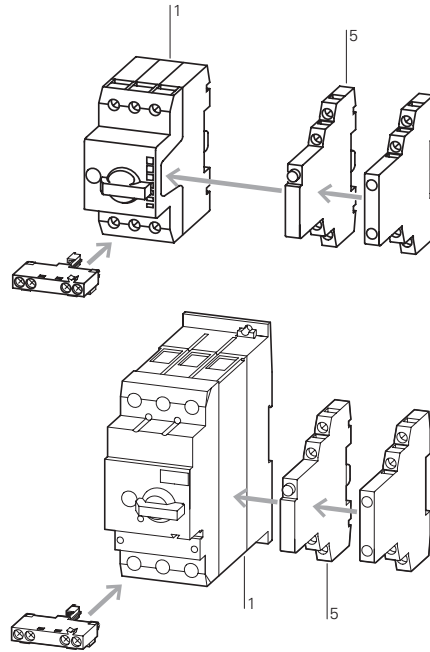

### Information relevant for export to North America



|                   |  |
|-------------------|--|
| Product Standards | UL 508; CSA-C22.2No.14;<br>IEC 60947-4-1; CE marking |
| UL File No.       | E36332   |
| UL CCN            | NLRV   |
| CSA File No.      | 12528  |
| CSA Class No.     | 3211-05  |
| NA Certification  | UL Listed, CSA certified                             |

Can be fitted to motor-protective circuit-breakers, transformer-protective circuit-breakers and motor-protective circuit-breakers for starter combinations from serial number 01. 45 mm (PKZM0 and PKZM01) or 55 mm (PKZM4) widths of the motor-protective circuit-breakers remain unchanged.  
NHI-E...-PKZ0-C not for use with MSC...-type motor starter combinations.

### Accessories

- 1 Motor-protective circuit-breakers → 4
- 5 Trip-indicating auxiliary contact → 12
- Additional accessories → 20

# 1.3

## Motor-protective circuit-breakers PKZM01, PKZM0, PKZM4, PKE Auxiliary contacts, undervoltage releases

1

### AGM2...., VHI...

Contact configuration

N/O = normally open contact  
NC = normally closed contact

Contact sequence

Circuit diagrams

For use with

Part no.  
Article no.

Price  
See price list

Std. pack

#### Trip indicators

##### For motor-protective circuit-breakers

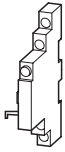

2 x 1 N/O

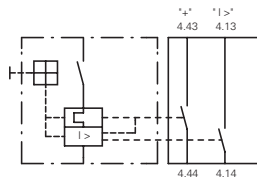
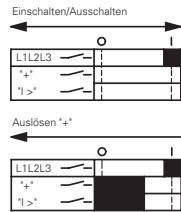

PKZM0  
PKZM4  
PKZM0-T  
PKM0  
PKZM01  
PKE<sup>1)</sup>

**AGM2-10-PKZ0**  
072898

2 off

– 2 x 1 NC

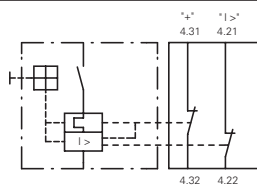
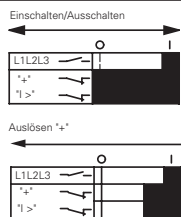

PKZM0  
PKZM4  
PKZM0-T  
PKM0  
PKZM01  
PKE<sup>1)</sup>

**AGM2-01-PKZ0**  
072899

2 off

#### Early-make auxiliary contacts

##### For motor-protective circuit-breakers



2 N/O

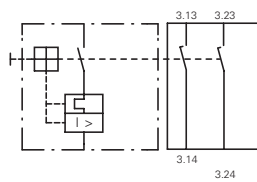

PKZM0  
PKZM0-T  
PKM0  
PKZM4

**VHI20-PKZ0**  
203595

2 off

2 N/O



PKZM01

**VHI20-PKZ01**  
278495

5 off

#### Shunt release (for power circuit-breakers)

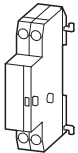

–

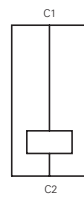

PKZM0  
PKZM4  
PKZM0-T  
PKM0  
PKZM01  
PKE<sup>2)</sup>

**A-PKZ0(230V50Hz)**  
073187

2 off

–

PKZM0  
PKZM4  
PKZM0-T  
PKM0  
PKZM01  
PKE<sup>2)</sup>

**A-PKZ0(24VDC)**  
073200

2 off

#### Undervoltage release

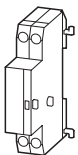

–

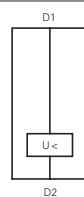

PKZM0  
PKZM4  
PKZM0-T  
PKM0  
PKZM01  
PKE<sup>2)</sup>

**U-PKZ0(230V50Hz)**  
073135

2 off

#### Current limiters

##### For increasing switching capacity of motor-protective circuit-breakers without auto-protection

–

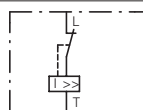

PKZM0  
PKZM4  
PKE

**CL-PKZ0**  
082881

1 off

#### Notes

- <sup>1)</sup> Only AGM2-...-PKZ0 manufactured on or after 06/2009 can be fitted.
- <sup>2)</sup> Only A(U)-PKZ0... with serial number 02 or higher can be fitted.

**Notes**

Can be fitted to the right side of motor-protective circuit-breakers

Can be combined with:  
Standard auxiliary contacts  
NHI11-PKZO  
NHI12-PKZO  
NHI21-PKZO  
NHI-E...

Separate indication of:  
a) General trip indication (overload)  
b) Short-circuit trip

Local short-circuit indication by red indicator, manually resettable.

Can be fitted to front of motor-protective circuit-breaker, 45 mm width of the motor-protective circuit-breaker remains unchanged.  
For early energization of undervoltage release, e.g. in emergency switching off circuits to EN 60204.  
VHI20-PKZO cannot be used in combination with PKZO-X(R).

**Notes**

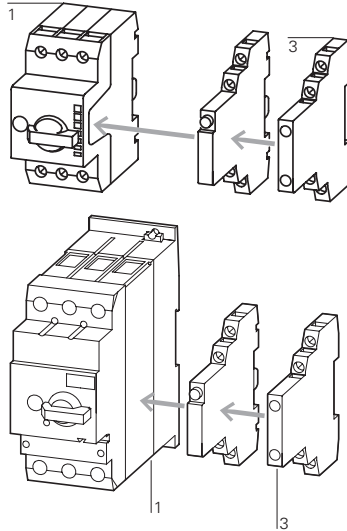

**Accessories**

- 1 Motor-protective circuit-breakers
- 3 Standard auxiliary contacts

**Page**

- 4
- 10

**Information relevant for export to North America**



|                   |  |
|-------------------|--|
| Product Standards | UL 508; CSA-C22.2No.14; IEC60947-4-1; CE marking |
| UL File No.       | E36332   |
| UL CCN            | NLRV   |
| CSA File No.      | 12528  |
| CSA Class No.     | 3211-05  |
| NA Certification  | UL Listed, CSA certified                         |

Can be fitted to the left side of motor-protective circuit-breakers.  
Cannot be combined with:  
undervoltage release U-PKZO  
DC: Intermittent operation 5 s

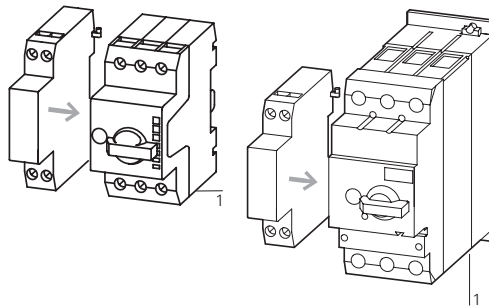

**Accessories**

- 1 Motor-protective circuit-breakers
- Further actuating voltages

**Page**

- 4
- 29

Can be fitted to the left side of motor-protective circuit-breakers.  
Cannot be combined with:  
A-PKZO shunt release  
When combined with circuit-breaker, can be used as emergency switching off device to IEC/EN 60204.

Max. rated operating voltage  $U_n = 690$  V, rated uninterrupted current  $I_n = 63$  A  
Can be used for individual and group protection.  
For group protection and in combination with PKZM4, order additional BK25/3 incoming terminal if required.  
Mounting next to or behind the motor-protective circuit-breaker.  
PKZM4: 16 - 63 A: 100 kA/400 V  
PKZM4: 16 - 63 A: 10 kA/690 V











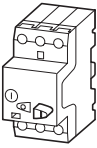

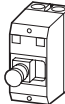
# 1.3

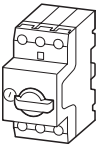
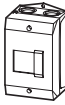
## Motor-protective circuit-breakers PKZM01, PKZM0, PKZM4, PKE

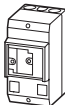
Accessories for motor-protective circuit-breakers in enclosures

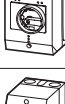
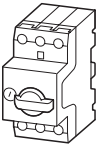





### 1 Engineering

#### PKZM01, PKZM

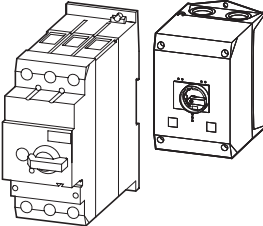
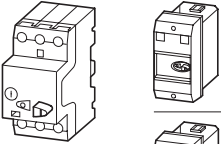
| Part no.  | Enclosure   |  | Degree of protection | Handle color | Accessories |              |               |             |                 |                  |        |  |
|---|---|--|----------------------|--------------|-------------|--------------|---------------|-------------|-----------------|------------------|--------|--|
|   | Part no.  |  |                      |              | NHI...-PKZ0 | AGM2...-PKZ0 | NHI-E...-PKZ0 | VHI...-PKZ0 | VHI...-PKZ01    | U-PKZ0 or A-PKZ0 | L-PKZ0 |  |
| <b>Surface mounting enclosure</b>   |   |  |                      |              |             |              |               |             |                 |                  |        |  |
| <b>Motor-protective circuit-breaker PKZM01</b>  |   |  |                      |              |             |              |               |             |                 |                  |        |  |
|       |    | <b>CI-PKZ01</b>                              | IP40                 | —            | —           | —            | ●             | —           | —               | ●                | ●      |  |
|   |   |  |                      |              | —           | —            | —             | —           | ●               | ●                | ●      |  |
|   |   |  |                      |              | ●           | —            | ●             | —           | —               | —                | ●      |  |
|   |   |  |                      |              | ●           | —            | —             | —           | ●               | —                | ●      |  |
|   |    | <b>CI-PKZ01-G</b>                            | IP65                 | —            | —           | —            | ●             | —           | —               | ●                | ●      |  |
|   |   |  |                      |              | —           | —            | —             | —           | ●               | ●                | ●      |  |
|   |   |  |                      |              | ●           | —            | ●             | —           | —               | —                | ●      |  |
|   |   |  |                      |              | ●           | —            | —             | —           | ●               | —                | ●      |  |
|   |   | <b>CI-PKZ01-PVT</b><br><b>CI-PKZ01-PVS</b>   | IP65                 | Red-yellow   | —           | —            | ●             | —           | —               | ●                | ●      |  |
|   |   |  |                      |              | —           | —            | —             | —           | ●               | ●                | ●      |  |
|   |   |  |                      |              | —           | —            | —             | —           | ●               | ●                | ●      |  |
|   |  | <b>CI-PKZ01-SVB</b><br><b>CI-PKZ01-SVB-V</b> | IP65                 | —            | —           | —            | ●             | —           | —               | ●                | ●      |  |
|   |   |  |                      |              | —           | —            | —             | —           | ● <sup>1)</sup> | ●                | ●      |  |
|   |   |  |                      |              | —           | —            | —             | —           | —               | ●                | ●      |  |
| <b>Motor-protective circuit-breaker PKZM0</b>   |   |  |                      |              |             |              |               |             |                 |                  |        |  |
|     |  | <b>CI-K2-PKZ0</b>                            | IP41                 | —            | ●           | —            | ●             | —           | —               | ●                | ●      |  |
|   |   |  |                      |              | —           | ●            | ●             | —           | —               | ●                | ●      |  |
|   |   |  |                      |              | ●           | —            | ●             | —           | —               | ●                | ●      |  |
|   |   |  |                      |              | —           | ●            | ●             | —           | —               | ●                | ●      |  |
|   |  | <b>CI-K2-PKZ0-G</b>                          | IP65                 | Black        | ●           | —            | ●             | —           | —               | ●                | ●      |  |
|   |   |  |                      |              | —           | ●            | ●             | —           | —               | ●                | ●      |  |
|   |   |  |                      |              | ●           | —            | ●             | —           | —               | ●                | ●      |  |
|   |  | <b>CI-K2-PKZ0-GR</b>                         | IP65                 | Red-yellow   | ●           | —            | ●             | —           | —               | ●                | ●      |  |
|   |   |  |                      |              | —           | ●            | ●             | —           | —               | ●                | ●      |  |
|   |   |  |                      |              | —           | —            | ●             | —           | —               | ●                | ●      |  |
|   |  | <b>CI-PKZ0-M</b>                             | IP40                 | —            | ●           | —            | ●             | —           | —               | —                | ●      |  |
|   |   |  |                      |              | —           | —            | ●             | —           | —               | ●                | ●      |  |
|   |   |  |                      |              | —           | —            | ●             | —           | —               | —                | ●      |  |
|   |  | <b>CI-PKZ0-GM</b>                            | IP55                 | Black        | ●           | —            | ●             | —           | —               | —                | ●      |  |
|   |   |  |                      |              | —           | —            | ●             | —           | —               | ●                | ●      |  |
|   |   |  |                      |              | —           | —            | ●             | —           | —               | —                | ●      |  |
|   |  | <b>CI-PKZ0-GRM</b>                           | IP55                 | Red-yellow   | ●           | —            | ●             | —           | —               | —                | ●      |  |
|   |   |  |                      |              | —           | —            | ●             | —           | —               | —                | ●      |  |
|   |   |  |                      |              | —           | —            | ●             | —           | —               | ●                | ●      |  |
| <b>Motor-protective circuit-breaker PKZM0 + early-make auxiliary contact VHI-PKZ0</b> |   |  |                      |              |             |              |               |             |                 |                  |        |  |
|     |  | <b>CI-K2-PKZ0-GV</b>                         | IP65                 | Black        | ●           | —            | —             | ●           | —               | ●                | ●      |  |
|   |   |  |                      |              | —           | ●            | —             | ●           | —               | ●                | ●      |  |
|   |   |  |                      |              | ●           | —            | —             | ●           | —               | ●                | ●      |  |
|   |   |  |                      |              | —           | ●            | —             | ●           | —               | ●                | ●      |  |
|   |  | <b>CI-K2-PKZ0-GRV</b>                        | IP65                 | Red-yellow   | ●           | —            | —             | ●           | —               | ●                | ●      |  |
|   |   |  |                      |              | —           | ●            | —             | ●           | —               | ●                | ●      |  |
|   |   |  |                      |              | —           | —            | —             | ●           | —               | —                | ●      |  |
|   |   |  |                      |              | —           | —            | —             | ●           | —               | ●                | ●      |  |
|   |  | <b>CI-K2-PKZ0-GVM</b>                        | IP55                 | Black        | ●           | —            | —             | ●           | —               | —                | ●      |  |
|   |   |  |                      |              | —           | —            | —             | ●           | —               | ●                | ●      |  |
|   |   |  |                      |              | —           | —            | —             | ●           | —               | —                | ●      |  |
|   |   |  |                      |              | —           | —            | —             | ●           | —               | ●                | ●      |  |
|   |  | <b>CI-K2-PKZ0-GRVM</b>                       | IP55                 | Red-yellow   | ●           | —            | —             | ●           | —               | —                | ●      |  |
|   |   |  |                      |              | —           | —            | —             | ●           | —               | —                | ●      |  |
|   |   |  |                      |              | —           | —            | —             | ●           | —               | ●                | ●      |  |

**Notes** The combination possibilities of circuit-breakers in an enclosure with accessory modules are identified by a ●  
<sup>1)</sup> Always required

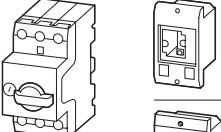
## PKZM4, PKZM01, PKZM0

| Enclosure   |                              | Accessories          |              |             |              |               |             |                 |                  |        |
|---|------------------------------|----------------------|--------------|-------------|--------------|---------------|-------------|-----------------|------------------|--------|
| Part no.  | Part no.                     | Degree of protection | Handle color | NHI...-PKZ0 | AGM2...-PKZ0 | NHI-E...-PKZ0 | VHI...-PKZ0 | VHI...-PKZ01    | U-PKZ0 or A-PKZ0 | L-PKZ0 |
| <b>Surface mounting enclosure</b>   |                              |                      |              |             |              |               |             |                 |                  |        |
| <b>Motor-protective circuit-breaker PKZM4</b>                                       |                              |                      |              |             |              |               |             |                 |                  |        |
|    | CI-K4-PKZ4-G                 | IP65                 | Black        | ●           | ●            | ●             | -           | -               | ●                | ●      |
|   | CI-K4-PKZ4-GR                | IP65                 | Red-yellow   | ●           | ●            | ●             | -           | -               | ●                | ●      |
| <b>Installation enclosure</b>   |                              |                      |              |             |              |               |             |                 |                  |        |
| <b>Motor-protective circuit-breaker PKZM01</b>                                      |                              |                      |              |             |              |               |             |                 |                  |        |
|   | E-PKZ01                      | IP40                 | -            | -           | -            | ●             | -           | -               | ●                | ●      |
|   |                              |                      |              | ●           | -            | ●             | -           | ●               | ●                | ●      |
|  | E-PKZ01-G                    | IP65                 | -            | -           | -            | ●             | -           | -               | ●                | ●      |
|   |                              |                      |              | ●           | -            | ●             | -           | ●               | ●                | ●      |
|  | E-PKZ01-PVT<br>E-PKZ01-PVS   | IP65                 | Red-yellow   | -           | -            | ●             | -           | -               | ●                | ●      |
|   |                              |                      |              | -           | -            | -             | -           | ●               | ●                | ●      |
|  | E-PKZ01-SVB<br>E-PKZ01-SVB-V | IP65                 | -            | -           | -            | ●             | -           | -               | ●                | ●      |
|   |                              |                      |              | -           | -            | -             | -           | ● <sup>1)</sup> | ●                | ●      |
| <b>Motor-protective circuit-breaker PKZM0</b>                                       |                              |                      |              |             |              |               |             |                 |                  |        |
|  | E-PKZ0                       | IP40                 | -            | ●           | -            | -             | -           | -               | -                | ●      |
|   |                              |                      |              | -           | -            | -             | -           | -               | ●                | ●      |
|  | E-PKZ0-G                     | IP55                 | Black        | ●           | -            | ●             | -           | -               | -                | ●      |
|   |                              |                      |              | -           | -            | ●             | -           | -               | ●                | ●      |
|  | E-PKZ1-GR                    | IP55                 | Red-yellow   | ●           | -            | ●             | -           | -               | -                | ●      |
|   |                              |                      |              | -           | -            | ●             | -           | -               | ●                | ●      |

**Notes**

The combination possibilities of circuit-breakers in an enclosure with accessory modules are identified by a ●  
<sup>1)</sup> Always required











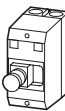
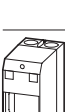

# 1.3



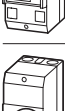
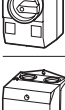

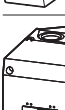























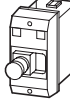

## Motor-protective circuit-breakers PKZM01, PKZM0, PKZM4, PKE Insulated enclosure

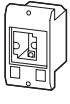
1

### PKZM01, PKZM0, PKZM4

|   | Degree of protection           | For use with  | Part no.<br>Article no.         | Price<br>See price list | Std. pack | Notes  |
|---|--------------------------------|---|---------------------------------|-------------------------|-----------|--|
| <b>Insulated enclosures for surface mounting</b>  |                                |   |                                 |                         |           |  |
| <b>For Motor-protective circuit-breaker PKZM01</b>  |                                |   |                                 |                         |           |  |
|           | IP40                           | PKZM01<br>+NHI-E or<br>VHI-PKZ01<br>+U or A or NHI<br>+L (2 off)                | <b>CI-PKZ01</b><br>281403       |                         | 1 off     | Integrated terminal for PE(N) connection, two M25 cable entry knockouts at top and at bottom.  |
|           | IP65                           |   | <b>CI-PKZ01-G</b><br>281404     |                         | 1 off     |  |
|           | IP65                           | PKZM01<br>+NHI-E or<br>+U or A<br>+L (2 off)                                    | <b>CI-PKZ01-SVB</b><br>281405   |                         | 1 off     |  |
|           | IP65                           |   | <b>CI-PKZ01-SVB-V</b><br>281944 |                         | 1 off     |  |
|          | IP65                           |   | <b>CI-PKZ01-PVT</b><br>281406   |                         | 1 off     |  |
|         | IP65                           |   | <b>CI-PKZ01-PVS</b><br>281407   |                         | 1 off     |  |
|         | As insert                      | PKZM01  | <b>CI-PKZ01-X</b><br>289934     |                         | 1 off     |  |
| <b>For Motor-protective circuit-breakers PKZM0</b>  |                                |   |                                 |                         |           |  |
|         | IP41<br>with vertical mounting | PKZM0-...<br>+NHI or AGM<br>+U or A<br>+NHI-E<br>+L-PKZ0 (2 off)                | <b>CI-K2-PKZ0</b><br>219653     |                         | 1 off     | M25 metric cable entry knockout, top and bottom<br>Cable push-through membrane top, bottom, in the back plate and as a control line entry.<br>Insulated enclosure CI-K2 incl. N and PE terminal. |
|         | IP65                           |   | <b>CI-K2-PKZ0-G</b><br>219654   |                         | 1 off     |  |
|         | IP65                           |   | <b>CI-K2-PKZ0-GR</b><br>219655  |                         | 1 off     |  |
|         | IP40                           | PKZM0-...<br>+NHI or U or A<br>+L-PKZ0 (2 off)                                  | <b>CI-PKZ0-M</b><br>267083      |                         | 1 off     | Integrated terminal for PE(N) connection, two M25 cable entry knockouts at top and at bottom.  |
|         | IP55                           | PKZM0-...<br>+NHI-E   | <b>CI-PKZ0-GM</b><br>260089     |                         | 1 off     |  |
|         | IP55                           | +NHI or U or A<br>+L-PKZ0 (2 off)   | <b>CI-PKZ0-GRM</b><br>260104    |                         | 1 off     |  |
| <b>For Motor-protective circuit-breakers PKZM0 with early-make VHI auxiliary contacts</b> |                                |   |                                 |                         |           |  |
|         | IP65                           | PKZM0-... and VHI<br>+NHI or AGM  | <b>CI-K2-PKZ0-GV</b><br>219657  |                         | 1 off     | M25 metric cable entry knockout, top and bottom<br>Cable push-through membrane top, bottom, in the back plate and as a control line entry.<br>Insulated enclosure CI-K2 incl. N and PE terminal. |
|         | IP65                           | +U or A<br>+L (2 off)   | <b>CI-K2-PKZ0-GRV</b><br>219656 |                         | 1 off     |  |
|         | IP55                           | PKZM0-... and VHI<br>+U or A (undervoltage or shunt release)<br>+L-PKZ0 (2 off) | <b>CI-PKZ0-GVM</b><br>263526    |                         | 1 off     | Integrated terminal for PE(N) connection, two M25 cable entry knockouts at top and at bottom.  |
|         | IP55                           |   | <b>CI-PKZ0-GRVM</b><br>263525   |                         | 1 off     |  |
| <b>For Motor-protective circuit-breakers PKZM4</b>  |                                |   |                                 |                         |           |  |
|         | IP65                           | PKZM4-...<br>+VHI or NHI-E  | <b>CI-K4-PKZ4-G</b><br>225524   |                         | 1 off     | Metric knockout:<br>Top and bottom: M25/M32<br>In the back plate: M25/M32<br>Control cable entry: M20<br>CI-K4 insulated enclosure including insulated PE terminal                               |
|         | IP65                           | +NHI and AGM<br>+U or A<br>+L-PKZ0 (2 off)                                      | <b>CI-K4-PKZ4-GR</b><br>225525  |                         | 1 off     |  |

## E-PKZ

















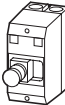

|   | Degree of protection   | For use with | Part no.<br>Article no.                                       | Price<br>See price list        | Std. pack  | Information relevant for export to North America  |   |
|---|--|--------------|---|--------------------------------|--|---|---|
|   |  |              |   |                                |  |   |   |
| <b>Insulated enclosures for flush mounting</b>                                      |  |              |   |                                |  |   |   |
| <b>For Motor-protective circuit-breaker PKZM01</b>                                  |  |              |   |                                |  |   |   |
| <b>Integrated terminal for PE(N) connection.</b>                                    |  |              |   |                                |  |   |   |
|    |  | Front IP40   | PKZM01<br>+NHI or U or A<br>+NHI-E or VHI<br>+L (2 off)       | <b>E-PKZ01</b><br>281633       | 1 off<br>      | Product Standards<br>UL File No.<br>UL CCN<br>CSA File No.<br>CSA Class No.<br>NA Certification   | UL 508; CSA-C22.2 No.14; IEC60947-4-1; CE marking<br>E36332<br>NLRV<br>12528<br>3211-05<br>UL Listed, CSA certified |
|    | With operating membrane  | Front IP65   |   | <b>E-PKZ01-G</b><br>281634     | 1 off<br>      |   |   |
|    | Lockable in Off position   | Front IP65   | PKZM01<br>+U or A<br>+NHI-E                                   | <b>E-PKZ01-SVB</b><br>281635   | 1 off<br>      |   |   |
|    | Lockable in Off position, in combination with VHI-PKZ01                            | Front IP65   | PKZM01<br>+U or A<br>+NHI-E or VHI                            | <b>E-PKZ01-SVB-V</b><br>281943 | 1 off<br>      |   |   |
|   | With emergency switching off mushroom button, maintained                           | Front IP65   |   | <b>E-PKZ01-PVT</b><br>281636   | 1 off<br>      |   |   |
|  | With emergency switching off mushroom button, with key-release                     | Front IP65   |   | <b>E-PKZ01-PVS</b><br>281637   | 1 off<br>  |   |   |
|  | For extension with inserts C/E-PKZ01-X... unit                                     | As insert    | PKZM01  | <b>E-PKZ01-X</b><br>289935     | 1 off  |   |   |
| <b>For Motor-protective circuit-breakers PKZM0</b>                                  |  |              |   |                                |  |   |   |
| <b>Integrated terminal for PE(N) connection.</b>                                    |  |              |   |                                |  |   |   |
|  | Cover with aperture dimensioned to accommodate front of breaker                    | Front IP40   | PKZM0-...<br>+NHI or U or A<br>+L-PKZ0<br>(2 parts)           | <b>E-PKZ0</b><br>072906        | 1 off<br>  | Product Standards<br>UL File No.<br>UL CCN<br>CSA File No.<br>CSA Class No.<br>NA Certification   | UL 508; CSA-C22.2 No.14; IEC60947-4-1; CE marking<br>E36332<br>NLRV<br>12528<br>3211-05<br>UL Listed, CSA certified |
|  | With black-grey rotary knob  | Front IP55   | PKZM0-...<br>+NHI or U or A<br>+NHI-E<br>+L-PKZ0<br>(2 parts) | <b>E-PKZ0-G</b><br>072907      | 1 off<br>  |   |   |
|  | With red-yellow rotary knob, for use as emergency switching off device to EN 60204 | Front IP55   |   | <b>E-PKZ0-GR</b><br>072908     | 1 off<br>  |   |   |

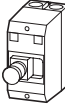
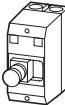
# 1.3











## Motor-protective circuit-breakers PKZM01, PKZM0, PKZM4, PKE Insulated enclosure

1

### CI-PKZ

|   | Degree of protection   | For use with  | Part no.<br>Article no.            | Price<br><br>See price list | Std. pack  | Information relevant for export to<br>North America<br>   |
|---|--|---|------------------------------------|-----------------------------|--|--|
| <b>Insulated enclosures for surface mounting</b>  |  |   |                                    |                             |  |  |
| <b>For Motor-protective circuit-breaker PKZM01s<br/>Integrated terminal for PE(N) connection.</b> |  |   |                                    |                             |  |  |
|                   | IP41   | PKZM01<br>+NHI-E or<br>VHI-PKZ01<br>+U or A or<br>NHI<br>+L (2 off) | <b>CI-PKZ01-NA</b><br>281408       |                             | 1 off<br>   | Product Standards<br>UL 508; CSA-C22.2<br>No.14; IEC60947-<br>4-1; CE marking<br>UL File No.<br>UL CCN<br>CSA File No.<br>CSA Class No.<br>NA Certification<br>E36332<br>NLRV<br>12528<br>3211-05<br>UL Listed, CSA<br>certified |
|                   | With operating<br>membrane<br>IP65   | PKZM01<br>+NHI-E or<br>VHI-PKZ01<br>+U or A or<br>NHI<br>+L (2 off) | <b>CI-PKZ01-NA-G</b><br>281409     |                             | 1 off<br>   | Specially designed for NA ✓<br>Degree of Protection<br>IEC: IP41, UL/CSA<br>Type: -  |
|                   | Lockable in Off<br>position<br>IP65  | PKZM01<br>+NHI-E or<br>VHI-PKZ01<br>+U or A<br>+L (2 off)           | <b>CI-PKZ01-NA-SVB</b><br>281630   |                             | 1 off<br>   |  |
|                  | Lockable in Off<br>position, in<br>combination with<br>VHI-PKZ01<br>IP65                               | PKZM01<br>+NHI-E<br>+U or A<br>+L (2 off)                           | <b>CI-PKZ01-NA-SVB-V</b><br>281945 |                             | 1 off<br>   |  |
|                 | With emergency<br>switching off<br>mushroom button,<br>maintained<br>IP65                              |   | <b>CI-PKZ01-NA-PVT</b><br>281631   |                             | 1 off<br> |  |
|                 | With emergency<br>switching off<br>mushroom button,<br>with key-release<br>IP65                        |   | <b>CI-PKZ01-NA-PVS</b><br>281632   |                             | 1 off<br> |  |
| <b>For Motor-protective circuit-breakers PKZM0</b>  |  |   |                                    |                             |  |  |
| <b>Integrated N and PE terminals; lower section without knockouts</b>                             |  |   |                                    |                             |  |  |
|                 | With black-grey<br>rotary knob<br>IP55   | PKZM0-...<br>+NHI or U or<br>A<br>+NHI-E<br>+L-PKZ0<br>(2 parts)    | <b>CI-K2-PKZ0-NA-G</b><br>262680   |                             | 1 off<br> |  |
|                 | With red-yellow<br>rotary knob, for use<br>as emergency<br>switching off device<br>to EN 60204<br>IP55 |   | <b>CI-K2-PKZ0-NA-GR</b><br>262681  |                             | 1 off<br> |  |
| <b>For Motor-protective circuit-breakers PKZM0 with early-make auxiliary contacts</b>             |  |   |                                    |                             |  |  |
| <b>Integrated N and PE terminals; lower section without knockouts</b>                             |  |   |                                    |                             |  |  |
|                 | With black-grey<br>rotary knob<br>IP55   | PKZM0-...<br>+VHI... +<br>U...<br>+L-PKZ0<br>(2 parts)              | <b>CI-K2-PKZ0-NA-GV</b><br>262682  |                             | 1 off<br> |  |
|                 | With red-yellow<br>rotary knob, for use<br>as emergency<br>switching off device<br>to EN 60204<br>IP55 |   | <b>CI-K2-PKZ0-NA-GRV</b><br>262683 |                             | 1 off<br> |  |

## SVB-PKZ, CL/EPKZ01

|   | Degree of protection   | For use with | Part no.<br>Article no.                                       | Price<br>See price list            | Std. pack   | Information relevant for export to<br>North America<br>   |
|---|--|--------------|---|------------------------------------|---|--|
| <b>Insulated enclosures, accessories</b>  |  |              |   |                                    |   |  |
| <b>Padlocking feature</b>   |  |              |   |                                    |   |  |
| <b>For up to 3 padlocks with 3 – 6 mm hasp thickness, for use as main switch to IEC/EN60204</b> |  |              |   |                                    |   |  |
|                | Lockable in the 0-position of the PKZM0 or Motor-protective circuit-breaker PKZM4. | –            | CI-K2-PKZ0-G(R)(V)<br>CI-PKZ0-G(R)(V)M                        | <b>SVB-PKZ0-CI</b><br>035129       | 3 off<br>  | Product Standards<br>UL 508; CSA-C22.2 No.14; IEC60947-4-1; CE marking   |
|   | –  | –            | E-PKZ0-G(R)   | <b>SVB-PKZ0-E</b><br>035127        | 3 off<br>  | UL File No.<br>UL CCN<br>CSA File No.<br>CSA Class No.<br>NA Certification<br>E36332<br>NLRV<br>12528<br>3211-05<br>UL Listed, CSA certified |
|   | –  | –            | CI-K4-PKZ4-G(R)   | <b>SVB-PKZ4-CI</b><br>225526       | 1 off   |  |
| <b>Neutral terminal</b>   |  |              |   |                                    |   |  |
| <b>For connection of a 5th conductor</b>  |  |              |   |                                    |   |  |
|                | Flexible, 1 - 4 mm <sup>2</sup>  | –            | CI-K2-PKZ0-...  | <b>K-CI-K1/2</b><br>207451         | 20 off<br> | UL/CSA certification not required  |
|   | 63 A, flexible, 6 - 16 mm <sup>2</sup>   | –            | CI-K4-PKZ4-G(R)   | <b>K25/1</b><br>096200             | 10 off  |  |
|               | –  | –            | E-PKZ0(-G)(-GR)<br>E-PKZ01(-G)                                | <b>N-PKZ0</b><br>082160            | 20 off  |  |
| <b>Units for insulated enclosures for PKZ01</b>   |  |              |   |                                    |   |  |
| <b>Combinable with CI-PKZ01-X and E-PKZ01-X.</b>  |  |              |   |                                    |   |  |
|              | With operating membrane  | Front IP65   | PKZM01<br>+NHI-E or VHI-PKZ01<br>+U or A or NHI<br>+L (2 off) | <b>CI/E-PKZ01-XG</b><br>289936     | 1 off   |  |
|              | Lockable in Off position   | Front IP65   | PKZM01<br>+NHI-E<br>+U or A<br>+L (2 off)                     | <b>CI/E-PKZ01-XSVB</b><br>289939   | 1 off   |  |
|              | With emergency switching off mushroom button, maintained                           | Front IP65   | PKZM01<br>+NHI-E or VHI-PKZ01<br>+U or A<br>+L (2 off)        | <b>CI/E-PKZ01-XPVT</b><br>289937   | 1 off   |  |
|   | With emergency switching off mushroom button, with key-release                     | Front IP65   | PKZM01<br>+NHI-E or VHI-PKZ01<br>+U or A<br>+L (2 off)        | <b>CI/E-PKZ01-XPVS</b><br>289938   | 1 off   |  |
|              | Lockable in Off position, in combination with VHI-PKZ01                            | Front IP65   | PKZM01<br>VHI-PKZ01<br>+U or A<br>+L (2 off)                  | <b>CI/E-PKZ01-XSVB-V</b><br>289980 | 1 off   |  |

# 1.3

## Motor-protective circuit-breakers PKZM01, PKZM0, PKZM4, PKE Accessories

1

### Accessories

**Metric cable glands to EN 50262**

- With lock nut and built-in strain relief
- IP68 up to 5 bar, halogen free

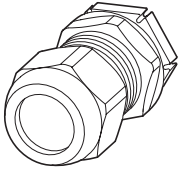

**Metric diaphragm grommets**



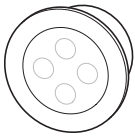

















- IP66
- With integral push-through diaphragm



| Cable entry | Drilling dimensions<br>mm | External cable diameter<br>mm | Part no.<br>Article no. | Price<br>See price list | Std. pack |
|-------------|---------------------------|-------------------------------|-------------------------|-------------------------|-----------|
| M20         | 20.5                      | 6 - 13                        | <b>V-M20</b><br>206910  |                         | 20 off    |
| M25         | 25.5                      | 9 - 17                        | <b>V-M25</b><br>206911  |                         | 20 off    |
| M32         | 32.5                      | 13 - 21                       | <b>V-M32</b><br>206912  |                         | 10 off    |
| M32         | 32.5                      | 18 - 25                       | <b>V-M32G</b><br>226156 |                         | 10 off    |
| M20         | 20.5                      | 1 - 13                        | <b>KT-M20</b><br>207602 |                         | 100 off   |
| M25         | 25.5                      | 1 - 18                        | <b>KT-M25</b><br>207603 |                         | 100 off   |
| M32         | 32.5                      | 1 - 25                        | <b>KT-M32</b><br>207604 |                         | 100 off   |

**Door coupling handles**  
Degree of protection IP65, UL/CS Type 4X / Type12



|  | For use with | Part no.<br>Article no. | Price<br>See price list                    | Std. pack  | Notes  |
|--|--------------|-------------------------|--|--|--|
| For use as main switch to IEC/EN 60204   | Black        | PKZM0<br>PKZM4          | <b>PKZ0-XH<sup>1)</sup></b><br>106132      | 1 off<br>  | Pluggable PKZ0-XAH extension shaft, can be cut to any required length for installation depths of 100...240 mm. Follower included in delivery. With ON/OFF switch position and "+" (tripped), lockable. With 3 padlocks, 4 – 8 mm hasp. Cannot be used in combination with VH20-PKZ0. |
| For use as a main switch with emergency switching off function to EN 60204   | Red-yellow   | PKZM0<br>PKZM4          | <b>PKZ0-XRH<sup>1)</sup></b><br>106133     | 1 off<br>  |  |
| For use as a main switch to EN 60204 in MCC power distribution systems and with PKZM0 installed rotated by 90°                                       | Black        | PKZM0<br>PKZM4          | <b>PKZ0-XH-MCC<sup>1)</sup></b><br>106136  | 1 off<br>  |  |
| For use as a main switch with emergency switching off function to EN 60204 in MCC power distribution systems and with PKZM0 installed rotated by 90° | Red-yellow   | PKZM0<br>PKZM4          | <b>PKZ0-XRH-MCC<sup>1)</sup></b><br>106137 | 1 off<br>  |  |
| For use as main switch to IEC/EN 60204   | Black        | PKE                     | <b>PKE-XH<sup>1)</sup></b><br>142416       | 1 off<br>  |  |
| For use as a main switch with emergency switching off function to EN 60204   | Red-yellow   | PKE                     | <b>PKE-XRH<sup>1)</sup></b><br>142417      | 1 off<br>  |  |
| For use as a main switch to EN 60204 in MCC power distribution systems and with PKE installed rotated by 90°   | Black        | PKE                     | <b>PKE-XH-MCC<sup>1)</sup></b><br>142418   | 1 off<br>  |  |
| For use as a main switch with emergency-switching off function to EN 60204 in MCC power distribution systems and with PKE installed rotated by 90°   | Red-yellow   | PKE                     | <b>PKE-XRH-MCC<sup>1)</sup></b><br>142419  | 1 off<br>  |  |
| For increasing the degree of protection of the PKZM4 to IP2X   | –            | PKZM4                   | <b>HB-PKZ4<sup>2)</sup></b><br>256581      | 1 off<br>  |  |
| –  | –            | PKZM0<br>PKZM4          | <b>PKZ0-XAH<sup>1)</sup></b><br>106134     | 1 off<br>  |  |

**Information relevant for export to North America**  

|                                 |   |
|---------------------------------|---|
| <sup>1)</sup> Product Standards | UL 508; CSA-C22.2 No.14; IEC60947-4-1; CE marking |
| UL File No.                     | E36332  |
| UL CCN                          | NLRV  |
| CSA File No.                    | 12528   |
| CSA Class No.                   | 3211-05   |
| NA Certification                | UL Listed, CSA certified                          |
| Degree of Protection            | IEC: IP65, UL/CSA Type: 4X, 12                    |

|                                 |   |
|---------------------------------|---|
| <sup>2)</sup> Product Standards | UL 508; CSA-C22.2 No.14; IEC60947-4-1; CE marking |
| UL File No.                     | E36332  |
| UL CCN                          | NLRV  |
| CSA File No.                    | 12528   |
| CSA Class No.                   | 3211-05   |
| NA Certification                | UL Listed, CSA certified                          |

## Accessories

### Telescopic adapters With 45 mm top-hat rail to IEC/EN 60715 for compensation of the mounting depth of rear-mounted devices enclosures CI-K and cabinets

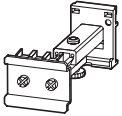

| Notes  | Part no.<br>Article no. | Price<br>See price list | Std. pack | Information relevant for export to<br>North America<br>   |
|--|-------------------------|-------------------------|-----------|---|
| Telescopic clip<br><br>Stepless adjustment via scale from 75 – 115 mm. | <b>M22-TA</b><br>226161 |                         | 1 off<br> | Product Standards IEC/EN60947-5; UL 508; CSA-C22.2 No.14-05; CSA-C22.2 No.94-91; CE marking E29184<br>UL File No. UL CCN<br>CSA File No. 012528<br>CSA Class No. 3211-03<br>NA Certification UL Listed, CSA certified |

### Lockable rotary handle



|   |                                    |                          |           |  |
|---|------------------------------------|--------------------------|-----------|--|
| For locking motor-protective circuit-breakers PKZM0, PKZM4 and PKE as a main switch in compliance with EN 60204. Can be padlocked in the "0" position.<br>Hasp thickness: 3 – 6.35 mm | Can not be combined with VHI-PKZ0. | <b>AK-PKZ0</b><br>030851 | 5 off<br> | Product Standards UL 508; CSA-C22.2 No.14; IEC/EN 60947-4-1; CE marking E36332<br>UL File No. NLRV<br>UL CCN<br>CSA File No. 12528<br>CSA Class No. 3211-05<br>NA Certification UL Listed, CSA certified |
|---|------------------------------------|--------------------------|-----------|--|

### Holding facility

|   |   |                          |       |  |
|---|---|--------------------------|-------|--|
| To prevent tampering with the overload release and the test function, it can be sealed using industry standard sealing wire<br>For use with motor-protective circuit-breakers PKZM0 and PKZM4 | – | <b>PL-PKZ0</b><br>203599 | 5 off |  |
|---|---|--------------------------|-------|--|

### Mounting angle bracket



|                                    |   |                            |            |  |
|------------------------------------|---|----------------------------|------------|--|
| For screw fixing to mounting plate | – | <b>PKE32-XMB</b><br>134837 | 20 off<br> | Product Standards UL 508; CSA-C22.2 No.14; IEC/EN 60947-4-1; CE marking<br>NA Certification Request filed for UL and CSA |
|------------------------------------|---|----------------------------|------------|--|

### Documentation

|   |                |                                    |       |  |
|---|----------------|------------------------------------|-------|--|
| Motor-protective circuit-breakers PKZM0, overload monitoring of EEx e motors  | German/English | <b>AWB1210-1458D/GB</b><br>266164  | 1 off |  |
| Motor-protective circuit-breakers PKZM4, overload monitoring of EEx e motors  | German/English | <b>AWB1210-1457D/GB</b><br>266165  | 1 off |  |
| Motor-protective circuit-breakers PKE, EEx electric motor overload monitoring | German/English | <b>AWB1210-1631DE/EN</b><br>134836 | 1 off |  |

### Indicator lights with glow lamp



| For use with Color Voltage                        | Color | Voltage<br>$U_s$<br>V | Part no.<br>Article no.          | Price<br>See price list | Std. pack |
|---|-------|-----------------------|----------------------------------|-------------------------|-----------|
| CI-K2-PKZ0-..., CI-K4-PKZ4, CI-PKZ0(1), E-PKZ0(1) | White | 110 - 230             | <b>L-PKZ0(230V)</b><br>082151    |                         | 10 off    |
| CI-K2-PKZ0-..., CI-K4-PKZ4, CI-PKZ0(1), E-PKZ0(1) | White | 230 - 400             | <b>L-PKZ0(400V)</b><br>082152    |                         | 10 off    |
| CI-K2-PKZ0-..., CI-K4-PKZ4, CI-PKZ0(1), E-PKZ0(1) | White | 415 - 500             | <b>L-PKZ0(500V)</b><br>082153    |                         | 5 off     |
| CI-K2-PKZ0-..., CI-K4-PKZ4, CI-PKZ0(1), E-PKZ0(1) | Green | 110 - 230             | <b>L-PKZ0-GN(230V)</b><br>082154 |                         | 10 off    |
| CI-K2-PKZ0-..., CI-K4-PKZ4, CI-PKZ0(1), E-PKZ0(1) | Green | 230 - 400             | <b>L-PKZ0-GN(400V)</b><br>082155 |                         | 10 off    |
| CI-K2-PKZ0-..., CI-K4-PKZ4, CI-PKZ0(1), E-PKZ0(1) | Green | 415 - 500             | <b>L-PKZ0-GN(500V)</b><br>082156 |                         | 5 off     |
| CI-K2-PKZ0-..., CI-K4-PKZ4, CI-PKZ0(1), E-PKZ0(1) | Red   | 110 - 230             | <b>L-PKZ0-RT(230V)</b><br>082157 |                         | 10 off    |
| CI-K2-PKZ0-..., CI-K4-PKZ4, CI-PKZ0(1), E-PKZ0(1) | Red   | 230 - 400             | <b>L-PKZ0-RT(400V)</b><br>082158 |                         | 10 off    |

# 1.3









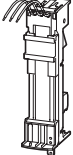

## Motor-protective circuit-breakers PKZM01, PKZM0, PKZM4, PKE Busbar adapters

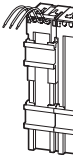
1

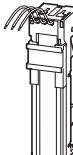
### Busbar adapters for PKZ and PKE

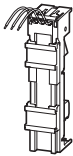
Approved to UL508.

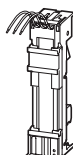
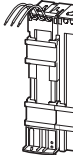
For fitting to flat copper busbars with 60mm between busbar centers, suitable for 5 mm and 10 mm busbar thickness.

| Rated operational voltage<br>$U_e$<br>V   | Conductor cross-section  | Adapter width<br>mm  | Mounting rails<br>Number  | For use with   | Part no.<br>Article no.  | Price<br>See price list   | Std. pack  | Notes  |  |  |   |  |
|---|--|--|---|--|--|---|--|--|--|--|---|--|
| <b>Rated operational current 16 A</b><br><b>For starters with spring-loaded terminals</b><br> | 690  | AWG 14<br>(2.5 mm <sup>2</sup> )   | 45  | 2  | PKZM0-C + DILMC7<br>PKZM0-C + DILMC9<br>PKZM0-C + DILMC12  | <b>BBA0C-16</b><br>101455   | 4 off<br>  | According to UL 508: $I_e = 12$ A  |  |  |   |  |
|   | <b>Rated operational current 25 A</b><br><b>For reversing starters</b><br> | 690  | AWG 12<br>(4 mm <sup>2</sup> )  | 90   | 1  | PKZM0, PKE + 2 x DILM7-01<br>PKZM0, PKE + 2 x DILM9-01<br>PKZM0, PKE + 2 x DILM12-01<br>MSC-R-0,25-M7... -<br>MSC-R-12-M12... | <b>BBA0R-25</b><br>101453  | 2 off<br>  | In combination with individual components PKZM0 and DILM, use reversing starter kit PKZM0-XRM12. Fully assembled and tested combination with MSC-R → Chapter 1.4 (Page 18)<br>Only busbar adapters/wiring sets manufactured on or after CW35/2009 can be used for PKE. |  |   |  |
|   |  | <b>Can be used universally</b><br> | 690   | AWG 12<br>(4 mm <sup>2</sup> )   | 45   | 2   | —  | <b>BBA0-25/2TS</b><br>101481   | 4 off<br>    | Mounting rails can be moved within 1.25 mm grid.   |   |  |
|   |  |  | <b>For DOL starters</b><br> | 690  | AWG 12<br>(4 mm <sup>2</sup> )   | 45  | 1  | PKZM0, PKE + 2 x DILM17-01<br>PKZM0, PKE + 2 x DILM25-01<br>PKZM0, PKE + 2 x DILM25-01<br>PKZM0, PKE + 2 x DILM32-01<br>MSC-R-16-M17...<br>MSC-R-32-M32...                       | <b>BBA0-25</b><br>101451   | 4 off<br>  | In combination with individual components PKZM0 and DILM, use DOL starter kit PKZM0-XRM12. Fully assembled and tested combination with MSC-D → Chapter 1.4 (Page 2)<br>Only busbar adapters/wiring sets manufactured on or after CW35/2009 can be used for PKE. |  |
|   |  |  |   | <b>For soft starters</b><br> | 690  | AWG 12<br>(4 mm <sup>2</sup> )  | 45   | 1  | PKZM0, PKE + DS7...004N...<br>PKZM0, PKE + DS7...007N...<br>PKZM0, PKE + DS7...009N...<br>PKZM0, PKE + DS7...012N...   | <b>BBA0L-25</b><br>142526  | 1 off   | —  |
|   |  |  |   |  | <b>Rated operational current 32 A</b><br><b>For reversing starters</b><br> | 690   | AWG 10<br>(6 mm <sup>2</sup> )   | 90   | 3  | PKZM0, PKE + 2 x DILM17-01<br>PKZM0, PKE + 2 x DILM25-01<br>PKZM0, PKE + 2 x DILM32-01<br>MSC-R-16-M17... -<br>MSC-R-32-M32...   | <b>BBA0R-32</b><br>101454   | 2 off<br>  |

#### Information relevant for export to North America



#### Product Standards

UL 508A; CSA-C22.2 No. 14;  
IEC60439-1; CE marking  
UL File No. E300273  
UL CCN

#### UL 508A; CSA-C22.2 No. 14;









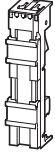

IEC60439-1; CE marking  
UL File No. E300273  
NMTR, NMTRZ

#### CSA File No.

232140  
CSA Class No. 3211-37  
NA Certification  
Max. Voltage Rating

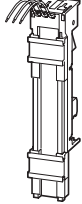
#### 232140

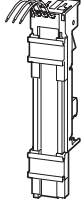
3211-37  
UL Listed, CSA certified  
600 V AC

|  | Rated operational voltage<br>$U_e$<br>V | Conductor cross-section        | Adapter width<br>mm | Mounting rails<br>Number | For use with  | Part no.<br>Article no.                     | Price<br>See price list | Std. pack  | Notes   |
|--|---|--------------------------------|---------------------|--------------------------|---|---|-------------------------|--|---|
| <b>Rated operational current 32 A</b><br><b>Can be used universally.</b><br>  | 690                                     | –                              | 45                  | 2                        | PKZM0..., PKE + DILM...   | <b>BBA0-32/2TS-C<sup>2)</sup></b><br>116708 |                         | 4 off<br>   | Universal adapter 1-, 2- and 3-phase applications. Mounting rail can be moved within 1.25 mm grid. For conductor cross-sections, round conductors of up to 6 mm <sup>2</sup> . Only busbaradapters/wiring sets manufactured on or after CW 35/2009 can be used for PKE. |
| <b>For DOL starters.</b><br>  | 690                                     | AWG 10<br>(6 mm <sup>2</sup> ) | 45                  | 2                        | PKZM0, PKE + DILM17<br>PKZM0, PKE + DILM25<br>PKZM0, PKE + DILM32<br>MSC-D-16-M17... -<br>MSC-D-32-M32... | <b>BBA0-32<sup>1)</sup></b><br>101452       |                         | 4 off<br>   | In combination with individual components PKZM0 and DILM wiring kit PKZM0-XM32DE can be used. Fully assembled and tested combination with MSC-D → Chapter 1.4 (Page 2) Only busbar adapters/wiring sets manufactured on or after CW35/2009 can be used for PKE.         |
| <b>For soft starters</b><br>   | 690                                     | AWG 10<br>(6 mm <sup>2</sup> ) | 45                  | 2                        | PKZM0, PKE + DS7...016N...<br>PKZM0, PKE + DS7...024N...<br>PKZM0, PKE + DS7...032N...                    | <b>BBA0L-32</b><br>142527                   |                         | 1 off  | –   |
| <b>For 160 mm adapter system with motor-protective circuit-breakers</b><br> | 690                                     | AWG 10<br>(6 mm <sup>2</sup> ) | 45                  | 1                        | PKZM0, PKE  | <b>BBA0K-32</b><br>142528                   |                         | 1 off  | –   |
| <b>Rated operational current 63 A</b><br><b>For DOL starters.</b><br>       | 690                                     | AWG 8<br>(10 mm <sup>2</sup> ) | 55                  | 2                        | PKZM4 + DILM17<br>PKZM4 + DILM25<br>PKZM4 + DILM32<br>PKZM4 + DILM40<br>PKZM4 + DILM50<br>PKZM4 + DILM65  | <b>BBA4-63<sup>1)</sup></b><br>101459       |                         | 4 off<br> | The following can be used to establish an electrical connection:<br>For PKZM4 + DILM17 to DILM32: MVS-LB0-0M-G<br>For PKZM4 + DILM40 to DILM65: PKZM4-XM65DE.   |
| <b>For motor-protective circuit-breakers</b><br>                            | 690                                     | AWG 8<br>(10 mm <sup>2</sup> ) | 54                  | 1                        | PKZM4   | <b>BBA4-63<sup>1)</sup></b><br>101457       |                         | 4 off<br> | –   |

**Information relevant for export to North America**



1)  
 Product Standards UL 508; CSA-C22.2 No.14; IEC60439-1; CE marking  
 UL File No. E300273  
 UL CCN NMTR, NMTR7  
 CSA File No. 232140  
 CSA Class No. 3211-37  
 NA Certification UL Listed, CSA certified  
 Max. Voltage Rating 600 V AC

2)  
 Product Standards UL 508; CSA-C22.2 No.14; IEC60439-1; CE marking  
 UL File No. E300273  
 UL CCN NMTR, NMTR7  
 NA Certification UL Listed, CSA certified  
 Max. Voltage Rating 600 V AC













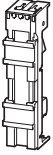





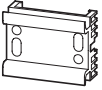

# 1.3

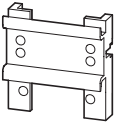
## Motor-protective circuit-breakers PKZM01, PKZM0, PKZM4, PKE

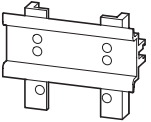
### Busbar adapters

1

#### BBA, PKZM0-XM

|  | Rated operational voltage<br>$U_e$<br>V | Conductor cross-section | Adapter width<br>mm | Mounting rails<br>Number | For use with | Part no.<br>Article no.                      | Price<br>See price list | Std. pack   | Notes   |
|--|---|-------------------------|---------------------|--------------------------|--------------|--|-------------------------|---|---|
| <b>Without electrical contacts<br/>Empty module.</b><br>               | –                                       | –                       | 45                  | 2                        | –            | <b>BBA0/ZTS-L<sup>1)</sup></b><br>101482     |                         | 4 off<br>       | Mounting rails can be moved within a 1.25 mm grid.<br>Can be used to mount reversing and star-delta starters. |
|  | –                                       | –                       | 54                  | 2                        | –            | <b>BBA4/ZTS-L<sup>1)</sup></b><br>101483     |                         | 4 off<br>       | Mounting rails can be moved within a 1.25 mm grid.<br>Can be used to mount reversing and star-delta starters. |
| <b>Side-mounted module,<br/>can be attached on<br/>both sides.</b><br> | –                                       | –                       | 9                   | –                        | –            | <b>BBA-XSM<sup>1)</sup></b><br>101484        |                         | 10 off<br>      | Can be grouped with busbar adapters in order to extend the mounting width.                                    |
| <b>Busbar adapters<br/>accessories<br/>Mounting rails</b><br>         | –                                       | –                       | 45                  | –                        | BBA...       | <b>PKZM0-XMR<sup>2)</sup></b><br>239364      |                         | 10 off<br>      | –   |
| <b>Busbar adapters<br/>accessories<br/>Mounting rails</b><br>        | –                                       | –                       | 54                  | –                        | BBA...       | <b>PKZM0-XMR54<sup>2)</sup></b><br>113911    |                         | 10 off<br>  | –   |
| <b>Busbar adapters<br/>accessories<br/>Mounting rails</b><br>        | –                                       | –                       | 72                  | –                        | BBA...       | <b>PKZM0-XMR72<sup>2)</sup></b><br>113912    |                         | 10 off<br>  | –   |
| <b>Connecting cable</b><br>–   | –                                       | –                       | –                   | –                        | BBA...       | <b>BBA-XLT-6-130<sup>3)</sup></b><br>116902  |                         | 30 off<br>  | –   |
|  | –                                       | –                       | –                   | –                        | BBA...       | <b>BBA-XLT-16-142<sup>3)</sup></b><br>116903 |                         | 30 off<br>  | –   |

#### Information relevant for export to North America



1)

|                     |  |
|---------------------|--|
| Product Standards   | UL 508A; CSA-C22.2 No.14; IEC60439-1; CE marking |
| UL File No.         | E300273  |
| UL CCN              | NMTR, NMTR7                                      |
| CSA File No.        | 232140   |
| CSA Class No.       | 3211-37  |
| NA Certification    | UL Listed, CSA certified                         |
| Max. Voltage Rating | 600 V AC   |

2)

|                   |  |
|-------------------|--|
| Product Standards | UL 508A; CSA-C22.2 No.14; IEC60947-4-1; CE marking |
| UL File No.       | E300273  |
| UL CCN            | NMTR, NMTR7  |
| CSA File No.      | 232140   |
| CSA Class No.     | 3211-37  |
| NA Certification  | UL Listed, CSA certified                           |

3)

|                   |  |
|-------------------|--|
| Product Standards | UL 508A; CSA-C22.2 No.14; IEC60439-1; CE marking |
| UL File No.       | On request                                       |
| UL CCN            | On request                                       |
| CSA File No.      | On request                                       |
| CSA Class No.     | On request                                       |
| NA Certification  | UL Recognized, CSA certified                     |

### Wiring set

For use with

**Part no.**  
Article no.

**Price**  
See price list

Std. pack

**Notes**

1

#### DOL starter

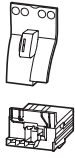

PKZM0, PKE + DILM7  
PKZM0, PKE + DILM9  
PKZM0, PKE + DILM12  
PKZM0, PKE + DILM15  
DS7-34...SX004...  
DS7-34...SX007...  
DS7-34...SX009...  
DS7-34...SX012...

**PKZM0-XDM12**  
283149

1 off

Consists of:

- Mechanical connection element for PKZM0 and contactor
- Main supply wiring between PKZM0 and contactor with tool-less plug connection
- Cable routing

As auxiliary contact, use DILA-XHIT... → Chapter 1.1 (Page 38)  
Cannot be combined with NHI-E...PKZ0-C.  
 $U_e \leq 415 \text{ V}^1)$

#### DOL starter

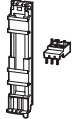

PKZM0, PKE + DILM17  
PKZM0, PKE + DILM25  
PKZM0, PKE + DILM32

**PKZM0-XDM32**  
283153

1 off

Consists of:

- Top-hat rail adapter plates
- Power supply wiring between PKZ and contactor<sup>1)</sup>

PKZM4 + DILM40  
PKZM4 + DILM50  
PKZM4 + DILM65

**PKZM4-XDM65**  
101053

1 off

#### Reversing starters

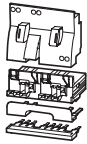

PKZM0, PKE + DILM7-01  
PKZM0, PKE + DILM9-01  
PKZM0, PKE + DILM12-01

**PKZM0-XRM12**  
283185

1 off

Consists of:

- Mechanical connection element for PKZM0 and contactor
- Reversing starters main supply wiring with tool-less plug connection
- Control cables for electrical interlocking in tool-less plug connection:
  - K1M: A1 -K2M: 21
  - K1M: 21 -K2M: A1
  - K1M: A2 -K2M: A2
- Cable routing

As auxiliary contact DILA-XHIT...use → Chapter 1.1 (Page 38)  
Can not be combined with AGM PKZ0.  
 $U_e \leq 415 \text{ V}^1)$

#### Reversing starters

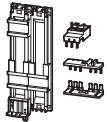

PKZM0, PKE + DILM17  
PKZM0, PKE + DILM25  
PKZM0, PKE + DILM32

**PKZM0-XRM32**  
283189

1 off

Consists of:

- Top-hat rail adapter plates
- Reversing starters supply wiring<sup>1)</sup>

#### Wiring kit



PKZM0, PKE + DILM17  
PKZM0, PKE + DILM25  
PKZM0, PKE + DILM32  
DS7-34...SX016...  
DS7-34...SX024...  
DS7-34...SX032...

**PKZM0-XM32DE**  
239349

5 off

• Main supply wiring between PKZM0 and contactor  
• Use only in combination with busbar adapter or mounting rail adapter plate

PKZM4 + DILM40  
PKZM4 + DILM50  
PKZM4 + DILM65

**PKZM4-XM65DE**  
101056

5 off

• Main current supply between PKZM4 and contactor

#### Top-hat rail adapter plates



PKZM0-XDM12  
PKZM0-XRM12

**PKZM0-XC45**  
283132

4 off

Consists of:

- 45 mm wide adapter plate
- Connection element for side-by-side positioning of further plates<sup>1)</sup>

#### Top-hat rail adapter plates

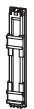

PKZM4 + DILM40  
PKZM4 + DILM50  
PKZM4 + DILM65

**PKZM4-XC55/2**  
101054

4 off

Consists of:

- 55 mm wide adapter plate
- Connection cam for additional plates<sup>1)</sup>
- For use with reversing and start-delta starters

#### Soft starters



PKZM0, PKE + DS7...004N...  
PKZM0, PKE + DS7...007N...  
PKZM0, PKE + DS7...009N...  
PKZM0, PKE + DS7...012N...

**PKZM0-XC45L**  
142529

1 off

Consists of:

- 45 mm wide adapter plate

#### Soft starters

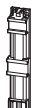

PKZM0, PKE + DS7...016N...  
PKZM0, PKE + DS7...024N...  
PKZM0, PKE + DS7...032N...

**PKZM0-XC45L/2**  
142570

1 off

Consists of:

- 45 mm wide adapter plate

#### Notes

<sup>1)</sup> Use only busbar adapters/wiring sets manufactured on or after CW35/2009 for PKE.

#### Information relevant for export to North America

<sup>2)</sup>  
Product Standards UL 508; CSA-C22.2 No.14; IEC60947-4-1;  
CE marking  
UL File No. E36332  
UL CCN NLRV  
CSA File No. 12528  
CSA Class No. 3211-05  
NA Certification UL Listed, CSA certified

<sup>3)</sup>  
UL/CSA certification not required

<sup>4)</sup>  
Product Standards UL 508; CSA-C22.2 No.14;  
IEC60947-4-1; CE marking  
UL File No. E300273  
UL CCN NMTR, NMTR7  
NA Certification UL Listed, CSA certified  
Max. Voltage Rating 600 V AC

# 1.3

## Motor-protective circuit-breakers PKZM01, PKZM0, PKZM4, PKE

Motor feeder plugs, three-phase commoning links

1

| Description   | For use with  | Part no.<br>Article no. | Price<br>See price list  | Std. pack                             | Notes   | Information relevant for export to<br>North America<br> |
|---|---|-------------------------|--|---------------------------------------|---|---|
|   | <b>PE module with contact plate</b>                           |                         |  |                                       |   |   |
| DILM(C)7<br>DILM(C)9<br>DILM(C)12<br>DILM(C)15  | <b>DILM12-XMCE</b><br>121764                                  | 5 off<br>               | 35 x 7.5 (15) mm mounting rail (as per DIN EN 60715) with PE function required. For connection of: PE 0.75 – 4 mm <sup>2</sup>               | Product Standards<br>NA Certification | UL 508; CSA-C22.2 No. 14; IEC60947-4-1; CE marking<br>Request filed for UL and CSA        |   |
|   | <b>Motor feeder plug with PE module and contact plate</b>     |                         |  |                                       |   |   |
| DILM(C)7<br>DILM(C)9<br>DILM(C)12<br>DILM(C)15  | <b>DILM12-XMCP/E</b><br>121769                                | 1 off<br>               | 35 x 7.5 (15) mm mounting rail (as per DIN EN 60715) with PE function required. For connection of: L1, L2, L3, PE 0.75 – 2.5 mm <sup>2</sup> | Product Standards<br>NA Certification | IEC/EN 60947-4-1; UL 508; CSA-C22.2 No. 14-05; CE marking<br>Request filed for UL and CSA |   |
|   | <b>Motor feeder plug with PE module without contact plate</b> |                         |  |                                       |   |   |
| PKZM0/PKE + DILM(C)7<br>PKZM0/PKE + DILM(C)9<br>PKZM0/PKE + DILM(C)12<br>PKZM0/PKE + DILM(C)15<br>MSC-D(E)-...-M7...<br>MSC-D(E)-...-M9...<br>MSC-D(E)-...-M15... | <b>DILM12-XMCP/T</b><br>121770                                | 1 off<br>               | For connection of: L1, L2, L3, PE 0.75 – 2.5 mm <sup>2</sup>   | Product Standards<br>NA Certification | IEC/EN 60947-4-1; UL 508; CSA-C22.2 No. 14-05; CE marking<br>Request filed for UL and CSA |   |

### Three-phase commoning links, incoming unit via terminals 1, 3, and 5

Finger- and back-of-hand-proof, short-circuit proof,  $U_e=690\text{ V}$ ,  $I_n=63\text{ A}$   
Can be extended through rotated installation

| Circuit-breakers<br>Number  | Length<br>mm | Unit width<br>mm | Part no.<br>Article no. | Price<br>See price list                   | Std. pack  | Notes   |
|---|--------------|------------------|-------------------------|---|------------|---|
| <b>For PKZM0-... or PKE without side-mounted auxiliary contacts or voltage releases</b>   |              |                  |                         |   |            |   |
|   | 2            | 90               | 45                      | <b>B3.0/2-PKZ0<sup>1)</sup></b><br>063961 | 10 off<br> | For parallel feeding of multiple motor-protective circuit-breakers on terminals 1, 3, and 5 |
|   | 3            | 135              | 45                      | <b>B3.0/3-PKZ0<sup>1)</sup></b><br>232289 | 10 off<br> |   |
|   | 4            | 180              | 45                      | <b>B3.0/4-PKZ0<sup>1)</sup></b><br>063960 | 10 off<br> |   |
|   | 5            | 225              | 45                      | <b>B3.0/5-PKZ0<sup>1)</sup></b><br>232290 | 10 off<br> |   |
| <b>For motor-protective circuit-breakers with one auxiliary contact or trip-indicating auxiliary contact each fitted to right side</b>                            |              |                  |                         |   |            |   |
|   | 2            | 99               | 45 + 9                  | <b>B3.1/2-PKZ0<sup>1)</sup></b><br>044945 | 10 off<br> | For parallel feeding of multiple motor-protective circuit-breakers on terminals 1, 3, and 5 |
|   | 3            | 153              | 45 + 9                  | <b>B3.1/3-PKZ0<sup>1)</sup></b><br>044946 | 10 off<br> |   |
|   | 4            | 207              | 45 + 9                  | <b>B3.1/4-PKZ0<sup>1)</sup></b><br>044947 | 10 off<br> |   |
|   | 5            | 261              | 45 + 9                  | <b>B3.1/5-PKZ0<sup>1)</sup></b><br>044948 | 10 off<br> |   |
| <b>For PKZM0-... or PKE with one auxiliary contact or trip-indicating auxiliary contact each fitted to right side, or one voltage release fitted on left side</b> |              |                  |                         |   |            |   |
|   | 2            | 108              | 45 + 18                 | <b>B3.2/2-PKZ0<sup>1)</sup></b><br>063963 | 10 off<br> | For parallel feeding of multiple motor-protective circuit-breakers on terminals 1, 3, and 5 |
|   | 4            | 234              | 45 + 18                 | <b>B3.2/4-PKZ0<sup>1)</sup></b><br>063959 | 10 off<br> |   |

#### Information relevant for export to North America



1)  
Product Standards  
UL File No.  
UL CCN  
CSA File No.  
CSA Class No.  
NA Certification

UL 508A; CSA-C22.2 No.14; IEC60947-4-1; CE marking  
E36332  
NLRV  
98494  
3211-06  
UL Listed, CSA certified

**HB3...PKZO, BK...I3-PKZ**

| Circuit-breakers | For use with | Unit width | Part no.<br>Article no. | Price<br>See price list | Std. pack | Notes |
|------------------|--------------|------------|-------------------------|-------------------------|-----------|-------|
|------------------|--------------|------------|-------------------------|-------------------------|-----------|-------|

| Number | mm |
|--------|----|
|--------|----|

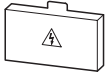

**Shroud for unused terminals**

**Protection against direct contact.**

**For covering unused terminals on three-phase commoning link B3...-PKZO**

|   |   |   |   |  |            |   |
|---|---|---|---|--|------------|---|
| - | - | - | <b>H-B3-PKZO<sup>1)</sup></b><br>032721 |  | 20 off<br> | - |
|---|---|---|---|--|------------|---|

**Incoming terminals**

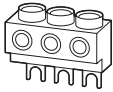

|   |              |   |   |  |           |   |
|---|--------------|---|---|--|-----------|---|
| - | PKZM0<br>PKE | - | <b>BK25/3-PKZO<sup>2)</sup></b><br>032720 |  | 5 off<br> | For three-phase commoning link, protected against accidental contact, $U_e = 690\text{ V}$ , $I_u = 63\text{ A}$<br>For conductor cross-sections:<br>2.5 - 25 mm <sup>2</sup> stranded<br>2.5 - 16 mm <sup>2</sup> flexible with ferrule<br>AWG 14 - 6, usable on terminals 1, 3, and 5 |
|---|--------------|---|---|--|-----------|---|

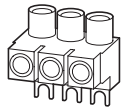

|   |       |   |   |  |           |  |
|---|-------|---|---|--|-----------|--|
| - | PKZM0 | - | <b>BK25/3-PKZO-E<sup>3)</sup></b><br>262518 |  | 5 off<br> | For three-phase commoning link, protected against accidental contact, $U_e = 690\text{ V}$ , $I_u = 60\text{ A}$<br>For conductor cross-sections:<br>2.5 - 25 mm <sup>2</sup> stranded<br>2.5 - 16 mm <sup>2</sup> flexible with ferrule<br>AWG 14 - 6<br>For assembly of Type E starters. |
|---|-------|---|---|--|-----------|--|

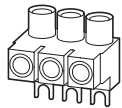

|   |       |   |   |  |           |  |
|---|-------|---|---|--|-----------|--|
| - | PKZM4 | - | <b>BK50/3-PKZ4-E<sup>4)</sup></b><br>272165 |  | 1 off<br> | Can be combined with three-phase commoning link B3...PKZ4.<br>$I_u = 120\text{ A}$ .<br>For assembly of Type E starters. |
|---|-------|---|---|--|-----------|--|

**Information relevant for export to North America**



1)

|                   |  |
|-------------------|--|
| Product Standards | UL 508; CSA-C22.2 No.14; IEC60947-4-1;<br>CE marking |
| UL File No.       | E36332   |
| UL CCN            | NLRV   |
| CSA File No.      | 98494  |
| CSA Class No.     | 3211-06  |
| NA Certification  | UL Listed, CSA certified                             |

2)

|                   |  |
|-------------------|--|
| Product Standards | UL 508; CSA-C22.2 No.14; IEC60947-4-1;<br>CE marking |
| UL File No.       | E36332   |
| UL CCN            | NLRV   |
| CSA File No.      | 12528  |
| CSA Class No.     | 3211-05  |
| NA Certification  | UL Listed, CSA certified                             |

3)

|  |  |
|--|--|
| Product Standards                      | UL 508; CSA-C22.2 No.14; IEC60947-4-1;<br>CE marking             |
| UL File No.                            | E36332   |
| UL CCN                                 | NLRV   |
| CSA File No.                           | 98494  |
| CSA Class No.                          | 3211-06  |
| NA Certification                       | UL Listed, CSA certified   |
| Specially designed for NA Suitable for | ✓<br>PKZM0/PKE, line terminal required for Type E/F applications |

4)

|  |  |
|--|--|
| Product Standards                      | UL 508; CSA-C22.2 No.14; IEC60947-4-1;<br>CE marking             |
| UL File No.                            | E36332   |
| UL CCN                                 | NLRV   |
| CSA File No.                           | 12528  |
| CSA Class No.                          | 3211-06  |
| NA Certification                       | UL Listed, CSA certified   |
| Specially designed for NA Suitable for | ✓<br>PKZM4/PKE, line terminal required for Type E/F applications |

# 1.3

## Motor-protective circuit-breakers PKZM01, PKZM0, PKZM4, PKE Three-phase commoning links

1

### Three-phase commoning links

Finger- and back-of-hand-proof, short-circuit proof  $U_p=690\text{ V}$ ,  $I_p=128\text{ A}$

| Circuit-breakers | Length | Unit width | Part no.    | Price          | Std. pack |
|------------------|--------|------------|-------------|----------------|-----------|
| Number           | mm     | mm         | Article no. | See price list |           |

Information relevant for export to North America



#### For PKZM4 without side-mounted auxiliary contacts or voltage releases

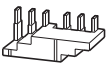

|   |     |    |                              |       |  |
|---|-----|----|------------------------------|-------|--|
| 2 | 110 | 55 | <b>B3.0/2-PKZ4</b><br>220220 | 1 off |  |
|---|-----|----|------------------------------|-------|--|



|   |     |    |                              |       |  |
|---|-----|----|------------------------------|-------|--|
| 3 | 165 | 55 | <b>B3.0/3-PKZ4</b><br>220221 | 1 off |  |
|---|-----|----|------------------------------|-------|--|

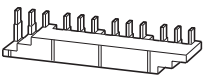

|   |     |    |                              |       |  |
|---|-----|----|------------------------------|-------|--|
| 4 | 220 | 55 | <b>B3.0/4-PKZ4</b><br>220222 | 1 off |  |
|---|-----|----|------------------------------|-------|--|

#### For PKZM4 with one auxiliary contact or trip-indicating auxiliary contact each fitted on the right side

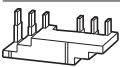

|   |     |        |                              |       |  |
|---|-----|--------|------------------------------|-------|--|
| 2 | 119 | 55 + 9 | <b>B3.1/2-PKZ4</b><br>220223 | 1 off |  |
|---|-----|--------|------------------------------|-------|--|

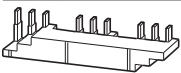

|   |     |        |                              |       |  |
|---|-----|--------|------------------------------|-------|--|
| 3 | 183 | 55 + 9 | <b>B3.1/3-PKZ4</b><br>220224 | 1 off |  |
|---|-----|--------|------------------------------|-------|--|

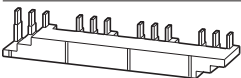

|   |     |        |                              |       |  |
|---|-----|--------|------------------------------|-------|--|
| 4 | 247 | 55 + 9 | <b>B3.1/4-PKZ4</b><br>220225 | 1 off |  |
|---|-----|--------|------------------------------|-------|--|

#### For PKZM4 with one auxiliary contact or trip-indicating auxiliary contact each fitted to right side, or one voltage release fitted to left side



|   |     |         |                              |       |  |
|---|-----|---------|------------------------------|-------|--|
| 2 | 128 | 55 + 18 | <b>B3.2/2-PKZ4</b><br>220226 | 1 off |  |
|---|-----|---------|------------------------------|-------|--|

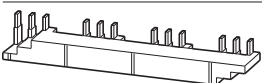

|   |     |         |                              |       |  |
|---|-----|---------|------------------------------|-------|--|
| 4 | 274 | 55 + 18 | <b>B3.2/4-PKZ4</b><br>220227 | 1 off |  |
|---|-----|---------|------------------------------|-------|--|



### Shroud for unused terminals

Protection against direct contact.  
To cover unused terminals on three-phase commoning link

| Circuit-breakers | Length | Unit width | Part no.    | Price          | Std. pack |
|------------------|--------|------------|-------------|----------------|-----------|
| Number           | mm     | mm         | Article no. | See price list |           |

























































Information relevant for export to North America



|   |   |   |                            |        |  |
|---|---|---|----------------------------|--------|--|
| – | – | – | <b>H-B3-PKZ4</b><br>220228 | 10 off |  |
|---|---|---|----------------------------|--------|--|

Product Standards UL 508; CSA-C22.2 No.14; IEC60947-4-1; CE marking  
UL File No. E36332  
UL CCN NLRV  
CSA File No. 12528  
CSA Class No. 3211-06  
NA Certification UL Listed, CSA certified

## A-PKZO, U-PKZO

| Actuating voltage  | Part no.<br>Article no.                        | Price<br>See price list | Std. pack  | Part no.<br>Article no.                        | Price<br>See price list | Std. pack  | Notes  |
|--|--|-------------------------|--|--|-------------------------|--|--|
| <b>Shunt release, undervoltage release</b>                   |  |                         |  |  |                         |  |  |
| AC   |  |                         |  |  |                         |  |  |
| Standard voltage   |  |                         |  |  |                         |  |  |
| 24 V 50 Hz   | <b>A-PKZO(24V50Hz)<sup>1)</sup></b><br>073181  |                         | 2 off<br>      | <b>U-PKZO(24V50Hz)<sup>1)</sup></b><br>073129  |                         | 2 off<br>      |  |
| 110 V 50 Hz  | <b>A-PKZO(110V50Hz)<sup>1)</sup></b><br>073184 |                         | 2 off<br>      | <b>U-PKZO(110V50Hz)<sup>1)</sup></b><br>073132 |                         | 2 off<br>      |  |
| 220 V 50 Hz  | <b>A-PKZO(220V50Hz)<sup>1)</sup></b><br>073186 |                         | 2 off<br>      | <b>U-PKZO(220V50Hz)<sup>1)</sup></b><br>073134 |                         | 2 off<br>      |  |
| 230 V 50 Hz  | <b>A-PKZO(230V50Hz)<sup>1)</sup></b><br>073187 |                         | 2 off<br>      | <b>U-PKZO(230V50Hz)<sup>1)</sup></b><br>073135 |                         | 2 off<br>      | Only A(U)-PKZO... with serial number 02 or higher can be fitted  |
| 240 V 50 Hz  | <b>A-PKZO(240V50Hz)<sup>1)</sup></b><br>073188 |                         | 2 off<br>      | <b>U-PKZO(240V50Hz)<sup>1)</sup></b><br>073136 |                         | 2 off<br>      |  |
| 380 V 50 Hz  | <b>A-PKZO(380V50Hz)<sup>1)</sup></b><br>073189 |                         | 2 off<br>      | <b>U-PKZO(380V50Hz)<sup>1)</sup></b><br>073137 |                         | 2 off<br>      |  |
| 400 V 50 Hz  | <b>A-PKZO(400V50Hz)<sup>1)</sup></b><br>073190 |                         | 2 off<br>      | <b>U-PKZO(400V50Hz)<sup>1)</sup></b><br>073138 |                         | 2 off<br>      |  |
| 415 V 50 Hz  | <b>A-PKZO(415V50Hz)<sup>1)</sup></b><br>073191 |                         | 2 off<br>      | <b>U-PKZO(415V50Hz)<sup>1)</sup></b><br>073139 |                         | 2 off<br>      |  |
| 120 V 60 Hz  | <b>A-PKZO(120V60Hz)<sup>1)</sup></b><br>073195 |                         | 2 off<br>    | <b>U-PKZO(120V60Hz)<sup>1)</sup></b><br>073143 |                         | 2 off<br>    |  |
| 240 V 60 Hz  | <b>A-PKZO(240V60Hz)<sup>1)</sup></b><br>073198 |                         | 2 off<br>  | <b>U-PKZO(240V60Hz)<sup>1)</sup></b><br>073146 |                         | 2 off<br>  |  |
| 440 V 60 Hz  | <b>A-PKZO(440V60Hz)<sup>1)</sup></b><br>082164 |                         | 2 off<br>  | <b>U-PKZO(440V60Hz)<sup>1)</sup></b><br>082161 |                         | 2 off<br>  |  |
| 480 V 60 Hz  | <b>A-PKZO(480V60Hz)<sup>1)</sup></b><br>073199 |                         | 2 off<br>  | <b>U-PKZO(480V60Hz)<sup>1)</sup></b><br>073147 |                         | 2 off<br>  |  |
| Non-standard voltages not covered by above standard voltages |  |                         |  |  |                         |  |  |
| ... V 50 Hz (24 - 500 V)                                     | <b>A-PKZO(*V50Hz)<sup>1)</sup></b><br>982165   |                         | 2 off<br>  | <b>U-PKZO(*V50Hz)</b><br>982162                |                         |  | The part number for ordering consists of the basic part number and the actuating voltage. For non-standard voltages, specify the required actuating voltage within the indicated range (... - ... V). Minimum order quantity is 10 units |
| ... V 60 Hz (24 - 600 V)                                     | <b>A-PKZO(*V60Hz)<sup>1)</sup></b><br>982166   |                         | 2 off<br>  | <b>U-PKZO(*V60Hz)</b><br>982163                |                         |  |  |
| DC   |  |                         |  |  |                         |  |  |
| Standard voltage   |  |                         |  |  |                         |  |  |
| 24 V DC  | <b>A-PKZO(24VDC)<sup>1)</sup></b><br>073200    |                         | 2 off<br>  |  |                         |  | PKE can be fitted only with A(U)-PKZO... with serial number 02 or higher.  |
| 110 V DC   | <b>A-PKZO(110VDC)<sup>1)</sup></b><br>073203   |                         | 2 off<br>  |  |                         |  |  |

### Information relevant for export to North America



1)

|                   |   |
|-------------------|---|
| Product Standards | UL 508; CSA-C22.2 No.14; IEC60947-4-1; CE marking |
| UL File No.       | E36332  |
| UL CCN            | NLRV  |
| CSA File No.      | 12528   |
| CSA Class No.     | 3211-05   |
| NA Certification  | UL Listed, CSA certified                          |

# 1.3 Motor-protective circuit-breakers PKZM01, PKZM0, PKZM4, PKE

## 1 Engineering

### 1- and 2-pole-connected PKZM0, PKZM4 with AC and DC



### 2-pole-connected PKZM0(1) and PKZM4 with CL-PKZ0

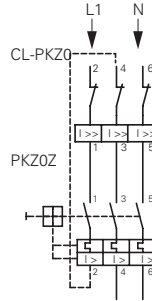

### Protection of PVC-insulated cables against thermal overload on short-circuits

The table specifies which minimum conductor cross-sections are protected by motor-protective circuit-breaker PKZ(M) up to their rated conditional short-circuit current  $I_q$ .

| Min. cross-section protected<br>380 – 415 V, 50 Hz, Cu mm <sup>2</sup> | Device<br>Part no. |
|--|--------------------|
| 4  | PKZM0-0,16         |
| 2.5  | PKZM0-6.3          |
| 1.5  | PKZM0-10           |
| 1  | PKZM0-12           |
| 0.75   | PKZM0-16           |
|  | PKZM0-20           |
|  | PKZM0-25           |
|  | PKZM0-32           |
|  | PKZM4-16           |
|  | PKZM4-25           |
|  | PKZM4-32           |
|  | PKZM4-40           |
|  | PKZM4-50           |
|  | PKZM4-58           |
|  | PKZM4-63           |

### PKZM0-...T tripping characteristics (not for PKM0-...), PKZM01

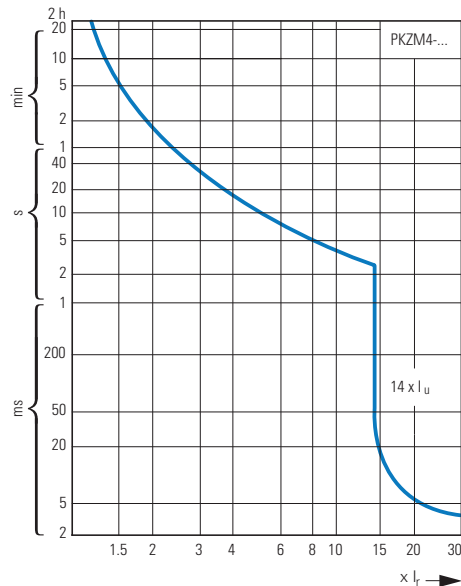
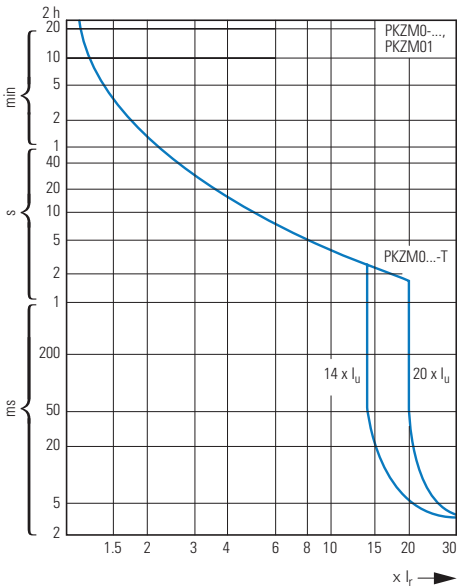

Tripping characteristic curves, wide-range circuit-breaker PKE

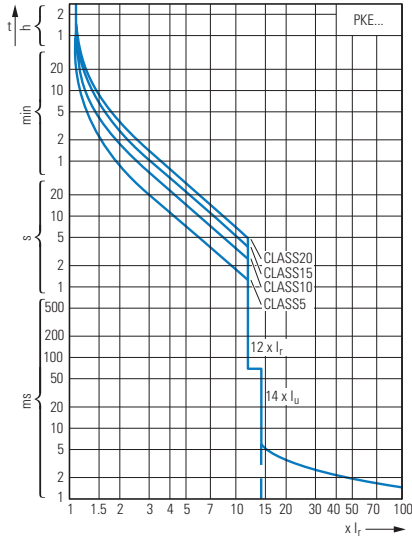

Let-through characteristics, motor-protective circuit-breaker, transformer-protective circuit-breakers, circuit-breaker for starter combinations

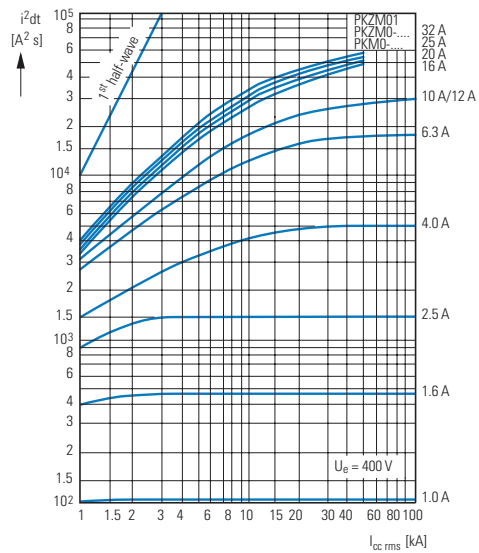
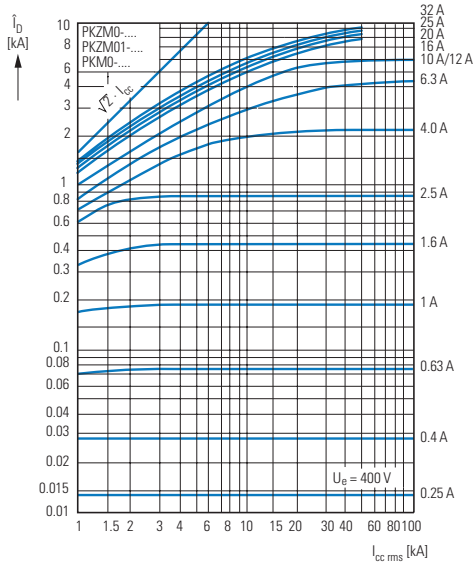

Motor-protective circuit-breaker let-through characteristics

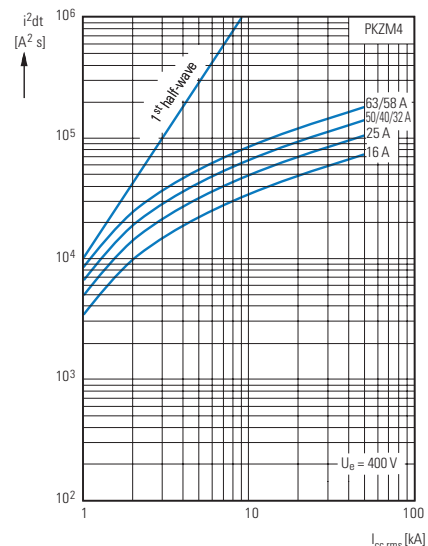
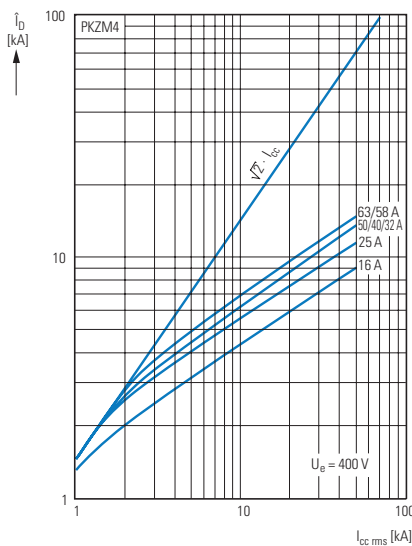



# 1.3

## Motor-protective circuit-breakers PKZM01, PKZM0, PKZM4, PKE

Switching capacity

### Circuit-breaker switching capacity from serial no. 04

1

Rated uninterrupted current  $I_u$

Rated conditional short-circuit current  $I_q$  IEC/EN 60947-4-1

Rated ultimate short-circuit breaking capacity  $I_{cu}$   
 Rated breaking capacity  $I_{cs}$  } IEC/EN 60947-2

|            | 230 V       |                |                |                 | 400 V       |                |                |                 | 440 V       |                |                |                 | 500 V       |                |                |                 | 690 V       |                |                |                 |
|------------|-------------|----------------|----------------|-----------------|-------------|----------------|----------------|-----------------|-------------|----------------|----------------|-----------------|-------------|----------------|----------------|-----------------|-------------|----------------|----------------|-----------------|
| $I_u$<br>A | $I_q$<br>kA | $I_{cu}$<br>kA | $I_{cs}$<br>kA | A <sup>1)</sup> | $I_q$<br>kA | $I_{cu}$<br>kA | $I_{cs}$<br>kA | A <sup>1)</sup> | $I_q$<br>kA | $I_{cu}$<br>kA | $I_{cs}$<br>kA | A <sup>1)</sup> | $I_q$<br>kA | $I_{cu}$<br>kA | $I_{cs}$<br>kA | A <sup>1)</sup> | $I_q$<br>kA | $I_{cu}$<br>kA | $I_{cs}$<br>kA | A <sup>1)</sup> |

#### PKZM0, PKZM0...-T, PKM0 with type "1" and "2" coordination

|          |     |     |     |    |     |     |     |    |    |    |    |    |    |    |    |    |   |   |   |    |
|----------|-----|-----|-----|----|-----|-----|-----|----|----|----|----|----|----|----|----|----|---|---|---|----|
| 0.16 – 1 | 150 | 150 | 150 | N  | 150 | 150 | 150 | N  |    |    |    | N  |    |    |    | N  |   |   |   | N  |
| 1.6      | 150 | 150 | 150 | N  | 150 | 150 | 150 | N  |    |    |    | N  |    |    |    | N  |   |   |   | N  |
| 2.5      | 150 | 150 | 150 | N  | 150 | 150 | 150 | N  |    |    |    | N  |    |    |    | N  | 5 | 5 | 5 | 50 |
| 4        | 150 | 150 | 150 | N  | 150 | 150 | 150 | N  |    |    |    | N  |    |    |    | N  | 3 | 3 | 3 | 50 |
| 6.3      | 150 | 150 | 150 | N  | 150 | 150 | 150 | N  |    |    |    | N  | 42 | 42 | 11 | 50 | 3 | 3 | 2 | 50 |
| 10       | 150 | 150 | 150 | N  | 150 | 150 | 150 | N  | 42 | 42 | 12 | 50 | 42 | 42 | 11 | 50 | 3 | 3 | 2 | 50 |
| 12       | 50  | 50  | 13  | 50 | 50  | 50  | 13  | 50 | 15 | 15 | 12 | 50 | 15 | 15 | 8  | 50 | 3 | 3 | 2 | 50 |
| 16       | 50  | 50  | 13  | 50 | 50  | 50  | 13  | 50 | 15 | 15 | 12 | 50 | 15 | 15 | 8  | 50 | 3 | 3 | 2 | 50 |
| 20       | 50  | 50  | 13  | 50 | 50  | 50  | 13  | 50 | 10 | 10 | 13 | 50 | 6  | 6  | 3  | 50 | 3 | 3 | 1 | 50 |
| 25       | 50  | 50  | 13  | 50 | 50  | 50  | 13  | 50 | 10 | 10 | 13 | 50 | 6  | 6  | 3  | 50 | 3 | 3 | 1 | 50 |
| 32       | 50  | 50  | 13  | 50 | 50  | 50  | 13  | 50 | 10 | 10 | 13 | 50 | 6  | 6  | 3  | 50 | 3 | 3 | 1 | 50 |

#### PKZM0 (PKZM0...-T, PKM0) + CL-PKZ0

|          |  |  |  |   |  |  |  |   |  |  |  |   |    |    |    |   |    |    |     |     |   |
|----------|--|--|--|---|--|--|--|---|--|--|--|---|----|----|----|---|----|----|-----|-----|---|
| 0.16 – 1 |  |  |  | N |  |  |  | N |  |  |  | N |    |    |    | N |    |    |     | 20  | N |
| 1.6      |  |  |  | N |  |  |  | N |  |  |  | N |    |    |    | N |    |    |     | 20  | N |
| 2.5      |  |  |  | N |  |  |  | N |  |  |  | N |    |    |    | N | 20 | 20 | 20  | 20  | N |
| 4        |  |  |  | N |  |  |  | N |  |  |  | N |    |    |    | N | 20 | 20 | 20  | 20  | N |
| 6.3      |  |  |  | N |  |  |  | N |  |  |  | N |    |    | 50 | N | 20 | 20 | 20  | 20  | N |
| 10       |  |  |  | N |  |  |  | N |  |  |  | N |    |    | 20 | N | 20 | 20 | 20  | 20  | N |
| 12       |  |  |  | N |  |  |  | N |  |  |  | N |    |    | 20 | N | 5  | 5  | 2.5 | 2.5 | N |
| 16       |  |  |  | N |  |  |  | N |  |  |  | N |    |    | 20 | N | 5  | 5  | 2.5 | 2.5 | N |
| 20       |  |  |  | N |  |  |  | N |  |  |  | N | 10 | 10 | 10 | N | 5  | 5  | 2.5 | 2.5 | N |
| 25       |  |  |  | N |  |  |  | N |  |  |  | N | 10 | 10 | 10 | N | 5  | 5  | 2.5 | 2.5 | N |
| 32       |  |  |  | N |  |  |  | N |  |  |  | N | 10 | 10 | 10 | N | 5  | 5  | 2.5 | 2.5 | N |

#### PKZM0 (PKZM0...-T, PKM0) + 2 CL-PKZ0

|          |  |  |  |   |  |  |  |   |  |  |  |   |    |    |    |   |    |    |     |     |   |
|----------|--|--|--|---|--|--|--|---|--|--|--|---|----|----|----|---|----|----|-----|-----|---|
| 0.16 – 1 |  |  |  | N |  |  |  | N |  |  |  | N |    |    |    | N |    |    |     | 20  | N |
| 1.6      |  |  |  | N |  |  |  | N |  |  |  | N |    |    |    | N |    |    |     | 20  | N |
| 2.5      |  |  |  | N |  |  |  | N |  |  |  | N |    |    |    | N | 40 | 40 | 20  | 20  | N |
| 4        |  |  |  | N |  |  |  | N |  |  |  | N |    |    |    | N | 40 | 40 | 20  | 20  | N |
| 6.3      |  |  |  | N |  |  |  | N |  |  |  | N |    |    | 50 | N | 20 | 20 | 20  | 20  | N |
| 10       |  |  |  | N |  |  |  | N |  |  |  | N |    |    | 40 | N | 20 | 20 | 20  | 20  | N |
| 12       |  |  |  | N |  |  |  | N |  |  |  | N |    |    | 40 | N | 10 | 10 | 2.5 | 2.5 | N |
| 16       |  |  |  | N |  |  |  | N |  |  |  | N |    |    | 40 | N | 10 | 10 | 2.5 | 2.5 | N |
| 20       |  |  |  | N |  |  |  | N |  |  |  | N | 20 | 20 | 20 | N | 10 | 10 | 2.5 | 2.5 | N |
| 25       |  |  |  | N |  |  |  | N |  |  |  | N | 20 | 20 | 20 | N | 10 | 10 | 2.5 | 2.5 | N |
| 32       |  |  |  | N |  |  |  | N |  |  |  | N | 20 | 20 | 20 | N | 10 | 10 | 2.5 | 2.5 | N |

**Notes**   No upstream protective device required, as it is the auto-protected range (100/150 kA)

<sup>1)</sup> Required back-up fuse if the short-circuit current exceeds the device's rated conditional short-circuit current ( $I_{cc} > I_q$ ).

N Not necessary

## Circuit-breaker switching capacity

Rated uninterrupted current  $I_u$

Rated conditional short-circuit current  $I_q$  IEC/EN 60947-4-1

Rated maximum short-circuit breaking capacity  $I_{cu}$   
 Rated breaking capacity  $I_{cs}$  } IEC/EN 60947-2

| $I_u$<br>A   | 230 V       |                |                |                 | 400 V       |                |                |                 | 440 V <sup>2)</sup> |                |                |                 | 500 V <sup>2)</sup> |                |                |                 | 690 V <sup>2)</sup> |                |                |                 |
|--|-------------|----------------|----------------|-----------------|-------------|----------------|----------------|-----------------|---------------------|----------------|----------------|-----------------|---------------------|----------------|----------------|-----------------|---------------------|----------------|----------------|-----------------|
|  | $I_q$<br>kA | $I_{cu}$<br>kA | $I_{cs}$<br>kA | A <sup>1)</sup> | $I_q$<br>kA | $I_{cu}$<br>kA | $I_{cs}$<br>kA | A <sup>1)</sup> | $I_q$<br>kA         | $I_{cu}$<br>kA | $I_{cs}$<br>kA | A <sup>1)</sup> | $I_q$<br>kA         | $I_{cu}$<br>kA | $I_{cs}$<br>kA | A <sup>1)</sup> | $I_q$<br>kA         | $I_{cu}$<br>kA | $I_{cs}$<br>kA | A <sup>1)</sup> |
| <b>PKZM01 with type "1" and "2" coordination</b>               |             |                |                |                 |             |                |                |                 |                     |                |                |                 |                     |                |                |                 |                     |                |                |                 |
| 0.16 – 1   | 50          | 50             | 50             | 50              | 50          | 50             | 50             | 50              | 50                  | 50             | 50             | 50              | 50                  | 50             | 50             | 50              | 50                  | 50             | 50             | 50              |
| 1.6  | 50          | 50             | 50             | 50              | 50          | 50             | 50             | 50              | 50                  | 50             | 50             | 50              | 50                  | 50             | 50             | 50              | 50                  | 50             | 50             | 50              |
| 2.5  | 50          | 50             | 50             | 50              | 50          | 50             | 50             | 50              | 50                  | 50             | 50             | 50              | 50                  | 50             | 50             | 50              | 50                  | 50             | 50             | 50              |
| 4  | 50          | 50             | 50             | 50              | 50          | 50             | 50             | 50              | 50                  | 50             | 50             | 50              | 50                  | 50             | 50             | 50              | 50                  | 50             | 50             | 50              |
| 6.3  | 50          | 50             | 50             | 50              | 50          | 50             | 50             | 50              | 50                  | 50             | 50             | 50              | 50                  | 50             | 50             | 50              | 50                  | 50             | 50             | 50              |
| 10   | 50          | 50             | 50             | 50              | 50          | 50             | 50             | 50              | 42                  | 42             | 10             | 50              | 50                  | 50             | 50             | 50              | 50                  | 50             | 50             | 50              |
| 12   | 50          | 50             | 10             | 50              | 50          | 50             | 10             | 50              | 15                  | 15             | 10             | 50              | 50                  | 50             | 50             | 50              | 50                  | 50             | 50             | 50              |
| 16   | 50          | 50             | 10             | 50              | 50          | 50             | 10             | 50              | 15                  | 15             | 10             | 50              | 50                  | 50             | 50             | 50              | 50                  | 50             | 50             | 50              |
| 20, 25   | 50          | 50             | 10             | 50              | 50          | 50             | 10             | 50              | 10                  | 10             | 3              | 50              | 50                  | 50             | 50             | 50              | 50                  | 50             | 50             | 50              |
| <b>PKZM4 with type "1" and "2" coordination</b>                |             |                |                |                 |             |                |                |                 |                     |                |                |                 |                     |                |                |                 |                     |                |                |                 |
| 16   | 150         | 150            | 25             | N               | 150         | 150            | 25             | N               | 45                  | 45             | 25             | 100             | 15                  | 15             | 100            | 8               | 8                   | 2.5            | 100            |                 |
| 25   | 150         | 150            | 25             | N               | 150         | 150            | 25             | N               | 45                  | 45             | 25             | 100             | 15                  | 15             | 100            | 8               | 8                   | 2.5            | 100            |                 |
| 32   | 50          | 50             | 25             | 100             | 50          | 50             | 25             | 100             | 45                  | 45             | 25             | 100             | 15                  | 15             | 100            | 5               | 5                   | 2.5            | 100            |                 |
| 40   | 50          | 50             | 25             | 100             | 50          | 50             | 25             | 100             | 45                  | 45             | 25             | 100             | 15                  | 15             | 100            | 5               | 5                   | 2.5            | 100            |                 |
| 50   | 50          | 50             | 25             | 100             | 50          | 50             | 25             | 100             | 45                  | 45             | 25             | 100             | 15                  | 15             | 100            | 5               | 5                   | 2.5            | 100            |                 |
| 58   | 50          | 50             | 25             | 160             | 50          | 50             | 25             | 160             | 45                  | 45             | 25             | 160             | 15                  | 15             | 160            | 5               | 5                   | 2.5            | 160            |                 |
| 63   | 50          | 50             | 25             | 160             | 50          | 50             | 25             | 160             | 45                  | 45             | 25             | 160             | 15                  | 15             | 160            | 5               | 5                   | 2.5            | 160            |                 |
| <b>PKE12...<sup>2)</sup> with type of coordination „1“ and</b> |             |                |                |                 |             |                |                |                 |                     |                |                |                 |                     |                |                |                 |                     |                |                |                 |
| 0.3 - 1.2  | 100         |                |                | 50              | 100         |                |                | 50              | 50                  |                |                | 50              | 10                  |                |                | 50              | 3                   |                |                | 50              |
| 1 - 4  | 100         |                |                | 50              | 100         |                |                | 50              | 50                  |                |                | 50              | 10                  |                |                | 50              | 3                   |                |                | 50              |
| 3 - 12   | 100         |                |                | 50              | 100         |                |                | 50              | 15                  |                |                | 50              | 10                  |                |                | 50              | 3                   |                |                | 50              |
| <b>PKE32...<sup>2)</sup> with type of coordination „1“ and</b> |             |                |                |                 |             |                |                |                 |                     |                |                |                 |                     |                |                |                 |                     |                |                |                 |
| 3 - 12   | 100         |                |                | 50              | 100         |                |                | 50              | 15                  |                |                | 50              | 6                   |                |                | 50              | 3                   |                |                | 50              |
| 8 - 32   | 100         |                |                | 50              | 100         |                |                | 50              | 25                  |                |                | 50              | 6                   |                |                | 50              | 3                   |                |                | 50              |

### Notes

- No upstream protective device required, as it is the auto-protected range (150 kA)
- N Not necessary

- Fuse (A gG/gL) for increasing the switching capacity of the motor-protective circuit-breaker to 100 kA
- Please enquire for additional information regarding voltages >400 V and device combinations with CL-PKZ0.

## Motor-protective circuit-breaker internal resistances

|            | Impedance | Heat dissipation (3 pole at operating temperature) | Rated uninterrupted current $I_u$ |          | Impedance | Heat dissipation (3 pole at operating temperature) | Rated uninterrupted current $I_u$ |
|------------|-----------|--|-----------------------------------|----------|-----------|--|-----------------------------------|
|            | $\Omega$  | W  | A                                 |          | $\Omega$  | W  | A                                 |
| PKZM0-0.16 | 78        | 6  | 0.16                              | PKZM4-16 | 0.029     | 22   | 16                                |
| PKZM0-0.25 | 32        | 6  | 0.25                              | PKZM4-25 | 0.012     | 22   | 25                                |
| PKZM0-0.4  | 13        | 6  | 0.4                               | PKZM4-32 | 0.007     | 22   | 32                                |
| PKZM0-0.63 | 5         | 6  | 0.63                              | PKZM4-40 | 0.005     | 22   | 40                                |
| PKZM0-1    | 2         | 6  | 1                                 | PKZM4-50 | 0.003     | 22   | 50                                |
| PKZM0-1.6  | 0.8       | 6  | 1.6                               | PKZM4-58 | 0.002     | 22   | 58                                |
| PKZM0-2.5  | 0.32      | 6  | 2.5                               | PKZM4-63 | 0.002     | 22   | 65                                |
| PKZM0-4    | 0.13      | 6  | 4                                 |          |           |  |                                   |
| PKZM0-6.3  | 0.050     | 6  | 6.3                               |          |           |  |                                   |
| PKZM0-10   | 0.020     | 6  | 10                                |          |           |  |                                   |
| PKZM0-12   | 0.014     | 6  | 12                                |          |           |  |                                   |
| PKZM0-16   | 0.008     | 6  | 16                                |          |           |  |                                   |
| PKZM0-20   | 0.005     | 6  | 20                                |          |           |  |                                   |
| PKZM0-25   | 0.003     | 6  | 25                                |          |           |  |                                   |
| PKZM0-32   | 0.002     | 6  | 32                                |          |           |  |                                   |

# 1.3

## Motor-protective circuit-breakers PKZM01, PKZM0, PKZM4, PKE

### Motor-protective circuit-breakers PKZM

#### 1 Approvals for world markets

#### PKZM01, PKZM0, PKZM4

Rating data for approved types<sup>1)</sup>  
UL 508/CSA C 22.2 No. 14

|  | Maximum motor rating                                  |       |       |       | Setting ranges    |                        | Maximum protective device to UL/CSA |                     |         |                         |         |     |
|--|---|-------|-------|-------|-------------------|------------------------|-------------------------------------|---------------------|---------|-------------------------|---------|-----|
|  | Three-phase current                                   |       |       |       | Overload releases | Short-circuit releases | Group protection <sup>2)</sup>      |                     |         |                         |         |     |
|  | 200 V   | 230 V | 460 V | 575 V |                   |                        | Up to max. short-circuit current    | Maximum fuse rating |         | Maximum circuit breaker |         |     |
|  | HP  | HP    | HP    | HP    | A                 | A                      | 600 V                               | with CL             | with CL | with CL                 | with CL |     |
| Motor-protective circuit-breakers PKZM01 | "Manual Motor Starter with thermal and magnetic trip" |       |       |       |                   |                        |                                     |                     |         |                         |         |     |
| PKZM01-0,16                              | 3 <sup>3)</sup>                                       |       |       |       | 0.1 – 0.16        | 2.2                    | 50                                  | 600                 |         | 600                     |         |     |
| PKZM01-0.25                              |   |       |       |       | 0.16 – 0.25       | 3.4                    | 50                                  | 600                 |         | 600                     |         |     |
| PKZM01-0.4                               |   |       |       |       | 0.25 – 0.4        | 5.6                    | 50                                  | 600                 |         | 600                     |         |     |
| PKZM01-0,63                              |   |       |       |       | 0.4 – 0.63        | 8.8                    | 50                                  | 600                 |         | 600                     |         |     |
| PKZM01-1                                 |   |       |       |       | 0.63 – 1          | 14                     | 50                                  | 600                 |         | 600                     |         |     |
| PKZM01-1,6                               |   |       | ¾     | ¾     | 1 – 1.6           | 22                     | 50                                  | 600                 |         | 600                     |         |     |
| PKZM01-2.5                               | ½   | ½     | 1     | 1½    | 1.6 – 2.5         | 35                     | 50                                  | 600                 |         | 600                     |         |     |
| PKZM01-4                                 | ¾   | ¾     | 2     | 3     | 2.5 – 4           | 56                     | 50                                  | 600                 |         | 600                     |         |     |
| PKZM01-6,3                               | 1   | 1½    | 3     | 5     | 4 – 6.3           | 88                     | 50                                  | 600                 |         | 600                     |         |     |
| PKZM01-10                                | 3   | 3     | 7½    | 10    | 6.3 – 11          | 140                    | 22                                  | 50                  | 150     | 600                     | 125     | 600 |
| PKZM01-12                                | 3   | 3     | 7½    | 10    | 9 – 12            | 168                    | 18                                  | 50                  | 150     | 600                     | 125     | 600 |
| PKZM01-16                                | 3   | 5     | 10    | 10    | 10 – 16           | 224                    | 10                                  | 50                  | 150     | 600                     | 125     | 600 |
| PKZM01-20                                | 5   | -     | -     | 15    | 16 – 20           | 280                    | 10                                  | 18                  | 150     | 600                     | 125     | 600 |
| PKZM01-25                                | -   | 7½    | 15    | 20    | 20 – 25           | 350                    | 10                                  | 18                  | 150     | 600                     | 125     | 600 |
| Motor-protective circuit-breakers PKZM01 | "Manual Motor Starter with thermal and magnetic trip" |       |       |       |                   |                        |                                     |                     |         |                         |         |     |
| PKZM0-0,16                               | 3 <sup>3)</sup>                                       |       |       |       | 0.1 – 0.16        | 2.2                    | 50                                  | 600                 |         | 600                     |         |     |
| PKZM0-0.25                               |   |       |       |       | 0.16 – 0.25       | 3.4                    | 50                                  | 600                 |         | 600                     |         |     |
| PKZM0-0.4                                |   |       |       |       | 0.25 – 0.4        | 5.6                    | 50                                  | 600                 |         | 600                     |         |     |
| PKZM0-0.63                               |   |       |       |       | 0.4 – 0.63        | 8.8                    | 50                                  | 600                 |         | 600                     |         |     |
| PKZM0-1                                  |   |       |       |       | 0.63 – 1          | 14                     | 50                                  | 600                 |         | 600                     |         |     |
| PKZM0-1.6                                |   |       | ¾     | ¾     | 1 – 1.6           | 22                     | 50                                  | 600                 |         | 600                     |         |     |
| PKZM0-2.5                                | ½   | ½     | 1     | 1½    | 1.6 – 2.5         | 35                     | 50                                  | 600                 |         | 600                     |         |     |
| PKZM0-4                                  | ¾   | ¾     | 2     | 3     | 2.5 – 4           | 56                     | 50                                  | 600                 |         | 600                     |         |     |
| PKZM0-6.3                                | 1   | 1½    | 3     | 5     | 4 – 6.3           | 88                     | 50                                  | 600                 |         | 600                     |         |     |
| PKZM0-10                                 | 3   | 3     | 7½    | 10    | 6.3 – 11          | 140                    | 22                                  | 50                  | 150     | 600                     | 125     | 600 |
| PKZM0-12                                 | 3   | 3     | 7½    | 10    | 9 – 12            | 168                    | 18                                  | 50                  | 150     | 600                     | 125     | 600 |
| PKZM0-16                                 | 3   | 5     | 10    | 10    | 10 – 16           | 224                    | 10                                  | 50                  | 150     | 600                     | 125     | 600 |
| PKZM0-20                                 | 5   | -     | -     | 15    | 16 – 20           | 280                    | 10                                  | 18                  | 150     | 600                     | 125     | 600 |
| PKZM0-25                                 | -   | 7½    | 15    | 20    | 20 – 25           | 350                    | 10                                  | 18                  | 150     | 600                     | 125     | 600 |
| PKZM0-32                                 | 7½  | 10    | 20    | 25    | 24 – 32           | 448                    | 10                                  | 18                  | 150     | 600                     | 125     | 600 |
| Motor-protective circuit-breakers PKZM4  |   |       |       |       |                   |                        |                                     |                     |         |                         |         |     |
| PKZM4-16                                 | 3   | 5     | 10    | 15    | 10 – 16           | 224                    | 50                                  | 600                 |         | 600                     |         |     |
| PKZM4-25                                 | 7½  | 7½    | 20    | 25    | 16 – 25           | 350                    | 50                                  | 600                 |         | 600                     |         |     |
| PKZM4-32                                 | 10  | 10    | 25    | 30    | 25 – 34           | 448                    | 50                                  | 600                 |         | 600                     |         |     |
| PKZM4-40                                 | 10  | 15    | 30    | 40    | 32 – 42           | 560                    | 50                                  | 600                 |         | 600                     |         |     |
| PKZM4-50                                 | 10  | 15    | 30    | 40    | 40 – 52           | 700                    | 10                                  | 600                 |         | 600                     |         |     |
| PKZM4-58                                 | 15  | 15    | 40    | 50    | 50 – 56           | 812                    | 10                                  | 600                 |         | 600                     |         |     |
| PKZM4-63                                 | 15  | 15    | 40    | 50    | 52 – 58           | 882                    | 10                                  | 600                 |         | 600                     |         |     |

#### Notes

Service factor (SF)

Set value  $I_r$ , on the current scale, depending on the load factor

$$SF = 1.15 \rightarrow I_r = 1 \times I_{n\text{ mot}}$$

$$SF = 1 \rightarrow I_r = 0.9 \times I_{n\text{ mot}}$$

<sup>1)</sup> Devices for world markets IEC  $\Delta$  UL/CSA

<sup>2)</sup> Caution: Changed requirements for group protection

<sup>3)</sup> Calculate motor output in this range according to rated operational current. Specified values as per NEC Table 430 – 150

## PKZM

### Rating data for approved types<sup>1)</sup>

UL 508/CSA C 22.2 No. 14

|                                      |                | For use with       | Pilot Duty   | General Use                      |  |
|--------------------------------------|----------------|--------------------|--------------|----------------------------------|--|
| <b>Accessories</b>                   |                |                    |              |                                  |  |
| Standard auxiliary contacts          | NHI11-PKZO     | PKZM0(-T)<br>PKZM4 | A 600, Q 300 | 5 A – 600 V AC<br>1 A – 250 V DC | –  |
|                                      | NHI12-PKZO     |                    |              |                                  |  |
|                                      | NHI21-PKZO     |                    |              |                                  |  |
|                                      | NHI2-11S-PKZO  |                    |              |                                  |  |
|                                      | NHI-E-11-PKZO  |                    |              |                                  |  |
| Early-make auxiliary contacts        | NHI-E-10-PKZO  |                    | E150         | 0.5 A – 250 V AC                 | –  |
|                                      | VHI20-PKZO     | PKZM0(-T)          | E150         | 0.5 A – 250 V AC                 | –  |
| Trip indicators                      | VHI20-PKZO1    | PKZM01             | E150         | 0.5 A – 250 V AC                 | –  |
|                                      | AGM2-10-PKZO   | PKZM0(-T)<br>PKZM4 | A 600, Q 300 | 5 A – 600 V AC<br>1 A – 250 V DC | –  |
| AGM2-01-PKZO                         |                |                    |              |                                  |  |
| Shunt release                        | A-PKZO(...)    | PKZM0(-T)<br>PKZM4 | –            | –                                | Actuating voltages and ordering information → Products for the German market |
|                                      | U-PKZO(...)    |                    |              |                                  |  |
| Auxiliary contact for contact module | HI11-S/EZ-PKZO | PKZM0              | A 600, Q 300 | 5 A – 600 V AC<br>1 A – 250 V DC | –  |

### Notes

<sup>1)</sup> Devices for world markets IEC Δ UL/CSA

## PKZM

### Motor-protective circuit-breakers PKZM0(4) used as "Manual self-protected Motor Starters" – UL 508 Type E

| Maximum motor output |       |       |       | Setting ranges    |                        | Interrupting Capacity = Short Circuit Current (SCCR) |                              |                              | Components        |                      |
|----------------------|-------|-------|-------|-------------------|------------------------|--|------------------------------|------------------------------|-------------------|----------------------|
| AC                   |       |       |       | Overload releases | Short-circuit releases | 240 V  | 480Y/<br>277 V <sup>2)</sup> | 600Y/<br>347 V <sup>2)</sup> | Motor Protector   | Accessories          |
| 200 V                | 230 V | 460 V | 575 V | [A]               | [A]                    | [kA]   | [kA]                         | [kA]                         | Part no.          | Part no.             |
| 208 V                | 240 V | 480 V | 600 V |                   |                        |  |                              |                              |                   |                      |
| <sup>1)</sup>        |       |       |       | 0.1 – 0.16        | 2.2                    | 65   | 65                           | 50                           | <b>PKZM0-0.16</b> | <b>BK25/3-PKZO-E</b> |
|                      |       |       |       | 0.16 – 0.25       | 3.4                    | 65   | 65                           | 50                           | <b>PKZM0-0.25</b> | <b>BK25/3-PKZO-E</b> |
|                      |       |       |       | 0.25 – 0.4        | 5.6                    | 65   | 65                           | 50                           | <b>PKZM0-0.4</b>  | <b>BK25/3-PKZO-E</b> |
|                      |       |       |       | 0.4 – 0.63        | 8.8                    | 65   | 65                           | 50                           | <b>PKZM0-0.63</b> | <b>BK25/3-PKZO-E</b> |
|                      |       |       |       | 0.63 – 1          | 14                     | 65   | 65                           | 50                           | <b>PKZM0-1</b>    | <b>BK25/3-PKZO-E</b> |
|                      |       |       |       | 1 – 1.6           | 22                     | 65   | 65                           | 50                           | <b>PKZM0-1.6</b>  | <b>BK25/3-PKZO-E</b> |
| ½                    | ½     | 1     | 1½    | 1.6 – 2,5         | 35                     | 65   | 65                           | 50                           | <b>PKZM0-2.5</b>  | <b>BK25/3-PKZO-E</b> |
| ¾                    | ¾     | 2     | 3     | 2.5 – 4           | 56                     | 65   | 65                           | 50                           | <b>PKZM0-4</b>    | <b>BK25/3-PKZO-E</b> |
| 1                    | 1½    | 3     | 5     | 4 – 6.3           | 88                     | 65   | 65                           | 50                           | <b>PKZM0-6.3</b>  | <b>BK25/3-PKZO-E</b> |
| 3                    | 3     | 7½    | 10    | 6.3 – 11          | 140                    | 65   | 65                           | 50                           | <b>PKZM0-10</b>   | <b>BK25/3-PKZO-E</b> |
| 3                    | 3     | 7½    | –     | 9 – 12            | 168                    | 65   | 65                           | –                            | <b>PKZM0-12</b>   | <b>BK25/3-PKZO-E</b> |
| 3                    | 5     | 10    | –     | 10 – 16           | 224                    | 42   | 42                           | –                            | <b>PKZM0-16</b>   | <b>BK25/3-PKZO-E</b> |
| 5                    | –     | –     | –     | 16 – 20           | 280                    | 18   | 18                           | –                            | <b>PKZM0-20</b>   | <b>BK25/3-PKZO-E</b> |
| –                    | 7½    | 15    | –     | 20 – 25           | 350                    | 18   | 18                           | –                            | <b>PKZM0-25</b>   | <b>BK25/3-PKZO-E</b> |
| 7½                   | 10    | 20    | –     | 24 – 32           | 448                    | 18   | 18                           | –                            | <b>PKZM0-32</b>   | <b>BK25/3-PKZO-E</b> |
| 3                    | 5     | 10    | 10    | 10 – 16           | 224                    | 65   | 65                           | 25                           | <b>PKZM4-16</b>   | <b>BK50/3-PKZ4-E</b> |
| 5                    | 7½    | 15    | 20    | 16 – 27           | 350                    | 65   | 65                           | 25                           | <b>PKZM4-25</b>   | <b>BK50/3-PKZ4-E</b> |
| 7½                   | 10    | 20    | 30    | 24 – 34           | 448                    | 65   | 65                           | 25                           | <b>PKZM4-32</b>   | <b>BK50/3-PKZ4-E</b> |
| 10                   | –     | 30    | 30    | 32 – 40           | 560                    | 65   | 65                           | 25                           | <b>PKZM4-40</b>   | <b>BK50/3-PKZ4-E</b> |
| –                    | 15    | 30    | –     | 40 – 52           | 700                    | 65   | 65                           | –                            | <b>PKZM4-50</b>   | <b>BK50/3-PKZ4-E</b> |
| –                    | –     | 40    | –     | 50 – 56           | 812                    | 65   | 65                           | –                            | <b>PKZM4-58</b>   | <b>BK50/3-PKZ4-E</b> |
| –                    | –     | 40    | –     | 52 – 58           | 882                    | 65   | –                            | –                            | <b>PKZM4-63</b>   | <b>BK50/3-PKZ4-E</b> |

### Notes

<sup>1)</sup> Calculate motor power in this range according to the rated current. Stated values to NEC Table 430 -150

<sup>2)</sup> Suitable for networks with grounded star-point

# 1.3

## Motor-protective circuit-breakers PKZM01, PKZM0, PKZM4, PKE Motor-protective circuit-breaker

### 1 Technical data

#### PKZM, PKE

|  |                                    | PKZM01...  | PKZM0-... <sup>1)</sup>                          |
|--|------------------------------------|--|--|
| <b>General</b>   |                                    |  |  |
| Standards  |                                    | IEC/EN 60947, VDE 0660, UL 508, CSA C 22.2 No. 14                              |  |
| Climatic proofing  |                                    | Damp heat, constant, to IEC 60068-2-78<br>Damp heat, cyclic, to IEC 60068-2-30 |  |
| Ambient temperature  | Storage                            | °C   | -25...80   |
|  | Open                               | °C   | -25...55   |
|  | Encapsulated                       | °C   | -25...40   |
| Built-in position  |                                    |  |  |
| Direction of incoming supply                                     |                                    | Any  | Any  |
| Degree of protection   | Device                             | IP20   | IP20   |
|  | Terminals                          | IP00   | IP00   |
| Contact protection to EN 50274                                   |                                    | Finger- and back-of-hand proof   |  |
| Shock resistance, half-sinusoidal shock, 10 ms to IEC 60068-2-27 |                                    | g  | 25   |
| Installation altitude  |                                    | m  | max. 2000  |
| Terminal capacity, screw terminals                               | Solid                              | mm <sup>2</sup>  | 1 x (1 - 6)<br>2 x (1 - 6)                       |
|  |                                    | mm <sup>2</sup>  | 1 x (1 - 6)<br>2 x (1 - 6)                       |
|  | Flexible with ferrule to DIN 46228 | mm <sup>2</sup>  | 1 x (1 - 6)<br>2 x (1 - 6)                       |
| Terminal capacity, spring-loaded terminals                       | Solid                              | mm <sup>2</sup>  | –  |
|  |                                    | mm <sup>2</sup>  | –  |
|  | Flexible with ferrule to DIN 46228 | mm <sup>2</sup>  | –  |
| Terminal screw tightening torque                                 | Main conductors                    | Nm   | 1.7  |
|  |                                    | Nm   | 1  |
|  | Auxiliary conductors               | Nm   | 1  |
| <b>Main contacts</b>   |                                    |  |  |
| Rated impulse withstand voltage                                  | $U_{imp}$                          | V AC   | 6000   |
| Overvoltage category/pollution degree                            |                                    |  | III/3  |
| Rated operational voltage  | $U_e$                              | V AC   | 690  |
| Rated uninterrupted current = rated operational current          | $I_u = I_e$                        | A  | 16 or current setting of the overcurrent release |
| Rated frequency  |                                    | Hz   | 40 - 60  |
| Heat dissipation (3 pole at operating temperature)               |                                    | W  | 6  |
| Lifespan, mechanical   | Operations                         | $\times 10^6$  | 0.05   |
| Lifespan, electrical (AC-3 at 400 V)                             | Operations                         | $\times 10^6$  | 0.05   |
| Maximum operating frequency                                      | Operations/h                       | Ops/h  | 25   |
| <b>Short-circuit rating</b>                                      |                                    |  |  |
| AC   |                                    |  | → Page 33  |
| DC   |                                    | kA   | 60   |
|  |                                    |  | → Page 32  |
|  |                                    |  | 60 (up to PKZM0-16)<br>40 (PKZM0-20 to PKZM0-32) |
| <b>Motor switching capacity</b>                                  |                                    |  |  |
| AC-3 up to 690 V   | A                                  |  | 16   |
| DC-5 (up to 250 V)   | A                                  |  | 16 (3 contacts in series)                        |
|  |                                    |  | 25 (3 contacts in series)                        |
| <b>Trip blocks</b>   |                                    |  |  |
| <b>Temperature compensation</b>                                  |                                    |  |  |
| To IEC/EN 60947, VDE 0660  | °C                                 |  | -5...40  |
| Operating range  | °C                                 |  | -25...55   |
| Temperature compensation residual error for $T > 40$ °C          | %/K                                |  | $\leq 0.25$                                      |
| Setting range of overload releases                               | $\times I_u$                       |  | 0.6 - 1  |
| Short-circuit releases tolerance                                 | %                                  |  | $\pm 20$   |
| Phase-failure sensitivity  |                                    |  | IEC/EN 60947-4-1,<br>VDE 0660 Part 102           |
|  |                                    |  | IEC/EN 60947-4-1,<br>VDE 0660 Part 102           |

**Notes** <sup>1)</sup> Tested according to IEC/EN 60947-1 (isolating characteristics) and IEC/EN 60947-2

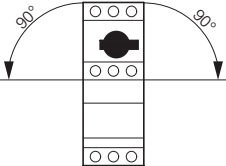
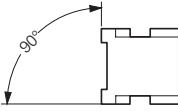
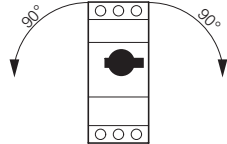
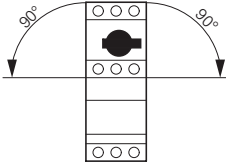
| PKM0-...  | PKZM0-...-T   | PKZM4   | PKE  |
|---|---|---|--|
| IEC/EN 60947, VDE 0660, UL 508, CSA C 22.2 No. 14                                 |   |   |  |
| Damp heat, constant, to IEC 60068-2-78  |   |   |  |
| Damp heat, cyclic, to IEC 60068-2-30  |   |   |  |
| -25...80  | -25...80  | -25...70  | -25...80   |
| -25...55  | -25...55  | -25...55  | -25...55   |
| -25...40  | -25...40  | -25...40  | -25...40   |
|  |  |  |  |
| Any   | Any   | Any   | Any  |
| IP20  | IP20  | IP20  | IP20   |
| IP00  | IP00  | IP00  | IP00   |
| Finger- and back-of-hand proof  |   |   |  |
| 25  | 25  | 15  | 25   |
| max. 2000   | max. 2000   | max. 2000   | max. 2000  |
| 1 x (1 - 6)   | 1 x (1 - 6)   | 1 x (1 - 50)  | 1 x (1 - 6)  |
| 2 x (1 - 6)   | 2 x (1 - 6)   | 2 x (1 - 35)  | 2 x (1 - 6)  |
| 1 x (1 - 6)   | 1 x (1 - 6)   | 1 x (1 - 35)  | 1 x (1 - 6)  |
| 2 x (1 - 6)   | 2 x (1 - 6)   | 2 x (1 - 35)  | 2 x (1 - 6)  |
| 18 - 10   | 18 - 10   | 14 - 2  | 18 - 10  |
| 1 x (1...2.5)   | -   | -   | 1 x (1...2.5)  |
| 2 x (1...2.5)   | -   | -   | 2 x (1...2.5)  |
| 1 x (1...2.5)   | -   | -   | 1 x (1...2.5)  |
| 2 x (1...2.5)   | -   | -   | 2 x (1...2.5)  |
| 18...14   | -   | -   | 18...14  |
| 1.7   | 1.7   | 3.3   | 1.7  |
| 1   | 1   | 1   | 1  |
| 6000  | 6000  | 6000  | 6000   |
| III/3   | III/3   | III/3   | III/3  |
| 690   | 690   | 690   | 690  |
| 32 or current setting of the overcurrent release                                  | 25 or current setting of the overcurrent release                                  | 65 Open<br>63 enclosed  | 32 A or set current of the overcurrent release                                     |
| 40 - 60   | 40 - 60   | 40 - 60   | 40 - 60  |
| 6   | 6   | 22  | 6  |
| 0.1   | 0.1   | 0.03  | 0.05   |
| 0.1   | 0.1   | 0.03  | 0.05   |
| 40  | 40  | 40  | 60   |
| → Page 32   | → Page 32   | → Page 33   | → Page 33  |
| 60 (up to PKM0-16)<br>40 (PKM0-20 to PKM0-32)                                     | 60 (up to PKZM0-16)<br>40 (PKZM0-20 to PKZM0-32)                                  | 60  | -  |
| 32  | 25  | 65  | 32   |
| 25 (3 contacts in series)   | 25 (3 contacts in series)   | 63 (3 contacts in series)   | -  |
| -5...40   | -5...40   | -5...40   | -5...40  |
| -25...55  | -25...55  | -25...55  | -25...55   |
| ≅ 0.25  | ≅ 0.25  | ≅ 0.25  |  |
|   | 0.6 - 1   | 0.6 - 1   | 0.25 - 1   |
| ± 20  | ± 20  | ± 20  | ± 20   |
| -   | IEC/EN 60947-1-1,<br>VDE 0660 Part 102  | IEC/EN 60947-4-1,<br>VDE 0660 Part 102  | Yes  |

# 1.3

## Motor-protective circuit-breakers PKZM01, PKZM0, PKZM4, PKE Auxiliary contacts

### 1 NHI...PKZ, AGM, U-PKZ, A-PKZ

|                                       |  |                   | NHI...PKZ0    | NHI-E-...PKZ0   | VHI...PKZ0 | AGM        |             |
|---------------------------------------|--|-------------------|---------------|---|------------|------------|-------------|
| <b>Auxiliary contacts</b>             |  |                   |               |   |            |            |             |
| Rated impulse withstand voltage       | $U_{imp}$  | V AC              | 6000          | 4000  | 4000       | 6000       |             |
| Overvoltage category/pollution degree |  |                   | III/3         | III/3   | III/3      | III/3      |             |
| Rated operating voltage               |  |                   |               |   |            |            |             |
|                                       | $U_e$  | V AC              | 500           | 440   | 440        | 500        |             |
|                                       | $U_e$  | V DC              | 250           | 250   | 250        | 250        |             |
| Safe isolation according to EN 61140  |  |                   |               |   |            |            |             |
|                                       |  | V AC              | 690           | 690   | 690        | 690        |             |
| Rated operational current             |  |                   |               |   |            |            |             |
| AC-15                                 |  |                   |               |   |            |            |             |
|                                       | 220 - 240 V  | $I_e$             | A             | 3.5   | 1          | 1          | 3.5         |
|                                       | 380 - 415 V  | $I_e$             | A             | 2   | –          | –          | 2           |
|                                       | 440 - 500 V  | $I_e$             | A             | 1   | –          | –          | 1           |
| DC-13 L/R $\leq$ 100 ms               |  |                   |               |   |            |            |             |
|                                       | 24 V   | $I_e$             | A             | 2   | 2          | 2          | 2           |
|                                       | 60 V   | $I_e$             | A             | 1.5   | –          | –          | 1.5         |
|                                       | 110 V  | $I_e$             | A             | 1   | –          | –          | 1           |
|                                       | 220 V  | $I_e$             | A             | 0.25  | –          | –          | 0.25        |
| Durability                            |  |                   |               |   |            |            |             |
|                                       | Lifespan, mechanical   | Operations        | $\times 10^6$ | > 0.1   | > 0.1      | > 0.1      | > 0.01      |
|                                       | Lifespan, electrical   | Operations        | $\times 10^6$ | > 0.05  | > 0.1      | > 0.1      | > 0.05      |
|                                       | Control circuit reliability (at $U_e = 24$ V DC, $U_{min} = 17$ V, $I_{min} = 5.4$ mA) | Fault probability | $\lambda$     | < $10^{-8}$ < 1 failure in $1 \times 10^8$ operations |            |            |             |
|                                       | Interlocked opposing contacts  |                   |               | Yes   | –          | –          | –           |
| Short-circuit rating without welding  |  |                   |               |   |            |            |             |
|                                       | Fuseless   |                   |               | FAZ-B4/1-HI   | –          | –          | FAZ-B4/1-HI |
|                                       | Fuse   | A gG/gL           | 10            | 10  | 10         | 10         | 10          |
| <b>Terminal capacity</b>              |  |                   |               |   |            |            |             |
|                                       | Solid or flexible conductor with ferrule   | mm <sup>2</sup>   | 0.75 - 2.5    | 0.75 - 1.5  | 0.75 - 1.5 | 0.75 - 2.5 |             |
|                                       | Solid or stranded  | AWG               | 18 - 14       | 18 - 16   | 18 - 16    | 18 - 14    |             |

### NHI...PKZ, AGM, U-PKZ, A-PKZ

|                                  |  |                 | Undervoltage release<br>U-PKZ...     | Shunt release<br>A-PKZ...            |          |
|----------------------------------|--|-----------------|--------------------------------------|--------------------------------------|----------|
| <b>General</b>                   |  |                 |                                      |                                      |          |
| Terminal capacity                |  |                 |                                      |                                      |          |
|                                  | Solid or flexible conductor with ferrule | mm <sup>2</sup> | 1 x (0.75 - 2.5)<br>2 x (0.75 - 2.5) | 1 x (0.75 - 2.5)<br>2 x (0.75 - 2.5) |          |
|                                  | Solid or stranded                        | AWG             | 1 x (18 - 14)<br>2 x (18 - 14)       | 1 x (18 - 14)<br>2 x (18 - 14)       |          |
| <b>Main contacts</b>             |  |                 |                                      |                                      |          |
|                                  | Rated operating voltage                  | $U_e$           | V AC                                 | 42 - 480                             | 42 - 480 |
|                                  | Rated operating voltage                  | $U_e$           | V DC                                 | 24 - 250                             | 24 - 250 |
| <b>Pick-up-/drop-out voltage</b> |  |                 |                                      |                                      |          |
|                                  | Pick-up voltage                          | $x U_s$         |                                      | 0.85 - 1.1                           |          |
|                                  | Drop-out voltage                         | $x U_s$         |                                      | 0.7 - 0.35                           |          |
| <b>Operating range</b>           |  |                 |                                      |                                      |          |
|                                  | AC voltage                               |                 | $x U_s$                              | 0.7...1.1                            |          |
|                                  | DC voltage (intermittent operation 5 s)  |                 | $x U_s$                              | 0.7...1.1                            |          |
| <b>Power consumption</b>         |  |                 |                                      |                                      |          |
| AC voltage                       |  |                 |                                      |                                      |          |
|                                  | AC pick-up rating                        | Pick-up         | VA                                   | 5                                    |          |
|                                  | AC consumption when closed               | Holding         | VA                                   | 3                                    |          |
| DC voltage                       |  |                 |                                      |                                      |          |
|                                  | DC pick-up rating                        | Pick-up         | W                                    | –                                    |          |
|                                  | DC consumption when closed               | Holding         | W                                    | –                                    |          |

## Dimensions

### Motor-protective circuit-breaker

PKZM01 ...

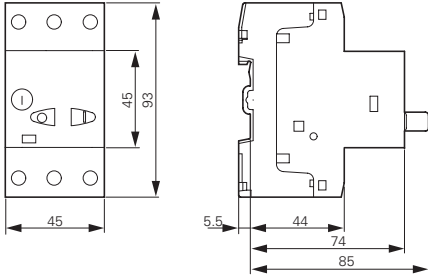

### Motor-protective circuit-breaker Transformer-protective circuit-breakers Motor-protective circuit-breaker with standard auxiliary contacts

PKZM0...(+NHI-E...-PKZ0)  
PKZM0...-T(+NHI-E...-PKZ0)  
PKM0...(+NHI-E...-PKZ0)

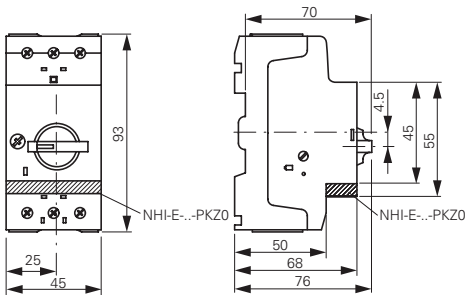

### Motor-protective circuit-breakers with lockable rotary handles

PKZM0...+AK-PKZ0

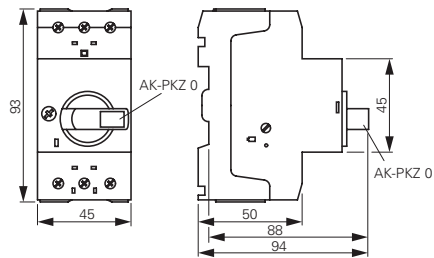

### Current limiters

CL-PKZ...

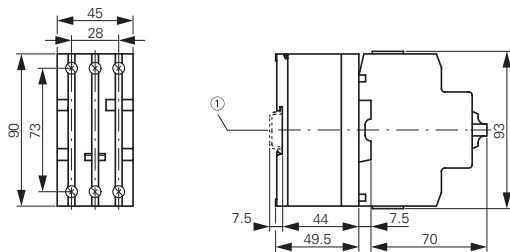

① Top-hat rail IEC/EN 60715

### Motor-protective circuit-breakers with early-make auxiliary contacts

PKZM0...+VHI...-PKZ0

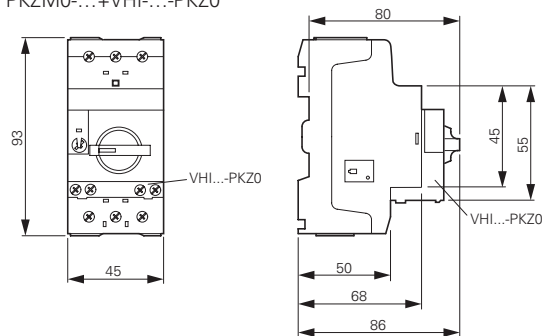

### Standard auxiliary contacts

NHI...-PKZ0

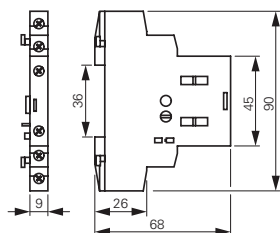

### Trip indicators

AGM2...-PKZ0

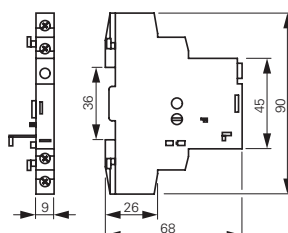

### Shunt release Undervoltage release

A-PKZ0...

U-PKZ0...

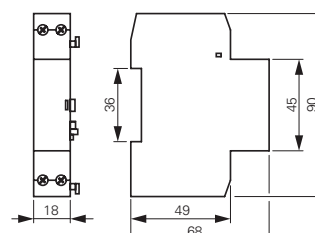



# 1.3

## Motor-protective circuit-breakers PKZM01, PKZM0, PKZM4, PKE

### Busbar adapters

1

**BBA0-25**  
**BBA0-25/2TS**  
**BBA0/2TS-L**  
**BBA0-32**  
**BBA0-32/2TS-C**  
**BBA0C-16**

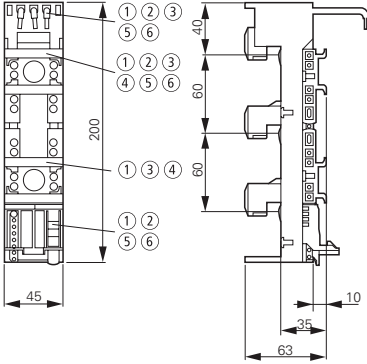

- ① BBA0-32/2TS-C
- ② BBA0-25/2TS
- ③ BBA0C-16
- ④ BBA0/2TS-L
- ⑤ BBA0-25
- ⑥ BBA0-32

**BBA2-63**  
**BBA2-63/2TS**

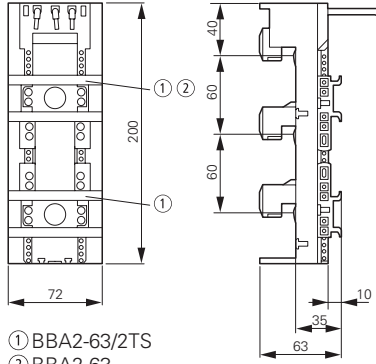

- ① BBA2-63/2TS
- ② BBA2-63

**BBA4/2TS-L**  
**BBA4L-63**

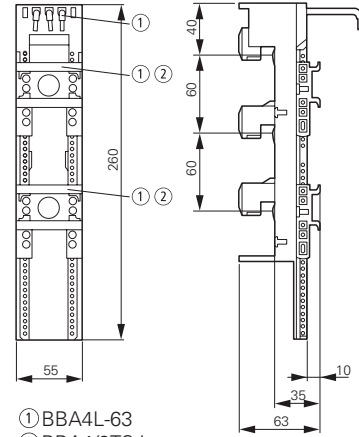

- ① BBA4L-63
- ② BBA4/2TS-L

**BBA4-63**

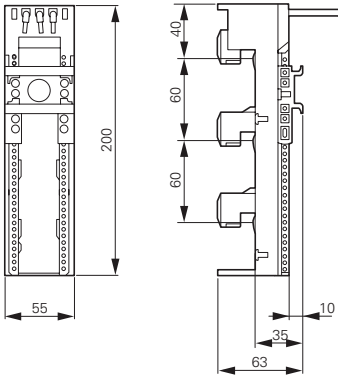

**BBA2-80/2TS-S**

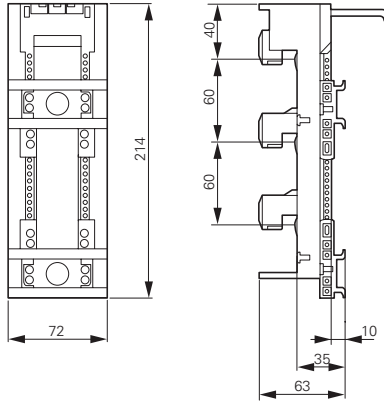

**BBA2L-63**

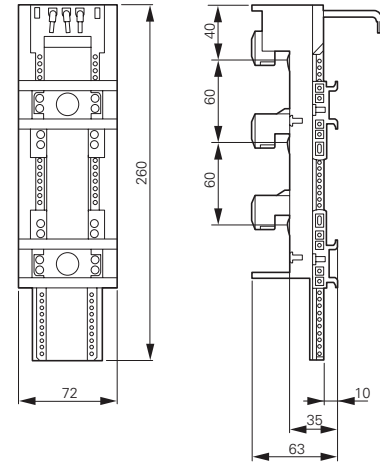

**BBA0L-25**  
**BBA0L-32**

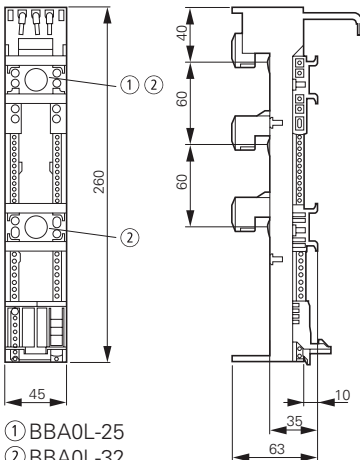

- ① BBA0L-25
- ② BBA0L-32

**BBA0K-32**

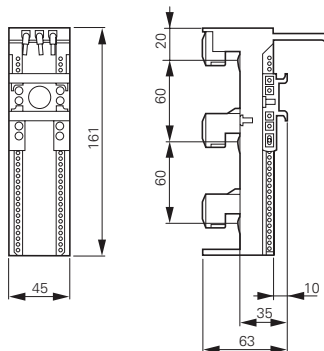

**PKZM0-XC45L**  
**PKZM0-XC45L-2**

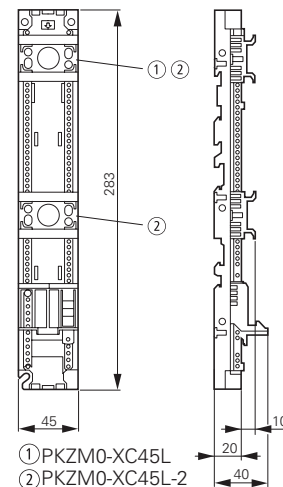

- ① PKZM0-XC45L
- ② PKZM0-XC45L-2

**Insulated enclosures for surface mounting**

CI-PKZ0-M

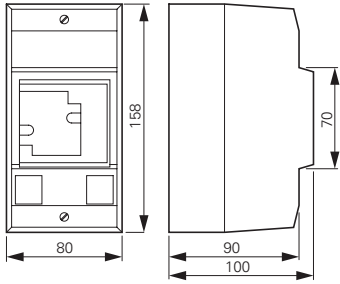

CI-PKZ10G...M

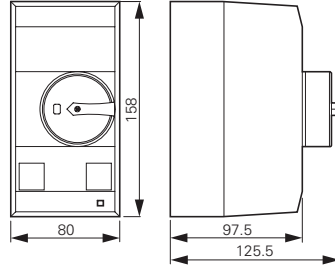

CI-PKZ0...M  
+ SVB-PKZ0-CI

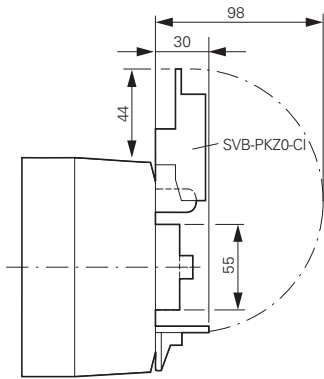

Drilling dimensions  
CI-PKZ0...M

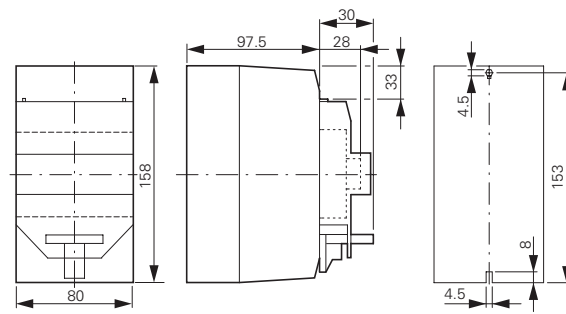

CI-K2-PKZ0

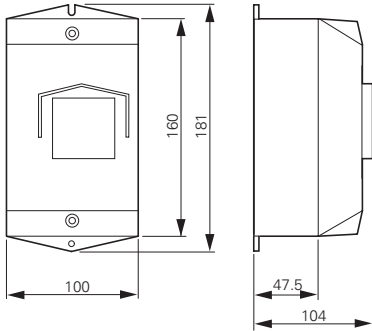

CI-K2-PKZ0G(R)(V)

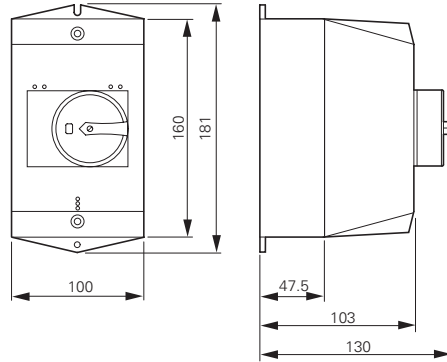

CI-K2-PKZ0-G(R)(V)  
+ SVB-PKZ0-CI

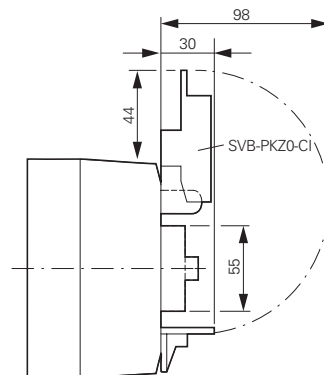

Drilling dimensions  
CI-K2-PKZ0...

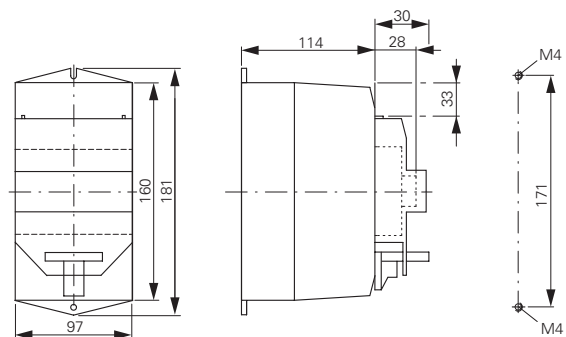

# 1.3

## Motor-protective circuit-breakers PKZM01, PKZM0, PKZM4, PKE Accessories

### Door coupling handles

PKZ0-X(R)H...

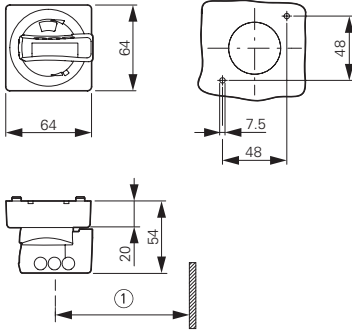

Mounting depth: 100 to 240 mm  
from the top edge of the top-hat rail  
to the front edge of the cabinet  
door/cover  
Distance between switch axis and  
cover hinge: at least 100 mm

① At least 100 mm from cover hinge

### Insulated enclosures for flush mounting

E-PKZ0 E-PKZ0-G...

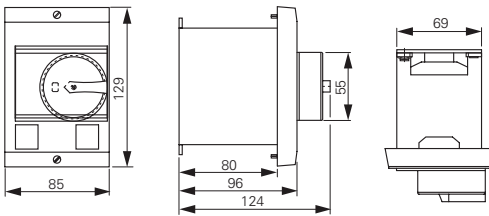

### Mounting aperture E-PKZ0...

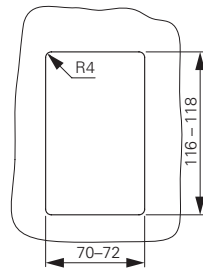

E-PKZ0-G... + SVB-PKZ0-E

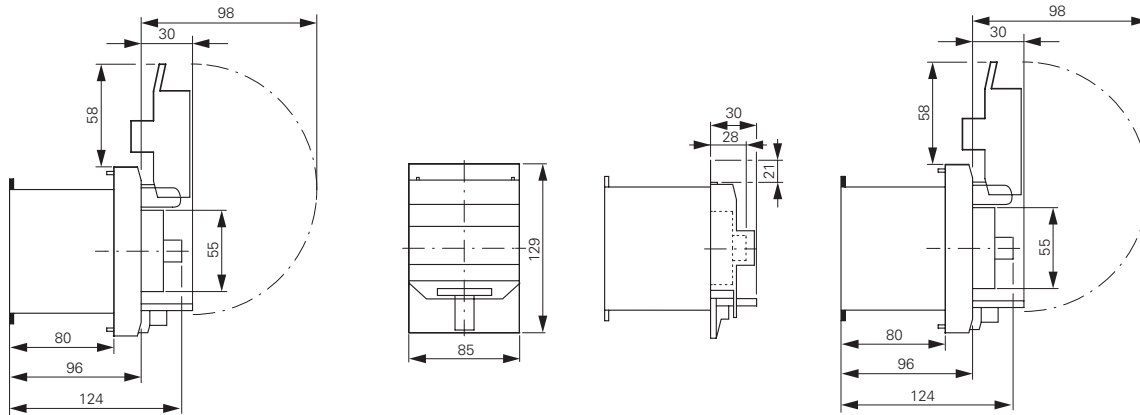

### Insulated enclosures for surface mounting

CI23E...

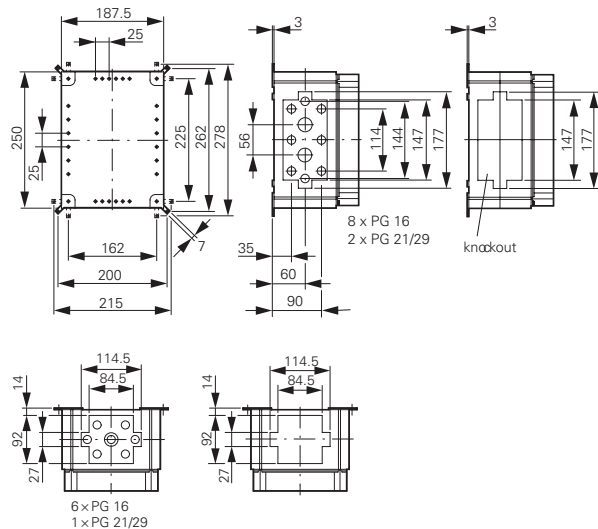

### Mounting plates

M3-CI23

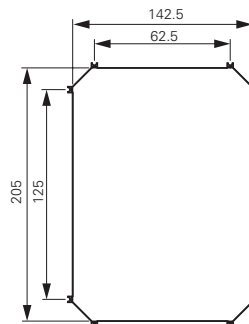

### Insulated enclosures for surface mounting

CI-PKZ01  
CI-PKZ01-G

CI-PKZ01-PVT  
CI-PKZ01-PVS

CI-PKZ01-SVB  
CI-PKZ01-SVB-V

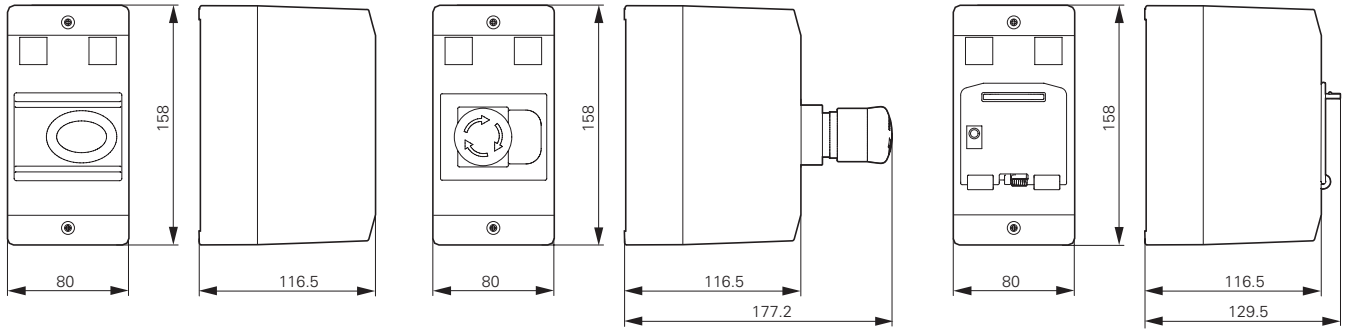

### Insulated enclosures for flush mounting

E-PKZ01  
E-PKZ01-G

E-PKZ01-PVT  
E-PKZ01-PVS

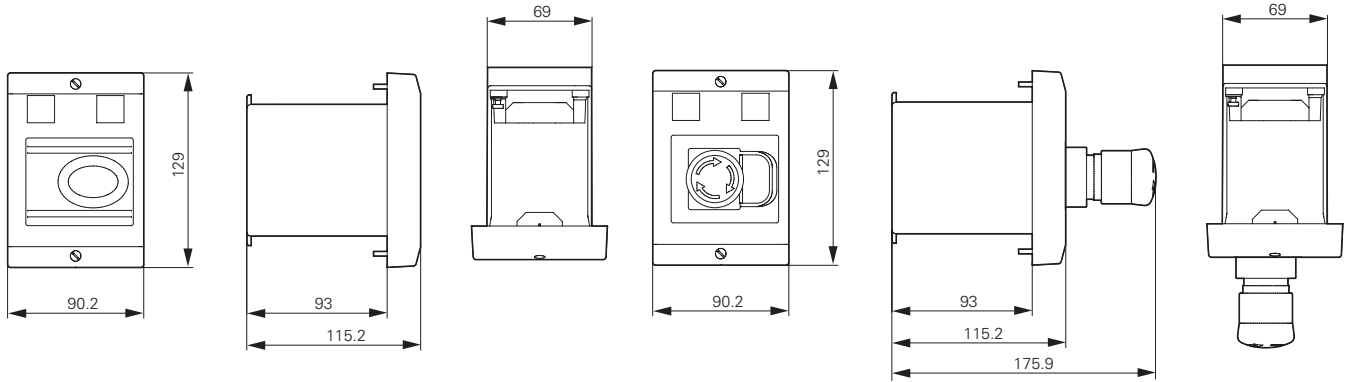

E-PKZ01-SVB  
E-PKZ01-SVB-V

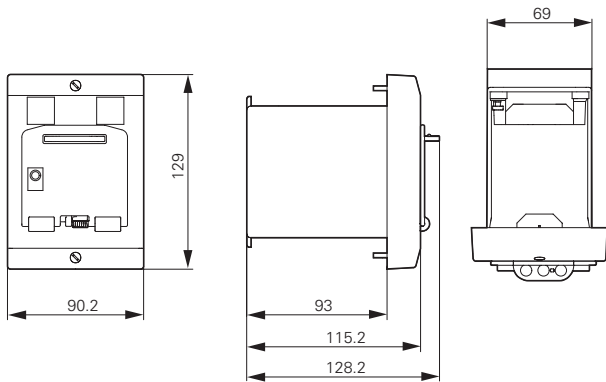

# 1.3

## Motor-protective circuit-breakers PKZM01, PKZM0, PKZM4, PKE

### Accessories

#### Motor-protective circuit-breaker

PKZM4-...

1

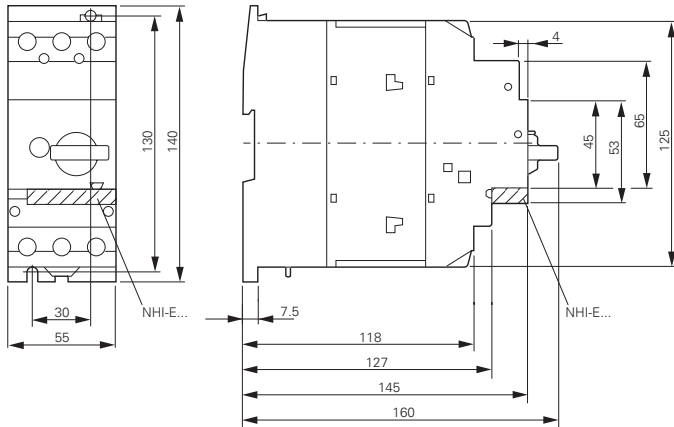

#### Standard auxiliary contacts

NHI...-PKZ...

NHI...-PKZ0

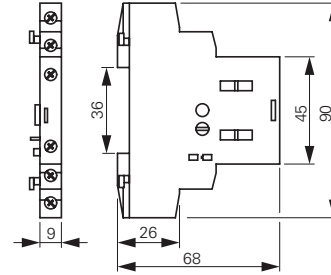

#### Motor-protective circuit-breakers with lockable cover

PKZM4-... +AK-PKZ0

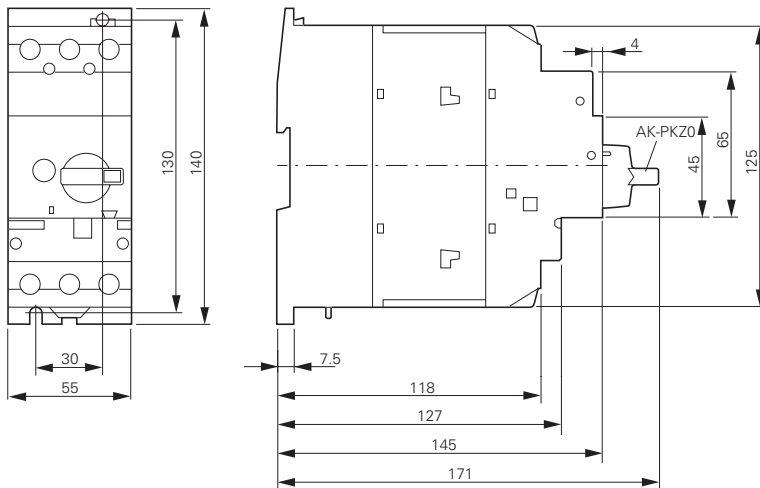

#### Trip indicators

AGM2...-PKZ...

AGM2...-PKZ0

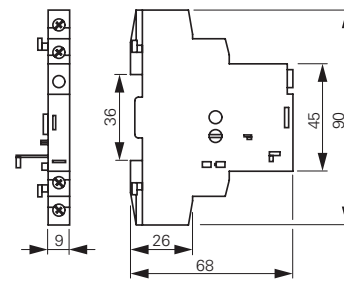

#### PKE Motor-protective circuit-breakers

PKE12, PKE32

PKE65

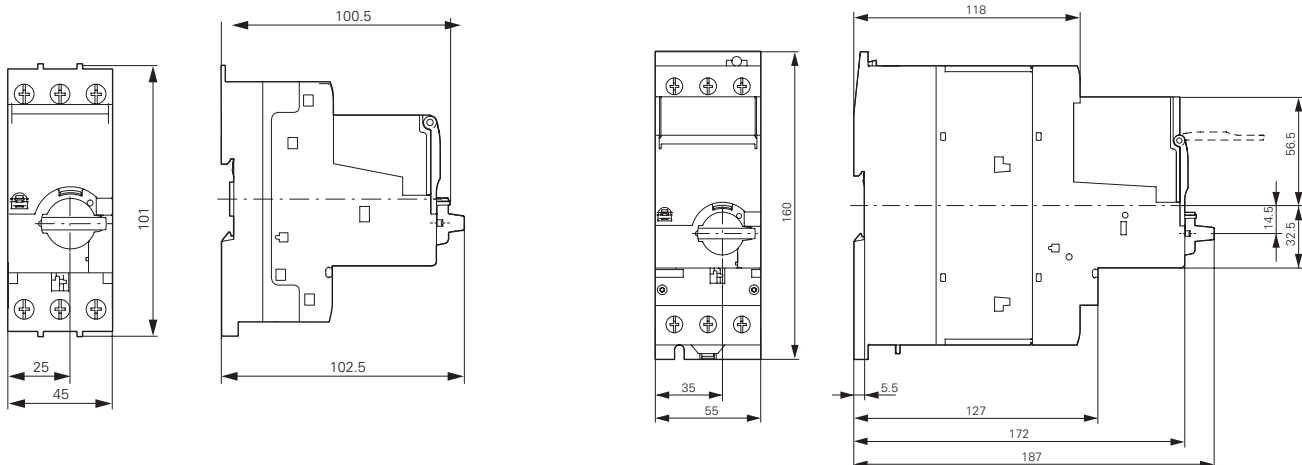

### Three-phase commoning links

B3.0/4-PKZ4

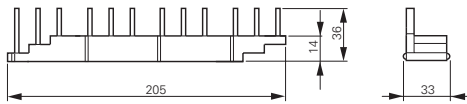

B3.2/4-PKZ4

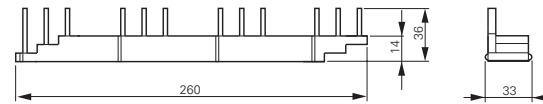

B3.0/3-PKZ4

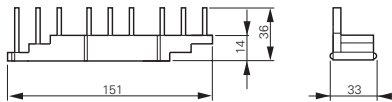

B3.2/2-PKZ4

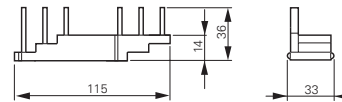

B3.0/2-PKZ4

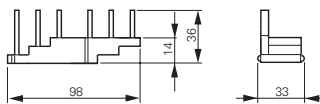

B3.0/3-PKZ4

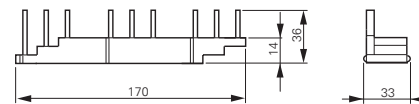

B3.1/4-PKZ4

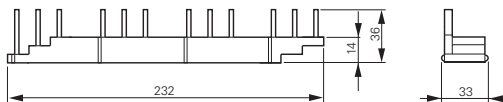

B3.1/2-PKZ4

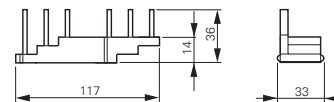

### Three-phase commoning links

B3.0/4-PKZ0

B3.0/2-PKZ0

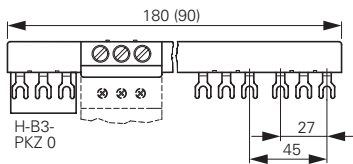

### Three-phase commoning links

B3.2/4-PKZ0

B3.2/2-PKZ0

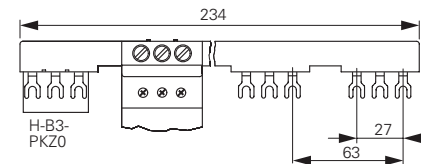

### Three-phase commoning links

B3.1/5-PKZ0

B3.1/3-PKZ0

B3.1/4-PKZ0

B3.1/2-PKZ0

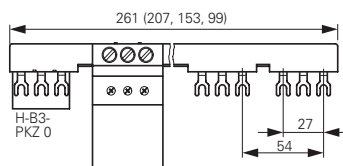

### Incoming terminals

BK25/3-PKZ0

Overlapping mounting to extend the three-phase commoning link

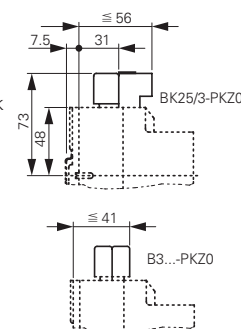

### Motor plug DILM12-XMCP/T

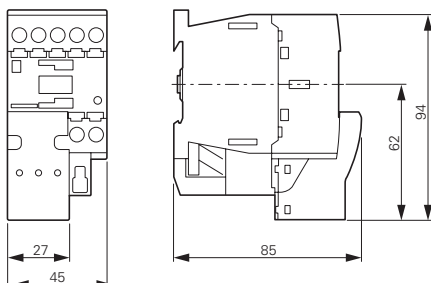

# 1.3

## Motor-protective circuit-breakers PKZM01, PKZM0, PKZM4, PKE Accessories

### 1 Insulated enclosures for surface mounting

CI-K4-PKZ4-G(R)  
+SVB-PKZ4-CI

CI-K4-PKZ4-G

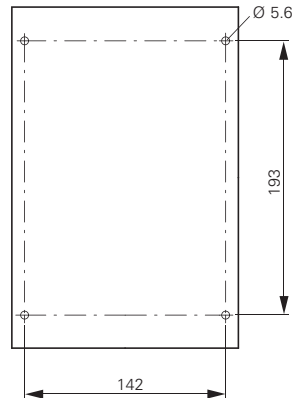
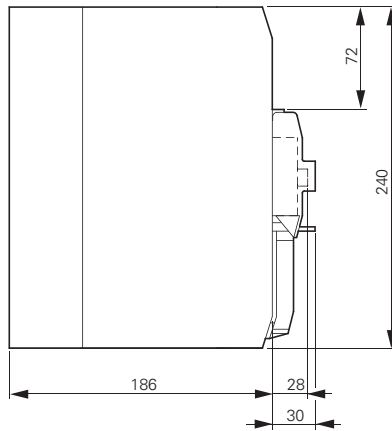
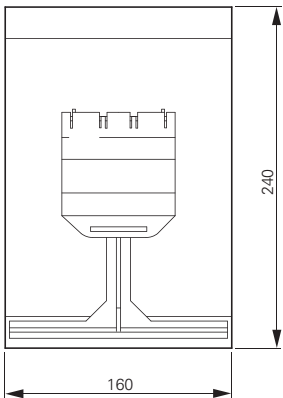
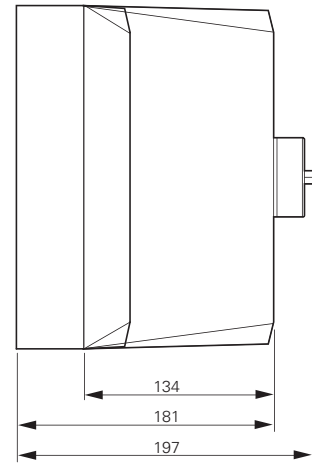
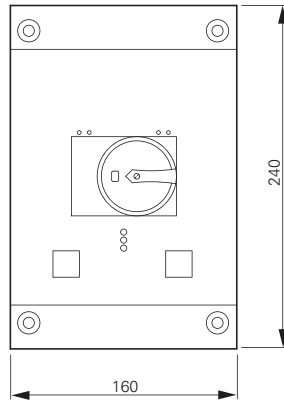
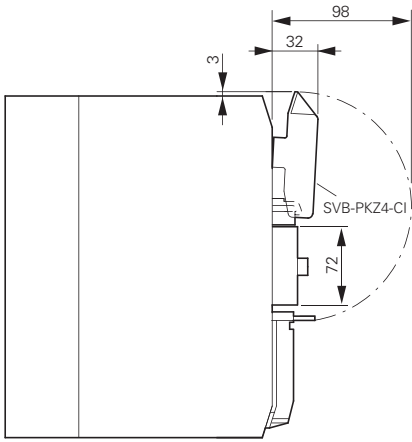

Drilling dimensions  
CI-K4-PKZ4-G(R)

## Description

### P-SOL, PKZ-SOL, SOL

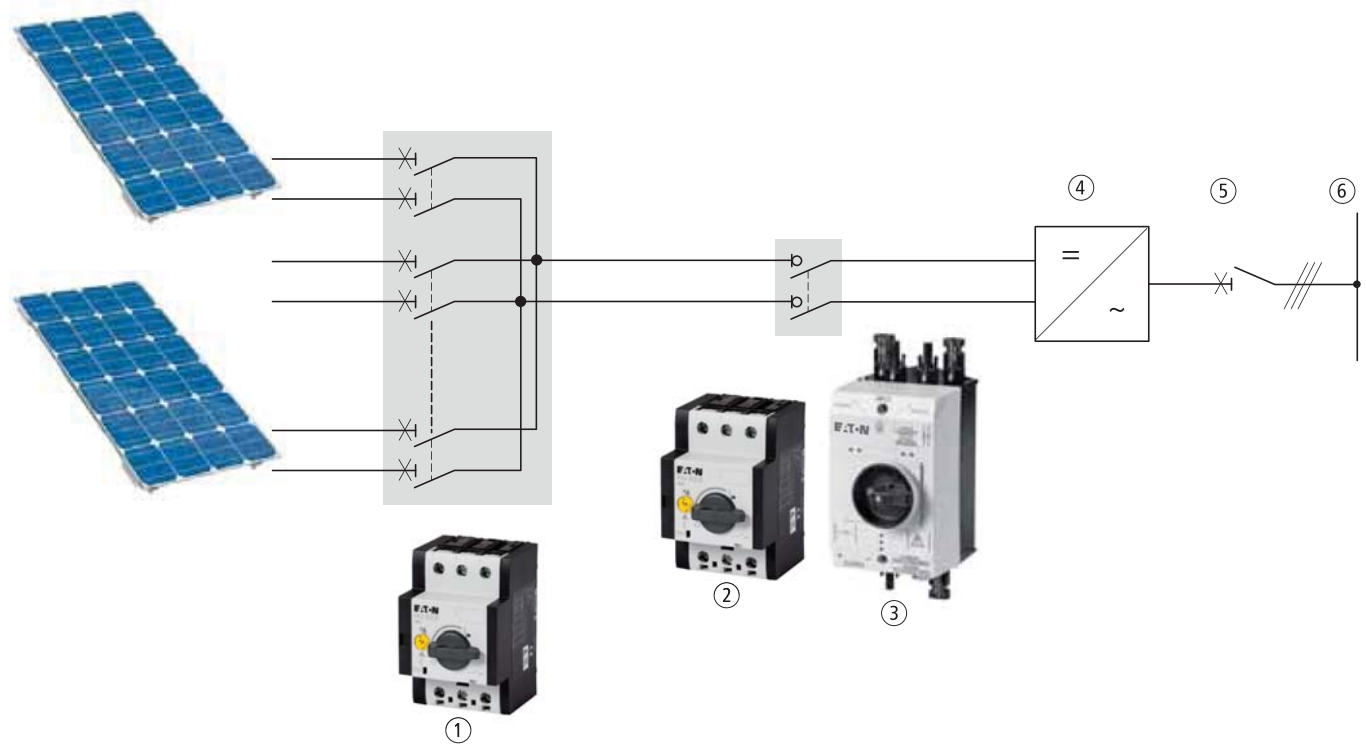

- ① DC string circuit-breaker PKZ-SOL
- ② DC switch-disconnector P-SOL
- ③ Ready-to-install DC switch-disconnector SOL
- ④ Inverter module
- ⑤ AC main switch
- ⑥ Network

### Photovoltaics description

Photovoltaic systems convert sunlight directly into electrical energy using solar cells. Photovoltaics represent a renewable source of energy that can be used on private and public buildings, as well as in large-scale power stations. These systems can be independent from the power grid or can be connected to it. Photovoltaic systems that are connected to the grid feed the generated power directly into the mains network. This eliminates the need for temporary storage. These systems consist of solar cells, one or more inverters, and a protective device for automatic cutoff in the event of a grid fault. Because of this, photovoltaic systems that are connected to the grid require extremely reliable and safe individual components.

### Features

#### DC string circuit-breakers

- Protect PV modules from fault currents, prevent (in larger systems, for instance) intact modules from feeding power back into a module with a short-circuit.
- Are ready for operation immediately after tripping and after the trip cause has been fixed.
- Open and for installation in customized generator terminal boxes.
- Tripping currents are adjustable within a wide range of limits.
- Optional shunt releases A-PKZO and undervoltage releases U-PKZO enable remote shutdown, e.g for the fire department. Optional auxiliary contact NHIE-PKZO signals switching state.
- When installed in an enclosure, suitable for voltages of up to 900 VDC.

#### DC switch-disconnectors

- Required, according to standard VDE 0100-712 (June 2006), between the PV module and inverter.
- Enclosed and open (for installation in enclosure) switch-disconnectors for voltages of up to 1,000 VDC.
- Usable as a separate switching point as required in VDI Guideline VDI 6012, e.g. by de-energizing an inverter in a completely safe manner.

- Two-pole switching, making it suitable for non-earthed systems as well.
- TÜV-certified.
- Open switch-disconnectors P-SOL are designed for installation in customer-specific enclosures or inverters.
- Mounting on 35 mm top-hat rails, their terminals enable a connection to all popular cable types.
- Separate rotary handles and shaft extensions allow for flexible installation.
- An auxiliary switching block can be mounted in order to provide switching state feedback.
- A shunt release or undervoltage release is available for remote tripping.
- Switch-disconnectors SOL with enclosure are ready for installation. Models for 2 and 4 or 4 and 8 strings and for the most popular connector types, such as MC3, MC4, and metric screw connectors, allow for easy integration into various system concepts.
- Enclosure provides degree of protection IP65, making outdoor mounting possible.
- Lockable mechanism provides safety when maintenance is required.
- Pressure-equalizing element prevents the formation of condensed water, preventing failures caused by voltage sparkovers



















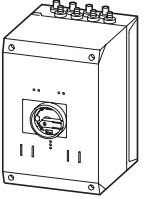

# 1.3

## DC string circuit-breakers, DC switch-disconnectors

DC switch-disconnectors, ready to install

### 1 Ordering

#### DC switch-disconnector, ready-to-install

| Inputs<br>Number of strings  | Connection type | Outputs             |                 | Max. rated operational current<br>DC-21A<br>$I_e$<br>A | Part no.<br>Article no. | Price<br>See price list     | Std. pack   |
|--|-----------------|---------------------|-----------------|--|-------------------------|-----------------------------|---|
|  |                 | Number of strings   | Connection type |  |                         |                             |   |
| <b>Rated operational voltage <math>U_e</math> 1000 V</b><br><b>Degree of protection IP65</b><br><b>Protection class 2</b><br><b>2 pole</b> |                 |                     |                 |  |                         |                             |   |
|    | 2               | MC3                 | 1               | MC3  | 20                      | <b>SOL20/2MC3</b><br>120913 | 1 off       |
|  | 4               | MC3                 | 1               | MC3  | 20                      | <b>SOL20/4MC3</b><br>120914 | 1 off       |
|  | 2               | MC4                 | 1               | MC4  | 20                      | <b>SOL20/2MC4</b><br>120915 | 1 off       |
|  | 4               | MC4                 | 1               | MC4  | 20                      | <b>SOL20/4MC4</b><br>120916 | 1 off       |
|   | 2               | Screw connector M12 | 1               | Screw connector M16                                    | 20                      | <b>SOL20/2MV</b><br>120919  | 1 off       |
|  | 2               | MC3                 | 1               | MC3  | 30                      | <b>SOL30/2MC3</b><br>120920 | 1 off       |
|  | 4               | MC3                 | 1               | MC3  | 30                      | <b>SOL30/4MC3</b><br>120921 | 1 off     |
|  | 2               | MC4                 | 1               | MC4  | 30                      | <b>SOL30/2MC4</b><br>120922 | 1 off   |
|    | 4               | MC4                 | 1               | MC4  | 30                      | <b>SOL30/4MC4</b><br>120923 | 1 off   |
|  | 2               | Screw connector M12 | 1               | Screw connector M16                                    | 30                      | <b>SOL30/2MV</b><br>120926  | 1 off   |
|  | 4               | MC3                 | 1               | Screw connector M20                                    | 63                      | <b>SOL60/4MC3</b><br>120927 | 1 off   |
|  | 8               | MC3                 | 1               | Screw connector M20                                    | 63                      | <b>SOL60/8MC3</b><br>120928 | 1 off   |
|  | 4               | MC4                 | 1               | Screw connector M20                                    | 63                      | <b>SOL60/4MC4</b><br>120929 | 1 off   |
|  | 8               | MC4                 | 1               | Screw connector M20                                    | 63                      | <b>SOL60/8MC4</b><br>120930 | 1 off   |
|  | 4               | Screw connector M12 | 1               | Screw connector M20                                    | 63                      | <b>SOL60/4MV</b><br>120933  | 1 off   |

#### Information relevant for export to North America



NA Certification Request filed for UL and CSA

**P-SOL, PKZ-SOL**

Max. rated operational current  
DC-21A

Permissible solar module  
short-circuit currents

**Part no.**  
Article no.

**Price**  
See price list

Std. pack

$I_e$   
A



**DC switch-disconnector, open**  
**Rated operating voltage  $U_e$  1000 V**  
**Protection class II**  
**2 pole**

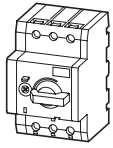

20

**P-SOL20**  
120934

1 off

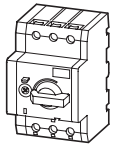

30

**P-SOL30**  
120935

1 off

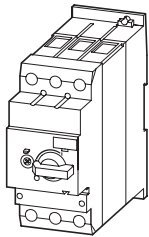

63

**P-SOL60**  
120936

1 off

**DC string circuit-breakers**  
**Rated operating voltage  $U_e$  900 V**  
**Protection class II**  
**2 pole**

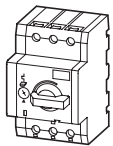

12

5 - 9

**PKZ-SOL12**  
120937

1 off

20

9 - 15

**PKZ-SOL20**  
120938

1 off

30

15 - 22

**PKZ-SOL30**  
120939

1 off

40

22 - 30

**PKZ-SOL40<sup>1)</sup>**  
120940

1 off

50

29 - 38

**PKZ-SOL50<sup>1)</sup>**  
120941

1 off

60

38 - 47

**PKZ-SOL60<sup>1)</sup>**  
120942

1 off

**Notes**

<sup>1)</sup> Availability from November 2010

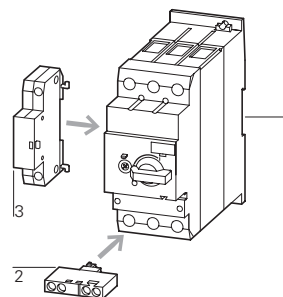
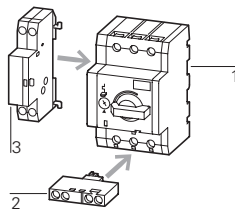

**Accessories**

2 Auxiliary contacts NHI-E

**Page**

→ 10

3 Shunt releases A-PKZ0

→ 29

3 Undervoltage releases U-PKZ0

→ 29

**Information relevant for export to North America**



NA Certification Request filed for UL and CSA

# 1.3

## DC string circuit-breakers, DC switch-disconnectors

### 1 Engineering

#### P-SOL and PKZ-SOL wiring

##### Switch-disconnector P-SOL

Non-earthed grid

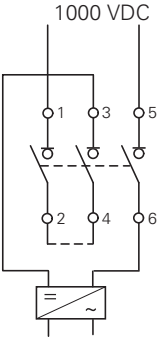

Earthed grid

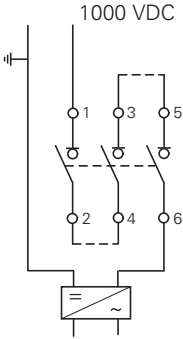

##### String circuit-breaker PKZ-SOL

Non-earthed grid

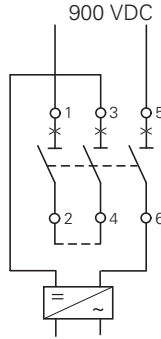

Earthed grid

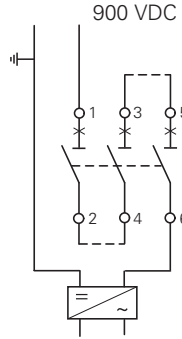

##### SOL internal circuit

SOL20/2MC3  
SOL20/2MC4  
SOL30/2MC3  
SOL30/2MC4

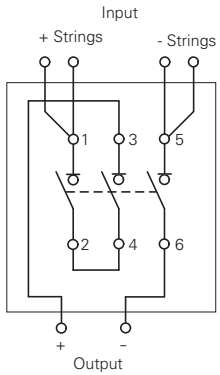

SOL20/2MV  
SOL30/2MV

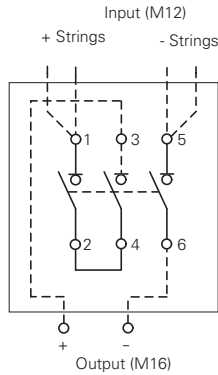

SOL20/4MC3  
SOL20/4MC4  
SOL30/4MC3  
SOL30/4MC4

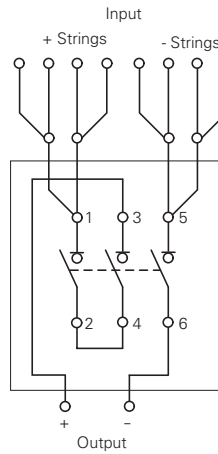

SOL60/4MC3  
SOL60/4MC4

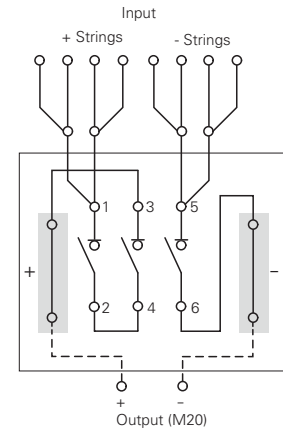

SOL60/4MV

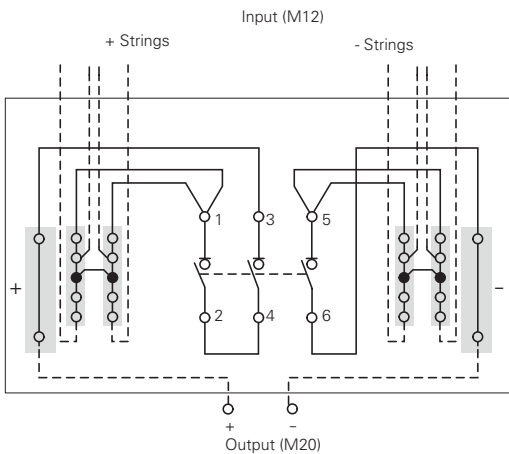

SOL60/8MC3  
SOL60/8MC4

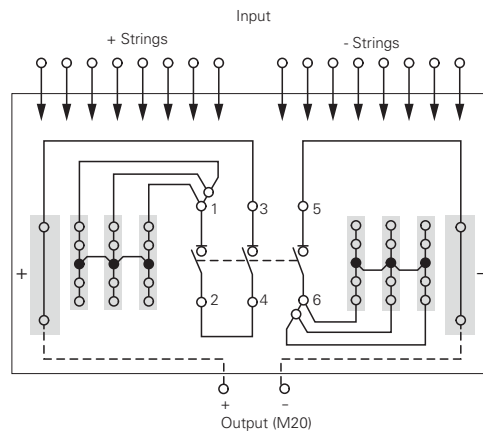

### Tripping characteristics

Tripping characteristics  
DC string circuit-breaker PKZ-SOL

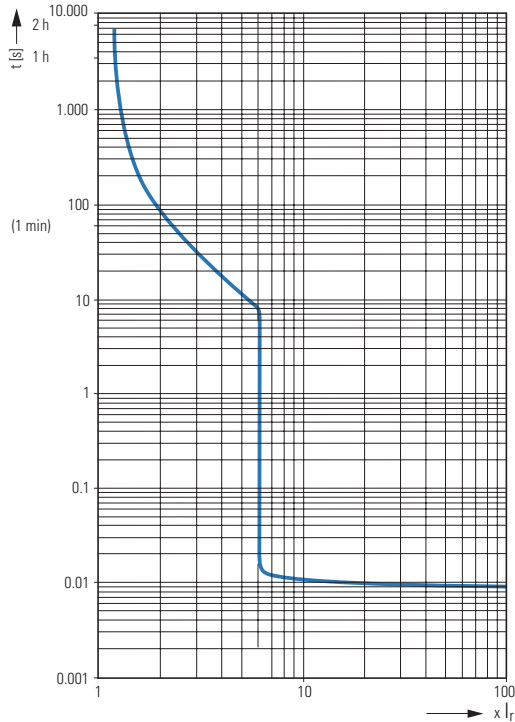

#### Characteristic curve set value - short-circuit current

As specified in the IEC 62548-1 draft for the protection of photovoltaic modules, the tripping current of the circuit-

breaker must lie between 1.4 and 2 times the value of the photovoltaic module's short-circuit current. Since only the current values of the installed overload release can be plotted on the setting scale for the

circuit-breaker<sup>1)</sup>, the correlation between the protective device's tripping current and the photovoltaic module's short-circuit current must be specified for each point of the scale in a suitable form.

Setting aid for string circuit-breaker PKZ-SOL

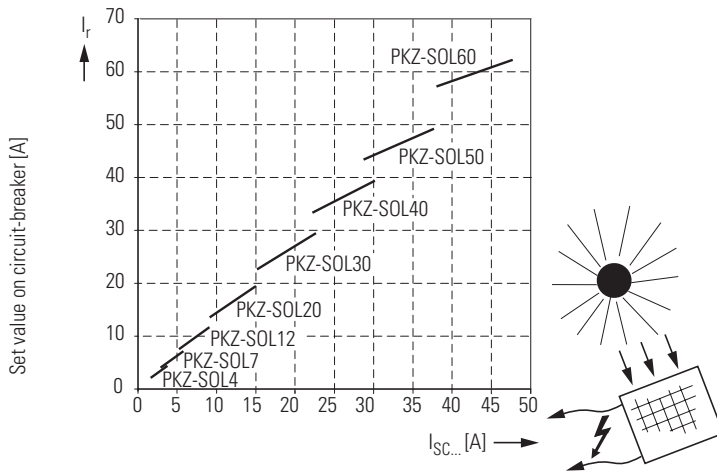

Short-circuit current in solar module [A]

<sup>1)</sup> Standard IEC/EN 60947-2 (Section 4.7.3) prohibits directly specifying the photovoltaic short-circuit current on the circuit-breaker's setting scale, meaning that only the current set value of the operating current can be plotted there.

# 1.3

## DC string circuit-breakers, DC switch-disconnectors

### DC switch-disconnectors

#### Technical data

#### 1 P-SOL, SOL

|   |              | SOL20  |             | SOL30       |  | SOL60 |             |
|---|--------------|--|-------------|-------------|--|-------|-------------|
| Rated operational current $I_e$ at DC-21A                       | A            | 20   | 30          | 63          |  |       |             |
| Number of poles   |              | 2  | 2           | 2           |  |       |             |
| Rated operational voltage $U_e$                                 | V DC         | 1000   | 1000        | 1000        |  |       |             |
| Isolating characteristics                                       |              | Yes  | Yes         | Yes         |  |       |             |
| Standards   |              | IEC/EN 60 947-3<br>UL 508, TÜV certificate                                       |             |             |  |       |             |
| Lifespan mechanical   | Operations   | 100,000  | 100,000     | 100,000     |  |       | 30,000      |
| Lifespan electrical   | Operations   | 100,000  | 100,000     | 100,000     |  |       | 30,000      |
| Max. operating frequency, mechanical                            | Ops/h        | 120  | 120         | 120         |  |       | 120         |
| Climatic proofing   |              | Damp heat, constant, to IEC 60 068-2-78<br>Damp heat, cyclic, to IEC 60 068-2-30 |             |             |  |       |             |
| Ambient temperature   | min./max. °C | -25 ... +60  | -25 ... +60 | -25 ... +60 |  |       | -25 ... +60 |
| Mounting position   |              | Any  | Any         | Any         |  |       | Any         |
| Degree of protection  | IP           | 65   | 65          | 65          |  |       | 65          |
| Dimensions  |              |  |             |             |  |       |             |
| Width   | mm           | 100  | 100         | 160         |  |       |             |
| Height  | mm           | 215  | 215         | 305         |  |       |             |
| Depth   | mm           | 130  | 130         | 210         |  |       |             |
| Weight  | kg           | 0.42   | 0.42        | 2.2         |  |       |             |
| Lockable in OFF position  |              | Yes  | Yes         | Yes         |  |       |             |
| Rated short-time withstand current $I_{cw}$ , 1 s to EN 60947-3 | kA           | 0.24   | 0.36        | 0.72        |  |       |             |
| Rated short-circuit making capacity to EN 60947-3               | $I_{cm}$ kA  | 0.32   | 0.32        | 0.6         |  |       |             |
| Internal resistance   | mΩ           | 8  | 7           | 4           |  |       |             |

#### P-SOL, SOL

|   |                 | P-SOL20  |             | P-SOL30                 |  | P-SOL60 |             |
|---|-----------------|--|-------------|-------------------------|--|---------|-------------|
| Rated operational current at DC-21A                             | $I_e$ A         | 20   | 30          | 63                      |  |         |             |
| Number of poles   |                 | 2  | 2           | 2                       |  |         |             |
| Rated operational voltage                                       | $U_e$ V DC      | 1000   | 1000        | 1000                    |  |         |             |
| Isolating characteristics                                       |                 | Yes  | Yes         | Yes                     |  |         |             |
| Standards   |                 | IEC/EN 60 947-3<br>UL 508, TÜV certificate                                       |             |                         |  |         |             |
| Lifespan mechanical   | Operations      | 100,000  | 100,000     | 100,000                 |  |         | 30,000      |
| Lifespan electrical   | Operations      | 100,000  | 100,000     | 100,000                 |  |         | 30,000      |
| Max. operating frequency, mechanical                            | Ops/h           | 120  | 120         | 120                     |  |         | 120         |
| Climatic proofing   |                 | Damp heat, constant, to IEC 60 068-2-78<br>Damp heat, cyclic, to IEC 60 068-2-30 |             |                         |  |         |             |
| Ambient temperature   |                 |  |             |                         |  |         |             |
| Open  | min./max. °C    | -25 ... +60  | -25 ... +60 | -25 ... +60             |  |         | -25 ... +60 |
| Mounting position   |                 | Any  | Any         | Any                     |  |         | Any         |
| Dimensions  |                 |  |             |                         |  |         |             |
| Width   | mm              | 58   | 58          | 55                      |  |         |             |
| Height  | mm              | 93   | 93          | 140                     |  |         |             |
| Depth   | mm              | 76   | 76          | 160                     |  |         |             |
| Mounting  |                 |  |             |                         |  |         |             |
| Top-hat rail  |                 | 35 mm  | 35 mm       | 35 mm                   |  |         |             |
| Screw mounting  |                 | –  | –           | 2 x M4 x 18<br>30 x 130 |  |         |             |
| Weight  | kg              | 0.32   | 0.32        | 1.25                    |  |         |             |
| Terminals   |                 |  |             |                         |  |         |             |
| Flexible with ferrule   | mm <sup>2</sup> | 1 x (1-6)  | 1 x (1-6)   | 1 x (1-35)              |  |         |             |
|   | mm <sup>2</sup> | 2 x (1-6)  | 2 x (1-6)   | 2 x (1-35)              |  |         |             |
| solid/stranded  | AWG             | 18 - 14  | 18 - 14     | 14 - 2                  |  |         |             |
| Rated short-time withstand current $I_{cw}$ , 1 s to EN 60947-3 | kA              | 0.24   | 0.36        | 0.72                    |  |         |             |
| Rated short-circuit making capacity to EN 60947-3               | $I_{cm}$ kA     | 0.32   | 0.32        | 0.6                     |  |         |             |
| Internal resistance   | mΩ              | 6  | 5           | 3                       |  |         |             |

### PKZ-SOL

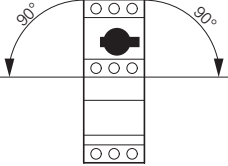
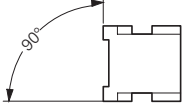
|  |                 |      | PKZ-SOL12   | PKZ-SOL20   | PKZ-SOL30   | PKZ-SOL40   | PKZ-SOL50               | PKZ-SOL60               |
|--|-----------------|------|---|-------------|-------------|---|-------------------------|-------------------------|
| Rated operational current at DC-21A/750VDC | $I_e$           | A    | 12  | 20          | 30          | 40  | 50                      | 63                      |
| Number of poles                            |                 |      | 2   | 2           | 2           | 2   | 2                       | 2                       |
| Rated operational voltage                  | $U_e$           | V DC | 900   | 900         | 900         | 900   | 900                     | 900                     |
| Thermal tripping                           |                 |      | 1.05 ... 1.3 x $I_e$  |             |             |   |                         |                         |
| Electromagnetic tripping                   |                 |      | 6 x $I_e$   |             |             |   |                         |                         |
| Standards                                  |                 |      | IEC/EN 60 947-2<br>UL 508, TÜV certificate  |             |             |   |                         |                         |
| Climatic proofing                          |                 |      | Damp heat, constant, to IEC 60 068-2-78<br>Damp heat, cyclic, to IEC 60 068-2-30  |             |             |   |                         |                         |
| Ambient temperature                        |                 |      |   |             |             |   |                         |                         |
| Open                                       | min./max.       | °C   | -25 ... +60   | -25 ... +60 | -25 ... +60 | -25 ... +60   | -25 ... +60             | -25 ... +60             |
| Mounting position                          |                 |      |  |             |             |  |                         |                         |
|  |                 |      | PKZ-SOL12<br>to PKZ-SOL60   |             |             | PKZ-SOL12<br>to PKZ-SOL30   |                         |                         |
| Dimensions                                 |                 |      |   |             |             |   |                         |                         |
| Width                                      | mm              |      | 58  | 58          | 58          | 55  | 55                      | 55                      |
| Height                                     | mm              |      | 93  | 93          | 93          | 140   | 140                     | 140                     |
| Depth                                      | mm              |      | 76  | 76          | 76          | 160   | 160                     | 160                     |
| Mounting                                   |                 |      |   |             |             |   |                         |                         |
| Top-hat rail                               |                 |      | 35 mm   | 35 mm       | 35 mm       | 35 mm   | 35 mm                   | 35 mm                   |
| Screw mounting                             |                 |      | –   | –           | –           | 2 x M4 x 18<br>30 x 130   | 2 x M4 x 18<br>30 x 130 | 2 x M4 x 18<br>30 x 130 |
| Weight                                     | kg              |      | 0.32  | 0.32        | 0.32        | 1.25  | 1.25                    | 1.25                    |
| Terminals                                  |                 |      |   |             |             |   |                         |                         |
| flexible with ferrule                      | mm <sup>2</sup> |      | 1 x (1-6)   | 1 x (1-6)   | 1 x (1-6)   | 1 x (1-35)  | 1 x (1-35)              | 1 x (1-35)              |
|  | mm <sup>2</sup> |      | 2 x (1-6)   | 2 x (1-6)   | 2 x (1-6)   | 2 x (1-35)  | 2 x (1-35)              | 2 x (1-35)              |
| solid/stranded                             | AWG             |      | 18 - 14   | 18 - 14     | 18 - 14     | 14 - 2  | 14 - 2                  | 14 - 2                  |
| Internal resistance                        | mΩ              |      | 31  | 12          | 7           | –   | –                       | –                       |

1

# 1.3

## DC switch-disconnectors, DC string circuit-breakers

DC string circuit-breakers, open

### 1 Dimensions

#### P-SOL, PKZ-SOL, SOL

P-SOL20  
P-SOL30  
PKZ-SOL12  
PKZ-SOL20  
PKZ-SOL30

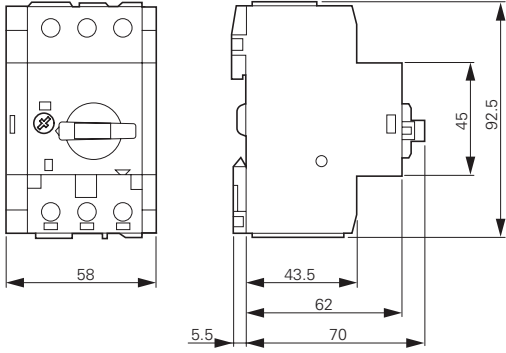

P-SOL60  
PKZ-SOL40  
PKZ-SOL50  
PKZ-SOL60

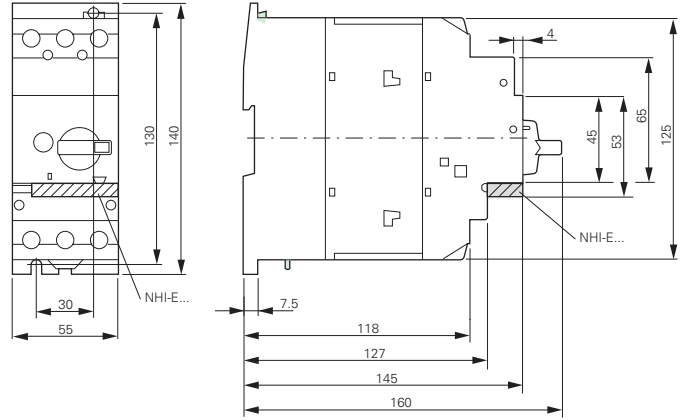

#### SOL

SOL20  
SOL30

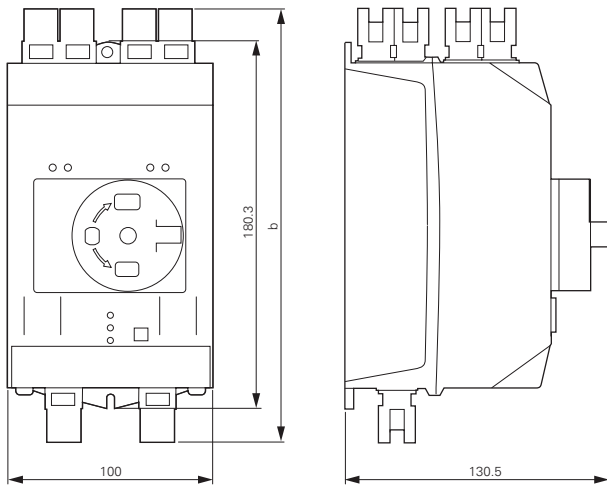

SOL60

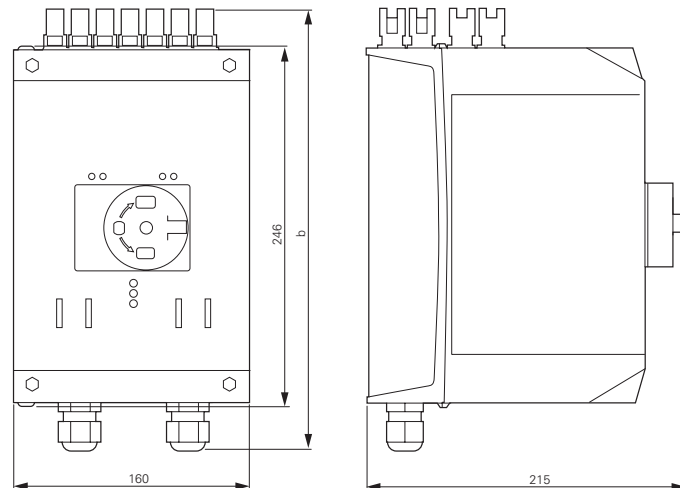

| Connection type | b mm |
|-----------------|------|
| MC3             | 195  |
| MC4             | 234  |
| MV              | 224  |

| Connection type | b mm |
|-----------------|------|
| MC3             | 275  |
| MC4             | 314  |
| MV              | 304  |



## Motor-starter combinations

Combining a motor protective circuit breaker or circuit breaker with a contactor results in a motor starter according to coordination type "1" or "2". Both types of coordination safely control short-circuit by switching it off. Coordination type "2" starters offer a high degree of operational continuity: after the cause of the short circuit has been removed, they can be switched back on immediately.

### Motor-starter combination - motor starter up to 1400 A

- Highest safety through proven combination in coordination type "1" or "2"
- Approved combinations for export to North America

### DOL starter and reversing starter MSC... – motor starter with motor-protective circuit-breaker PKZM0 up to 32A

- Mounted starters minimize wiring time
- Plug & Play with starters on busbar adapters
- Attractive design for high-quality installations
- Direct field bus connection through SmartWire-DT® communication system via plug-in type protective module

### DOL starter and reversing starter MSC-DE... – motor starter with electric motor-protective circuit-breaker PKE up to 32A

- Increased safety through separate contact systems between switching and safety devices
- Direct field bus connection through SmartWire-DT® communication system via plug-in type protective module
- Direct reading of motor current and state, transfer to subordinate control system through SmartWire-DT®

### Conditions for fulfilling type of coordination

- Coordination type: "1": Secure switching off of the entered short-circuit current  $I_q$
- No danger to personnel or installations in case of short-circuit
- For further operation without repair and partial renewal, switch does not need to be suitable
- Damage to the switch or individual components approved
- Coordination type: "2": Secure switching off of the entered short-circuit current  $I_q$
- No danger to personnel or installations in case of short-circuit
- Switch remains suitable for further operation
- No damage to switch, except to welds of protective contacts, when these can be easily separated without significant deformation







### Ordering

|                               |    |
|-------------------------------|----|
| Direct-on-line starters MSC-D |    |
| MSC-D complete units          | 2  |
| MSC-US complete units         | 4  |
| MSC-DEA complete units        | 6  |
| Modules PKZM0/PKZM4 + DILM    | 8  |
| Modules NZMN/NZMH + DILM      | 12 |
| Modules PKM0 + DILM + ZB      | 16 |
| Modules NZMN + DILM + ZB      | 16 |

### Ordering

|                            |    |
|----------------------------|----|
| Reversing starter MSC-R    |    |
| MSC-R complete units       | 18 |
| Modules PKZM0/PKZM4 + DILM | 20 |
| Modules NZMN/NZMH + DILM   | 22 |

### Ordering

|   |    |
|---|----|
| Starter on busbar adapter                   |    |
| DOL starter complete units MSC-D/BBA        | 24 |
| Reversing starters complete units MSC-R/BBA | 26 |

### Ordering

|   |    |
|---|----|
| Starter for North America               |    |
| Modules type F starter combinations     | 28 |
| Modules DILEM/DILM + ZE/ZB/Z5/ZW7       | 29 |
| Modules NZMH-...-CNA + DILM + ZB/Z5/ZW7 | 30 |

### System overview, description

|                                 |    |
|---------------------------------|----|
| Connection system SmartWire-DT® | 31 |
|---------------------------------|----|

### Ordering

|                                 |    |
|---------------------------------|----|
| Connection system SmartWire-DT® | 32 |
| Accessories                     | 33 |

### Engineering

|                                 |    |
|---------------------------------|----|
| Connection system SmartWire-DT® | 34 |
|---------------------------------|----|

### Technical data

|                                 |    |
|---------------------------------|----|
| Connection system SmartWire-DT® | 35 |
| DOL starters MSC-D, MSC-DE(A)   | 39 |
| Reversing starter MSC-R         | 39 |

### Dimensions

|                                 |    |
|---------------------------------|----|
| Direct-on-line starter MSC-D    |    |
| MSC-D complete units            | 39 |
| MSC-D/BBA complete units        | 39 |
| MSC-DE(A) complete units        | 40 |
| Reversing starter MSC-R         |    |
| MSC-R complete units            | 40 |
| MSC-R/BBA complete units        | 40 |
| Connection system SmartWire-DT® | 41 |

# 1.4

## Motor-starter combinations

Complete units

### Ordering

1

#### MSC-D: PKZM0, DILM

| Motor data              |                                 |                             |                          | Setting range    |                          | Motor starters<br>actuating voltage<br>230 V 50 Hz    | Part no.<br>Article no. | Price<br>See price<br>list | Std.<br>pack |
|-------------------------|---------------------------------|-----------------------------|--------------------------|------------------|--------------------------|---|-------------------------|----------------------------|--------------|
| Motor rating            | Rated<br>operational<br>current | Rated short-circuit current |                          | Overload<br>trip | Short-circuit<br>release |   |                         |                            |              |
| AC-3                    | AC-3                            | 380 - 415 V                 | 380 - 415 V              |                  |                          |   |                         |                            |              |
| 380 V<br>400 V<br>415 V | 400 V                           | Type "1"<br>coordination    | Type "2"<br>coordination |                  |                          |   |                         |                            |              |
| P<br>kW                 | $I_b$<br>A                      | $I_q$<br>kA                 | $I_q$<br>kA              | $I_r$<br>A       | $I_{rm}$<br>A            |   |                         |                            |              |
| 0.06                    | 0.21                            | 150                         | 50                       | 0.16 - 0.25      | 3.5                      | <b>MSC-D-0.25-M7(230V50Hz)<sup>1)</sup></b><br>281925 |                         | 1 off                      |              |
| 0.09                    | 0.31                            | 150                         | 50                       | 0.25 - 0.4       | 5.6                      | <b>MSC-D-0.4-M7(230V50Hz)<sup>1)</sup></b><br>281926  |                         | 1 off                      |              |
| 0.12<br>0.18            | 0.41<br>0.6                     | 150                         | 50                       | 0.4 - 0.63       | 8.82                     | <b>MSC-D-0.63-M7(230V50Hz)<sup>1)</sup></b><br>281927 |                         | 1 off                      |              |
| 0.25                    | 0.8                             | 150                         | 50                       | 0.63 - 1         | 14                       | <b>MSC-D-1-M7(230V50Hz)<sup>1)</sup></b><br>281929    |                         | 1 off                      |              |
| 0.37<br>0.55            | 1.1<br>1.5                      | 150                         | 50                       | 1 - 1.6          | 22.4                     | <b>MSC-D-1.6-M7(230V50Hz)<sup>1)</sup></b><br>283140  |                         | 1 off                      |              |
| 0.75                    | 1.9                             | 150                         | 50                       | 1.6 - 2.5        | 35                       | <b>MSC-D-2.5-M7(230V50Hz)<sup>1)</sup></b><br>283142  |                         | 1 off                      |              |
| 1.1<br>1.5              | 2.6<br>3.6                      | 150                         | 50                       | 2.5 - 4          | 56                       | <b>MSC-D-4-M7(230V50Hz)<sup>1)</sup></b><br>283143    |                         | 1 off                      |              |
| 2.2                     | 5                               | 150                         | 50                       | 4 - 6.3          | 88.2                     | <b>MSC-D-6.3-M7(230V50Hz)<sup>1)</sup></b><br>283145  |                         | 1 off                      |              |
| 3                       | 6.6                             | 150                         | –                        | 6.3 - 10         | 140                      | <b>MSC-D-10-M7(230V50Hz)</b><br>283146                |                         | 1 off                      |              |
| 4                       | 8.5                             | 150                         | –                        | 6.3 - 10         | 140                      | <b>MSC-D-10-M9(230V50Hz)</b><br>283147                |                         | 1 off                      |              |
| 5.5                     | 11.3                            | 50                          | –                        | 8 - 12           | 168                      | <b>MSC-D-12-M12(230V50Hz)</b><br>283148               |                         | 1 off                      |              |
| 7.5                     | 15.2                            | 50                          | –                        | 10 - 16          | 224                      | <b>MSC-D-16-M15(230V50Hz)</b><br>100414               |                         | 1 off                      |              |
| 3                       | 6.6                             | 50                          | 50                       | 6.3 - 10         | 140                      | <b>MSC-D-10-M17(230V50Hz)</b><br>101045               |                         | 1 off                      |              |
| 4                       | 8.5                             | 50                          | 50                       | 6.3 - 10         | 140                      | <b>MSC-D-10-M17(230V50Hz)</b><br>101045               |                         | 1 off                      |              |
| 5.5                     | 11.3                            | 50                          | 50                       | 8 - 12           | 168                      | <b>MSC-D-12-M17(230V50Hz)</b><br>101046               |                         | 1 off                      |              |
| 7.5                     | 15.2                            | 50                          | 50                       | 10 - 16          | 224                      | <b>MSC-D-16-M17(230V50Hz)<sup>1)</sup></b><br>283150  |                         | 1 off                      |              |
| 11                      | 21.7                            | 50                          | 50                       | 20 - 25          | 350                      | <b>MSC-D-25-M25(230V50Hz)<sup>1)</sup></b><br>283151  |                         | 1 off                      |              |
| 15                      | 29.3                            | 50                          | 50                       | 25 - 32          | 448                      | <b>MSC-D-32-M32(230V50Hz)<sup>1)</sup></b><br>283152  |                         | 1 off                      |              |

#### Complete units MSC-D

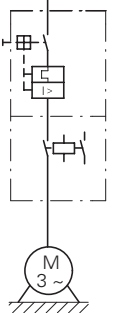
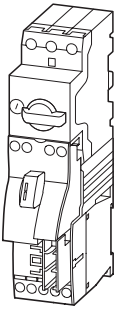

#### Complete units MSC-D

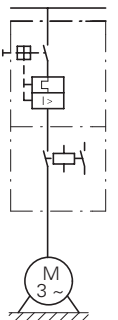
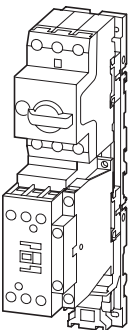

| Motor starters<br>actuating voltage<br>24 V DC      | Std.<br>pack               | Motor<br>protective<br>circuit breaker | Contactor      | DOL starter wiring<br>set | Notes   |                            |             |                      |               |                 |                         |                     |               |                            |                         |                  |                         |
|---|----------------------------|--|----------------|---------------------------|---|----------------------------|-------------|----------------------|---------------|-----------------|-------------------------|---------------------|---------------|----------------------------|-------------------------|------------------|-------------------------|
| Part no.<br>Article no.                             | Price<br>See price<br>list | Type                                   | Type           | Type                      |   |                            |             |                      |               |                 |                         |                     |               |                            |                         |                  |                         |
| <b>MSC-D-0.25-M7(24VDC)</b> <sup>1)</sup><br>283154 | 1 off                      | PKZM0-0,25                             | DILM7-10(...)  | PKZM0-XDM12               | <p>The DOL starters (complete devices) consist of a motor protective circuit breaker PKZM0 and a contactor DILM. With the adapterless top-hat rail mounting of starters up to 15 A, only the motor-protective circuit-breaker on the top-hat rail requires an adapter. The contactors are provided with mechanical support via a mechanical connection element.</p> <p>Control wire guide with max. 6 conductors with up to 2.5 mm external diameter or 4 conductors up to 3.5 mm external diameter.</p> <p>From 16 A, the motor protective circuit breaker and contactors are mounted on the top-hat rail adapter plate. The connection of the main circuit between PKZ and contactor is established with electrical contact modules. When using auxiliary contacts DILA - XHIT... → Chapter 1.1 (Page 38) the electrical plugs can be pulled without having to remove the front mounting auxiliary contact.</p> <p>Cannot be combined with NHI-E-...-PKZ0-C standard auxiliary contact with spring-loaded terminal.</p> |                            |             |                      |               |                 |                         |                     |               |                            |                         |                  |                         |
| <b>MSC-D-0.4-M7(24VDC)</b> <sup>1)</sup><br>283155  | 1 off                      | PKZM0-0,4                              | DILM7-10(...)  | PKZM0-XDM12               |   |                            |             |                      |               |                 |                         |                     |               |                            |                         |                  |                         |
| <b>MSC-D-0.63-M7(24VDC)</b> <sup>1)</sup><br>283156 | 1 off                      | PKZM0-0,63                             | DILM7-10(...)  | PKZM0-XDM12               |   |                            |             |                      |               |                 |                         |                     |               |                            |                         |                  |                         |
| <b>MSC-D-1-M7(24VDC)</b> <sup>1)</sup><br>283158    | 1 off                      | PKZM0-1                                | DILM7-10(...)  | PKZM0-XDM12               |   |                            |             |                      |               |                 |                         |                     |               |                            |                         |                  |                         |
| <b>MSC-D-1.6-M7(24VDC)</b> <sup>1)</sup><br>283159  | 1 off                      | PKZM0-1,6                              | DILM7-10(...)  | PKZM0-XDM12               |   |                            |             |                      |               |                 |                         |                     |               |                            |                         |                  |                         |
| <b>MSC-D-2.5-M7(24VDC)</b> <sup>1)</sup><br>283161  | 1 off                      | PKZM0-2,5                              | DILM7-10(...)  | PKZM0-XDM12               |   |                            |             |                      |               |                 |                         |                     |               |                            |                         |                  |                         |
| <b>MSC-D-4-M7(24VDC)</b> <sup>1)</sup><br>283162    | 1 off                      | PKZM0-4                                | DILM7-10(...)  | PKZM0-XDM12               |   |                            |             |                      |               |                 |                         |                     |               |                            |                         |                  |                         |
| <b>MSC-D-6.3-M7(24VDC)</b> <sup>1)</sup><br>283164  | 1 off                      | PKZM0-6,3                              | DILM7-10(...)  | PKZM0-XDM12               |   |                            |             |                      |               |                 |                         |                     |               |                            |                         |                  |                         |
| <b>MSC-D-10-M7(24VDC)</b><br>283165                 | 1 off                      | PKZM0-10                               | DILM7-10(...)  | PKZM0-XDM12               |   |                            |             |                      |               |                 |                         |                     |               |                            |                         |                  |                         |
| <b>MSC-D-10-M9(24VDC)</b><br>283166                 | 1 off                      | PKZM0-10                               | DILM9-10(...)  | PKZM0-XDM12               |   |                            |             |                      |               |                 |                         |                     |               |                            |                         |                  |                         |
| <b>MSC-D-12-M12(24VDC)</b><br>283167                | 1 off                      | PKZM0-12                               | DILM12-10(...) | PKZM0-XDM12               | <table border="0"> <tr> <td><b>Further information</b></td> <td><b>Page</b></td> </tr> <tr> <td>Technical data PKZM0</td> <td>→ Chapter 1.3</td> </tr> <tr> <td>Accessories PKZ</td> <td>→ Chapter 1.3 (Page 10)</td> </tr> <tr> <td>Technical data DILM</td> <td>→ Chapter 1.1</td> </tr> <tr> <td>Further actuating voltages</td> <td>→ Chapter 1.1 (Page 69)</td> </tr> <tr> <td>DILM accessories</td> <td>→ Chapter 1.1 (Page 50)</td> </tr> </table>   | <b>Further information</b> | <b>Page</b> | Technical data PKZM0 | → Chapter 1.3 | Accessories PKZ | → Chapter 1.3 (Page 10) | Technical data DILM | → Chapter 1.1 | Further actuating voltages | → Chapter 1.1 (Page 69) | DILM accessories | → Chapter 1.1 (Page 50) |
| <b>Further information</b>                          | <b>Page</b>                |  |                |                           |   |                            |             |                      |               |                 |                         |                     |               |                            |                         |                  |                         |
| Technical data PKZM0                                | → Chapter 1.3              |  |                |                           |   |                            |             |                      |               |                 |                         |                     |               |                            |                         |                  |                         |
| Accessories PKZ                                     | → Chapter 1.3 (Page 10)    |  |                |                           |   |                            |             |                      |               |                 |                         |                     |               |                            |                         |                  |                         |
| Technical data DILM                                 | → Chapter 1.1              |  |                |                           |   |                            |             |                      |               |                 |                         |                     |               |                            |                         |                  |                         |
| Further actuating voltages                          | → Chapter 1.1 (Page 69)    |  |                |                           |   |                            |             |                      |               |                 |                         |                     |               |                            |                         |                  |                         |
| DILM accessories                                    | → Chapter 1.1 (Page 50)    |  |                |                           |   |                            |             |                      |               |                 |                         |                     |               |                            |                         |                  |                         |
| <b>MSC-D-10-M17(24VDC)</b><br>101047                | 1 off                      | PKZM0-10                               | DILM17-10(...) | PKZM0-XDM32               |   |                            |             |                      |               |                 |                         |                     |               |                            |                         |                  |                         |
| <b>MSC-D-12-M17(24VDC)</b><br>101048                | 1 off                      | PKZM0-12                               | DILM17-10(...) | PKZM0-XDM32               |   |                            |             |                      |               |                 |                         |                     |               |                            |                         |                  |                         |
| <b>MSC-D-16-M17(24VDC)</b><br>283168                | 1 off                      | PKZM0-16                               | DILM17-10(...) | PKZM0-XDM32               |   |                            |             |                      |               |                 |                         |                     |               |                            |                         |                  |                         |
| <b>MSC-D-25-M25(24VDC)</b><br>283169                | 1 off                      | PKZM0-25                               | DILM25-10(...) | PKZM0-XDM32               |   |                            |             |                      |               |                 |                         |                     |               |                            |                         |                  |                         |
| <b>MSC-D-32-M32(24VDC)</b><br>283170                | 1 off                      | PKZM0-32                               | DILM32-10(...) | PKZM0-XDM32               |   |                            |             |                      |               |                 |                         |                     |               |                            |                         |                  |                         |

<sup>1)</sup> To assemble Type F starters that conform with UL508, incoming terminals BK25/3-PKZ0-E and, if necessary, three-phase terminal blocks B3.../...-PKZ0 can be added to motor starter combinations. Type F starter → Page 28

# 1.4

## Motor-starter combinations

Complete units 400/415 V

1

### MSC-DE: PKE, DILM

#### Motor data

| Rated operational power<br>AC-3 | Rated operational current<br>AC-3 | Rated short-circuit current |
|---------------------------------|-----------------------------------|-----------------------------|
| 380 V<br>400 V<br>415 V         | 400 V                             | 380 - 415 V                 |
| P<br>kW                         | $I_e$<br>A                        | $I_q$<br>kA                 |

#### Setting range

| Overload trip | Short-circuit release | Type of coordination |
|---------------|-----------------------|----------------------|
| $I_r$<br>A    | $I_{rm}$<br>A         |                      |

#### Motor starters actuating voltage 230 V 50 Hz

Part no.  
Article no.

Price  
See price list

Std. pack

#### Complete units MSC-US

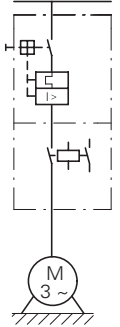
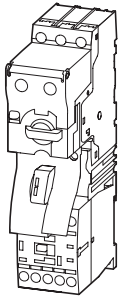

|      |      |     |           |      |     |  |       |
|------|------|-----|-----------|------|-----|--|-------|
| 0.06 | 0.21 | 100 | 0.3 - 1.2 | 16.8 | "1" | <b>MSC-DE-1.2-M7(230V50Hz)</b><br>121735 | 1 off |
| 0.09 | 0.31 | 100 | 0.3 - 1.2 | 16.8 | "1" | <b>MSC-DE-1.2-M7(230V50Hz)</b><br>121735 | 1 off |
| 0.12 | 0.41 | 100 | 0.3 - 1.2 | 16.8 | "1" | <b>MSC-DE-1.2-M7(230V50Hz)</b><br>121735 | 1 off |
| 0.18 | 0.6  | 100 | 0.3 - 1.2 | 16.8 | "1" | <b>MSC-DE-1.2-M7(230V50Hz)</b><br>121735 | 1 off |
| 0.25 | 0.8  | 100 | 0.3 - 1.2 | 16.8 | "1" | <b>MSC-DE-1.2-M7(230V50Hz)</b><br>121735 | 1 off |
| 0.37 | 1.1  | 100 | 0.3 - 1.2 | 16.8 | "1" | <b>MSC-DE-1.2-M7(230V50Hz)</b><br>121735 | 1 off |
| 0.55 | 1.5  | 100 | 1 - 4     | 56   | "1" | <b>MSC-DE-4-M7(230V50Hz)</b><br>121737   | 1 off |
| 0.75 | 1.9  | 100 | 1 - 4     | 56   | "1" | <b>MSC-DE-4-M7(230V50Hz)</b><br>121737   | 1 off |
| 1.1  | 2.6  | 100 | 1 - 4     | 56   | "1" | <b>MSC-DE-4-M7(230V50Hz)</b><br>121737   | 1 off |
| 1.5  | 3.6  | 100 | 1 - 4     | 56   | "1" | <b>MSC-DE-4-M7(230V50Hz)</b><br>121737   | 1 off |
| 2.2  | 5    | 100 | 3 - 12    | 168  | "1" | <b>MSC-DE-12-M7(230V50Hz)</b><br>121739  | 1 off |
| 3    | 6.6  | 100 | 3 - 12    | 168  | "1" | <b>MSC-DE-12-M7(230V50Hz)</b><br>121739  | 1 off |
| 4    | 8.5  | 100 | 3 - 12    | 168  | "1" | <b>MSC-DE-12-M9(230V50Hz)</b><br>121741  | 1 off |
| 5.5  | 11.3 | 100 | 3 - 12    | 168  | "1" | <b>MSC-DE-12-M12(230V50Hz)</b><br>121743 | 1 off |

#### Complete units MSC-US

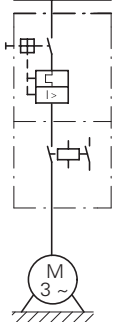
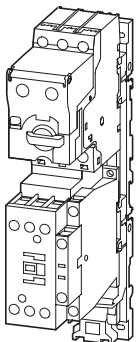

|     |      |     |        |     |          |  |       |
|-----|------|-----|--------|-----|----------|--|-------|
| 2.2 | 5    | 100 | 3 - 12 | 168 | "1", "2" | <b>MSC-DE-12-M17(230V50Hz)</b><br>121745 | 1 off |
| 3   | 6.6  | 100 | 3 - 12 | 168 | "1", "2" | <b>MSC-DE-12-M17(230V50Hz)</b><br>121745 | 1 off |
| 4   | 8.5  | 100 | 3 - 12 | 168 | "1", "2" | <b>MSC-DE-12-M17(230V50Hz)</b><br>121745 | 1 off |
| 5.5 | 11.3 | 100 | 3 - 12 | 168 | "1", "2" | <b>MSC-DE-12-M17(230V50Hz)</b><br>121745 | 1 off |
| 7.5 | 16.7 | 100 | 8 - 32 | 448 | "1", "2" | <b>MSC-DE-32-M17(230V50Hz)</b><br>121747 | 1 off |
| 11  | 21.7 | 100 | 8 - 32 | 448 | "1", "2" | <b>MSC-DE-32-M25(230V50Hz)</b><br>121749 | 1 off |
| 15  | 29.3 | 100 | 8 - 32 | 448 | "1", "2" | <b>MSC-DE-32-M32(230V50Hz)</b><br>121751 | 1 off |

| Motor starters<br>actuating voltage<br>24 V DC | Std.<br>pack               | Motor<br>protective<br>circuit breaker | Contactor      | DOL starter<br>wiring set | Notes   |
|--|----------------------------|--|----------------|---------------------------|---|
| Part no.<br>Article no.                        | Price<br>See price<br>list | Type                                   | Type           | Type                      |   |
| <b>MSC-DE-1.2-M7(24VDC)</b><br>121736          | 1 off                      | PKE12/XTU-1.2                          | DILM7-10(...)  | PKZM0-XDM12               | <p>The DOL starters (complete devices) consist of a PKE motor protective circuit breaker and a DILM contactor. With the adapterless top-hat rail mounting of starters up to 15 A, only the motor protective circuit breaker on the top-hat rail requires an adapter. The contactors are provided with mechanical support via a mechanical connection element. Control wire guide with max. 6 conductors with up to 2.5 mm external diameter or 4 conductors up to 3.5 mm external diameter. From 16 A, the motor protective circuit breaker and contactor are mounted on the top-hat rail adapter plate. The connection of the main circuit between PKE and contactor is established with electrical contact modules. When using auxiliary contacts DILA-XHIT... → Chapter 1.1 (Page 38) the electrical plugs can be pulled without having to remove the front mounting auxiliary contact. Cannot be combined with standard auxiliary contact NHI-E....PKZ0-C with spring-loaded terminals.</p> |
| <b>MSC-DE-1.2-M7(24VDC)</b><br>121736          | 1 off                      | PKE12/XTU-1.2                          | DILM7-10(...)  | PKZM0-XDM12               |   |
| <b>MSC-DE-1.2-M7(24VDC)</b><br>121736          | 1 off                      | PKE12/XTU-1.2                          | DILM7-10(...)  | PKZM0-XDM12               |   |
| <b>MSC-DE-1.2-M7(24VDC)</b><br>121736          | 1 off                      | PKE12/XTU-1.2                          | DILM7-10(...)  | PKZM0-XDM12               |   |
| <b>MSC-DE-1.2-M7(24VDC)</b><br>121736          | 1 off                      | PKE12/XTU-1.2                          | DILM7-10(...)  | PKZM0-XDM12               |   |
| <b>MSC-DE-1.2-M7(24VDC)</b><br>121736          | 1 off                      | PKE12/XTU-1.2                          | DILM7-10(...)  | PKZM0-XDM12               |   |
| <b>MSC-DE-4-M7(24VDC)</b><br>121738            | 1 off                      | PKE12/XTU-4                            | DILM7-10(...)  | PKZM0-XDM12               |   |
| <b>MSC-DE-4-M7(24VDC)</b><br>121738            | 1 off                      | PKE12/XTU-4                            | DILM7-10(...)  | PKZM0-XDM12               |   |
| <b>MSC-DE-4-M7(24VDC)</b><br>121738            | 1 off                      | PKE12/XTU-4                            | DILM7-10(...)  | PKZM0-XDM12               |   |
| <b>MSC-DE-4-M7(24VDC)</b><br>121738            | 1 off                      | PKE12/XTU-4                            | DILM7-10(...)  | PKZM0-XDM12               |   |
| <b>MSC-DE-12-M7(24VDC)</b><br>121740           | 1 off                      | PKE12/XTU-12                           | DILM7-10(...)  | PKZM0-XDM12               | <p><b>Further information</b></p> <p>Technical data PKE → Chapter 1.3</p> <p>Accessories PKE → Chapter 1.3 (Page 10)</p> <p>Technical data DILM → Chapter 1.1</p> <p>Further actuating voltages → Chapter 1.1 (Page 69)</p> <p>DILM accessories → Chapter 1.1 (Page 50)</p>   |
| <b>MSC-DE-12-M7(24VDC)</b><br>121740           | 1 off                      | PKE12/XTU-12                           | DILM7-10(...)  | PKZM0-XDM12               |   |
| <b>MSC-DE-12-M9(24VDC)</b><br>121742           | 1 off                      | PKE12/XTU-12                           | DILM9-10(...)  | PKZM0-XDM12               |   |
| <b>MSC-DE-12-M12(24VDC)</b><br>121744          | 1 off                      | PKE12/XTU-12                           | DILM12-10(...) | PKZM0-XDM12               |   |
| <b>MSC-DE-12-M17(24VDC)</b><br>121746          | 1 off                      | PKE12/XTU-12                           | DILM17-10(...) | PKZM0-XDM32               |   |
| <b>MSC-DE-12-M17(24VDC)</b><br>121746          | 1 off                      | PKE12/XTU-12                           | DILM17-10(...) | PKZM0-XDM32               |   |
| <b>MSC-DE-12-M17(24VDC)</b><br>121746          | 1 off                      | PKE12/XTU-12                           | DILM17-10(...) | PKZM0-XDM32               |   |
| <b>MSC-DE-12-M17(24VDC)</b><br>121746          | 1 off                      | PKE12/XTU-12                           | DILM17-10(...) | PKZM0-XDM32               |   |
| <b>MSC-DE-32-M17(24VDC)</b><br>121748          | 1 off                      | PKE32/XTU-32                           | DILM17-10(...) | PKZM0-XDM32               |   |
| <b>MSC-DE-32-M25(24VDC)</b><br>121750          | 1 off                      | PKE32/XTU-32                           | DILM25-10(...) | PKZM0-XDM32               |   |
| <b>MSC-DE-32-M32(24VDC)</b><br>121752          | 1 off                      | PKE32/XTU-32                           | DILM32-10(...) | PKZM0-XDM32               |   |

# 1.4

## Motor-starter combinations

Complete units 400/415 V



1

### MSC-DEA: PKE, DILM

#### Motor data

#### Setting range

| Rated operational power<br>AC-3<br>380 V<br>400 V<br>415 V | Rated operational current<br>AC-3<br>400 V | Rated short-circuit current<br>380 - 415 V | Overload trip | Short-circuit release | Type of coordination |
|--|--|--|---------------|-----------------------|----------------------|
|--|--|--|---------------|-----------------------|----------------------|

| P<br>kW | $I_e$<br>A | $I_q$<br>kA | $I_r$<br>A  | $I_{rm}$<br>A  |          |
|---------|------------|-------------|---|---|----------|
| 0.06    | 0.21       | 100         | 0.3 - 1.2   | 16.8  | "1"      |
| 0.09    | 0.31       | 100         | 0.3 - 1.2   | 16.8  | "1"      |
| 0.12    | 0.41       | 100         | 0.3 - 1.2   | 16.8  | "1"      |
| 0.18    | 0.6        | 100         | 0.3 - 1.2   | 16.8  | "1"      |
| 0.25    | 0.8        | 100         | 0.3 - 1.2   | 16.8  | "1"      |
| 0.37    | 1.1        | 100         | 0.3 - 1.2   | 16.8  | "1"      |
| 0.55    | 1.5        | 100         | 1 - 4   | 56  | "1"      |
| 0.75    | 1.9        | 100         | 1 - 4   | 56  | "1"      |
| 1.1     | 2.6        | 100         | 1 - 4   | 56  | "1"      |
| 1.5     | 3.6        | 100         | 1 - 4   | 56  | "1"      |
| 2.2     | 5          | 100         | 3 - 12  | 168   | "1"      |
| 3       | 6.6        | 100         | 3 - 12  | 168   | "1"      |
| 4       | 8.5        | 100         | 3 - 12  | 168   | "1"      |
| 5.5     | 11.3       | 100         | 3 - 12  | 168   | "1"      |
| 2.2     | 5          | 100         | 3 - 12  | 168   | "1", "2" |
| 3       | 6.6        | 100         | 3 - 12  | 168   | "1", "2" |
| 4       | 8.5        | 100         | 3 - 12  | 168   | "1", "2" |
| 5.5     | 11.3       | 100         | 3 - 12  | 168   | "1", "2" |
| 7.5     | 16.7       | 100         | 8 - 32  | 448   | "1", "2" |
| 11      | 21.7       | 100         | 8 - 32  | 448   | "1", "2" |
| 15      | 29.3       | 100         | 8 - 32  | 448   | "1", "2" |

#### Complete devices MSD-DEA

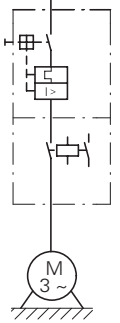
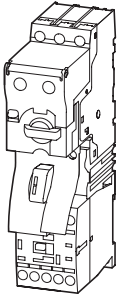

#### Complete devices MSD-DEA

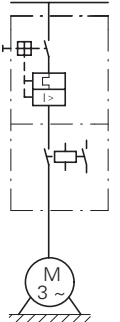
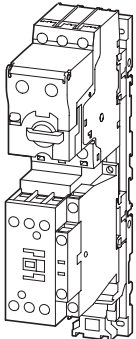

| Motor starters<br>actuating voltage<br>24 V DC | Std.<br>pack               | Motor<br>protective<br>circuit breaker | Contactor      | DOL starter<br>wiring set | Notes   |                            |             |                    |               |                 |                         |                     |               |                            |                         |                  |                         |
|--|----------------------------|--|----------------|---------------------------|---|----------------------------|-------------|--------------------|---------------|-----------------|-------------------------|---------------------|---------------|----------------------------|-------------------------|------------------|-------------------------|
| Part no.<br>Article no.                        | Price<br>See price<br>list | Type                                   | Type           | Type                      |   |                            |             |                    |               |                 |                         |                     |               |                            |                         |                  |                         |
| <b>MSC-DEA-1.2-M7(24VDC)</b><br>121753         | 1 off                      | PKE12/XTUA-1.2                         | DILM7-10(...)  | PKZM0-XDM12               | <p>The DOL starters (complete devices) consist of a PKE motor protective circuit breaker and a DILM contactor. With the adapterless top-hat rail mounting of starters up to 15 A, only the motor protective circuit breaker on the top-hat rail requires an adapter. The contactors are provided with mechanical support via a mechanical connection element. Control wire guide with max. 6 conductors with up to 2.5 mm external diameter or 4 conductors up to 3.5 mm external diameter. From 16 A, the motor protective circuit breaker and contactor are mounted on the top-hat rail adapter plate. The connection of the main circuit between PKE and contactor is established with electrical contact modules. When using auxiliary contacts DILA - XHIT... → Chapter 1.1 (Page 38) the electrical plugs can be pulled without having to remove the front mounting auxiliary contact. Cannot be combined with standard auxiliary contact NHI-E...-PKZO-C with spring-loaded terminals. The DOL starters MSC-DEA... are prepared for communication via SmartWire-DT®. For this the SWD-PKE communication must be added.</p> <table border="0"> <tr> <td><b>Further information</b></td> <td><b>Page</b></td> </tr> <tr> <td>Technical data PKE</td> <td>→ Chapter 1.3</td> </tr> <tr> <td>Accessories PKE</td> <td>→ Chapter 1.3 (Page 10)</td> </tr> <tr> <td>Technical data DILM</td> <td>→ Chapter 1.1</td> </tr> <tr> <td>Further actuating voltages</td> <td>→ Chapter 1.1 (Page 69)</td> </tr> <tr> <td>DILM accessories</td> <td>→ Chapter 1.1 (Page 50)</td> </tr> </table> | <b>Further information</b> | <b>Page</b> | Technical data PKE | → Chapter 1.3 | Accessories PKE | → Chapter 1.3 (Page 10) | Technical data DILM | → Chapter 1.1 | Further actuating voltages | → Chapter 1.1 (Page 69) | DILM accessories | → Chapter 1.1 (Page 50) |
| <b>Further information</b>                     | <b>Page</b>                |  |                |                           |   |                            |             |                    |               |                 |                         |                     |               |                            |                         |                  |                         |
| Technical data PKE                             | → Chapter 1.3              |  |                |                           |   |                            |             |                    |               |                 |                         |                     |               |                            |                         |                  |                         |
| Accessories PKE                                | → Chapter 1.3 (Page 10)    |  |                |                           |   |                            |             |                    |               |                 |                         |                     |               |                            |                         |                  |                         |
| Technical data DILM                            | → Chapter 1.1              |  |                |                           |   |                            |             |                    |               |                 |                         |                     |               |                            |                         |                  |                         |
| Further actuating voltages                     | → Chapter 1.1 (Page 69)    |  |                |                           |   |                            |             |                    |               |                 |                         |                     |               |                            |                         |                  |                         |
| DILM accessories                               | → Chapter 1.1 (Page 50)    |  |                |                           |   |                            |             |                    |               |                 |                         |                     |               |                            |                         |                  |                         |
| <b>MSC-DEA-1.2-M7(24VDC)</b><br>121753         | 1 off                      | PKE12/XTUA-1.2                         | DILM7-10(...)  | PKZM0-XDM12               |   |                            |             |                    |               |                 |                         |                     |               |                            |                         |                  |                         |
| <b>MSC-DEA-1.2-M7(24VDC)</b><br>121753         | 1 off                      | PKE12/XTUA-1.2                         | DILM7-10(...)  | PKZM0-XDM12               |   |                            |             |                    |               |                 |                         |                     |               |                            |                         |                  |                         |
| <b>MSC-DEA-1.2-M7(24VDC)</b><br>121753         | 1 off                      | PKE12/XTUA-1.2                         | DILM7-10(...)  | PKZM0-XDM12               |   |                            |             |                    |               |                 |                         |                     |               |                            |                         |                  |                         |
| <b>MSC-DEA-1.2-M7(24VDC)</b><br>121753         | 1 off                      | PKE12/XTUA-1.2                         | DILM7-10(...)  | PKZM0-XDM12               |   |                            |             |                    |               |                 |                         |                     |               |                            |                         |                  |                         |
| <b>MSC-DEA-1.2-M7(24VDC)</b><br>121753         | 1 off                      | PKE12/XTUA-1.2                         | DILM7-10(...)  | PKZM0-XDM12               |   |                            |             |                    |               |                 |                         |                     |               |                            |                         |                  |                         |
| <b>MSC-DEA-4-M7(24VDC)</b><br>121754           | 1 off                      | PKE12/XTUA-4                           | DILM7-10(...)  | PKZM0-XDM12               |   |                            |             |                    |               |                 |                         |                     |               |                            |                         |                  |                         |
| <b>MSC-DEA-4-M7(24VDC)</b><br>121754           | 1 off                      | PKE12/XTUA-4                           | DILM7-10(...)  | PKZM0-XDM12               |   |                            |             |                    |               |                 |                         |                     |               |                            |                         |                  |                         |
| <b>MSC-DEA-4-M7(24VDC)</b><br>121754           | 1 off                      | PKE12/XTUA-4                           | DILM7-10(...)  | PKZM0-XDM12               |   |                            |             |                    |               |                 |                         |                     |               |                            |                         |                  |                         |
| <b>MSC-DEA-4-M7(24VDC)</b><br>121754           | 1 off                      | PKE12/XTUA-4                           | DILM7-10(...)  | PKZM0-XDM12               |   |                            |             |                    |               |                 |                         |                     |               |                            |                         |                  |                         |
| <b>MSC-DEA-12-M7(24VDC)</b><br>121755          | 1 off                      | PKE12/XTUA-12                          | DILM7-10(...)  | PKZM0-XDM12               |   |                            |             |                    |               |                 |                         |                     |               |                            |                         |                  |                         |
| <b>MSC-DEA-12-M7(24VDC)</b><br>121755          | 1 off                      | PKE12/XTUA-12                          | DILM7-10(...)  | PKZM0-XDM12               |   |                            |             |                    |               |                 |                         |                     |               |                            |                         |                  |                         |
| <b>MSC-DEA-12-M9(24VDC)</b><br>121756          | 1 off                      | PKE12/XTUA-12                          | DILM9-10(...)  | PKZM0-XDM12               |   |                            |             |                    |               |                 |                         |                     |               |                            |                         |                  |                         |
| <b>MSC-DEA-12-M12(24VDC)</b><br>121757         | 1 off                      | PKE12/XTUA-12                          | DILM12-10(...) | PKZM0-XDM12               |   |                            |             |                    |               |                 |                         |                     |               |                            |                         |                  |                         |
| <b>MSC-DEA-12-M17(24VDC)</b><br>121758         | 1 off                      | PKE12/XTUA-12                          | DILM17-10(...) | PKZM0-XDM32               |   |                            |             |                    |               |                 |                         |                     |               |                            |                         |                  |                         |
| <b>MSC-DEA-12-M17(24VDC)</b><br>121758         | 1 off                      | PKE12/XTUA-12                          | DILM17-10(...) | PKZM0-XDM32               |   |                            |             |                    |               |                 |                         |                     |               |                            |                         |                  |                         |
| <b>MSC-DEA-12-M17(24VDC)</b><br>121758         | 1 off                      | PKE12/XTUA-12                          | DILM17-10(...) | PKZM0-XDM32               |   |                            |             |                    |               |                 |                         |                     |               |                            |                         |                  |                         |
| <b>MSC-DEA-12-M17(24VDC)</b><br>121758         | 1 off                      | PKE12/XTUA-12                          | DILM17-10(...) | PKZM0-XDM32               |   |                            |             |                    |               |                 |                         |                     |               |                            |                         |                  |                         |
| <b>MSC-DEA-32-M17(24VDC)</b><br>121759         | 1 off                      | PKE32/XTUA-32                          | DILM17-10(...) | PKZM0-XDM32               |   |                            |             |                    |               |                 |                         |                     |               |                            |                         |                  |                         |
| <b>MSC-DEA-32-M25(24VDC)</b><br>121760         | 1 off                      | PKE32/XTUA-32                          | DILM25-10(...) | PKZM0-XDM32               |   |                            |             |                    |               |                 |                         |                     |               |                            |                         |                  |                         |
| <b>MSC-DEA-32-M32(24VDC)</b><br>121761         | 1 off                      | PKE32/XTUA-32                          | DILM32-10(...) | PKZM0-XDM32               |   |                            |             |                    |               |                 |                         |                     |               |                            |                         |                  |                         |

# 1.4



## Motor-starter combinations Modules

1

### PKZM, DILM

#### Motor data

#### Setting range

| Rated operational power | Rated operational current | 380 - 415 V           |                       | Overload trip   | Short-circuit release   |
|-------------------------|---------------------------|-----------------------|-----------------------|---|---|
| AC-3                    | AC-3                      | Type "1" coordination | Type "2" coordination |   |   |
| 380 V<br>400 V<br>415 V | 400 V                     |                       |                       | $I_r$   | $I_{rm}$  |
| P                       | $I_e$                     | $I_q$                 | $I_q$                 | A  | A  |
| kW                      | A                         | kA                    | kA                    |   |   |
| 0.06                    | 0.21                      | 150                   | 50                    | 0.16 - 0.25   | 3.5   |
| 0.09                    | 0.31                      | 150                   | 50                    | 0.25 - 0.4  | 5.6   |
| 0.12                    | 0.41                      | 150                   | 50                    | 0.4 - 0.63  | 8.82  |
| 0.18                    | 0.6                       | 150                   | 50                    | 0.4 - 0.63  | 8.82  |
| 0.25                    | 0.8                       | 150                   | 50                    | 0.63 - 1  | 14  |
| 0.37                    | 1.1                       | 150                   | 50                    | 1 - 1.6   | 22.4  |
| 0.55                    | 1.5                       | 150                   | 50                    | 1 - 1.6   | 22.4  |
| 0.75                    | 1.9                       | 150                   | 50                    | 1.6 - 2.5   | 35  |
| 1.1                     | 2.6                       | 150                   | 50                    | 2.5 - 4   | 56  |
| 1.5                     | 3.6                       | 150                   | 50                    | 2.5 - 4   | 56  |
| 2.2                     | 5                         | 150                   | 50                    | 4 - 6.3   | 88.2  |
| 3                       | 6.6                       | 150                   | 50                    | 6.3 - 10  | 140   |
| 4                       | 8.5                       | 150                   | 50                    | 6.3 - 10  | 140   |
| 5.5                     | 11.3                      | 50                    | 50                    | 8 - 12  | 168   |
| 7.5                     | 15.2                      | 50                    | 50                    | 10 - 16   | 224   |
| 11                      | 21.7                      | 50                    | 50                    | 20 - 25   | 350   |
| 15                      | 29.3                      | 50                    | 50                    | 25 - 32   | 448   |
| 5.5                     | 11.3                      | 50                    | 50                    | 10 - 16   | 224   |
| 7.5                     | 15.2                      | 50                    | 50                    | 10 - 16   | 224   |
| 11                      | 21.7                      | 50                    | 50                    | 20 - 25   | 350   |
| 15                      | 29.3                      | 50                    | 50                    | 25 - 32   | 448   |
| 18.5                    | 36                        | 50                    | 50                    | 32 - 40   | 560   |
| 22                      | 41                        | 50                    | 50                    | 40 - 50   | 700   |
| 30                      | 55                        | 50                    | 50                    | 50 - 58   | 812   |
| 34                      | 63                        | 50                    | 50                    | 55 - 65   | 882   |

#### Modules PKZM0 and DILM

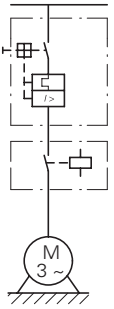
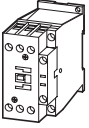
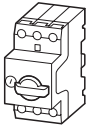

#### Modules PKZM4 and DILM

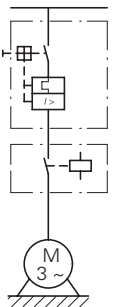
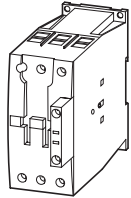
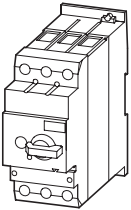



| Motor protective circuit breaker | Contactor             | Contactor             | Notes  |  |
|----------------------------------|-----------------------|-----------------------|--|--|
|                                  | Type "1" coordination | Type "2" coordination |  |  |
| Type                             | Type                  | Type                  |  |  |
| PKZM0-0,25                       | DILM7-...(…)          | DILM7-...(…)          | <p>The motor-starter combinations consist of the motor protective circuit breaker or a circuit breaker and a contactor. They conform with IEC/EN 60947-4-1 or VDE 0660 Part 102.</p> <p><math>I_q</math> = conditional rated current</p> <p><b>Further information</b></p> <p>Technical data PKZM0</p> <p>Accessories PKZ</p> <p>Technical data DILM</p> <p>Further actuating voltages</p> <p>DILM accessories</p> |  |
| PKZM0-0,4                        | DILM7-...(…)          | DILM7-...(…)          |  |  |
| PKZM0-0,63                       | DILM7-...(…)          | DILM7-...(…)          |  |  |
| PKZM0-0,63                       | DILM7-...(…)          | DILM7-...(…)          |  |  |
| PKZM0-1                          | DILM7-...(…)          | DILM7-...(…)          |  |  |
| PKZM0-1,6                        | DILM7-...(…)          | DILM7-...(…)          |  |  |
| PKZM0-1,6                        | DILM7-...(…)          | DILM7-...(…)          |  |  |
| PKZM0-2,5                        | DILM7-...(…)          | DILM7-...(…)          |  |  |
| PKZM0-4                          | DILM7-...(…)          | DILM7-...(…)          |  |  |
| PKZM0-4                          | DILM7-...(…)          | DILM7-...(…)          |  |  |
| PKZM0-6,3                        | DILM7-...(…)          | DILM7-...(…)          | <p><b>Page</b></p> <p>→ Chapter 1.3</p> <p>→ Chapter 1.3 (Page 10)</p> <p>→ Chapter 1.1</p> <p>→ Chapter 1.1 (Page 69)</p> <p>→ Chapter 1.1 (Page 50)</p>  |  |
| PKZM0-10                         | DILM7-...(…)          | DILM17-...(…)         |  |  |
| PKZM0-10                         | DILM9-...(…)          | DILM17-...(…)         |  |  |
| PKZM0-12                         | DILM12-...(…)         | DILM17-...(…)         |  |  |
| PKZM0-16                         | DILM15-...(…)         | DILM17-...(…)         |  |  |
| PKZM0-25                         | DILM25-...(…)         | DILM25-...(…)         |  |  |
| PKZM0-32                         | DILM32-...(…)         | DILM32-...(…)         |  |  |
| PKZM4-16                         | DILM17-...(…)         | DILM17-...(…)         |  | <p>The motor-starter combinations consist of the motor protective circuit breaker or a circuit breaker and a contactor. They conform with IEC/EN 60947-4-1 or VDE 0660 Part 102.</p> <p><math>I_q</math> = conditional rated current</p> <p><b>Further information</b></p> <p>Technical data PKZM4</p> <p>Accessories PKZ</p> <p>Technical data DILM</p> <p>Further actuating voltages</p> <p>DILM accessories</p> |
| PKZM4-16                         | DILM17-...(…)         | DILM17-...(…)         |  |  |
| PKZM4-25                         | DILM25-...(…)         | DILM25-...(…)         |  |  |
| PKZM4-32                         | DILM32-...(…)         | DILM32-...(…)         |  |  |
| PKZM4-40                         | DILM40(…)             | DILM40(…)             |  |  |
| PKZM4-50                         | DILM50(…)             | DILM50(…)             |  |  |
| PKZM4-58                         | DILM65(…)             | DILM65(…)             |  |  |
| PKZM4-63                         | DILM65(…)             | DILM65(…)             |  |  |
| PKZM4-16                         | DILM17-...(…)         | DILM17-...(…)         | <p><b>Page</b></p> <p>→ Chapter 1.3</p> <p>→ Chapter 1.3 (Page 10)</p> <p>→ Chapter 1.1</p> <p>→ Chapter 1.1 (Page 70)</p> <p>→ Chapter 1.1 (Page 50)</p>  |  |
| PKZM4-16                         | DILM17-...(…)         | DILM17-...(…)         |  |  |
| PKZM4-25                         | DILM25-...(…)         | DILM25-...(…)         |  |  |
| PKZM4-32                         | DILM32-...(…)         | DILM32-...(…)         |  |  |
| PKZM4-40                         | DILM40(…)             | DILM40(…)             |  |  |
| PKZM4-50                         | DILM50(…)             | DILM50(…)             |  |  |
| PKZM4-58                         | DILM65(…)             | DILM65(…)             |  |  |
| PKZM4-63                         | DILM65(…)             | DILM65(…)             |  |  |

# 1.4

## Motor-starter combinations Modules

1



### PKZM, DILM

#### Motor data

| Rated operational power | Rated operational current | Rated short-circuit current |                       |
|-------------------------|---------------------------|-----------------------------|-----------------------|
| AC-3                    | AC-3                      | 500 V                       | 500 V                 |
| 500 V                   | 500 V                     | Type "1" coordination       | Type "2" coordination |

#### Setting range

| Overload trip | Short-circuit release |
|---------------|-----------------------|
|---------------|-----------------------|

| P<br>kW | $I_e$<br>A | $I_q$<br>kA | $I_q$<br>kA | $I_r$<br>A  | $I_{rm}$<br>A  |
|---------|------------|-------------|-------------|--|---|
| 0.06    | 0.17       | 100         | 50          | 0.16 - 0.25  | 3.5   |
| 0.09    | 0.25       | 100         | 50          | 0.25 - 0.4   | 5.6   |
| 0.12    | 0.33       | 100         | 50          | 0.25 - 0.4   | 5.6   |
| 0.18    | 0.48       | 100         | 50          | 0.4 - 0.63   | 8.8   |
| 0.25    | 0.7        | 100         | 50          | 0.63 - 1   | 14  |
| 0.37    | 0.9        | 100         | 50          | 0.63 - 1   | 14  |
| 0.55    | 1.2        | 100         | 50          | 1 - 1.6  | 22  |
| 0.75    | 1.5        | 100         | 50          | 1 - 1.6  | 22  |
| 1.1     | 2.1        | 100         | 50          | 1.6 - 2.5  | 35  |
| 1.5     | 2.9        | 100         | 50          | 2.5 - 4  | 56  |
| 2.2     | 4          | 42          | 18          | 4 - 6.3  | 88  |
| 2.2     | 4          | —           | 50          | 4 - 6.3  | 88  |
| 3       | 5.3        | 42          | 18          | 4 - 6.3  | 88  |
| 3       | 5.3        | —           | 50          | 4 - 6.3  | 88  |
| 4       | 6.8        | 42          | 18          | 6.3 - 10   | 140   |
| 4       | 6.8        | —           | 50          | 6.3 - 10   | 140   |
| 5.5     | 9          | 42          | 18          | 6.3 - 10   | 140   |
| 5.5     | 9          | —           | 50          | 6.3 - 10   | 140   |
| 6.5     | 10.6       | 42          | 18          | 8 - 12   | 168   |
| 6.5     | 10.6       | —           | 50          | 8 - 12   | 168   |
| 7.5     | 12.1       | 15          | 18          | 10 - 16  | 224   |
| 7.5     | 12.1       | —           | 50          | 10 - 16  | 224   |
| 11      | 17.4       | 6           | —           | 16 - 20  | 280   |
| 11      | 17.4       | 15          | —           | 16 - 20  | 280   |
| 15      | 23.4       | 6           | —           | 20 - 25  | 350   |
| 15      | 23.4       | 15          | —           | 20 - 25  | 350   |
| 18.5    | 28.9       | 6           | —           | 25 - 32  | 448   |
| 18.5    | 28.9       | 15          | —           | 25 - 32  | 448   |
| 11      | 17.4       | 50          | 50          | 16 - 25  | 350   |
| 15      | 23.4       | 50          | 50          | 16 - 25  | 350   |
| 18.5    | 28.9       | 50          | 50          | 25 - 32  | 448   |
| 22      | 33         | 50          | 50          | 32 - 40  | 560   |
| 30      | 44         | 50          | 50          | 40 - 50  | 700   |
| 37      | 54         | 50          | 50          | 50 - 58  | 812   |
| 45      | 65         | 50          | 50          | 55 - 65  | 882   |

#### Modules PKZM0 and DILM

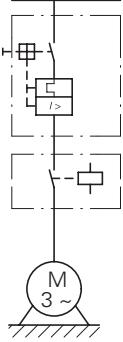
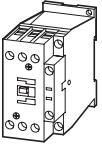
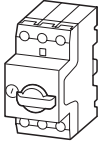

#### Modules PKZM4 and DILM

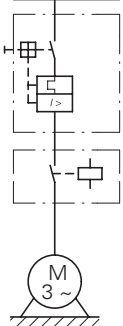
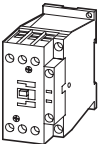
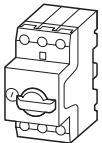

| Motor protective circuit breaker | Contactor<br>Type "1" coordination | Contactor<br>Type "2" coordination | Current limiter | Notes   |   |
|----------------------------------|------------------------------------|------------------------------------|-----------------|---|---|
| Type                             | Type                               | Type                               | Type            |   |   |
| PKZM0-0,25                       | DILM7-...(…)                       | DILM7-...(…)                       | –               | The motor-starter combinations consist of the motor protective circuit breaker or a circuit breaker and a contactor. They conform with IEC/EN 60947-4-1 or VDE 0660 Part 102. I <sub>q</sub> = rated conditional short-circuit current. |   |
| PKZM0-0,4                        | DILM7-...(…)                       | DILM7-...(…)                       | –               |   |   |
| PKZM0-0,4                        | DILM7-...(…)                       | DILM7-...(…)                       | –               |   |   |
| PKZM0-0,63                       | DILM7-...(…)                       | DILM7-...(…)                       | –               |   |   |
| PKZM0-1                          | DILM7-...(…)                       | DILM7-...(…)                       | –               |   |   |
| PKZM0-1                          | DILM7-...(…)                       | DILM7-...(…)                       | –               |   |   |
| PKZM0-1,6                        | DILM7-...(…)                       | DILM7-...(…)                       | –               |   |   |
| PKZM0-1,6                        | DILM7-...(…)                       | DILM7-...(…)                       | –               |   |   |
| PKZM0-2,5                        | DILM7-...(…)                       | DILM17-...(…)                      | –               |   |   |
| PKZM0-4                          | DILM7-...(…)                       | DILM17-...(…)                      | –               |   |   |
| PKZM0-6,3                        | DILM7-...(…)                       | DILM17-...(…)                      | –               | <b>Further information</b><br>Technical data PKZM...<br>PKZM accessories...<br>Technical data DILM<br>Further actuating voltages<br>DILM accessories  |   |
| PKZM0-6,3                        | –                                  | DILM17-...(…)                      | CL-PKZ0         |   |   |
| PKZM0-6,3                        | DILM7-...(…)                       | DILM17-...(…)                      | –               |   |   |
| PKZM0-6,3                        | –                                  | DILM17-...(…)                      | CL-PKZ0         |   |   |
| PKZM0-10                         | DILM9-...(…)                       | DILM17-...(…)                      | –               |   |   |
| PKZM0-10                         | –                                  | DILM17-...(…)                      | CL-PKZ0         |   |   |
| PKZM0-10                         | DILM9-...(…)                       | DILM17-...(…)                      | –               |   |   |
| PKZM0-10                         | –                                  | DILM17-...(…)                      | CL-PKZ0         |   |   |
| PKZM0-12                         | DILM12-...(…)                      | DILM17-...(…)                      | –               |   |   |
| PKZM0-12                         | –                                  | DILM17-...(…)                      | CL-PKZ0         |   |   |
| PKZM0-16                         | DILM17-...(…)                      | DILM17-...(…)                      | –               | <b>Further information</b><br>Technical data PKZM...<br>PKZM accessories...<br>Technical data DILM<br>Further actuating voltages<br>DILM accessories  |   |
| PKZM0-16                         | –                                  | DILM17-...(…)                      | CL-PKZ0         |   |   |
| PKZM0-20                         | DILM25-...(…)                      | –                                  | –               |   |   |
| PKZM0-20                         | DILM25-...(…)                      | –                                  | CL-PKZ0         |   |   |
| PKZM0-25                         | DILM25-...(…)                      | –                                  | –               |   |   |
| PKZM0-25                         | DILM25-...(…)                      | –                                  | CL-PKZ0         |   |   |
| PKZM0-32                         | DILM32-...(…)                      | –                                  | –               |   |   |
| PKZM0-32                         | DILM32-...(…)                      | –                                  | CL-PKZ0         |   |   |
| PKZM4-25                         | DILM40(…)                          | DILM40(…)                          | –               |   | The motor-starter combinations consist of the motor protective circuit breaker or a circuit breaker and a contactor. They conform with IEC/EN 60947-4-1 or VDE 0660 Part 102. I <sub>q</sub> = rated conditional short-circuit current. |
| PKZM4-25                         | DILM40(…)                          | DILM40(…)                          | –               |   |   |
| PKZM4-32                         | DILM40(…)                          | DILM40(…)                          | –               |   |   |
| PKZM4-40                         | DILM40(…)                          | DILM40(…)                          | –               |   |   |
| PKZM4-50                         | DILM50(…)                          | DILM50(…)                          | –               |   |   |
| PKZM4-58                         | DILM65(…)                          | DILM65(…)                          | –               |   |   |
| PKZM4-63                         | DILM65(…)                          | DILM65(…)                          | –               |   |   |
|                                  |                                    |                                    |                 |   |   |
|                                  |                                    |                                    |                 |   |   |
|                                  |                                    |                                    |                 |   |   |

# 1.4

## Motor-starter combinations Modules

1

### NZMN, NZMH, DILM

#### Motor data

| Rated operational power<br>AC-3 | Rated operational current<br>AC-3 | Rated short-circuit current |
|---------------------------------|-----------------------------------|-----------------------------|
| 380 V<br>400 V<br>415 V         | 400 V                             | 400/415 V                   |
| P<br>kW                         | $I_e$<br>A                        | $I_q$<br>kA                 |

#### Setting range

| Overload trip | Short-circuit release |
|---------------|-----------------------|
|---------------|-----------------------|



#### Modules NZMN and DILM

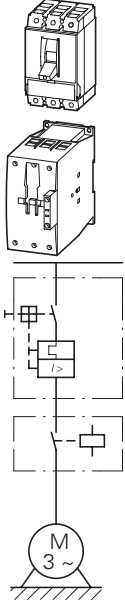

|      |     |    |            |              |
|------|-----|----|------------|--------------|
| 18.5 | 36  | 50 | 32 - 40    | 320 - 560    |
| 22   | 41  | 50 | 40 - 50    | 400 - 700    |
| 30   | 55  | 50 | 50 - 63    | 504 - 882    |
| 37   | 68  | 50 | 63 - 80    | 640 - 1120   |
| 45   | 81  | 50 | 80 - 100   | 800 - 1250   |
| 55   | 99  | 50 | 80 - 100   | 800 - 1250   |
| 75   | 134 | 50 | 125 - 160  | 1280 - 2240  |
| 90   | 161 | 50 | 160 - 200  | 1600 - 2500  |
| 110  | 196 | 50 | 160 - 200  | 1600 - 2500  |
| 132  | 231 | 50 | 175 - 350  | 350 - 4900   |
| 160  | 279 | 50 | 175 - 350  | 350 - 4900   |
| 200  | 349 | 50 | 175 - 350  | 350 - 4900   |
| 250  | 437 | 50 | 225 - 450  | 450 - 6300   |
| 315  | 544 | 50 | 275 - 550  | 550 - 7700   |
| 400  | 683 | 50 | 438 - 875  | 875 - 12250  |
| 450  | 750 | 50 | 438 - 875  | 875 - 12250  |
| 500  | 820 | 50 | 438 - 875  | 875 - 12250  |
| 560  | 947 | 50 | 700 - 1400 | 1400 - 19600 |

#### Modules NZMH and DILM

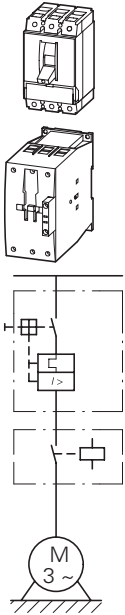

|     |     |     |           |             |
|-----|-----|-----|-----------|-------------|
| 22  | 41  | 100 | 40 - 50   | 400 - 700   |
| 30  | 55  | 100 | 50 - 63   | 504 - 882   |
| 37  | 68  | 100 | 63 - 80   | 640 - 1120  |
| 45  | 81  | 100 | 80 - 100  | 800 - 1250  |
| 55  | 100 | 100 | 100 - 125 | 1000 - 1750 |
| 75  | 134 | 100 | 125 - 160 | 1280 - 2240 |
| 30  | 55  | 100 | 45 - 90   | 90 - 1260   |
| 37  | 68  | 100 | 45 - 90   | 90 - 1260   |
| 45  | 81  | 100 | 45 - 90   | 90 - 1260   |
| 55  | 100 | 100 | 70 - 140  | 140 - 1960  |
| 75  | 134 | 100 | 70 - 140  | 140 - 1960  |
| 90  | 161 | 100 | 110 - 120 | 220 - 3080  |
| 110 | 196 | 100 | 110 - 120 | 220 - 3080  |
| 132 | 231 | 100 | 175 - 350 | 350 - 4900  |
| 160 | 279 | 100 | 175 - 350 | 350 - 4900  |
| 200 | 349 | 100 | 175 - 350 | 350 - 4900  |

Notes

|                        |                       |                       |
|------------------------|-----------------------|-----------------------|
| <b>Circuit-breaker</b> | <b>Contactor</b>      | <b>Contactor</b>      |
|                        | Type "1" coordination | Type "2" coordination |

|             |             |             |
|-------------|-------------|-------------|
| <b>Type</b> | <b>Type</b> | <b>Type</b> |
|-------------|-------------|-------------|

|              |                  |                  |
|--------------|------------------|------------------|
| NZMN1-M40    | DILM40(...)      | DILM80(...)      |
| NZMN1-M50    | DILM50(...)      | DILM80(...)      |
| NZMN1-M63    | DILM65(...)      | DILM80(...)      |
| NZMN1-M80    | DILM80(...)      | DILM80(...)      |
| NZMN1-M100   | DILM95(...)      | DILM95(...)      |
| NZMN1-M100   | DILM115(...)     | DILM115(...)     |
| NZMN2-M160   | DILM150(...)     | DILM150(...)     |
| NZMN2-M200   | DILM185A/22(...) | DILM185A/22(...) |
| NZMN2-M200   | DILM225A/22(...) | DILM225A/22(...) |
| NZMN3-ME350  | DILM250/22(...)  | DILM250/22(...)  |
| NZMN3-ME350  | DILM300A/22(...) | DILM300A/22(...) |
| NZMN3-ME350  | DILM400/22(...)  | DILM400/22(...)  |
| NZMN3-ME450  | DILM500/22(...)  | DILM500/22(...)  |
| NZMN4-ME550  | DILM580/22(...)  | –                |
| NZMN4-ME875  | DILM650/22(...)  | –                |
| NZMN4-ME875  | DILM750/22(...)  | –                |
| NZMN4-ME875  | DILM820/22(...)  | –                |
| NZMN4-ME1400 | DILM1000/22(...) | –                |

The motor-starter combinations consist of the motor protective circuit breaker or a circuit breaker and a contactor. They conform with IEC/EN 60947-4-1 or VDE 0660 Part 102.  
I<sub>q</sub> = conditional rated current

|             |                  |                  |
|-------------|------------------|------------------|
| NZMH2-M50   | DILM80(...)      | DILM80(...)      |
| NZMH2-M63   | DILM80(...)      | DILM80(...)      |
| NZMH2-M80   | DILM80(...)      | DILM80(...)      |
| NZMH2-M100  | DILM95(...)      | DILM95(...)      |
| NZMH2-M125  | DILM115(...)     | DILM115(...)     |
| NZMH2-M160  | DILM150(...)     | DILM150(...)     |
| NZMH2-ME90  | DILM80(...)      | DILM80(...)      |
| NZMH2-ME90  | DILM80(...)      | DILM80(...)      |
| NZMH2-ME90  | DILM95(...)      | DILM95(...)      |
| NZMH2-ME140 | DILM115(...)     | DILM115(...)     |
| NZMH2-ME140 | DILM150(...)     | DILM150(...)     |
| NZMH2-ME220 | DILM185A/22(...) | DILM185A/22(...) |
| NZMH2-ME220 | DILM225A/22(...) | DILM225A/22(...) |
| NZMH3-ME350 | DILM250/22(...)  | DILM250/22(...)  |
| NZMH3-ME350 | DILM300A/22(...) | DILM300A/22(...) |
| NZMH3-ME350 | DILM400/22(...)  | DILM400/22(...)  |

The motor-starter combinations consist of the motor protective circuit breaker or a circuit breaker and a contactor. They conform with IEC/EN 60947-4-1 or VDE 0660 Part 102.  
I<sub>q</sub> = conditional rated current

# 1.4 Motor-starter combinations

Modules

## 1 Modules NZMH and DILM

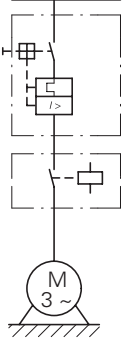
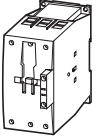
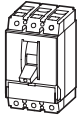

### NZMH, DILM

#### Motor data

| Rated operational power<br>AC-3 | Rated operational current |       | Rated short-circuit current |
|---------------------------------|---------------------------|-------|-----------------------------|
| 500 V<br>525 V                  | 500 V                     | 525 V | 500/525 V                   |

#### Setting range

| Overload trip | Short-circuit release |
|---------------|-----------------------|
|---------------|-----------------------|

| P<br>kW | $I_e$<br>A | $I_e$<br>A | $I_q$<br>kA | $I_r$<br>A | $I_{rm}$<br>A |
|---------|------------|------------|-------------|------------|---------------|
| 11      | 17.4       | 17         | 50          | 16 - 20    | 350 - 350     |
| 15      | 23.4       | 22.5       | 50          | 20 - 25    | 350 - 350     |
| 18.5    | 28.9       | 28         | 50          | 25 - 32    | 320 - 448     |
| 22      | 33         | 32         | 50          | 32 - 40    | 320 - 560     |
| 30      | 44         | 43         | 50          | 40 - 50    | 400 - 700     |
| 37      | 54         | 54         | 50          | 50 - 63    | 504 - 882     |
| 45      | 65         | 64         | 50          | 63 - 80    | 640 - 1120    |
| 55      | 79         | 78         | 50          | 63 - 80    | 640 - 1120    |
| 75      | 107        | 106        | 50          | 100 - 125  | 1000 - 1750   |
| 90      | 129        | 127        | 50          | 125 - 160  | 1280 - 2240   |
| 30      | 44         | 43         | 50          | 45 - 90    | 90 - 1260     |
| 37      | 54         | 54         | 50          | 45 - 90    | 90 - 1260     |
| 45      | 65         | 64         | 50          | 45 - 90    | 90 - 1260     |
| 55      | 79         | 78         | 50          | 45 - 90    | 90 - 1260     |
| 75      | 107        | 106        | 50          | 70 - 140   | 140 - 1960    |
| 90      | 129        | 127        | 50          | 70 - 140   | 140 - 1960    |

| Circuit-breaker | Contactor             | Contactor             | Notes  |
|-----------------|-----------------------|-----------------------|--|
|                 | Type "1" coordination | Type "2" coordination |  |
| Type            | Type                  | Type                  |  |
| NZMH2-M20       | DILM40(...)           | DILM80(...)           | The motor-starter combinations consist of the motor protective circuit breaker or a circuit breaker and a contactor. They conform with IEC/EN 60947-4-1 or VDE 0660 Part 102.<br>$I_q$ = conditional rated current |
| NZMH2-M25       | DILM40(...)           | DILM80(...)           |  |
| NZMH2-M32       | DILM40(...)           | DILM80(...)           |  |
| NZMH2-M40       | DILM40(...)           | DILM80(...)           |  |
| NZMH2-M50       | DILM80(...)           | DILM80(...)           |  |
| NZMH2-M63       | DILM80(...)           | DILM80(...)           |  |
| NZMH2-M80       | DILM80(...)           | DILM80(...)           |  |
| NZMH2-M80       | DILM80(...)           | DILM80(...)           |  |
| NZMH2-M125      | DILM115(...)          | DILM115(...)          |  |
| NZMH2-M160      | DILM150(...)          | DILM150(...)          |  |
| NZMH2-ME90      | DILM80(...)           | DILM80(...)           |  |
| NZMH2-ME90      | DILM80(...)           | DILM80(...)           |  |
| NZMH2-ME90      | DILM80(...)           | DILM80(...)           |  |
| NZMH2-ME140     | DILM115(...)          | DILM115(...)          |  |
| NZMH2-ME140     | DILM150(...)          | DILM150(...)          |  |

# 1.4 Motor-starter combinations

## Modules

1

### PKZM0, DILM, ZB; NZMN1, DILM, ZB

| Motor data              |                           |                             | Setting range |                       | Basic unit |
|-------------------------|---------------------------|-----------------------------|---------------|-----------------------|------------|
| Rated operational power | Rated operational current | Rated short-circuit current | Overload trip | Short-circuit release |            |
| AC-3                    | AC-3                      |                             |               |                       |            |
| 380 V<br>400 V<br>415 V | 400 V                     | 380 - 415 V                 |               |                       |            |
| P                       | $I_e$                     | $I_q$                       | $I_r$         | $I_{rm}$              | Type       |
| kW                      | A                         | kA                          | A             | A                     |            |
| 0.06                    | 0.21                      | 100                         | 0.16 - 0.24   | 3.5                   | PKM0-0,25  |
| 0.09                    | 0.31                      | 100                         | 0.24 - 0.4    | 5.6                   | PKM0-0,4   |
| 0.12                    | 0.41                      | 100                         | 0.4 - 0.6     | 8.82                  | PKM0-0,63  |
| 0.18                    | 0.6                       | 100                         | 0.4 - 0.6     | 8.82                  | PKM0-0,63  |
| 0.25                    | 0.8                       | 100                         | 0.6 - 1       | 14                    | PKM0-1     |
| 0.37                    | 1.1                       | 100                         | 1 - 1.6       | 22.4                  | PKM0-1,6   |
| 0.55                    | 1.5                       | 100                         | 1 - 1.6       | 22.4                  | PKM0-1,6   |
| 0.75                    | 1.9                       | 100                         | 1.6 - 2.4     | 35                    | PKM0-2,5   |
| 1.1                     | 2.6                       | 100                         | 2.4 - 4       | 56                    | PKM0-4     |
| 1.5                     | 3.6                       | 100                         | 2.4 - 4       | 56                    | PKM0-4     |
| 2.2                     | 5                         | 100                         | 4 - 6         | 88.2                  | PKM0-6,3   |
| 3                       | 6.6                       | 100                         | 6 - 10        | 140                   | PKM0-10    |
| 4                       | 8.5                       | 100                         | 6 - 10        | 140                   | PKM0-10    |
| 5.5                     | 11.3                      | 50                          | 8 - 12        | 168                   | PKM0-12    |
| 5.5                     | 11.3                      | 50                          | 10 - 16       | 168                   | PKM0-12    |
| 7.5                     | 15.2                      | 50                          | 10 - 16       | 224                   | PKM0-16    |
| 11                      | 21.7                      | 50                          | 16 - 24       | 350                   | PKM0-25    |
| 15                      | 29.3                      | 50                          | 20 - 32       | 448                   | PKM0-32    |
| 18.5                    | 36                        | 50                          | 24 - 40       | 320 - 560             | NZMN1-S40  |
| 18.5                    | 36                        | 50                          | 3 - 65        | 320 - 560             | NZMN1-S40  |
| 22                      | 41                        | 50                          | 40 - 57       | 400 - 700             | NZMN1-S50  |
| 22                      | 41                        | 50                          | 3 - 65        | 400 - 700             | NZMN1-S50  |
| 30                      | 55                        | 50                          | 40 - 57       | 504 - 882             | NZMN1-S63  |
| 30                      | 55                        | 50                          | 3 - 65        | 504 - 882             | NZMN1-S63  |
| 37                      | 68                        | 50                          | 50 - 70       | 640 - 1120            | NZMN1-S80  |
| 37                      | 68                        | 50                          | 10 - 145      | 640 - 1120            | NZMN1-S80  |
| 45                      | 81                        | 50                          | 70 - 100      | 800 - 1250            | NZMN1-S100 |
| 45                      | 81                        | 50                          | 10 - 145      | 800 - 1250            | NZMN1-S100 |
| 55                      | 99                        | 50                          | 70 - 100      | 800 - 1250            | NZMN1-S100 |
| 55                      | 99                        | 50                          | 10 - 145      | 800 - 1250            | NZMN1-S100 |

#### Modules PKM0, DILM and ZB with and without automatic reset

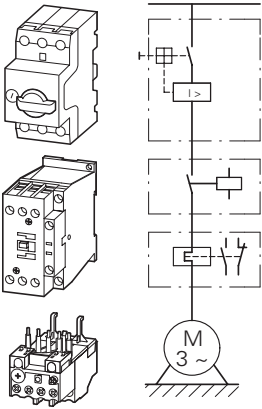

#### Modules NZMN1, DILM and Z...

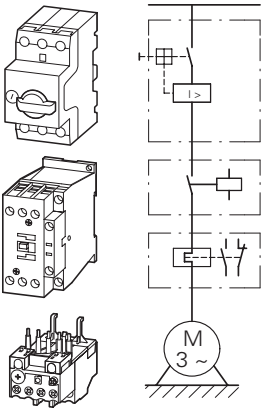



| Contactor             | Overload relay        | Contactor             | Overload relay        | Current sensor | Notes  |
|-----------------------|-----------------------|-----------------------|-----------------------|----------------|--|
| Type "1" coordination | Type "1" coordination | Type "2" coordination | Type "2" coordination |                |  |
| Type                  | Type                  | Type                  | Type                  | Type           |  |
| DILM7-...(…)          | ZB12-0,24             | DILM7-...(…)          | ZB12-0,24             | –              | <p>The motor-starter combinations consist of the motor protective circuit breaker (without overload function), a contactor and overload relay modules.</p> <p>They conform with IEC/EN 60947-4-1 or VDE 0660 Part 102.</p> <p><math>I_g</math> = conditional rated current</p> <p>The combinations can be operated with or without manual reset. In the Manual position, the combination is blocked against automatic restarting and must be reset locally. In the Auto position, the combination automatically switches on again after the bimetallic elements have cooled down.</p>                        |
| DILM7-...(…)          | ZB12-0,4              | DILM7-...(…)          | ZB12-0,4              | –              |  |
| DILM7-...(…)          | ZB12-0,6              | DILM7-...(…)          | ZB12-0,6              | –              |  |
| DILM7-...(…)          | ZB12-0,6              | DILM7-...(…)          | ZB12-0,6              | –              |  |
| DILM7-...(…)          | ZB12-1                | DILM7-...(…)          | ZB12-1                | –              |  |
| DILM7-...(…)          | ZB12-1,6              | DILM7-...(…)          | ZB12-1,6              | –              |  |
| DILM7-...(…)          | ZB12-1,6              | DILM7-...(…)          | ZB12-1,6              | –              |  |
| DILM7-...(…)          | ZB12-2,4              | DILM7-...(…)          | ZB12-2,4              | –              |  |
| DILM7-...(…)          | ZB12-4                | DILM7-...(…)          | ZB12-4                | –              |  |
| DILM7-...(…)          | ZB12-4                | DILM7-...(…)          | ZB12-4                | –              |  |
| DILM7-...(…)          | ZB12-6                | DILM17-...(…)         | ZB32-6                | –              |  |
| DILM9-...(…)          | ZB12-10               | DILM17-...(…)         | ZB32-10               | –              |  |
| DILM9-...(…)          | ZB12-10               | DILM17-...(…)         | ZB32-10               | –              |  |
| DILM12-...(…)         | ZB12-12               | –                     | –                     | –              |  |
| –                     | –                     | DILM17-...(…)         | ZB32-16               | –              |  |
| DILM17-...(…)         | ZB32-16               | DILM17-...(…)         | ZB32-16               | –              |  |
| DILM25-...(…)         | ZB32-24               | DILM25-...(…)         | ZB32-24               | –              |  |
| DILM32-...(…)         | ZB32-32               | DILM32-...(…)         | ZB32-32               | –              |  |
| DILM40(…)             | ZB65-40               | –                     | –                     | –              | <p>The motor-starter combinations consist of the circuit-breaker (without overload function), contactor and overload relay module.</p> <p>They conform with IEC/EN 60947-4-1 or VDE 0660 Part 102.</p> <p><math>I_g</math> = conditional rated current</p> <p>The combinations can be operated with or without manual reset. In the Manual position, the combination is blocked against automatic restarting and must be reset locally. In the Auto position, the combination automatically switches on again after the bimetallic elements have cooled down.</p> <p>Maximum tripping tolerance CLASS10.</p> |
| –                     | –                     | DILM40(…)             | –                     | –              |  |
| DILM50(…)             | ZB65-57               | –                     | –                     | –              |  |
| –                     | –                     | DILM50(…)             | –                     | –              |  |
| DILM65(…)             | ZB65-57               | –                     | –                     | –              |  |
| –                     | –                     | DILM65(…)             | –                     | –              |  |
| DILM80(…)             | ZB150-70              | –                     | –                     | –              |  |
| –                     | –                     | DILM80(…)             | –                     | –              |  |
| DILM95(…)             | ZB150-100             | –                     | –                     | –              |  |
| –                     | –                     | DILM95(…)             | –                     | –              |  |
| DILM115(…)            | ZB150-100             | –                     | –                     | –              |  |
| –                     | –                     | DILM115(…)            | –                     | –              |  |
| –                     | –                     | –                     | –                     | –              |  |
| –                     | –                     | –                     | –                     | –              |  |
|                       |                       |                       |                       |                | <p><b>Further information</b></p> <p>Technical data PKZMO → Chapter 1.3</p> <p>Accessories PKZ → Chapter 1.3 (Page 10)</p> <p>Technical data DILM → Chapter 1.1</p> <p>Further actuating voltages → Chapter 1.1 (Page 69)</p> <p>DIL accessories → Chapter 1.1 (Page 52)</p> <p>Technical data ZB... → Chapter 1.2</p> <p>Accessories ZB... → Chapter 1.2 (Page 21)</p>  |
|                       |                       |                       |                       |                | <p><b>Further information</b></p> <p>Technical data NZMN1 → See catalog</p> <p>Accessories NZM1 → See catalog</p> <p>Technical data DILM → Chapter 1.1</p> <p>Further actuating voltages → Chapter 1.1 (Page 71)</p> <p>DIL accessories → Chapter 1.1 (Page 50)</p> <p>Technical data ZB... → Chapter 1.2</p> <p>Accessories ZB... → Chapter 1.2 (Page 21)</p>   |

# 1.4 Motor-starter combinations

Complete units

1

## MSC-R: PKZM0, DILM

### Motor data

| Rated operational power<br>AC-3 | Rated operational current<br>AC-3 | Rated short-circuit current<br>380 - 415 V |                               |
|---------------------------------|-----------------------------------|--|-------------------------------|
| 380 V<br>400 V<br>415 V         | 400 V                             | Type "1"<br>coordina-<br>tion              | Type "2"<br>coordina-<br>tion |
| P<br>kW                         | $I_e$<br>A                        | $I_q$<br>kA                                | $I_q$<br>kA                   |

### Setting range

| Overload trip | Short-circuit releases |
|---------------|------------------------|
| $I_r$<br>A    | $I_{rm}$<br>A          |

### Motor starters actuating voltage 230 V 50 Hz

Part no.  
Article no.

Price  
See price list

#### Complete units MSC-R

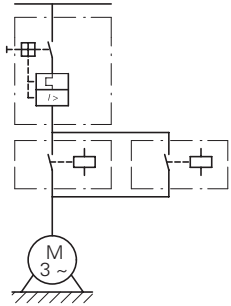
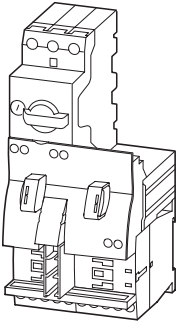

|              |             |     |    |             |      |  |
|--------------|-------------|-----|----|-------------|------|--|
| 0.06         | 0.21        | 150 | 50 | 0.16 - 0.25 | 3.5  | <b>MSC-R-0.25-M7(230V50Hz)</b><br>283171 |
| 0.09         | 0.31        | 150 | 50 | 0.25 - 0.4  | 5.6  | <b>MSC-R-0.4-M7(230V50Hz)</b><br>283172  |
| 0.12<br>0.18 | 0.41<br>0.6 | 150 | 50 | 0.4 - 0.63  | 8.82 | <b>MSC-R-0.63-M7(230V50Hz)</b><br>283173 |
| 0.25         | 0.8         | 150 | 50 | 0.63 - 1    | 14   | <b>MSC-R-1-M7(230V50Hz)</b><br>283175    |
| 0.37<br>0.55 | 1.1<br>1.5  | 150 | 50 | 1 - 1.6     | 22.4 | <b>MSC-R-1.6-M7(230V50Hz)</b><br>283176  |
| 0.75         | 1.9         | 150 | 50 | 1.6 - 2.5   | 35   | <b>MSC-R-2.5-M7(230V50Hz)</b><br>283178  |
| 1.1<br>1.5   | 2.6<br>3.6  | 150 | 50 | 2.5 - 4     | 56   | <b>MSC-R-4-M7(230V50Hz)</b><br>283179    |
| 2.2          | 5           | 150 | 50 | 4 - 6.3     | 88.2 | <b>MSC-R-6.3-M7(230V50Hz)</b><br>283181  |
| 3            | 6.6         | 150 | -  | 6.3 - 10    | 140  | <b>MSC-R-10-M7(230V50Hz)</b><br>283182   |
| 4            | 8.5         | 150 | -  | 6.3 - 10    | 140  | <b>MSC-R-10-M9(230V50Hz)</b><br>283183   |
| 5.5          | 11.3        | 50  | -  | 8 - 12      | 168  | <b>MSC-R-12-M12(230V50Hz)</b><br>283184  |

#### Complete units MSC-R

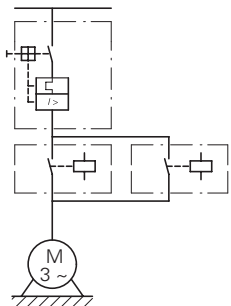
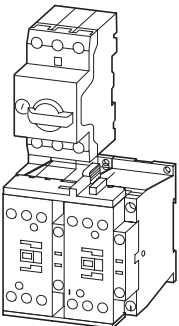

|     |      |    |    |          |     |   |
|-----|------|----|----|----------|-----|---|
| 3   | 6.6  | 50 | 50 | 6.3 - 10 | 140 | <b>MSC-R-10-M17(230V50Hz)</b><br>101049 |
| 4   | 11.3 | 50 | 50 | 8 - 12   | 168 | <b>MSC-R-12-M17(230V50Hz)</b><br>101050 |
| 7.5 | 15.2 | 50 | 50 | 10 - 16  | 224 | <b>MSC-R-16-M17(230V50Hz)</b><br>283186 |
| 11  | 21.7 | 50 | 50 | 20 - 25  | 350 | <b>MSC-R-25-M25(230V50Hz)</b><br>283187 |
| 15  | 29.3 | 50 | 50 | 25 - 32  | 448 | <b>MSC-R-32-M32(230V50Hz)</b><br>283188 |

| Motor starters<br>actuating voltage<br>24 V DC | Price<br>See price<br>list | Std. pack | Motor protective<br>circuit breaker | Contactors     | Reversing starter<br>wiring set   | Notes  |
|--|----------------------------|-----------|-------------------------------------|----------------|---|--|
| Part no.<br>Article no.                        |                            |           |                                     |                | Mechanical<br>connection<br>module,<br>electrical<br>contact module<br>and reversing<br>connector |  |
|  |                            |           | Type                                | Type           | Type  |  |
| <b>MSC-R-0.25-M7(24VDC)</b><br>283190          |                            | 1 off     | PKZM0-0,25                          | DILM7-01(...)  | PKZM0-XRM12   | <p>The reversing starters (complete devices) consist of a PKZM0 motor protective circuit breaker and two contactors DILM.</p> <p>With the adapterless top-hat rail mounting of starters up to 12 A, only the motor-protective circuit-breaker on the top-hat rail requires an adapter. The contactors are provided with mechanical support via a mechanical connection element.</p> <p>Control wire guide with max. 6 conductors with up to 2.5 mm external diameter or 4 conductors up to 3.5 mm external diameter.</p> <p>From 16 A, the motor protective circuit breaker and contactors are mounted on the top-hat rail adapter plate. The connection of the main circuit between PKZ and contactor is established with electrical contact modules. Complete units with mechanical interlock, starters up to 12 A also with electrical interlock.</p> <p>When using auxiliary contacts DILA - XHIT ... → Chapter 1.1 (Page 38) the electrical plugs can be pulled without having to remove the front mounting auxiliary contact.</p> <p>Cannot be combined with standard auxiliary contact NHI-E...-PKZ0-C with spring-loaded terminal.</p> |
| <b>MSC-R-0.4-M7(24VDC)</b><br>283191           |                            | 1 off     | PKZM0-0,4                           | DILM7-01(...)  | PKZM0-XRM12   |  |
| <b>MSC-R-0.63-M7(24VDC)</b><br>283192          |                            | 1 off     | PKZM0-0,63                          | DILM7-01(...)  | PKZM0-XRM12   |  |
| <b>MSC-R-1-M7(24VDC)</b><br>283194             |                            | 1 off     | PKZM0-1                             | DILM7-01(...)  | PKZM0-XRM12   |  |
| <b>MSC-R-1.6-M7(24VDC)</b><br>283195           |                            | 1 off     | PKZM0-1,6                           | DILM7-01(...)  | PKZM0-XRM12   |  |
| <b>MSC-R-2.5-M7(24VDC)</b><br>283197           |                            | 1 off     | PKZM0-2,5                           | DILM7-01(...)  | PKZM0-XRM12   |  |
| <b>MSC-R-4-M7(24VDC)</b><br>283198             |                            | 1 off     | PKZM0-4                             | DILM7-01(...)  | PKZM0-XRM12   |  |
| <b>MSC-R-6.3-M7(24VDC)</b><br>283200           |                            | 1 off     | PKZM0-6,3                           | DILM7-01(...)  | PKZM0-XRM12   |  |
| <b>MSC-R-10-M7(24VDC)</b><br>283201            |                            | 1 off     | PKZM0-10                            | DILM7-01(...)  | PKZM0-XRM12   |  |
| <b>MSC-R-10-M9(24VDC)</b><br>283202            |                            | 1 off     | PKZM0-10                            | DILM9-01(...)  | PKZM0-XRM12   |  |
| <b>MSC-R-12-M12(24VDC)</b><br>283203           |                            | 1 off     | PKZM0-12                            | DILM12-01(...) | PKZM0-XRM12   |  |
| <b>MSC-R-10-M17(24VDC)</b><br>101051           |                            | 1 off     | PKZM0-10                            | DILM17-01(...) | PKZM0-XRM32   | <p><b>Further information</b></p> <p>Technical data PKZM0</p> <p>Accessories PKZ</p> <p>Technical data DILM</p> <p>Further actuation voltages</p> <p>DILM accessories</p>  |
| <b>MSC-R-12-M17(24VDC)</b><br>101052           |                            | 1 off     | PKZM0-12                            | DILM17-01(...) | PKZM0-XRM32   |  |
| <b>MSC-R-16-M17(24VDC)</b><br>283204           |                            | 1 off     | PKZM0-16                            | DILM17-01(...) | PKZM0-XRM32   |  |
| <b>MSC-R-25-M25(24VDC)</b><br>283205           |                            | 1 off     | PKZM0-25                            | DILM25-01(...) | PKZM0-XRM32   |  |
| <b>MSC-R-32-M32(24VDC)</b><br>283206           |                            | 1 off     | PKZM0-32                            | DILM32-01(...) | PKZM0-XRM32   |  |
|  |                            |           |                                     |                |   |  |

| Further information        | Page                    |
|----------------------------|-------------------------|
| Technical data PKZM0       | → Chapter 1.3           |
| Accessories PKZ            | → Chapter 1.3 (Page 10) |
| Technical data DILM        | → Chapter 1.1           |
| Further actuation voltages | → Chapter 1.1 (Page 69) |
| DILM accessories           | → Chapter 1.1 (Page 50) |

# 1.4 Motor-starter combinations

## Modules

1

### PKZM, DILM

#### Motor data

| Rated operational power | Rated operational current | Rated short-circuit current |                       |
|-------------------------|---------------------------|-----------------------------|-----------------------|
| 400 V                   | AC-3                      | 380 - 415 V                 | 380 - 415 V           |
|                         | 400 V                     | Type "1" coordination       | Type "2" coordination |

#### Setting range

| Overload trip | Short-circuit release |
|---------------|-----------------------|
|---------------|-----------------------|

| P<br>kW | $I_e$<br>A | $I_q$<br>kA | $I_q$<br>kA | $I_r$<br>A  | $I_{rm}$<br>A |
|---------|------------|-------------|-------------|-------------|---------------|
| 0.06    | 0.21       | 150         | 50          | 0.16 - 0.25 | 3.5           |
| 0.09    | 0.31       | 150         | 50          | 0.25 - 0.4  | 5.6           |
| 0.12    | 0.41       | 150         | 50          | 0.4 - 0.63  | 8.82          |
| 0.18    | 0.6        | 150         | 50          | 0.4 - 0.63  | 8.82          |
| 0.25    | 0.8        | 150         | 50          | 0.63 - 1    | 14            |
| 0.37    | 1.1        | 150         | 50          | 1 - 1.6     | 22.4          |
| 0.55    | 1.5        | 150         | 50          | 1 - 1.6     | 22.4          |
| 0.75    | 1.9        | 150         | 50          | 1.6 - 2.5   | 35            |
| 1.1     | 2.6        | 150         | 50          | 2.5 - 4     | 56            |
| 1.5     | 3.6        | 150         | 50          | 2.5 - 4     | 56            |
| 2.2     | 5          | 150         | 50          | 4 - 6.3     | 88.2          |
| 3       | 6.6        | 150         | 50          | 6.3 - 10    | 140           |
| 4       | 8.5        | 150         | 50          | 6.3 - 10    | 140           |
| 5.5     | 11.3       | 50          | 50          | 8 - 12      | 168           |
| 7.5     | 15.2       | 50          | 50          | 10 - 16     | 224           |
| 11      | 21.7       | 50          | 50          | 20 - 25     | 350           |
| 15      | 29.3       | 50          | 50          | 25 - 32     | 448           |

#### Modules PKZM0 and DILM

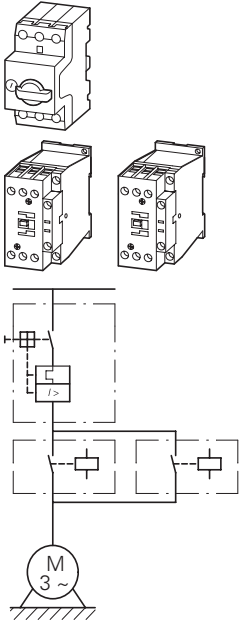

#### Modules PKZM4 and DILM

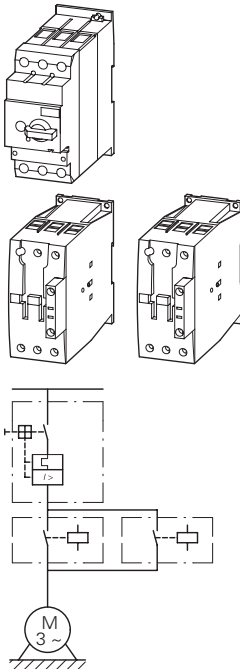

|      |      |    |    |         |     |
|------|------|----|----|---------|-----|
| 5.5  | 11.3 | 50 | 50 | 10 - 16 | 224 |
| 7.5  | 15.2 | 50 | 50 | 10 - 16 | 224 |
| 11   | 21.7 | 50 | 50 | 20 - 25 | 350 |
| 15   | 29.3 | 50 | 50 | 25 - 32 | 448 |
| 18.5 | 36   | 50 | 50 | 32 - 40 | 560 |
| 22   | 41   | 50 | 50 | 40 - 50 | 700 |
| 30   | 55   | 50 | 50 | 50 - 58 | 812 |
| 34   | 63   | 50 | 50 | 55 - 65 | 882 |

| Motor protective circuit breaker | Contactor             | Contactor             | Notes   |
|----------------------------------|-----------------------|-----------------------|---|
|                                  | Type "1" coordination | Type "2" coordination |   |
| Type                             | Type                  | Type                  |   |
| PKZM0-0,25                       | 2 x DILM7-...(…)      | 2 x DILM7-...(…)      | <p>The motor-starter combinations consist of the motor protective circuit breaker or a circuit breaker and a contactor. They conform with IEC/EN 60947-4-1 or VDE 0660 Part 102.<br/>I<sub>q</sub> = conditional rated current</p> <p><b>Further information</b></p> <p>Technical data PKZM0<br/>Accessories PKZ<br/>Technical data DILM<br/>Other operating voltages<br/>DILM accessories</p> <p><b>Page</b></p> <p>→ Chapter 1.3<br/>→ Chapter 1.3 (Page 10)<br/>→ Chapter 1.1<br/>→ Chapter 1.1 (Page 69)<br/>→ Chapter 1.1 (Page 50)</p>                |
| PKZM0-0,4                        | 2 x DILM7-...(…)      | 2 x DILM7-...(…)      |   |
| PKZM0-0,63                       | 2 x DILM7-...(…)      | 2 x DILM7-...(…)      |   |
| PKZM0-0,63                       | 2 x DILM7-...(…)      | 2 x DILM7-...(…)      |   |
| PKZM0-1                          | 2 x DILM7-...(…)      | 2 x DILM7-...(…)      |   |
| PKZM0-1,6                        | 2 x DILM7-...(…)      | 2 x DILM7-...(…)      |   |
| PKZM0-1,6                        | 2 x DILM7-...(…)      | 2 x DILM7-...(…)      |   |
| PKZM0-2,5                        | 2 x DILM7-...(…)      | 2 x DILM7-...(…)      |   |
| PKZM0-4                          | 2 x DILM7-...(…)      | 2 x DILM7-...(…)      |   |
| PKZM0-4                          | 2 x DILM7-...(…)      | 2 x DILM7-...(…)      |   |
| PKZM0-6,3                        | 2 x DILM7-...(…)      | 2 x DILM7-...(…)      |   |
| PKZM0-10                         | 2 x DILM9-...(…)      | 2 x DILM17-...(…)     |   |
| PKZM0-10                         | 2 x DILM9-...(…)      | 2 x DILM17-...(…)     |   |
| PKZM0-12                         | 2 x DILM12-...(…)     | 2 x DILM17-...(…)     |   |
| PKZM0-16                         | 2 x DILM17-...(…)     | 2 x DILM17-...(…)     |   |
| PKZM0-25                         | 2 x DILM25-...(…)     | 2 x DILM25-...(…)     |   |
| PKZM0-32                         | 2 x DILM32-...(…)     | 2 x DILM32-...(…)     |   |
| PKZM4-16                         | 2 x DILM17-...(…)     | 2 x DILM17-...(…)     | <p>The motor-starter combinations consist of the motor protective circuit breaker or a circuit breaker and a contactor. They conform with IEC/EN 60947-4-1 or VDE 0660 Part 102.<br/>I<sub>q</sub> = rated conditional short-circuit current.</p> <p><b>Further information</b></p> <p>Technical data PKZM0<br/>Accessories PKZ<br/>Technical data DILM<br/>Other operating voltages<br/>DILM accessories</p> <p><b>Page</b></p> <p>→ Chapter 1.3<br/>→ Chapter 1.3 (Page 10)<br/>→ Chapter 1.1<br/>→ Chapter 1.1 (Page 70)<br/>→ Chapter 1.1 (Page 50)</p> |
| PKZM4-16                         | 2 x DILM17-...(…)     | 2 x DILM17-...(…)     |   |
| PKZM4-25                         | 2 x DILM25-...(…)     | 2 x DILM25-...(…)     |   |
| PKZM4-32                         | 2 x DILM32-...(…)     | 2 x DILM32-...(…)     |   |
| PKZM4-40                         | 2 x DILM40(…)         | 2 x DILM40(…)         |   |
| PKZM4-50                         | 2 x DILM50(…)         | 2 x DILM50(…)         |   |
| PKZM4-58                         | 2 x DILM65(…)         | 2 x DILM65(…)         |   |
| PKZM4-63                         | 2 x DILM65(…)         | 2 x DILM65(…)         |   |

# 1.4 Motor-starter combinations

## Modules



1

### NZMN, NZMH, DILM

#### Motor data

| Rated operational power | Rated operational current | Rated short-circuit current |
|-------------------------|---------------------------|-----------------------------|
| AC-3                    | AC-3                      |                             |
| 380 V<br>400 V<br>415 V | 400 V                     | 400/415 V                   |
| P<br>kW                 | $I_e$<br>A                | $I_q$<br>kA                 |

#### Setting range

| Overload trip  | Short-circuit release   |
|--|---|
| $I_r$<br>A  | $I_{rm}$<br>A  |

#### Modules NZMN and DILM

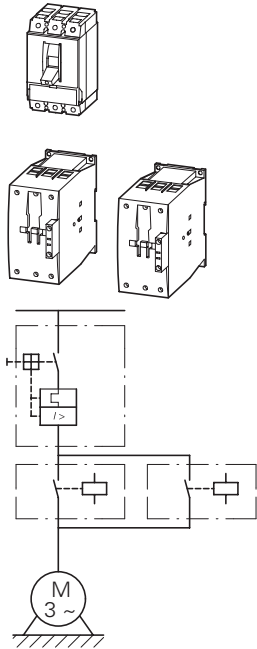

|      |      |    |            |              |
|------|------|----|------------|--------------|
| 15   | 29.3 | 50 | 25 - 32    | 320 - 448    |
| 18.5 | 36   | 50 | 32 - 40    | 320 - 560    |
| 22   | 41   | 50 | 40 - 50    | 400 - 700    |
| 30   | 55   | 50 | 50 - 63    | 504 - 882    |
| 37   | 68   | 50 | 63 - 80    | 640 - 1120   |
| 45   | 81   | 50 | 80 - 100   | 800 - 1250   |
| 55   | 99   | 50 | 80 - 100   | 800 - 1250   |
| 75   | 134  | 50 | 125 - 160  | 1280 - 2240  |
| 90   | 161  | 50 | 160 - 200  | 1600 - 2500  |
| 110  | 196  | 50 | 160 - 200  | 1600 - 2500  |
| 132  | 231  | 50 | 175 - 350  | 350 - 4900   |
| 160  | 279  | 50 | 175 - 350  | 350 - 4900   |
| 200  | 349  | 50 | 175 - 350  | 350 - 4900   |
| 250  | 437  | 50 | 225 - 450  | 450 - 6300   |
| 315  | 544  | 50 | 275 - 550  | 550 - 7700   |
| 400  | 683  | 50 | 438 - 875  | 875 - 12250  |
| 450  | 750  | 50 | 438 - 875  | 875 - 12250  |
| 500  | 820  | 50 | 438 - 875  | 875 - 12250  |
| 560  | 947  | 50 | 700 - 1400 | 1400 - 19600 |

#### Modules NZMH and DILM

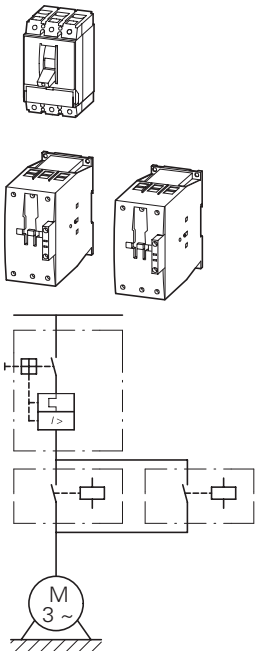

|     |     |     |           |             |
|-----|-----|-----|-----------|-------------|
| 22  | 41  | 100 | 40 - 50   | 400 - 700   |
| 30  | 55  | 100 | 50 - 63   | 504 - 882   |
| 37  | 68  | 100 | 63 - 80   | 640 - 1120  |
| 55  | 81  | 100 | 80 - 100  | 800 - 1250  |
| 55  | 100 | 100 | 100 - 125 | 1000 - 1750 |
| 75  | 134 | 100 | 125 - 160 | 1280 - 2240 |
| 30  | 55  | 100 | 45 - 90   | 90 - 1260   |
| 37  | 68  | 100 | 45 - 90   | 90 - 1260   |
| 45  | 81  | 100 | 45 - 90   | 90 - 1260   |
| 55  | 100 | 100 | 70 - 140  | 140 - 1960  |
| 75  | 134 | 100 | 70 - 140  | 140 - 1960  |
| 90  | 161 | 100 | 110 - 120 | 220 - 3080  |
| 110 | 196 | 100 | 110 - 120 | 220 - 3080  |
| 132 | 231 | 100 | 175 - 350 | 350 - 4900  |
| 160 | 279 | 100 | 175 - 350 | 350 - 4900  |
| 200 | 349 | 100 | 175 - 350 | 350 - 4900  |

| Circuit-breaker | Contactor             | Contactor             | Notes |
|-----------------|-----------------------|-----------------------|-------|
|                 | Type "1" coordination | Type "2" coordination |       |

| Type         | Type                 | Type                 |  |
|--------------|----------------------|----------------------|--|
| NZMN1-M32    | 2 x DILM40(...)      | 2 x DILM80(...)      | The motor starter combinations consist of the motor protective circuit-breaker and a contactor. They comply with IEC/EN 60947-4-1 and VDE 0660 Part 102. $I_q$ = conditional rated current.                                    |
| NZMN1-M40    | 2 x DILM40(...)      | 2 x DILM80(...)      |  |
| NZMN1-M50    | 2 x DILM50(...)      | 2 x DILM80(...)      |  |
| NZMN1-M63    | 2 x DILM65(...)      | 2 x DILM80(...)      |  |
| NZMN1-M80    | 2 x DILM80(...)      | 2 x DILM80(...)      |  |
| NZMN1-M100   | 2 x DILM95(...)      | 2 x DILM95(...)      |  |
| NZMN1-M100   | 2 x DILM115(...)     | 2 x DILM115(...)     |  |
| NZMN2-M160   | 2 x DILM150(...)     | 2 x DILM150(...)     |  |
| NZMN2-M200   | 2 x DILM185A/22(...) | 2 x DILM185A/22(...) |  |
| NZMN2-M200   | 2 x DILM225A/22(...) | 2 x DILM225A/22(...) |  |
| NZMN3-ME350  | 2 x DILM250/22(...)  | 2 x DILM250/22(...)  |  |
| NZMN3-ME350  | 2 x DILM300A/22(...) | 2 x DILM300A/22(...) |  |
| NZMN3-ME350  | 2 x DILM400/22(...)  | 2 x DILM400/22(...)  |  |
| NZMN3-ME450  | 2 x DILM500/22(...)  | 2 x DILM500/22(...)  |  |
| NZMN4-ME550  | 2 x DILM580/22(...)  | 2 x –                |  |
| NZMN4-ME875  | 2 x DILM650/22(...)  | 2 x –                |  |
| NZMN4-ME875  | 2 x DILM750/22(...)  | 2 x –                |  |
| NZMN4-ME875  | 2 x DILM820/22(...)  | 2 x –                |  |
| NZMN4-ME1400 | 2 x DILM1000/22(...) | 2 x –                |  |
| NZMH2-M50    | 2 x DILM80(...)      | 2 x DILM80(...)      | The motor-starter combinations consist of the motor protective circuit breaker or a circuit breaker and a contactor. They conform with IEC/EN 60947-4-1 or VDE 0660 Part 102. $I_q$ = rated conditional short-circuit current. |
| NZMH2-M63    | 2 x DILM80(...)      | 2 x DILM80(...)      |  |
| NZMH2-M80    | 2 x DILM80(...)      | 2 x DILM80(...)      |  |
| NZMH2-M100   | 2 x DILM95(...)      | 2 x DILM95(...)      |  |
| NZMH2-M125   | 2 x DILM115(...)     | 2 x DILM115(...)     |  |
| NZMH2-M160   | 2 x DILM150(...)     | 2 x DILM150(...)     |  |
| NZMH2-ME90   | 2 x DILM80(...)      | 2 x DILM80(...)      |  |
| NZMH2-ME90   | 2 x DILM80(...)      | 2 x DILM80(...)      |  |
| NZMH2-ME90   | 2 x DILM95(...)      | 2 x DILM95(...)      |  |
| NZMH2-ME140  | 2 x DILM115(...)     | 2 x DILM115(...)     |  |
| NZMH2-ME140  | 2 x DILM150(...)     | 2 x DILM150(...)     |  |
| NZMH2-ME220  | 2 x DILM185A/22(...) | 2 x DILM185A/22(...) |  |
| NZMH2-ME220  | 2 x DILM225A/22(...) | 2 x DILM225A/22(...) |  |
| NZMH3-ME350  | 2 x DILM250/22(...)  | 2 x DILM250/22(...)  |  |
| NZMH3-ME350  | 2 x DILM300A/22(...) | 2 x DILM300A/22(...) |  |
| NZMH3-ME350  | 2 x DILM400/22(...)  | 2 x DILM400/22(...)  |  |

# 1.4

## Motor-starter combinations

DOL starters

1

### MSC-D.../BBA

#### Motor data

| Motor rating            | Rated operational current | Rated short-circuit current |                       |
|-------------------------|---------------------------|-----------------------------|-----------------------|
| AC-3                    | AC-3                      | 380 - 415 V                 | 380 - 415 V           |
| 380 V<br>400 V<br>415 V | 400 V                     | Type "1" coordination       | Type "2" coordination |

| P<br>kW | I <sub>e</sub><br>A | I <sub>q</sub><br>kA | I <sub>q</sub><br>kA |
|---------|---------------------|----------------------|----------------------|
|---------|---------------------|----------------------|----------------------|

#### Setting range

| Overload trip | Short-circuit release |
|---------------|-----------------------|
|---------------|-----------------------|



#### Motor starters actuating voltage 230 V 50 Hz

Part no.  
Article no.

Price  
See price list

Std.  
pack

Complete devices PKZ and DIL on BBA

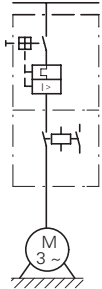
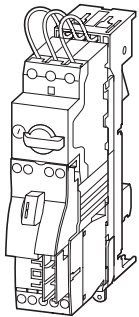

Complete devices PKZ and DIL on BBA

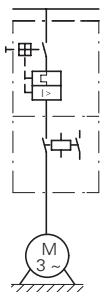
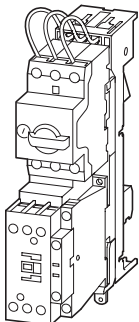

|              |             |     |    |             |      |   |       |
|--------------|-------------|-----|----|-------------|------|---|-------|
| 0.06         | 0.21        | 100 | 50 | 0.16 - 0.25 | 3.5  | <b>MSC-D-0.25-M7(230V50Hz)/BBA<sup>1)</sup></b><br>102737 | 1 off |
| 0.09         | 0.31        | 100 | 50 | 0.25 - 0.4  | 5.6  | <b>MSC-D-0.4-M7(230V50Hz)/BBA<sup>1)</sup></b><br>102738  | 1 off |
| 0.12<br>0.18 | 0.41<br>0.6 | 100 | 50 | 0.4 - 0.63  | 8.82 | <b>MSC-D-0.63-M7(230V50Hz)/BBA<sup>1)</sup></b><br>102739 | 1 off |
| 0.25         | 0.8         | 100 | 50 | 0.63 - 1    | 14   | <b>MSC-D-1-M7(230V50Hz)/BBA<sup>1)</sup></b><br>102950    | 1 off |
| 0.37<br>0.55 | 1.1<br>1.5  | 100 | 50 | 1 - 1.6     | 22.4 | <b>MSC-D-1.6-M7(230V50Hz)/BBA<sup>1)</sup></b><br>102951  | 1 off |
| 0.75         | 1.9         | 100 | 50 | 1.6 - 2.5   | 35   | <b>MSC-D-2.5-M7(230V50Hz)/BBA<sup>1)</sup></b><br>102952  | 1 off |
| 1.1<br>1.5   | 2.6<br>3.6  | 100 | 50 | 2.5 - 4     | 56   | <b>MSC-D-4-M7(230V50Hz)/BBA<sup>1)</sup></b><br>102953    | 1 off |
| 2.2          | 5           | 100 | 50 | 4 - 6.3     | 88.2 | <b>MSC-D-6.3-M7(230V50Hz)/BBA<sup>1)</sup></b><br>102954  | 1 off |
| 3            | 6.6         | 100 | —  | 6.3 - 10    | 140  | <b>MSC-D-10-M7(230V50Hz)/BBA</b><br>102955                | 1 off |
| 4            | 8.5         | 100 | —  | 6.3 - 10    | 140  | <b>MSC-D-10-M9(230V50Hz)/BBA</b><br>102956                | 1 off |
| 5.5          | 11.3        | 100 | —  | 8 - 12      | 168  | <b>MSC-D-12-M12(230V50Hz)/BBA</b><br>102957               | 1 off |
| 7.5          | 15.2        | 50  | —  | 10 - 16     | 224  | <b>MSC-D-16-M15(230V50Hz)/BBA</b><br>102958               | 1 off |
| 3            | 6.6         | 100 | 50 | 6.3 - 10    | 140  | <b>MSC-D-10-M17(230V50Hz)/BBA</b><br>102959               | 1 off |
| 4            | 8.5         | 100 | 50 | 8 - 12      | 168  | <b>MSC-D-12-M17(230V50Hz)/BBA</b><br>102960               | 1 off |
| 5.5          | 11.3        | 100 | 50 | 8 - 12      | 168  | <b>MSC-D-12-M17(230V50Hz)/BBA</b><br>102960               | 1 off |
| 7.5          | 15.2        | 50  | 50 | 10 - 16     | 224  | <b>MSC-D-16-M17(230V50Hz)/BBA<sup>1)</sup></b><br>102961  | 1 off |
| 11           | 21.7        | 50  | 50 | 20 - 25     | 350  | <b>MSC-D-25-M25(230V50Hz)/BBA<sup>1)</sup></b><br>102962  | 1 off |
| 15           | 29.3        | 50  | 50 | 25 - 32     | 448  | <b>MSC-D-32-M32(230V50Hz)/BBA<sup>1)</sup></b><br>102963  | 1 off |



| Motor starters<br>actuating voltage<br>24 V DC<br>Part no.<br>Article no. | Price<br>See price<br>list | Std.<br>pack | Motor<br>protective<br>circuit<br>breaker | Contactor      | DOL starter<br>wiring set<br><br>Mechanical con-<br>nection module<br>and electrical<br>contact module | Busbar<br>adapter | Notes  |
|---|----------------------------|--------------|---|----------------|--|-------------------|--|
|   |                            |              | Type                                      | Type           | Type   | Type              |  |
| <b>MSC-D-0.25-M7(24VDC)/BBA</b> <sup>1)</sup><br>102964                   |                            | 1 off        | PKZM0-0,25                                | DILM7-10(...)  | PKZM0-XDM12  | BBA0-25           | The DOL starters (complete devices) consist of a motor protective circuit breaker PKZM0 and a contactor DILM. These combinations are mounted on busbars.<br>The connection of the main circuit between PKZ and contactor is established with electrical contact modules.<br>Cannot be combined with standard auxiliary contact NHI-E-...-PKZ0-C with spring-loaded terminal. |
| <b>MSC-D-0.4-M7(24VDC)/BBA</b> <sup>1)</sup><br>102965                    |                            | 1 off        | PKZM0-0,4                                 | DILM7-10(...)  | PKZM0-XDM12  | BBA0-25           |  |
| <b>MSC-D-0.63-M7(24VDC)/BBA</b> <sup>1)</sup><br>102966                   |                            | 1 off        | PKZM0-0,63                                | DILM7-10(...)  | PKZM0-XDM12  | BBA0-25           |  |
| <b>MSC-D-1-M7(24VDC)/BBA</b> <sup>1)</sup><br>102967                      |                            | 1 off        | PKZM0-1                                   | DILM7-10(...)  | PKZM0-XDM12  | BBA0-25           |  |
| <b>MSC-D-1.6-M7(24VDC)/BBA</b> <sup>1)</sup><br>102968                    |                            | 1 off        | PKZM0-1,6                                 | DILM7-10(...)  | PKZM0-XDM12  | BBA0-25           |  |
| <b>MSC-D-2.5-M7(24VDC)/BBA</b> <sup>1)</sup><br>102969                    |                            | 1 off        | PKZM0-2,5                                 | DILM7-10(...)  | PKZM0-XDM12  | BBA0-25           |  |
| <b>MSC-D-4-M7(24VDC)/BBA</b> <sup>1)</sup><br>102970                      |                            | 1 off        | PKZM0-4                                   | DILM7-10(...)  | PKZM0-XDM12  | BBA0-25           |  |
| <b>MSC-D-6.3-M7(24VDC)/BBA</b><br>102971                                  |                            | 1 off        | PKZM0-6,3                                 | DILM7-10(...)  | PKZM0-XDM12  | BBA0-25           |  |
| <b>MSC-D-10-M7(24VDC)/BBA</b><br>102972                                   |                            | 1 off        | PKZM0-10                                  | DILM7-10(...)  | PKZM0-XDM12  | BBA0-25           |  |
| <b>MSC-D-10-M9(24VDC)/BBA</b><br>102973                                   |                            | 1 off        | PKZM0-10                                  | DILM9-10(...)  | PKZM0-XDM12  | BBA0-25           |  |
| <b>MSC-D-12-M12(24VDC)/BBA</b><br>102974                                  |                            | 1 off        | PKZM0-12                                  | DILM12-10(...) | PKZM0-XDM12  | BBA0-25           |  |
| <b>MSC-D-16-M15(24VDC)/BBA</b><br>102975                                  |                            | 1 off        | PKZM0-16                                  | DILM15-10(...) | PKZM0-XDM12  | BBA0-25           |  |
| <b>MSC-D-10-M17(24VDC)/BBA</b><br>102976                                  |                            | 1 off        | PKZM0-10                                  | DILM17-10(...) | PKZM0-XM32DE   | BBA0-32           | <b>Further information</b><br>Technical data PKZM0<br>Accessories PKZ<br>Technical data DILM<br>DILM accessories<br><br><sup>1)</sup> To assemble Type F starters that conform with UL508, incoming terminals BK25/3-PKZ0-E and, if necessary, three-phase terminal blocks B3.../...-PKZ0 can be added to motor starter combinations.<br>Type F starter → Page 28            |
| <b>MSC-D-12-M17(24VDC)/BBA</b><br>102977                                  |                            | 1 off        | PKZM0-12                                  | DILM17-10(...) | PKZM0-XM32DE   | BBA0-32           |  |
| <b>MSC-D-16-M17(24VDC)/BBA</b><br>102978                                  |                            | 1 off        | PKZM0-16                                  | DILM17-10(...) | PKZM0-XM32DE   | BBA0-32           |  |
| <b>MSC-D-25-M25(24VDC)/BBA</b><br>102979                                  |                            | 1 off        | PKZM0-25                                  | DILM25-10(...) | PKZM0-XM32DE   | BBA0-32           |  |
| <b>MSC-D-32-M32(24VDC)/BBA</b><br>102980                                  |                            | 1 off        | PKZM0-32                                  | DILM32-10(...) | PKZM0-XM32DE   | BBA0-32           |  |

# 1.4 Motor-starter combinations

## Reversing starters

1

### MSC-R.../BBA

**Motor starters  
actuating voltage  
230 V 50 Hz**

**Price**  
See price  
list

#### Motor data

| Motor rating            | Rated operational current | Rated short-circuit current   |                               |
|-------------------------|---------------------------|-------------------------------|-------------------------------|
| AC-3                    | AC-3                      | 380 - 415 V                   | 380 - 415 V                   |
| 380 V<br>400 V<br>415 V | 400 V                     | Type "1"<br>coordina-<br>tion | Type "2"<br>coordina-<br>tion |
| P<br>kW                 | $I_e$<br>A                | $I_q$<br>kA                   | $I_q$<br>kA                   |

#### Setting range

| Overload trip | Short-circuit release |
|---------------|-----------------------|
|---------------|-----------------------|

**Part no.**  
Article no.



**Complete devices PKZ and DILM on BBA for reversing starters**

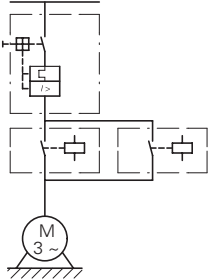
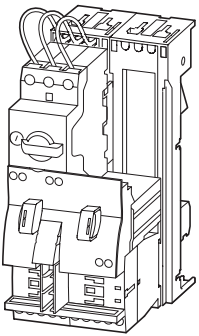

**Complete devices PKZ and DILM on BBA for reversing starters**

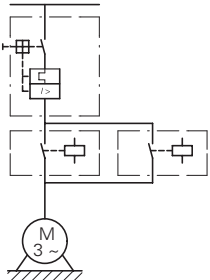
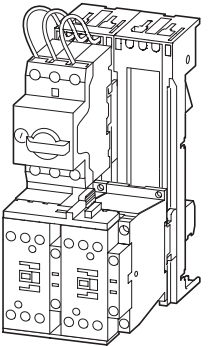

|              |             |     |    |             |      |  |
|--------------|-------------|-----|----|-------------|------|--|
| 0.06         | 0.21        | 100 | 50 | 0.16 - 0.25 | 3.5  | <b>MSC-R-0.25-M7(230V50Hz)/BBA</b><br>102981 |
| 0.09         | 0.31        | 100 | 50 | 0.25 - 0.4  | 5.6  | <b>MSC-R-0.4-M7(230V50Hz)/BBA</b><br>102982  |
| 0.12<br>0.18 | 0.41<br>0.6 | 100 | 50 | 0.4 - 0.63  | 8.82 | <b>MSC-R-0.63-M7(230V50Hz)/BBA</b><br>102983 |
| 0.25         | 0.8         | 100 | 50 | 0.63 - 1    | 14   | <b>MSC-R-1-M7(230V50Hz)/BBA</b><br>102984    |
| 0.37<br>0.55 | 1.1<br>1.5  | 100 | 50 | 1 - 1.6     | 22.4 | <b>MSC-R-1.6-M7(230V50Hz)/BBA</b><br>102985  |
| 0.75         | 1.9         | 100 | 50 | 1.6 - 2.5   | 35   | <b>MSC-R-2.5-M7(230V50Hz)/BBA</b><br>102986  |
| 1.1<br>1.5   | 2.6<br>3.6  | 100 | 50 | 2.5 - 4     | 56   | <b>MSC-R-4-M7(230V50Hz)/BBA</b><br>102987    |
| 2.2          | 5           | 100 | 50 | 4 - 6.3     | 88.2 | <b>MSC-R-6.3-M7(230V50Hz)/BBA</b><br>102988  |
| 3            | 6.6         | 100 | –  | 6.3 - 10    | 140  | <b>MSC-R-10-M7(230V50Hz)/BBA</b><br>102989   |
| 4            | 8.5         | 100 | –  | 6.3 - 10    | 140  | <b>MSC-R-10-M9(230V50Hz)/BBA</b><br>102990   |
| 5.5          | 11.3        | 100 | –  | 8 - 12      | 168  | <b>MSC-R-12-M12(230V50Hz)/BBA</b><br>102991  |
| 3            | 6.6         | 100 | 50 | 6.3 - 10    | 140  | <b>MSC-R-10-M17(230V50Hz)/BBA</b><br>102992  |
| 4            | 8.5         | 100 | 50 | 8 - 12      | 168  | <b>MSC-R-12-M17(230V50Hz)/BBA</b><br>102993  |
| 5.5          | 11.3        | 100 | 50 | 8 - 12      | 168  | <b>MSC-R-12-M17(230V50Hz)/BBA</b><br>102993  |
| 7.5          | 15.2        | 50  | 50 | 10 - 16     | 224  | <b>MSC-R-16-M17(230V50Hz)/BBA</b><br>102994  |
| 11           | 21.7        | 50  | 50 | 20 - 25     | 350  | <b>MSC-R-25-M25(230V50Hz)/BBA</b><br>102995  |
| 15           | 29.3        | 50  | 50 | 25 - 32     | 448  | <b>MSC-R-32-M32(230V50Hz)/BBA</b><br>102996  |

| Motor starters<br>actuating voltage<br>24 V DC | Price<br>See price<br>list | Std.<br>pack | Motor<br>protective<br>circuit<br>breaker | Contactor      | Wiring set<br>Reversing<br>starters  | Busbar<br>adapter | Notes   |
|--|----------------------------|--------------|---|----------------|--|-------------------|---|
| <b>Part no.</b><br>Article no.                 |                            |              |   |                | Mechanical con-<br>nection module,<br>electrical contact<br>module and<br>reversing connec-<br>tor |                   |   |
| Type   | Type                       | Type         | Type                                      | Type           | Type   | Type              |   |
| <b>MSC-R-0.25-M7(24VDC)/BBA</b><br>102997      | 1 off                      | PKZM0-0,25   | 2 x                                       | DILM7-01(...)  | PKZM0-XRM12  | BBA0R-25          | The reversing starters (complete devices) consist of a PKZM0 motor protective circuit breaker and two contactors DILM. These combinations are mounted on bus-bars. The connection of the main circuit between PKZ and contactor is established with electrical contact modules. Complete units with mechanical interlock, starters up to 12 A also with electrical interlock. |
| <b>MSC-R-0.4-M7(24VDC)/BBA</b><br>102998       | 1 off                      | PKZM0-0,4    | 2 x                                       | DILM7-01(...)  | PKZM0-XRM12  | BBA0R-25          |   |
| <b>MSC-R-0.63-M7(24VDC)/BBA</b><br>102999      | 1 off                      | PKZM0-0,63   | 2 x                                       | DILM7-01(...)  | PKZM0-XRM12  | BBA0R-25          |   |
| <b>MSC-R-1-M7(24VDC)/BBA</b><br>103000         | 1 off                      | PKZM0-1      | 2 x                                       | DILM7-01(...)  | PKZM0-XRM12  | BBA0R-25          |   |
| <b>MSC-R-1.6-M7(24VDC)/BBA</b><br>103001       | 1 off                      | PKZM0-1,6    | 2 x                                       | DILM7-01(...)  | PKZM0-XRM12  | BBA0R-25          |   |
| <b>MSC-R-2.5-M7(24VDC)/BBA</b><br>103002       | 1 off                      | PKZM0-2,5    | 2 x                                       | DILM7-01(...)  | PKZM0-XRM12  | BBA0R-25          |   |
| <b>MSC-R-4-M7(24VDC)/BBA</b><br>103003         | 1 off                      | PKZM0-4      | 2 x                                       | DILM7-01(...)  | PKZM0-XRM12  | BBA0R-25          |   |
| <b>MSC-R-6.3-M7(24VDC)/BBA</b><br>103004       | 1 off                      | PKZM0-6,3    | 2 x                                       | DILM7-01(...)  | PKZM0-XRM12  | BBA0R-25          |   |
| <b>MSC-R-10-M7(24VDC)/BBA</b><br>103005        | 1 off                      | PKZM0-10     | 2 x                                       | DILM7-01(...)  | PKZM0-XRM12  | BBA0R-25          |   |
| <b>MSC-R-10-M9(24VDC)/BBA</b><br>103006        | 1 off                      | PKZM0-10     | 2 x                                       | DILM9-01(...)  | PKZM0-XRM12  | BBA0R-25          |   |
| <b>MSC-R-12-M12(24VDC)/BBA</b><br>103007       | 1 off                      | PKZM0-12     | 2 x                                       | DILM12-01(...) | PKZM0-XRM12  | BBA0R-25          |   |
| <b>MSC-R-10-M17(24VDC)/BBA</b><br>103008       | 1 off                      | PKZM0-10     | 2 x                                       | DILM17-01(...) | PKZM0-XM32DE+<br>DILM32-XRL  | BBA0R-32          |   |
| <b>MSC-R-12-M17(24VDC)/BBA</b><br>103009       | 1 off                      | PKZM0-12     | 2 x                                       | DILM17-01(...) | PKZM0-XM32DE+<br>DILM32-XRL  | BBA0R-32          |   |
| <b>MSC-R-16-M17(24VDC)/BBA</b><br>103010       | 1 off                      | PKZM0-16     | 2 x                                       | DILM17-01(...) | PKZM0-XM32DE+<br>DILM32-XRL  | BBA0R-32          |   |
| <b>MSC-R-25-M25(24VDC)/BBA</b><br>103011       | 1 off                      | PKZM0-25     | 2 x                                       | DILM25-01(...) | PKZM0-XM32DE+<br>DILM32-XRL  | BBA0R-32          |   |
| <b>MSC-R-32-M32(24VDC)/BBA</b><br>103012       | 1 off                      | PKZM0-32     | 2 x                                       | DILM32-01(...) | PKZM0-XM32DE+<br>DILM32-XRL  | BBA0R-32          |   |

| Further information  | Page                    |
|----------------------|-------------------------|
| Technical data PKZM0 | → Chapter 1.3           |
| Accessories PKZ      | → Chapter 1.3 (Page 10) |
| Technical data DILM  | → Chapter 1.1           |
| DILM accessories     | → Chapter 1.1 (Page 50) |

# 1.4

## Motor-starter combinations

### Type F starter combinations

#### 1 PKZMO, DILM, BK...

| Maximum motor rating   |       |       |       | Setting range |                       | Rated short-circuit breaking capacity $I_{cn}$ |                     |       | Extension terminal | Motor protective circuit breaker | Contactor |
|------------------------|-------|-------|-------|---------------|-----------------------|--|---------------------|-------|--------------------|----------------------------------|-----------|
| Alternating current HP |       |       |       | Overload trip | Short-circuit release | 240 V  | 480 V               | 600 V | Type               | Type                             | Type      |
| 200 V                  | 230 V | 460 V | 575 V |               |                       | 277 V <sup>2)</sup>                            | 347 V <sup>2)</sup> |       |                    |                                  |           |
| 208 V                  | 240 V | 480 V | 600 V |               |                       |  |                     |       |                    |                                  |           |

| HP                            | HP | HP | HP | $I_r$<br>A  | $I_{lm}$<br>A | kA | kA | kA | Type          | Type       | Type           |
|-------------------------------|----|----|----|-------------|---------------|----|----|----|---------------|------------|----------------|
| <b>Modules PKZMO, DIL, BK</b> |    |    |    |             |               |    |    |    |               |            |                |
| 1)                            |    |    |    | 0.1 - 0.16  | 2.2           | 65 | 65 | 50 | BK25/3-PKZO   | PKZMO-0,16 | DILEM...(...)  |
|                               |    |    |    | 0.1 - 0.16  | 2.2           | 65 | 65 | 50 | BK25/3-PKZO   | PKZMO-0,16 | DILM7...(...)  |
|                               |    |    |    | 0.16 - 0.25 | 3.4           | 65 | 65 | 50 | BK25/3-PKZO   | PKZMO-0,25 | DILEM...(...)  |
|                               |    |    |    | 0.16 - 0.25 | 3.4           | 65 | 65 | 50 | BK25/3-PKZO   | PKZMO-0,25 | DILM7...(...)  |
|                               |    |    |    | 0.25 - 0.4  | 5.6           | 65 | 65 | 50 | BK25/3-PKZO   | PKZMO-0,4  | DILEM...(...)  |
|                               |    |    |    | 0.25 - 0.4  | 5.6           | 65 | 65 | 50 | BK25/3-PKZO   | PKZMO-0,4  | DILM7...(...)  |
|                               |    |    |    | 0.4 - 0.63  | 8.8           | 65 | 65 | 50 | BK25/3-PKZO   | PKZMO-0,63 | DILEM...(...)  |
|                               |    |    |    | 0.4 - 0.63  | 8.8           | 65 | 65 | 50 | BK25/3-PKZO   | PKZMO-0,63 | DILM7...(...)  |
| ½                             | ½  |    |    | 0.63 - 1    | 14            | 65 | 65 | 50 | BK25/3-PKZO   | PKZMO-1    | DILEM...(...)  |
| ½                             | ½  |    |    | 0.63 - 1    | 14            | 65 | 65 | 50 | BK25/3-PKZO   | PKZMO-1    | DILM7...(...)  |
| ¾                             | 1  |    |    | 1 - 1.6     | 22            | 65 | 65 | 50 | BK25/3-PKZO   | PKZMO-1,6  | DILEM...(...)  |
| ¾                             | 1  |    |    | 1 - 1.6     | 22            | 65 | 65 | 50 | BK25/3-PKZO   | PKZMO-1,6  | DILM7...(...)  |
| ½                             | ½  | 1  | 1½ | 1.6 - 2.5   | 35            | 65 | 65 | 50 | BK25/3-PKZO   | PKZMO-2,5  | DILEM...(...)  |
| ½                             | ½  | 1  | 1½ | 1.6 - 2.5   | 35            | 65 | 65 | 50 | BK25/3-PKZO   | PKZMO-2,5  | DILM7...(...)  |
| 1                             | 1  | 2  | 3  | 2.5 - 4     | 56            | 65 | 65 | 50 | BK25/3-PKZO   | PKZMO-4    | DILEM...(...)  |
| 1                             | 1  | 2  | 3  | 2.5 - 4     | 56            | 65 | 65 | 50 | BK25/3-PKZO   | PKZMO-4    | DILM7...(...)  |
| 1½                            | 1½ | 3  | 5  | 4 - 6.3     | 88            | 65 | 65 | 50 | BK25/3-PKZO   | PKZMO-6,3  | DILEM...(...)  |
| 1½                            | 1½ | 3  | 5  | 4 - 6.3     | 88            | 65 | 65 | 50 | BK25/3-PKZO   | PKZMO-6,3  | DILM7...(...)  |
| 3                             | 3  | 7½ | 10 | 6.3 - 11    | 140           | 65 | 65 | 50 | BK25/3-PKZO   | PKZMO-10   | DILM9...(...)  |
| 3                             | 3  | 7½ | –  | 9 - 12      | 168           | 65 | 65 | 50 | BK25/3-PKZO   | PKZMO-12   | DILM12...(...) |
| 3                             | 5  | 10 | –  | 10 - 16     | 224           | 50 | 50 | –  | BK50/3-PKZ4-E | PKZMO-16   | DILM17...(...) |
| 3                             | 5  | 10 | –  | 10 - 16     | 224           | 18 | 18 | –  | BK50/3-PKZ4-E | PKZMO-16   | DILM17...(...) |
| 5                             | 5  | 10 | –  | 16 - 20     | 280           | 18 | 18 | –  | BK50/3-PKZ4-E | PKZMO-20   | DILM25...(...) |
| 5                             | 7½ | 15 | –  | 20 - 25     | 350           | 18 | 18 | –  | BK50/3-PKZ4-E | PKZMO-25   | DILM25...(...) |
| 7½                            | 10 | 20 | –  | 25 - 32     | 448           | 18 | 18 | –  | BK50/3-PKZ4-E | PKZMO-32   | DILM32...(...) |
| <b>Modules PKZM4, DIL, BK</b> |    |    |    |             |               |    |    |    |               |            |                |
| 3                             | 5  | 10 | 15 | 10 - 16     | 224           | 65 | 65 | 50 | BK50/3-PKZ4-E | PKZM4-16   | DILM17...(...) |
| 5                             | 7½ | 15 | 20 | 16 - 27     | 350           | 65 | 65 | 50 | BK50/3-PKZ4-E | PKZM4-25   | DILM25...(...) |
| 7½                            | 10 | 25 | 30 | 24 - 34     | 448           | 65 | 65 | 50 | BK50/3-PKZ4-E | PKZM4-32   | DILM32...(...) |
| 10                            | 15 | 30 | 30 | 32 - 40     | 560           | 65 | 65 | 50 | BK50/3-PKZ4-E | PKZM4-40   | DILM40(...)    |
| 10                            | 15 | 30 | –  | 40 - 52     | 700           | 65 | 65 | –  | BK50/3-PKZ4-E | PKZM4-50   | DILM50(...)    |
| 15                            | 15 | 40 | –  | 50 - 56     | 812           | 65 | 65 | –  | BK50/3-PKZ4-E | PKZM4-58   | DILM65(...)    |
| 15                            | 15 | 40 | –  | 52 - 58     | 882           | 65 | 65 | –  | BK50/3-PKZ4-E | PKZM4-63   | DILM65(...)    |

**Notes**

Device for world markets  $\Delta$  IEC UL/CSA  
 Service factor (SF)  
 Set value  $I_r$  on the current scale, depending on the load factor  
 $SF=1.15 \rightarrow I_r = 1 \times I_{n\text{ mot}}$   
 $SF=1.0 \rightarrow I_r = 0.9 \times I_{n\text{ mot}}$

1) Calculate motor power in this range according to the rated operational current. Stated values to NEC Table 430 - 150.  
 2) Suitable for networks with grounded star-point  
 Type F starter combinations do not need an upstream protective device.  
 For use in Canada, the switch must be fitted with an AK-PKZO.

## DILM, ZE, ZB, Z5, ZW7

### Rating data for approved types<sup>1)</sup>

| Maximum motor rating   |                      |                      |                      | Max. rated motor current | Contactor | Overload relay | Maximum short-circuit protective device for North America |                               |
|------------------------|----------------------|----------------------|----------------------|--------------------------|-----------|----------------|---|-------------------------------|
| Alternating current HP |                      |                      |                      |                          |           |                | Fuse CEC or NEC   | Circuit-breaker <sup>2)</sup> |
| 200 V<br>208 V<br>HP   | 230 V<br>240 V<br>HP | 460 V<br>480 V<br>HP | 575 V<br>600 V<br>HP | A                        | Type      | Type           | Continuous current  | Short-circuit release         |

### Modules DIL, Z

|     |     |     |     |      |                |               |             |      |       |
|-----|-----|-----|-----|------|----------------|---------------|-------------|------|-------|
| –   | –   | ½   | ½   | 1    | DILEM-...(…)   | ZE-1.0        | 3           | 15   | –     |
| –   | –   | ¾   | 1   | 1.4  | DILEM-...(…)   | ZE-1.6        | 6           | 15   | –     |
| ½   | ½   | 1   | 1½  | 2.3  | DILEM-...(…)   | ZE-2.4        | 6           | 15   | –     |
| –   | 1   | 2   | 3   | 3.9  | DILEM-...(…)   | ZE-4          | 15          | 15   | –     |
| 1½  | 1½  | 3   | –   | 6    | DILEM-...(…)   | ZE-6          | 20          | 15   | –     |
| –   | 2   | –   | –   | 6.8  | DILEM-...(…)   | ZE-9          | 35          | 15   | –     |
| 2   | 2   | 5   | 5   | 7.8  | DILEM-...(…)   | ZE-9          | 35          | 15   | –     |
| 2   | 3   | 5   | 5   | 9.6  | DILEM-...(…)   | ZE-12         | 45          | –    | –     |
| –   | –   | ½   | ½   | 1    | DILM7-...(…)   | ZB12-1        | 3           | 25   | 200   |
| –   | –   | ¾   | 1   | 1.4  | DILM7-...(…)   | ZB12-1,6      | 6           | 25   | 200   |
| ½   | ½   | 1   | 1½  | 2.3  | DILM7-...(…)   | ZB12-2,4      | 6           | 25   | 200   |
| 1   | 1   | 2   | 3   | 3.9  | DILM7-...(…)   | ZB12-4        | 15          | 25   | 200   |
| 1½  | ½   | 3   | –   | 6    | DILM7-...(…)   | ZB12-6        | 20          | 25   | 200   |
| –   | –   | –   | 7½  | 9    | DILM9-...(…)   | ZB12-10       | 25          | 25   | 200   |
| –   | 3   | 5   | 7½  | 9.6  | DILM12-...(…)  | ZE-12         | 25          | 25   | 200   |
| –   | –   | 7½  | 10  | 11   | DILM12-...(…)  | ZB12-12       | 45          | 25   | 200   |
| –   | 5   | 10  | –   | 15.2 | DILM15-...(…)  | ZB12-16       | 60          | 40   | 320   |
| –   | –   | ½   | ½   | 1    | DILM17-...(…)  | ZB32-1        | 3           | 25   | 200   |
| –   | –   | ¾   | 1   | 1.4  | DILM17-...(…)  | Z78447        | 6           | 25   | 200   |
| ½   | ½   | 1   | 1½  | 2.3  | DILM17-...(…)  | ZB32-2,4      | 6           | 25   | 200   |
| 1   | 1   | 2   | 3   | 3.9  | DILM17-...(…)  | ZB32-4        | 15          | 25   | 200   |
| ½   | 1½  | 3   | –   | 6    | DILM17-...(…)  | ZB32-6        | 20          | 25   | 200   |
| –   | 3   | 5   | 7½  | 9.6  | DILM17-...(…)  | ZB32-10       | 25          | 25   | 200   |
| –   | –   | 7½  | 10  | 11   | DILM17-...(…)  | ZB32-16       | 40          | 30   | 320   |
| –   | 5   | 10  | –   | 15.2 | DILM17-...(…)  | ZB32-16       | 40          | 30   | 320   |
| –   | 7½  | 15  | 20  | 22   | DILM25-...(…)  | ZB32-24       | 90          | 100  | 1200  |
| –   | 10  | 20  | 25  | 32.2 | DILM32-...(…)  | ZB32-32       | 125         | 125  | 1200  |
| –   | 3   | 5   | 7½  | 9.6  | DILM40(…)      | ZB65-10       | 40          | 40   | 380   |
| –   | 5   | 10  | 10  | 15.2 | DILM40(…)      | ZB65-16       | 60          | 60   | 760   |
| –   | 7½  | 20  | 25  | 32.2 | DILM40(…)      | ZB65-24       | 90          | 90   | 1200  |
| –   | 10  | 20  | 30  | 34   | DILM40(…)      | ZB65-40       | 125         | 125  | 1200  |
| –   | 20  | 40  | 50  | 54   | DILM50(…)      | ZB65-57       | 200         | 150  | 2000  |
| –   | 20  | 50  | 50  | 63   | DILM65(…)      | ZB65-65       | 200         | 160  | 2000  |
| –   | 25  | 50  | 60  | 68   | DILM80(…)      | ZB150-70      | 250         | 250  | 2500  |
| –   | 30  | 75  | 100 | 99   | DILM95(…)      | ZB150-100     | 400         | 400  | 3200  |
| –   | 40  | 100 | 100 | 124  | DILM115(…)     | ZB150-125     | 500         | 500  | 4000  |
| –   | 60  | 125 | 125 | 156  | DILM150(…)     | ZB150-150     | 600         | 600  | 4800  |
| 50  | 60  | 125 | 150 | 156  | DILM185A/22(…) | Z5-160/FF225A | 600 CLASS J | 600  | 7200  |
| 60  | 75  | 150 | 200 | 192  | DILM225A/22(…) | Z5-220/FF225A | 800 CLASS J | 800  | 16000 |
| 75  | 100 | 200 | 250 | 248  | DILM250/22(…)  | Z5-250/FF250  | 700 CLASS J | 600  | –     |
| 100 | 125 | 250 | 300 | 312  | DILM300A/22(…) | ZW7-400       | 1000        | 1000 | –     |
| 125 | 150 | 300 | 400 | 382  | DILM400/22(…)  | ZW7-400       | 1000        | 1000 | –     |
| 150 | 200 | 400 | 500 | 480  | DILM500/22(…)  | ZW7-540       | 1000        | 600  | –     |

### Notes

<sup>1)</sup> Devices for world markets IEC ≙ UL/CSA

<sup>2)</sup> Circuit-breaker -> See catalog

# 1.4 Motor-starter combinations

## Function blocks

### 1 NZMH...S...CNA, DILM..., ZB, Z5, ZW7

#### Rating data for approved types

Maximum motor rating  
Alternating current HP

Max. rated motor current

Rated short-circuit breaking capacity

#### Setting range

Overload trip

Short-circuit releases

#### Circuit-breaker

#### Contactor

#### Overload relay

Minimum enclosure volume

200 V 230 V 460 V 575 V  
208 V 240 V 480 V 600 V

480 V 600 Y 600 V  
347 V<sup>1)</sup>

Type

Type

Type

HP HP HP HP A kA kA kA A A cm<sup>3</sup>



#### Module NZMH...S...CNA, DILM, Z

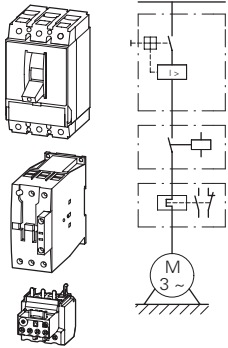

| HP  | HP  | HP  | HP  | A    | kA  | kA | kA | A         | A           | Type            | Type          | Type         | cm <sup>3</sup> |
|-----|-----|-----|-----|------|-----|----|----|-----------|-------------|-----------------|---------------|--------------|-----------------|
| –   | –   | –   | ½   | 0.9  | 100 | 50 | –  | 0.6 - 1   | 12.8 - 22.5 | NZMH2-S1.6-CNA  | DILM17-...(…) | ZB32-1       | 81.5            |
| –   | –   | ½   | ¾   | 1.3  | 100 | 50 | –  | 1 - 1.6   | 12.8 - 22.5 | NZMH2-S1.6-CNA  | DILM17-...(…) | ZB32-1,6     | 81.5            |
| –   | –   | ¾   | –   | 1.6  | 100 | 50 | –  | 1 - 1.6   | 19.2 - 33.6 | NZMH2-S2.4-CNA  | DILM17-...(…) | ZB32-1,6     | 81.5            |
| –   | –   | 1   | 1   | 2.1  | 100 | 50 | –  | 1.6 - 2.4 | 19.2 - 33.6 | NZMH2-S2.4-CNA  | DILM17-...(…) | ZB32-2,4     | 81.5            |
| –   | ½   | –   | 1½  | 2.4  | 100 | 50 | –  | 1.6 - 2.4 | 32 - 56     | NZMH2-S5-CNA    | DILM17-...(…) | ZB32-2,4     | 81.5            |
| ¾   | ¾   | 2   | 3   | 3.9  | 100 | 50 | –  | 2.4 - 4   | 32 - 56     | NZMH2-S5-CNA    | DILM17-...(…) | ZB32-4       | 81.5            |
| –   | 1   | –   | –   | 4.2  | 100 | 50 | –  | 4 - 6     | 32 - 56     | NZMH2-S5-CNA    | DILM17-...(…) | ZB32-6       | 81.5            |
| 1   | 1½  | 3   | –   | 6    | 100 | 50 | –  | 4 - 6     | 48 - 84     | NZMH2-S8-CNA    | DILM17-...(…) | ZB32-6       | 81.5            |
| 1½  | 2   | –   | 5   | 6.9  | 100 | 50 | –  | 6 - 10    | 48 - 84     | NZMH2-S8-CNA    | DILM17-...(…) | ZB32-10      | 81.5            |
| 2   | 3   | 5   | 7½  | 9.6  | 100 | 50 | –  | 6 - 10    | 80 - 140    | NZMH2-S12-CNA   | DILM17-...(…) | ZB32-10      | 81.5            |
| 3   | 5   | 10  | 10  | 15.2 | 100 | 50 | –  | 10 - 16   | 128 - 224   | NZMH2-S18-CNA   | DILM17-...(…) | ZB32-16      | 81.5            |
| 5   | –   | –   | 15  | 17.5 | 100 | 50 | –  | 16 - 24   | 200 - 350   | NZMH2-S26-CNA   | DILM17-...(…) | ZB32-24      | 81.5            |
| –   | 7½  | 15  | 20  | 22   | 100 | 50 | –  | 16 - 24   | 200 - 350   | NZMH2-S26-CNA   | DILM25-...(…) | ZB32-24      | 81.5            |
| 7½  | –   | –   | –   | 25.3 | 100 | 50 | –  | 24 - 32   | 256 - 448   | NZMH2-S33-CNA   | DILM25-...(…) | ZB32-32      | 81.5            |
| –   | 10  | 20  | 25  | 28   | 100 | 50 | –  | 24 - 32   | 256 - 448   | NZMH2-S33-CNA   | DILM32-...(…) | ZB32-32      | 81.5            |
| 10  | –   | –   | –   | 32.2 | 100 | 50 | –  | 24 - 32   | 320 - 560   | NZMH2-S40-CNA   | DILM32-...(…) | ZB32-32      | 81.5            |
| –   | –   | 25  | 30  | 34   | 100 | 50 | –  | 32 - 40   | 320 - 560   | NZMH2-S40-CNA   | DILM40(…)     | ZB65-40      | 81.5            |
| –   | –   | 30  | –   | 40   | 100 | 50 | –  | 32 - 40   | 400 - 700   | NZMH2-S50-CNA   | DILM40(…)     | ZB65-40      | 81.5            |
| –   | 15  | –   | 40  | 42   | 100 | 50 | –  | 40 - 57   | 400 - 700   | NZMH2-S50-CNA   | DILM40(…)     | ZB65-57      | 81.5            |
| 15  | 20  | 40  | 50  | 54   | 100 | 50 | –  | 40 - 57   | 504 - 882   | NZMH2-S63-CNA   | DILM50(…)     | ZB65-57      | 81.5            |
| 20  | –   | 50  | 60  | 65   | 100 | 50 | –  | 57 - 65   | 640 - 1120  | NZMH2-S80-CNA   | DILM65(…)     | ZB65-65      | 81.5            |
| –   | 25  | –   | –   | 68   | 100 | 50 | –  | 50 - 70   | 640 - 1120  | NZMH2-S80-CNA   | DILM80(…)     | ZB150-70     | 163             |
| 25  | 30  | 60  | 75  | 80   | 100 | 50 | –  | 70 - 100  | 800 - 1400  | NZMH2-S100-CNA  | DILM80(…)     | ZB150-100    | 163             |
| –   | 40  | 75  | 100 | 104  | 100 | 50 | –  | 70 - 100  | 1000 - 1750 | NZMH2-S125-CNA  | DILM95(…)     | ZB150-100    | 163             |
| 30  | –   | –   | –   | 92   | 100 | 50 | –  | 70 - 100  | 1000 - 1750 | NZMH2-S125-CNA  | DILM115(…)    | ZB150-100    | 163             |
| 40  | –   | 100 | 125 | 125  | 100 | 50 | –  | 100 - 125 | 1280 - 2240 | NZMH2-S160-CNA  | DILM115(…)    | ZB150-125    | 163             |
| –   | 50  | –   | –   | 130  | 100 | 50 | –  | 125 - 150 | 1280 - 2240 | NZMH2-S160-CNA  | DILM115(…)    | ZB150-150    | 163             |
| –   | –   | 125 | –   | 156  | 100 | 50 | –  | 125 - 150 | 1600 - 2500 | NZMH2-S200-CNA  | DILM150(…)    | ZB150-150    | 265             |
| 50  | 60  | –   | 150 | 154  | 100 | 50 | –  | 120 - 160 | 1600 - 2500 | NZMH2-S200-CNA  | DILM185/22(…) | Z5-160/FF250 | 265             |
| 60  | 75  | 150 | 200 | 192  | 100 | 50 | –  | 160 - 220 | 220 - 3080  | NZMH2-SE220-CNA | DILM225/22(…) | Z5-220/FF250 | 265             |
| 75  | 100 | 200 | 250 | 248  | 100 | 50 | 50 | 160 - 220 | 350 - 4900  | NZMH3-SE350-CNA | DILM250/22(…) | Z5-220/FF250 | 306             |
| 100 | –   | –   | 300 | 289  | 100 | 50 | 50 | 190 - 290 | 350 - 4900  | NZMH3-SE350-CNA | DILM300/22(…) | ZW7-290      | 306             |
| –   | 125 | 250 | –   | 302  | 100 | 50 | 50 | 270 - 400 | 450 - 6300  | NZMH3-SE450-CNA | DILM300/22(…) | ZW7-400      | 306             |
| 125 | 150 | 300 | 400 | 382  | 100 | 50 | 50 | 270 - 400 | 450 - 6300  | NZMH3-SE450-CNA | DILM400/22(…) | ZW7-400      | 306             |

Notes <sup>1)</sup> Suitable for networks with grounded star-point

## Description

### SWIRE...

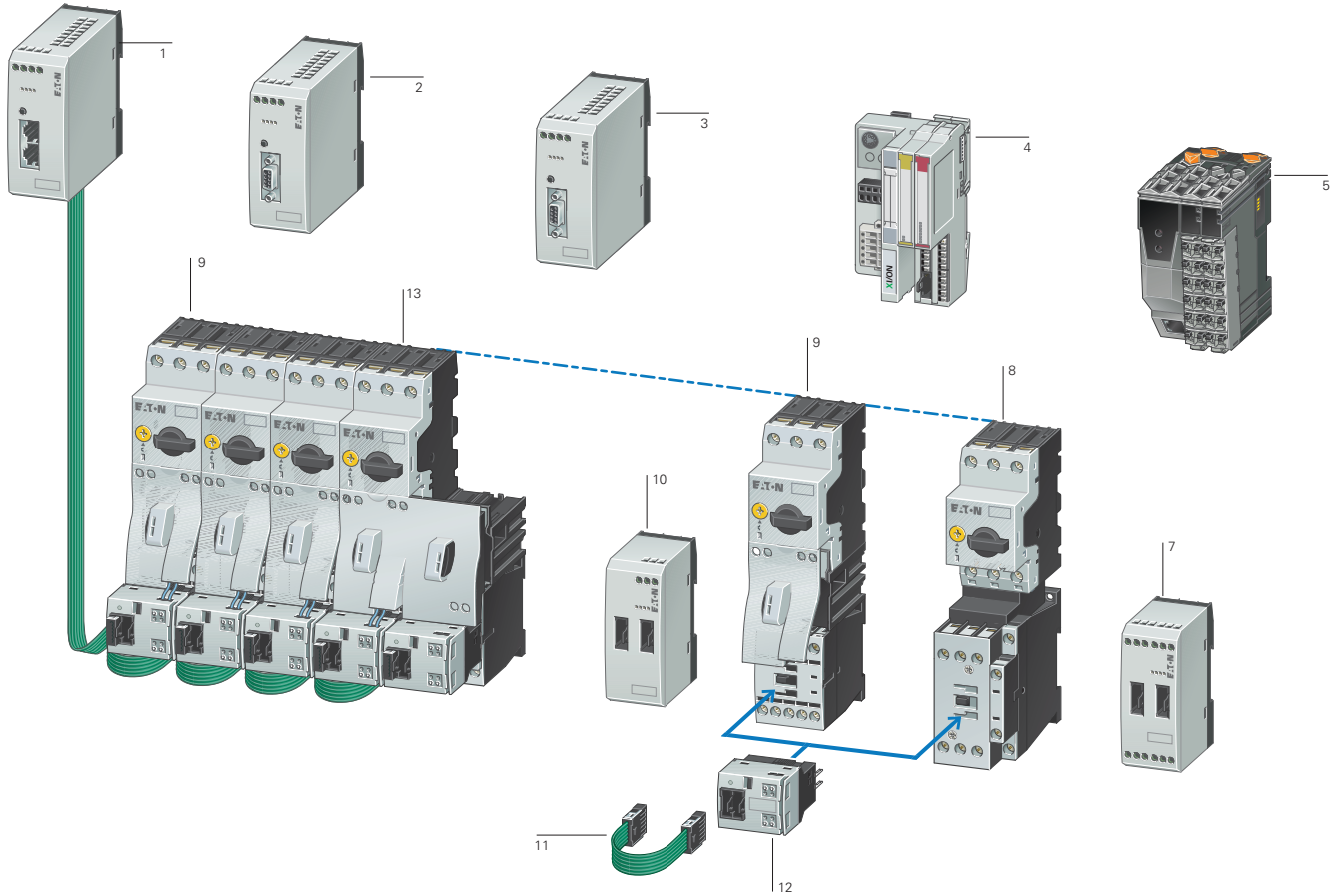

- 1 Gateway easy NET/CAN open
- 2 Gateway PROFIBUS-DP
- 3 Gateway MODBUS
- 4 Coupling unit XI/ON with SmartWire-DT® Interface card MicroInnovation AG, [www.microinnovation.com](http://www.microinnovation.com)
- 5 Interface module B & R CS1011 for X20 system, [www.br-automation.com](http://www.br-automation.com)
- 6 SmartWire-DT® I/O module
- 7 DOL starter MSC-D up to 32 A
- 8 DOL starter MSC-D up to 15.5 A
- 9 SmartWire-DT® power module
- 10 Connection cable
- 11 SmartWire-DT® module for DILM
- 12 Reversing starter MSC-R up to 12 A

### System description

With the SmartWire-DT® connection system, switchgear can be connected to a programmable logic controller without the need for complex control wiring. Plug-in SmartWire-DT® cards for DILM and a preassembled connection cable replace the control wiring, dramatically reducing wiring complexity and completely eliminating wiring errors. SmartWire-DT® also cuts the time needed for installation, commissioning and troubleshooting. The PLC's inputs and outputs are replaced by the SmartWire-DT® module for DILM, and no control wiring terminals are required. Connection to the various fieldbus systems is through third-party gateways or interface modules.

### Features

- Gateway
  - Connects the SmartWire-DT® cards with the fieldbus
  - Supports the fieldbus standards PROFIBUS-DP, MODBUS, CANopen and easy-NET
  - Supplies the control voltage for the motor starter or contactor
  - Supplies the supply voltage for the SmartWire-DT® connection system
  - Configuration button for automatic addressing of the SmartWire-DT® modules for DILM
  - Supports max. 16 SmartWire-DT® modules for DILM
- Interface of third-party manufacturers, e.g. for the XI/ON I/O system, X20 system CS1011 interface module
  - Connection to the field buses PROFIBUS-DP, MODBUS, CANopen and DeviceNET
- SmartWire-DT® module for DILM
  - Pluggable on contactors
  - Suitable for contactors DILM7 to DILM32 (24 V DC), DILMC7 to DILMC32 (24 V DC), DILMP20 (24 V DC) or motor starter MSC... (24 V DC)
  - Use the standard switchgear of the xStart range
  - Suitable for DOL and reversing starters
  - The accessories of the contactor series can be used
- Suitable for contactor combinations with PKZ or with Z relays
- Integrated switch position monitoring of the contactors
- Integrated mechanical switch position display
- Actuation of the contactors
- Scanning of a potential-free contact, e.g. NHI-E-10-PKZO
- Electrical interlocking, e.g. possible with reversing starters
- LED for status and diagnostic display
- Connection to gateway or interface from third party devices
- SmartWire-DT® I/O module
  - 4 digital inputs for connection of potential-free contacts
  - Power supply for the digital inputs comes from the device
  - 2 relay outputs 250 V AC
- SmartWire-DT® power module
  - Supply of the 24 V DC control voltage for actuation of contactors DILM
  - Assembly of Emergency Off groups
  - Increases the control voltage power in the SmartWire-DT® line
- Safety engineering
  - Emergency switching off disconnection as per IEC/EN 954-1, Switching Category 3
  - Central switch off of control voltage at the gateway or SmartWire-DT® power module
  - Combination with safety-relevant switchgear possible

# 1.4

## Connection system SmartWire-DT®

### 1 Ordering

#### SWIRE-...

| Description | Part no.<br>Article no. | Price<br>See price list | Std. pack | Notes |
|-------------|-------------------------|-------------------------|-----------|-------|
|-------------|-------------------------|-------------------------|-----------|-------|

#### Gateway

##### PROFIBUS-DP



Gateway with integrated supply for the SmartWire-DT® module and control voltage for the switchgear.

- Connection to PROFIBUS-DP as slave.
- Transmission rate: 9.6 Kbits/s to 12 MBit/s.
- 9 pole SUB-D socket.
- Address range 1...126.
- Connection to SmartWire-DT® module as master.
- Supports 16 SmartWire-DT® modules.

**SWIRE-GW-DP**  
107027

1 off

##### MODBUS



Gateway with integrated supply for the SmartWire-DT® module and control voltage for the switchgear.

- Connection to MODBUS-RTU as slave.
- Transmission rate: 9.6 to 57.6 Kbits/s.
- 9 pole SUB-D socket RS232/RS485.
- Address range 1...31.
- Connection to SmartWire-DT® module as master.
- Supports 16 SmartWire-DT® modules.

**SWIRE-GW-MB**  
118562

1 off

#### Modules

##### SmartWire-DT® module for DILM

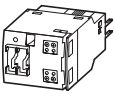

SmartWire-DT® module to assemble on the contactors DILM(C)7...DILM(C)38, DILA..., DILMP20

- One module is necessary per contactor.
- Connection to SmartWire-DT® gateway as slave.
- Max. 16 SmartWire-DT® modules per line.
- 1 digital input for floating contact.
- Signaling contactor switch position.

**SWIRE-DIL**  
107028

5 off

- Take account of the max. current consumption of the contactor coils per SmartWire-DT® line.
- Length of connection cable at the input and the electrical interlock < 2.8 m.
- The A2 connection of the contactors must not be linked.
- Electrical interlocking only possible via the terminals on the module for DILM.
- Wiring sets DILM 12-XRL and PKZM0-XRM12 cannot be used.
- Connection terminals for electrical interlocking are not suitable for safety technology.

##### SmartWire-DT® power module



Power module for supplying the control voltage.

- Connection on SmartWire-DT® gateway as interactive station (no address).

**SWIRE-PF**  
107029

1 off

Max. 4 power modules per SmartWire-DT® line.

##### SmartWire-DT® I/O mod-ule



4 digital inputs  
2 digital relay outputs

**SWIRE-4DI-2DO-R**  
107030

1 off

Max. 4 SmartWire-DT® I/O modules per line.























#### Information relevant for export to North America



|                   |   |
|-------------------|---|
| Product Standards | IEC/EN 60947-4-1; UL 508; CSA-C22.2 No.14-05; |
|                   | CE marking                                    |
| UL File No.       | E29184  |
| UL CCN            | NKCR  |
| CSA File No.      | 012528  |
| CSA Class No.     | 2252-01                                       |
| NA Certification  | UL Listed, CSA certified                      |



SWIRE-...

| Description  | Part no.<br>Article no.         | Price<br>See price list | Std. pack   | Notes   |
|--|---------------------------------|-------------------------|---|---|
| <b>Accessory</b>   |                                 |                         |   |   |
| SmartWire-DT® connection cable <sup>1)</sup>   |                                 |                         |   |   |
| Length: 85 mm  | <b>SWIRE-CAB-008</b><br>107032  |                         | 25 off<br>      | Cable lengths: Engineering → 34                       |
| Length: 110 mm   | <b>SWIRE-CAB-011</b><br>107033  |                         | 25 off<br>      |   |
| Length: 150 mm   | <b>SWIRE-CAB-015</b><br>107034  |                         | 5 off<br>       |   |
| Length: 250 mm   | <b>SWIRE-CAB-025</b><br>107035  |                         | 5 off<br>       |   |
| Length: 500 mm   | <b>SWIRE-CAB-050</b><br>112027  |                         | 1 off<br>       |   |
| Length: 1000 mm  | <b>SWIRE-CAB-100</b><br>107036  |                         | 1 off<br>       |   |
| Length: 2000 mm  | <b>SWIRE-CAB-200</b><br>107037  |                         | 1 off<br>       |   |
| Termination connector <sup>1)</sup>  |                                 |                         |   |   |
| – Termination plug for last SmartWire-DT® card, 6 pole, no electrical function.                    | <b>SWIRE-CAB-000</b><br>107031  |                         | 25 off<br>      | –   |
| Data cable <sup>1)</sup>   |                                 |                         |   |   |
| – 6-core, ribbon cable, length: 100 m.   | <b>SWIRE-CAB-100M</b><br>107038 |                         | 1 off<br>   | Preassembly of cable only possible with special tool. |
| Plug <sup>1)</sup>   |                                 |                         |   |   |
| – 6-pin plug for ribbon cable.   | <b>SWIRE-CAB-CON</b><br>107039  |                         | 50 off<br>  | For use with SWIRE-CAB-100M.                          |
| NHI-E with cable <sup>1)</sup>   |                                 |                         |   |   |
| – NHI-E-10-PKZO with connection cable AWG18 blue, for connection to SmartWire-DT® module for DILM. | <b>NHI-E-10L-PKZO</b><br>107040 |                         | 5 off   | –   |
| Plug-in reversing bridge <sup>2)</sup>   |                                 |                         |   |   |
| – For assembling reversing starters with tool-less plug connection                                 | <b>DILM12-XR</b><br>110099      |                         | 20 off<br>  | For use with DILM7...DILM15, without A2 link.         |

Information relevant for export to North America



1)  
 Product Standards IEC/EN 60947-4-1; UL 508; CSA-C22.2 No.14-05; CE marking  
 UL File No. E29184  
 UL CCN NKCR  
 CSA File No. 012528  
 CSA Class No. 2252-01  
 NA Certification UL Listed, CSA certified

2)  
 Product Standards IEC/EN 60947-4-1; UL 508; CSA-C22.2 No.14-05; CE marking  
 UL File No. E36332  
 UL CCN NLRV  
 CSA File No. 012528  
 CSA Class No. 3211-05  
 NA Certification UL Listed, CSA certified

# 1.4 Connection system SmartWire-DT®

## 1 Engineering

### SWIRE-... Cable lengths

For connection between motor starters and contactors DILM, the cable lengths depend on the combination and assembly of the devices.

| Applications              | PKZ accessories                  | from         | to           | Cable length |
|---------------------------|----------------------------------|--------------|--------------|--------------|
| <b>Contactors DILM</b>    | None<br>(45 grid)                | DILM7-...15  | DILM7-...15  | 85 mm        |
|                           |                                  | DILM17-...38 | DILM17-...38 | 85 mm        |
|                           |                                  | DILM7-...38  | DILM17-...38 | 110 mm       |
|                           |                                  | DILM17-...38 | DILM7-...15  | 110 mm       |
|                           | PKZM0 with U-/A.../NHI.../AGM... | DILM7-...15  | DILM7-...15  | 110 mm       |
|                           |                                  | DILM17-...32 | DILM17-...32 | 110 mm       |
|                           |                                  | DILM7-...15  | DILM17-...32 | 110 mm       |
|                           |                                  | DILM17-...32 | DILM7-...15  | 110 mm       |
| <b>Motor starters MSC</b> | None<br>(45 grid)                | DILM7-...15  | DILM7-...15  | 85 mm        |
|                           |                                  | DILM17-...32 | DILM17-...32 | 85 mm        |
|                           |                                  | DILM7-...15  | DILM17-...32 | 110 mm       |
|                           |                                  | DILM17-...32 | DILM7-...15  | 110 mm       |
|                           | PKZM0 with U-/A.../NHI.../AGM... | DILM7-...15  | DILM7-...15  | 110 mm       |
|                           |                                  | DILM17-...32 | DILM17-...32 | 110 mm       |
|                           |                                  | DILM7-...15  | DILM17-...32 | 150 mm       |
|                           |                                  | DILM17-...32 | DILM7-...15  | 150 mm       |

### SWIRE-... Cable lengths

The cable lengths for connecting SmartWire-DT® devices depend on the combination and assembly of the devices.

| Applications   | Cable length |
|--|--------------|
| Connection from power module to SWIRE-DIL with mounting beside PKZ   | 250 mm       |
| Connection from power module to SWIRE-DIL with mounting beside DILM  | 150 mm       |
| Connection from gateway to SWIRE-DIL with mounting beside PKZ        | 250 mm       |
| Connection from coupling unit to SWIRE-DIL with mounting beside DILM | 250 mm       |

### SWIRE-... Magnet systems

The number of motor starters or contactors DILM that can be connected is dependant on the power consumption of the magnet systems per SmartWire-DT® line. To increase the number of SmartWire-DT® modules that can be connected, power modules can be used.

| 24 V DC       |   | DILM7 | DILM9 | DILM12 | DILM15      | DILM17      | DILM25      | DILM32/38   |
|---------------|---|-------|-------|--------|-------------|-------------|-------------|-------------|
| Pick-up power | W | 3     | 3     | 4.5    | 12 at 24 V  | 12 at 24 V  | 12 at 24 V  | 12 at 24 V  |
| Holding power | W | 3     | 3     | 4.5    | 0.5 at 24 V | 0.5 at 24 V | 0.5 at 24 V | 0.5 at 24 V |

**Technical data**

**SWIRE-...**

|  |                 | SWIRE-GW-DP   | SWIRE-PF     | SWIRE-DIL                           |
|--|-----------------|---|--------------|-------------------------------------|
| <b>General</b>   |                 |   |              |                                     |
| Standards  |                 |   |              |                                     |
| General  |                 | IEC/EN 60947<br>EN 55011<br>EN 55022<br>IEC/EN 61000-4<br>IEC/EN 60068-2-27                     |              |                                     |
| Profibus-DP  |                 | IEC 61158   | –            | –                                   |
| Mounting   |                 | Top-hat rail IEC/EN 60715 (35mm) or screw fixing with fixing brackets ZB4-101-GF1 (accessories) |              | on DILM7...DILM38                   |
| Dimensions (w x d x h)   | mm              | 35 x 90 x 109   | 35 x 90 x 74 | 45 x 44 x 81                        |
| Weight   | kg              | 0.15  | 0.1          | 0.04                                |
| <b>Terminal capacity</b>   |                 |   |              |                                     |
| Solid  | mm <sup>2</sup> | 0.34...1.5  | 0.34...1.5   | 0.34...1.5                          |
| Flexible with ferrule  | mm <sup>2</sup> | 0.34...1.5  | 0.34...1.5   | 0.34...1.5                          |
| Solid or stranded  | AWG             | 22...16   | 22...16      | 22...16                             |
| Flat-blade screwdriver   | mm              | 3.5 x 0.8   | 3.5 x 0.8    | 3.5 x 0.8                           |
| Max. tightening torque   | Nm              | 0.6   | 0.6          | 0.5                                 |
| <b>Ambient climatic conditions</b>   |                 |   |              |                                     |
| Ambient temperature  | Operation       | °C  | -25 - +55    | -25 - +55                           |
|  | Storage         | °C  | -25 - +70    | -25 - +70                           |
| Condensation   |                 | Prevent condensation by means of suitable measures  |              |                                     |
| Relative humidity, non-condensing (IEC/EN 60068-2-30)                            | %               | 5 - 95  | 5 - 95       | 5 - 95                              |
| Air pressure (in operation)  | hPa             | 795 - 1080  | 795 - 1080   | 795 - 1080                          |
| <b>Ambient mechanical conditions</b>   |                 |   |              |                                     |
| Protection type (IEC/EN 60529)   |                 | IP20  | IP20         | IP20                                |
| Pollution degree   |                 | 2   | 2            | 2                                   |
| Mounting position  |                 | Vertical  | Vertical     | As per DILM7 to DILM38              |
| <b>Electromagnetic compatibility (EMC)</b>                                       |                 |   |              |                                     |
| Electrostatic discharge (IEC EN 61000-4-2, Level 3, ESD)                         |                 |   |              |                                     |
| Air discharge  | kV              | 8   | 8            | 8                                   |
| Contact discharge  | kV              | –   | –            | –                                   |
| Electromagnetic fields (IEC/EN 61000-4-3, RFI)                                   | V/m             | 10  | 10           | 10                                  |
| Radio interference suppression (EN 55011, EN 55022)                              |                 | Class A   | Class A      | Class A                             |
| Burst pulses(IEC/EN 61000-4-4, level 3)  |                 |   |              |                                     |
| Supply cables  | kV              | 2   | 2            | 2                                   |
| Signal cables  | kV              | 2   | 2            | 2                                   |
| High-energy pulses (surge) (IEC/EN 61000-4-5, level 2)                           | kV              | 0.5 (supply cables, symmetrical)  |              |                                     |
| Emitted RFI (IEC/EN 61000-4-6)   | V               | 10  | 10           | 10                                  |
| <b>Insulation resistance</b>   |                 |   |              |                                     |
| Clearances and creepage distances  |                 | EN 50178, EN 60947-1, UL 508, CSA C22.2 No 142  |              |                                     |
| Insulation resistance  |                 | EN 50178, EN 60947-1  |              |                                     |
| <b>Supply voltage, gateway electronics and SmartWire-DT® station electronics</b> |                 |   |              |                                     |
| <b>U<sub>gateway</sub></b>   |                 |   |              |                                     |
| Rated operational voltage U <sub>gateway</sub>                                   | V DC            | 24, -15 %, +20 %  | –            | –                                   |
| Permissible range  |                 | 20.4...28.8   | 20.4...28.8  | Supply from gateway or power module |
| Ripple   | %               | ≅ 5   | –            | –                                   |
| Maximum coupling unit power consumption at 24 V DC                               | mA              | 500<br>(typically 100 for gateway + typically 25 per SmartWire-DT® module)                      | –            | –                                   |
| Voltage dips (IEC/EN 61131-2)  | ms              | 10  | –            | –                                   |
| Heat dissipation at 24 V DC  | W               | Normally 6  | Normally 1   | Normally 0.6                        |
| Protection against polarity reversal   |                 | Yes   | –            | –                                   |
| Short-circuit protection, SmartWire-DT® side                                     |                 | Yes   | –            | –                                   |

# 1.4 Connection system SmartWire-DT®

## SWIRE-...

1

|  |       | SWIRE-GW-DP   | SWIRE-PF  | SWIRE-DIL                               |
|--|-------|---|---|---|
| <b>General</b>   |       |   |   |   |
| <b>Supply voltage <math>U_{AUX}</math> (supply voltage for switching SmartWire-DT® elements, e.g. contactor coils)</b> |       |   |   |   |
| Rated operational voltage $U_{AUX}$  | V DC  | 24, -15 %, +20 %<br>(Derating from > 40 °C)   | 24, -15 %, +20 %<br>(Derating from > 40 °C)   | Supply from gateway or power module     |
| Permissible range  | V DC  | 20.4...28.8,<br>at 45 °C: 21...28.8,<br>at 50 °C: 21.6...28.8,<br>at 55 °C: 22.2...27.6 | 20.4...28.8,<br>at 45 °C: 21...28.8,<br>at 50 °C: 21.6...28.8,<br>at 55 °C: 22.2...27.6 | Supply from gateway or power module     |
| Input current $U_{AUX}$ at 24 V DC   | A     | Normally 3  | Normally 3  | –                                       |
| Ripple   | %     | ≅ 5   | ≅ 5   | –                                       |
| Voltage dips (IEC/EN 61131-2)  | ms    | 10  | 10  | –                                       |
| Protection against polarity reversal   |       |   |   |   |
| Short-circuit protection, SmartWire-DT® side   |       | No, external fuse<br>3 A or FAZ-Z3  | No, external fuse<br>3 A or FAZ-Z3  | –                                       |
| <b>LED indicators</b>  |       |   |   |   |
| Operational  |       | Ready: green  | –   | Ready: green                            |
| Power supply, SmartWire-DT® contactors   |       | $U_{AUX}$ : green   | $U_{AUX}$ : green   | –                                       |
| PROFIBUS-DP status   |       | PROFIBUS-DP: green  | –   | –                                       |
| SmartWire-DT® status   |       | SmartWire-DT®: green  | –   | above Ready                             |
| Output status  |       | –   | –   | –                                       |
| <b>Connection floating contacts</b>  |       |   |   |   |
| Number   |       | –   | –   | 1                                       |
| Rated voltage (internal supply)  | $U_e$ | V DC  | –   | 17                                      |
| Input current at "1" signal, typically   |       | mA  | –   | 5                                       |
| Potential isolation  |       | –   | –   | No                                      |
| Max. cable length  |       | m   | –   | < 2.8                                   |
| <b>PROFIBUS-DP</b>   |       |   |   |   |
| Terminal type  |       | SUB-D 9-pole, socket  | –   | –                                       |
| Station address  |       | 1 ... 125   | –   | –                                       |
| Address setting  |       | DIP switches  | –   | –                                       |
| Potential isolation  |       |   |   |   |
| From $U_{AUX}$ power supply  |       | Yes   | –   | –                                       |
| From $U_{Gateway}$ power supply  |       | Yes   | –   | –                                       |
| To SmartWire-DT®   |       | Yes   | –   | –                                       |
| Function   |       | PROFIBUS-DP<br>slave  | –   | –                                       |
| Bus protocol   |       | PROFIBUS-DP   | –   | –                                       |
| Bus Terminating Resistors  |       | can be connected via plug   | –   | –                                       |
| Baud rate  |       | Automatic, up to 12 Mbits/s   | –   | –                                       |
| <b>SmartWire-DT®</b>   |       |   |   |   |
| Terminal type  |       | Plug, 6-pole  | Plug, 6-pole  | Plug, 6-pole                            |
| Data/power cable   |       | 6-core ribbon cable   | 6-core ribbon cable   | 6-core ribbon cable                     |
| Maximum cable length, SmartWire-DT® system   | m     | Max. 4  | Max. 4  | Max. 4                                  |
| Bus termination  |       | No  | Plug connectors   | Plug connectors                         |
| Station address  |       | Automatic assignment  | None  | 1...16                                  |
| Station  |       | max. 126 PROFIBUS<br>stations   | Max. 4 SmartWire-DT® cards<br>per line  | Max. 16 SmartWire-DT® cards<br>per line |
| Address setting  |       | None  | None  | automatically via SmartWire-DT®         |
| Potential isolation  |       |   |   |   |
| From $U_{AUX}$ power supply  |       | No  | No  | No                                      |
| From $U_{Gateway}$ power supply  |       | No  | No  | No                                      |
| Function   |       | SmartWire-DT® master  | no SmartWire-DT® station  | SmartWire-DT® slave                     |
| Data transfer time, SmartWire-DT® system   |       |   |   |   |
| Write switch   |       | –   | –   | Normally 20 ms for all stations         |
| Read status information  |       | –   | –   | Normally 10 ms per station              |

SWIRE-...

1

|   |                 | SWIRE-4DI-2DO-R   | SWIRE-GW-MB  |
|---|-----------------|---|--|
| <b>General</b>  |                 |   |  |
| Standards   |                 |   |  |
| General   |                 | IEC/EN 60947, EN 55011, EN 55022, IEC/EN 61000-4, IEC/EN 60068-2-27                             |  |
| Mounting  |                 | Tophat rail IEC/EN 60715 (35 mm) or screw fixing with fixing brackets ZB4-101-GF1 (accessories) |  |
| Dimensions (w x d x h)  | mm              | 35 x 90 x 74  | 35 x 90 x 109  |
| Weight  | kg              | 0.12  | 0.15   |
| <b>Terminal capacity</b>  |                 |   |  |
| Solid   | mm <sup>2</sup> | 0.5...1.5   | 0.5...1.5  |
| Flexible with ferrule   | mm <sup>2</sup> | 0.5...1.5   | 0.5...1.5  |
| Solid or stranded   | AWG             | 22...16   | 22...16  |
| Flat-blade screwdriver  | mm              | 3.5 x 0.8   | 3.5 x 0.8  |
| Max. tightening torque  | Nm              | 0.6   | 0.6  |
| <b>Ambient climatic conditions</b>  |                 |   |  |
| Ambient temperature   | Operation       | °C  | -25 - +55  |
|   | Storage         | °C  | -25 - +70  |
| Condensation  |                 | Prevent condensation by means of suitable measures  |  |
| Relative humidity, non-condensing (IEC/EN 60068-2-30)   | %               | 5 - 95  | 5 - 95   |
| Air pressure (in operation)   | hPa             | 795 - 1080  | 795 - 1080   |
| <b>Ambient mechanical conditions</b>  |                 |   |  |
| Protection type (IEC/EN 60529, EN50178, VBG 4)  |                 | IP20  | IP20   |
| Pollution degree  |                 | 2   | 2  |
| Mounting position   |                 | Vertical  | Vertical   |
| <b>Electromagnetic compatibility (EMC)</b>  |                 |   |  |
| Electrostatic discharge (IEC/EN 61000-4-2, Level 3, ESD)  |                 |   |  |
| Air discharge   | kV              | 8   | 8  |
| Contact discharge   | kV              | –   | –  |
| Electromagnetic fields (IEC/EN 61000-4-3, RFI)  | V/m             | 10  | 10   |
| Radio interference suppression (EN 55011, EN 55022)   |                 | Class A   | Class A  |
| Burst pulses (IEC/EN 61000-4-4, level 3)  |                 |   |  |
| Supply cables   | kV              | 2   | 2  |
| Signal cables   | kV              | –   | 2  |
| power pulses (surge) (IEC/EN 61000-4-5, level 2)  | kV              | 0.5 (supply cables, symmetrical)  |  |
| Emitted RFI (IEC/EN 61000-4-6)  | V               | 10  | 10   |
| <b>Insulation resistance</b>  |                 |   |  |
| Clearances and creepage distances   |                 | EN 50178, EN 60947-1, UL 508, CSA C22.2 No 142  |  |
| Insulation resistance   |                 | EN 50178, EN 60947-1  |  |
| <b>Supply voltage, gateway electronics and SmartWire-DT® station electronics U<sub>gateway</sub></b>            |                 |   |  |
| Rated operational voltage U <sub>gateway</sub>  | V DC            | –   | 24, -15 %, +20 %   |
| Permissible range   |                 | Supply from gateway or power module 20.4...28.8   |  |
| Ripple  | %               | –   | ≅ 5  |
| Maximum gateway current consumption at 24 V DC  | mA              | –   | 500 (normally 100 coupling unit + normally 25 per SmartWire-DT® card)          |
| Voltage dips (IEC/EN 61131-2)   | ms              | –   | 10   |
| Heat dissipation at 24 V DC   | W               | –   | Normally 6   |
| Protection against polarity reversal  |                 |   | Yes  |
| Short-circuit protection, SmartWire-DT® side  |                 | –   | Yes  |
| <b>Power supply U<sub>AUX</sub> (power supply for switching the SmartWire-DT® slaves, e.g. contactor coils)</b> |                 |   |  |
| Rated operational voltage U <sub>AUX</sub>  | V DC            | –   | 24, -15 %, +20 % (Derating from > 40 °C)                                       |
| Permissible range   | V DC            | –   | 20.4...28.8, at 45 °C: 21...28.8, at 50 °C: 21.6...28.8, at 55 °C: 22.2...27.6 |
| Input current U <sub>AUX</sub> at 24 V DC   | A               | –   | Normally 3   |
| Ripple  | %               | –   | ≅ 5  |
| Voltage dips (IEC/EN 61131-2)   | ms              | –   | 10   |
| Protection against polarity reversal  |                 |   | Yes  |
| Voltage   | U <sub>s</sub>  | V   | –  |
| Short-circuit protection, SmartWire-DT® side  |                 | –   | No, external 3 A fuse or FAZ-Z3  |

# 1.4 Connection system SmartWire-DT®

## SWIRE-...

1

|  | SWIRE-4DI-2DO-R  |        |  | SWIRE-GW-MB                                     |
|--|------------------|--------|--|---|
| <b>LED indicators</b>                      |                  |        |  |   |
| Operational                                |                  |        |  | Ready: green                                    |
| Power supply, SmartWire-DT® contactors     |                  |        |  | U <sub>Aux</sub> : green                        |
| MODBUS status                              |                  |        |  | MODBUS: yellow                                  |
| SmartWire-DT® status                       |                  |        |  | SmartWire-DT®: green                            |
| Output status                              |                  |        |  | Q1, Q2: green                                   |
| <b>Connection floating contacts</b>        |                  |        |  |   |
| Number                                     |                  |        | 4                                      | –   |
| Rated voltage (internal supply)            | U <sub>e</sub>   | V DC   | 17                                     | –   |
| Input current at "1" signal, typically     |                  | mA     | 5                                      | –   |
| Potential isolation                        |                  |        | –                                      | Yes   |
| Max. cable length                          |                  | m      | < 2.8                                  | –   |
| <b>MODBUS</b>                              |                  |        |  |   |
| Terminal type                              |                  |        | –                                      | SUB-D, 9 pole, socket RS232/RS485               |
| Station address                            |                  |        | –                                      | 1 ... 31  |
| Address setting                            |                  |        | –                                      | DIP switches                                    |
| Potential isolation                        |                  |        |  |   |
| From U <sub>AUX</sub> power supply         |                  |        | –                                      | Yes   |
| From U <sub>Gateway</sub> power supply     |                  |        | –                                      | Yes   |
| To SmartWire-DT®                           |                  |        | –                                      | Yes   |
| Function                                   |                  |        | –                                      | MODBUS-RTU<br>Slave                             |
| Bus protocol                               |                  |        | –                                      | MODBUS-RTU                                      |
| Bus Terminating Resistors                  |                  |        | –                                      | can be connected via plug                       |
| Baud rate                                  |                  |        | –                                      | Adjustable up to 57.6 (9.6/19.2/38.4)<br>kbit/s |
| <b>SmartWire-DT®</b>                       |                  |        |  |   |
| Terminal type                              |                  |        | Plug, 6-pole                           | Plug, 6-pole                                    |
| Data/power cable                           |                  |        | 6-core ribbon cable                    | 6-core ribbon cable                             |
| Maximum cable length, SmartWire-DT® system |                  | m      | Max. 4                                 | Max. 4  |
| Bus termination                            |                  |        | Plug connectors                        | No  |
| Station address                            |                  |        | 1...16                                 | Automatic assignment                            |
| Station                                    |                  |        | Max. 4 SmartWire-DT® modules per line. | Max. 16   |
| Address setting                            |                  |        | automatically via SmartWire-DT®        | None  |
| Potential isolation                        |                  |        |  |   |
| From U <sub>AUX</sub> power supply         |                  |        | No                                     | No  |
| From U <sub>Gateway</sub> power supply     |                  |        | No                                     | No  |
| Function                                   |                  |        | SmartWire-DT® slave                    | SmartWire-DT® master                            |
| Data transfer time, SmartWire-DT® system   |                  |        |  |   |
| Write switch                               |                  |        | Normally 20 ms for all stations        | –   |
| Read status information                    |                  |        | Normally 10 ms per station             | –   |
| <b>Relay outputs</b>                       |                  |        |  |   |
| Rated impulse withstand voltage            | U <sub>imp</sub> | V AC   | 4000                                   | –   |
| Overvoltage category/pollution degree      |                  |        | III/3                                  | –   |
| Rated insulation voltage                   | U <sub>i</sub>   | V      | 250                                    | –   |
| Rated operating voltage                    | U <sub>e</sub>   | V      | 250                                    | –   |
| Making capacity                            |                  | A      | 30                                     | –   |
| Breaking capacity                          | 380/400 V        | A      | 10                                     | –   |
| Rated operational current                  |                  |        |  |   |
| AC-15, 250 V                               | I <sub>e</sub>   | A      | 3                                      | –   |
| DC-12, 30 V                                | I <sub>e</sub>   | A      | 3                                      | –   |
| Conventional thermal current               | I <sub>th</sub>  | A      | 6                                      | 6   |
| Short-circuit rating without welding       |                  |        |  |   |
| max.fuse                                   |                  | AgG/gL | 10                                     | –   |

## MSC-D, MSC-R, MSC-DE(A)

### MSC-D, MSC-R, MSC-DE(A)

1

|                               |   |   |      |           |
|-------------------------------|---|---|------|-----------|
| <b>General</b>                | <b>Standards</b>                        | IEC/EN 60947-4-1, VDE 0660<br>UL 508 (please enquire)<br>CSA C 22.2 No. 14 (please enquire) |      |           |
|                               | Mounting position                       |   |      |           |
| <b>Main contacts</b>          | <b>Rated impulse withstand voltage</b>  | $U_{imp}$   | V AC | 6000      |
|                               | Overvoltage category/pollution degree   |   |      | III/3     |
|                               | Rated operating voltage                 | $U_e$   | V    | 230 - 415 |
| <b>Further technical data</b> | <b>Motor protective circuit breaker</b> | PKZM0, PKE → Chapter 1.3  |      |           |
|                               | Contactors DILM                         | → Chapter 1.1   |      |           |

## Dimensions

### DOL starters

MSC-D-...-M7[...15]...

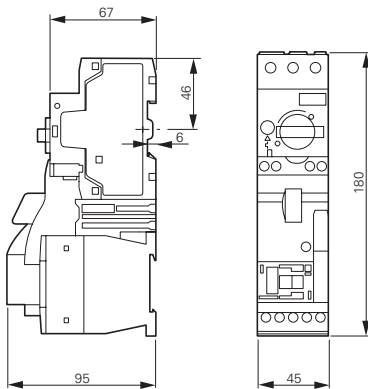

MSC-D-...-M17[...32]...

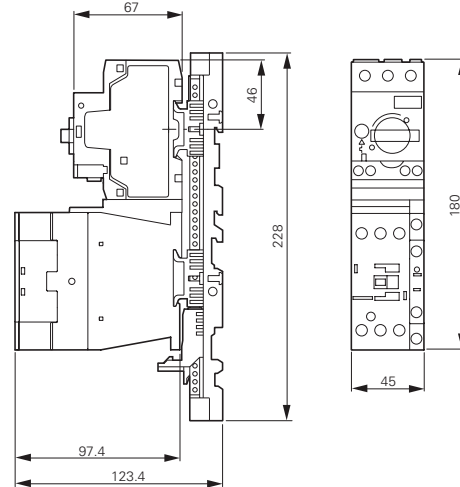

MSC-D-...-M7[...15]BBA...

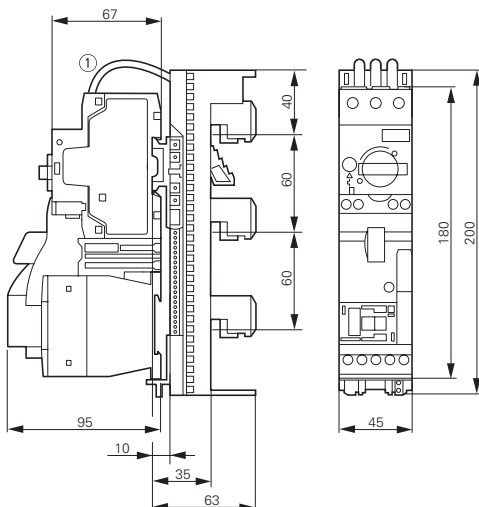

MSC-D-...-M17[...32]BBA...

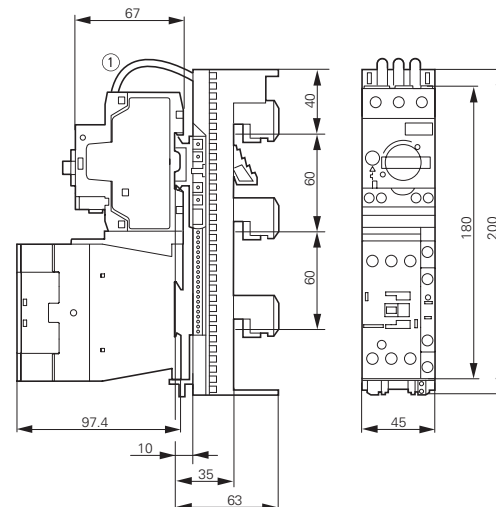

# 1.4 Motor-starter combinations

DOL starters, reversing starters

## Reversing starters

1

MSC-R-...-M7[...12]...

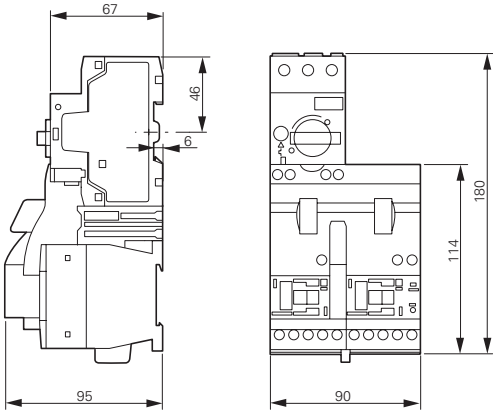

MSC-R-...-M17[...32]...

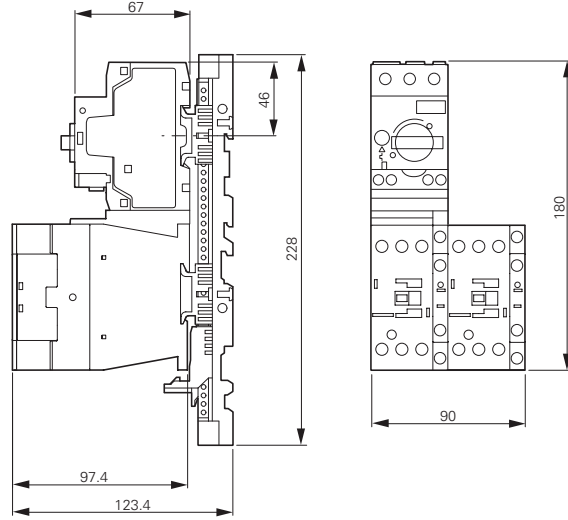

MSC-R-...-M7[...12]BBA...

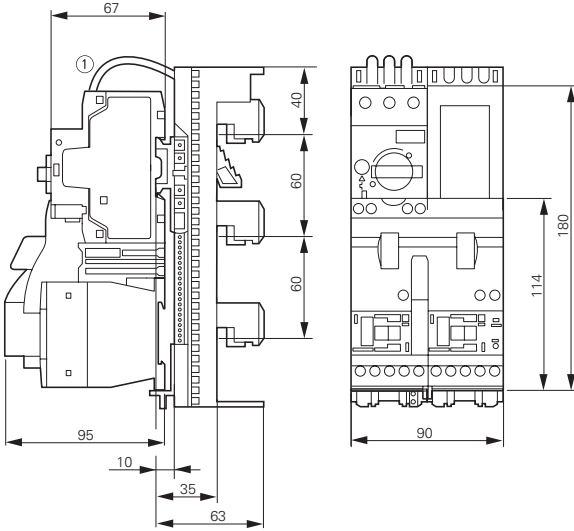

MSC-R-...-M17[...32]BBA...

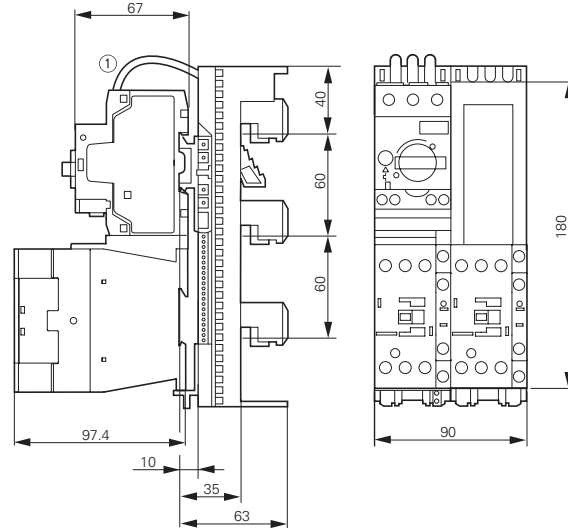

## DOL starters

MSC-DE(A)-...-M7[...12]...

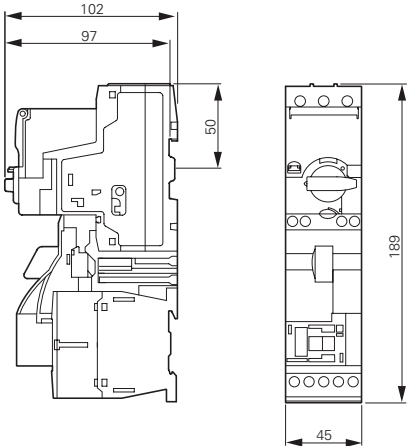

MSC-DE(A)-...-M7[...12]...

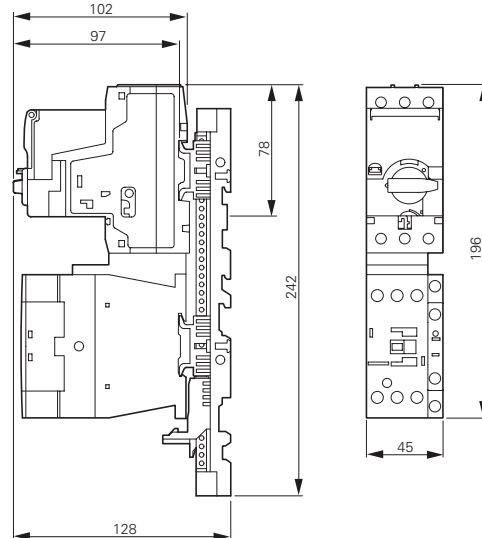



**Modules**

SWIRE-DIL

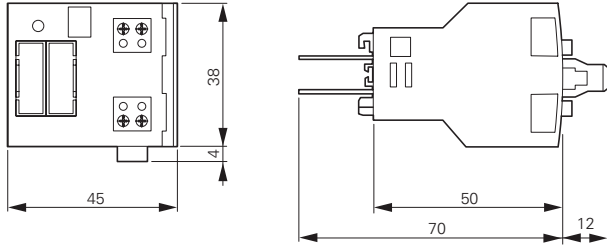

SWIRE-PF, SWIRE-4DI-2DO-R

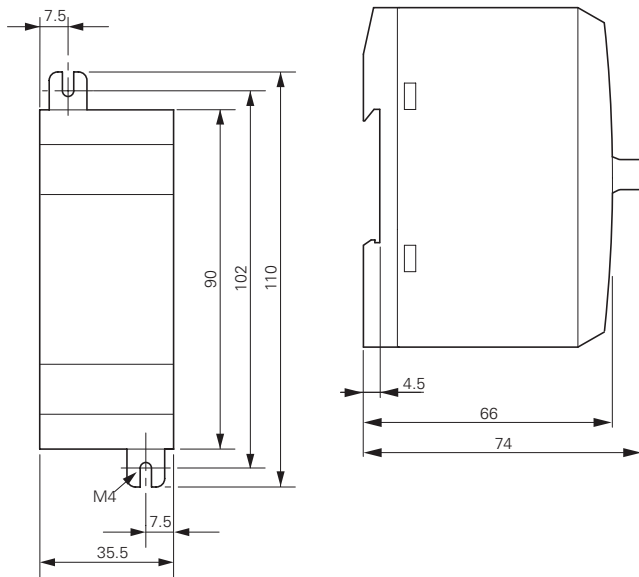

**Gateways**

SWIRE-GW-DP..., SWIRE-GW-MB

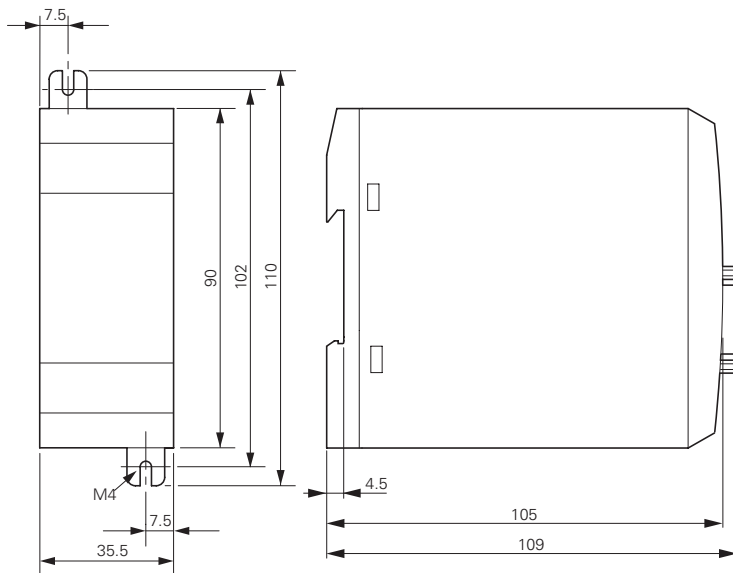

Control relays XTRG



System overview

Control relays XTRG ..... 1

Product selection

Basic devices XTRG ..... 2

Auxiliary contact modules, Actuating voltages / Accessories ..... 3

Technical data

Control relays XTRG ..... 4

Control relays XTRG

Product description

Part of the E Line family of controls, the XTRG control relay offers space savings, enhanced reliability and more efficient use of materials. Rated to operate thermal currents up to 10A, AC voltages up to 660V or DC voltages up to 250V, the XTRG contactor relay offers optimum performance in a compact package.

Features

- 10A Control relay
- 690V Insulation rating
- 660VAC or 250VDC Operational voltage
- Up to 5 sets of normally open or normally closed contacts with add-on blocks
- All common AC control voltages
- DIN rail or panel mount options
- Unique 27mm design

System overview

Control relays are used to remotely switch small loads or in complex control schemes. The XTRG relay can be integrated with contactors from the E Line family of motor controls to create compact, efficient control panels for a multitude of applications.

Standards and certifications

- GB 14048
- IEC/EN 60947
- CCC
- CE

Accessory overview

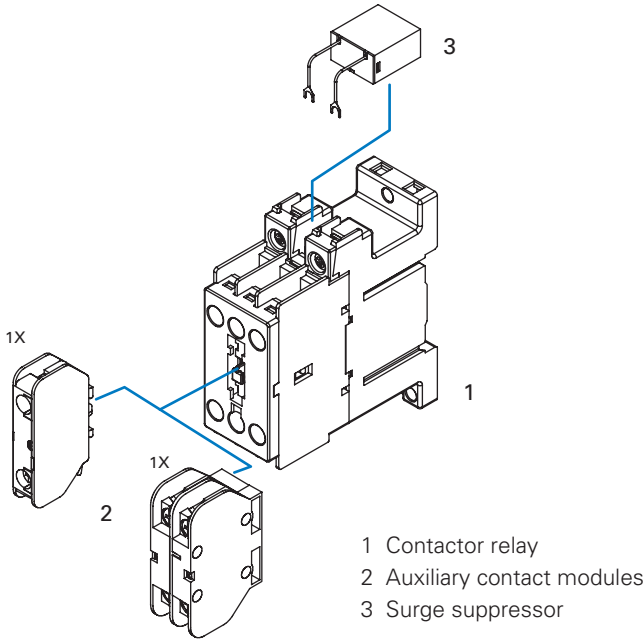

# 2.1

## Control relays XTRG

Product selection

XTRG

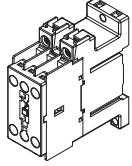

2

### Control relays

| Connection type | Contact           |                     | Rated operational current AC-15 I <sub>e</sub> (A) |       | Conventional thermal current, open, 40°C I <sub>th</sub> (A) | Circuit symbol | Can be combined with auxiliary contact module | AC operation                 | Standard package |
|-----------------|-------------------|---------------------|--|-------|--|----------------|---|------------------------------|------------------|
|                 | N/O=Normally open | N/C=Normally closed | 220V   | 380 V |  |                |   | Part no. Article no.         |                  |
| Screw terminals | 3 N/O             | -                   | 4  | 1.9   | 10   |                | XTCGXFAC10<br>XTCGXFAC..                      | <b>XTRG10B30DT</b><br>168044 | 1 piece          |
| Screw terminals | 2 N/O             | 1 N/C               | 4  | 1.9   | 10   |                | XTCGXFAC10<br>XTCGXFAC..                      | <b>XTRG10B21DT</b><br>167927 | 1 piece          |
| Screw terminals | 1 N/O             | 2 N/C               | 4  | 1.9   | 10   |                | XTCGXFAC10<br>XTCGXFAC..                      | <b>XTRG10B12DT</b><br>167968 | 1 piece          |
| Screw terminals | -                 | 3 N/C               | 4  | 1.9   | 10   |                | XTCGXFAC10<br>XTCGXFAC..                      | <b>XTRG10B03DT</b><br>167978 | 1 piece          |

### Actuating voltages

| Coil Voltage | 3NO                          | 2NO/1NC                      | 1NO/2NC                      | 3NC                          |
|--------------|------------------------------|------------------------------|------------------------------|------------------------------|
| 24VAC 50Hz   | <b>XTRG10B30B5</b><br>168040 | <b>XTRG10B21B5</b><br>167923 | <b>XTRG10B12B5</b><br>167933 | <b>XTRG10B03B5</b><br>167974 |
| 36VAC 50Hz   | <b>XTRG10B30DS</b><br>168041 | <b>XTRG10B21DS</b><br>167924 | <b>XTRG10B12DS</b><br>167934 | <b>XTRG10B03DS</b><br>167975 |
| 48VAC 50Hz   | <b>XTRG10B30C5</b><br>168042 | <b>XTRG10B21C5</b><br>167925 | <b>XTRG10B12C5</b><br>167966 | <b>XTRG10B03C5</b><br>167976 |
| 110VAC 50Hz  | <b>XTRG10B30E5</b><br>168043 | <b>XTRG10B21E5</b><br>167926 | <b>XTRG10B12E5</b><br>167967 | <b>XTRG10B03E5</b><br>167977 |
| 220VAC 50Hz  | <b>XTRG10B30DT</b><br>168044 | <b>XTRG10B21DT</b><br>167927 | <b>XTRG10B12DT</b><br>167968 | <b>XTRG10B03DT</b><br>167978 |
| 380VAC 50Hz  | <b>XTRG10B30DU</b><br>168047 | <b>XTRG10B21DU</b><br>167930 | <b>XTRG10B12DU</b><br>167971 | <b>XTRG10B03DU</b><br>167936 |
| 24V 50/60Hz  | <b>XTRG10B30B2</b><br>177675 | <b>XTRG10B21B2</b><br>177687 | <b>XTRG10B12B2</b><br>177693 | <b>XTRG10B03B2</b><br>177681 |
| 36V 50/60Hz  | <b>XTRG10B30DV</b><br>177676 | <b>XTRG10B21DV</b><br>177688 | <b>XTRG10B12DV</b><br>177694 | <b>XTRG10B03DV</b><br>177682 |
| 48V 50/60Hz  | <b>XTRG10B30C2</b><br>177677 | <b>XTRG10B21C2</b><br>177689 | <b>XTRG10B12C2</b><br>177695 | <b>XTRG10B03C2</b><br>177683 |
| 110V 50/60Hz | <b>XTRG10B30E2</b><br>177678 | <b>XTRG10B21E2</b><br>177690 | <b>XTRG10B12E2</b><br>177696 | <b>XTRG10B03E2</b><br>177684 |
| 220V 50/60Hz | <b>XTRG10B30AO</b><br>177679 | <b>XTRG10B21AO</b><br>177691 | <b>XTRG10B12AO</b><br>177697 | <b>XTRG10B03AO</b><br>177685 |
| 380V 50/60Hz | <b>XTRG10B30AR</b><br>177680 | <b>XTRG10B21AR</b><br>177692 | <b>XTRG10B12AR</b><br>177698 | <b>XTRG10B03AR</b><br>177686 |
| 24V DC       | <b>XTRG10B30B0</b><br>178153 | <b>XTRG10B21B0</b><br>178152 | <b>XTRG10B12B0</b><br>178154 | <b>XTRG10B03B0</b><br>178151 |

Auxiliary contact, top mounting

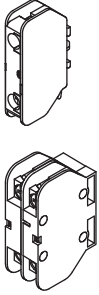

Auxiliary contact modules

| Connection type |        | Conventional thermal current open, 40°C<br><br>$I_{th} = I_e$ AC-1 A | Contact<br><br>N/O=Normally open<br>N/C=Normal closed |       | Circuit symbol | Can be combined with control relay | Part no. Article no.        | Standard package |
|-----------------|--------|--|---|-------|----------------|------------------------------------|-----------------------------|------------------|
| Screw terminals | 1 pole | 10   | 1 N/O   | -     |                | XTRG10B..                          | <b>XTCGXFAC10</b><br>167939 | 1 piece          |
| Screw terminals | 1 pole | 10   | -   | 1 N/C |                | XTRG10B..                          | <b>XTCGXFAC01</b><br>167940 | 1 piece          |
| Screw terminals | 2 pole | 10   | 2 N/O   | -     |                | XTRG10B..                          | <b>XTCGXFAC20</b><br>167941 | 1 piece          |
| Screw terminals | 2 pole | 10   | 1 N/O   | 1 N/C |                | XTRG10B..                          | <b>XTCGXFAC11</b><br>167942 | 1 piece          |
| Screw terminals | 2 pole | 10   | -   | 2 N/C |                | XTRG10B..                          | <b>XTCGXFAC02</b><br>167943 | 1 piece          |

Coil surge suppressor

| Coil voltage | RC                          | Varistor                    |
|--------------|-----------------------------|-----------------------------|
| 24-48V       | <b>XTCGXRSCN2</b><br>167946 | <b>XTCGXVSCN2</b><br>167949 |
| 110-220V     | <b>XTCGXRSCDV</b><br>167947 | <b>XTCGXVSCDV</b><br>167950 |
| 380-440V     | <b>XTCGXRSCCM</b><br>167948 | <b>XTCGXVSCCM</b><br>167951 |

# 2.1

## Control relays XTRG

### Technical data

#### General

2

|                                    |              |                   | XTRG10B..  | XTCGXFAC.. |
|------------------------------------|--------------|-------------------|--|------------|
| Standards                          |              |                   | IEC/EN 60947, GB 14048   |            |
| <b>Mechanical lifespan</b>         |              |                   |  |            |
| AC operated                        | Operations   | x 10 <sup>6</sup> | 10   | 10         |
| <b>Maximum operating frequency</b> |              |                   |  |            |
| Maximum operating frequency        | Operations/h |                   | 3600   | 3600       |
| Climatic proofing                  |              |                   | Damp heat, constant, to IEC 60068-2-78<br>Damp heat, cyclic, to IEC 60068-2-30 |            |
| <b>Ambient temperature</b>         |              |                   |  |            |
| Operation                          |              | °C                | -25-55   | -25-55     |
| Storage                            |              | °C                | -40-80   | -40-80     |
| Protection type                    |              |                   | IP20   | IP20       |
| Weight approximate weight          |              | kg                | 0.17   | 0.02       |

#### Contacts





|  |                  |                   | XTRG10B.. | XTCGXFAC.. |
|--|------------------|-------------------|-----------|------------|
| Rated impulse withstand voltage          | U <sub>imp</sub> | VAC               | 6000      | 6000       |
| Overvoltage category/degree of pollution |                  |                   | III/3     | III/3      |
| Rated insulation voltage                 | U <sub>i</sub>   | VAC               | 690       | 690        |
| Rated operational voltage                | U <sub>e</sub>   | VAC               | 660       | 660        |
| Rated operational current                |                  |                   |           |            |
| <b>AC-15</b>                             |                  |                   |           |            |
| 120V                                     | I <sub>e</sub>   | A                 | 6         | 6          |
| 240V                                     | I <sub>e</sub>   | A                 | 4         | 4          |
| 380V                                     | I <sub>e</sub>   | A                 | 1.9       | 1.9        |
| 480V                                     | I <sub>e</sub>   | A                 | 1.5       |            |
| 500V                                     | I <sub>e</sub>   | A                 | 1.4       |            |
| 600V                                     | I <sub>e</sub>   | A                 | 1.2       |            |
| <b>DC-13</b>                             |                  |                   |           |            |
| 125V                                     | I <sub>e</sub>   | A                 | 0.55      | 0.55       |
| 250V                                     | I <sub>e</sub>   | A                 | 0.27      | 0.27       |
| Conventional thermal current             | I <sub>th</sub>  | A                 | 10        | 10         |
| <b>Electrical lifespan</b>               |                  |                   |           |            |
| at U <sub>e</sub> =230V, AC-15, 3A       | Operations       | x 10 <sup>6</sup> | 1         | 1          |

**Magnet system**



|   |              |         | <b>XTRG10B..</b> |
|---|--------------|---------|------------------|
| Voltage tolerance   | Pick-up      | $x U_c$ | 0.85-1.1         |
| Power consumption of coil in a cold state and 1.0 xUc (50Hz)    | Pick-up      | VA      | 30               |
|   | Sealing      | VA      | 6                |
|   | Sealing      | W       | 2                |
|   | Sealing      | W       | 2                |
| Power consumption of coil in a cold state and 1.0 xUc (50/60Hz) | 50Hz Pick-up | VA      | 35               |
|   | 50Hz Sealing | VA      | 6.5              |
|   | 50Hz Sealing | W       | 2.3              |
| Power consumption of coil in a cold state and 1.0 xUc (50/60Hz) | 60Hz Pick-up | VA      | 30               |
|   | 60Hz Sealing | VA      | 6                |
|   | 60Hz Sealing | W       | 2.1              |
| Power consumption of coil in a cold state and 1.0 xUc (24VDC)   | Pick-up      | VA      | 12               |
|   | Sealing      | W       | 3                |

**Terminals**

**XTRG10B..**

|   | <br>mm <sup>2</sup> | <br>mm <sup>2</sup> | Nm  |
|--|--|--|-----|
|   | 0.75-2.5   | 0.75-2.5   | 0.8 |
|  | 0.75-2.5   | 0.75-2.5   |     |

**XTCGXFAC..**

| A1 / A2 / Aux  | mm <sup>2</sup> | Nm  |
|--|-----------------|-----|
|   | 0.75-2.5        | 0.8 |
|  |                 |     |

# 2.1

## Contactors XTCG

Contents

### Contactors XTCG

2



### System overview

Contactors XTCG ..... 6

### Product selection

Basic devices XTCG ..... 7  
 Auxiliary contact modules ..... 7  
 Accessories ..... 8

### Technical data

Contactors XTCG ..... 10  
 Auxiliary contact modules ..... 11

## Contactors XTCG

### Product description

The XTCG is the flagship of the E Line family of motor controls. The XTCG contactor offers space savings, enhanced reliability and more efficient use of materials. Boasting AC-3 ratings up to 95A @ 400V and with a maximum operating voltage of 660V, XTCG offers tremendous performance in a small package.

### Features

- Technologically advanced contact design
- 690V insulation rating
- Operating voltage up to 660VAC
- Up to (3) add on auxiliary contact modules
- All common AC control voltages
- DIN rail or panel mount options
- Unique space saving design

### System overview

3 phase contactors are used to start motors or control industrial loads. The E Line family of contactors allows the starting of motors up to 45kW, and when combined with an XTOD overload relay or PKZC motor protective circuit breaker offers a complete package of protection and control for long life and reliable operation.

### Standards and certifications

- GB 14048
- IEC/EN 60947
- CCC
- CE

## Accessory overview

7-12A Frame

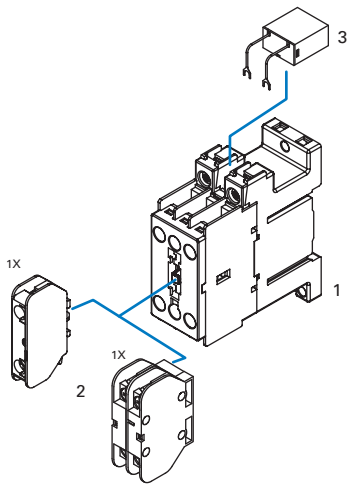

18-38A Frame

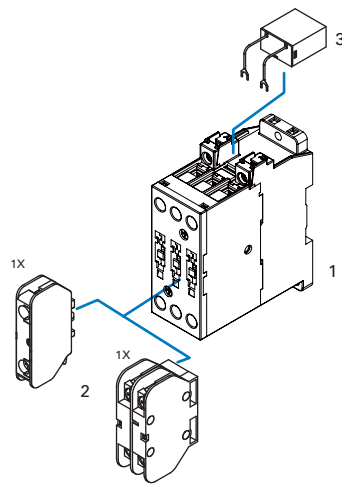

40-95A Frame

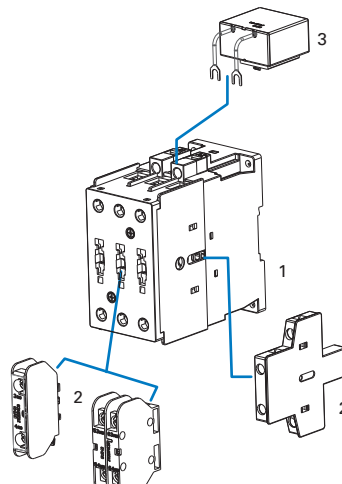

With mechanical interlock

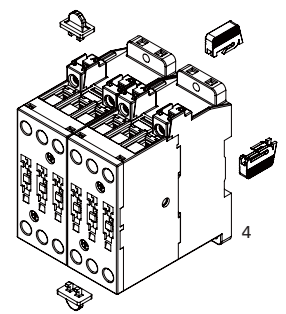

- 1 Contactor relay
- 2 Auxiliary contact modules
- 3 Surge suppressor
- 4 Interlocking kit

XTCG



3-pole contactors

| Connection type | Rated operational current AC-3 I <sub>e</sub> (A) 380V | Max motor rating for 3-phase motors, 50-60Hz AC-3 P kW |      |       | Conventional thermal current, open, 40 °C I <sub>th</sub> = I <sub>e</sub> AC-1(A) | Circuit symbol | AC operation Part no. Article no. Actuating voltage 220V 50Hz | Standard package |
|-----------------|--|--|------|-------|--|----------------|---|------------------|
|                 |  | 220V   | 380V | 660V* |  |                |   |                  |
| Screw terminals | 7  | 2.2  | 3    | 3.5   | 20   |                | <b>XTCG007B00DT</b><br>167984                                 | 1 piece          |
| Screw terminals | 9  | 2.5  | 4    | 4.5   | 20   |                | <b>XTCG009B00DT</b><br>167994                                 | 1 piece          |
| Screw terminals | 12   | 3.5  | 5.5  | 5.5   | 20   |                | <b>XTCG012B00DT</b><br>168004                                 | 1 piece          |
| Screw terminals | 18   | 5  | 7.5  | 7.5   | 25   |                | <b>XTCG018C00DT</b><br>168014                                 | 1 piece          |
| Screw terminals | 25   | 7.5  | 11   | 11    | 35   |                | <b>XTCG025C00DT</b><br>168024                                 | 1 piece          |
| Screw terminals | 32   | 10   | 15   | 15    | 40   |                | <b>XTCG032C00DT</b><br>168034                                 | 1 piece          |
| Screw terminals | 38   | 11   | 18.5 | 22    | 40   |                | <b>XTCG038C00DT</b><br>174459                                 | 1 piece          |
| Screw terminals | 40   | 12.5   | 18.5 | 22    | 60   |                | <b>XTCG040D00DT</b><br>172214                                 | 1 piece          |
| Screw terminals | 50   | 15.5   | 22   | 30    | 70   |                | <b>XTCG050D00DT</b><br>172224                                 | 1 piece          |
| Screw terminals | 65   | 20   | 30   | 37    | 80   |                | <b>XTCG065D00DT</b><br>172234                                 | 1 piece          |
| Bolts terminals | 80   | 25   | 37   | 37    | 110  |                | <b>XTCG080E00DT</b><br>172244                                 | 1 piece          |
| Bolts terminals | 95   | 30   | 45   | 45    | 120  |                | <b>XTCG095E00DT</b><br>172254                                 | 1 piece          |

\* 40-95A is 690V.

Auxiliary contact modules

| Connection type | Poles  | Conventional thermal current open, 40 °C I <sub>th</sub> = I <sub>e</sub> AC-1 A | Contact           |                   | Circuit symbol | Can be combined with control relay   | Part no. Article no.        | Standard package |
|-----------------|--------|--|-------------------|-------------------|----------------|--|-----------------------------|------------------|
|                 |        |  | N/O=Normally open | N/C=Normal closed |                |  |                             |                  |
| Screw terminals | 1 pole | 10   | 1 N/O             | -                 |                | XTCG007B00..<br>XTCG009B00..   | <b>XTCGXFAC10</b><br>167939 | 1 piece          |
|                 | 1 pole | 10   | -                 | 1 N/C             |                | XTCG012B00..<br>XTCG018C00..   | <b>XTCGXFAC01</b><br>167940 | 1 piece          |
|                 | 2 pole | 10   | 2 N/O             | -                 |                | XTCG025C00..<br>XTCG032C00..   | <b>XTCGXFAC20</b><br>167941 | 1 piece          |
|                 | 2 pole | 10   | 1 N/O             | 1 N/C             |                | XTCG040D00..<br>XTCG050D00..   | <b>XTCGXFAC11</b><br>167942 | 1 piece          |
|                 | 2 pole | 10   | -                 | 2 N/C             |                | XTCG065D00..<br>XTCG080E00..<br>XTCG095E00..                                 | <b>XTCGXFAC02</b><br>167943 | 1 piece          |
| Screw terminals | 2 pole | 10   | 1 N/O             | 1 N/C             |                | XTCG040D00..<br>XTCG050D00..<br>XTCG065D00..<br>XTCG080E00..<br>XTCG095E00.. | <b>XTCGXSAE11</b><br>172260 | 1 piece          |

Top mounting

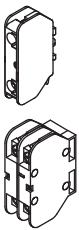

Side mounting





# 2.1

## Contactors XTCG Product Selection

### Actuating voltages

2

| Coil voltage   | 7A                            | 9A                            | 12A                           | 18A                           | 25A                           | 32A                           | 38A                           |
|----------------|-------------------------------|-------------------------------|-------------------------------|-------------------------------|-------------------------------|-------------------------------|-------------------------------|
| 24VAC 50Hz     | <b>XTCG007B00B5</b><br>167980 | <b>XTCG009B00B5</b><br>167990 | <b>XTCG012B00B5</b><br>168000 | <b>XTCG018C00B5</b><br>168010 | <b>XTCG025C00B5</b><br>168020 | <b>XTCG032C00B5</b><br>168030 | <b>XTCG038C00B5</b><br>174455 |
| 36VAC 50Hz     | <b>XTCG007B00DS</b><br>167981 | <b>XTCG009B00DS</b><br>167991 | <b>XTCG012B00DS</b><br>168001 | <b>XTCG018C00DS</b><br>168011 | <b>XTCG025C00DS</b><br>168021 | <b>XTCG032C00DS</b><br>168031 | <b>XTCG038C00DS</b><br>174456 |
| 48VAC 50Hz     | <b>XTCG007B00C5</b><br>167982 | <b>XTCG009B00C5</b><br>167992 | <b>XTCG012B00C5</b><br>168002 | <b>XTCG018C00C5</b><br>168012 | <b>XTCG025C00C5</b><br>168022 | <b>XTCG032C00C5</b><br>168032 | <b>XTCG038C00C5</b><br>174457 |
| 110VAC 50Hz    | <b>XTCG007B00E5</b><br>167983 | <b>XTCG009B00E5</b><br>167993 | <b>XTCG012B00E5</b><br>168003 | <b>XTCG018C00E5</b><br>168013 | <b>XTCG025C00E5</b><br>168023 | <b>XTCG032C00E5</b><br>168033 | <b>XTCG038C00E5</b><br>174458 |
| 220VAC 50Hz    | <b>XTCG007B00DT</b><br>167984 | <b>XTCG009B00DT</b><br>167994 | <b>XTCG012B00DT</b><br>168004 | <b>XTCG018C00DT</b><br>168014 | <b>XTCG025C00DT</b><br>168024 | <b>XTCG032C00DT</b><br>168034 | <b>XTCG038C00DT</b><br>174459 |
| 380VAC 50Hz    | <b>XTCG007B00DU</b><br>167987 | <b>XTCG009B00DU</b><br>167997 | <b>XTCG012B00DU</b><br>168007 | <b>XTCG018C00DU</b><br>168017 | <b>XTCG025C00DU</b><br>168027 | <b>XTCG032C00DU</b><br>168037 | <b>XTCG038C00DU</b><br>174462 |
| 24VAC 50/60Hz  | <b>XTCG007B00B2</b><br>177208 | <b>XTCG009B00B2</b><br>177214 | <b>XTCG012B00B2</b><br>177220 | <b>XTCG018C00B2</b><br>177226 | <b>XTCG025C00B2</b><br>177232 | <b>XTCG032C00B2</b><br>177238 | <b>XTCG038C00B2</b><br>177639 |
| 36VAC 50/60Hz  | <b>XTCG007B00DV</b><br>177242 | <b>XTCG009B00DV</b><br>177243 | <b>XTCG012B00DV</b><br>177244 | <b>XTCG018C00DV</b><br>177245 | <b>XTCG025C00DV</b><br>177246 | <b>XTCG032C00DV</b><br>177247 | <b>XTCG038C00DV</b><br>177640 |
| 48VAC 50/60Hz  | <b>XTCG007B00C2</b><br>177209 | <b>XTCG009B00C2</b><br>177215 | <b>XTCG012B00C2</b><br>177221 | <b>XTCG018C00C2</b><br>177227 | <b>XTCG025C00C2</b><br>177233 | <b>XTCG032C00C2</b><br>177192 | <b>XTCG038C00C2</b><br>177641 |
| 110VAC 50/60Hz | <b>XTCG007B00E2</b><br>177210 | <b>XTCG009B00E2</b><br>177216 | <b>XTCG012B00E2</b><br>177222 | <b>XTCG018C00E2</b><br>177228 | <b>XTCG025C00E2</b><br>177234 | <b>XTCG032C00E2</b><br>177193 | <b>XTCG038C00E2</b><br>177642 |
| 220VAC 50/60Hz | <b>XTCG007B00AO</b><br>177205 | <b>XTCG009B00AO</b><br>177211 | <b>XTCG012B00AO</b><br>177217 | <b>XTCG018C00AO</b><br>177223 | <b>XTCG025C00AO</b><br>177229 | <b>XTCG032C00AO</b><br>177235 | <b>XTCG038C00AO</b><br>177643 |
| 380VAC 50/60Hz | <b>XTCG007B00AR</b><br>177206 | <b>XTCG009B00AR</b><br>177212 | <b>XTCG012B00AR</b><br>177218 | <b>XTCG018C00AR</b><br>177224 | <b>XTCG025C00AR</b><br>177230 | <b>XTCG032C00AR</b><br>177236 | <b>XTCG038C00AR</b><br>177644 |
| 24VDC          | <b>XTCG007B00B0</b><br>177207 | <b>XTCG009B00B0</b><br>177213 | <b>XTCG012B00B0</b><br>177219 | <b>XTCG018C00B0</b><br>177225 | <b>XTCG025C00B0</b><br>177231 | <b>XTCG032C00B0</b><br>177237 | <b>XTCG038C00B0</b><br>177194 |

| 40A                           | 50A                           | 65A                           | 80A                           | 95A                           |
|-------------------------------|-------------------------------|-------------------------------|-------------------------------|-------------------------------|
| <b>XTCG040D00B5</b><br>172210 | <b>XTCG050D00B5</b><br>172220 | <b>XTCG065D00B5</b><br>172230 | <b>XTCG080E00B5</b><br>172240 | <b>XTCG095E00B5</b><br>172250 |
| <b>XTCG040D00DS</b><br>172211 | <b>XTCG050D00DS</b><br>172221 | <b>XTCG065D00DS</b><br>172231 | <b>XTCG080E00DS</b><br>172241 | <b>XTCG095E00DS</b><br>172251 |
| <b>XTCG040D00C5</b><br>172212 | <b>XTCG050D00C5</b><br>172222 | <b>XTCG065D00C5</b><br>172232 | <b>XTCG080E00C5</b><br>172242 | <b>XTCG095E00C5</b><br>172252 |
| <b>XTCG040D00E5</b><br>172213 | <b>XTCG050D00E5</b><br>172223 | <b>XTCG065D00E5</b><br>172233 | <b>XTCG080E00E5</b><br>172243 | <b>XTCG095E00E5</b><br>172253 |
| <b>XTCG040D00DT</b><br>172214 | <b>XTCG050D00DT</b><br>172224 | <b>XTCG065D00DT</b><br>172234 | <b>XTCG080E00DT</b><br>172244 | <b>XTCG095E00DT</b><br>172254 |
| <b>XTCG040D00DU</b><br>172217 | <b>XTCG050D00DU</b><br>172227 | <b>XTCG065D00DU</b><br>172237 | <b>XTCG080E00DU</b><br>172247 | <b>XTCG095E00DU</b><br>172257 |
| <b>XTCG040D00B2</b><br>177645 | <b>XTCG050D00B2</b><br>177651 | <b>XTCG065D00B2</b><br>177657 | <b>XTCG080E00B2</b><br>177663 | <b>XTCG095E00B2</b><br>177669 |
| <b>XTCG040D00DV</b><br>177646 | <b>XTCG050D00DV</b><br>177652 | <b>XTCG065D00DV</b><br>177658 | <b>XTCG080E00DV</b><br>177664 | <b>XTCG095E00DV</b><br>177670 |
| <b>XTCG040D00C2</b><br>177647 | <b>XTCG050D00C2</b><br>177653 | <b>XTCG065D00C2</b><br>177659 | <b>XTCG080E00C2</b><br>177665 | <b>XTCG095E00C2</b><br>177671 |
| <b>XTCG040D00E2</b><br>177648 | <b>XTCG050D00E2</b><br>177654 | <b>XTCG065D00E2</b><br>177660 | <b>XTCG080E00E2</b><br>177666 | <b>XTCG095E00E2</b><br>177672 |
| <b>XTCG040D00AO</b><br>177649 | <b>XTCG050D00AO</b><br>177655 | <b>XTCG065D00AO</b><br>177661 | <b>XTCG080E00AO</b><br>177667 | <b>XTCG095E00AO</b><br>177673 |
| <b>XTCG040D00AR</b><br>177650 | <b>XTCG050D00AR</b><br>177656 | <b>XTCG065D00AR</b><br>177662 | <b>XTCG080E00AR</b><br>177668 | <b>XTCG095E00AR</b><br>177674 |
| <b>XTCG040D00B0</b><br>177195 | <b>XTCG050D00B0</b><br>177196 | <b>XTCG065D00B0</b><br>177197 | <b>XTCG080E00B0</b><br>177198 | <b>XTCG095E00B0</b><br>177199 |

# 2.1

## Contactors XTCG

Technical data

### General

2

| XT Basic device   |              |                          | CG007  | CG009     | CG012     | CG018     | CG025     | CG032     |
|---|--------------|--------------------------|--|-----------|-----------|-----------|-----------|-----------|
| Standards   |              |                          | IEC/EN 60947, GB 14048   |           |           |           |           |           |
| <b>Lifespan, mechanical</b>   |              |                          |  |           |           |           |           |           |
| AC operated   | Operations   | x 10 <sup>6</sup>        | 10   | 10        | 10        | 10        | 10        | 10        |
| <b>Operating frequency</b>  |              |                          |  |           |           |           |           |           |
| AC operated   | Operations/h |                          | 3600   | 3600      | 3600      | 3600      | 3600      | 3600      |
| Climatic Proofing   |              |                          | Damp heat,constant,to IEC60068-2-78<br>Damp heat,cyclic,to IEC60068-2-30 |           |           |           |           |           |
| <b>Ambient temperature</b>  |              |                          |  |           |           |           |           |           |
| Operation   |              | °C                       | -25-55   | -25-55    | -25-55    | -25-55    | -25-55    | -25-55    |
| Storage   |              | °C                       | -40-80   | -40-80    | -40-80    | -40-80    | -40-80    | -40-80    |
| Protection type   |              |                          | IP20   | IP20      | IP20      | IP20      | IP20      | IP20      |
| Weight  |              |                          | kg   | 0.17      | 0.17      | 0.17      | 0.35      | 0.35      |
| <b>Terminal capacity of main cable</b>  |              |                          |  |           |           |           |           |           |
| Solid/stranded  |              | AWG                      |  |           |           |           |           |           |
| Terminal capacity of control circuit cable  |              | mm <sup>2</sup>          | 0.75-2.5   | 0.75-2.5  | 0.75-2.5  | 0.75-2.5  | 0.75-2.5  | 0.75-2.5  |
| Main cable connection screws / bolts  |              |                          | M3.5   | M3.5      | M3.5      | M5        | M5        | M5        |
| Tightening torque   |              |                          | Nm   | 0.8       | 0.8       | 0.8       | 2         | 2         |
| Control circuit cable connection screws   |              |                          | M3.5   | M3.5      | M3.5      | M3.5      | M3.5      | M3.5      |
| Tightening torque   |              |                          | Nm   | 0.8       | 0.8       | 0.8       | 0.8       | 0.8       |
| <b>Main contacts</b>  |              |                          |  |           |           |           |           |           |
| Rated impulse withstand voltage   |              | U <sub>imp</sub> V AC    | 6000   | 6000      | 6000      | 6000      | 6000      | 6000      |
| Overvoltage category / pollution degree   |              |                          | III/3  | III/3     | III/3     | III/3     | III/3     | III/3     |
| Rated insulation voltage  |              | U <sub>i</sub> V AC      | 690  | 690       | 690       | 690       | 690       | 690       |
| Rated operational voltage   |              | U <sub>e</sub> V AC      | 660  | 660       | 660       | 660       | 660       | 660       |
| Making capacity (cos φ to IEC/EN60947)  |              | 380V A                   | 70   | 90        | 120       | 180       | 250       | 320       |
| <b>Breaking capacity (cos φ to IEC/EN60947)</b>                                     |              | 380V A                   | 56   | 72        | 96        | 144       | 200       | 256       |
| <b>Electrical lifespan</b>  |              |                          |  |           |           |           |           |           |
| AC-3  |              | Op.                      | 1,500,000  | 1,500,000 | 1,500,000 | 1,000,000 | 1,000,000 | 1,000,000 |
| AC-4  |              | Op.                      | 100,000  | 100,000   | 100,000   | 100,000   | 100,000   | 100,000   |
| <b>Magnet systems</b>   |              |                          |  |           |           |           |           |           |
| Voltage tolerance AC operated   |              | Pick-up x U <sub>c</sub> | 0.85-1.1   | 0.85-1.1  | 0.85-1.1  | 0.85-1.1  | 0.85-1.1  | 0.85-1.1  |
| <b>Power consumption of coil in a cold state and 1.0 xU<sub>c</sub></b>             |              | Pick-up VA               | 30   | 30        | 30        | 80        | 80        | 80        |
|   |              | Sealing VA               | 6  | 6         | 6         | 8.1       | 8.1       | 8.1       |
|   |              | Sealing W                | 2  | 2         | 2         | 2.4       | 2.4       | 2.4       |
| <b>Power consumption of coil in a cold state and 1.0 xU<sub>c</sub> ( 50/60Hz )</b> |              | 50Hz Pick-up VA          | 35   | 35        | 35        | 85        | 85        | 85        |
|   |              | 50Hz Sealing VA          | 6.5  | 6.5       | 6.5       | 8.5       | 8.5       | 8.5       |
|   |              | 50Hz Sealing W           | 2.3  | 2.3       | 2.3       | 2.6       | 2.6       | 2.6       |
| <b>Power consumption of coil in a cold state and 1.0 xU<sub>c</sub> ( 50/60Hz )</b> |              | 60Hz Pick-up VA          | 30   | 30        | 30        | 80        | 80        | 80        |
|   |              | 60Hz Sealing VA          | 6  | 6         | 6         | 8.1       | 8.1       | 8.1       |
|   |              | 60Hz Sealing W           | 2.1  | 2.1       | 2.1       | 2.5       | 2.5       | 2.5       |
| <b>Power consumption of coil in a cold state and 1.0 xU<sub>c</sub> ( 24VDC )</b>   |              | Pick-up VA               | 12   | 12        | 12        | 12        | 12        | 12        |
|   |              | Sealing W                | 3  | 3         | 3         | 3         | 3         | 3         |

| CG038  | CG040    | CG050    | CG065    | CG080    | CG095    |
|--|----------|----------|----------|----------|----------|
| IEC/EN 60947, GB 14048   |          |          |          |          |          |
| 10   | 5        | 5        | 5        | 5        | 5        |
| 3600   | 3600     | 3600     | 3600     | 3600     | 3600     |
| Damp heat,constant,to IEC60068-2-78<br>Damp heat,cyclic,to IEC60068-2-30 |          |          |          |          |          |
| -25~55   | -25~55   | -25~55   | -25~55   | -25~55   | -25~55   |
| -40~80   | -40~80   | -40~80   | -40~80   | -40~80   | -40~80   |
| IP20   | IP20     | IP20     | IP20     | IP20     | IP20     |
| 0.35   | 0.76     | 0.76     | 0.76     | 1.25     | 1.25     |
| 0.75-2.5   | 0.75-2.5 | 0.75-2.5 | 0.75-2.5 | 0.75-2.5 | 0.75-2.5 |
| M5   | M6       | M6       | M6       | M8       | M8       |
| 2  | 2.5      | 2.5      | 2.5      | 6        | 6        |
| M3.5   | M3.5     | M3.5     | M3.5     | M3.5     | M3.5     |
| 0.8  | 0.8      | 0.8      | 0.8      | 0.8      | 0.8      |
| 6000   | 6000     | 6000     | 6000     | 6000     | 6000     |
| III/3  | III/3    | III/3    | III/3    | III/3    | III/3    |
| 690  | 690      | 690      | 690      | 690      | 690      |
| 660  | 690      | 690      | 690      | 690      | 690      |
| 320  | 400      | 500      | 650      | 800      | 950      |
| 256  | 320      | 400      | 520      | 640      | 760      |
| 1,000,000  | 900,000  | 900,000  | 900,000  | 900,000  | 900,000  |
| 100,000  |          |          |          |          |          |
| 0.85-1.1   | 0.85-1.1 | 0.85-1.1 | 0.85-1.1 | 0.85-1.1 | 0.85-1.1 |
| 80   | 190      | 190      | 190      | 300      | 300      |
| 8.1  | 20       | 20       | 20       | 26       | 26       |
| 2.4  | 4        | 4        | 4        | 6        | 6        |
| 85   | 220      | 220      | 220      | 350      | 350      |
| 8.5  | 21       | 21       | 21       | 34       | 34       |
| 2.6  | 6        | 6        | 6        | 9        | 9        |
| 80   | 200      | 200      | 200      | 300      | 300      |
| 8.1  | 20       | 20       | 20       | 26       | 26       |
| 2.5  | 5        | 5        | 5        | 8        | 8        |
| 12   | 65       | 65       | 65       | 90       | 90       |
| 3  | 4        | 4        | 4        | 5        | 5        |

# 2.1

## Contactors XTCG



Technical data

### Auxiliary contact



|  |            |               | XTCGXFAC.. | XTCGXSAE11 |
|--|------------|---------------|------------|------------|
| Rated impulse withstand voltage          | $U_{imp}$  | VAC           | 6000       | 6000       |
| Overvoltage category/degree of pollution |            |               | III/3      | III/3      |
| Rated insulation voltage                 | $U_i$      | VAC           | 690        | 690        |
| Rated operational voltage                | $U_e$      | VAC           | 660        | 690        |
| Rated operational current                |            |               |            |            |
| <b>AC-15</b>                             |            |               |            |            |
| 120V                                     | $I_e$      | A             | 6          | 6          |
| 240V                                     | $I_e$      | A             | 4          | 4          |
| 380V                                     | $I_e$      | A             | 1.9        | 1.9        |
| <b>DC-13</b>                             |            |               |            |            |
| 125V                                     | $I_e$      | A             | 0.55       | 0.55       |
| 250V                                     | $I_e$      | A             | 0.27       | 0.27       |
| Conventional thermal current             | $I_{th}$   | A             | 10         | 10         |
| <b>Electrical lifespan</b>               |            |               |            |            |
| at $U_e=230V$ , AC-15, 3A                | Operations | $\times 10^6$ | 1          | 1          |

### Terminals



#### 7-12A

|   | mm <sup>2</sup> | mm <sup>2</sup> | Nm  | Aux Contact<br>mm <sup>2</sup> | Nm  |
|---|-----------------|-----------------|-----|--------------------------------|-----|
|   | 0.75 - 2.5      | 0.75 - 2.5      | 0.8 | 0.75 - 2.5                     | 0.8 |
|  | 0.75 - 2.5      | 0.75 - 2.5      |     |                                |     |



#### 18-38A

|  | mm <sup>2</sup>    | mm <sup>2</sup>    | Nm | Aux Contact<br>mm <sup>2</sup> | Nm  |
|--|--------------------|--------------------|----|--------------------------------|-----|
|  | 1 - 6<br>(1 - 10)* | 1 - 6<br>(1 - 10)* | 2  | 0.75 - 2.5                     | 0.8 |
|  | 1 - 4<br>(1 - 10)* | 1 - 4<br>(1 - 10)* |    |                                |     |

#### 40-65A

|  | mm <sup>2</sup> | mm <sup>2</sup> | Nm  | Aux Contact<br>mm <sup>2</sup> | Nm  |
|--|-----------------|-----------------|-----|--------------------------------|-----|
|  | 2.5 - 25        | 2.5 - 16        | 2.5 | 0.75 - 2.5                     | 1.2 |
|  | 2.5 - 25        | 2.5 - 16        |     |                                |     |

#### 80-95A

|  | mm <sup>2</sup> | mm <sup>2</sup> | Nm | Aux Contact<br>mm <sup>2</sup> | Nm  |
|--|-----------------|-----------------|----|--------------------------------|-----|
|  | 6 - 50          | 6 - 25          | 6  | 0.75 - 2.5                     | 1.2 |
|  | 6 - 50          | 6 - 25          |    |                                |     |

\* Only for XTCG032...

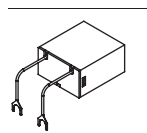

### Coil surge suppressor (7-38A)

| Coil voltage | RC                          | Varistor                    |
|--------------|-----------------------------|-----------------------------|
| 24-48V       | <b>XTCGXRSCN2</b><br>167946 | <b>XTCGXVSCN2</b><br>167949 |
| 110-220V     | <b>XTCGXRSCDV</b><br>167947 | <b>XTCGXVSCDV</b><br>167950 |
| 380-440V     | <b>XTCGXRSCCM</b><br>167948 | <b>XTCGXVSCCM</b><br>167951 |

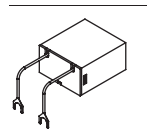

### Coil surge suppressor (40-95A)

| Coil voltage | RC                          | Varistor                    |
|--------------|-----------------------------|-----------------------------|
| 24V          | <b>XTCGXRSEB5</b><br>174132 | <b>XTCGXVSEB5</b><br>177204 |
| 36V          | <b>XTCGXRSEDS</b><br>174133 | <b>XTCGXVSEDS</b><br>177239 |
| 48V          | <b>XTCGXRSEC5</b><br>174134 | <b>XTCGXVSEC5</b><br>177201 |
| 110V         | <b>XTCGXRSEE5</b><br>174129 | <b>XTCGXVSEE5</b><br>177203 |
| 220V         | <b>XTCGXRSEDT</b><br>174135 | <b>XTCGXVSEDT</b><br>174142 |
| 380V         | <b>XTCGXRSEDU</b><br>174136 | <b>XTCGXVSEDU</b><br>174143 |

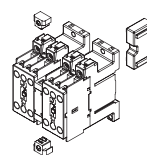

### Mechanical interlock

| 7-12A                     | 18-38A                    | 40-65A                    | 80-95A                    |
|---------------------------|---------------------------|---------------------------|---------------------------|
| <b>XTCGXMLB</b><br>167944 | <b>XTCGXMLC</b><br>167945 | <b>XTCGXMLD</b><br>172261 | <b>XTCGXMLE</b><br>172262 |

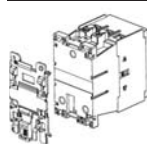

### Din rail plate

| 80-95A                     |
|----------------------------|
| <b>XTCGXMPPE</b><br>172908 |

**Thermal overload relays XTOD/XTOG**



**System overview**

Thermal overload relays XTOD/XTOG ..... 13

**Product selection**

Thermal overload relays XTOD/XTOG ..... 14

**Technical data**

Thermal overload relays XTOD/XTOG ..... 16

**Thermal overload relays XTOD/XTOG**

**Product description**

XTOD/XTOG thermal overload relays offer precision motor protection with phase loss protection and ambient temperature compensation. The separate mount design allows for flexibility and the units can be mounted on DIN rail or directly on the panel adjacent the motor contactor.

XTOD... is for separate mounting; XTOG is for direct mounting.

**Features**

- Precision motor protection up to 97A
- Integral 1NO/1NC contact for contactor control and alarm signal
- Phase loss protection
- Ambient temperature compensation
- DIN rail or panel mount options

**System overview**

Thermal overload relays provide protective features for 1 or 3 phase motors. The relay monitors the operating current of the motor and switched the contactor off in the event of an overload situation. It also protects the motor from damage during phase loss.

**Standards and certifications**

- GB 14048
- IEC/EN 60947
- CCC
- CE































# 2.2

## Thermal overload relays XTOD/XTOG











### Product selection

#### Thermal overload relays

2

| For use with  |                 | Setting range of overload releases $I_r$ (A)                                      | Circuit symbol  | Auxiliary contact   |                             | Part no. Article no.         | Standard package |
|---|-----------------|---|---|---|-----------------------------|------------------------------|------------------|
|   |                 |  |   | N/O =Normally open<br>N/C =Normally closed  |                             |                              |                  |
| <b>XTOD..CC1S</b><br> | XTCG007         | Seperate mounting   | 0.3~0.45  |    | 1 N/O 1 N/C                 | <b>XTODP45CC1S</b><br>167952 | 1 piece          |
|   | XTCG009         | Seperate mounting   | 0.45~0.67   |    | 1 N/O 1 N/C                 | <b>XTODP67CC1S</b><br>167953 | 1 piece          |
|   | XTCG012         |   |   |   |                             |                              |                  |
|   | XTCG018         | Seperate mounting   | 0.67~1.0  |    | 1 N/O 1 N/C                 | <b>XTOD001CC1S</b><br>167954 | 1 piece          |
|   | XTCG025         | Seperate mounting   | 1.0~1.5   |    | 1 N/O 1 N/C                 | <b>XTOD1P5CC1S</b><br>167955 | 1 piece          |
|   | XTCG032         |   |   |   |                             |                              |                  |
|   | XTCG038         | Seperate mounting   | 1.4~2.1   |    | 1 N/O 1 N/C                 | <b>XTOD2P2CC1S</b><br>167956 | 1 piece          |
|   |                 | Seperate mounting   | 1.8~2.7   |    | 1 N/O 1 N/C                 | <b>XTOD2P7CC1S</b><br>167957 | 1 piece          |
|   |                 | Seperate mounting   | 2.4~3.6   |    | 1 N/O 1 N/C                 | <b>XTOD3P6CC1S</b><br>167958 | 1 piece          |
|   |                 | Seperate mounting   | 3.5~5.0   |    | 1 N/O 1 N/C                 | <b>XTOD005CC1S</b><br>167959 | 1 piece          |
|   |                 | Seperate mounting   | 4.0~6.0   |    | 1 N/O 1 N/C                 | <b>XTOD006CC1S</b><br>167960 | 1 piece          |
|   |                 | Seperate mounting   | 5.5~8.5   |    | 1 N/O 1 N/C                 | <b>XTOD8P5CC1S</b><br>167961 | 1 piece          |
|   |                 | Seperate mounting   | 8.5~12.5  |   | 1 N/O 1 N/C                 | <b>XTOD013CC1S</b><br>167962 | 1 piece          |
|   |                 | Seperate mounting   | 12.5~18   |  | 1 N/O 1 N/C                 | <b>XTOD018CC1S</b><br>167963 | 1 piece          |
|   |                 | Seperate mounting   | 17~24   |  | 1 N/O 1 N/C                 | <b>XTOD024CC1S</b><br>167964 | 1 piece          |
|   |                 | Seperate mounting   | 22~30   |  | 1 N/O 1 N/C                 | <b>XTOD030CC1S</b><br>167965 | 1 piece          |
| <b>XTOG...</b><br>  | XTCG007         | Direct mounting   | 0.1~0.16  |  | 1 N/O 1 N/C                 | <b>XTOGP16BC1</b><br>173679  | 1 piece          |
|   | XTCG009         |   |   |   |                             |                              |                  |
|   | XTCG012         | Direct mounting   | 0.16~0.24   |  | 1 N/O 1 N/C                 | <b>XTOGP24BC1</b><br>173680  | 1 piece          |
|   | XTCG018         | Direct mounting   | 0.24~0.4  |  | 1 N/O 1 N/C                 | <b>XTOGP40BC1</b><br>173681  | 1 piece          |
|   | XTCG025         |   |   |   |                             |                              |                  |
|   | XTCG032         | Direct mounting   | 0.4~0.6   |  | 1 N/O 1 N/C                 | <b>XTOGP60BC1</b><br>173682  | 1 piece          |
|   | XTCG038         | Direct mounting   | 0.6~1   |  | 1 N/O 1 N/C                 | <b>XTOG001BC1</b><br>173683  | 1 piece          |
|   |                 |   |   |   |                             |                              |                  |
|   |                 | Direct mounting   | 1~1.6   |  | 1 N/O 1 N/C                 | <b>XTOG1P6BC1</b><br>173684  | 1 piece          |
|   |                 | Direct mounting   | 1.6~2.4   |  | 1 N/O 1 N/C                 | <b>XTOG2P4BC1</b><br>173685  | 1 piece          |
|   |                 | Direct mounting   | 2.4~4   |  | 1 N/O 1 N/C                 | <b>XTOG004BC1</b><br>173686  | 1 piece          |
|   |                 | Direct mounting   | 4~6   |  | 1 N/O 1 N/C                 | <b>XTOG006BC1</b><br>173687  | 1 piece          |
|   |                 | Direct mounting   | 6~10  |  | 1 N/O 1 N/C                 | <b>XTOG010BC1</b><br>173688  | 1 piece          |
|   |                 | Direct mounting   | 9-12  |  | 1 N/O 1 N/C                 | <b>XTOG012BC1</b><br>173689  | 1 piece          |
|   |                 | Direct mounting   | 12~16   |  | 1 N/O 1 N/C                 | <b>XTOG016CC1</b><br>173690  | 1 piece          |
|   |                 | Direct mounting   | 16~24   |  | 1 N/O 1 N/C                 | <b>XTOG024CC1</b><br>173691  | 1 piece          |
|   | Direct mounting | 24~32   |  | 1 N/O 1 N/C   | <b>XTOG032CC1</b><br>173692 | 1 piece                      |                  |

## Thermal overload relays

| For use with  |         | Setting range of overload releases $I_r$ (A)                                      | Circuit symbol | Auxiliary contact   |       | Part no. Article no. | Standard package            |         |
|---|---------|---|----------------|---|-------|----------------------|-----------------------------|---------|
|   |         |  |                | N/O = Normally open<br>N/C = Normally closed                                      |       |                      |                             |         |
| <b>XTOG...</b><br> | XTCG040 | Direct mounting   | 17~25          |  | 1 N/O | 1 N/C                | <b>XTOG025DC1</b><br>173693 | 1 piece |
|   | XTCG050 | Direct mounting   | 23~32          |  | 1 N/O | 1 N/C                | <b>XTOG032DC1</b><br>173694 | 1 piece |
|   | XTCG065 |   | 30~40          |  | 1 N/O | 1 N/C                | <b>XTOG040DC1</b><br>173695 | 1 piece |
|   | XTCG080 | Direct mounting   | 37~50          |  | 1 N/O | 1 N/C                | <b>XTOG050DC1</b><br>173696 | 1 piece |
|   | XTCG095 |   | 48~65          |  | 1 N/O | 1 N/C                | <b>XTOG065DC1</b><br>173697 | 1 piece |
|   |         | Direct mounting   | 37~50          |  | 1 N/O | 1 N/C                | <b>XTOG050EC1</b><br>173698 | 1 piece |
|   |         | Direct mounting   | 48~65          |  | 1 N/O | 1 N/C                | <b>XTOG065EC1</b><br>173699 | 1 piece |
|   |         | Direct mounting   | 63~80          |  | 1 N/O | 1 N/C                | <b>XTOG080EC1</b><br>173700 | 1 piece |
|   |         | Direct mounting   | 77~97          |  | 1 N/O | 1 N/C                | <b>XTOG097EC1</b><br>173701 | 1 piece |



# 2.2

## Thermal overload relays XTOD/XTOG

### Technical data

#### General

|                   |  | XTOD/XTOG  |
|-------------------|--|--|
| Standards         |  | IEC/EN 60947, GB 14048   |
| Climatic Proofing |  | Damp heat, constant, to IEC60068-2-78<br>Damp heat, cyclic, to IEC60068-2-30 |

#### Ambient temperature

|                          |    |        |
|--------------------------|----|--------|
| Open                     | °C | -25-55 |
| Enclosed                 | °C | -25-40 |
| Temperature compensation | °C | -5-40  |
| Weight                   | kg | 0.15   |
| Protection type          |    | IP20   |

#### Main contacts

|                                       |           | XTOD/XTOG |
|---------------------------------------|-----------|-----------|
| Rated impulse withstand voltage       | $U_{imp}$ | VAC 6000  |
| Overvoltage category/pollution degree |           | III/3     |

#### Rated insulation voltage

|                                |       |         |
|--------------------------------|-------|---------|
| AC                             | $U_i$ | VAC 690 |
| Rated operational voltage      | $U_e$ | VAC 690 |
| Overload release setting range | A     | 0.1-97  |

#### Terminal capacity

|                       |                 |                        |
|-----------------------|-----------------|------------------------|
| Solid                 | mm <sup>2</sup> | 1 x (1-6)<br>2 x (1-6) |
| Flexible with ferrule | mm <sup>2</sup> | 1 x (1-6)<br>2 x (1-6) |
| Solid/stranded        | AWG             |                        |
| Terminal screw        |                 | M4                     |
| Tightening torque     | Nm              | 1.2                    |

#### Auxiliary and control circuits

|                                       |           | XTOD/XTOG |
|---------------------------------------|-----------|-----------|
| Rated impulse withstand voltage       | $U_{imp}$ | V 6000    |
| Overvoltage category/pollution degree |           | III/3     |

#### Terminal capacity

|                       |                 |                        |
|-----------------------|-----------------|------------------------|
| Solid                 | mm <sup>2</sup> | 1 x (1-6)<br>2 x (1-6) |
| Flexible with ferrule | mm <sup>2</sup> | 1 x (1-6)<br>2 x (1-6) |
| Solid/stranded        | AWG             |                        |
| Terminal screw        |                 | M3.5                   |
| Tightening torque     | Nm              | 0.8                    |

|                              |          |         |
|------------------------------|----------|---------|
| Rated insulation voltage     | $U_i$    | VAC 690 |
| Rated operational voltage    | $U_e$    | VAC 690 |
| Conventional thermal current | $I_{th}$ | A 10    |
| Rated operational current    |          |         |

#### AC-15

|          |       |       |
|----------|-------|-------|
| 120V     | $I_e$ | A 6   |
| 220/240V | $I_e$ | A 3   |
| 380V     | $I_e$ | A 1.9 |
| 480V     | $I_e$ | A 1.5 |
| 500V     | $I_e$ | A 1.4 |
| 600V     | $I_e$ | A 1.2 |

#### DC-13

|      |       |        |
|------|-------|--------|
| 125V | $I_e$ | A 0.55 |
| 250V | $I_e$ | A 0.27 |

Contactors

7-12A Frame

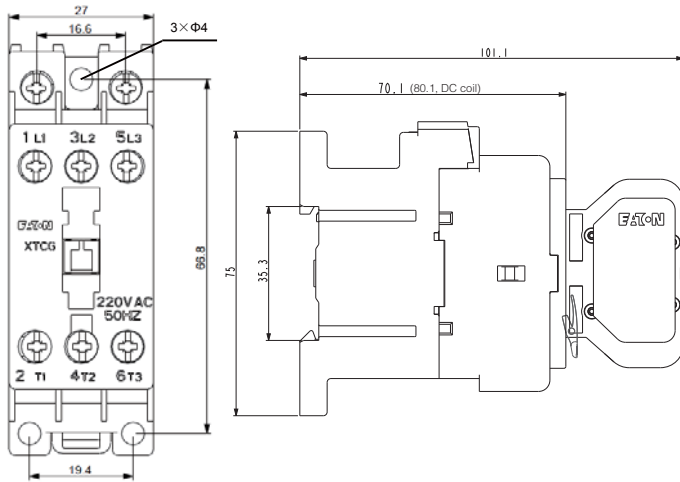

18-38A Frame

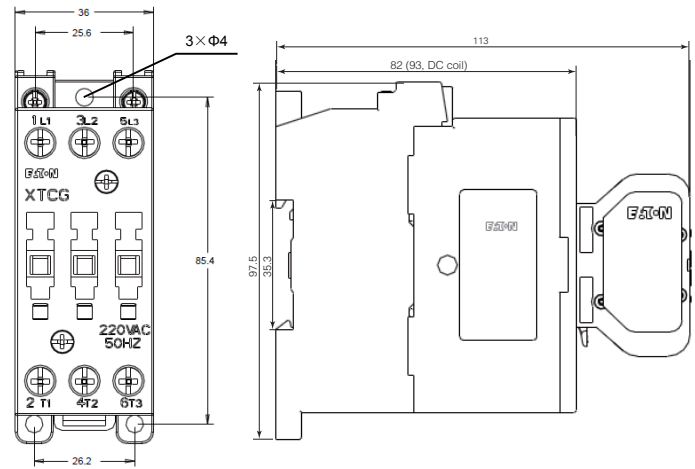

40-65A Frame

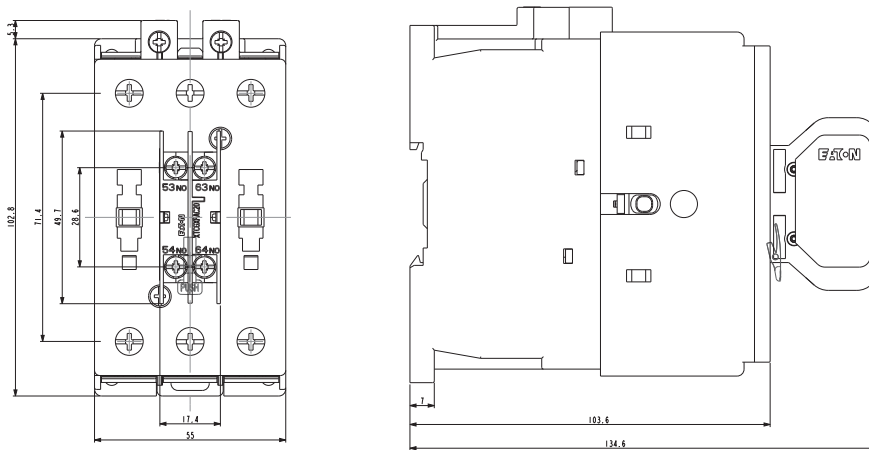

80-95A Frame

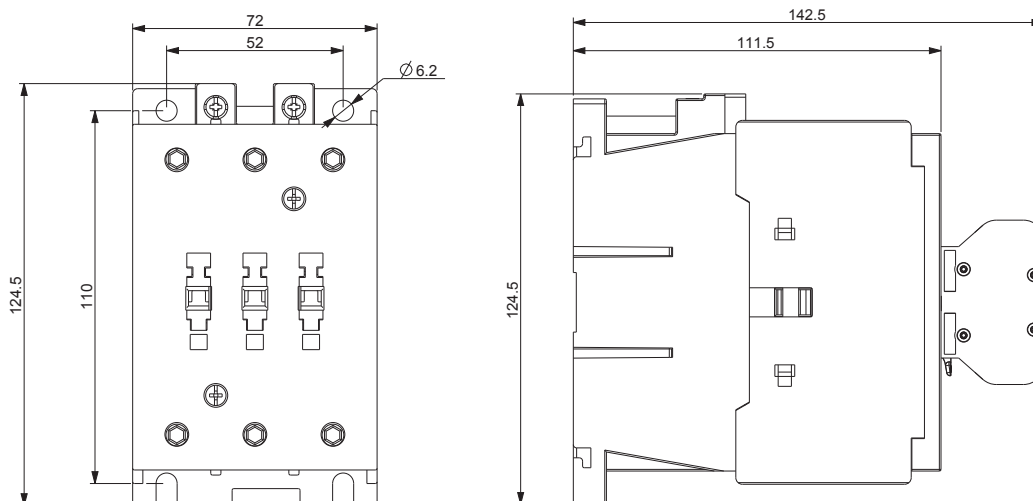

# 2.2

## Dimensions

Thermal overload relay XTOD/XTOG

### Thermal overload relay + mounting adapter

XTOD..CC1S

2

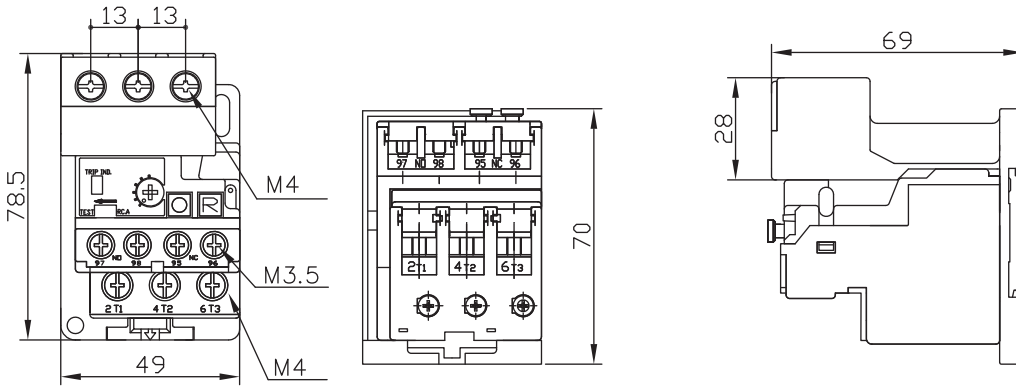

### Thermal overload relays XTOG

17-65A

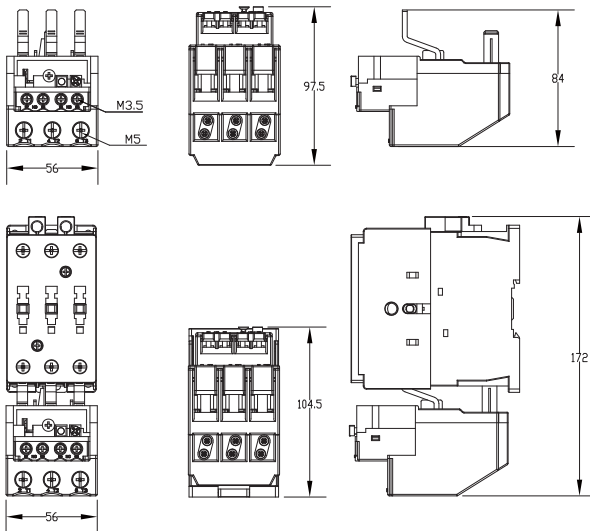

37-97A

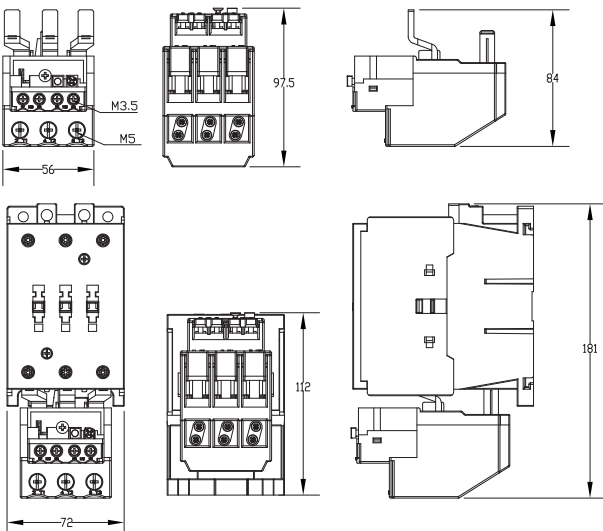

Auxiliary contact module

1 Pole

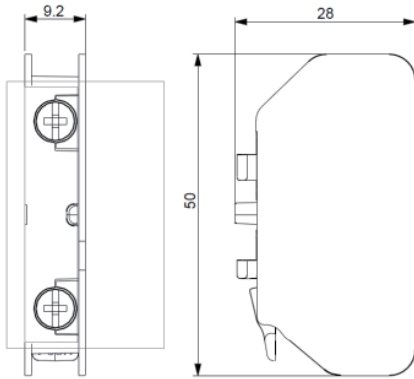

2 Pole

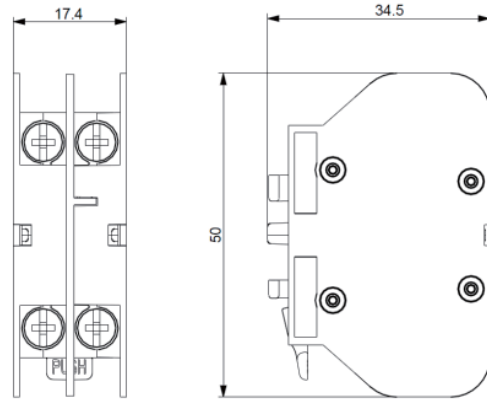

2

Side mounting contact module

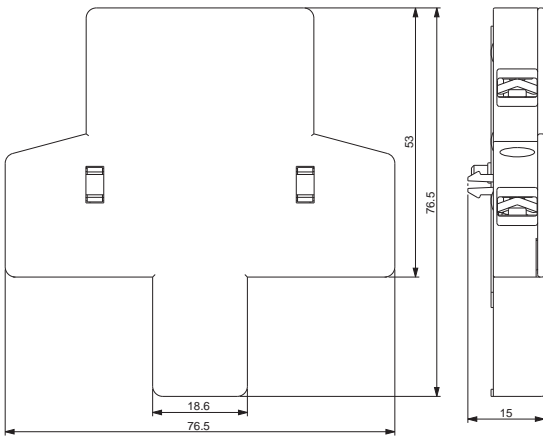

# 2.2

## Dimensions

Control relay XTRG / Surge suppressor

### Control Relay

2

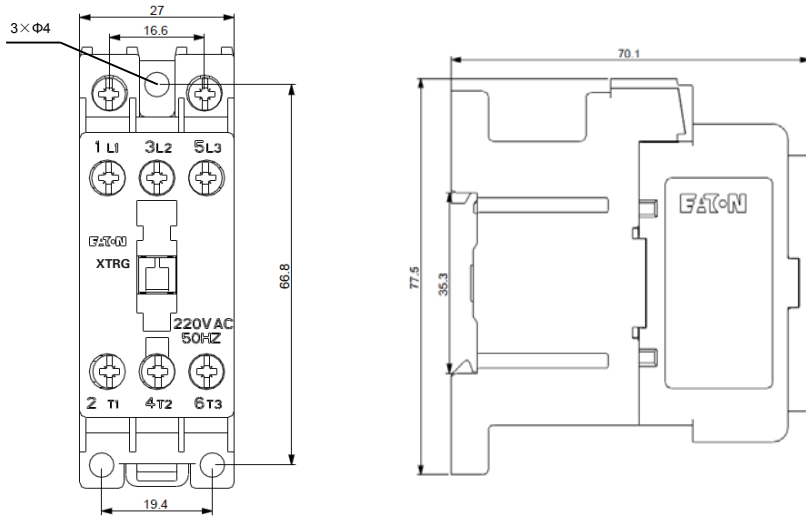

### Surge suppressor

#### 7-38A Surge suppressor

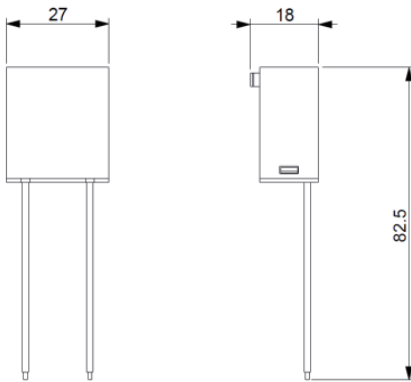

#### 40-95A Surge suppressor

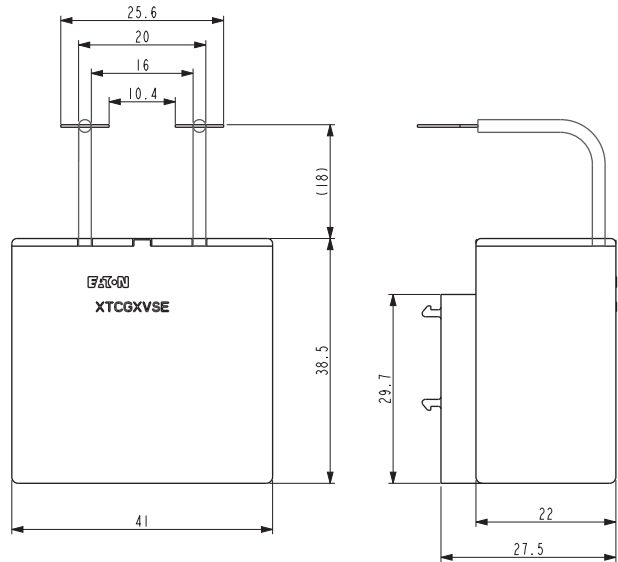

**Mechanical interlock**

**7-12A Frame**

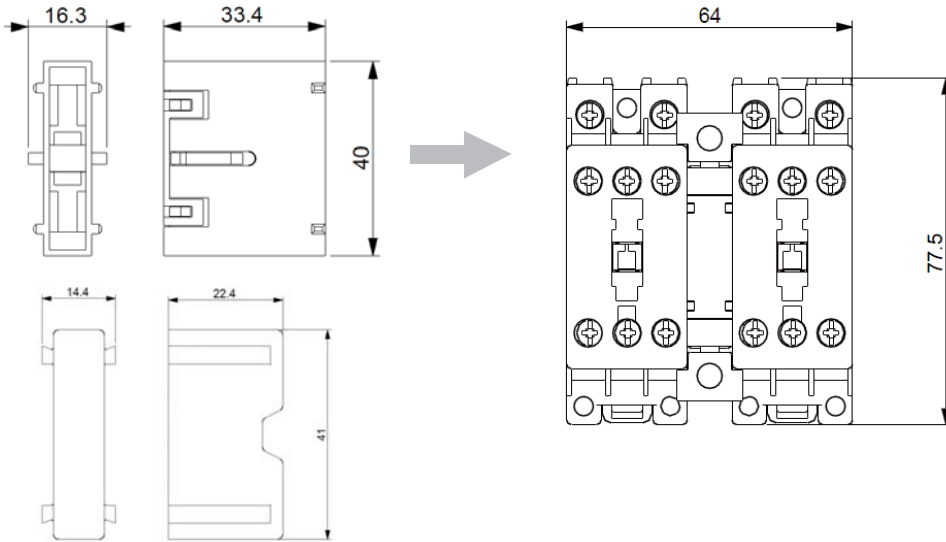

**18-38A Frame**

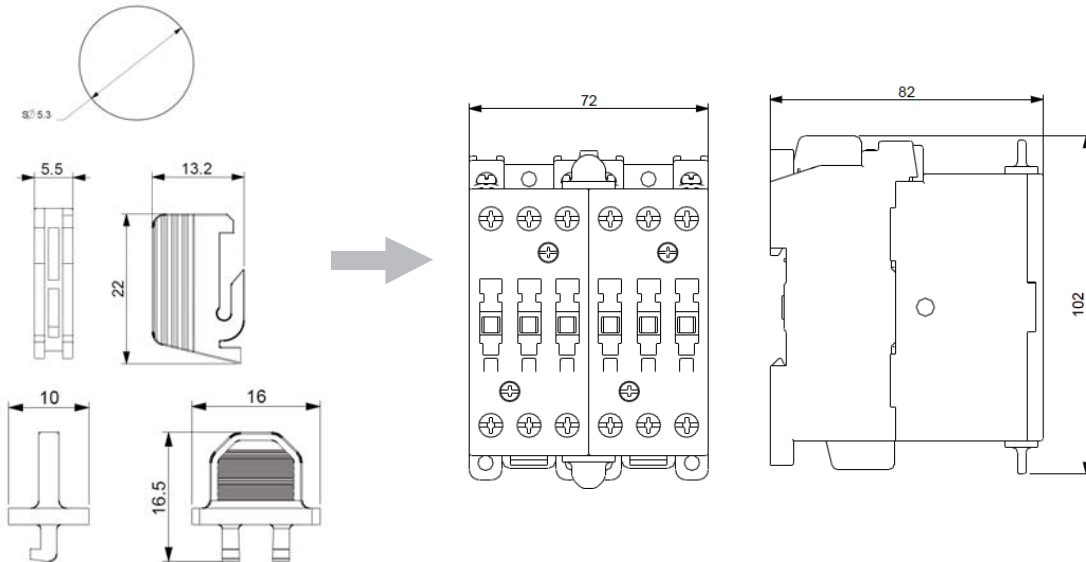

# 2.2

## Dimensions Mechanical interlock

### Mechanical interlock

#### 40-65A Frame

2

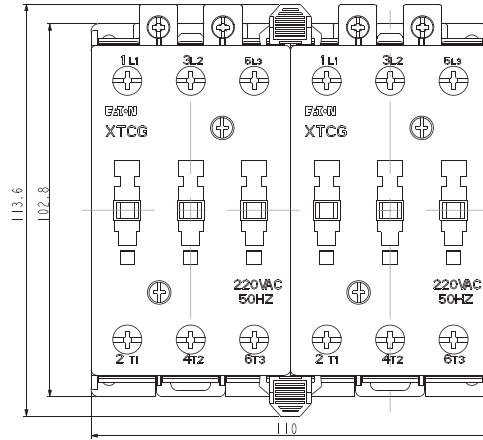
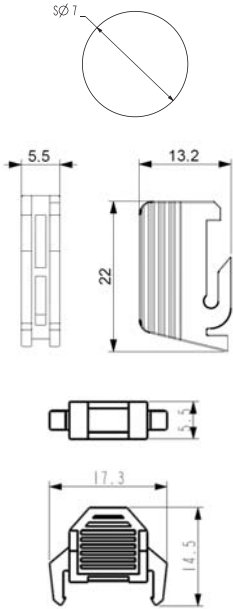

#### 80-95A Frame

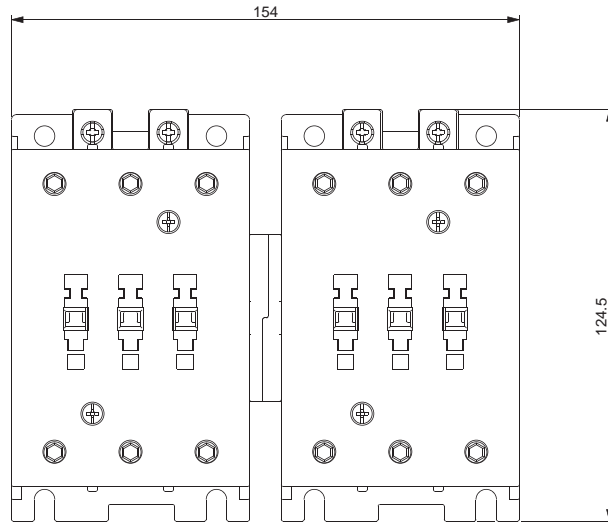
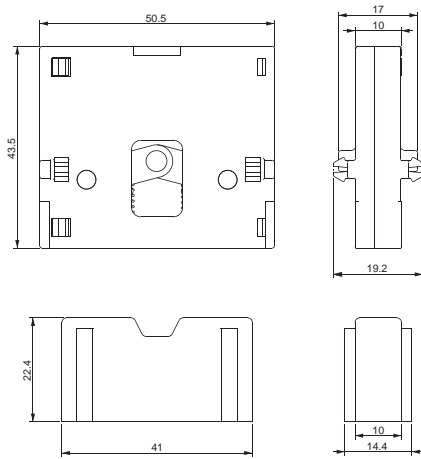

## X-ON Electronics

Largest Supplier of Electrical and Electronic Components

*Click to view similar products for [Industrial & Electrical Fuses](#) category:*

*Click to view products by [Eaton](#) manufacturer:*

Other Similar products are found below :

[MTH-4](#) [MTH-8](#) [BCC-1-8/10](#) [BP/FNM-5](#) [BP/NON-30](#) [KTN-R-10](#) [LPS-RK-2SP](#) [ABU-15](#) [ABU-25](#) [ABU-3](#) [ABU-35](#) [ABU-50](#) [ABU-60](#)  
[TCF40RN](#) [BCF-10](#) [3TX4431-0A](#) [BK-SC-20](#) [FNM-6-1-4](#) [FRN-R-6-1-4](#) [FRS-R-3-12](#) [KTK-1-1-2](#) [BBS-610](#) [FNM-6-10](#) [FNQ-R-1-1-4](#) [FRN-](#)  
[R-30ID](#) [FRS-R-20ID](#) [CL03AB00M6](#) [CHSF-80](#) [BBS-1/10](#) [LDFJ350.X](#) [BAF-4](#) [KRP-C-1000SP](#) [TIA10](#) [MIC-20](#) [BBS-10](#) [BBS-4/10](#) [BBS-3/4](#)  
[BBS-1/2](#) [C10G32](#) [C10M20](#) [JJN-100](#) [JJN-15](#) [JJS-2](#) [KRP-C-700SP](#) [KTK-7](#) [KTK-R-1-1/2](#) [KTK-R-9](#) [3RU1136-1KB0](#) [LP-CC-12](#) [LP-CC-25](#)