

Electrical Sector Solutions

Volume 8: Sensing Solutions

EATON

Powering Business Worldwide

Tab 1—Safety Products	V8-T1-1
Tab 2—Limit Switches	V8-T2-1
Tab 3—Inductive Proximity Sensors	V8-T3-1
Tab 4—Capacitive Proximity Sensors	V8-T4-1
Tab 5—Photoelectric Sensors	V8-T5-1
Tab 6—Conveyor Sensor Systems	V8-T6-1
Tab 7—Current and Voltage Sensors	V8-T7-1
Tab 8—Sensor Accessories	V8-T8-1
Tab 9—Fiber Optic Cables	V8-T9-1
Tab 10—Sensor Connectivity	V8-T10-1
Tab 11—Legacy Sensor Products	V8-T11-1
Tab 12—Sensor Learning Course	V8-T12-1
Tab 13—Sensor Applications	V8-T13-1
Appendix 1—Eaton Terms & Conditions	V8-A1-1
Appendix 2—Enclosure Ratings/Glossary of Terms	V8-A2-1
Appendix 3—Catalog Number Index	V8-A3-1



Dimensions, Weights and Ratings

Dimensions, weights and ratings given in this catalog **are approximate and should not be used for construction purposes**. Drawings containing exact dimensions are available upon request. All listed product specifications and ratings are subject to change without notice. Photographs are representative of production units.

Terms and Conditions

All prices and discounts are subject to change without notice. When price changes occur, they are published in Eaton's *Price and Availability Digest* (PAD). All orders accepted by Eaton's Electrical Sector are subject to the general terms and conditions as set forth in Appendix 1—Eaton Terms & Conditions.

Technical and Descriptive Publications

This catalog contains brief technical data for proper selection of products. Further information is available in the form of technical information publications and illustrated brochures. If additional product information is required, contact your local Eaton Products Distributor, call **1-800-525-2000** or visit our website at **www.eaton.com**.

Compliance with Nuclear Regulation 10 CFR 21

Eaton products are sold as commercial grade products not intended for application in facilities or activities licensed by the United States Nuclear Regulatory Commission for atomic purposes, under 10 CFR 21. Further certification will be required for use of these products in a safety-related application in any nuclear facility licensed by the U.S. Nuclear Regulatory Commission.

WARNING

The installation and use of Eaton products should be in accordance with the provisions of the U.S. National Electrical Code® and/or other local codes or industry standards that are pertinent to the particular end use. Installation or use not in accordance with these codes and standards could be hazardous to personnel and/or equipment.

These catalog pages do not purport to cover all details or variations in equipment, nor to provide for every possible contingency to be met in connection with installation, operation or maintenance. Should further information be desired or should particular problems arise which are not covered sufficiently for the purchaser's purposes, the matter should be referred to the local Eaton Products Distributor or Sales Office. The contents of this catalog shall not become part of or modify any prior or existing agreement, commitment or relationship. The sales contract contains the entire obligation of Eaton's Electrical Sector. The warranty contained in the contract between the parties is the sole warranty of Eaton. Any statements contained herein do not create new warranties or modify the existing warranty.



DANGER

THE SENSORS IN THIS CATALOG, UNLESS OTHERWISE NOTED, ARE NOT SAFETY DEVICES AND ARE NOT INTENDED TO BE USED AS SAFETY DEVICES. These sensors are designed only to detect or read certain data in an electronic manner and perform no use apart from that, specifically no safety-related use. These sensors do not include self-checking redundant circuitry, and the failure of these sensors could cause either an energized or de-energized output condition, which could result in death, serious bodily injury, or property damage.



Powering Business Worldwide

Eaton is a global leader in power distribution, power quality, control and automation, and monitoring products.

At Eaton, we believe a reliable, efficient and safe power system is the foundation of every successful enterprise. Through innovative technologies, cutting-edge products and our highly skilled services team, we empower businesses around the world to achieve a powerful advantage.

In addition, Eaton is committed to creating and maintaining powerful customer relationships built on a foundation of excellence. From the products we manufacture to our dedicated customer service and support, we know what's important to you.

Solutions

Eaton takes the complexity out of power systems management with a holistic and strategic approach, leveraging our industry-leading technology, solutions and services. We focus on the following three areas in all we do:

- **Reliability**—maintain the appropriate level of power continuity without disruption or unexpected downtime
- **Efficiency**—minimize energy usage, operating costs, equipment footprint and environmental impact
- **Safety**—identify and mitigate electrical hazards to protect what you value most

Using the Eaton Catalog Library

As we grow, it becomes increasingly difficult to include all products in one or two comprehensive catalogs. Knowing that each user has their specific needs, we have created a library of catalogs for our products that when complete, will contain 15 volumes. Since the volumes will continuously be a work in progress and updated, each volume will stand alone. Refer to our volume directory, MZ08100001E, for a quick glance of where to look for the products you need. The 15 volumes include:

- Volume 1—Residential and Light Commercial (CA08100002E)
- Volume 2—Commercial Distribution (CA08100003E)
- Volume 3—Power Distribution and Control Assemblies (CA08100004E)
- Volume 4—Circuit Protection (CA08100005E)
- Volume 5—Motor Control and Protection (CA08100006E)
- Volume 6—Solid-State Motor Control (CA08100007E)
- Volume 7—Logic Control, Operator Interface and Connectivity Solutions (CA08100008E)
- Volume 8—Sensing Solutions (CA08100010E)
- Volume 9—Original Equipment Manufacturer (CA08100011E)
- Volume 10—Enclosed Control (CA08100012E)
- Volume 11—Vehicle and Commercial Controls (CA08100013E)
- Volume 12—Aftermarket, Renewal Parts and Life Extension Solutions (CA08100014E)
- Volume 13—Counters, Timers and Tachometers (CA08100015E)—Available in electronic format only
- Volume 14—Fuses (CA08100016E)—Available in electronic format only
- Volume 15—Solar Inverters and Electrical Balance of System (CA08100018E)

These volumes are not all-inclusive of every product, but they are meant to be an overview of our product lines. For our full range of product solutions and additional product information, consult Eaton.com/electrical and other catalogs and product guides in our literature library.

These references include:

- The Consulting Application Guide (CA08104001E)
- The Eaton Power Quality Product Guide (COR01FYA)

If you don't have the volume that contains the product or information that you are looking for, not to worry. You can access every volume of the catalog library at Eaton.com/electrical in the Literature Library.

By installing our Automatic Tab Updater (ATU), you can be sure you always have the most recent version of each volume and tab.

Icons



Green Leaf

Eaton Green Solutions are products, systems or solutions that represent Eaton benchmarks for environmental performance. The green leaf symbol is our promise that the solution has been reviewed and documented as offering exceptional, industry-leading environmental benefits to customers, consumers and our communities. Though all of Eaton's products and solutions are designed to meet or exceed applicable government standards related to protecting the environment, our products with the Green Leaf designation further provide "exceptional environmental benefit".



Learn Online

When you see the Learn Online icon, go to Eaton.com/electrical and search for the product or training page. There you will find 100-level training courses, podcasts, webcasts or games and puzzles to learn more.



Drawings Online

When you see the Drawings Online icon, go to Eaton.com/electrical and find the products page. There you will find a tab that includes helpful product drawings and illustrations.

Contact Us

If you need additional help, you can find contact information under the Customer Care heading of Eaton.com/electrical.

Door-Flap Switch



Door-Hinge Switch



Key Interlock Switch



RS2 Safety Interlock Switch



1.0 Introduction

Technical Reference	V8-T1-2
Product Overview	V8-T1-3

1.1 LS-Titan Safety Interlock Switches

Product Description	V8-T1-4
Features	V8-T1-4
Standards and Certifications	V8-T1-4
Product Identification	V8-T1-5
Product Selection	V8-T1-6
Technical Data and Specifications	V8-T1-9
Mounting Instructions	V8-T1-10
Dimensions	V8-T1-11

1.2 RS Safety Interlock Switches

Product Description	V8-T1-15
Operation	V8-T1-15
Features	V8-T1-15
Standards and Certifications	V8-T1-15
Catalog Number Selection	V8-T1-16
Product Selection	V8-T1-16
Recommended Logic Interfaces	V8-T1-18
Accessories	V8-T1-18
Technical Data and Specifications	V8-T1-19
Mounting Instructions	V8-T1-20
Dimensions	V8-T1-21



For Customer Service in the U.S. call 1-877-ETN CARE (386-2273),
 in Canada call 1-800-268-3578.
 For Application Assistance in the U.S. and Canada
 call 1-800-426-9184.

Technical Reference

LS-Titan



To protect personnel and equipment, often the need arises for a device to provide a signal indicating that a door or a panel has been closed before a machine can be turned on or operations can be restarted.

While a standard limit switch or sensor may be able to do this function, the possibility exists that the unit could be false tripped or false actuated either accidentally or deliberately, thereby posing a danger to the machine operator.

In response to this problem, many switch manufacturers offer safety-rated interlock switches.

Designed with two parts—the sensor and the actuator, the sensor is typically mounted on the stationary portion of a structure and the actuator is mounted on the movable portion. The sensor is designed to work with the correct actuator (keyed or coded magnet) to reduce tampering and increase safety.

Interlock Switch

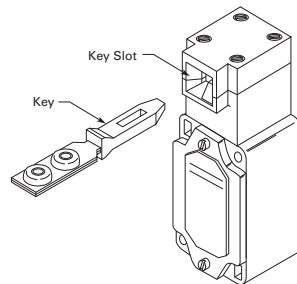

Actuation of the interlock switch occurs only when the corresponding key is inserted into the key slot. The key is usually mounted on a door or machine guard in such a way that when the door or the guard is closed, the key fits into the slot actuating the switch. The special key design makes the safety interlock switch extremely difficult to defeat. When inserted into the slot, the key performs three separate mechanical functions.

In addition to being difficult to override, the safety interlock is also designed to fail to a safe mode. If, by chance, the contacts were to become welded together, removal of the key will physically tear the contacts apart, resulting in a safe condition.

LS-Titan™ key interlock switches by Eaton's Electrical Sector are available in both NEMA® and DIN style housings. NEMA style key interlock switches feature durable metal housings, which remove power to the machine when the guard is opened.

DIN style key interlock switches feature a reduced size and economical plastic housings. They remove power to the machine when the guard is opened.

Non-Contact Interlock Switch

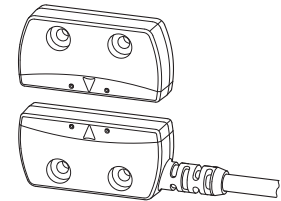

Activation of the non-contact interlock switch occurs only when the corresponding magnetic actuator is within operating range. The actuator is usually mounted on a door or machine guard in such a way that when the door or the guard is closed, the actuator is within operating range and actuates the sensor. The design of the sensor/actuator combination reduces the likelihood of defeating the sensor with a simple magnet.

Product Overview

LS-Titan Safety Products



LS-Titan Miniature DIN Safety Interlock Switches



LS-Titan Full-Size DIN Safety Interlock Switches



LS-Titan Solenoid Safety Interlock Switches

Product Selection	Page V8-T1-6	Page V8-T1-7	Page V8-T1-8
Technical Data and Specifications	Page V8-T1-9	Page V8-T1-9	Page V8-T1-9
Mounting Instructions	Page V8-T1-10	Page V8-T1-10	Page V8-T1-10
Dimensions	Page V8-T1-11	Page V8-T1-11	Page V8-T1-11

RS Safety Interlock Switches



RS2 Interlock Switches



RS2R Interlock Switches



RS4 Interlock Switches

Product Selection	Page V8-T1-16	Page V8-T1-16	Page V8-T1-16
Technical Data and Specifications	Page V8-T1-19	Page V8-T1-19	Page V8-T1-19
Mounting Instructions	Page V8-T1-20	Page V8-T1-20	Page V8-T1-20
Dimensions	Page V8-T1-21	Page V8-T1-21	Page V8-T1-21

LS-Titan Safety Interlock Switches



LS-Titan Safety Interlock Switches

Product Description

Eaton's LS-Titan safety interlock switches have been specifically designed for monitoring the position of protective guards, such as doors, flaps, hoods and grilles. All switches in this family are safety-rated, include positively opening NC contacts, and cannot be defeated using simple tools, such as pliers, screwdrivers and nails.

The LS-Titan safety interlock family is comprised of three types of safety switches: key interlock, door-flap and door-hinge switches.

Key interlock switches are a two-piece design, made up of the switch and key (actuator). The key portion of the switch is affixed to a movable door, cover or other such guard. The switch itself is mounted to a rigid portion of the machine. When the guard is opened, the key is removed from the switch, thereby positively breaking the NC contacts. This interrupts the control circuit, stopping machine operation.

The door-flap and door-hinge switches are one-piece designs, suitable for when a key cannot be mounted in the application. When an attempt is made to open a protected door hinge or flap during operation, these switches disconnect the power supply to the machine or installation. Both switches feature four-way adjustable heads.

All LS-Titan safety interlock switches are approved to protect personnel and processes.

Contents

<i>Description</i>	<i>Page</i>
LS-Titan Safety Interlock Switches	
Product Identification	V8-T1-5
Product Selection	
LS-Titan Miniature DIN Safety Interlock Switches	V8-T1-6
LS-Titan Full-Size DIN Safety Interlock Switches	V8-T1-7
LS-Titan Solenoid Safety Interlock Switches	V8-T1-7
LS-Titan Solenoid Safety Interlock Keys	V8-T1-8
Technical Data and Specifications	V8-T1-9
Mounting Instructions	V8-T1-10
Dimensions	V8-T1-11

Features

- Broad family of safety interlock switches in industry-standard enclosure sizes: miniature DIN; full-size DIN; and larger, solenoid key interlocks providing the highest degree of personnel and process protection
- Large selection of actuators (keys), including those for sliding doors, swing doors and doors that do not close precisely
- Miniature DIN models have a five-way adjustable head, while full-size DIN models have four-way adjustable heads
- Fully safety-rated as interlocking devices per EN 1088, with safety function by positive opening contacts per IEC/EN 60947-5-1
- Door-flap and door-hinge safety switches provide a unique solution when actuators (keys) cannot be used
- IP65 degree of protection

Standards and Certifications

- UL® listed
- CSA® approved
- CCC



- Positive opening NC contacts per EN 60947-5-1 ↻



Safety Notes

Do not use as a mechanical stop/shipping brace.

Any change to an original Eaton safety position switch is not permitted and automatically leads to the loss of all approvals.

⚠ Switch must never be used as a mechanical stop.

For the most current information on this product, visit our Web site: www.eaton.com

For Customer Service in the U.S. call 1-877-ETN CARE (386-2273), in Canada call 1-800-268-3578. For Application Assistance in the U.S. and Canada call 1-800-426-9184.

Product Identification

Solenoid Safety Interlock Switches (LS-...ZBZ)

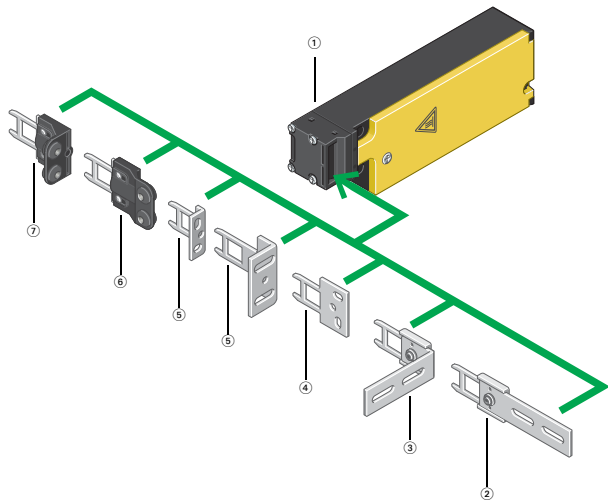

Notes

- ① **Basic device** (see Page V8-T1-7)
Spring or magnet-powered interlock
For increased personnel and process protection
Tamper-proof
Multiple coded actuators
Contacts: 1NO-1NC or 2NC
- ② **Flat flexible actuator** (see Page V8-T1-8)
For doors that do not close precisely
- ③ **Angled flexible actuator** (see Page V8-T1-8)
For doors that do not close precisely
- ④ **Flat actuator** (see Page V8-T1-8)
For sliding doors
- ⑤ **Angled actuator** (see Page V8-T1-8)
For swing doors
- ⑥ **Flat compensating actuator** (see Page V8-T1-8)
For increased tolerance compensation in the direction of door closure
- ⑦ **Angled compensating actuator** (see Page V8-T1-8)
For increased tolerance compensation in the direction of door closure

Miniature DIN Safety Interlock Switch (LS-...ZB)

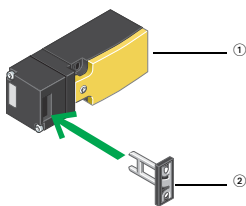

Notes

- ① **Complete device** (see Page V8-T1-6)
For personnel protection
Contacts: 1NC, 1NO-1NO or 2NC
Five directions of operation possible
- ② **Actuator** (see Page V8-T1-6)
Included with switch
Multiple coding protection against tampering

Door Flap Safety Switch (LSR-...TKG)

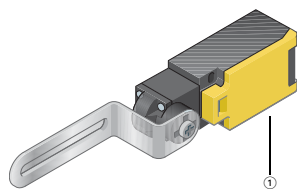

Note

- ① **Complete device** (see Page V8-T1-6)
For personnel protection
Contacts: 1NO-1NC or 2NC
For swing doors with fixed connection to the door/hinge pin

Door Hinge Safety Switch (LSR-...TS)

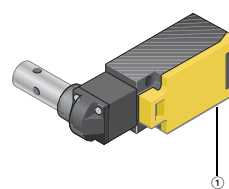

Note

- ① **Complete device** (see Page V8-T1-6)
For personnel protection
Contacts: 1NO-1NC or 2NC
For swing doors with fixed connection to the door/hinge pin

Full-Size DIN Safety Interlock Switch (LS4-...ZB)

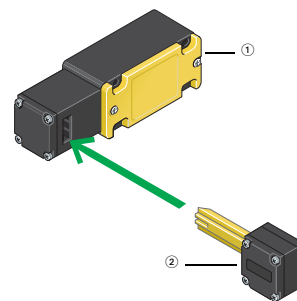

Notes

- ① **Complete device** (see Page V8-T1-7)
Narrow enclosure version
For personnel protection
Contacts: 1NO, 1NO-1NC
- ② **Actuator**
Included with switch, not orderable as a separate item
Multiple coding
For horizontal or vertical operation

Product Selection

LS-Titan Miniature DIN Safety Interlock Switches

Key Interlock Switch

Key Interlock Switch—LS...ZB ^①



Contacts	Contact Sequence	Contact Travel	Connection	Catalog Number (Includes Key)
2NC with positive opening		—	Screw terminal	LS-S02-ZB
1NO and 1NC with positive opening		—	Screw terminal	LS-S11-ZB
		Snap action contacts	Screw terminal	LS-S11S-ZB

Door-Flap Switch

Door-Flap Switch—LSR...TKG ^①



Contacts	Contact Sequence	Contact Travel	Connection	Catalog Number (Includes Key)
2NC with positive opening			Screw terminal	LSR-S02-1-I-TKG
1NO and 1NC with positive opening			Screw terminal	LSR-S11-1-I-TKG

Door-Hinge Switch

Door-Hinge Switch—LSR...TS ^①



Contacts	Contact Sequence	Contact Travel	Connection	Catalog Number (Includes Key)
2NC with positive opening			Screw terminal	LSR-S02-1-I-TS
1NO and 1NC with positive opening			Screw terminal	LSR-S11-1-I-TS

Replacement Safety Interlock Key



Replacement Safety Interlock Key ^①

Description	Catalog Number
Replacement key for miniature DIN key interlock switches (only models LS...ZB).	LS-XB-ZB

Note

^① For dimensions, see [Page V8-T1-11](#).

LS-Titan Full-Size DIN Safety Interlock Switches

Key Interlock Switch Full-Size DIN—LS4-...ZB ^{①②}



Contacts	Contact Sequence	Contact Travel	Connection	Catalog Number (Includes Key)
1NO and 1NC with positive opening		—	Screw terminal	LS4-S11-1-I-ZB

LS-Titan Solenoid Safety Interlock Switches





Switch Body without Key—LS-...ZBX ^{①②③}



Operation	Operating Voltage	Contacts	Contact Sequence	Catalog Number (Key not Included)
Power to unlock (mechanical bypass present)	24 Vdc	1NO and 1NC with positive opening		LS-S11-24DFT-ZBX-X
		2NC with positive opening		LS-S02-24DFT-ZBX-X
	120 Vac (50/60 Hz)	1NO and 1NC with positive opening		LS-S11-120AFT-ZBX-X
		2NC with positive opening		LS-S02-120AFT-ZBX-X
Power to lock	24 Vdc	1NO and 1NC with positive opening		LS-S11-24DMT-ZBX-X
		2NC with positive opening		LS-S02-24DMT-ZBX-X
	120 Vac (50/60 Hz)	1NO and 1NC with positive opening		LS-S11-120AMT-ZBX-X
		2NC with positive opening		LS-S02-120AMT-ZBX-X

- Notes**
- ① For dimensions, see **Page V8-T1-11**.
 - ② For mounting instructions, see **Page V8-T1-10**.
 - ③ Key ordered separately, see **Page V8-T1-8**.

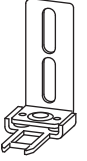
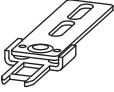
LS-Titan Solenoid Safety Interlock Keys**Keys Only—LS...ZBZ** ^{①②}

	Description	Application	Catalog Number
LS-XG-ZBZ 	Flat actuator	For sliding doors	LS-XG-ZBZ
LS-X...ZBZ 	Angled actuator, short	For swing doors starting at 250 mm in width	LS-XW-ZBZ
	Angled actuator, long	For swing doors starting at 250 mm in width	LS-XWA-ZBZ
LS-XF-ZBZ 	Angled, flexible actuator	For doors that do not close precisely	LS-XF-ZBZ
LS-XFG-ZBZ 	Even, flexible coasting actuator	For doors that do not close precisely	LS-XFG-ZBZ
LS-XNG-ZBZ 	Flat, compensating actuator	Increased tolerance in closing direction for inaccurately closing doors	LS-XNG-ZBZ
LS-XNW-ZBZ 	Angled, compensating actuator	Increased tolerance in closing direction for inaccurately closing doors	LS-XNW-ZBZ

Notes

- ① Switch body ordered separately, see **Page V8-T1-7**.
- ② For mounting instructions, see **Page V8-T1-10**.

Technical Data and Specifications

LS-Titan Safety Interlock Switches

	Units		LS-...ZBZ	LS-...ZB	LS4...ZB
General					
Standards			IEC/EN 60947	IEC/EN 60947	IEC/EN 60947
Climatic proofing			①	①	①
Ambient temperature	°C		-25...+0	-25...+70	-25...+70
Mounting position			As required	As required	As required
Protection type			IP65	IP65	IP65
Terminal capacities					
Solid	mm ²		1 x (0.75-2.5)/2 x (0.75-1.5)	1 x (0.75-2.5)/2 x (0.75-1.5)	1 x (0.75-2.5)/2 x (0.75-1.5)
Flexible with ferrule	mm ²		1 x (0.75-2.5)/2 x (0.75-1.5)	1 x (0.75-2.5)/2 x (0.75-1.5)	1 x (0.75-2.5)/2 x (0.75-1.5)
Contacts/Switching Capacity					
Rated impulse withstand voltage	U _{imp}	Vac	4000	6000	6000
Rated insulation voltage	U _i	V	400	500	500
Overvoltage category/pollution degree			III/3	III/3	III/3
Burden Current					
AC-15					
24V	I _e	A	6	10	10
230V/240V	I _e	A	6	6	6
400V/415V	I _e	A	4	4	4
DC-13					
24V	I _e	A	3	3	3
110V	I _e	A	0.8	0.8	0.8
220V	I _e	A	0.3	0.3	0.3
Supply frequency		Hz	max. 400	max. 400	max. 400
Short-circuit rating to IEC/EN 60947-5-1 Max. fuse		A gG/gL	6	6	6
Repetition accuracy		mm	± 0.02	± 0.02	± 0.02
Mechanical Variables					
Lifespan					
Standard-action contact	Operations	x 10 ⁶	1	10	10
Snap-action contact	Operations	x 10 ⁶	—	—	—
Mechanical shock resistance (half-sinusoidal shock, 20 ms)					
Standard-action contact		g	10	25	5
Snap-action contact		g	—	—	—
Operating frequency	Operations/h		≤ 800	≤ 1800	≤ 1800
Actuation					
Mechanical					
Actuating force at beginning/end of stroke					
ZB/ZBZ (push in/pull out)		N	25/15	10/5	15/20
Mechanical holding force according to GS-ET-19 (04/2004)					
XG, XW		N	1500	N/A	N/A
XFF, XNG, XWA		N	1300	N/A	N/A
XF		N	750	N/A	N/A
XNW		N	500	N/A	N/A
Electromechanical					
For magnet					
Power consumption					
at 120 Vac		VA	8	N/A	N/A
at 230 Vac		VA	11	N/A	N/A
at 24 Vdc		W	8	N/A	N/A
Pickup and dropout values		x U _s	0.85-1.1	N/A	N/A
Magnet duty factor		% ED	100	N/A	N/A

Note

① Damp heat, constant, to IEC 60068-2-78; damp heat, cyclical, to IEC 60068-2-30.

1

Mounting Instructions

LS-...ZB, TKG, TS

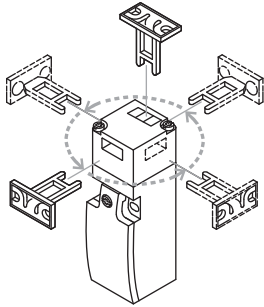

Actuator can be repositioned for horizontal or vertical installation. The operating heads can be rotated manually in 90° steps to suit the specified direction of operation.

LS4-...ZB

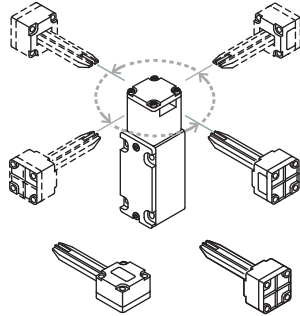

Actuator can be repositioned for horizontal or vertical installation. The operating heads can be rotated manually in 90° steps to suit the specified direction of operation.

LS-...ZBZ

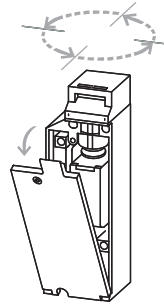

The operating head can be rotated manually in 90° steps to suit the specified level of actuation.

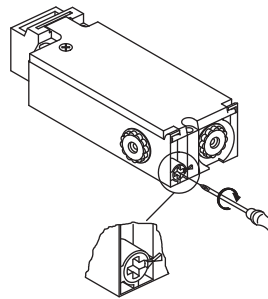

In the event of a loss of voltage, (for example, during commissioning), the spring-powered LS-...-...FT-ZBZ can be released with a screwdriver. **The auxiliary release mechanism must be sealed.**

Dimensions

Approximate Dimensions in Inches (mm)

Safety Position Switches

LS...-ZB

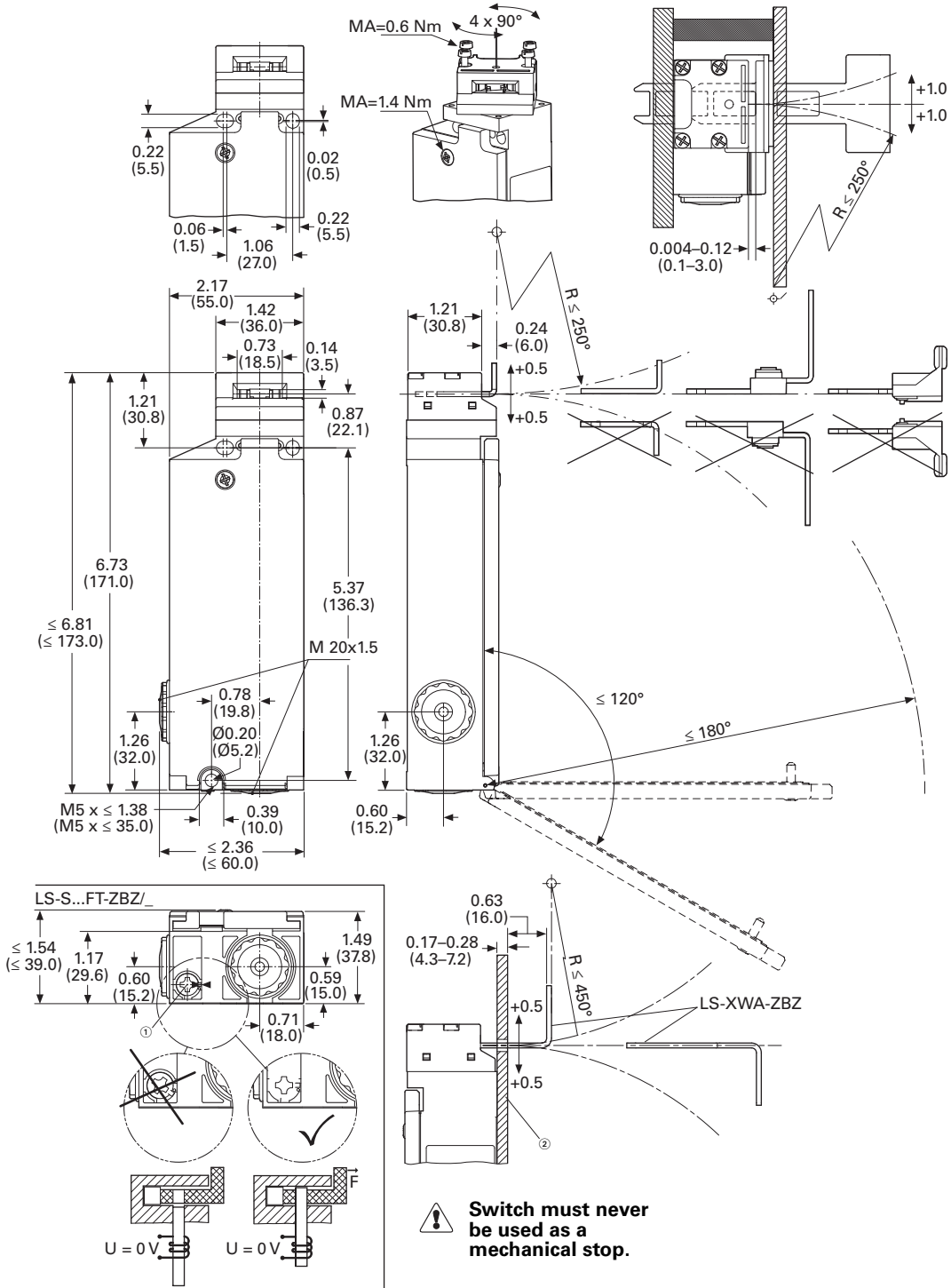

Notes

- ① The auxiliary release mechanism must be sealed for proper operation.
- ② Can be used as stop with the corresponding material selection and design.

Approximate Dimensions in Inches (mm)

Actuators

LS-XG-ZBZ

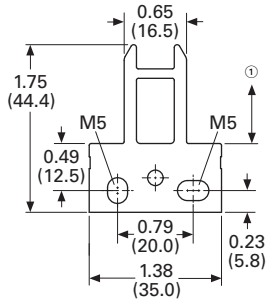

LS-XW-ZBZ

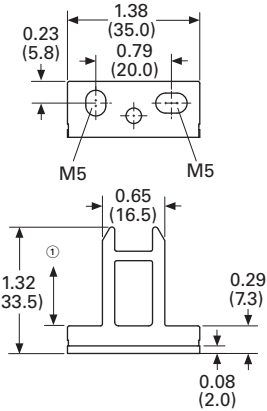

LS-XF-ZBZ

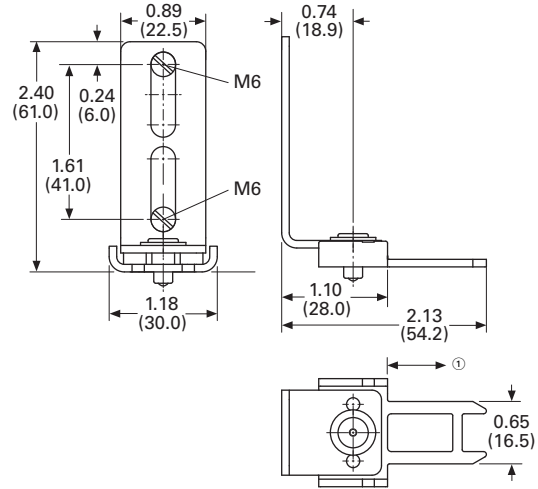

LS-XNW-ZBZ^②

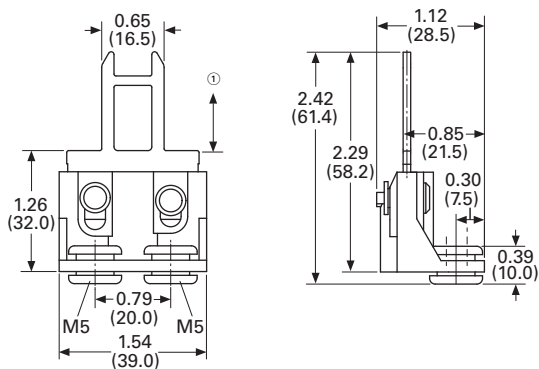

LS-XNG-ZBZ^②

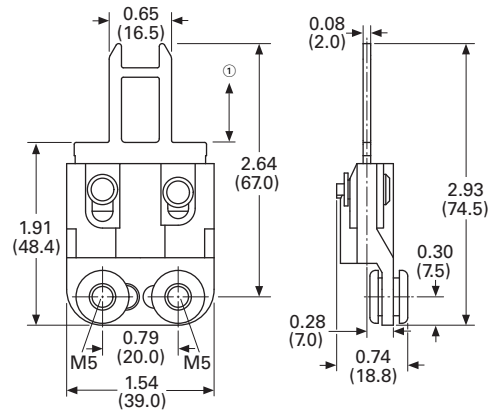

LS-XFG-ZBZ

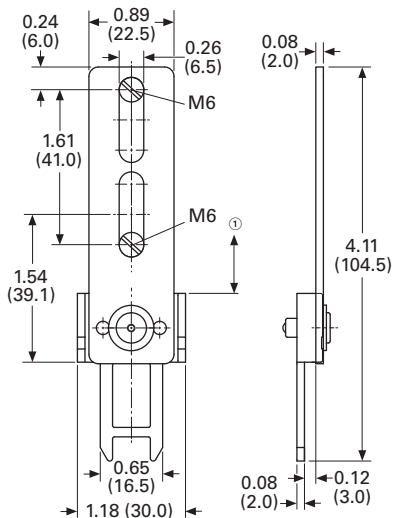

LS-XWA-ZBZ^③

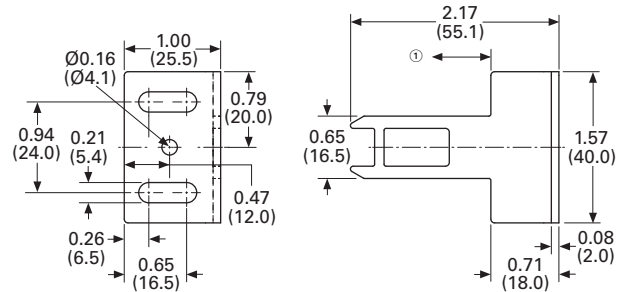

Notes

- ① Distance to device head = 0.1–3.0 mm.
- ② Fixing only allowed with M5 fixing screw and washer according to DIN EN ISO 7093.
- ③ Pin with a 4 mm pin after mounting.

Approximate Dimensions in Inches (mm)

Safety Door Flap Switch

LSR-.../TKG

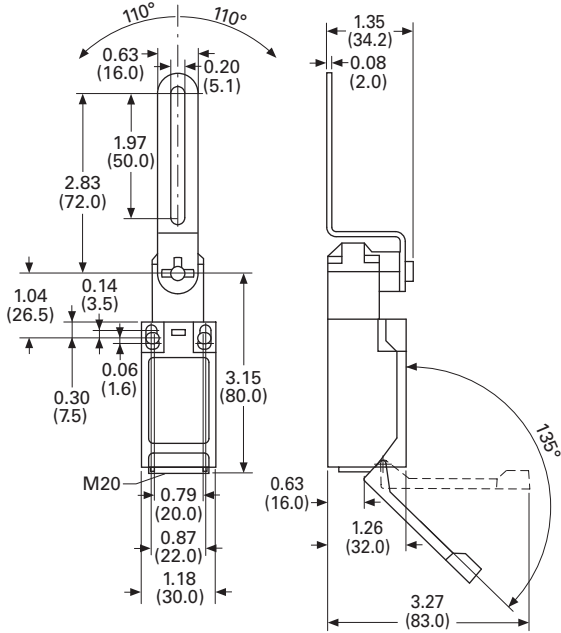

Safety Hinge Switch

LSR-.../TS

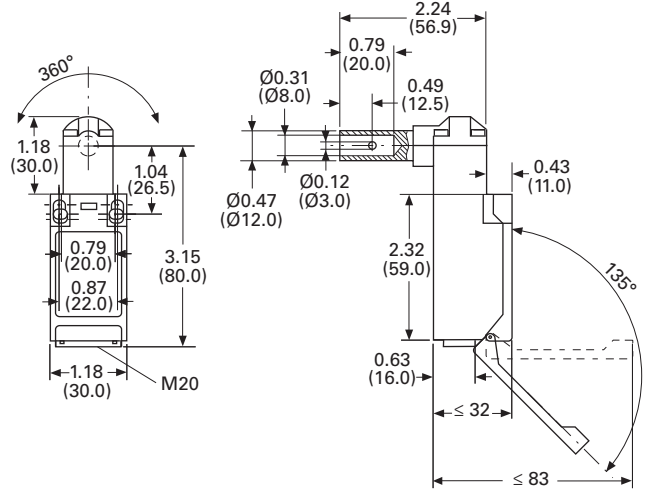

Safety Position Switches

LS-...-ZB

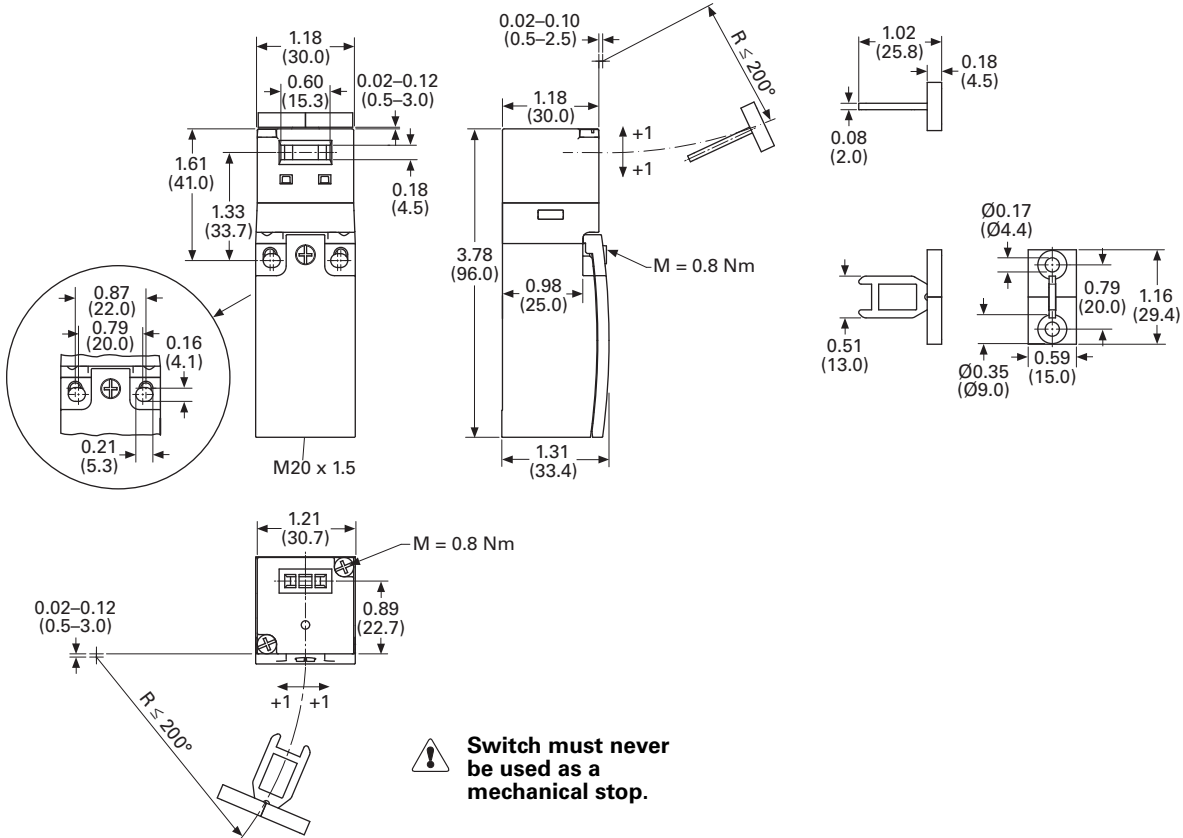

Approximate Dimensions in Inches (mm)

Safety Position Switches

LS4...ZB

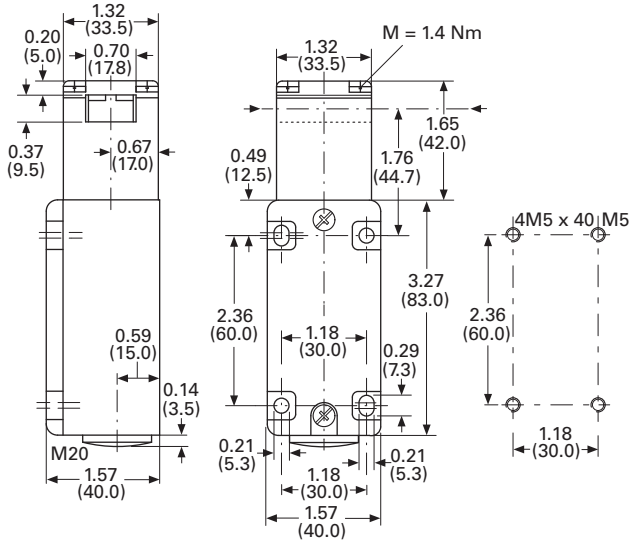

Actuator—Included with Switch Above

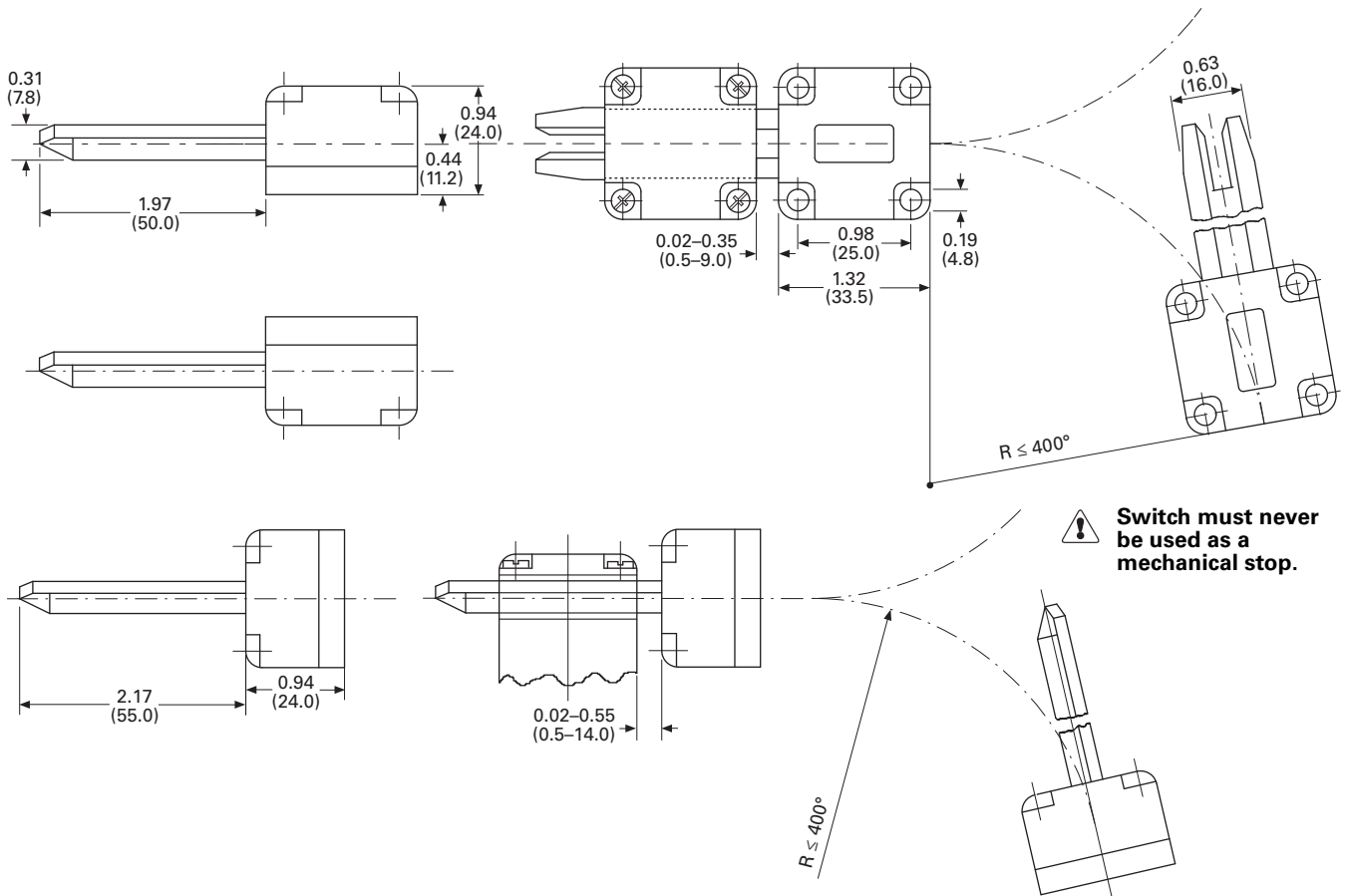

RS Safety Interlock Switches



Contents

Description

	<i>Page</i>
RS Safety Interlock Switches	
Catalog Number Selection	V8-T1-16
Product Selection	V8-T1-16
Recommended Logic Interfaces	V8-T1-18
Accessories	V8-T1-18
Technical Data and Specifications	V8-T1-19
Mounting Instructions	V8-T1-20
Dimensions	V8-T1-21

RS Safety Interlock Switches

Product Description

Eaton’s RS safety interlock switches have been specifically designed for monitoring of protective guards, such as doors, flaps and hoods. All switches in this family are safety-rated and use magnetically coded actuators to minimize defeat by simple magnets. With correct installation, the RS family complies with EN ISO 13849-1 and IEC 62061 guidelines.

Operation

The RS safety interlock family is comprised of three series: RS2, RS2R and RS4. The assembly comprises a sensor component and a separate magnet actuator component. The sensor is typically mounted to a stationary portion of a structure and the magnet to a movable portion. When the sensor and the actuator are within operating range, the NC contacts will be closed and the NO contacts will be open.

Features

- Non-contact actuation
- Reversible mounting
- High misalignment tolerance
- Up to SIL 3 and up to PLe ratings
- -10 to +55°C temperature range
- IP67

Standards and Certifications

- IEC 61508
- ISO 13849
- EN 1088
- cUL
- CE
- TÜV



Safety Notes

Do not use as a mechanical stop/shipping brace.

Any change to an original Eaton safety position switch is not permitted and automatically leads to the loss of all approvals.



Switch must never be used as a mechanical stop.

For the most current information on this product, visit our Web site: www.eaton.com

For Customer Service in the U.S. call 1-877-ETN CARE (386-2273), in Canada call 1-800-268-3578. For Application Assistance in the U.S. and Canada call 1-800-426-9184.

Catalog Number Selection

RS2 Safety Non-Contact Switch

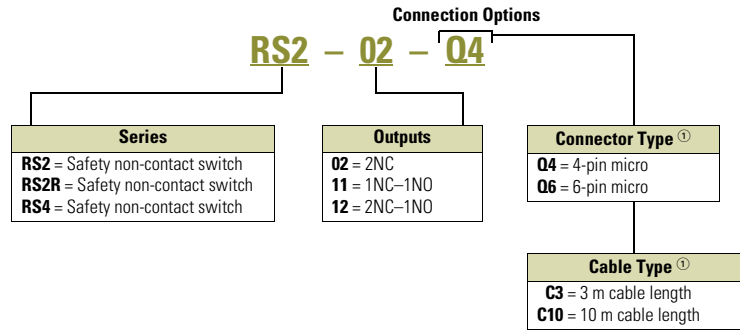



Note

① For cable, replace **Q4** or **Q6** connector with **C3** or **C10** cable in catalog number.

Product Selection

RS2 Safety Interlock Switches

RS2—Standard Models

	Outputs	Description	Catalog Number
RS2 DC Connector Style 	2NC	4-pin micro connector	RS2-02-Q4
	1NC–1NO	4-pin micro connector	RS2-11-Q4
	2NC–1NO	6-pin micro connector, dual key	RS2-12-Q6
RS2 DC Cable Style 	2NC	3 m cable length	RS2-02-C3
	1NC–1NO	3 m cable length	RS2-11-C3
	2NC–1NO	3 m cable length	RS2-12-C3
	2NC	10 m cable length	RS2-02-C10
	1NC–1NO	10 m cable length	RS2-11-C10
	2NC–1NO	10 m cable length	RS2-12-C10

RS2 SmartWire-DT™ Compatible Models

RS2—Standard Models, SmartWire-DT Compatible

	Outputs	Description	Catalog Number
RS2 SmartWire-DT Compatible 	2NC	150 mm SmartWire-DT connector	RS2-02-Q4-SWD
	1NC–1NO	150 mm SmartWire-DT connector	RS2-11-Q4-SWD

RS2R Safety Interlock Switches

RS2R Connector



RS2R—Standard Models

Outputs	Description	Catalog Number
2NC	150 mm 4-pin micro connector	RS2R-02-Q4
1NO-1NC	150 mm 4-pin micro connector	RS2R-11-Q4
1NO-2NC	150 mm 6-pin micro connector, dual key	RS2R-12-Q6
2NC	3 m cable length	RS2R-02-C3
1NO-1NC	3 m cable length	RS2R-11-C3
1NO-2NC	3 m cable length	RS2R-12-C3

RS2R SmartWire-DT Compatible Models

RS2R SmartWire-DT Compatible



RS2R—Standard Models, SmartWire-DT Compatible

Outputs	Description	Catalog Number
2NC	150 mm SmartWire-DT connector	RS2R-02-Q4-SWD
1NC-1NO	150 mm SmartWire-DT connector	RS2R-11-Q4-SWD

RS4 Safety Interlock Switches

RS4 Connector



RS4—Standard Models

Outputs	Description	Catalog Number
2NC	150 mm 4-pin micro connector	RS4-02-Q4
1NO-2NC	150 mm 6-pin micro connector, dual key	RS4-12-Q6

RS4 SmartWire-DT Compatible Models

RS4 SmartWire-DT Compatible



RS4—Standard Models, SmartWire-DT Compatible

Outputs	Description	Catalog Number
2NC	150 mm SmartWire-DT connector	RS4-02-Q4-SWD

Recommended Logic Interfaces

ESR5



- Use for the highest safety requirements in accordance with EN ISO 13849-1, IEC 62061 and EC 61508
- Suitable for the global market with UL, cUL certifications and TÜV Rhineland functional safety certifications
- Applicable for EN 60204 stop categories 0 or 1
- Plug-in screw terminals for fast and fault-free replacement
- Multi-voltage versions

ESR5 Safety Relays

Safety Inputs	Safety Outputs (NO)	Power Supply	Catalog Number
1	4	24 Vac/Vdc	ESR5-NO-41-24VAC-DC
2	2	24 Vac/Vdc	ESR5-NO-21-24VAC-DC
2	3	24 Vac/Vdc	ESR5-NO-31-24VAC-DC
2	3	240 Vac	ESR5-NO-31-230VAC
2	3	24–230 Vac/Vdc	ESR5-NO-31-AC-DC

easySafety



- All-in-one—safety and control functions combined in one device
- Simple configuration through prefabricated and tested safety components
- Direct state display and increased machine availability due to fast error diagnosis through integrated display
- Multistep password concept prevents unwanted manipulation

easySafety

Safety Inputs	Safety Outputs (NO)	Reset Type	Power Supply	Catalog Number
14	1 (6 A relay), 4 (transistor)		24 Vdc	ES4P-221-DMXD1
14	4 (6 A relay)		24 Vdc	ES4P-221-DRXD1

Cordset

4-Pin Connectors

Description	Catalog Number
2 m cable	CSDS4A4CY2202
5 m cable	CSDS4A4CY2205
10 m cable	CSDS4A4CY2210
20 m cable	CSDS4A4CY2220

6-Pin Connectors

Description	Catalog Number
3 m cable	CSAS6A6CY2203
5 m cable	CSAS6A6CY2205

Accessories

RS Safety Interlock Switches



Description	Catalog Number
RS2 spare actuator	RS2-A

Technical Data and Specifications

RS Safety Interlock Switches

Description	RS2/RS2R/RS4 Specification
Safety classification	Up to SIL 3, IEC 61508
Outputs	NO and NC circuit combinations
Sensing range	On: 8 mm / Off: 19 mm
Enclosure rating	IP67, IP69K
Output switching	300 mA at 24 Vdc
Operating voltage	24 Vdc
Temperature range	-10° to +55°C (14° to 131°F)
Shock	30 G, 11 ms, 1/2 sine wave
Vibration	1 mm, 0–2000 Hz
Radio frequency immunity	IEC 61000-4-3
Repeat accuracy	10%
Housing material	Polyamide
Actuator material	Polyamide
Color	Black/yellow
Connection types	Cable and micro connector (4-pin or 6-pin)
Wire size	22 AWG
Standards and certifications	CULUS UL 508 Type 1, CSA 22.2 no.14
B10d	15,000,000
Contact response time	3 ms
Maintenance schedule	≤6 months

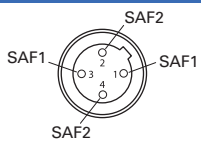
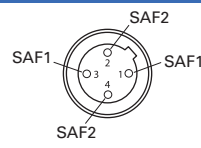
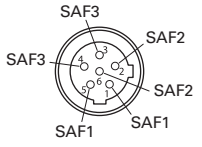
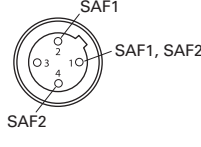
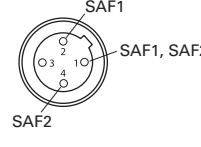
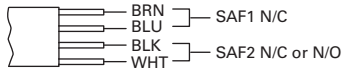
Wire Colors—RS2, RS2R and RS4 Models

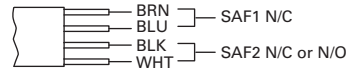
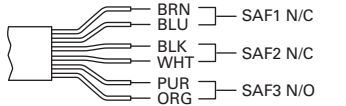
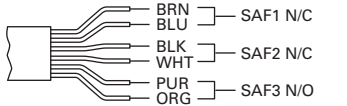
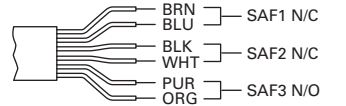
Description	2NC	2NC-1NO (SAF3 NO)	1NC-1NO (SAF2 NO)
4-pin micro		—	
6-pin micro (dual key)	—		—
SmartWire-DT		—	
Cordset (4-pin)			
Cordset (6-pin)			

1

Mounting Instructions

Reversible

The RS family has reversible mounting to adjust to field wiring needs.

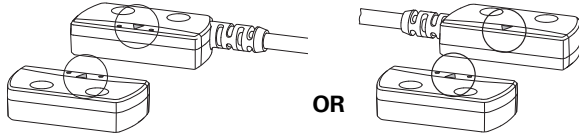

Alignment

Direction of approach is perpendicular to the plane of the sensing face.

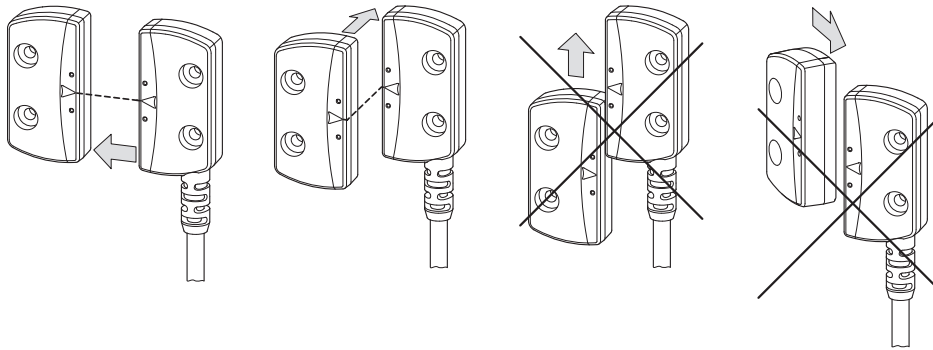

Dimensions

Approximate Dimensions in Inches (mm)

RS Safety Interlock Switches

RS2

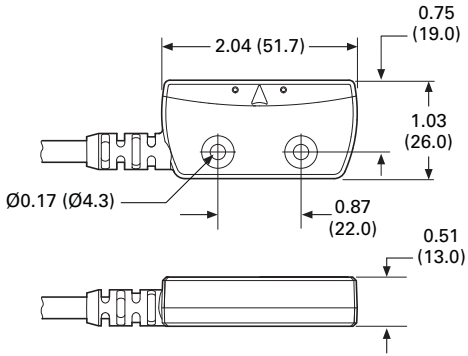

RS2R

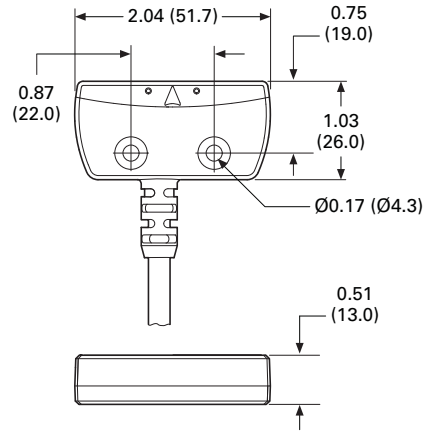

RS4

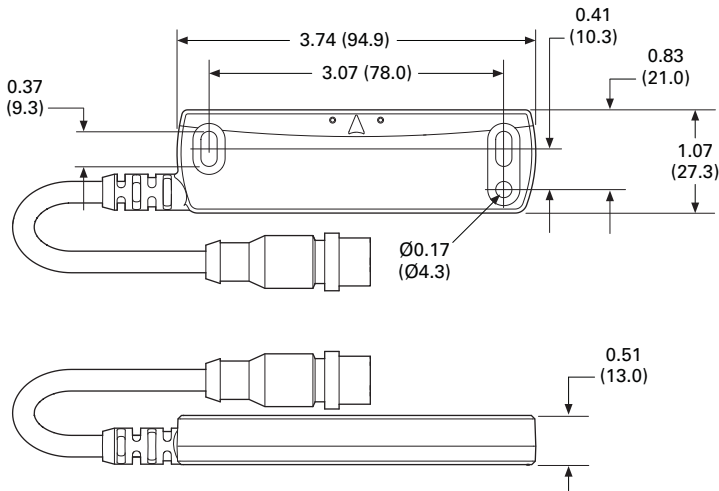

1.2

Safety Products

RS Safety Interlock Switches

1

Approximate Dimensions in Inches (mm)

RS Safety Interlock Actuators

RS2A

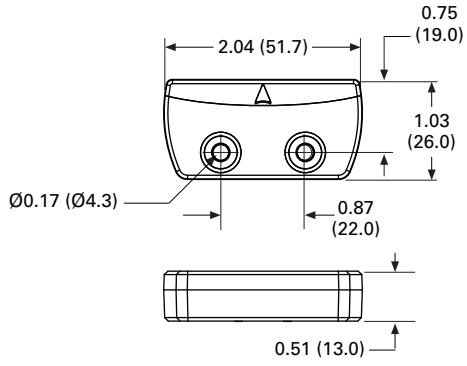

RS4A

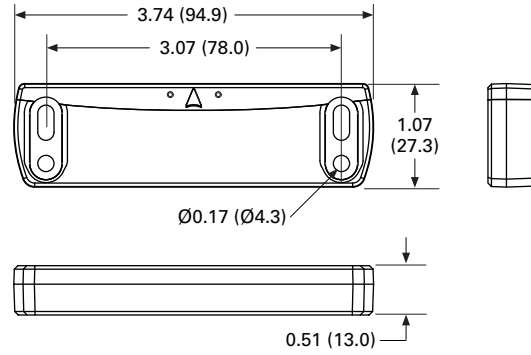

E47 Precision Switch



Compact Prewired Switch



LS-Titan Miniature DIN Switch



E49 Compact Metal Switch



Heavy-Duty Factory Sealed 6P+ Switch



2.0 Introduction	
Technical Reference	V8-T2-2
Product Selection Guide	V8-T2-3
2.1 E47 Precision Switches	
Product Description	V8-T2-6
Product Selection	V8-T2-7
2.2 Compact Prewired Switches	
Product Description	V8-T2-15
Product Selection	V8-T2-16
2.3 LS-Titan Miniature DIN Switches	
Product Description	V8-T2-21
Product Selection	V8-T2-23
2.4 E49 Mini Metal Switches	
Product Description	V8-T2-43
Product Selection	V8-T2-44
2.5 E49 Compact Metal Switches	
Product Description	V8-T2-49
Product Selection	V8-T2-50
2.6 E50 Heavy-Duty Plug-In Switches	
Product Description	V8-T2-54
Product Selection	V8-T2-55
2.7 E50 Heavy-Duty Factory Sealed 6P+ Switches	
Product Description	V8-T2-68
Product Selection	V8-T2-69
2.8 Operators	
Product Description	V8-T2-80
Product Selection	V8-T2-81
2.9 Non Plug-In Switches	
Product Description	V8-T2-89
Product Selection	V8-T2-90
2.10 Hazardous Location Limit Switches	
Product Description	V8-T2-92
Product Selection	V8-T2-93
2.11 Special Purpose Limit Switches	
Product Description	V8-T2-96
Product Selection	V8-T2-97



Unless otherwise noted, the products contained in this section should not be used for functional safety applications. These products were not designed or tested to IEC 60947-5-3 or recommended for functional safety.



For Customer Service in the U.S. call 1-877-ETN CARE (386-2273),
in Canada call 1-800-268-3578.
For Application Assistance in the U.S. and Canada
call 1-800-426-9184.

Technical Reference

Limit Switches

2



Mechanical Limit Switches are contact sensors widely used for detecting the presence or position of objects in industrial applications.

Limit Switches offer high precision in terms of accuracy and repeatability. This is primarily due to the fact that they make direct contact with the target. When an object contacts the limit switch lever (or plunger) the lever moves a pre-travel distance to the operating point where the contacts are tripped. Movement of the lever beyond this point is called the over-travel.

Limit switches contain the following major components. These may be modular or part of a single-piece switch.

Limit Switch Components

Lever Type Actuator

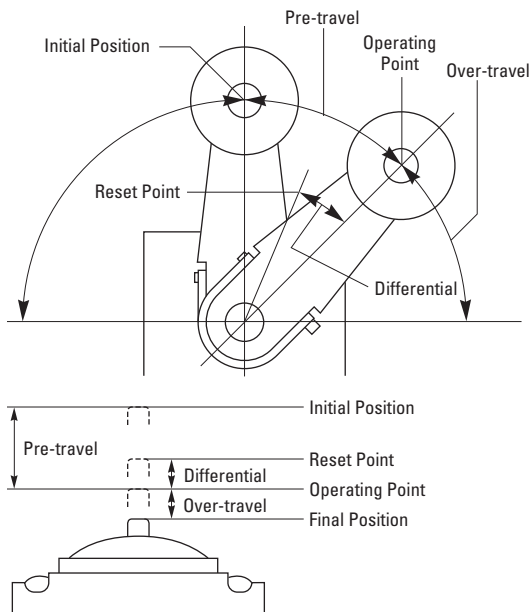

Refer to Sensor Learning Course, **Page V8-T12-4**, for a complete description of limit switch terminology.

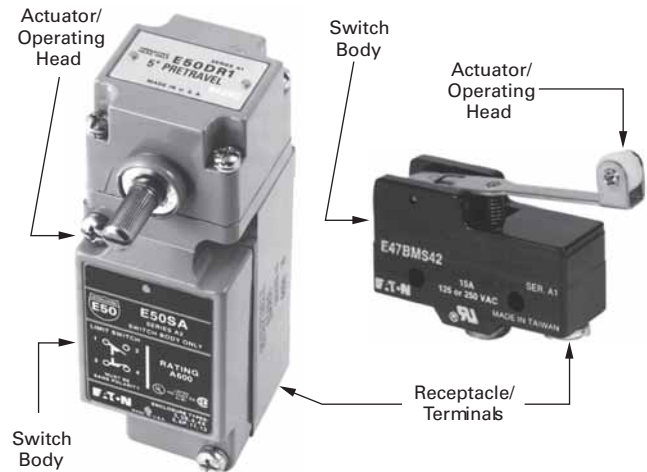

Actuator

This is the part of the switch that contacts the target. Typical actuators are levers and plungers. Several styles are available, see Sensor Learning Course, **Page V8-T12-4**, for more information.

Switch Body

This part contains the electrical contact mechanism. For complete information on electrical outputs, see Sensor Learning Course, **Page V8-T12-4**.

Terminals

The terminals are the point of connection for the wiring. These terminals may be on the body itself, or housed in a removable receptacle. The limit switch may also come equipped with a factory installed cable or pin-connector.

Product Selection Guide

E47 Precision Switches



Page V8-T2-6

Overview

Specified when accurate repeatability, choice of operating forces and travel characteristics and tightly controlled action of cam or target in space restricted areas are of prime importance. Cost effective and compact.

Applications

Overhead, folding and elevator doors, sliding gates, automated guided vehicles and commercial instrumentation

Product Features

Self-contained switches or with an enclosed cast housing for increased durability and conduit connection (1/2 in NPT)

High current capacity for power load switching and motor handling capability

Screw and solder terminations

Booted enclosed version shields actuators from debris

Mounting centers—1.0 in (25.4 mm), #8 screw size

Technical Data and Specifications

Mechanical life: 3,000,000 operations min.

Electrical life: 500,000 operations min.

Contact ratings—
NEMA A600, R300, AC-15, DC-13
15A/20A, 125 or 250 Vac

Enclosure ratings—
Enclosed: NEMA 1

Construction—
Basic: Phenolic
Enclosed: Aluminum die cast

Approvals

UL® Recognized
CSA® Certified
CE



Compact Prewired Switches



Page V8-T2-15

Overview

Designed to be a versatile, slim device for hard to fit applications where sealing integrity is required.

Applications

Machine tool, food processing and packaging

Product Features

Rugged aluminum alloy die cast housing
Sealed construction with enclosure ratings of NEMA 4, 6 and 13

Prewired with 3m of 18 AWG, AWM 2517, 300V cable

Stackable ridge for ganged operation

Technical Data and Specifications

Mechanical life: 10,000,000 operations min.

Electrical life: 200,000 operations
30 operations min.

Contact ratings—
NEMA B300

Enclosure ratings—
NEMA 4, 6 and 13; IP67, IP69K

Construction—
Aluminum alloy die cast

Approvals

cULus



LS-Titan Miniature DIN Switches



Page V8-T2-21

Overview

Safety position switches with insulated plastic or rugged metal enclosures. Approved for worldwide safety application.

Applications

Automatic vending machines, electronic assembly machines, elevators and lifts, injection molding, packaging and safety applications

Product Features

Modular plug-in head and body components
Positive opening NC contacts for safety applications

Operating heads can be rotated 90 degrees to suit specific direction of operation

Technical Data and Specifications

Mechanical life: 8,000,000 operations

Contact ratings—
AC-15, 6A at 24V, 6A at 230/240V,
4A at 400/415V;
DC-13, 3A at 24V, 800 mA at 110V,
300 mA at 220V

Enclosure ratings—
IP66, IP67 (by model)

Construction—
Plastic or metal (by model)

Approvals

Safety function, IEC/EN 60947-5-1
TÜV-Rheinland certified (LSE models)
CSA certified
UL listed
CE
CCC



E49 Mini Metal Switches



Page V8-T2-43

Overview

Suitable for OEMs who require a small, cost-effective solution but cannot sacrifice durability and mechanical life as they would if they chose a plastic IEC style switch.

Applications

Automatic vending machines, electronic assembly machines, elevators and lifts, injection molding, packaging

Product Features

Pre-wired units with custom cable lengths available for high volume customers
“Fingerproof” terminals protect against accidental shock

Double-spring mechanism for contact reliability

Grounding terminal included

Captive screws on enclosure cover make wiring hassle-free

SPDT double break

Technical Data and Specifications

Contact ratings—
5A at 250 Vac
5A at 30 Vdc

Enclosure ratings—
IP65

Construction—
Zinc alloy

Approvals

UL Recognized
CE



E49 Compact Metal Switches



Page V8-T2-49

Overview

Designed with high mechanical strength for robust environments. The rugged Aluminum die cast construction provides reliable, oil-tight, waterproof and dustproof sealing for a variety of applications. Snap action 1NO-1NC contacts provide flexibility in design.

Applications

Packaging, material handling conveyors, end-of-travel and guarding operations, baler/compactor, industrial door lifts

Product Features

- Rigid die cast switch housing
- Set position indicator plate for easy maintenance
- High mechanical strength
- Oiltight, waterproof and dustproof construction

Technical Data and Specifications

- Mechanical life: 15,000,000 operations min.
- Electrical life: 500,000 operations min. at full load
- Contact ratings—NEMA A600, R300; AC-15, DC-13
- Enclosure ratings—NEMA 4, 4X, 6, 6P, 12, 13; IP65, IP67
- Construction—Aluminum die cast

Approvals

- cULus
- IP67



E50 Heavy-Duty Plug-In Switches



Page V8-T2-54

Overview

Versatile in design. High reliability. Low maintenance costs with installation ease. BEST CHOICE for Heavy-Duty Limit Switch applications. Withstands physical and chemical abuse of harsh industrial environments.

Applications

Punch presses, waste water treatment, machine tool, automotive, retrieval systems, industrial truck, car wash lines

Product Features

- Modular operating heads, switch bodies and receptacles are interchangeable without field adjustment
- Order as complete assemblies or components for stocking and manufacturing flexibility
- 90 degree total travel, 5 degree pre-travel characteristics are standard features
- Viton® gasket, boot, and seal material offers exceptional chemical resistance
- Rotary head operating mode from CW, CCW or CW and CCW is easily changed without tools

Technical Data and Specifications

- Mechanical life: 13,000,000 operations min.
- Electrical life: 1,000,000 operations min. at full load (single-pole)
- Contact ratings—NEMA A600, R300
- Lighted versions A150, R150 6A, 120 Vac; 10A continuous
- Enclosure ratings—NEMA 1, 3, 3S, 4, 4X, 6, 6P, 13; IP67
- Construction—Zinc die cast

Approvals

- UL Listed
- CSA Certified
- IEC 947-5-1
- TUV
- CE (some models)



E50 Heavy-Duty Factory Sealed 6P+ Switches



Page V8-T2-68

Overview

Designed specifically to withstand the penetrating properties of new cutting fluids (coolants), acid or caustic washes, salt spray, severe vibration, shock and temperature fluctuations, grit and debris.

Applications

Automotive, pulp and paper, food processing, waste management, primary metals, machine tool (cutting, forming, bending)

Product Features

- Tamperproof, one-piece switch body assembly, epoxy filled
- Factory sealed. 6P submersible. Pre-wired with cable, pigtail or pin connector options. All with ground connection
- Utilizes E50 modular operating heads
- Special V-seal on switch body/head connection provides hermetic barrier against fluid ingress
- LED indicating light, 24V–120 Vac/dc neon version too
- Peel off see-through painting mask over nameplate

Technical Data and Specifications

- Mechanical life: 35,000,000 operations min.
- Electrical life: 1,000,000 operations min. at full load
- Contact ratings—NEMA A600, R300
- Lighted versions A150, R150 6A, 120 Vac; 10A continuous
- Enclosure ratings—NEMA 1, 2, 3, 3S, 4, 4X, 6, 6P, 13; IP67, IP69K
- Construction—Zinc die cast

Approvals

- UL Listed
- CSA Certified
- IEC 947-5-1
- TUV
- CE (some models)



Operators



Page V8-T2-80

Overview

Wide variety of operator types for rotary and wobble style limit switches.

Applications

Used with E50, E50 6P+ and 10316 limit switches

Product Features

Rollers and rods available in metal and nonmetal contact surfaces

Technical Data and Specifications

Varies by model

Approvals

Varies by model

Non Plug-In Switches



Page V8-T2-89

Overview

The Industrial standard for Non Plug-In Heavy-Duty Limit Switches. Sold as complete assembled units only.

Applications

Serving MRO and USER replacement requirements with broad d market coverage

Product Features

Side and top rotary, side and top push or wobble operation
 CW, CCW or CW and CCW operating modes are field convertible
 Double break-make snap action contacts, same polarity each pole
 Captive saddle clamp terminals accept up to #12 wire
 Head can be mounted in any of four discrete positions, intervals of 90 degrees

Technical Data and Specifications

Mechanical life: 10,000,000 operations min.
 Electrical life: 500,000 operations at full load
 Contact ratings—NEMA A600, R300
 6A, 120 Vac; 10A continuous
 Enclosure ratings—NEMA 1, 4, 13
 Construction—
 Zinc die cast

Approvals

UL Listed
 CSA Certified



Hazardous Location Switches



Page V8-T2-92

Overview

Designed for severe environmental service in locations where there exists a danger of an internal or external explosion of flammable gases, vapors, metal alloy or grain dust.

Applications

Mining, metal cutting, grain storage, forest products, petrochemical, waste and sewage management, pharmaceutical

Product Features

Sealed and unsealed versions available
 One-way gasket on sealed version keeps liquids out, yet allows a harmless release of gases in the event of an internal explosion
 Silicon bronze housing provides excellent corrosion resistant properties in extreme NEMA 4X applications
 Temperature build-up on limit switch surface is dissipated by housing design and materials used
 Utilizes the operating heads and internal switch mechanisms of the 10316 Non Plug-In line

Technical Data and Specifications

NEMA 7, Div. 1, Class I, BCD
 NEMA 9, Div. 1, Class II, EFG
 Contact ratings—NEMA B600
 3A, 120 Vac; 5A continuous
 Enclosure ratings—LX: NEMA 7, 9
 CX: NEMA 1, 4, 7, 9
 CB: NEMA 1, 4, 4X, 13
 CBX: NEMA 1, 4, 4X, 7, 9, 13
 Construction—LX, CX: Aluminum die cast
 CB, CBX: Silicon bronze

Approvals

cUL® Listed



Special Purpose Switches



Page V8-T2-96

Overview

Variety of special function limit switch products.

Applications

Serving MRO and USER replacement requirements with broad market coverage

Product Features

Special function switch lines include:
 Cabinet door interlocks — when plunger is pulled out, red band indicator visually shows that interlock is defeated
 Precision switches—1NO-1NC, 2NO-2NC, or operator only. Variety of mounting brackets available
 Pneumatic time delay—ON delay and OFF delay. Timing range—0.05 to 60 seconds
 Rotating cam shaft switches

Technical Data and Specifications

See **Page V8-T2-99** for more information
 Enclosure ratings—
 NEMA 1 or NEMA 4 versions
 Construction—
 Zinc die cast
 PS: Phenolic

Approvals

UL Listed
 CSA Certified (PS and J only)



E47 Precision Switches



E47 Precision Switches

Product Description

E47 Precision Switches from Eaton's electrical sector provide high accuracy switching at an affordable price. A variety of standard features, such as current capacity, operating force, travel characteristics and actuators, lets you custom fit the switch to your application.

The switches are available in their compact basic form, or enclosed in a rugged, metal housing.

Features

- Compact housings are ideal for use where space is restricted
- Precision, snap-action operators provide accurate repeatability of electrical and mechanical operating characteristics
- High current capacity (up to 20A) allows power load switching and motor handling capability
- Enclosed booted versions shield actuators from debris

Contents

Description

Description	Page
E47 Precision Switches	
Product Selection	
Basic Switches	V8-T2-7
Enclosed Switches	V8-T2-9
Accessories	V8-T2-10
Technical Data and Specifications	V8-T2-10
Dimensions	V8-T2-12



Operating Characteristics

Definitions

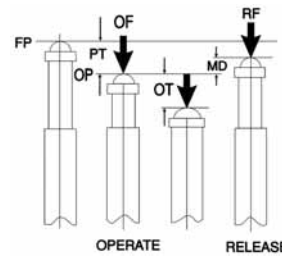

- OF—Operating Force
- RF—Return Force
- PT—Pre-Travel
- OT—Over-Travel
- MD—Movement Differential
- FP—Free Position
- OP—Operating Position

Standards and Certifications

- UL Recognized
- CSA Certified
- CE
- RoHS



⚠ DANGER

THIS SENSOR IS NOT A SAFETY DEVICE AND IS NOT INTENDED TO BE USED AS A SAFETY DEVICE. This sensor is designed only to detect and read certain data in an electronic manner and perform no use apart from that, specifically no safety-related use. This sensor product does not include self-checking redundant circuitry, and the failure of this sensor product could cause either an energized or de-energized output condition, which could result in death, serious bodily injury, or property damage.

For the most current information on this product, visit our Web site: www.eaton.com

For Customer Service in the U.S. call 1-877-ETN CARE (386-2273), in Canada call 1-800-268-3578. For Application Assistance in the U.S. and Canada call 1-800-426-9184.

Product Selection

Basic Switches

E47 Precision Switches—Basic

Type	Specifications ^①	15A Catalog Number	20A Catalog Number
Pin Plunger			
 Pin Plunger			
Screw terminal	OF max.—12.3 oz (350g) RF max.—4.02 oz (114g) PT max.—0.016 in (0.4 mm)	E47BMS01	E47CMS01
Solder terminal	OT max.—0.005 in (0.13 mm) MD max.—0.002 in (0.05 mm) OP—0.626 in (15.9 mm)	E47BML01	E47CML01 ^②
Extended Plunger			
 Extended Plunger			
Screw terminal	OF max.—12.3 oz (350g) RF max.—4.02 oz (114g) PT max.—0.016 in (0.4 mm)	E47BMS03	—
Solder terminal	OT max.—0.063 in (1.6 mm) MD max.—0.002 in (0.05 mm) OP—1.11 in (28.2 mm)	E47BML03	—
Straight Plunger			
 Straight Plunger			
Screw terminal	OF max.—12.3 oz (350g) RF max.—4.02 oz (114g) PT max.—0.016 in (0.4 mm)	E47BMS02	E47CMS02
Solder terminal	OT max.—0.063 in (1.6 mm) MD max.—0.002 in (0.05 mm) OP—0.846 in (21.5 mm)	E47BML02	E47CML02
Reversed Lever			
 Reversed Lever			
Screw terminal	OF max.—5.29 oz (150g) RF max.—0.49 oz (14g) PT max.—0.16 in (4 mm)	E47BMS21	—
Solder terminal	OT max.—0.063 in (1.6 mm) MD max.—0.051 in (1.3 mm) FP max.—0.81 in (20.6 mm)	E47BML21	—
Spade terminal	OP—0.685 in (17.4 mm)	E47BMT21	—
Straight Lever			
 Straight Lever			
Screw terminal	OF max.—2.47 oz (70g) RF min.—0.49 oz (14g) PT max.—0.394 in (10 mm) OT max.—0.220 in (5.6 mm)	E47BMS22	E47CMS22
Solder terminal	MD max.—0.051 in (1.3 mm) FP max.—1.11 in (28.2 mm) OP—0.748 in (19 mm)	E47BML22	—
Standard Lever			
 Standard Lever			
Screw terminal	OF max.—3.53 oz (100g) RF min.—0.99 oz (28g) PT max.—0.197 in (5.0 mm)	E47BMS20	—
Solder terminal	OT max.—0.079 in (2.0 mm) MD max.—0.039 in (1.0 mm) FP max.—0.976 in (24.8 mm) OP—0.748 in (19 mm)	E47BML20	—
Extended Straight Plunger			
 Extended Straight Plunger			
Screw terminal	OF max.—12.3 oz (350g) RF max.—4.02 oz (114g) PT max.—0.016 in (0.4 mm)	E47BMS04	E47CMS04
Screw terminal (with space lugs)	OT max.—0.217 in (5.5 mm) MD max.—0.002 in (0.05 mm) OP—0.858 in (21.8 mm)	E47BMT04	—
Solder terminal		E47BML04	E47CML04

Notes

^① OF = Operating Force; RF = Return Force; PT = Pre-Travel; OT = Over-Travel; MD = Movement Differential; FP = Free Position; OP = Operating Position.

^② Contact Eaton's Sensor Applications Department at 1-800-426-9184 for approval status.



E47 Precision Switches—Basic, continued

Type	Specifications ^①	15A Catalog Number	20A Catalog Number	
Roller Plunger				
	Screw terminal	OF max.—12.3 oz (350g) RF max.—4.02 oz (114g) PT max.—0.016 in (0.4 mm) OT max.—0.14 in (3.6 mm)	E47BMS10	E47CMS10
	Solder terminal	MD max.—0.002 in (0.05 mm) OP—1.315 in (33.4 mm)	E47BML10	—
Cross Roller Plunger				
	Screw terminal	OF max.—12.3 oz (350g) RF max.—4.02 oz (114g) PT max.—0.016 in (0.4 mm) OT max.—0.14 in (3.6 mm)	E47BMS11	E47CMS11
	Solder terminal	MD max.—0.002 in (0.05 mm) OP—1.315 in (33.4 mm)	E47BML11	—
Reversed Roller Lever				
	Screw terminal	OF max.—5.29 oz (150g) RF max.—0.49 oz (14g) PT max.—0.16 in (4 mm)	E47BMS41	—
	Solder terminal	OT max.—0.063 in (1.6 mm) MD max.—0.051 in (1.3 mm) FP max.—1.252 in (31.8 mm) OP—1.126 in (28.6 mm)	E47BML41	—
Extended Roller Lever				
	Screw terminal	OF max.—5.64 oz (160g) RF min.—0.78 oz (22g) PT max.—0.28 in (7.1 mm)	E47BMS42	E47CMS42
	Solder terminal	OT max.—0.16 in (4 mm) MD max.—0.04 in (1.02 mm) FP max.—1.437 in (36.5 mm) OP—1.189 in (30.2 mm)	E47BML42	—
Roller Lever				
	Screw terminal	OF max.—5.64 oz (160g) RF min.—1.48 oz (42g)	E47BMS30	E47CMS30
	Solder terminal	PT max.—0.106 in (2.7 mm) OT max.—0.094 in (2.4 mm) MD max.—0.02 in (0.5 mm)	E47BML30	—
	Spade terminal	FP max.—1.28 in (32.5 mm) OP—1.189 in (30.2 mm)	E47BMT30	E47CMT30
One-Way Roller				
	Screw terminal	OF max.—5.64 oz (160g) RF min.—1.48 oz (42g) PT max.—0.106 in (2.7 mm) OT max.—0.094 in (2.4 mm)	E47BMS31	—
	Solder terminal	MD max.—0.02 in (0.5 mm) FP—1.717 in (43.6 mm) OP—1.697 in (43.1 mm)	E47BML31	—
Integral Leaf				
	Screw terminal	OF max.—0.35 oz (10g) RF min.—0.106 oz (3.0g) PT max.—0.787 in (20.0 mm)	E47BMS23	E47CMS23
	Solder terminal	OT max.—0.22 in (5.6 mm) MD max.—0.118 in (3.0 mm) OP—0.748 in (19.0 mm)	E47BML23	—

Note







^① OF = Operating Force; RF = Return Force; PT = Pre-Travel; OT = Over-Travel; MD = Movement Differential; FP = Free Position; OP = Operating Position.

E47 Precision Switches—Basic, continued

Type	Specifications ^①	15A Catalog Number	20A Catalog Number
Adjustable Roller	Adjustable Roller		
	Screw terminal	OF max.—17.64 oz (500g) RF min.—6.0 oz (170g) PT max.—0.197 in (5.0 mm) OT max.—0.5 in (12.7 mm)	E47BMS40 —
	Solder terminal	MD max.—0.087 in (2.2 mm) FP max.—1.752 in (44.5 mm) OP—1.591 in (40.4 mm)	E47BML40 —
Extended Adjustable Roller	Extended Adjustable Roller		
	Screw terminal	OF max.—21.16 oz (600g) RF min.—10.58 oz (300g) PT max.—0.118 in (3.0 mm) OT max.—0.236 in (6.0 mm)	E47BMS43 —
	Solder terminal	MD max.—0.079 in (2.0 mm) FP max.—1.614 in (41 mm) OP—1.591 in (40.4 mm)	E47BML43 —

Enclosed Switches

E47 Precision Switches—Enclosed

Specifications ^①	Catalog Number	Specifications ^①	Catalog Number
Plunger Actuator	Plunger Actuator	Booted Roller Lever	Booted Roller Lever
	OF max.—8.82–12.3 oz (250–350g) RF min.—4.02 oz (114g) PT max.—0.016 in (0.4 mm) OT max.—0.217 in (5.5 mm) MD max.—0.002 in (0.05 mm) OP—1.504 in (38.2 mm)		OF max.—22.57 oz (640g) RF min.—8.11 oz (230g) PT max.—0.197 in (5.0 mm) OT max.—0.236 in (6.0 mm) MD max.—0.016 in (0.4 mm)
	E47BLS05		E47CLS05 ^{②③}
Booted Plunger	Booted Plunger	Roller Plunger	Roller Plunger
	OF max.—28.22 oz (800g) RF min.—8.46 oz (240g) PT max.—0.079 in (2.0 mm) OT max.—0.197 in (5.0 mm) MD max.—0.004 in (0.1 mm) OP—1.803 in (45.8 mm)		OF max.—8.82–12.3 oz (250–350g) RF min.—4.02 oz (114g) PT max.—0.02 in (0.5 mm) OT max.—0.142 in (3.6 mm) MD max.—0.002 in (0.05 mm) OP—1.957 in (49.7 mm)
	E47BLS06		E47CLS06 ^{②③}
Roller Lever	Roller Lever	Booted Roller Plunger	Booted Roller Plunger
	OF max.—20.1 oz (570g) RF min.—6.0 oz (170g) PT max.—0.157 in (4.0 mm) OT max.—0.236 in (6.0 mm) MD max.—0.016 in (0.4 mm)		OF max.—17.64 oz (500g) RF min.—3.53 oz (100g) PT max.—0.039 in (1.0 mm) OT max.—0.138 in (3.5 mm) MD max.—0.005 in (0.12 mm) OP—1.957 in (49.7 mm)
	E47BLS32		E47CLS32 ^{②③}
			E47BLS11 ^④
			E47BLS12 ^④

Notes

- ① OF = Operating Force; RF = Return Force; PT = Pre-Travel; OT = Over-Travel; MD = Movement Differential; FP = Free Position; OP = Operating Position.
- ② Contact Eaton's Sensor Applications Department at 1-800-426-9184 for approval status.
- ③ 20 ampere version.
- ④ Cross roller unit.

E47 Precision Switches—Enclosed, continued

	Specifications ①	Catalog Number
One-Way Roller		
	OF max.—20.1 oz (570g) RF min.—6.0 oz (170g) PT max.—0.157 in (4.0 mm) OT max.—0.236 in (6.0 mm) MD max.—0.016 in (0.4 mm)	E47BLS34

	Specifications ①	Catalog Number
Booted One-Way Roller		
	OF max.—22.57 oz (640g) RF min.—8.11 oz (230g) PT max.—0.197 in (5.0 mm) OT max.—0.236 in (6.0 mm) MD max.—0.016 in (0.4 mm)	E47BLS35

E47 Precision Switches—Enclosed, continued

	Specifications ①	Catalog Number
Booted Wobble		
	OF max.—2.11 oz (60g) RF min.—0.88 oz (25g) PT max.—0.520 in (13.2 mm) OT max.—0.315 in (8.0 mm) MD max.—0.039 in (1.0 mm)	E47BLS14

Accessories

Terminal Wire Covers for Basic Switches

	Description	Catalog Number
45°		
	Terminal wire cover with 45° conduit interface	E47PA1

	Description	Catalog Number
90°		
	Terminal wire cover with 90° conduit interface	E47PA2

Technical Data and Specifications

E47 Precision Switches

Description	Specification
Operating speed	0.01m/second to 1m/second
Operating Frequency	
Mechanical	120 operations/minute
Electrical	20 operations/minute
Mechanical life	3,000,000 operations minimum
Electrical life	500,000 operations minimum
Contact resistance	15M ohms maximum, initial
Insulation resistance	100M ohms minimum at 500 Vdc
Dielectric Strength	
Between non-current carrying parts	1000 Vac, 50/60 Hz for 1 minute
Between current carrying parts and ground	2000 Vac, 50/60 Hz for 1 minute

Notes

- ① OF = Operating Force; RF = Return Force; PT = Pre-Travel; OT = Over-Travel; MD = Movement Differential; FP = Free Position; OP = Operating Position.
- ② Cross roller unit.

E47 Precision Switches, continued

Description	Specification
Ambient Operating Temperature	
Basic	-13° to 176°F (-25° to 80°C)
Enclosed	5° to 176°F (-15° to 80°C)
Environmental rating enclosed, booted	NEMA 1
Mounting centers	1.0 in (25.4 mm), #8 screw size
Terminal screws	Bottom facing M4 x 0.7 (8-32) Screws with cup washers will accept 22-12 AWG (2.5 sq. mm maximum) Maximum torque: 10 in-lbs.
Threaded bushing	15/32 in
Material of construction	Mineral filled phenolic
Enclosure rating	Aluminum die casting (ADC-3/A380); Seal boot: nitrile, butyl rubber (NBR)
Conduit fitting on enclosed type	1/2 in NPT

Maximum Ampere Ratings ^{①②}

Model	Rated Voltage	Non-Inductive Load (A)			Inductive Load (A)			Inrush Current (A)	
		Resistive Load NC and NO	Lamp Load NC	NO	Inductive Load NC and NO	Motor Load NC	NO	NC	NO
15A	125 Vac	15	3	1.5	15	5	2.5	30 max.	15 max.
	250 Vac	15	2.5	1.25	15	3	1.5		
	500 Vac	3	1.5	0.75	2.5	1.5	0.75		
	8 Vdc	15	3	1.5	15	5	2.5		
	14 Vdc	15	3	1.5	10	5	2.5		
	30 Vdc	6 (2)	3	1.5	5	5	2.5		
	125 Vdc	0.4	0.4	0.4	0.05	0.05	0.05		
	250 Vdc	0.2	0.2	0.2	0.03	0.03	0.03		
20A	125 Vac	20	7.5	7.5	20	12.5	12.5	60 max.	30 max.
	250 Vac	20	7.5	7.5	20	8.3	8.3		
	500 Vac	6	4	4	5	2	2		
	8 Vdc	20	3	1.5	20	12.5	12.5		
	14 Vdc	20	3	1.5	15	12.5	12.5		
	30 Vdc	6	3	1.5	5	5	5		
	125 Vdc	0.5	0.5	0.5	0.05	0.05	0.05		
	250 Vdc	0.25	0.25	0.25	0.03	0.03	0.03		

Terminal Configurations

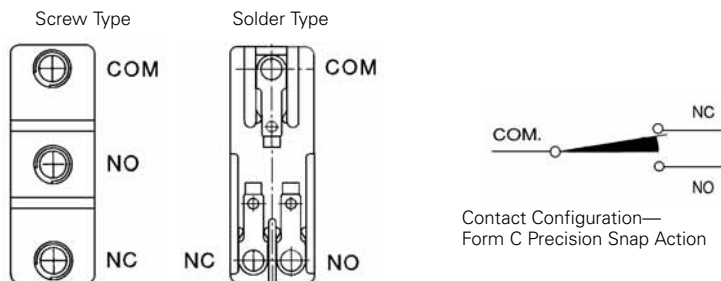

(Spade type not shown, available on some models)

Notes

- ① Inductive load has a power factor of 0.04 minimum (AC) and a time constant of 7 m/second (DC).
- ② Lamp load has an inrush current of six times steady-state current.

2.1

Limit Switches

E47 Precision Switches

Dimensions

Approximate Dimensions in Inches [mm]

2

Basic Switches

Pin Plunger

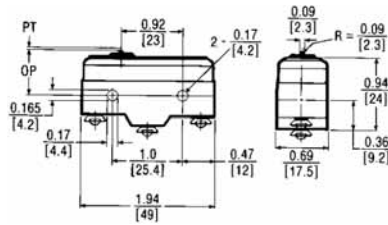

Standard Lever

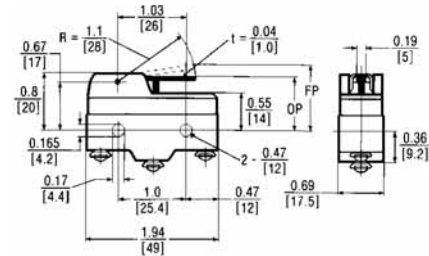

Extended Plunger

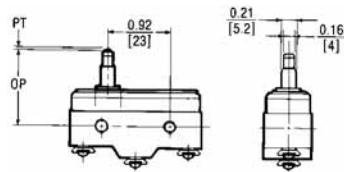

Extended Straight Plunger

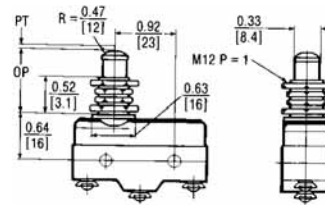

Straight Plunger

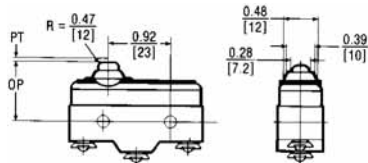

Roller Plunger

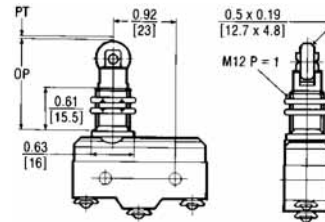

Reversed Lever

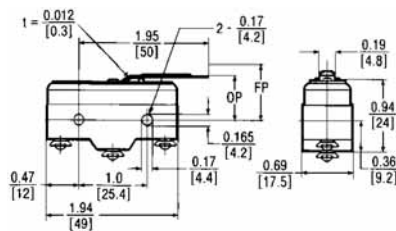

Cross Roller Plunger

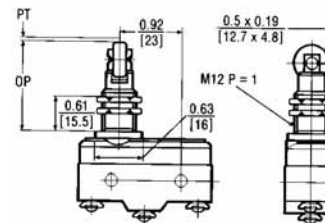

Straight Lever

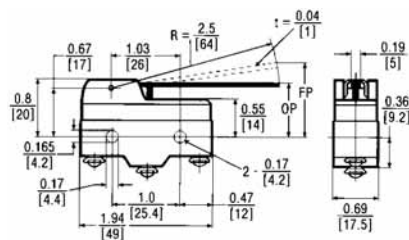

Reversed Roller Lever

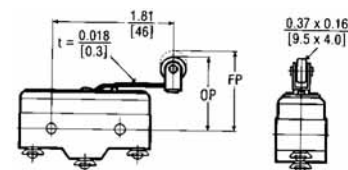

Approximate Dimensions in Inches [mm]

Extended Roller Lever

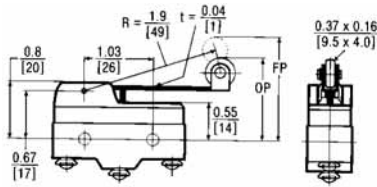

Integral Leaf

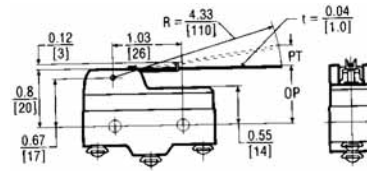

Roller Lever

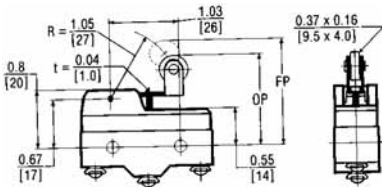

Adjustable Roller

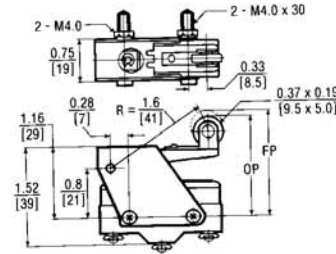

One-Way Roller

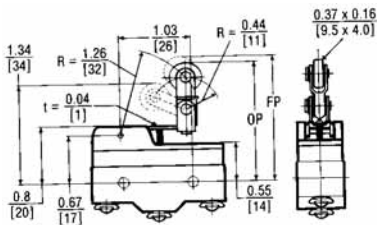

Extended Adjustable Roller

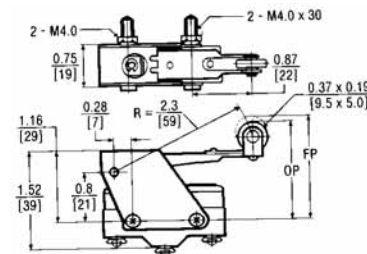

Enclosed Switches

Plunger Actuator

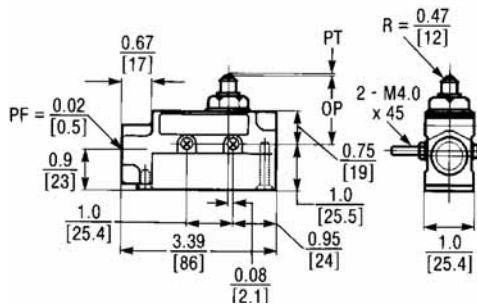

Roller Lever

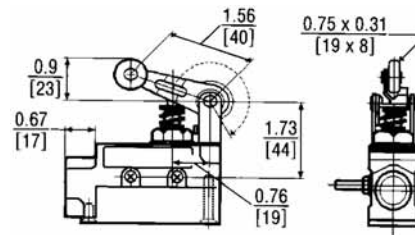

Booted Plunger

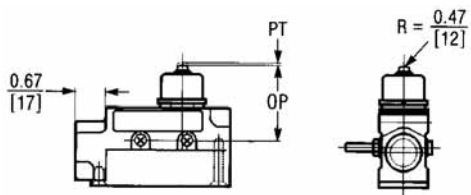

Booted Roller Lever

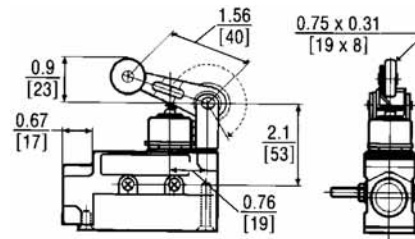

2.1

Limit Switches

E47 Precision Switches

Approximate Dimensions in Inches [mm]

2

Roller Plunger

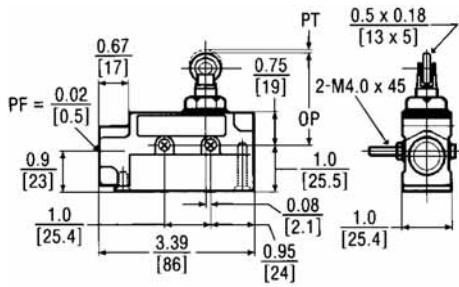

Booted One-Way Roller

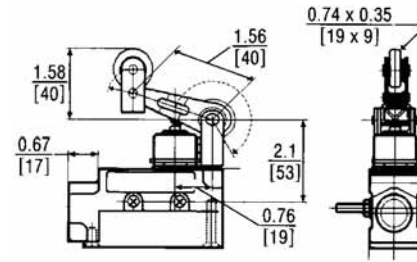

Booted Roller Plunger

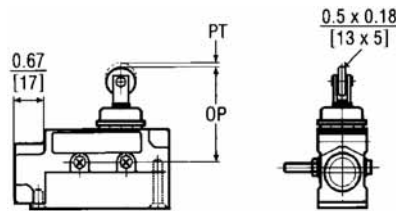

Booted Wobble

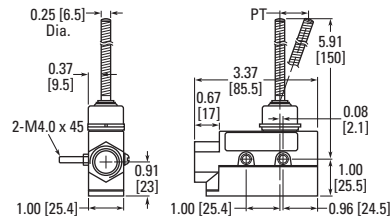

One-Way Roller

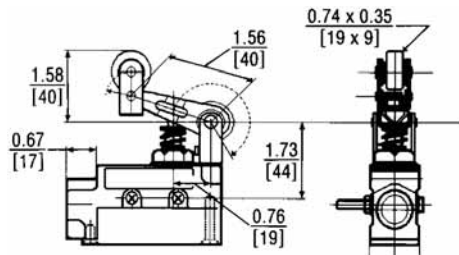

Accessories

Approximate Dimensions in mm

Terminal Wire Cover with 45° Conduit Interface

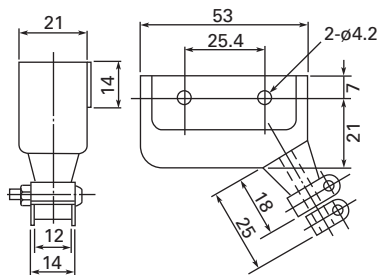

Terminal Wire Cover with 90° Conduit Interface

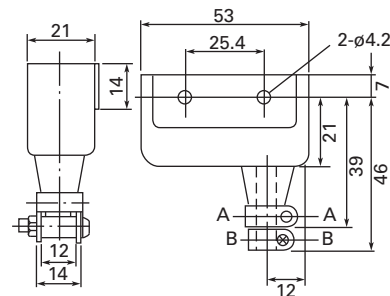

Compact Prewired Switches



Compact Prewired Switches

Product Description

The E47 Compact Prewired Limit Switch by Eaton's electrical sector is designed to be a versatile, slim device for hard to fit applications where sealing integrity is required. The rugged die cast aluminum alloy housing, cable connection and switch mechanism are encapsulated for protection against extreme temperature (-10° to 70°C [14° to 158°F]), contaminants, moisture, shock and vibration. This factory wired (3m) device has NEMA® enclosure ratings of 4, 6 and 13, making it suitable for applications such as machine tool, food processing and packaging.

Features

- Rugged aluminum alloy die cast housing
- Sealed construction with enclosure ratings of NEMA 4, 6 and 13
- Prewired with 3m of 18 AWG, AWM 2517, 300V cable, or micro-connector version also available
- Stackable ridge for ganged operation

Contents

Description

	Page
Compact Prewired Switches	
Product Selection	V8-T2-16
Technical Data and Specifications	V8-T2-18
Wiring Diagram	V8-T2-18
Dimensions	V8-T2-19

Drawings
Online

Standards and Certifications

- cULus (cable versions only)
- UL (cable versions only)
- NEMA 4, 6 and 13
- IEC IP67, IP69K
- RoHS

 **DANGER**

THIS SENSOR IS NOT A SAFETY DEVICE AND IS NOT INTENDED TO BE USED AS A SAFETY DEVICE. This sensor is designed only to detect and read certain data in an electronic manner and perform no use apart from that, specifically no safety-related use. This sensor product does not include self-checking redundant circuitry, and the failure of this sensor product could cause either an energized or de-energized output condition, which could result in death, serious bodily injury, or property damage.

For the most current information on this product, visit our Web site: www.eaton.com

For Customer Service in the U.S. call 1-877-ETN CARE (386-2273),
in Canada call 1-800-268-3578.
For Application Assistance in the U.S. and Canada
call 1-800-426-9184.





Product Selection

2

Compact Prewired Switches

Actuator Type	Operating Force (Maximum)	Reset Force (Minimum)	Over-Travel (Maximum)	Pre-Travel	Movement Differential (Maximum)	Operating Position	Standard Version Catalog Number	Connector Version Catalog Number
Pin Plunger 	Pin Plunger							
	42.3 oz (1.2 kg)	15.9 oz (450g)	0.118 in (3 mm)	0.07 in (1.8 mm)	0.008 in (0.2 mm)	0.62 ± 0.04 in (15.7 ± 1 mm)	E47BCC05	E47BCC05P4
Sealed Plunger 	Sealed Plunger							
	63.5 oz (1.8 kg)	15.9 oz (450g)	0.118 in (3 mm)	0.07 in (1.8 mm)	0.008 in (0.2 mm)	0.99 ± 0.04 in (24.9 ± 1 mm)	E47BCC06	E47BCC06P4
Roller Plunger 	Roller Plunger							
	42.3 oz (1.2 kg)	15.9 oz (450g)	0.118 in (3 mm)	0.07 in (1.8 mm)	0.008 in (0.2 mm)	1.12 ± 0.04 in (28.5 ± 1 mm)	E47BCC07	E47BCC07P4
Sealed Roller Plunger 	Sealed Roller Plunger							
	63.5 oz (1.8 kg)	15.9 oz (450g)	0.118 in (3 mm)	0.07 in (1.8 mm)	0.008 in (0.2 mm)	1.35 ± 0.04 in (34.3 ± 1 mm)	E47BCC08	E47BCC08P4
Cross Roller Plunger 	Cross Roller Plunger							
	42.3 oz (1.2 kg)	15.9 oz (450g)	0.118 in (3 mm)	0.07 in (1.8 mm)	0.008 in (0.2 mm)	1.12 ± 0.04 in (28.5 ± 1 mm)	E47BCC11	E47BCC11P4
Sealed Cross Roller Plunger 	Sealed Cross Roller Plunger							
	63.5 oz (1.8 kg)	15.9 oz (450g)	0.118 in (3 mm)	0.07 in (1.8 mm)	0.008 in (0.2 mm)	1.35 ± 0.04 in (34.3 ± 1 mm)	E47BCC12	E47BCC12P4
Bevel Plunger 	Bevel Plunger							
	42.3 oz (1.2 kg)	15.9 oz (450g)	0.118 in (3 mm)	0.07 in (1.8 mm)	0.008 in (0.2 mm)	1.12 ± 0.04 in (28.5 ± 1 mm)	E47BCC13	E47BCC13P4

Compact Prewired Switches, continued

Actuator Type	Operating Force (Maximum)	Reset Force (Minimum)	Over-Travel (Maximum)	Pre-Travel	Movement Differential (Maximum)	Operating Position	Standard Version Catalog Number	Connector Version Catalog Number
 <p>Roller Lever</p>	Roller Lever 20.5 oz (580g)	5.3 oz (150g)	40°	25° max.	3°	—	E47BCC15	E47BCC15P4
 <p>Wobble Stick</p>	Wobble Stick 5.3 oz (150g)	—	—	15° max.	—	—	E47BCC20	E47BCC20P4
 <p>Rod Lever</p>	Rod Lever 20.5 oz (580g)	5.3 oz (150g)	40°	25° max.	3°	—	—	E47BCC21P4
 <p>Adjustable Level Arm</p>	Adjustable Level Arm 20.5 oz (580g)	5.3 oz (150g)	40°	25° max.	3°	—	E47BCC22	E47BCC22P4

Technical Data and Specifications

Compact Prewired Switches

2

Description	Specification
Contacts	1-SPDT (Form C)
Mechanical life	10,000,000 operations
Electrical life	200,000 operations, 30 operation/min. at rated load
Operating speed	30 operations per minute maximum
Operating temperature range	-10° to 70°C (14° to 158°F)
Storage temperature range	-10° to 70°C (14° to 158°F)
Humidity	95% maximum non-condensing
Vibration	Malfunction durability, 10 to 55 Hz 1.5 mm double amplitude
Shock	Malfunction durability, approximately 50G
Enclosure ratings	NEMA 4, 6 and 13; IEC IP67

Maximum Ampere Ratings ^①

Rated Voltage	Non-Inductive Load (A)		Inductive Load (A)		Motor Load		Inrush Current (A)	
	NC	NO	NC	NO	NC	NO	NC	NO
125 Vac	5	5	3	3	2.5	1.3	20 max.	10 max.
250 Vac	5	5	2	2	1.5	0.8		
8 Vdc	5	5	5	4	1.5	1.5		
14 Vdc	5	5	4	4	1.5	1.5		
30 Vdc	4	4	3	3	1.5	1.5		
125 Vdc	0.4	0.4	0.4	0.4	0.05	0.05		
250 Vdc	0.2	0.2	0.2	0.2	0.03	0.03		

Wiring Diagram

Compact Prewired Switches

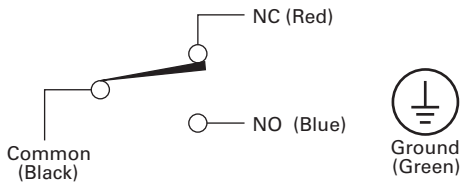

Micro-Connector Switches

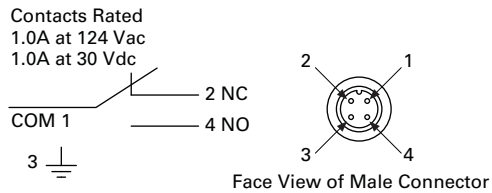

Note

^① Inductive load ratings are tested at a power factor 0.4 min. for AC power and a time constant of 7 ms max. for DC power. Inrush current for motor load is six times the steady state current.

Dimensions

Approximate Dimensions in mm [in]

E47BCC05

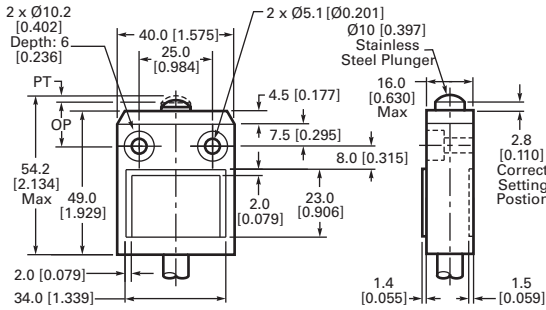

E47BCC11

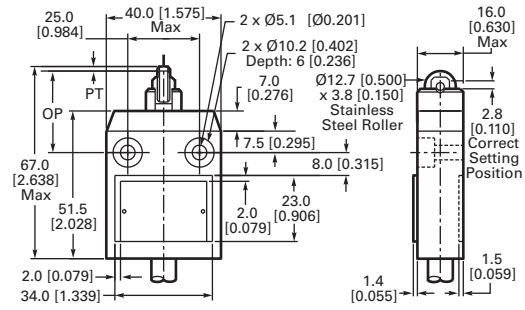

E47BCC06

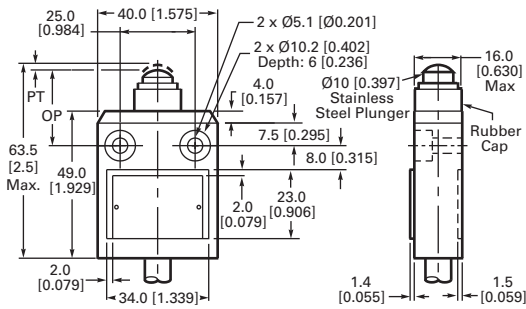

E47BCC12

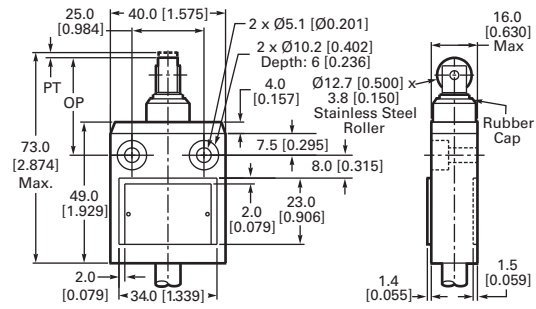

E47BCC07

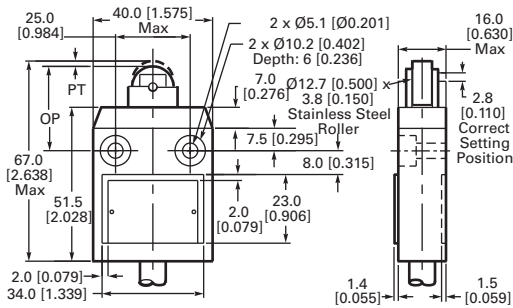

E47BCC13

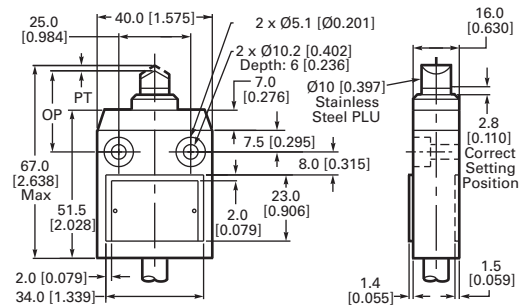

E47BCC08

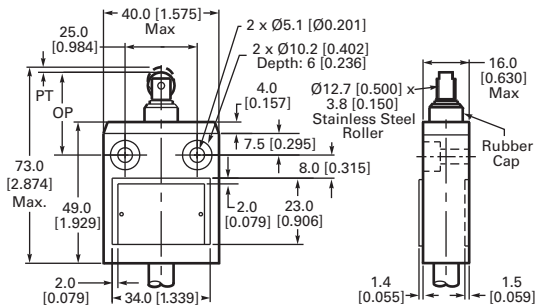

E47BCC15

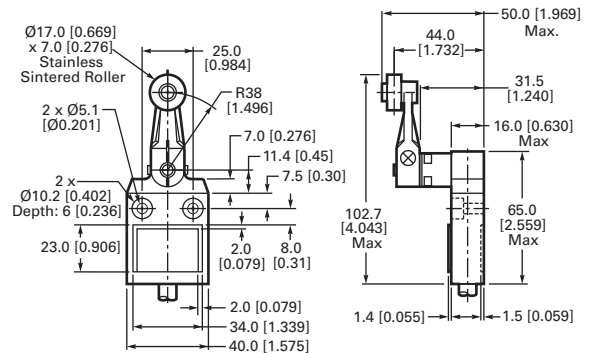

2.2

Limit Switches

Compact Prewired Switches

Approximate Dimensions in mm [in]

E47BCC20

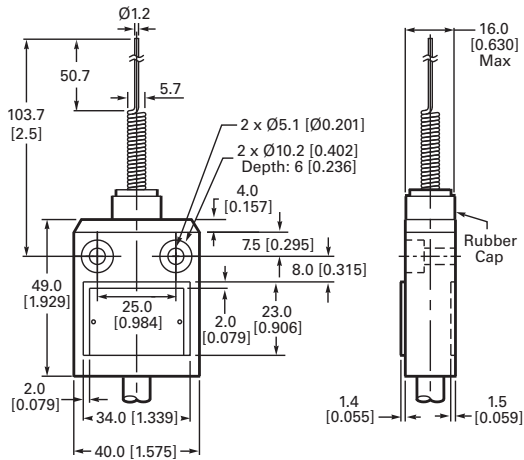

E47BCC22

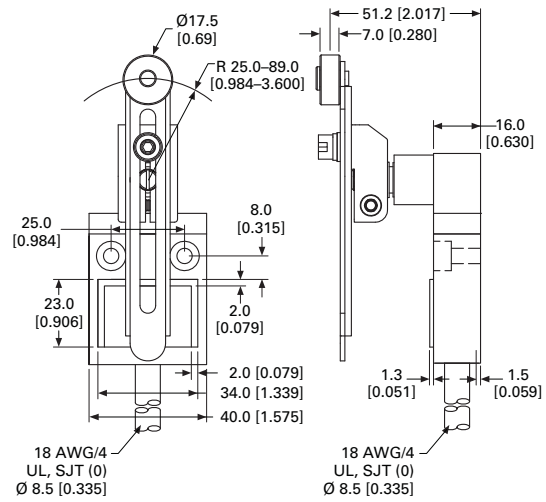

E47BCC21

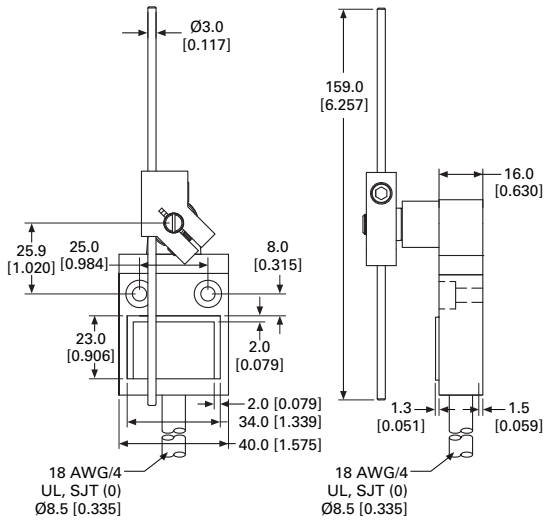

LS-Titan Miniature DIN Switches



LS-Titan Miniature DIN Switches

Product Description

Eaton's LS-Titan™ limit switch line is a complete offering of safety position switches designed for worldwide application. Economical insulated plastic or rugged metal enclosures and modular, plug-in operating heads and bodies make LS-Titan a flexible switching solution.

A highlight of the LS-Titan switch line is the world's first electronic position switch (LSE models). These switches feature freely programmable operating points that can be set individually at any time. Additional LSE models provide analog outputs proportional to the actuator position.

LS-Titan switches are suitable for use in safety applications designed to protect persons or processes.

Features

- Modular, plug-in system (head and body components)
- Positive opening NC contacts for safety applications
- Wide variety of economical plastic and rugged metal versions available
- Operating heads can be rotated 90 degrees to suit specific direction of operation
- Unique electronic safety position switches (LSE models) provide analog (0–10 Vdc or 4–20 mA) outputs proportional to the actuator position and allow for easy configuration of a custom trip point
- Can be ordered as separate components (head and body) or as completely assembled switches
- Screw and Cage Clamp® (standard on LSE models and optionally available on mechanical models) connections provide larger wiring areas for easier installation
- Approved for worldwide application

Standards and Certifications

- Safety function by positive opening contacts per IEC/EN 60947-5-1 up to Category 4 per EN 954-1
- TÜV-Rheinland Certified for Functional-Safety (LSE models)
- CSA certified
- UL listed
- CE
- CCC



Note: Cage Clamp is a registered trademark of Wago Kontakttechnik, 32423 Minden, Germany.

Contents

Description

Page

LS-Titan Miniature DIN Switches	
Product Identification	V8-T2-22
Product Selection	V8-T2-23
LS-Titan Plastic Safety Switches	V8-T2-23
LS-Titan Plastic Electronic Safety Position Switches	V8-T2-26
LS-Titan Metal Safety Switches	V8-T2-30
Understanding LS-Titan Electronic Safety Position Switches	V8-T2-32
Operating Point Adjustment	V8-T2-32
Accessories	V8-T2-33
Technical Data and Specifications	V8-T2-34
Contact Travel Diagrams	V8-T2-37
Dimensions	V8-T2-40

For the most current information on this product, visit our Web site: www.eaton.com

For Customer Service in the U.S. call 1-877-ETN CARE (386-2273), in Canada call 1-800-268-3578. For Application Assistance in the U.S. and Canada call 1-800-426-9184.

Product Identification

2

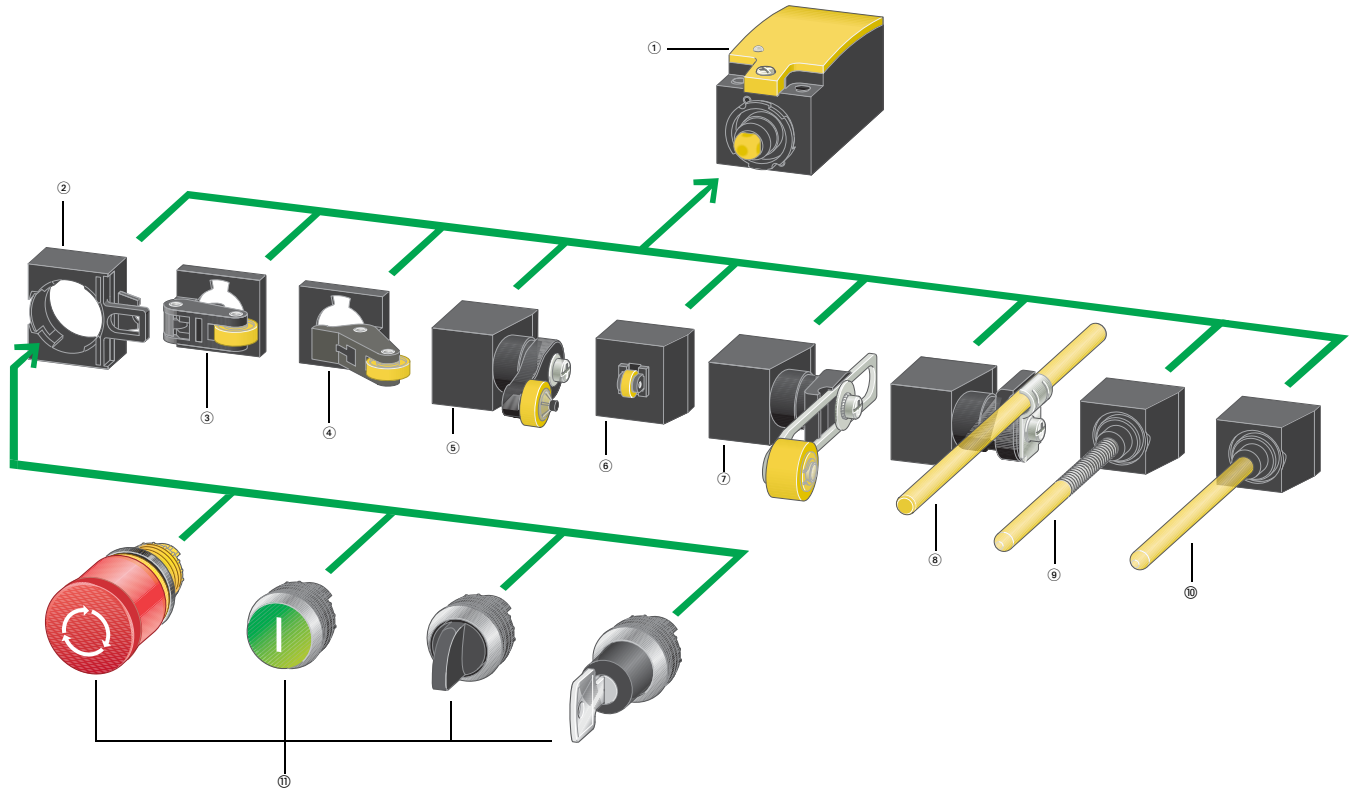

Notes

- ① **Basic device** (see **Pages V8-T2-23 to V8-T2-31**)
According to EN 50047
With screw-on cover
Contacts: 1NO-1NC, 2NO, 2NC
Cage Clamp, screw terminal
As snap-action or standard-action switch
As electronic snap-action switch (individually adjustable)
As 4–20 mA analog signal encoder
As 0–10 Vdc analog signal encoder
- ② **Fixing adapter** (see **Page V8-T2-33**)
Allows mounting of M22 pushbuttons
- ③ **Roller lever** (see **Pages V8-T2-23 and V8-T2-26**)
For one-sided operation with higher operating speed
- ④ **Angled roller lever** (see **Pages V8-T2-23, V8-T2-26 and V8-T2-30**)
For actuation along the unit axis
- ⑤ **Rotary lever** (see **Pages V8-T2-23, V8-T2-27 and V8-T2-30**)
For actuation from the side, for pendulum movements
- ⑥ **Roller plunger** (see **Pages V8-T2-23, V8-T2-26 and V8-T2-30**)
For actuation from the side with low actuating force
- ⑦ **Adjustable roller lever** (see **Pages V8-T2-24, V8-T2-27, V8-T2-28 and V8-T2-30**)
For length adjustment as required
- ⑧ **Actuating rod** (see **Pages V8-T2-25, V8-T2-29 and V8-T2-31**)
On conveyor belts for lightweight goods
- ⑨ **Spring-rod** (see **Pages V8-T2-25, V8-T2-29 and V8-T2-31**)
For flexible actuation from all sides
- j **Actuating rod** (see **Pages V8-T2-25, V8-T2-29 and V8-T2-31**)
Withdrawable mechanism from front
- k Pushbuttons from the M22 family; see M22 catalog (CA04716001E) or www.eaton.com/m22

Operating heads can be rotated by 90 degrees.

Product Selection

LS-Titan Plastic Safety Switches

Plastic Safety Switch Body



Assembled Switch



Plastic Safety Switches

Switch Body Catalog Number

Output Function

Terminal Connection

Contact Sequence

Contact Travel

■ = contact closed

□ = contact open

Operating Head Type ②

Head Only

Catalog Number

LS-S02

2NC with positive opening contacts

Screw terminal ①

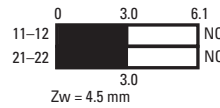

LS-S20A

2NO with slow make/break

Screw terminal ①

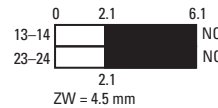

LS-S11S

1NO and 1NC with positive opening contact

Screw terminal ①

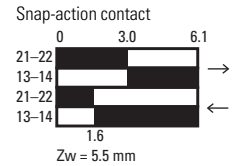

Assembled Switch Catalog Number

Top Push Roller Plunger

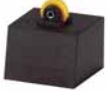

LS-XP

LS-S02-P

LS-S20A-P

LS-S11S-P

Long Roller Lever



LS-XL

LS-S02-L

LS-S20A-L

LS-S11S-L

Short Roller Lever



LS-XLS

LS-S02-LS

LS-S20A-LS

LS-S11S-LS

Large Roller Lever



LS-XLB

LS-S02-LB

LS-S20A-LB

LS-S11S-LB

Angled Roller



LS-XLA

LS-S02-LA

LS-S20A-LA

LS-S11S-LA

Rotary Lever



LS-XRL

LS-S02-RL

LS-S20A-RL

LS-S11S-RL

Notes

① Cage Clamp versions available. Contact Application Engineering.

② For operating head dimensions, see **Page V8-T2-40**.

Plastic Safety Switch Body



Assembled Switch



Plastic Safety Switches, continued

Switch Body Catalog Number

Output Function

Terminal Connection

Contact Sequence

Contact Travel

■ = contact closed
□ = contact open

Operating Head Type ②

Head Only

Catalog Number

LS-S02

2NC with positive opening contacts

Screw terminal ①

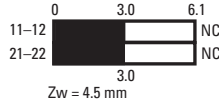

LS-S20A

2NO with slow make/break

Screw terminal ①

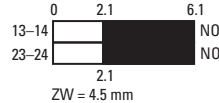

LS-S11S

1NO and 1NC with positive opening contact

Screw terminal ①



Snap-action contact

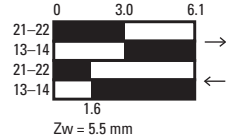

Assembled Switch Catalog Number

Adjustable Roller Lever (with 18 mm Roller)



LS-XRLA

LS-S02-RLA

LS-S20A-RLA

LS-S11S-RLA

Adjustable Roller Lever (with 30 mm Roller)



LS-XRLA30

LS-S02-RLA30

LS-S20A-RLA30

LS-S11S-RLA30

Adjustable Roller Lever (with 40 mm Roller)



LS-XRLA40

LS-S02-RLA40

LS-S20A-RLA40

LS-S11S-RLA40

Adjustable Roller Lever (with 40 mm Rubber Roller)



LS-XRLA40R

LS-S02-RLA40R

LS-S20A-RLA40R

LS-S11S-RLA40R

Notes

- ① Cage Clamp versions available. Contact Application Engineering.
- ② For operating head dimensions, see **Page V8-T2-40**.

Plastic Safety Switches, continued

Plastic Safety Switch Body



Assembled Switch



Switch Body Catalog Number

Output Function

Terminal Connection

Contact Sequence

Contact Travel

■ = contact closed
□ = contact open

Operating Head Type ②

Head Only Catalog Number

LS-S02

2NC with positive opening contacts

Screw terminal ①

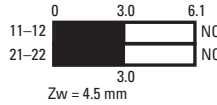

LS-S20A

2NO with slow make/break

Screw terminal ①

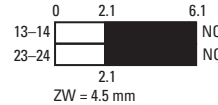

LS-S11S

1NO and 1NC with positive opening contact

Screw terminal ①

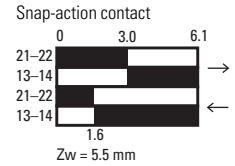

Plastic Rod Lever



Metal Rod



Spring Rod (Wobble) ③



Actuating Rod



LS-XRR

LS-XRRM

LS-XS

LS-XOR

LS-S02-RR

LS-S02-RRM

LS-S02-S

LS-S02-OR

LS-S20A-RR

LS-S20A-RRM

LS-S20A-S

LS-S20A-OR

LS-S11S-RR

LS-S11S-RRM

LS-S11S-S

LS-S11S-OR

Notes

- ① Cage Clamp versions available. Contact Application Engineering.
- ② For operating head dimensions, see Page V8-T2-40.
- ③ Not to be used as a safety position switch. Use only in conjunction with snap-action contact.

LS-Titan Plastic Electronic Safety Position Switches

2

Plastic Electronic Safety Position Switch Body



Assembled Switch



Plastic Electronic Safety Position Switches

Switch Body Catalog Number

Output Function

Terminal Connections

Safety Functions and Approvals

LSE-11

1NO and 1 NC

Cage Clamp ①

These models may be used in safety-oriented circuits. Visual status LED indication is comparable to positive opening contacts. Certified by TÜV as a "Functional-Safety" device. Suitable for protection of people or processes.



LSE-02

2NC

Cage Clamp ①

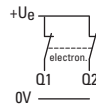
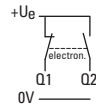

LSE-AI

Analog 4–20 mA

Cage Clamp ①

Additional diagnostic output that registers a 0V signal in the event of a fault. Self-test function continuously tests both outputs for overloads, short circuits to 0V and short circuits to +U_e. Certified by TÜV to EN 954-1, Category 3 or 4. Suitable for protection of people or processes.



Analog 4–20 mA

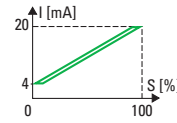

LSE-AU

Analog 0–10V

Cage Clamp ①

Analog 0–10V

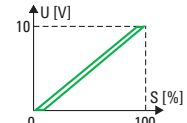

Contact Sequence

Contact Travel

■ = contact closed

□ = contact open

Operating Head Type ②

Head Only Catalog Number

Assembled Switch Catalog Number

Top Push Roller Plunger



LS-XP

LSE-11-P

LSE-02-P

LSE-AI-P

LSE-AU-P

Long Roller Lever



LS-XL

LSE-11-L

LSE-02-L

LSE-AI-L

LSE-AU-L

Short Roller Lever



LS-XLS

LSE-11-LS

LSE-02-LS

LSE-AI-LS

LSE-AU-LS

Large Roller Lever



LS-XLB

LSE-11-LB

LSE-02-LB

LSE-AI-LB

LSE-AU-LB

Angled Roller



LS-XLA

LSE-11-LA

LSE-02-LA

LSE-AI-LA

LSE-AU-LA

Notes

① A compatible Cage Clamp tool is available as an accessory on [Page V8-T2-33](#).

② For operating head dimensions, see [Page V8-T2-40](#).

Plastic Electronic Safety Position Switches, continued

Plastic Electronic Safety Position Switch Body



Assembled Switch



Switch Body Catalog Number
Output Function
Terminal Connections
Safety Functions and Approvals

LSE-11

1NO and 1NC

Cage Clamp ①

These models may be used in safety-oriented circuits. Visual status LED indication is comparable to positive opening contacts. Certified by TÜV as a "Functional-Safety" device. Suitable for protection of people or processes.



LSE-02

2NC

Cage Clamp ①

LSE-AI

Analog 4–20 mA

Cage Clamp ①

Additional diagnostic output that registers a 0V signal in the event of a fault. Self-test function continuously tests both outputs for overloads, short circuits to 0V and short circuits to +U₀. Certified by TÜV to EN 954-1, Category 3 or 4. Suitable for protection of people or processes.



LSE-AU

Analog 0–10V

Cage Clamp ①

Contact Sequence

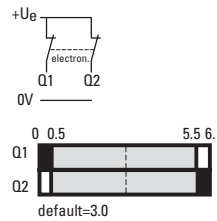
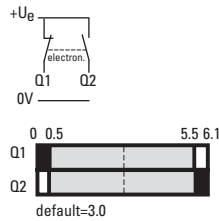

Analog 4–20 mA

Analog 0–10V

Contact Travel
 ■ = contact closed
 □ = contact open

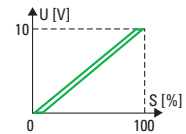
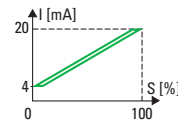

Operating Head Type ②

Head Only Catalog Number **Assembled Switch Catalog Number**

Rotary Lever



LS-XRL LSE-11-RL LSE-02-RL LSE-AI-RL LSE-AU-RL

Adjustable Roller Lever (with 18 mm Roller)



LS-XRLA LSE-11-RLA LSE-02-RLA LSE-AI-RLA LSE-AU-RLA

Adjustable Roller Lever (With 30 mm Roller)



LS-XRLA30 LSE-11-RLA30 LSE-02-RLA30 LSE-AI-RLA30 LSE-AU-RLA30

Notes

- ① A compatible Cage Clamp tool is available as an accessory on **Page V8-T2-33**.
- ② For operating head dimensions, see **Page V8-T2-40**.

Plastic Electronic Safety Position Switch Body



Assembled Switch



Plastic Electronic Safety Position Switches, continued

Switch Body

Catalog Number

Output Function

Terminal Connections

Safety Functions and Approvals

LSE-11

1NO and 1NC

Cage Clamp ①

These models may be used in safety-oriented circuits. Visual status LED indication is comparable to positive opening contacts. Certified by TÜV as a "Functional-Safety" device. Suitable for protection of people or processes.

LSE-02

2NC

Cage Clamp ①

LSE-AI

Analog 4–20 mA

Cage Clamp ①

LSE-AU

Analog 0–10V

Cage Clamp ①

Additional diagnostic output that registers a 0V signal in the event of a fault. Self-test function continuously tests both outputs for overloads, short circuits to 0V and short circuits to +U_e. Certified by TÜV to EN 954-1, Category 3 or 4. Suitable for protection of people or processes.



Contact Sequence

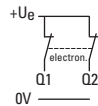
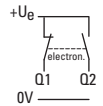

Analog 4–20 mA

Analog 0–10V

Contact Travel

■ = contact closed

□ = contact open

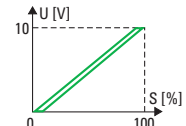
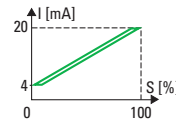
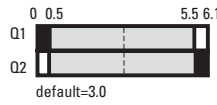
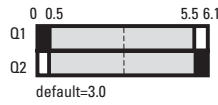

Operating Head Type ②

**Head Only
Catalog Number**

**Assembled Switch
Catalog Number**

Adjustable Roller Lever (With 40 mm Roller)



LS-XRLA40

LSE-11-RLA40

LSE-02-RLA40

LSE-AI-RLA40

LSE-AU-RLA40

Adjustable Roller Lever (With 40 mm Roller)



LS-XRLA40R

LSE-11-RLA40R

LSE-02-RLA40R

LSE-AI-RLA40R

LSE-AU-RLA40R

Plastic Rod Lever



LS-XRR

LSE-11-RR

LSE-02-RR

LSE-AI-RR

LSE-AU-RR

Notes

- ① A compatible Cage Clamp tool is available as an accessory on **Page V8-T2-33**.
- ② For operating head dimensions, see **Page V8-T2-40**.

Plastic Electronic Safety Position Switches, continued

Plastic Electronic Safety Position Switch Body



Assembled Switch



Switch Body Catalog Number
Output Function
Terminal Connections
Safety Functions and Approvals

LSE-11

1NO and 1NC
 Cage Clamp ①

LSE-02

2NC
 Cage Clamp ①

LSE-AI

Analog 4–20 mA
 Cage Clamp ①

LSE-AU

Analog 0–10V
 Cage Clamp ①

These models may be used in safety-oriented circuits. Visual status LED indication is comparable to positive opening contacts. Certified by TÜV as a “Functional-Safety” device. Suitable for protection of people or processes.

Additional diagnostic output that registers a 0V signal in the event of a fault. Self-test function continuously tests both outputs for overloads, short circuits to 0V and short circuits to +U_e. Certified by TÜV to EN 954-1, Category 3 or 4. Suitable for protection of people or processes.



Contact Sequence

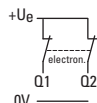
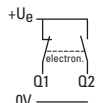

Contact Travel
 ■ = contact closed
 □ = contact open

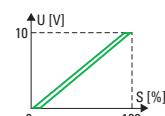
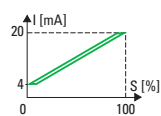
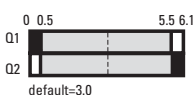
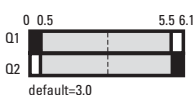

Operating Head Type ②

Head Only Catalog Number **Assembled Switch Catalog Number**

Metal Rod



LS-XRRM

LSE-11-RRM

LSE-02-RRM

LSE-AI-RRM

LSE-AU-RRM

Spring Rod (Wobble) ③



LS-XS

LSE-11-S

LSE-02-S

LSE-AI-S

LSE-AU-S

Actuating Rod



LS-XOR

LSE-11-OR

LSE-02-OR

LSE-AI-OR

LSE-AU-OR

Notes

- ① A compatible Cage Clamp tool is available as an accessory on **Page V8-T2-33**.
- ② For operating head dimensions, see **Page V8-T2-40**.
- ③ Not to be used as a safety position switch. Use only in conjunction with snap-action contact.

LS-Titan Metal Safety Switches

2

Metal Safety Switch Body



Assembled Switch



Metal Safety Switches

Switch Body Catalog Number

Output Function

Terminal Connection

Contact Sequence

Contact Travel

■ = contact closed

□ = contact open

LSM-02

2NC with positive opening contacts

Cage Clamp

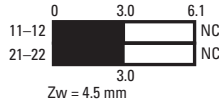

LSM-20A

2NO with slow make/break

Cage Clamp

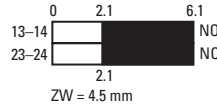

LSM-11S

1NO and 1NC with positive opening contact

Cage Clamp



Snap-action contact

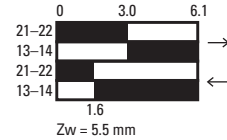

Operating Head Type ①

Head Only Catalog Number

Assembled Switch Catalog Number

Top Push Roller Plunger



LSM-XP

LSM-02-P

LSM-20A-P

LSM-11S-P

Long Roller Lever



LSM-XL

LSM-02-L

LSM-20A-L

LSM-11S-L

Angled Roller



LSM-XLA

LSM-02-LA

LSM-20A-LA

LSM-11S-LA

Rotary Lever



LSM-XRL

LSM-02-RL

LSM-20A-RL

LSM-11S-RL

Adjustable Roller Lever



LSM-XRLA

LSM-02-RLA

LSM-20A-RLA

LSM-11S-RLA

Note

① For operating head dimensions, see **Page V8-T2-40**.

Metal Safety Switches, continued

Metal Safety Switch Body



Assembled Switch



Switch Body Catalog Number

Output Function

Terminal Connection

Contact Sequence

Contact Travel

- = contact closed
- = contact open

Operating Head Type ①

Head Only

Catalog Number

LSM-02

2NC with positive opening contacts

Cage Clamp

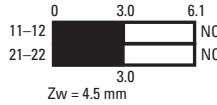

LSM-20A

2NO with slow make/break

Cage Clamp

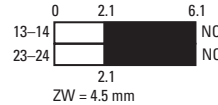

LSM-11S

1NO and 1NC with positive opening contact

Cage Clamp



Snap-action contact

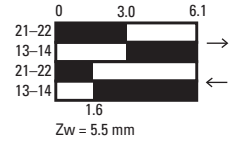

Assembled Switch Catalog Number

Plastic Rod Lever



LSM-XRR

LSM-02-RR

LSM-20A-RR

LSM-11S-RR

Metal Rod Lever



LSM-XRRM

LSM-02-RRM

LSM-20A-RRM

LSM-11S-RRM

Spring Rod (Wobble)



LSM-XS

LSM-02-S

LSM-20A-S

LSM-11S-S

Note

① For operating head dimensions, see **Page V8-T2-40**.

Understanding LS-Titan Electronic Safety Position Switches

All four LS-Titan LSE switch bodies are safety-rated products. The LSE-11 and LSE-02 switch bodies both have a freely programmable operating point and can be individually adjusted to suit the application, and can be changed as often as required. These devices feature an LED on the body, providing simple indication during programming and operation.

The LSE-AI (4–20 mA) and LSE-AU (0–10V) analog position switches take position data and convert to an analog current or voltage value that can then be continuously fed into an automation system. These two switches also feature a diagnostic output for additional data processing.

This ensures that a safe operating state can be monitored and evaluated at any time. A self-test function is also present on these models. Outputs Q1 and Q2 are continuously tested for overloads, short circuits to 0V and short circuits to +U_e.

Like the electromechanical position switches, LS-Titan electronic position switches meet Category 3 or 4 of the EN 954-1 standard for machine safety when configured as a redundant system. All devices are thus suitable for safety applications that are used for the protection of persons or processes.

Operating Point Adjustment

LSE-11

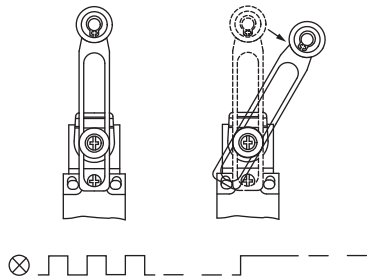

LSE-02

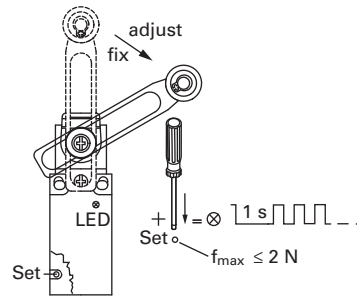

Example of LS-Titan LSE Models in a Safety-Oriented Circuit

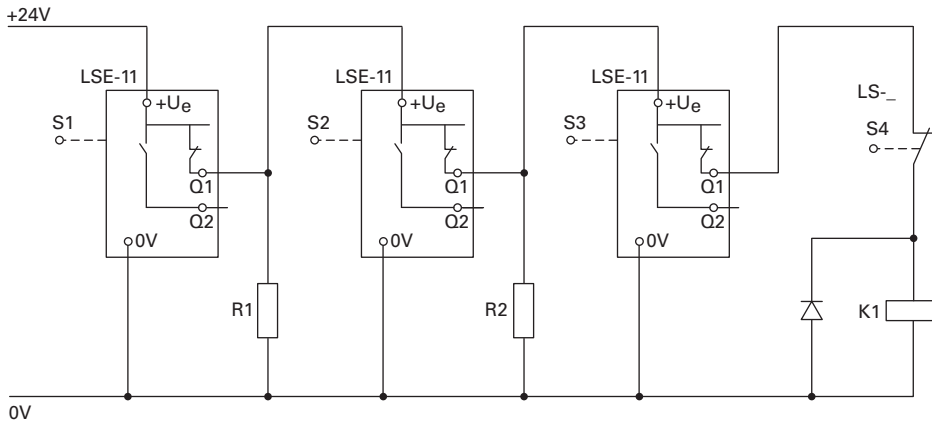

Notes

LSE-11 and LSE-02—individual operating point adjustment.

LSE-11 and LSE-02 can be used in safety circuits.



S1 is connected to 24 Vdc

S2, S3 each switch with a delay of 0.7s

R1, R2, for example, series element M22-XLED60 (2820 ohms/0.5W)

Accessories

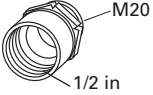
LS-Titan Safety Switches

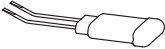
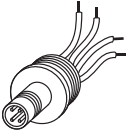
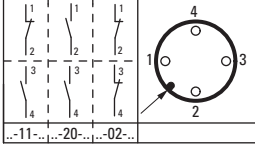
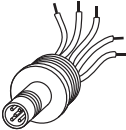
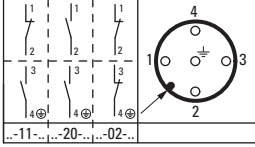
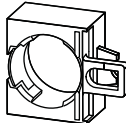
	For Use With	Description	Notes	Catalog Number
	Any	M20 screw terminal in 1/2 in. For use with American pipe thread, metal.	The screw connection must be earthed. Not total insulation.	V1-2-M20-NA
	Any	M20 screw terminal in 1/2 in. For use with American pipe thread, molded material.	—	V1-2-M20
	Any	M20 diaphragm bolt. With internal push-through membrane. Will fit cable with an external diameter of up to 13 mm. Rated IP65 with cable inserted.	—	EMS20
	Any	Cage Clamp tool.	—	LS-XTW
	LS-Titan plastic bodies (LS-_)	Plug connector, 12 mm, 4-pin male connector M12x1 (M12x1). Rated IP65. Molded material. Color coded to IEC/EN 60947-5-2.		M12A
	LS-Titan metal bodies (LSM-_)	Plug connector, 12 mm, 5-pin male connector (M12x1). Rated IP65. Molded material. Color coded to IEC/EN 60947-5-2.		M12A5
	Any	Allows mounting of M22 pushbuttons. (See the M22 catalog, CA04716001E, for a full selection of pushbuttons.)	—	M22-LS

Technical Data and Specifications

LS-Titan Miniature DIN Switches—IP66, IP67 Complete Units

2

Units			LS, LSM	LSE-11/LSE-02	LSE-AI ①	LSE-AU ①
General						
Standards			IEC/EN 60947	IEC/EN 60947 EN 61000-4	IEC/EN 60947 EN 61000-4	IEC/EN 60947 EN 61000-4
Climatic proofing			Damp heat, constant, to IEC 60068-2-78; damp heat, cyclical, to IEC 60068-2-30	Damp heat, constant, to IEC 60068-2-78; damp heat, cyclical, to IEC 60068-2-30	Damp heat, constant, to IEC 60068-2-78; damp heat, cyclical, to IEC 60068-2-30	Damp heat, constant, to IEC 60068-2-78; damp heat, cyclical, to IEC 60068-2-30
Ambient temperature	°F (°C)		–13° to 158°F (–25° to 70°C)	–13° to 158°F (–25° to 70°C)	–13° to 158°F (–25° to 70°C)	–13° to 158°F (–25° to 70°C)
Mounting position			As required	As required	As required	As required
Protection type			IP66, IP67	IP66, IP67	IP66, IP67	IP66, IP67
Terminal capacity of screw terminal and Cage Clamp						
Solid	mm ²		1 x (0.5–2.5)	1 x (0.5–2.5)	1 x (0.5–2.5)	1 x (0.5–2.5)
Flexible with ferrules to DIN 46228	mm ²		1 x (0.5–1.5)	1 x (0.5–1.5)	1 x (0.5–1.5)	1 x (0.5–1.5)
Power Supply						
Rated voltage	U _e	Vdc	N/A	12–30	24 (–15%/+20%)	24 (–15%/+20%)
Burden current						
12V	I _e	mA	N/A	15	N/A	N/A
24V	I _e	mA	N/A	18	28–45	24
30V	I	mA	N/A	19	N/A	N/A
Contacts/Switching Capacity						
Rated impulse withstand voltage	U _{imp}	Vac	4000	N/A	N/A	N/A
Rated insulation voltage	U _i	V	400	N/A	N/A	N/A
Overvoltage category/ pollution degree			III/3	III/3	N/A	N/A
Rated Operational Current						
AC–15						
24V	I _e	A	6	N/A	N/A	N/A
230V/240V	I _e	A	6	N/A	N/A	N/A
400V/415V	I _e	A	4	N/A	N/A	N/A
DC-13						
24V	I _e	A	3	0.2	N/A	N/A
110V	I _e	A	0.8	N/A	N/A	N/A
220V	I _e	A	0.3	N/A	N/A	N/A

Note

① The following applies for LSE-11 and LSE-02: ensure that the power supply operates correctly when setting the operating point.

LS-Titan Miniature DIN Switches—IP66, IP67 Complete Units. continued

Units		LS, LSM	LSE-11/LSE-02	LSE-AI ①	LSE-AU ①
Burden Current					
Analog output Q1					
Output voltage (max. 10 mA)	Vdc	N/A	N/A		0–10
Output current	mA	N/A	N/A	4–20	
Fault scenario	V	N/A	N/A	0	0
Resolution	Steps	N/A	N/A	100	100
Step tolerance	Steps	N/A	N/A	1	1
Shunt resistor, resistive load	ohms	N/A	N/A	<400	>1000
Digital diagnostics output Q2 (switching to + pole PNP)					
Response threshold	V	N/A	N/A	Approx. U_e	Approx. U_e
	mA	N/A	N/A	<200	<200
Control circuit reliability					
At 24 Vdc/5 mA	H_F	Fault probability	$<10^{-7}$, <1 fault in 10^7 operations	N/A	N/A
At 5 Vdc/1 mA	H_F	Fault probability	$<10^{-6}$, <1 failure at 5×10^6 operations	N/A	N/A
Supply frequency	Hz	Max. 400	N/A	N/A	N/A
Short-circuit rating to IEC/EN 60947-5-1					
Maximum fuse	A gG/gL	6	N/A	N/A	N/A
Repetition accuracy	mm	± 0.02	± 0.02	± 0.02	± 0.02

Note

① The following applies for LSE-11 and LSE-02: ensure that the power supply operates correctly when setting the operating point.

LS-Titan Miniature DIN Switches—IP66, IP67 Complete Units

	Units	LS, LSM		LSE-11/LSE-02	LSE-AI/LSE-AU	LSE-AI/LSE-AU
Mechanical Variables						
Lifespan						
Standard-action contact	Operations	X 10 ⁶	8	N/A	N/A	N/A
Snap-action contact	Operations	X 10 ⁶	8	3 (electronic)	N/A	N/A
Contact temperature of roller head		°C	≤100	≤100	≤100	≤100
Mechanical shock resistance (half-sinusoidal shock, 20 ms)						
Standard-action contact		g	25	N/A	N/A	N/A
Snap-action contact			9	N/A	N/A	N/A
Basic unit		g	N/A	30	30	30
Operating frequency	Operations/h		≤6000	≤3000	≤3000	≤3000
Switching point			N/A	0.5–5.5 mm freely adjustable	N/A	N/A
Hysteresis		mm	N/A	0.4	0.4	0.4
Contact sequence (contact closed open Zw = positive opening clearance)		mm	N/A	0.04	0.06	0.06
Actuation						
Mechanical						
Actuating force at beginning/end of stroke						
Basic units		N	1.0/8.0	3.5/8.0	3.5/8.0	3.5/8.0
LS(M)-XP		N	1.0/8.0	1.0/8.0	1.0/8.0	1.0/8.0
LS(M)-XL		N	1.0/8.0	1.0/8.0	1.0/8.0	1.0/8.0
LS(M)-XLA		N	1.0/8.0	1.0/8.0	1.0/8.0	1.0/8.0
Actuating torque of rotary drives		Nm	0.2	0.2	0.2	0.2
Maximum operating speed with DIN cam						
Basic units for angle of actuation	$\alpha = 0^\circ/30^\circ$	m/s	1/0.5	1/0.5	1/0.5	1/0.5
LS(M)-XRL for angle of actuation	$\alpha = 0^\circ$	m/s	1.5	1.5	1.5	1.5
LS(M)-XRLA for angle of actuation	$\alpha = 30^\circ, L = 125 \text{ mm}$	m/s	1.5	1.5	1.5	1.5
LS(M)-XRR for angle of actuation	$L = 130 \text{ mm}$	m/s	1.5	1.5	1.5	1.5
LS(M)-XL for angle of actuation	$\alpha = 30^\circ/45^\circ$	m/s	1	1	1	1
LS(M)-XLA for angle of actuation	$\alpha = 30^\circ/45^\circ$	m/s	1	1	1	1
LS(M)-XP for angle of actuation	$\alpha = 0^\circ/30^\circ$	m/s	1/1	1/1	1/1	1/1
Electromagnetic Compatibility (EMC)						
Electrostatic discharge (IEC/EN 61000-4-2, Level 3 ESD)						
Air discharge		kV		8	8	8
Contact discharge		kV		4	4	4
Electromagnetic fields (IEC/EN 61000-403, RFI)		V/m		10	10	10
Burst pulses (IEC/EN 61000-4-4, Level 3)						
Supply cables		kV		2	2	2
Signal lines		kV		2	2	2
High-energy pulses (surge) (IEC/EN 61000-4-5)		kV		0.5	0.5	0.5
Immunity to line-conducted interference to (IEC/EN 61000-4-6)		V		10	10	10

Contact Travel Diagrams

LSE

Contact Travel

■ = contact closed
□ = contact open

Description

Basic Units

LSE-11

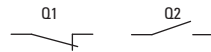

LSE-02

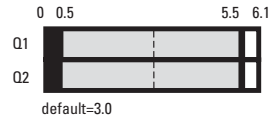
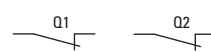

Operating Heads

Roller plunger

- LS-XP
- LSM-XP

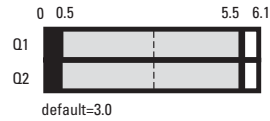
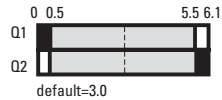

Roller lever

- LS-XL
- LSM-XL
- LS-XL
- LS-XLB

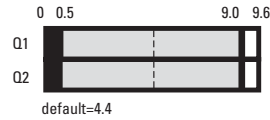
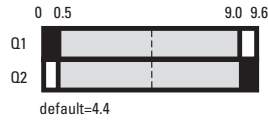

Angled roller lever

- LS-XLA
- LSM-XLA

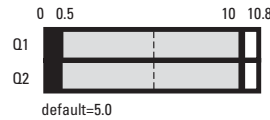
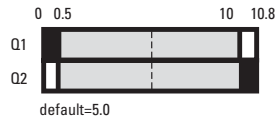

Rotary lever

- LS-XRL
- LSM-XRL

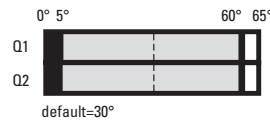
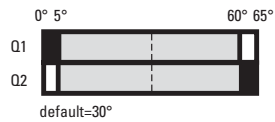

Adjustable roller lever

- LS-XRLA
- LSM-XRLA
- LS-XRLA30
- LS-XRLA40
- LS-XRLA40R

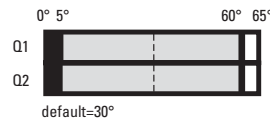
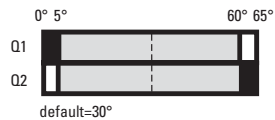

Actuating rod

- LS-XRR
- LSM-XRR
- LS-XRRM
- LSM-XRRM

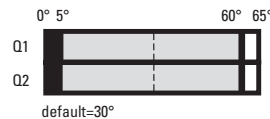
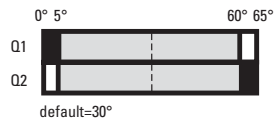

Spring rod

- LS-XS
- LSM-XS

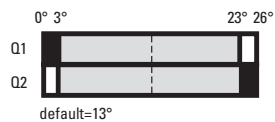

LS and LSM

2

Contact Travel

= contact closed
 = contact open

Description

LS-02, LS-S02, LSM-02

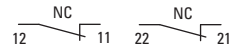

LS-11S, LS-S11S, LSM-11S

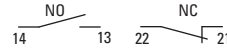

LS-20A, LS-S20A, LSM-20A

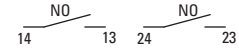

Basic Units

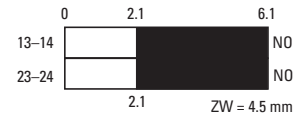
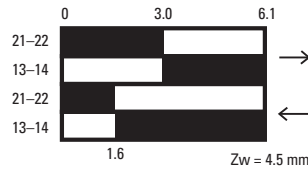
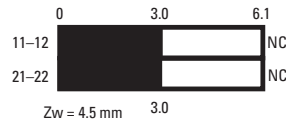

Operating Heads

Roller plunger

LS-XP, LSM-XP

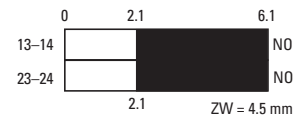
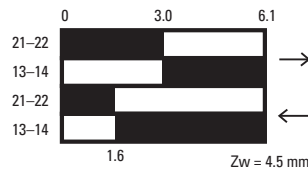
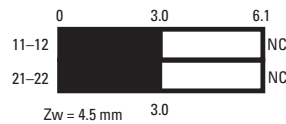

Roller lever

LS-XL, LSM-XL

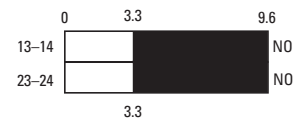
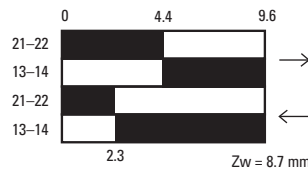
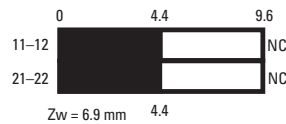

Roller lever, short

LS-XLS

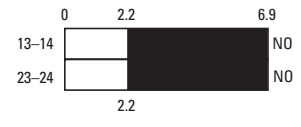
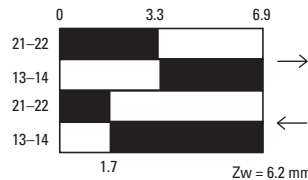
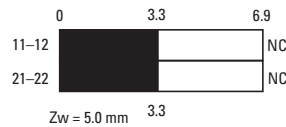

Roller lever, large

LS-XLB

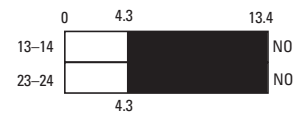
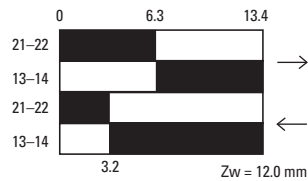
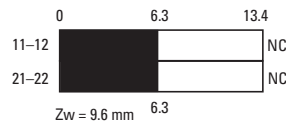

LS and LSM, continued

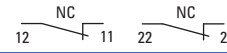
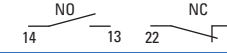
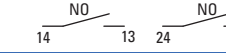
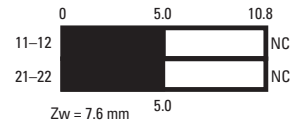
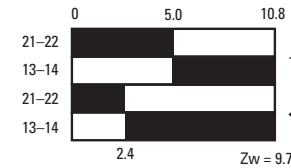
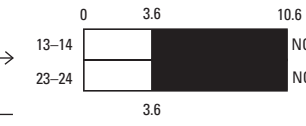
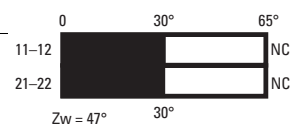
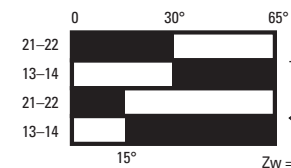
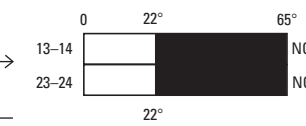
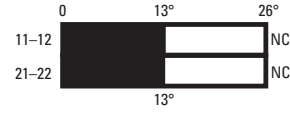
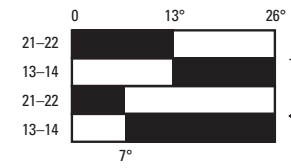
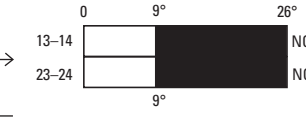
Description	Contact Travel	LS-02, LS-S02, LSM-02	LS-11S, LS-S11S, LSM-11S	LS-20A, LS-S20A, LSM-20A
Operating Heads	■ = contact closed □ = contact open			
Angled roller lever LS-XLA, LSM-XLA				
Rotary lever LS-XRL, LSM-XRL Adjustable roller lever LS-XRLA, LSM-XRLA LS-XRLA30, LS-XRLA40 LS-XRLA40R				
Actuating rod LS-XRR, LSM-XRR LS-XRRM, LSM-XRRM				
Spring rod LS-XS, LSM-XS				

Dimensions

Approximate Dimensions in Inches (mm)

2

Position Switches

LS-, LSM-, LSE-

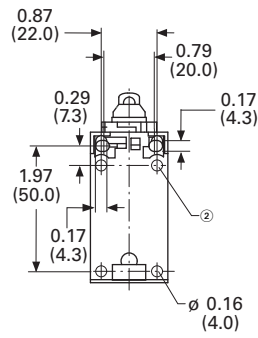
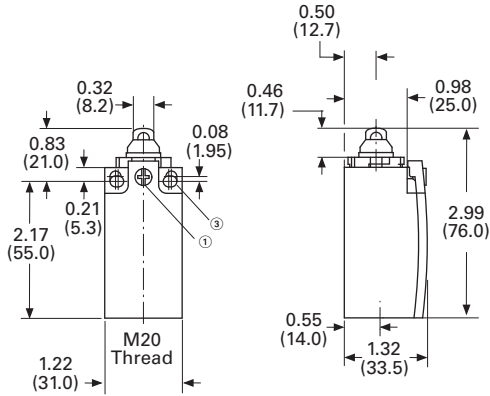

LS-, LSM-, LSE-

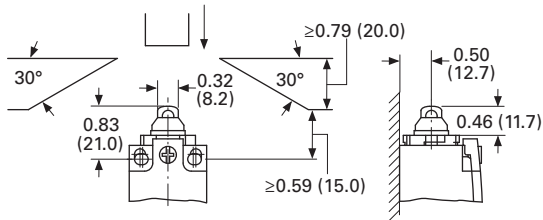

LS(M)-_/S

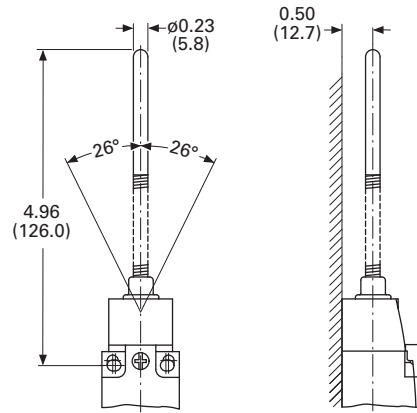

LS(M)-_/P

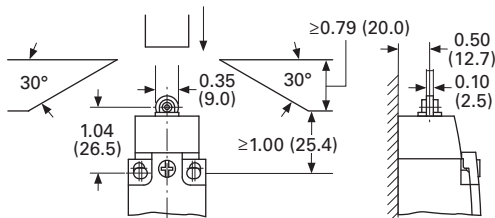

Notes

- ① Tightening torque of cover screws: 0.8 Nm \pm 0.2 Nm.
- ② Only with LS (insulated version).
- ③ Fixing screws 2 x M4 \geq 30
M_A = 1.5 Nm

Approximate Dimensions in Inches (mm)

Rotary Lever
LS(M)-_RL

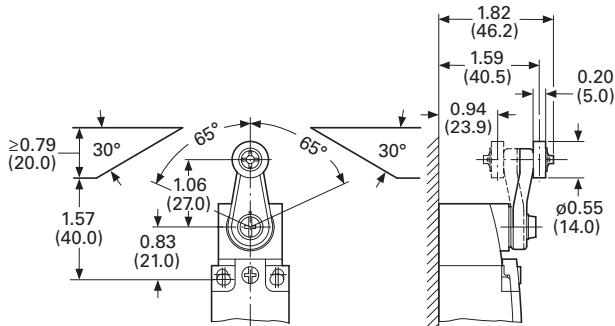

Roller Lever, Short
LS(M)-_LS

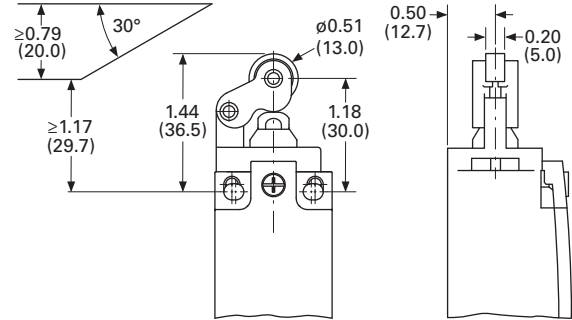

Roller Lever
LS(M)-_L

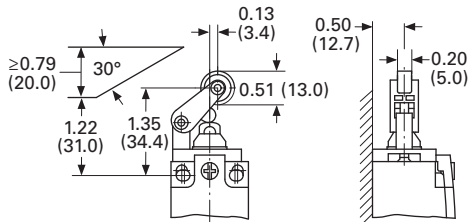

Adjustable Roller Lever
LS(M)-_RLA

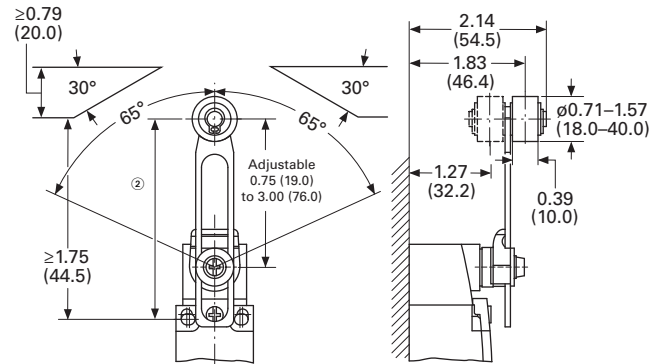

Roller Lever, Large
LS(M)-_LB^①

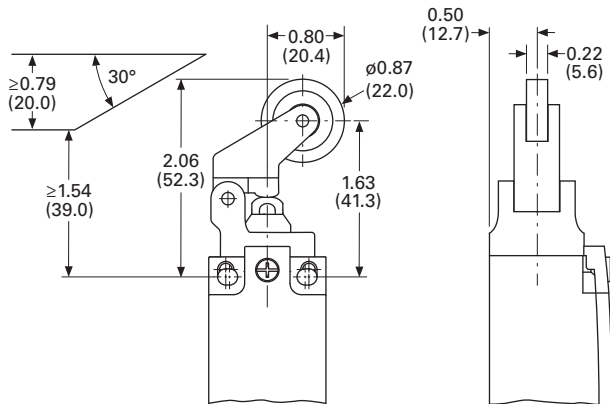

Angled Roller Lever
LS(M)-_XLA

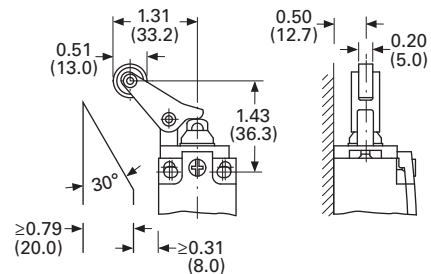

Notes

- ① Tightening torque of cover screws: 0.8 Nm \pm 0.2 Nm.
- ② Setting range of 54.5 to 97.

Approximate Dimensions in Inches (mm)

2

Actuating Rod

LS(M)-_/RR

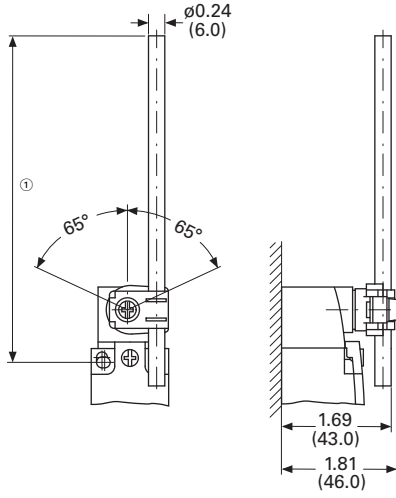

LS(M)-_/OR

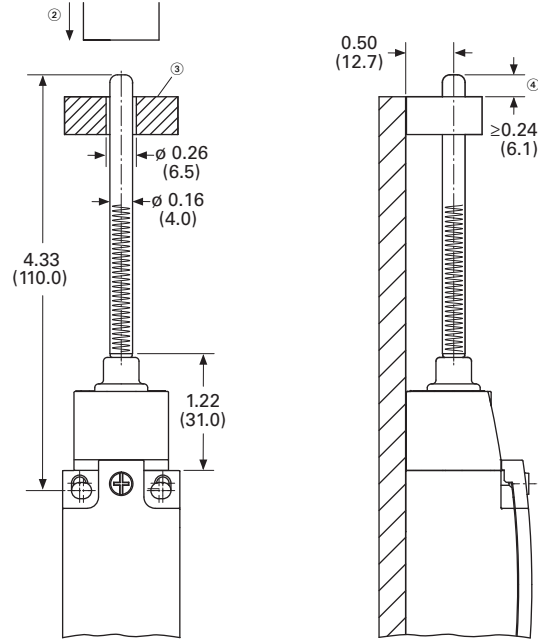

Notes

- ① LS_/RR ≤150
LS_/RRM ≤210
- ② Approach direction, vertical.
- ③ Guide is done by customer, not included.
- ④ Maximum push-through.

E49 Mini Metal Switches



Contents

Description

	<i>Page</i>
E49 Mini Metal Switches	
Product Selection	V8-T2-44
Technical Data and Specifications	V8-T2-46
Dimensions	V8-T2-47



Drawings
Online

E49 Mini Metal Switches

Product Description

E49 Mini Metal Limit Switches from Eaton’s electrical sector are designed small and tough, with machinery OEMs in mind. The small size, metal body and mechanical life make this product perfect for switching applications in packaging, material handling, elevators and lifts, electronic assembly equipment, injection molding machinery, and auto-vending machines. The E49 Mini Metal is the ideal switch for those who need a cost-effective, compact solution, but don’t want to sacrifice durability in the process.

Features

- Long life—rated for 10 million operations
- Pre-wired units with custom cable lengths available for high volume customers
- “Fingerproof” terminals protect against accidental shock
- Double-spring mechanism for contact reliability
- Grounding terminal included
- Captive screws on enclosure cover make wiring hassle-free
- SPDT double break

Standards and Certifications

- UL Recognized
- CE
- RoHS



⚠ DANGER

THIS SENSOR IS NOT A SAFETY DEVICE AND IS NOT INTENDED TO BE USED AS A SAFETY DEVICE. This sensor is designed only to detect and read certain data in an electronic manner and perform no use apart from that, specifically no safety-related use. This sensor product does not include self-checking redundant circuitry, and the failure of this sensor product could cause either an energized or de-energized output condition, which could result in death, serious bodily injury, or property damage.

For the most current information on this product, visit our Web site: www.eaton.com

For Customer Service in the U.S. call 1-877-ETN CARE (386-2273), in Canada call 1-800-268-3578. For Application Assistance in the U.S. and Canada call 1-800-426-9184.

Product Selection

2

E49 Mini Metal Switches

<i>Operating Head Type</i>	Travel to Operate Contacts	Travel to Reset Contacts	Total Travel	Force to Operate Contacts	Minimum Return Force	Assembled Unit (Switch Body and Head) 1NO-1NC Contacts Catalog Number
Side Rotary Lever 	Side Rotary Lever					
	20°	12°	70°	750g	100g	E49G31AP3
Adjustable Side Rotary Lever 	Adjustable Side Rotary Lever					
	20°	12°	70°	750g	100g	E49G31UP3
Top Pushbutton 	Top Pushbutton					
	0.06 in (1.5 mm)	0.04 in (1 mm)	0.22 in (5.5 mm)	900g	150g	E49G31BP3
Top Push Roller 	Top Push Roller					
	0.06 in (1.5 mm)	0.04 in (1 mm)	0.22 in (5.5 mm)	900g	150g	E49G31CP3
Top Push Roller (90° Roller) 	Top Push Roller (90° Roller)					
	0.06 in (1.5 mm)	0.04 in (1 mm)	0.22 in (5.5 mm)	900g	150g	E49G31CP3
Adjustable Rod Lever 	Adjustable Rod Lever					
	20°	12°	70°	750g	100g	E49G31DP3

E49 Mini Metal Switches, continued

<i>Operating Head Type</i>	Travel to Operate Contacts	Travel to Reset Contacts	Total Travel	Force to Operate Contacts	Assembled Unit (Switch Body and Head) 1NO-1NC Contacts Catalog Number
Wobble Stick (Nylon Coil) 	Wobble Stick (Nylon Coil)				
	1.18 in (30 mm)	—	—	150g	E49G31NP3
Wobble Stick (Metal Coil) 	Wobble Stick (Metal Coil)				
	1.18 in (30 mm)	—	—	150g	E49G31VP3
Wobble Stick (Metal Rod) 	Wobble Stick (Metal Rod)				
	1.18 in (30 mm)	—	—	150g	E49G31MP3
Wobble Stick (Whisker) 	Wobble Stick (Whisker)				
	1.18 in (30 mm)	—	—	150g	E49G31XM3

Technical Data and Specifications

2

E49 Mini Metal Switches

Description	Specification
Operating speed	0.19 in (5 mm) to 19.7 in/s (50 cm/s)
Operating frequency	120 operations/min
Contact resistance	25M ohms (initial)
Insulation resistance	100M ohms min (at 500 Vdc)
Dielectric strength	1000 Vac, 50/60 Hz for one minute between non-continuous terminals
	1500 Vac, 50/60 Hz for one minute between current-carrying and non-current-carrying parts and between each terminal and ground
Vibration	10 to 55 Hz, 1.5 mm double amplitude
Shock	Approx. 300 m/s ² (approx. 30Gs)
Ambient operating temperature	23° to 149°F (-5° to 65°C)
Humidity	95% RH max.
Service life	Mechanical: 10,000,000 operations min.
	Electrical: 500,000 operations min.
Weight	Approx. 130 to 190g
Degree of protection	IEC: IP65
Material of construction	Shaft: stainless SUS303 Arm: stainless SUS304 Head and body: zinc alloy Terminal cover: PC/ABS plastic Rubber grommet: NBR rubber

Maximum Ampere Ratings

Rated Voltage	Non-Inductive Load (A)				Inductive Load (A) ^①			
	Resistive Load		Lamp Load ^②		Inductive Load		Motor Load	
	NC	NO	NC	NO	NC	NO	NC	NO
125 Vac	5	5	1.5	0.7	3	3	2	1
250 Vac	5	5	1	0.5	3	3	1.5	0.8
8 Vdc	5	5	3	3	5	4	3	3
14 Vdc	5	5	3	3	4	4	3	3
30 Vdc	5	5	3	3	4	4	3	3
125 Vdc	0.4	0.4	—	—	—	—	—	—
250 Vdc	0.2	0.2	—	—	—	—	—	—

Terminal Configuration

NO (4) —○ ○— NO (3)

NC (1) —● ●— NC (2)

Notes

- ^① Inductive load has a power factor of 0.4 min. (AC) and a time constant of 7 msec. max. (DC).
^② Lamp load has an inrush current of ten times the steady-state current, while motor load has an inrush current of six times the steady-state current.

E49 Mini Metal Switches

Dimensions

Approximate Dimensions in Inches (mm)

E49G31AP3

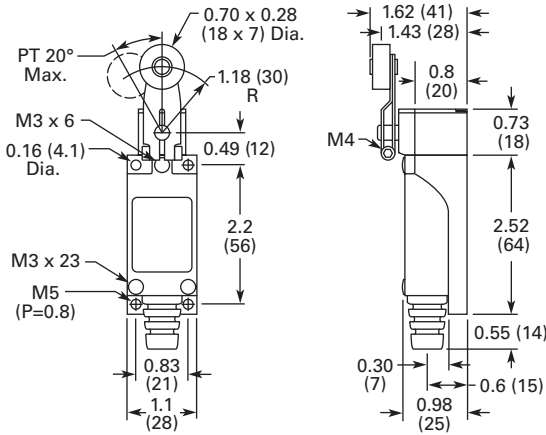

E49G31CP3

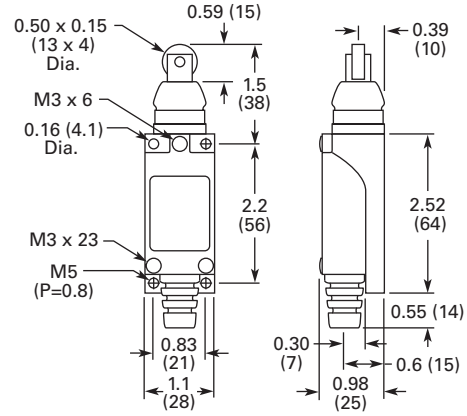

E49G31BP3

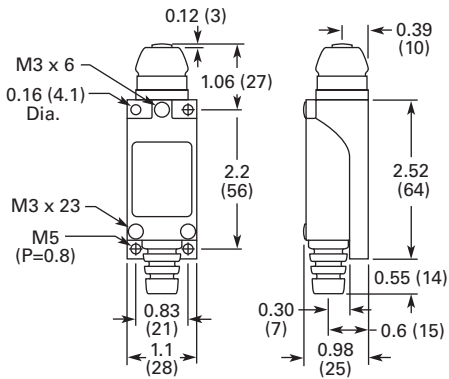

E49G31DP3

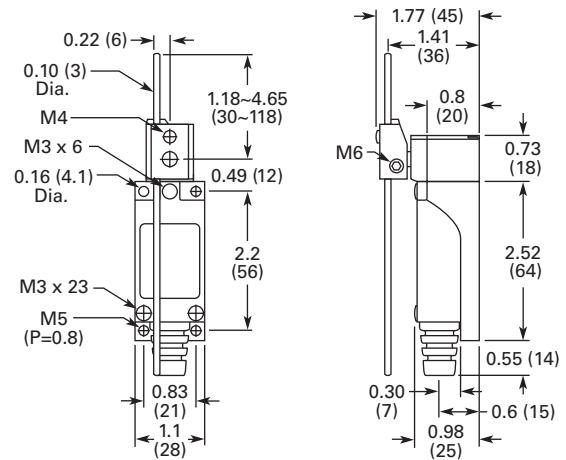

E49G31C1P3

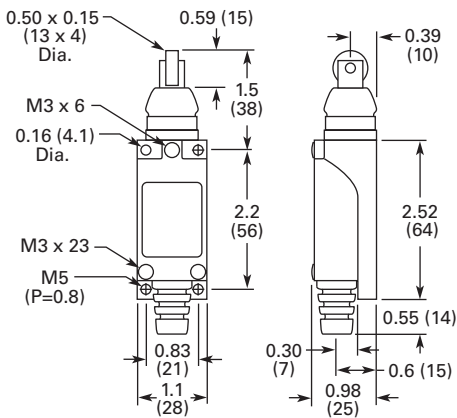

E49G31MP3

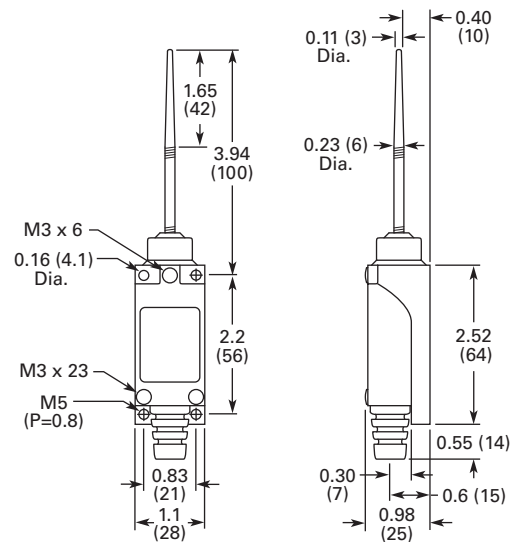

2.4

Limit Switches

E49 Mini Metal Switches

Approximate Dimensions in Inches (mm)

2

E49G31NP3

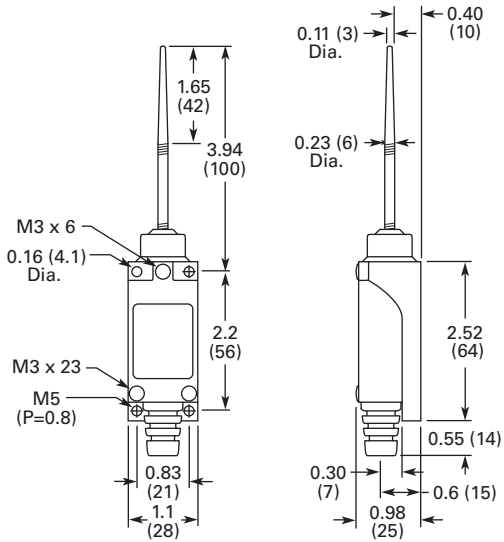

E49G31VP3

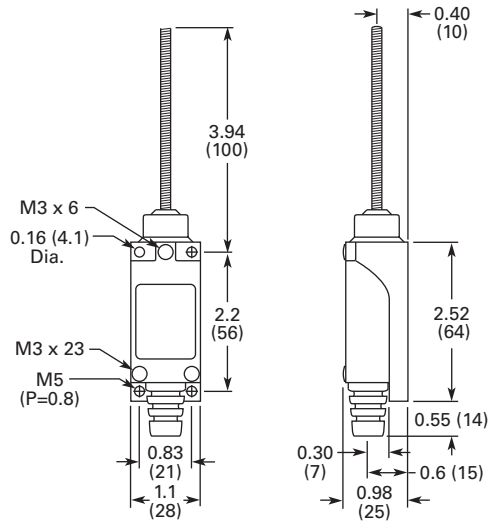

E49G31UP3

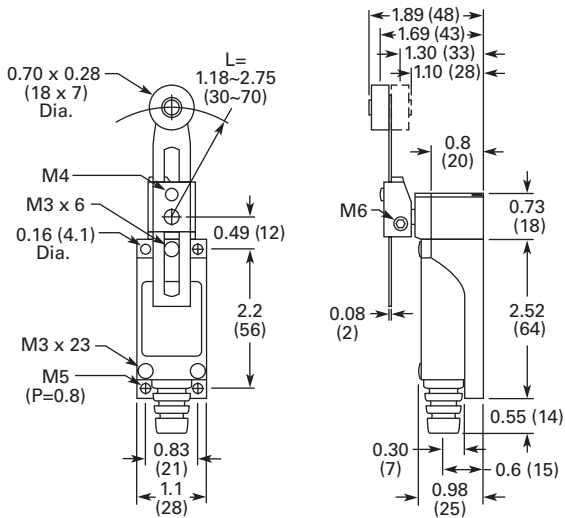

E49G31XM3

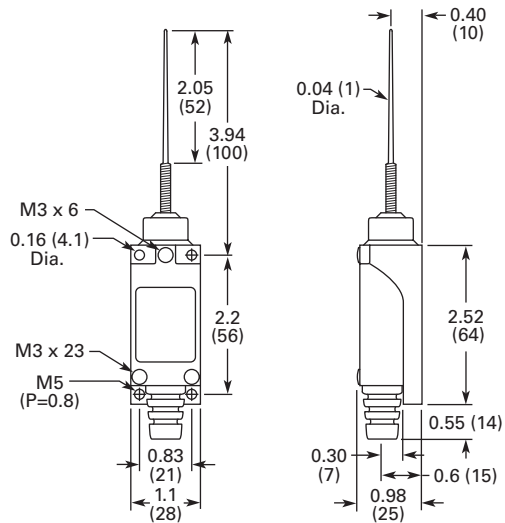

E49 Compact Metal Switches



Contents

Description

	<i>Page</i>
E49 Compact Metal Switches	
Product Selection	V8-T2-50
Technical Data and Specifications	V8-T2-52
Dimensions	V8-T2-53



Drawings
Online

E49 Compact Metal Switches

Product Description

E49 Compact Metal Switches by Eaton's electrical sector are designed with high mechanical strength for robust environments. The rugged aluminum die cast construction provides reliable, oil-tight, waterproof and dustproof sealing for a variety of applications. Snap action 1NO-1NC contacts provide flexibility in design.

Features

- Rigid die cast switch housing
- High mechanical strength
- Oil-tight, waterproof and dustproof construction

Standards and Certifications

- cULus
- NEMA A600 (AC-15)
- NEMA R300 (DC-13)
- IP67
- RoHS



⚠ DANGER

THIS SENSOR IS NOT A SAFETY DEVICE AND IS NOT INTENDED TO BE USED AS A SAFETY DEVICE. This sensor is designed only to detect and read certain data in an electronic manner and perform no use apart from that, specifically no safety-related use. This sensor product does not include self-checking redundant circuitry, and the failure of this sensor product could cause either an energized or de-energized output condition, which could result in death, serious bodily injury, or property damage.

For the most current information on this product, visit our Web site: www.eaton.com

For Customer Service in the U.S. call 1-877-ETN CARE (386-2273), in Canada call 1-800-268-3578. For Application Assistance in the U.S. and Canada call 1-800-426-9184.



Product Selection

2

E49 Compact Metal Switches

<i>Operating Head Type</i>	Travel to Operate Contacts	Travel to Reset Contacts	Total Travel	Force to Operate Contacts (Maximum)	Minimum Return Force	Assembled Unit (Switch Body and Head) 1NO-1NC Contacts Catalog Number
Roller Lever 	Roller Lever 20°	12°	50°	2.99 lbs	0.50 lb	E49M11AP1
Top Push 	Top Push 0.067 in (1.7 mm)	0.04 in (1.0 mm)	—	6.02 lbs	2.01 lbs	E49M11BP1
Top Push Roller 	Top Push Roller 0.067 in (1.7 mm)	0.04 in (1.0 mm)	0.25 in (6.5 mm)	6.02 lbs	2.01 lbs	E49M11CP1 (as pictured)
						E49M11CP2 90° Cross Roller
Rod Lever 	Rod Lever 20°	12°	50°	0.31 lb	0.06 lb	E49M11DP1

E49 Compact Metal Switches, continued

<i>Operating Head Type</i>	Travel to Operate Contacts	Travel to Reset Contacts	Total Travel	Force to Operate Contacts (Maximum)	Minimum Return Force	Assembled Unit (Switch Body and Head) 1NO-1NC Contacts Catalog Number
Adjustable Roller Lever 	Adjustable Roller Lever					
	20°	12°	50°	2.99 lbs	0.50 lb	E49M11UP1
Wobble 	Wobble					
	1.10 in (28 mm)	N/A	N/A	0.33 lb	N/A	E49M11VP1
Cat Whisker 	Cat Whisker					
	1.10 in (28 mm)	N/A	N/A	0.064 lb	N/A	E49M11XM1

Technical Data and Specifications

E49 Compact Metal Switches

2

Description	Specification
Operating speed	1 mm to 2m/sec
Operating frequency	Mechanically: 120 operations/min.; Electronically: 30 operations/min.
Contact resistance	15M ohms max. (initial)
Insulation resistance	100M ohms min. (at 500 Vdc)
Dielectric strength	1000 Vac, 50/60 Hz for 1 minute between non-continuous terminals; 2200 Vac, 50/60 Hz for 1 minute between each terminal and non-current carrying metal part and between each terminal and ground
Vibration	Malfunction durability: approx. 1000 m/sec ² (approx. 100 Gs); Malfunction durability: approx. 300/sec ² (30 Gs)
Ambient operating temperature	14° to 176°F (–10° to 80°C)
Humidity	95% RH max.
Service life	Mechanically: 15,000,000 operations/minute; Electronically: 500,000 operations/minute

Maximum Ampere Ratings—Isolated Contacts, No Polarity Restriction

NEMA A600 (AC-15) 50 or 60 Hz

Rated Voltage	Current			Voltamperes		NEMA R300 (DC-13)	
	Continuous	Make	Break	Make	Break	Rated Voltage	Current
24 Vac	10A	60A	6.0A	7200 VA	720 VA	24 Vdc	1.5A
120 Vac	10A	60A	6.0A	7200 VA	720 VA	120 Vdc	0.22A
250 Vac	10A	30A	3.0A	7200 VA	720 VA	250 Vdc	0.11A
480 Vac	10A	15A	1.5A	7200 VA	720 VA		
600 Vac	10A	12A	1.2A	7200 VA	720 VA		

Dimensions

Approximate Dimensions in Inches (mm)

Switch Body with E49M11BP1

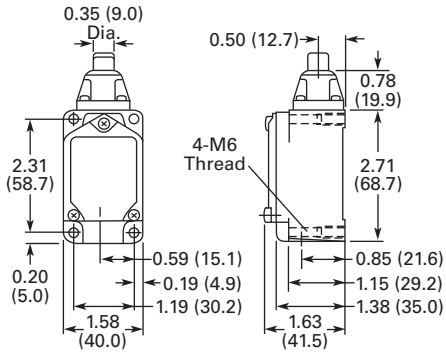

E49M11UP1

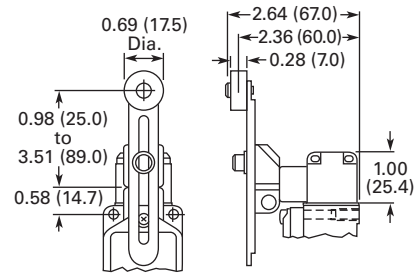

E49M11CP1/E49M11CP2

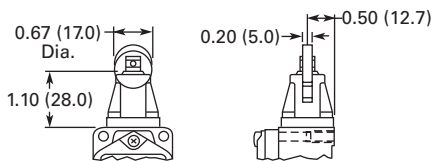

E49M11VP1

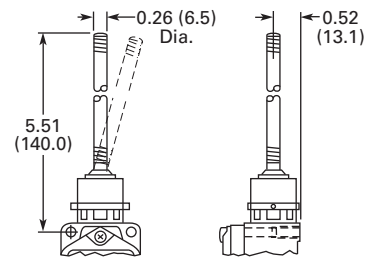

E49M11DP1

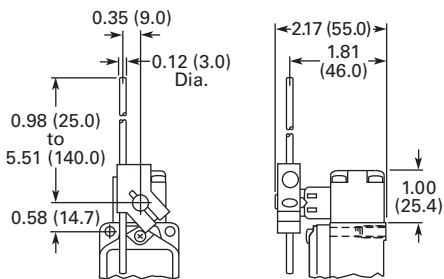

E49M11XM1

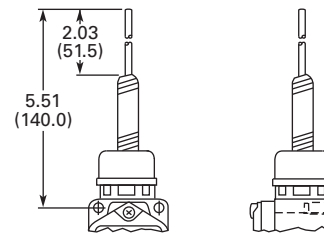

E49M11AP1

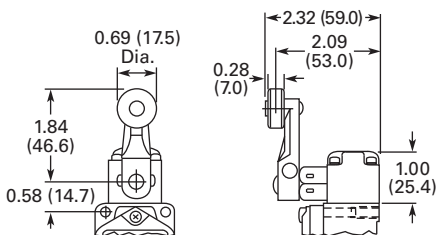

E50 Heavy-Duty Plug-In Switches



E50 Heavy-Duty Plug-In Switches

Product Description

E50 Modular Plug-In Limit Switch Components from Eaton's electrical sector are the industry standard with versatility of design and high reliability for low maintenance, installation and inventory costs. Standard Viton gaskets, seals and boots and a zinc die cast enclosure provide exceptional chemical resistance to the common coolants, cleansing agents, and hydraulic fluids found in machine tool, automotive, waste water treatment and other heavy-duty industrial applications. Mounting dimensions accommodate both U.S. and DIN standards for easy retrofit installations. Super bright 24–120 Vac/dc LED indicating light versions simplify setup and troubleshooting operations.

Features

- Modular, plug-in components (head, body and receptacle) provide application flexibility, reduced inventory and less downtime
- Manufactured to take the physical and environmental abuse (including cutting fluids and chemicals) of harsh industrial environments
- Chemical resistant Viton gaskets, seals and boots are standard, and so are captive, posi-drive screws
- The switches have terminal identification on the nameplate for a visual wiring checkout without guesswork. Heads and switch bodies can be replaced without rewiring
- E50 devices can be ordered in separate components or as complete assembled switches
- 600V rating, ridge-topped contacts and wiping action assure continuity even to logic level circuits
- Keyed, four direction head positioning
- Standard 5° pre-travel and 90° total travel
- 24–120 Vac/dc LED and 120 Vac neon indicating lights available
- Rotary heads are field convertible CW, CCW, or both, without special tools
- Epoxy filled, pin connector or pigtail pin connector receptacles available

Standards and Certifications

- UL Listed
- CSA Certified
- IEC.9475.1
- TUV—E9271605E02
- CE (where shown)



⚠ DANGER

THIS SENSOR IS NOT A SAFETY DEVICE AND IS NOT INTENDED TO BE USED AS A SAFETY DEVICE. This sensor is designed only to detect and read certain data in an electronic manner and perform no use apart from that, specifically no safety-related use. This sensor product does not include self-checking redundant circuitry, and the failure of this sensor product could cause either an energized or de-energized output condition, which could result in death, serious bodily injury, or property damage.

Contents

Description

Page

E50 Heavy-Duty Plug-In Switches	
Product Selection	
Assembled Switches—Standard	V8-T2-55
Assembled Switches—Special Purpose	V8-T2-58
Operating Heads	V8-T2-59
Switch Bodies	V8-T2-60
Receptacles	V8-T2-61
Compatible Connector Cables	V8-T2-62
Accessories	V8-T2-62
Technical Data and Specifications	V8-T2-64
Circuit Diagrams	V8-T2-65
Wiring Diagrams	V8-T2-65
Dimensions	V8-T2-66



Drawings
Online

For the most current information on this product, visit our Web site: www.eaton.com

For Customer Service in the U.S. call 1-877-ETN CARE (386-2273), in Canada call 1-800-268-3578.
For Application Assistance in the U.S. and Canada call 1-800-426-9184.

Product Selection

Assembled Switches—Standard

Assembled Switch E50 Heavy-Duty Plug-In Switches, Assembled—Standard

Assembled Switch



Single-Pole (5 Terminal Receptacle)

Two-Pole (9 Terminal Receptacle)

Indicating Light:	None	LED (24–120 Vac/dc)	Neon (120 Vac)	None	LED (24–120 Vac/dc)	Neon (120 Vac)	LED (24–120 Vac/dc)	Neon (120 Vac)
Switch Body:	E50SA	E50SAL	E50SAN	E50SB	E50SBL	E50SBN	E50SCL	—
Receptacle: ①	1NO-1NC	1NO-1NC	1NO-1NC	2NO-2NC	2NO-2NC	2NO-2NC	1NO-2NC	E50RB

Operating Head Type ②

Side Rotary



Description	Assembled Switch (Head + Receptacle + Body) Catalog Number			Assembled Switch (Head + Receptacle + Body) Catalog Number				
Side Rotary (requires an operating lever, see Page V8-T2-80)								
Standard spring return—E50DR1 ③	E50AR1	E50ALR1	E50ANR1	E50BR1	E50BLR1	E50BNR1	—	—
Low force spring return—E50DL1 ③	E50AL1	E50ALL1	E50ANL1	E50BL1	E50BLL1	E50BNL1	—	—
Maintained two-position—E50DM1	E50AM1	E50ALM1	E50ANM1	E50BM1	E50BLM1	E50BNM1	—	—
Side Pushbutton								
Spring return—E50DS1	E50AS1	E50ALS1	E50ANS1	E50BS1	E50BLS1	E50BNS1	E50CLS1	—
Adjustable Spring Return	E50AS2	E50ALS2	E50ANS2	E50BS2	E50BLS2	E50BNS2	E50BLS2	E50CNS2

Spring Return



Adjustable Spring Return



Circuit Diagrams, see Page V8-T2-65.

Notes

① Connection options (add the code suffix from the table below to the end of the catalog number):

Option		Mating Cordset Catalog Number	Code Suffix
Mini-connector ④ (with epoxy filled receptacle)	Single-pole (5-pin mini-connector)	CSMS5D5CY1602	P5 ⑤
	Two-pole (9-pin mini-connector)	CSMS9D9CY1602	P9 ⑤
Micro-connector ④ (with epoxy filled receptacle)	Single-pole (5-pin micro-connector)	CSDS5A5CY2202	A5 ⑤
	8 ft cable length	—	S
	12 ft cable length	—	S12
Cable connection (with epoxy filled receptacle)	20 ft cable length	—	S20
	Manifold mount (rear wiring entrance)	—	M
20 mm conduit entrance	—	—	20

② For operating head specifications, see Page V8-T2-59.

③ CW (clockwise) and CCW (counterclockwise) operation, easily convertible to CW only or CCW only operation.

④ For a full selection of cable connectors, see Tab 10, section 10.1.

⑤ Refer to Page V8-T2-65 for wiring diagrams.

Assembled Switch

E50 Heavy-Duty Plug-In Switches, Assembled—Standard, continued



Single-Pole (5 Terminal Receptacle)

Two-Pole (9 Terminal Receptacle)

Indicating Light:	None	LED (24–120 Vac/dc)	Neon (120 Vac)	None	LED (24–120 Vac/dc)	Neon (120 Vac)	LED (24–120 Vac/dc)	Neon (120 Vac)
Switch Body:	E50SA 1NO-1NC	E50SAL 1NO-1NC	E50SAN 1NO-1NC	E50SB 2NO-2NC	E50SBL 2NO-2NC	E50SBN 2NO-2NC	E50SCL 1NO-2NC	—
Receptacle: ①	E50RA	E50RA	E50RA	E50RB	E50RB	E50RB	E50RB	E50RB
Description	Assembled Switch (Head + Receptacle + Body) Catalog Number			Assembled Switch (Head + Receptacle + Body) Catalog Number				

Operating Head Type ②

Side Push Roller



Side Push Roller

Spring return— E50DS3 ③	E50AS3 CE	E50ALS3	E50ANS3	E50BS3	E50BLS3	E50BNS3	E50BLS3	—
----------------------------	--------------	---------	---------	--------	---------	---------	---------	---

Side Pushbutton



Side Pushbutton

Maintained— E50DH1	E50AH1 CE	E50ALH1	E50ANH1	E50BH1	E50BLH1	E50BNH1	E50BLH1	—
-----------------------	--------------	---------	---------	--------	---------	---------	---------	---

Top Pushbutton

Spring Return



Spring return— E50DT1	E50AT1 CE	E50ALT1	E50ANT1	E50BT1	E50BLT1	E50BNT1	E50CLT1	E50BNT1
--------------------------	--------------	---------	---------	--------	---------	---------	---------	---------

Adjustable Spring Return



Adjustable spring return—E50DT2	E50AT2 CE	E50ALT2	E50ANT2	E50BT2	E50BLT2	E50BNT2	—	—
------------------------------------	--------------	---------	---------	--------	---------	---------	---	---

Circuit Diagrams, see **Page V8-T2-65**.

Notes

① Connection options (add the code suffix from the table below to the end of the catalog number):

Option		Mating Cordset Catalog Number	Code Suffix
Mini-connector ④ (with epoxy filled receptacle)	Single-pole (5-pin mini-connector)	CSMS5D5CY1602	P5 ⑤
	Two-pole (9-pin mini-connector)	CSMS9D9CY1602	P9 ⑤
Micro-connector ④ (with epoxy filled receptacle)	Single-pole (5-pin micro-connector)	CSDS5A5CY2202	A5 ⑤
Cable connection (with epoxy filled receptacle)	8 ft cable length	—	S
	12 ft cable length	—	S12
	20 ft cable length	—	S20
Manifold mount (rear wiring entrance)		—	M
20 mm conduit entrance		—	20

② For operating head specifications, see **Page V8-T2-59**.

③ Roller can be converted in the field between horizontal and vertical.

④ For a full selection of cable connectors, see **Tab 10, section 10.1**.

⑤ Refer to **Page V8-T2-65** for wiring diagrams.

E50 Heavy-Duty Plug-In Switches, Assembled—Standard, continued

Assembled Switch



Single-Pole (5 Terminal Receptacle)

Two-Pole (9 Terminal Receptacle)

Indicating Light:	None	LED (24–120 Vac/dc)	Neon (120 Vac)	None	LED (24–120 Vac/dc)	Neon (120 Vac)	LED (24–120 Vac/dc)	Neon (120 Vac)
Switch Body:	E50SA 1NO-1NC	E50SAL 1NO-1NC	E50SAN 1NO-1NC	E50SB 2NO-2NC	E50SBL 2NO-2NC	E50SBN 2NO-2NC	E50SCL 1NO-2NC	—
Receptacle: ①	E50RA	E50RA	E50RA	E50RB	E50RB	E50RB	E50RB	E50RB
Description	Assembled Switch (Head + Receptacle + Body) Catalog Number			Assembled Switch (Head + Receptacle + Body) Catalog Number				

Operating Head Type ②

Top Push Roller



Description	Top Push Roller							
Spring return E50DT3 ③	E50AT3 CE	E50ALT3	E50ANT3	E50BT3	E50BLT3	E50BNT3	—	—

Wobble Head, Spring Return



Description	Wobble Head, Spring Return (requires a wobble operator, see Page V8-T2-80)							
Standard duty— E50DW1	E50AW1 CE	E50ALW1	E50ANW1	E50BW1	E50BLW1	E50BNW1	E50CLW1	—
Heavy-duty high strength steel— E50DW2	E50AW2 CE	E50ALW2	E50ANW2	E50BW2	E50BLW2	E50BNW2	E50CLW2	E50BNW2

Circuit Diagrams, see Page V8-T2-65.

Notes

① Connection options (add the code suffix from the table below to the end of the catalog number):

Option		Mating Cordset Catalog Number	Code Suffix
Mini-connector ④ (with epoxy filled receptacle)	Single-pole (5-pin mini-connector)	CSMS5D5CY1602	P5 ⑤
	Two-pole (9-pin mini-connector)	CSMS9D9CY1602	P9 ⑤
Micro-connector ④ (with epoxy filled receptacle)	Single-pole (5-pin micro-connector)	CSDS5A5CY2202	A5 ⑤
Cable connection (with epoxy filled receptacle)	8 ft cable length	—	S
	12 ft cable length	—	S12
	20 ft cable length	—	S20
Manifold mount (rear wiring entrance)		—	M
20 mm Conduit Entrance		—	20

② For operating head specifications, see Page V8-T2-59.

③ Roller can be converted in the field between horizontal and vertical.

④ For a full selection of cable connectors, see Tab 10, section 10.1.

⑤ Refer to Page V8-T2-65 for wiring diagrams.

Assembled Switches—Special Purpose

2

E50 Heavy-Duty Plug-In Switches, Assembled—Special Purpose

Operating Data— Nominal Switches	Assembled Switch Catalog Number	Switch Body Only Catalog Number	Receptacle Only Catalog Number	Operating Head Only Catalog Number
Neutral Position	Neutral Position (requires an operating lever, see Page V8-T2-80)			
5° Travel	E50NN1 ①	E50SN	E50RB	E50DN1 ①
5° Travel; stainless steel shaft	E50NN1SPL ②	—	—	—
15° Travel	E50NN2	E50SN	E50RB	E50DN2 ①
Travel to operate contacts:	—	—	—	5° or 15° ③
Travel to reset contacts:	—	—	—	2°
Total travel:	—	—	—	90°
Force to operate contacts:	—	—	—	1.8 in-lbs
Minimum return force:	—	—	—	2.5 in-oz
Operating temperature:	—	—	—	14° to 200°F (–10° to 94°C)
Two-Step	Two-Step CW, CCW, or both, Convertible (requires an operating lever, see Page V8-T2-80)			
—	E50TD1	E50ST	E50RB	E50DD1
Travel to operate contacts:	—	—	—	1st step 10°; 2nd step 20° 4° each
Travel to reset contacts:	—	—	—	90°
Total travel:	—	—	—	3 in-lbs
Force to operate contacts:	—	—	—	4.5 in-oz
Minimum return force:	—	—	—	CW or CCW: 14° to 250°F (–10° to 121°C)
Operating temperature:	—	—	—	CW and CCW: 14° to 200°F (–10° to 94°C)
Gravity Return	Gravity Return (requires E50KL220, E50KL226 or equivalent operating lever, see Page V8-T2-80)			
Without indicating light	E50GG1	E50SG	E50RA	E50DG1
With LED indicating light (24–120 Vac/dc)	E50GLG1	E50SGL	E50RA	E50DG1
With neon indicating light (120 Vac)	E50GNG1	E50SGN	E50RA	E50DG1
Travel to operate contacts:	—	—	—	10° to 170°
Travel to reset contacts:	—	—	—	8°
Total travel:	—	—	—	360°
Force to operate contacts:	—	—	—	3.0 in-oz
Minimum return force:	—	—	—	Gravity
Operating temperature:	—	—	—	14° to 200°F (–10° to 94°C)

Circuit Diagrams, see [Page V8-T2-65](#).**Notes**







- ① Add **9** suffix to the model number for low temperature –40° to 174°F (–40 to 79°C) versions.
- ② Low temperature rating –40° to 174°F (–40° to 79°C)
- ③ Depending upon model selected.

E50 Heavy-Duty Plug-In Switches

Operating Heads

E50 Heavy-Duty Plug-In Switches, Operating Heads

2

Description	Travel to Operate Contacts	Travel to Reset Contacts	Total Travel	Force to Operate Contacts	Minimum Return Force	Operating Temperature ^①		Catalog Number
						Without Cable	With Pre-Wired Cable	
Side Rotary	Side Rotary (requires an operating lever, see Page V8-T2-80)							
 Standard spring return ^②	5°	2°	90°	3 in-lbs	4.5 in-oz	10° to 200°F (-12° to 94°C) ^③	10° to 200°F (-12° to 94°C) ^③	E50DR1
Low temperature spring return ^②	5°	2°	90°	3 in-lbs	4.5 in-oz	-40° to 175°F (-40° to 79°C)	-31° to 175°F (-34° to 79°C)	E50DR19
Low force spring return ^②	15°	6°	90°	1.5 in-lbs	2.5 in-oz	10° to 200°F (-12° to 94°C) ^③	10° to 200°F (-12° to 94°C) ^③	E50DL1
Maintained two-position	50°	50°	90°	3 in-lbs	—	14° to 200°F (-10° to 94°C)	14° to 200°F (-10° to 94°C)	E50DM1
Spring Return	Side Pushbutton							
 Spring return	0.065 in	0.030 in	0.250 in	4 lbs	8 oz	14° to 200°F (-10° to 94°C)	14° to 200°F (-10° to 94°C)	E50DS1
Adjustable Spring Return	Adjustable Spring Return							
 Adjustable spring return	0.065 in	0.030 in	0.250 in	4 lbs	8 oz	14° to 200°F (-10° to 94°C)	14° to 200°F (-10° to 94°C)	E50DS2
Side Push Roller	Side Push Roller							
 Spring return ^④	0.065 in	0.030 in	0.250 in	4 lbs	8 oz	14° to 200°F (-10° to 94°C)	14° to 200°F (-10° to 94°C)	E50DS3 ^⑤
	0.065 in	0.030 in	0.250 in	4 lbs	8 oz	14° to 200°F (-10° to 94°C)	14° to 200°F (-10° to 94°C)	E50DS4 ^⑤
Side Pushbutton	Side Pushbutton							
 Maintained	0.200 in	0.130 in	0.320 in	5 lbs	5 lbs	14° to 200°F (-10° to 94°C)	14° to 200°F (-10° to 94°C)	E50DH1
Spring Return	Top Pushbutton							
 Spring return	0.040 in	0.020 in	0.280 in	4 lbs	8 oz	14° to 250°F (-10° to 121°C)	14° to 221°F (-10° to 105°C)	E50DT1
Adjustable Spring Return	Adjustable Spring Return							
 Adjustable spring return	0.040 in	0.020 in	0.280 in	4 lbs	8 oz	14° to 250°F (-10° to 121°C)	14° to 221°F (-10° to 105°C)	E50DT2

Notes

- ① Temperature ranges below 32°F (0°C) are based on absence of freezing moisture or water.
- ② CW (clockwise) and CCW (counterclockwise) operation, easily convertible to CW only or CCW only operation.
- ③ For CW and CCW operation. For CW only or CCW only operation, high temperature limit increases to 250°F (121°C) without cable, and 221°F (105°C) with pre-wired cable.
- ④ Roller can be converted in the field between horizontal and vertical.
- ⑤ Roller shaft is 0.38 in (9.5 mm) longer on E50DS4, see Dimensions on [Page V8-T2-66](#).

E50 Heavy-Duty Plug-In Switches, Operating Heads, continued

Description	Travel to Operate Contacts	Travel to Reset Contacts	Total Travel	Force to Operate Contacts	Minimum Return Force	Operating Temperature ^①		Catalog Number
						Without Cable	With Pre-wired Cable	
Top Push Roller								
Top Push Roller								
Spring return	0.040 in	0.020 in	0.280 in	4 lbs	8 oz	14° to 250°F (-10° to 121°C)	14° to 221°F (-10° to 105°C)	E50DT3
Wobble Head, Spring Return								
Wobble Head, Spring Return (requires a wobble operator, see Page V8-T2-80)								
Standard duty	10°	6°	15°	2 in-lbs	2.4 in-oz	14° to 250°F (-10° to 121°C)	14° to 221°F (-10° to 105°C)	E50DW1
Heavy-duty high strength steel	10°	6°	15°	2 in-lbs	2.4 in-oz	14° to 250°F (-10° to 121°C)	14° to 221°F (-10° to 105°C)	E50DW2

Switch Bodies

E50 Heavy-Duty Plug-In Switches, Switch Bodies



Switch Body Construction ^①	Single-Pole 1NO-1NC Catalog Number	Two-Pole 2NO-2NC Parallel Wired Indicator Light Catalog Number	Two-Pole 2NC-1NO Series Wired Indicator Light Catalog Number
Without indicating light	E50SA CE	E50SB	—
With LED indicating light 24–120 Vac/dc	E50SAL	E50SBL	E50SCL
With neon indicating light 120 Vac	E50SAN	E50SBN	—





Circuit Diagrams, see **Page V8-T2-65**.

Note

^① Indicating lights are supplied from the factory wired as shown in Circuit Diagrams on **Page V8-T2-65**. However, they can be easily re-connected to terminals 1 and 2 if necessary (SPDT).

Receptacles

E50 Heavy-Duty Plug-In Switches, Receptacles

	Description	Poles	Conduit Entrance	Cable Length	Catalog Number
Surface Mount 	Surface Mount Conduit entrance, front or rear mounting	Single-pole (5 terminal)	1/2 NPT	—	E50RA
			20 mm	—	E50RA20
		Two-pole (9 terminal)	1/2 NPT	—	E50RB
			3/4 NPT	—	E50RB34
			20 mm	—	E50RB20
Manifold Mount 	Manifold Mount Rear wiring entrance instead of conduit hole, gasket on back for oil tightness	Single-pole (5 terminal)	—	—	E50RAM
		Two-pole (9 terminal)	—	—	E50RBM
Mini-Connector 	Mini-Connector Epoxy filled receptacle with pre-wired mini-connector. (The -W version is a wiring scheme typically used in automotive applications.)	Single-pole (5 terminal)	5-pin mini-connector	—	E50RAP5 Ⓢ
				—	E50RAP5-W Ⓢ
		Two-pole (9 terminal)	9-pin mini-connector	—	E50RBP9 Ⓢ
Micro-Connector 	Micro-Connector Epoxy filled receptacle with M12 DC micro-connector	Single-pole (5 terminal)	—	—	E50RAA5 ①
Pre-Wired Cable 	Pre-Wired Cable Epoxy filled receptacle with pre-wired 16 gauge, yellow jacketed, type SOOW-A cable. Cable enters through hole threaded for conduit.	Single-pole (5 terminal)	1/2 NPT	8 ft	E50RAS
				12 ft	E50RAS12
				20 ft	E50RAS20
			20 mm	8 ft	E50RA20S
				12 ft	E50RA20S12
				20 ft	E50RA20S20
		Two-pole (9 terminal)	1/2 NPT	8 ft	E50RBS
				12 ft	E50RBS12
			20 mm	20 ft	E50RBS20
				8 ft	E50RB20S
12 ft	E50RB20S12				
20 ft	E50RB20S20				

Wiring Diagrams, see **Page V8-T2-65**.

Notes





Ⓢ See listing of compatible connector cables on **Page V8-T2-62**.

① Model E50RAA5 is not UL listed or CSA certified.

Compatible Connector Cables

2

Standard Cables ^①

	Current Rating at 600V	Voltage Style	Number of Pins	Gauge	Length	Pin Configuration/Wire Colors (Face View Female Shown)	Catalog Number
Mini-style Straight Female 	Mini-Style, Straight Female						
	8A	—	5-pin	16 AWG	6 ft (2m)	 <ul style="list-style-type: none"> 1-White 2-Red 3-Green 4-Orange 5-Black 	CSMS5D5CY1602
	7A	—	9-pin	16 AWG	12 ft (4m)	 <ul style="list-style-type: none"> 1-Orange 2-Blue 3-Red/Black 4-Green/Black 5-White 6-Red 7-Green 8-White/Black 9-Black 	CSMS9D9CY1602
Micro-Style 	Micro-Style						
	4A	—	5-pin, 5-wire	22 AWG	6.0 ft (2m)	 <ul style="list-style-type: none"> 1-Brown 2-White 3-Blue 4-Black 5-Green/Yellow 	CSDS5A5CY2202

Accessories

E50 Heavy-Duty Plug-In Switch Accessories







	Description	Catalog Number
E50KH7 	Adapter Plate	
	Allows E50 to replace Square D Type AW Surface Mounting Non Plug-In Standard Box Limit Switch	E50KH7

Dimensions, see Page V8-T2-67.

Note

① For a full selection of connector cables, see **Tab 10, section 10.1**.

E50 Heavy-Duty Plug-In Switch Accessories, continued

Description	Catalog Number
Adapter Plate, continued	
E50KH4	E50KH4 ①
	Allows E50 to replace National Acme, Type D-1200M, Style 2 Mounting. Denison LoxSwitch, Model L-100W, Style 2 Mounting. Square D 9007 Type T, Style B Mounting. (Adapter plate is 1/8 in thick, with 1/4 in mounting holes.) Namco® long mount.
E50KH5	E50KH5 ①
	Allows E50 to replace National Acme, Type D-1200M, Style 1 Mounting. Denison LoxSwitch, Model L-100W, Style 1 Mounting. Square D 9007 Type T, Style C Mounting. (Adapter plate is 1/8 in thick, with 1/4 in mounting holes.)
E50KH2	E50KH2
	Allows E50 to replace Eaton's 10316 Type LT Non Plug-In Two-Pole Limit Switch
E50KH10	E50KH10
	Allows E50 to replace Allen-Bradley 802M Sealed Limit Switch
Adjustable Mounting Plate	
E50KH3	E50KH3 ①
	This is a mounting plate only 5/16 in thick and includes the proper mounting bolts and nuts. The slots in the plate allow a maximum horizontal adjustment of 1 in and vertical adjustment of 1-1/4 in
E50KH6	E50KH6
	Conduit Sealing Nut 1/2 in oiltight

Dimensions, see **Page V8-T2-67**.

Note

① Limit switch not included.

Technical Data and Specifications

E50 Heavy-Duty Plug-In Switches

Description	Specification
Environmental ratings	NEMA 1, 3, 3S, 4, 4X, 6, 6P, 13, IP67
Material of construction	Zinc die cast
Switch gasket material	Viton
Universal U.S./DIN mounting dimensions	1.16 in (30 mm) x 2.34 in (60 mm)
Conduit entrance	1/2 in NPT or 20 mm threading
Contact ratings	See below
Contact operation	Snap action over center mechanism
Contact material	Fine silver
Maximum frequency of operation	8000 operations per hour
Mechanical life	
Side rotary	13,000,000 operations minimum
Side or top push	10,000,000 operations minimum
Electrical life	
Single-pole	1,000,000 operations typical at full load
Two-pole	100,000 operations typical at full load
Ambient temperature range—standard	
Standard without cable	14° to 250°F (–10° to 121°C)
Standard with cable	14° to 221°F (–10° to 105°C)
Low temperature without cable	–40° to 250°F (–40° to 121°C)
Low temperature with cable	–40° to 221°F (–40° to 105°C)
Repeat accuracy—standard	
Side operated	Within 0.0012 in
Top operated	Within 0.0003 in
Side rotary	Within 0.0014 in
Torque requirements:	
Switch body screws	25–30 lb-in
Operating head screws	14–18 lb-in
Wire size	Will accept AWG #22–#12, single or stranded wire

Electrical Data—Maximum Contact Ratings (Same polarity each pole)

AC Volts	Current, Amperes			Voltamperes		DC Volts	Current, Amperes	
	Make	Break	Cont. ①	Make	Break		Max. Make or Break	Cont. ①
All Switches Except Gravity Return and Indicating Light Versions								
NEMA A600 Rating						NEMA R300		
120	60	6	10	7200	720	125	0.22	1.0
240	30	3	10	7200	720	250	0.11	1.0
480	15	1.5	10	7200	720	250	0.11	1.0
600	12	1.2	10	7200	720	250	0.11	1.0
Switches with Indicating Lights (LED or Neon)								
NEMA A150 Rating						NEMA R150		
120	60	6	10	7200	720	125	0.22	1.0
Gravity Return Switches—Maximum Contact Ratings								
NEMA 6600 Rating—Contacts on same polarity								
120	30	3	5	3600	360	—	—	—
240	15	1.5	5	3600	360	—	—	—
480	7.5	0.75	5	3600	360	—	—	—
600	6	0.60	5	3600	360	—	—	—

Note

① Thermal rating. Valid only if switch does not have to make or break.

Circuit Diagrams

Standard Assembled Switches and Switch Bodies

Single-Pole 1NO-1NC

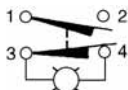

Must be same polarity.

Two-Pole 2NO-2NC

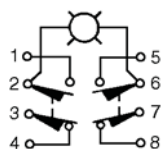

Parallel wired indicator light. Same polarity each pole.

Two-Pole 1NO-2NC

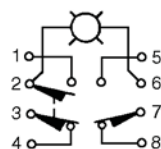

Series wired indicator light. Same polarity each pole.

Special Purpose Assembled Switches

Neutral Position

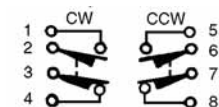

Same polarity, each pole.

Two-Step (CW, CCW, or Both)

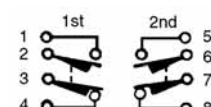

Same polarity, each pole.

Gravity Return



Must be same polarity.

Wiring Diagrams

Receptacles ①

E50RAP5

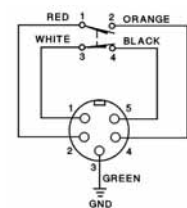

E50RAP5-W

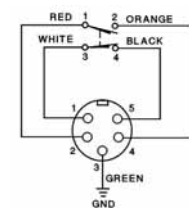

E50RBP9

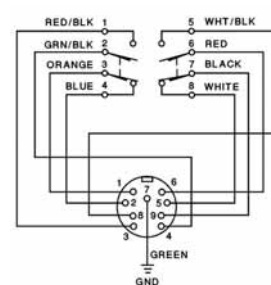

E50RAA5

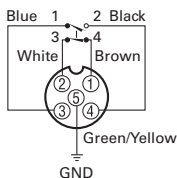

E50RAS_

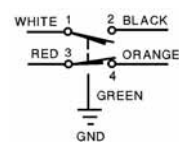

E50RBS_

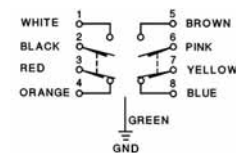

Note

① The wire colors referenced on these diagrams are those internal to the switch itself.

2.6

Limit Switches

E50 Heavy-Duty Plug-In Switches

Dimensions

Approximate Dimensions in Inches (mm)

2

Standard

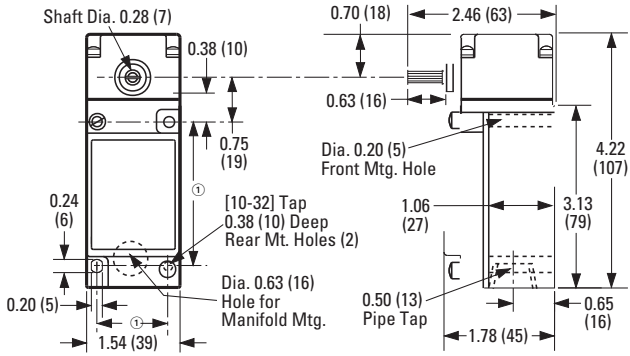

E50SB34

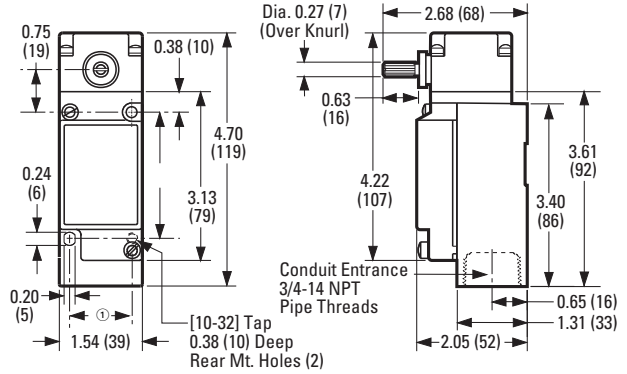

Side Push Operators

Approximate Dimensions in mm [in]

Pushbutton

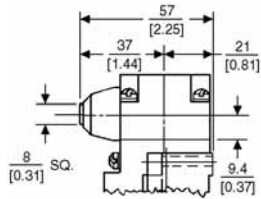

Adjustable Pushbutton

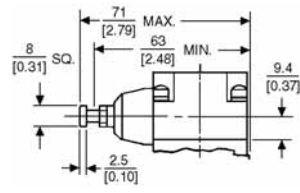

Roller

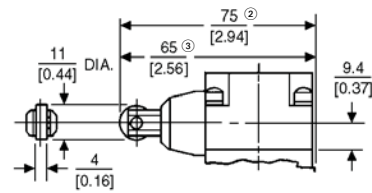

Maintained Pushbutton

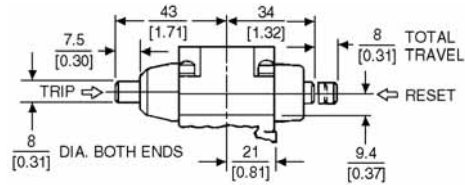

Top Push Operators

Pushbutton

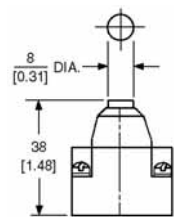

Adjustable Pushbutton

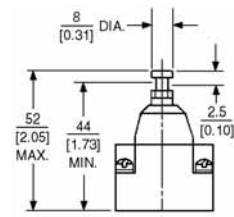

Roller

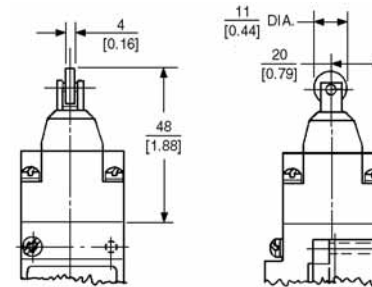

Wobble Operators

See Operators on [Page V8-T2-80](#).

Notes

- Can accommodate both U.S., 1.16 (29.4) x 2.34 (59.5) and DIN, 1.18 (30) x 2.36 (60), mounting dimensions.
- For E50DS4.
- For E50DS3.

Accessories

Approximate Dimensions in mm [in]

Adapter Plates

E50KH1M



E50KH7

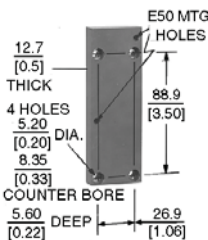

E50KH4

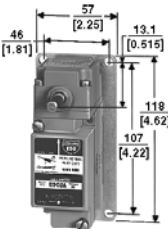

E50KH5

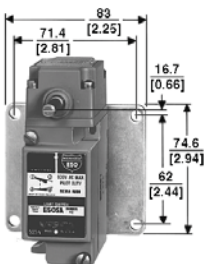

E50KH2

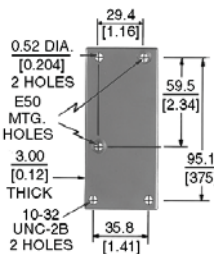

E50KH10

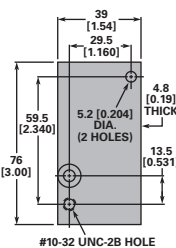

Adjustable Mounting Plate

E50KH3

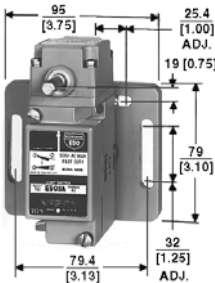

E50 Heavy-Duty Factory Sealed 6P+ Switches



E50 Heavy-Duty Factory Sealed 6P+ Switches

Product Description

E50 6P+ Limit Switches by Eaton's electrical sector were specifically designed to withstand the penetrating properties of cutting fluids and coolants, such as those used in the automotive industry, as well as extreme shock, vibration and temperature fluctuations. The one-piece, epoxy filled switch body is prewired at the factory to ensure leak-proof, submersible performance. This unique construction positively stops fluid from finding its way to any and all critical connections.

Our 6P+ switches can be ordered in separate components or as complete assembled devices. They are available with prewired 16 AWG cables or mini-connectors. Standard and custom cable lengths are available. As part of the E50 line, the 6P+ switches use the same operating heads as the standard E50 plug-in models to reduce the components you need to inventory.

Features

- Manufactured to take the physical and environmental abuse (including cutting fluids and chemicals) of harsh industrial environments
- Modular, plug-in components (head and switch body) provide application flexibility, reduced inventory and less downtime
- Chemical resistant Viton gaskets, seals and boots are standard, and so are captive, posi-drive screws
- A special tertiary seal on the switch body prevents fluid from entering even when the operating head is not attached
- 600V rating, ridge-topped contacts and wiping action assure continuity even to logic level circuits
- Factory wired cable features a 350 pound pullout capacity
- Keyed, four direction head positioning. Standard 5° pre-travel and 90° total travel
- 24–120 Vac/dc LED and 120 Vac neon indicating lights available
- Rotary heads are field convertible CW, CCW, or both, without special tools

Standards and Certifications

- UL Listed
- CSA Certified
- IEC.9475.1
- TUV—E9271605E02
- CE (where shown)



⚠ DANGER

THIS SENSOR IS NOT A SAFETY DEVICE AND IS NOT INTENDED TO BE USED AS A SAFETY DEVICE. This sensor is designed only to detect and read certain data in an electronic manner and perform no use apart from that, specifically no safety-related use. This sensor product does not include self-checking redundant circuitry, and the failure of this sensor product could cause either an energized or de-energized output condition, which could result in death, serious bodily injury, or property damage.

Contents

Description

Page

E50 Heavy-Duty Factory Sealed 6P+ Switches	
Product Selection	
Assembled Switches—Standard	V8-T2-69
Operating Heads	V8-T2-72
Switch Bodies	V8-T2-73
Compatible Connector Cables	V8-T2-74
Accessories	V8-T2-74
Technical Data and Specifications	V8-T2-76
Circuit Diagrams	V8-T2-77
Wiring Diagrams	V8-T2-77
Dimensions	V8-T2-78



Drawings
Online

For the most current information on this product, visit our Web site: www.eaton.com

For Customer Service in the U.S. call 1-877-ETN CARE (386-2273), in Canada call 1-800-268-3578.
For Application Assistance in the U.S. and Canada call 1-800-426-9184.

Product Selection

Assembled Switches—Standard

Connection is by 8 ft cable ①.

Assembled Switch

E50 Heavy-Duty Factory Sealed 6P+ Switches, Assembled—Standard



Lever sold separately



Single-Pole



Two-Pole

Indicating Light:	None	LED (24–120 Vac/dc)	Neon (120 Vac)	None	LED (24–120 Vac/dc)	Neon (120 Vac)
Switch Body:	E50SA6P 1NO-1NC	E50SAL6P 1NO-1NC	E50SAN6P 1NO-1NC	E50SB6P 2NO-2NC	E50SBL6P 2NO-2NC	E50SBN6P 2NO-2NC

Operating Head Type ②

Description

**Assembled Switch
Catalog Number**

**Assembled Switch
Catalog Number**

Side Rotary

Side Rotary (requires an operating lever, see **Page V8-T2-80**)



Standard spring return—E50DR1 ③	E50AR16P CE	E50ALR16P	E50ANR16P	E50BR16P	E50BLR16P	E50BNR16P
Low force spring return—E50DL1 ③	E50AL16P CE	E50ALL16P	E50ANL16P	E50BL16P	E50BLL16P	E50BNL16P
Maintained two-position—E50DM1	E50AM16P CE	E50ALM16P	E50ANM16P	E50BM16P	E50BLM16P	E50BNM16P

Spring Return

Spring return—E50DS1



E50AS16P CE	E50ALS16P	E50ANS16P	E50BS16P	E50BLS16P	E50BNS16P
----------------	-----------	-----------	----------	-----------	-----------

Adjustable Spring Return

Adjustable spring return—E50DS2



E50AS26P CE	E50ALS26P	E50ANS26P	E50BS26P	E50BLS26P	E50BNS26P
----------------	-----------	-----------	----------	-----------	-----------

Circuit Diagrams, see **Page V8-T2-77**.

Notes

① Connection options (add the code suffix from the table below to the end of the catalog number):

Option		Catalog Number	Code Suffix
Mini-connector ④	Single-pole (5-pin mini-connector)	CSMS5D5CY1602	C
	Two-pole (9-pin mini-connector)	CSMS9D9CY1602	C
Cable connection	12 ft cable length (standard)	—	12
	20 ft cable length (standard)	—	20
	Other lengths (special order)	—	Length in ft

② For operating head specifications, see **Page V8-T2-72**.

③ CW (clockwise) and CCW (counterclockwise) operation, easily convertible to CW only or CCW only operation.

④ For a full selection of connector cables, see **Tab 10, section 10.1**.

Connection is by 8 ft cable ①.

2





Assembled Switch E50 Heavy-Duty Factory Sealed 6P+ Switches, Assembled—Standard, continued



Single-Pole



Two-Pole

Operating Head Type ②	Description	Single-Pole			Two-Pole		
		Assembled Switch Catalog Number	LED (24–120 Vac/dc)	Neon (120 Vac)	Assembled Switch Catalog Number	LED (24–120 Vac/dc)	Neon (120 Vac)
Side Push Roller	Side Push Roller						
	Spring return—E50DS3 ③	E50AS36P CE	E50ALS36P	E50ANS36P	E50BS36P	E50BLS36P	E50BNS36P
Side Pushbutton	Side Pushbutton						
	Maintained—E50DH1	E50AH16P CE	E50ALH16P	E50ANH16P	E50BH16P	E50BLH16P	E50BNH16P
Spring Return	Spring return—E50DT1	E50AT16P CE	E50ALT16P	E50ANT16P	E50BT16P	E50BLT16P	E50BNT16P
							
Adjustable Spring Return	Adjustable spring return—E50DT2	E50AT26P CE	E50ALT26P	E50ANT26P	E50BT26P	E50BLT26P	E50BNT26P
							

Circuit Diagrams, see Page V8-T2-77.

Notes

① Connection options (add the code suffix from the table below to the end of the catalog number):

Option		Catalog Number	Code Suffix
Mini-connector ②	Single-pole (5-pin mini-connector)	CSMS5D5CY1602	C
	Two-pole (9-pin mini-connector)	CSMS9D9CY1602	C
Cable connection	12 ft cable length (standard)	—	12
	20 ft cable length (standard)	—	20
	Other lengths (special order)	—	Length in ft

② For operating head specifications, see Page V8-T2-72.

③ Roller can be converted in the field between horizontal and vertical.

④ For a full selection of connector cables, see Tab 10, section 10.1.

E50 Heavy-Duty Factory Sealed 6P+ Switches

Connection is by 8 ft cable ①.

Assembled Switch

E50 Heavy-Duty Factory Sealed 6P+ Switches, Assembled—Standard, continued



Single-Pole



Two-Pole

Indicating Light:	None	LED (24–120 Vac/dc)	Neon (120 Vac)	None	LED (24–120 Vac/dc)	Neon (120 Vac)
Switch Body:	E50SA6P 1NO-1NC	E50SAL6P 1NO-1NC	E50SAN6P 1NO-1NC	E50SB6P 2NO-2NC	E50SBL6P 2NO-2NC	E50SBN6P 2NO-2NC
Description	Assembled Switch Catalog Number			Assembled Switch Catalog Number		

Operating Head Type ②

Top Push Roller



Description	Assembled Switch Catalog Number			Assembled Switch Catalog Number		
Spring return— E50DT3	E50AT36P CE	E50ALT36P	E50ANT36P	E50BT36P	E50BLT36P	E50BNT36P

**Wobble Head,
Spring Return**



Wobble Head, Spring Return (requires a wobble operator, see Page V8-T2-80)						
Standard duty— E50DW1	E50AW16P CE	E50ALW16P	E50ANW16P	E50BW16P	E50BLW16P	E50BNW16P
Heavy-duty high strength steel— E50DW2	E50AW26P CE	E50ALW26P	E50ANW26P	E50BW26P	E50BLW26P	E50BNW26P

Circuit Diagrams, see Page V8-T2-77.

Notes

① Connection options (add the code suffix from the table below to the end of the catalog number):

Option		Catalog Number	Code Suffix
Mini-connector ③	Single-pole (5-pin mini-connector)	CSMS5D5CY1602	C
	Double-pole (9-pin mini-connector)	CSMS9D9CY1602	C
Cable connection	12 ft cable length (standard)	—	12
	20 ft cable length (standard)	—	20
	Other lengths (special order)	—	Length in ft







② For operating head specifications, see Page V8-T2-72.

③ For a full selection of connector cables, see Tab 10, section 10.1.

Operating Heads

2

E50 Heavy-Duty Factory Sealed 6P+ Switches, Operating Heads

Description	Travel to Operate Contacts	Travel to Reset Contacts	Total Travel	Force to Operate Contacts	Minimum Return Force	Operating Temperature ^①		Catalog Number
						Without Cable	With Pre-wired Cable	
Side Rotary	Side Rotary (requires an operating lever, see Page V8-T2-80)							
 Standard spring return ^②	5°	2°	90°	3 in-lbs	4.5 in-oz	10° to 200°F (-12° to 94°C) ^③	10° to 200°F (-12° to 94°C) ^③	E50DR1
Low temperature spring return ^②	5°	2°	90°	3 in-lbs	4.5 in-oz	-40° to 175°F (-40° to 79°C)	-31° to 175°F (-34° to 79°C)	E50DR19
Low force spring return ^②	15°	6°	90°	1.5 in-lbs	2.5 in-oz	10° to 200°F (-12° to 94°C) ^③	10° to 200°F (-12° to 94°C) ^③	E50DL1
Maintained two-position	50°	50°	90°	3 in-lbs	—	14° to 200°F (-10° to 94°C)	14° to 200°F (-10° to 94°C)	E50DM1
Spring Return	Side Pushbutton							
 Spring return	0.065 in	0.030 in	0.250 in	4 lbs	8 oz	14° to 200°F (-10° to 94°C)	14° to 200°F (-10° to 94°C)	E50DS1
Adjustable Spring Return	Side Pushbutton							
 Adjustable spring return	0.065 in	0.030 in	0.250 in	4 lbs	8 oz	14° to 200°F (-10° to 94°C)	14° to 200°F (-10° to 94°C)	E50DS2
Side Push Roller	Side Pushbutton							
 Spring return ^④	0.065 in	0.030 in	0.250 in	4 lbs	8 oz	14° to 200°F (-10° to 94°C)	14° to 200°F (-10° to 94°C)	E50DS3 ^⑤
	0.065 in	0.030 in	0.250 in	4 lbs	8 oz	14° to 200°F (-10° to 94°C)	14° to 200°F (-10° to 94°C)	E50DS4 ^⑤
Side Pushbutton	Side Pushbutton							
 Maintained	0.200 in	0.130 in	0.320 in	5 lbs	5 lbs	14° to 200°F (-10° to 94°C)	14° to 200°F (-10° to 94°C)	E50DH1
Spring Return	Top Pushbutton							
 Spring return	0.040 in	0.020 in	0.280 in	4 lbs	8 oz	14° to 250°F (-10° to 121°C)	14° to 221°F (-10° to 105°C)	E50DT1
Adjustable Spring Return	Top Pushbutton							
 Adjustable spring return	0.040 in	0.020 in	0.280 in	4 lbs	8 oz	14° to 250°F (-10° to 121°C)	14° to 221°F (-10° to 105°C)	E50DT2

Notes

- ① Temperature ranges below 32°F (0°C) are based on absence of freezing moisture or water.
- ② CW (clockwise) and CCW (counterclockwise) operation, easily convertible to CW only or CCW only operation.
- ③ For CW and CCW operation. For CW only or CCW only operation, high temperature limit increases to 250°F (121°C) without cable, and 221°F (105°C) with pre-wired cable.
- ④ Roller can be converted in the field between horizontal and vertical.
- ⑤ Roller shaft is 0.38 in (9.5 mm) longer on E50DS4, see Dimensions on [Page V8-T2-78](#).

E50 Heavy-Duty Factory Sealed 6P+ Switches

E50 Heavy-Duty Factory Sealed 6P+ Switches, Operating Heads, continued

Description	Travel to Operate Contacts	Travel to Reset Contacts	Total Travel	Force to Operate Contacts	Minimum Return Force	Operating Temperature ^①		Catalog Number
						Without Cable	With Pre-Wired Cable	
Top Push Roller	Top Push Roller							
Spring return	0.040 in	0.020 in	0.280 in	4 lbs	8 oz	14° to 250°F (-10° to 121°C)	14° to 221°F (-10° to 105°C)	E50DT3
Wobble Head, Spring Return	Wobble Head, Spring Return (requires a wobble operator, see Page V8-T2-80)							
Standard duty	10°	6°	15°	2 in-lbs	2.4 in-oz	14° to 250°F (-10° to 121°C)	14° to 221°F (-10° to 105°C)	E50DW1
Heavy-duty high strength steel	10°	6°	15°	2 in-lbs	2.4 in-oz	14° to 250°F (-10° to 121°C)	14° to 221°F (-10° to 105°C)	E50DW2
Circuit Diagrams , see Page V8-T2-77 .								

Switch Bodies

E50 Heavy-Duty Factory Sealed 6P+, Switch Bodies

Circuit	Switch Body Construction	Cable Length	Catalog Number
Pre-Wired Cable	Pre-Wired Cable		
Single-pole 1NO-1NC	Without indicating light	8 ft	E50SA6P
		12 ft	E50SA6P12
		20 ft	E50SA6P20
	With LED indicating light 24–120 Vac/dc	8 ft	E50SAL6P
		12 ft	E50SAL6P12
		20 ft	E50SAL6P20
	With neon indicating light 120 Vac	8 ft	E50SAN6P
		12 ft	E50SAN6P12
		20 ft	E50SAN6P20
Two-pole 2NO-2NC	Without indicating light	8 ft	E50SB6P
		12 ft	E50SB6P12
		20 ft	E50SB6P20
	With LED indicating light 24–120 Vac/dc	8 ft	E50SBL6P
		12 ft	E50SBL6P12
		20 ft	E50SBL6P20
	With neon indicating light 120 Vac	8 ft	E50SBN6P
		12 ft	E50SBN6P12
		20 ft	E50SBN6P20
Mini-Connector	Mini-Connector		
Single-pole 1NO-1NC	Without indicating light normal wiring	—	E50SA6PC Ⓢ
	Without indicating light alternate wiring	—	E50SA6PC-W Ⓢ
	With LED indicating light 24–120 Vac/dc	—	E50SAL6PC Ⓢ
	With neon indicating light 120 Vac	—	E50SAN6PC Ⓢ
Two-pole 2NO-2NC	Without indicating light	—	E50SB6PC Ⓢ
	With LED indicating light 24–120 Vac/dc	—	E50SBL6PC Ⓢ
	With neon indicating light 120 Vac	—	E50SBN6PC Ⓢ

Notes



Ⓢ See listing of compatible connector cables on [Page V8-T2-74](#).

① Temperature ranges below 32°F (0°C) are based on absence of freezing moisture or water.

Compatible Connector Cables



2

Standard Cables ^①

	Current Rating at 600V	Voltage Style	Number of Pins	Gauge	Length	Pin Configuration/Wire Colors (Face View Female Shown)	Catalog Number
 Mini-Style, Straight Female	Mini-Style, Straight Female						
	8A	—	5-pin	16 AWG	6 ft (2m)	 1-White 2-Red 3-Green 4-Orange 5-Black	CSMS5D5CY1602
	7A	—	9-pin	16 AWG	12 ft (4m)	 1-Orange 2-Blue 3-Red/Black 4-Green/Black 5-White 6-Red 7-Green 8-White/Black 9-Black	CSMS9D9CY1602

Accessories

E50 Heavy-Duty Factory Sealed 6P+ Switch Accessories

		Catalog Number
 E50KH1M	Adapter Plate Allows E50 to replace Eaton's 10316 Type LP Manifold Mounting Plug-In Limit Switch	E50KH1M
 E50KH7	Allows E50 to replace Square D Type AW Surface Mounting Non Plug-In Standard Box Limit Switch	E50KH7

Dimensions, see **Page V8-T2-78**.

Note

^① For a full selection of connector cables, see **Tab 10, section 10.1**.

E50 Heavy-Duty Factory Sealed 6P+ Switch Accessories, continued

Catalog Number

Adapter Plate, continued**E50KH4**

Allows E50 to replace National Acme, Type D-1200M, Style 2 Mounting. Denison LoxSwitch, Model L-100W, Style 2 Mounting. Square D 9007 Type T, Style B Mounting. (Adapter plate is 1/8 in thick, with 1/4 in mounting holes.) Namco® long mount.

E50KH4 ①**E50KH5**

Allows E50 to replace National Acme, Type D-1200M, Style 1 Mounting. Denison LoxSwitch, Model L-100W, Style 1 Mounting. Square D 9007 Type T, Style C Mounting. (Adapter plate is 1/8 in thick, with 1/4 in mounting holes.)

E50KH5 ①**E50KH2**

Allows E50 to replace Eaton's 10316 Type LT Non Plug-In Two-Pole Limit Switch

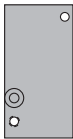
E50KH2**E50KH10**

Allows E50 to replace Allen-Bradley 802M Sealed Limit Switch

E50KH10**Adjustable Mounting Plate****E50KH3**

This is a mounting plate only 5/16 in thick and includes the proper mounting bolts and nuts. The slots in the plate allow a maximum horizontal adjustment of 1 in and vertical adjustment of 1-1/4 in

E50KH3 ①**Conduit Sealing Nut****E50KH6**

1/2 in oiltight

E50KH6

Dimensions, see Page V8-T2-78.

Note

① Limit switch not included.

Technical Data and Specifications

2

E50 Heavy-Duty Factory Sealed 6P+ Switches

Description	Specification
Environmental ratings	NEMA 1, 3, 3S, 4, 4X, 6, 6P, 13, IP67, IP69K
Material of construction	Zinc die cast
Switch gasket material	Viton
Universal U.S./DIN mounting dimensions	1.16 in (30 mm) x 2.34 in (60 mm)
Conduit entrance	1/2 in NPT or 20 mm threading
Contact ratings	See below
Contact operation	Snap action over center mechanism
Contact material	Fine silver
Maximum frequency of operation	8000 operations per hour
Mechanical life	
Side rotary	13,000,000 operations minimum
Side or top push	10,000,000 operations minimum
Electrical life	
Single-pole	1,000,000 operations typical at full load
Double-pole	100,000 operations typical at full load
Ambient temperature range—standard	
Standard without cable	14° to 250°F (–10° to 121°C)
Standard with cable	14° to 221°F (–10° to 105°C)
Low temperature without cable	–40° to 250°F (–40° to 121°C)
Low temperature with cable	–40° to 221°F (–40° to 105°C)
Repeat accuracy—standard	
Side operated	Within 0.0012 in
Top operated	Within 0.0003 in
Side rotary	Within 0.0014 in
Torque requirements	
Operating head screws	14–18 lb-in

Electrical Data—Maximum Contact Ratings (Same polarity each pole)

AC Volts	Current, Amperes			Voltamperes		DC Volts	Current, Amperes	
	Make	Break	Cont. ①	Make	Break		Max. Make or Break	Cont. ①
All Switches Except Gravity Return and Indicating Light Versions								
NEMA A600 Rating						NEMA R300		
120	60	6	10	7200	720	125	0.22	1.0
240	30	3	10	7200	720	250	0.11	1.0
480	15	1.5	10	7200	720	250	0.11	1.0
600	12	1.2	10	7200	720	250	0.11	1.0
Switches with Indicating Lights (LED or Neon)								
NEMA A150 Rating						NEMA R150		
120	60	6	10	7200	720	125	0.22	1.0

Note

① Thermal rating. Valid only if switch does not have to make or break.

Circuit Diagrams ①

Standard Assembled Switches

Single-Pole 1NO-1NC

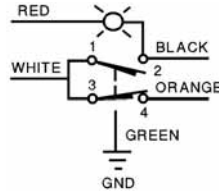
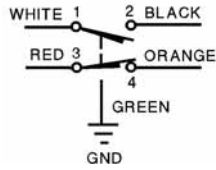

Must be same polarity.

Switch Bodies

**Pre-Wired Cable—
Single-Pole 1NO-1NC**

E50SA6P_

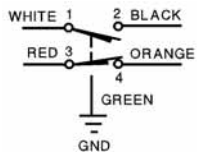

E50SAL6P_

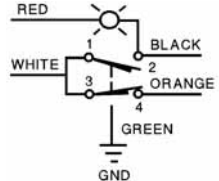

Two-Pole 2NO-2NC

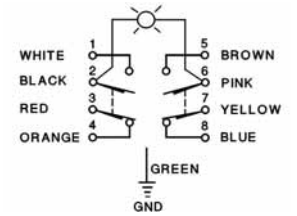
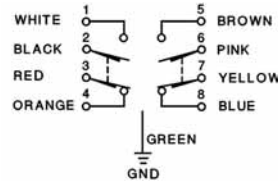

Same polarity, each pole.

**Pre-Wired Cable—
Two-Pole 2NO-2NC**

E50SB6P_

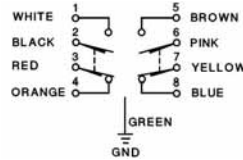

E50SBL6P_

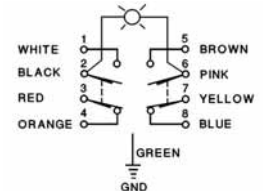

Wiring Diagrams ①

Mini-Connector—Single-Pole 1NO-1NC

E50SA6PC

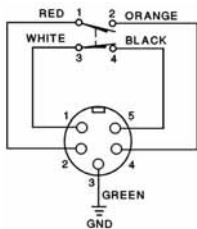

E50SA6PC-W

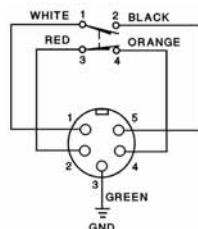

E50SAL6PC/E50SAN6PC

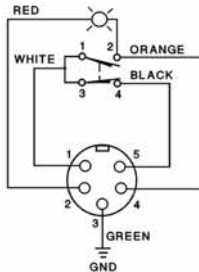

Mini-Connector—Two-Pole 2NO-2NC

E50SB6PC

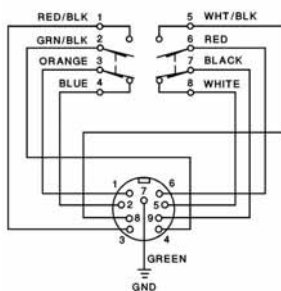

E50SBL6PC/E50SBN6PC

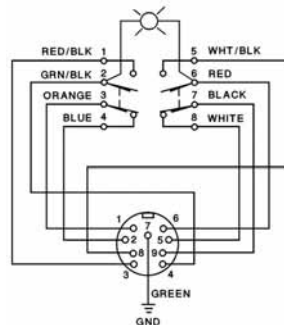

Note

① The wire colors referenced on these diagrams are those internal to the switch itself.

Dimensions

Approximate Dimensions in Inches (mm)

2

Standard

6P+ Limit Switch with Rotary Operating Head

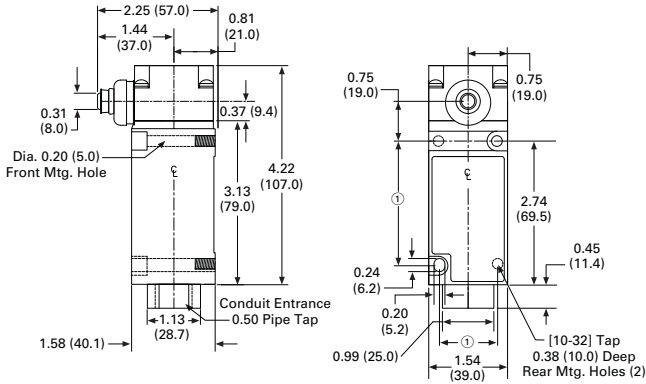

Side Push Operators

Approximate Dimensions in mm [in]

Pushbutton

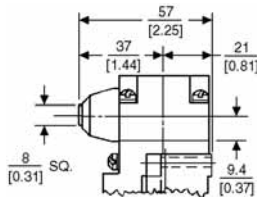

Adjustable Pushbutton

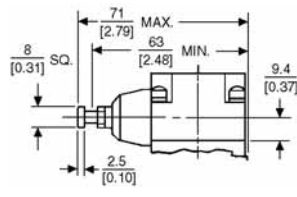

Roller

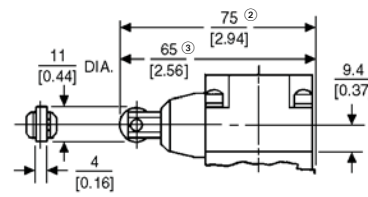

Maintained Pushbutton

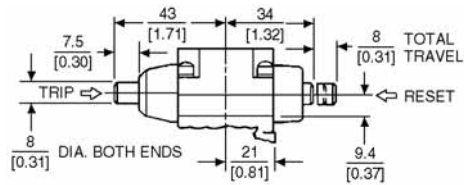

Top Push Operators

Pushbutton

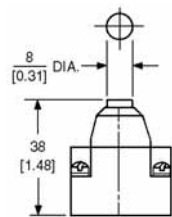

Adjustable Pushbutton

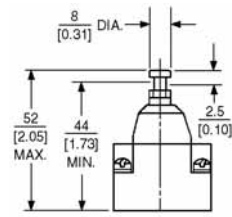

Roller

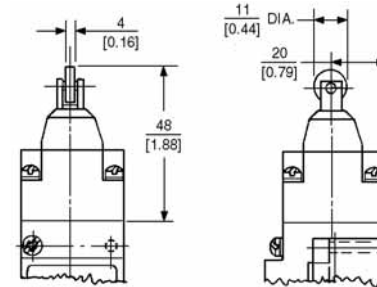

Wobble Operators

See Operators on **Page V8-T2-80**.

Notes

- Can accommodate both U.S., 1.16 (29.4) x 2.34 (59.5) and DIN, 1.18 (30.0) x 3.26 (83.0), mounting dimensions.
- For E50DS4.
- For E50DS3.

Accessories

Approximate Dimensions in mm [in]

Adapter Plates

E50KH1M



E50KH7

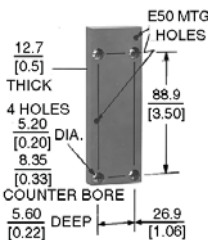

E50KH4

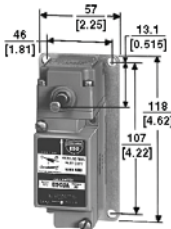

E50KH5

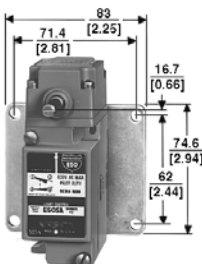

E50KH2

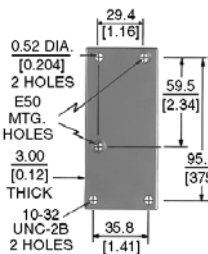

E50KH10

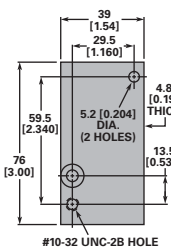

Adjustable Mounting Plate

E50KH3

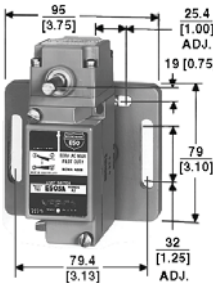

Operators

2



Operators

Product Description

The Operators presented here are used with Eaton's E50 Plug-In and 6P+ limit switches, as well as our 10316 rotary type limit switches. A wide variety of styles and sizes are available to provide optimum performance for nearly any application.

Features

- Wide variety of operator types for rotary and wobble style limit switches
- Rollers and rods available in metal and nonmetal contact surfaces

Contents

Description

Page

Operators

Product Selection

Roller Type Operators **V8-T2-81**

Rod Type Operators **V8-T2-83**

Wobble Type Operators **V8-T2-84**

Dimensions **V8-T2-84**



Drawings
Online

⚠ DANGER

THIS SENSOR IS NOT A SAFETY DEVICE AND IS NOT INTENDED TO BE USED AS A SAFETY DEVICE. This sensor is designed only to detect and read certain data in an electronic manner and perform no use apart from that, specifically no safety-related use. This sensor product does not include self-checking redundant circuitry, and the failure of this sensor product could cause either an energized or de-energized output condition, which could result in death, serious bodily injury, or property damage.

For the most current information on this product, visit our Web site: www.eaton.com

For Customer Service in the U.S. call 1-877-ETN CARE (386-2273),
in Canada call 1-800-268-3578.
For Application Assistance in the U.S. and Canada
call 1-800-426-9184.





Product Selection

Roller Type Operators

For rotary head switches: E50 Plug-In, E50 6P+, and 10316.

Note: Only operators with Nylatron rods or rollers should be used with explosion-proof limit switches.

Operators—Roller Type

Roller Type	Minimum Required Return Torque ^①	Approximate Dimensions in Inches (mm)						Catalog Number	
		A Lever Length ^②	B Roller Diameter	C Roller Width	D	E	F		
E50KL200									
Standard Roller (Stainless Steel)									
	Metal	0.95 in-oz	1.38 (34.9)	0.75 (19.0)	0.32 (8.1)	0.34 (8.6)	0.13 (3.3)	0.17 (4.3)	E50KL40
	Ball bearing	0.77 in-oz	1.50 (38.1)	0.69 (17.5)	0.25 (6.4)	0.34 (8.6)	0.05 (1.3)	0.11 (2.8)	E50KL531
	Nylatron	0.53 in-oz	1.50 (38.1)	0.75 (19.0)	0.32 (8.1)	0.34 (8.6)	0.13 (3.3)	0.17 (4.3)	E50KL200
	Metal	1.10 in-oz	1.50 (38.1)	0.75 (19.0)	0.32 (8.1)	0.34 (8.6)	0.13 (3.3)	0.17 (4.3)	E50KL355
E50KL355									
	Nylatron	0.96 in-oz	1.50 (38.1)	0.75 (19.0)	1.00 (25.4)	0.34 (8.6)	0.83 (21.1)	0.83 (21.1)	E50KL377
	Without roller	0.32 in-oz	1.50 (38.1)	—	—	0.34 (8.6)	—	—	E50KL32
	Ball bearing	1.10 in-oz	2.00 (50.8)	0.69 (17.5)	0.25 (6.4)	0.34 (8.6)	0.05 (1.3)	0.11 (2.8)	E50KL552
	Nylatron	0.71 in-oz	2.00 (50.8)	0.75 (19.0)	0.32 (8.1)	0.34 (8.6)	0.13 (3.3)	0.17 (4.3)	E50KL546
	Metal	1.50 in-oz	2.00 (50.8)	0.75 (19.0)	0.32 (8.1)	0.34 (8.6)	0.13 (3.3)	0.17 (4.3)	E50KL549
E50KL377									
	Nylatron	1.45 in-oz	2.00 (50.8)	0.75 (19.0)	1.00 (25.4)	0.34 (8.6)	0.83 (21.1)	0.83 (21.1)	E50KL572
	Ball bearing	1.50 in-oz	2.50 (63.5)	0.69 (17.5)	0.25 (6.4)	0.34 (8.6)	0.05 (1.3)	0.11 (2.8)	E50KL553
	Nylatron	1.00 in-oz	2.50 (63.5)	0.75 (19.0)	0.32 (8.1)	0.34 (8.6)	0.13 (3.3)	0.17 (4.3)	E50KL547
	Metal	2.00 in-oz	2.50 (63.5)	0.75 (19.0)	0.32 (8.1)	0.34 (8.6)	0.13 (3.3)	0.17 (4.3)	E50KL550
	Nylatron	1.80 in-oz	2.50 (63.5)	0.75 (19.0)	1.00 (25.4)	0.34 (8.6)	0.83 (21.1)	0.83 (21.1)	E50KL573
E50KL554									
	Nylatron	1.40 in-oz	2.50 (63.5)	1.50 (38.1)	0.28 (7.1)	0.34 (8.6)	0.11 (2.8)	0.17 (4.3)	E50KL575
	Ball bearing	1.80 in-oz	3.00 (76.2)	0.69 (17.5)	0.25 (6.4)	0.34 (8.6)	0.05 (1.3)	0.11 (2.8)	E50KL554
	Nylatron	1.30 in-oz	3.00 (76.2)	0.75 (19.0)	0.32 (8.1)	0.34 (8.6)	0.13 (3.3)	0.17 (4.3)	E50KL548
	Metal	2.50 in-oz	3.00 (76.2)	0.75 (19.0)	0.32 (8.1)	0.34 (8.6)	0.13 (3.3)	0.17 (4.3)	E50KL551
	Nylatron	2.30 in-oz	3.00 (76.2)	0.75 (19.0)	1.00 (25.4)	0.34 (8.6)	0.83 (21.1)	0.83 (21.1)	E50KL574
	Nylatron	1.80 in-oz	3.00 (76.2)	1.50 (38.1)	0.28 (7.1)	0.34 (8.6)	0.11 (2.8)	0.17 (4.3)	E50KL576
Dimensions, see Page V8-T2-84.									
E50KL580									
	Roller On Reverse Side (Stainless Steel)								
	Ball bearing	0.77 in-oz	1.50 (38.1)	0.69 (17.5)	0.25 (6.4)	0.34 (8.6)	0.18 (4.6)	0.24 (6.1)	E50KL580
	Nylatron	0.53 in-oz	1.50 (38.1)	0.75 (19.0)	0.32 (8.1)	0.34 (8.6)	0.27 (6.9)	0.31 (7.9)	E50KL310
	Metal	1.10 in-oz	1.50 (38.1)	0.75 (19.0)	0.32 (8.1)	0.34 (8.6)	0.27 (6.9)	0.31 (7.9)	E50KL579
	Nylatron	0.96 in-oz	1.50 (38.1)	1.50 (38.1)	0.28 (7.1)	0.34 (8.6)	0.23 (5.8)	0.31 (7.9)	E50KL536
E50KL24									
	Offset Inboard Roller (Stainless Steel)								
	Nylatron	0.65 in-oz	1.50 (38.1)	0.75 (19.0)	0.32 (8.1)	0.03 (0.8)	—	—	E50KL24
	Metal	1.20 in-oz	1.50 (38.1)	0.75 (19.0)	0.32 (8.1)	0.03 (0.8)	—	—	E50KL25
	Ball bearing	0.90 in-oz	1.50 (38.1)	0.69 (17.5)	0.25 (6.4)	0.04 (1.0)	—	—	E50KL26
E50KL27									
	Offset Outboard Roller (Stainless Steel)								
	Nylatron	0.65 in-oz	1.50 (38.1)	0.75 (19.0)	0.32 (8.1)	0.03 (0.8)	—	—	E50KL27
	Metal	1.20 in-oz	1.50 (38.1)	0.75 (19.0)	0.32 (8.1)	0.03 (0.8)	—	—	E50KL28
	Ball bearing	0.90 in-oz	1.50 (38.1)	0.69 (17.5)	0.25 (6.4)	0.04 (1.0)	—	—	E50KL29
	Nylatron	1.10 in-oz	1.50 (38.1)	0.75 (19.0)	1.00 (25.4)	—	—	—	E50KL30
Dimensions, see Page V8-T2-85.									

Notes

- ^① **Caution:** When selecting lever, the minimum required return torque of lever should not exceed minimum return force available in operating head as given in operating head specifications.
- ^② Length from the operating shaft axis to the roller axis (or to the tip for non-roller operators).

Note: Only operators with Nylatron rods or rollers should be used with explosion-proof limit switches.

Operators—Roller Type, continued

Roller Type	Minimum Required Return Torque ^①	Approximate Dimensions in Inches (mm)						Catalog Number
		A Lever Length ^②	B Roller Diameter	C Roller Width	D	E	F	
E50KL532								
Bantam Lever								
Metal	0.45 in-oz	0.69 (17.5)	0.85 (22.0)	0.18 (4.6)	—	—	—	E50KL532
E50KL340								
Precision Adjustment								
Nylatron	0.65 in-oz	0.69 (17.5)	0.75 (19.0)	0.32 (8.1)	0.48 (12.2)	0.24 (6.1)	0.28 (7.1)	E50KL340
Metal	1.20 in-oz	Roller length: 1.50 (38.1) ^③	0.75 (19.0)	0.32 (8.1)	0.48 (12.2)	0.24 (6.1)	0.28 (7.1)	E50KL465
Ball bearing	0.90 in-oz		0.69 (17.5)	0.25 (6.4)	0.48 (12.2)	0.16 (4.1)	0.22 (5.6)	E50KL535
E50KL201								
Dimensions, see Page V8-T2-85.								
Adjustable Roller (Stainless Steel)								
Ball bearing	2.50 in-oz ^④	1.0 (25.4) to 3.75 (95.2) ^⑤	0.69 (17.5)	0.25 (6.4)	0.23 (5.8)	0.30 (7.6)	—	E50KL539
Nylatron	1.90 in-oz ^④		0.75 (19.0)	0.32 (8.1)	0.29 (7.4)	0.33 (8.4)	—	E50KL201
			0.75 (19.0)	0.32 (8.1)	0.29 (7.4)	0.33 (8.4)	—	E50KL201SPL ^⑥
E50KL537								
Metal	3.40 in-oz ^④		0.75 (19.0)	0.32 (8.1)	0.29 (7.4)	0.33 (8.4)	—	E50KL538
Nylatron	1.90 in-oz ^④		0.75 (19.0)	0.50 (12.7)	0.46 (11.6)	0.48 (12.2)	—	E50KL599
Nylatron	3.10 in-oz ^④		0.75 (19.0)	1.00 (25.4)	0.90 (22.9)	0.95 (24.1)	—	E50KL537
Large Nylatron	4.50 in-oz ^④	0.5 (12.7) to 3.25 (82.6)	4.00 (102.0)	0.11 (2.8)	0.11 (2.8)	0.19 (4.8)	—	E50KL598
Without roller	1.20 in-oz ^④	0.5 (12.7) to 3.75 (95.2)	—	—	—	—	—	E50KL31
Nylatron	2.50 in-oz ^④	1.63 (41.3) to 3.75 (95.2) ^⑤	1.50 (38.1)	0.29 (7.4)	0.26 (6.6)	0.32 (8.1)	—	E50KL443
Dimensions, see Page V8-T2-86.								

Operators—Roller Type, continued

Roller Type	Minimum Required Return Torque ^①	Approximate Dimensions in Inches (mm)						Catalog Number	
		A Lever Length ^②	B Roller Diameter	C Roller Width	D	E	F		G
E50KL545									
Fork Lever—Both Rollers on One Side									
Ball bearing	—	1.50 (38.1)	0.69 (17.5)	0.25 (6.4)	0.08 (2.0)	0.14 (3.6)	—	E50KL545	
Nylatron	—		0.75 (19.0)	0.32 (8.1)	0.16 (4.1)	0.20 (5.1)	—	E50KL204	
Metal	—		0.75 (19.0)	0.32 (8.1)	0.16 (4.1)	0.20 (5.1)	—	E50KL544	
Nylatron	—		0.75 (19.0)	1.00 (25.4)	0.84 (21.3)	0.88 (22.4)	—	E50KL543	
E50KL542									
Fork Lever—One Roller Outside, One Inside									
Ball bearing	—	1.50 (38.1)	0.69 (17.5)	0.25 (6.4)	0.08 (2.0)	0.14 (3.6)	0.64 (16.3)	0.70 (17.8)	E50KL542
Nylatron	—		0.75 (19.0)	0.32 (8.1)	0.16 (4.1)	0.20 (5.1)	0.73 (18.5)	0.77 (19.6)	E50KL203
Metal	—		0.75 (19.0)	0.32 (8.1)	0.16 (4.1)	0.20 (5.1)	0.73 (18.5)	0.77 (19.6)	E50KL541
Dimensions, see Page V8-T2-86.									

Notes



- ① **Caution:** When selecting lever, the minimum required return torque of lever should not exceed minimum return force available in operating head as given in operating head specifications.
- ② Length from the operating shaft axis to the roller axis (or to the tip for non-roller operators).
- ③ Maximum length dimension between operating shaft axis to roller axis for comparison. Precision adjustable to lesser dimensions.
- ④ Applies when lever is extended to the maximum dimension.
- ⑤ By reassembling lever, minimum length can be reduced another 0.5 in (12.7 mm).
- ⑥ High-grade stainless steel.

Rod Type Operators





For rotary head switches: E50 Plug-In, E50 6P+, and 10316.

Note: Only operators with Nylatron rods or rollers should be used with explosion-proof limit switches.

Operators—Rod Type

Rod Type	Minimum Required Return Torque ^①	Approximate Dimensions in Inches (mm)			Catalog Number
		A Rod Length (Maximum) ^②	B Rod Diameter		
Nylon/Metal					
Adjustable Rod					
 Nylon	0.40 in-oz ^③	5.50 (140.0)	0.19 (4.8)		E50KL399
Metal	0.92 in-oz ^③		0.12 (3.2)		E50KL202
Metal	2.20 in-oz ^③	8.75 (222.0)	Rod size (square): 0.12 (3.2) x 0.12 (3.2)		E50KL581
Metal/Steel					
 Stainless steel	7.00 in-oz ^③	9.00 (229.0)	0.19 (4.8)		E50KL220
Bendable steel	5.00 in-oz ^③	12.00 (305.0)	0.12 (3.2)		E50KL226
Clamps for Adjustable Rods (Rod not included)					
Clamp for ...					
					E50KL35
					E50KL36
					E50KL41
Dimensions, see Page V8-T2-87.					

Operators—Rod Type, continued

Rod Type	Minimum Required Return Torque ^①	Approximate Dimensions in Inches (mm)				Catalog Number
		A Rod Length ^②	B Rod Diameter	C	D	
Nylon/Steel						
Spring Rod						
 Nylon	3.50 in-oz	—	—	—	—	E50KL556
Stainless steel	2.80 in-oz	—	—	—	—	E50KL421
Nylon Covered Wire						
Adjustable Wire						
 Nylon covered wire	1.50 in-oz ^③	—	—	—	—	E50KL533
Nylatron						
Adjustable Wide Roller Lever						
 Nylatron	4.50 in-oz ^③	—	—	—	—	E50KL37
Nylatron Loop						
 Nylatron	0.40 in-oz	6.00 (152.0)	∅: 0.158 (4.0)	—	—	E50KL142
Zinc-Plated Steel						
Eye Bolt						
 Zinc-plated steel	0.53 in-oz	150.00 (38.1)	∅: 0.1875 (4.8) Loop ID: 0.375 (9.5)	0.52 (13.1)	0.24 (8.6)	E50KL33

Dimensions, see Page V8-T2-87.

Notes

- ^① **Caution:** When selecting lever, the minimum required return torque of lever should not exceed minimum return force available in operating head as given in operating head specifications.
- ^② Length from the operating shaft axis to tip.
- ^③ Applies when lever is extended to the maximum dimension.



Wobble Type Operators

For E50DW1 and E50DWZ Operator Heads on E50 Plug-In and E50 6P+ Switches.

2

Note: Only operators with Nylatron rods or rollers should be used with explosion-proof limit switches.

Operators—Wobble Type

	Wobble Type	Catalog Number
	Nylon Rod	E50KW2
	Stainless Steel Rod	E50KW3
	Coil Spring	E50KW4

Dimensions, see Page V8-T2-88.

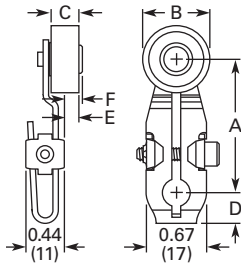
Dimensions**Roller Type Operators****Standard Roller**

Approximate Dimensions in Inches (mm)

Catalog Number	A Lever Length ^①	B Roller Diameter	C Roller Width	D	E	F
E50KL39	0.88 (22.2)	0.75 (19.0)	0.32 (8.1)	0.31 (7.9)	0.20 (5.1)	0.24 (6.1)
E50KL40	1.38 (34.9)	0.75 (19.0)	0.32 (8.1)	0.34 (8.6)	0.13 (3.3)	0.17 (4.3)
E50KL531	1.50 (38.1)	0.69 (17.5)	0.25 (6.4)	0.34 (8.6)	0.05 (1.3)	0.11 (2.8)
E50KL200	1.50 (38.1)	0.75 (19.0)	0.32 (8.1)	0.34 (8.6)	0.13 (3.3)	0.17 (4.3)
E50KL355	1.50 (38.1)	0.75 (19.0)	0.32 (8.1)	0.34 (8.6)	0.13 (3.3)	0.17 (4.3)
E50KL377	1.50 (38.1)	0.75 (19.0)	1.00 (25.4)	0.34 (8.6)	0.83 (21.1)	0.83 (21.1)
E50KL32	1.50 (38.1)	—	—	0.34 (8.6)	—	—
E50KL552	2.00 (50.8)	0.69 (17.5)	0.25 (6.4)	0.34 (8.6)	0.05 (1.3)	0.11 (2.8)
E50KL546	2.00 (50.8)	0.75 (19.0)	0.32 (8.1)	0.34 (8.6)	0.13 (3.3)	0.17 (4.3)
E50KL549	2.00 (50.8)	0.75 (19.0)	0.32 (8.1)	0.34 (8.6)	0.13 (3.3)	0.17 (4.3)
E50KL572	2.00 (50.8)	0.75 (19.0)	1.00 (25.4)	0.34 (8.6)	0.83 (21.1)	0.83 (21.1)
E50KL553	2.50 (63.5)	0.69 (17.5)	0.25 (6.4)	0.34 (8.6)	0.05 (1.3)	0.11 (2.8)
E50KL547	2.50 (63.5)	0.75 (19.0)	0.32 (8.1)	0.34 (8.6)	0.13 (3.3)	0.17 (4.3)
E50KL550	2.50 (63.5)	0.75 (19.0)	0.32 (8.1)	0.34 (8.6)	0.13 (3.3)	0.17 (4.3)
E50KL573	2.50 (63.5)	0.75 (19.0)	1.00 (25.4)	0.34 (8.6)	0.83 (21.1)	0.83 (21.1)
E50KL575	2.50 (63.5)	1.50 (38.1)	0.28 (7.1)	0.34 (8.6)	0.11 (2.8)	0.17 (4.3)
E50KL554	3.00 (76.2)	0.69 (17.5)	0.25 (6.4)	0.34 (8.6)	0.05 (1.3)	0.11 (2.8)
E50KL548	3.00 (76.2)	0.75 (19.0)	0.32 (8.1)	0.34 (8.6)	0.13 (3.3)	0.17 (4.3)
E50KL551	3.00 (76.2)	0.75 (19.0)	0.32 (8.1)	0.34 (8.6)	0.13 (3.3)	0.17 (4.3)
E50KL574	3.00 (76.2)	0.75 (19.0)	1.00 (25.4)	0.34 (8.6)	0.83 (21.1)	0.83 (21.1)
E50KL576	3.00 (76.2)	1.50 (38.1)	0.28 (7.1)	0.34 (8.6)	0.11 (2.8)	0.17 (4.3)

Note

^① Length from the operating shaft axis to the roller axis (or to the tip for non-roller operators).

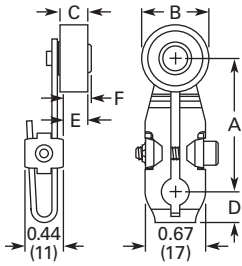

Roller on Reverse Side

Approximate Dimensions in Inches (mm)

Catalog Number	A Lever Length ①	B Roller Diameter	C Roller Width	D	E	F
E50KL580	1.50 (38.1)	0.69 (17.5)	0.25 (6.4)	0.34 (8.6)	0.18 (4.6)	0.24 (6.1)
E50KL310	1.50 (38.1)	0.75 (19.0)	0.32 (8.1)	0.34 (8.6)	0.27 (6.9)	0.31 (7.9)
E50KL579	1.50 (38.1)	0.75 (19.0)	0.32 (8.1)	0.34 (8.6)	0.27 (6.9)	0.31 (7.9)
E50KL536	1.50 (38.1)	1.50 (38.1)	0.28 (7.1)	0.34 (8.6)	0.23 (5.8)	0.31 (7.9)

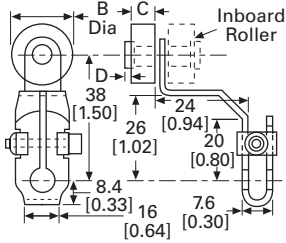

Offset Roller

Approximate Dimensions in mm [in]

Catalog Number	A Lever Length ①	B Roller Diameter	C Roller Width	D
Inboard				
E50KL24	38.1 [1.50]	19.0 [0.75]	8.1 [0.32]	0.8 [0.03]
E50KL25	38.1 [1.50]	19.0 [0.75]	8.1 [0.32]	0.8 [0.03]
E50KL26	38.1 [1.50]	17.5 [0.69]	6.4 [0.25]	1.0 [0.04]
Outboard				
E50KL27	38.1 [1.50]	19.0 [0.75]	8.1 [0.32]	0.8 [0.03]
E50KL28	38.1 [1.50]	19.0 [0.75]	8.1 [0.32]	0.8 [0.03]
E50KL29	38.1 [1.50]	17.5 [0.69]	6.4 [0.25]	1.0 [0.04]
E50KL30	38.1 [1.50]	19.0 [0.75]	25.4 [1.00]	—

Bantam Lever

Approximate Dimensions in mm [in]

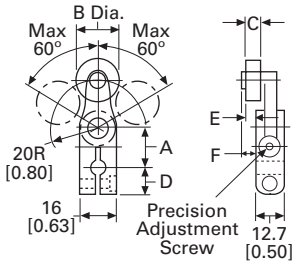
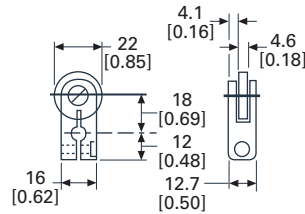

Precision Adjustment

Approximate Dimensions in mm [in]

Catalog Number	A Lever Length ①	B Roller Diameter	C Roller Width	D	E	F
E50KL340	17.5 [0.69]	19.0 [0.75]	8.1 [0.32]	12.2 [0.48]	6.1 [0.24]	7.1 [0.28]
E50KL465	Roller length: 38.1 [1.50] ②	19.0 [0.75]	8.1 [0.32]	12.2 [0.48]	6.1 [0.24]	7.1 [0.28]
E50KL535		17.5 [0.69]	6.4 [0.25]	12.2 [0.48]	4.1 [0.16]	5.6 [0.22]

Notes

- ① Length from the operating shaft axis to the roller axis (or to the tip for non-roller operators).
- ② Maximum length dimension between operating shaft axis to the roller axis for comparison. Precision adjustable to lesser dimensions.

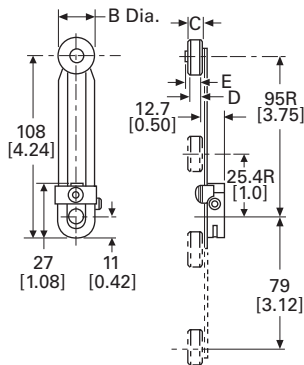

Adjustable Roller

Approximate Dimensions in mm [in]

Catalog Number	A Lever Length ①	B Roller Diameter	C Roller Width	D	E
E50KL539	25.4 [1.0] to 95.2 [3.75] ②	17.5 [0.69]	6.4 [0.25]	5.8 [0.23]	7.6 [0.30]
E50KL201		19.0 [0.75]	8.1 [0.32]	7.4 [0.29]	8.4 [0.33]
E50KL201SPL ③		19.0 [0.75]	8.1 [0.32]	7.4 [0.29]	8.4 [0.33]
E50KL538		19.0 [0.75]	8.1 [0.32]	7.4 [0.29]	8.4 [0.33]
E50KL599		19.0 [0.75]	12.7 [0.50]	11.6 [0.46]	12.2 [0.48]
E50KL537		19.0 [0.75]	25.4 [1.00]	22.9 [0.90]	24.1 [0.95]
E50KL598	12.7 [0.50] to 82.6 [3.25]	102.0 [4.00]	2.8 [0.11]	4.8 [0.19]	24.1 [0.95]
E50KL31	12.7 [0.50] to 95.2 [3.75]	—	—	—	—
E50KL443	41.3 [1.63] to 95.2 [3.75] ②	38.1 [1.50]	7.4 [0.29]	6.6 [0.26]	8.1 [0.32]

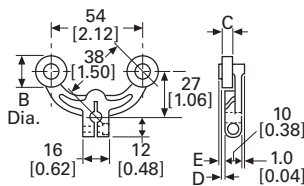

Fork Lever—Both Rollers on One Side

Approximate Dimensions in mm [in]

Catalog Number	A Lever Length ①	B Roller Diameter	C Roller Width	D	E
E50KL545	38.1 [1.50]	17.5 [0.69]	6.4 [0.25]	2.0 [0.08]	3.6 [0.14]
E50KL204	38.1 [1.50]	19.0 [0.75]	8.1 [0.32]	4.1 [0.16]	5.1 [0.20]
E50KL544	38.1 [1.50]	19.0 [0.75]	8.1 [0.32]	4.1 [0.16]	5.1 [0.20]
E50KL543	38.1 [1.50]	19.0 [0.75]	25.4 [1.00]	21.3 [0.84]	22.4 [0.88]

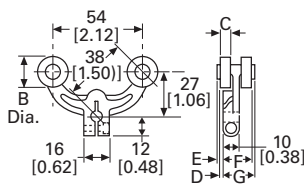

Fork Lever—One Roller Outside, One Inside

Approximate Dimensions in mm [in]

Catalog Number	A Lever Length ①	B Roller Diameter	C Roller Width	D	E	F	G
E50KL542	38.1 [1.50]	17.5 [0.69]	6.4 [0.25]	2.0 [0.08]	3.6 [0.14]	16.3 [0.64]	17.8 [0.70]
E50KL203	38.1 [1.50]	19.0 [0.75]	8.1 [0.32]	4.1 [0.16]	5.1 [0.20]	18.5 [0.73]	19.6 [0.77]
E50KL541	38.1 [1.50]	19.0 [0.75]	8.1 [0.32]	4.1 [0.16]	5.1 [0.20]	18.5 [0.73]	19.6 [0.77]

Notes

- ① Length from the operating shaft axis to the roller axis (or to the tip for non-roller operators).
- ② By reassembling lever, minimum length can be reduced another 12.7 mm [0.5 in].
- ③ High-grade stainless steel.

Approximate Dimensions in Inches or mm [in]

Rod Type Operators

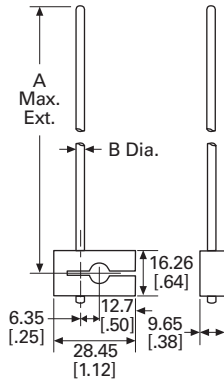

Adjustable Rod

Catalog Number	A Rod Length ^①	B Rod Diameter
E50KL399	140.0 [5.50]	4.8 [0.19]
E50KL202		3.2 [0.12]
E50KL581	222.0 [8.75]	Rod size (square): 3.2 [0.12] x 3.2 [0.12]
E50KL220	229.0 [9.00]	4.8 [0.19]
E50KL226	305.0 [12.00]	3.2 [0.12]

Spring Rod – E50KL556

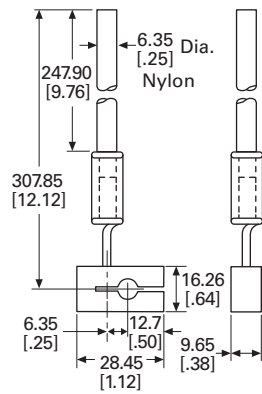

Spring Rod – E50KL421

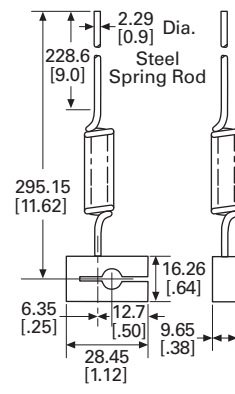

Adjustable Wire

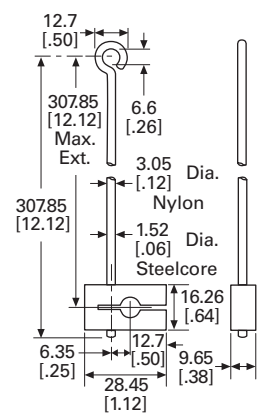

Adjustable Wide Roller Lever

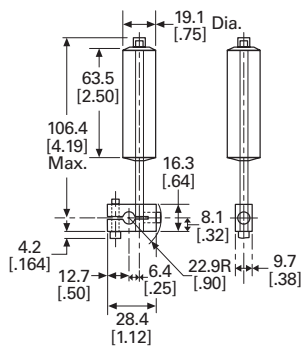

Nylatron Loop – E50KL142

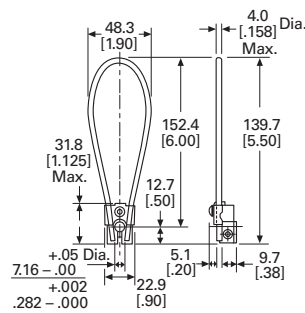

Eye Bolt

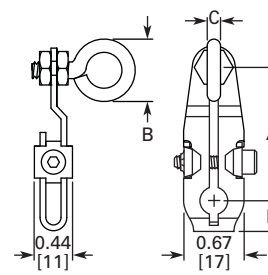

Catalog Number	A Rod Length ^②	B Rod Diameter	C Rod Width	D
E50KL33	38.1 [1.50]	4.8 [0.1875] Loop ID: 9.5 [0.375]	13.1 [0.52]	8.6 [0.34]

Notes

- ① Applies when lever is extended to the maximum dimension.
- ② Length from the operating shaft axis to tip.

Wobble Type Operators

Nylon Rod

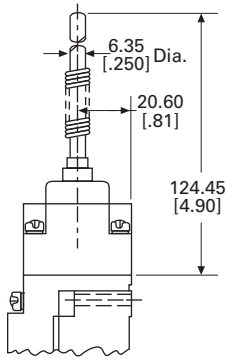

Stainless Steel Rod

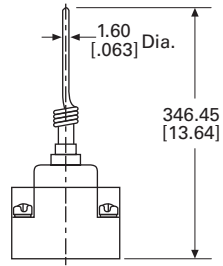

Coil Spring

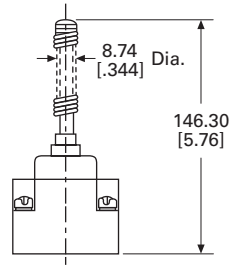

Non Plug-In Switches



Non Plug-In Switches

Product Description

10316 Type L non plug-in limit switches by Eaton's electrical sector are sold as complete assembled devices only with a wide array of operating head configurations. All switches are single-pole 1NO-1NC.

Features

- Side and top rotary, side and top push or wobble operation
- CW, CCW or CW and CCW operating modes are field convertible
- Double break-make snap action contacts, same polarity each pole
- Captive saddle clamp terminals accept up to #12 wire
- Head can be mounted in any of four discrete positions, intervals of 90°

Contents

Description

Non Plug-In Switches

	<i>Page</i>
Product Selection	V8-T2-90
Technical Data and Specifications	V8-T2-91
Dimensions	V8-T2-91

2

Standards and Certifications

- UL Listed
- CSA Certified



⚠ DANGER

THIS SENSOR IS NOT A SAFETY DEVICE AND IS NOT INTENDED TO BE USED AS A SAFETY DEVICE. This sensor is designed only to detect and read certain data in an electronic manner and perform no use apart from that, specifically no safety-related use. This sensor product does not include self-checking redundant circuitry, and the failure of this sensor product could cause either an energized or de-energized output condition, which could result in death, serious bodily injury, or property damage.









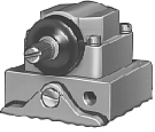
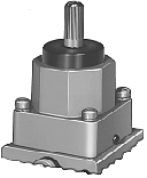
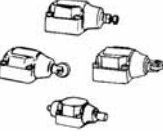

For the most current information on this product, visit our Web site: www.eaton.com

For Customer Service in the U.S. call 1-877-ETN CARE (386-2273),
in Canada call 1-800-268-3578.
For Application Assistance in the U.S. and Canada
call 1-800-426-9184.

Product Selection

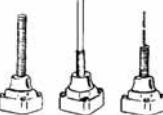
2

Complete Assembled Switches Single-Pole 1NO-1NC

Operating Characteristics	Operating Data—Nominal			Force to Operate Contacts	Minimum Return Force	Catalog Number
	Travel to Operate Contacts	Travel to Reset Contacts	Total Travel			
Side Rotary Operated	Side Rotary Operated ^①					
 Standard	10°	4°	50°	3 in-lbs	4.5 in-oz	10316H187
Top Rotary Operated	Top Rotary Operated ^①					
 Clockwise	20°	12°	140°	1.1 in-lbs	3 in-oz	10316H700
Counterclockwise	20°	12°	140°	1.1 in-lbs	3 in-oz	10316H701
Side Push Operated	Side Push Operated					
 Adjustable pushbutton	0.07 in (1.8 mm)	0.03 in (0.8 mm)	0.29 in (7.4 mm)	4 lbs	8 oz	10316H621
 Vertical roller— 0.44 in (11.2 mm) dia.	0.07 in (1.8 mm)	0.03 in (0.8 mm)	0.29 in (7.4 mm)	4 lbs	8 oz	10316H284
 Horizontal roller— 0.44 in (11.2 mm) dia.	0.07 in (1.8 mm)	0.03 in (0.8 mm)	0.29 in (7.4 mm)	4 lbs	8 oz	10316H285
Top Push Operated	Top Push Operated					
 Pushbutton	0.04 in (1.0 mm)	0.02 in (0.5 mm)	0.28 in (7.1 mm)	4 lbs	8 oz	10316H281
 Roller—0.44 in (11.2 mm) dia.	0.04 in (1.0 mm)	0.02 in (0.5 mm)	0.28 in (7.1 mm)	4 lbs	8 oz	10316H283
 Roller—0.75 in (19.1 mm) dia.	0.04 in (1.0 mm)	0.02 in (0.5 mm)	0.28 in (7.1 mm)	4 lbs	8 oz	10316H577
Wobble Operated	Wobble Operated ^②					
 Spring	10°	6°	15°	1 in-lb	2.4 in-oz	10316H299
 Nylon rod	10°	6°	15°	2 in-lbs	2.4 in-oz	10316H296
 Wire	10°	6°	15°	2 in-lbs	2.4 in-oz	10316H484
 Cat whisker	15°	5°	30°	0.63 in-lb	1.7 in-oz	10316H341

Notes

^① For operating levers, see **Page V8-T2-80**.

^② For wobble operators, see **Page V8-T2-80**.

Technical Data and Specifications

Non Plug-In Switches

Description	Specification
Contact rating	NEMA A600, R300 double break-make snap action contacts
Electrical life	500,000 operations minimum
Mechanical life	5,000,000 operations minimum at full load
Conduit entrance	0.5 in (12.7 mm) NPT
Material of construction	Zinc die cast
Enclosure rating	NEMA 1, 4, 13
Ambient operating temperature	-20° to 200°F (-29° to 93°C) ①
Approximate shipping weight	2 lbs

Electrical Data—Maximum Contact Ratings per Pole ②

AC Volts	Current, Amperes		Cont. Thermal Ratings	Volts, Amperes		DC Volts	DC Current, Ampere
	Make	Break		Make	Break		
NEMA A600, R300 Rating							
120	60	6	10	7200	720	125	0.22
240	30	3	10	7200	720	250	0.11
480	15	1.5	10	7200	720	250	0.11
600	12	1.2	10	7200	720	250	0.11

Dimensions

Approximate Dimensions in Inches or Inches (mm)

Side Rotary Operated Head with Switch

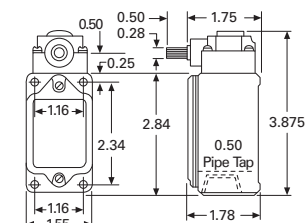

(2) 0.203 Dia. Holes for Front Mtg.
(2) 10-32 Tapped Holes 0.375 Deep for Rear Mtg.

Side Pushbutton, Adjustable

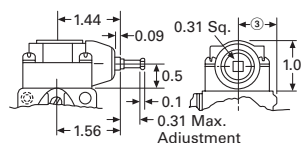

Top Pushbutton

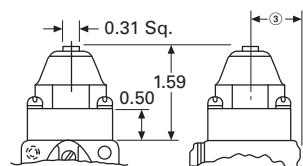

Side Push, Vertical Roller

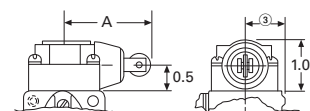

Dimension "A"

With 0.44 (11.2) dia. roller	1.78 (45.2)
With 0.75 (19.1) dia. roller	2.09 (53.1)

Side Push Maintained Contact

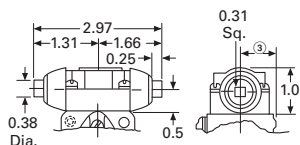

Top Push Roller

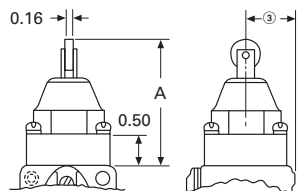

Dimension "A"

With 0.44 (11.2) dia. roller	2.03 (51.6)
With 0.75 (19.1) dia. roller	2.34 (59.4)

Wobble Operators

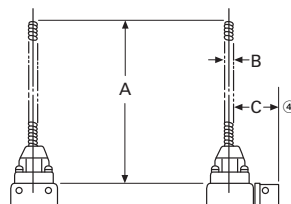

A	B	C
Wobble Spring		
5.44 (138.2)	0.31 (7.9)	0.81 (20.6)
Wire Wobble Stick		
12.5 (317.5)	0.08 (2.0)	0.81 (20.6)
Nylon Wobble Stick		
4.5 (114.3)	0.25 (6.4)	0.81 (20.6)

Notes

- ① Ranges below 32°F (0°C) are based on absence of freezing moisture or water.
- ② Contacts must be same polarity when both circuits are used.
- ③ Dimension from centerline of head to mounting surface is 0.78 in (20 mm).
- ④ Center to mounting surface.

Hazardous Location Limit Switches

2



Hazardous Location Limit Switches

Product Description

Type LX, CX and CBX limit switches by Eaton's electrical sector are designed for extreme environmental service in NEMA 7-9 locations where the danger of an internal or external explosion of flammable gases, vapors, metal alloy or grain dust exists. Type CB provides excellent corrosion resistant properties in NEMA 4X applications. Markets served include mining, grain storage, forest products, petrochemical, pharmaceutical and waste and sewage management.

Features

- Sealed and unsealed versions available
- One-way gasket on sealed version keeps liquids out, yet allows a harmless release of gases in the event of an internal explosion
- Silicon bronze housing provides excellent corrosion resistant properties in extreme NEMA 4X applications
- Temperature buildup on limit switch surface is dissipated by housing design and materials used
- Utilizes the operating heads and internal switch mechanisms of the 10316 L non plug-in line

Contents

Description

	<i>Page</i>
Hazardous Location Limit Switches	
Product Selection	V8-T2-93
Technical Data and Specifications	V8-T2-94
Dimensions	V8-T2-91

Standards and Certifications

- cUL



NEMA Ratings Comparison

Switch Type	LX	CX	CBX	CB ①
NEMA 1, 4, 13	—	✓	✓	✓
NEMA 4X	—	—	✓	✓
NEMA 7 Division I, Class I, BCD	✓	✓	✓	—
NEMA 9 Division I, Class II, EFG	✓	✓	✓	—

Note

① Not rated for explosive locations.

⚠ DANGER

THIS SENSOR IS NOT A SAFETY DEVICE AND IS NOT INTENDED TO BE USED AS A SAFETY DEVICE. This sensor is designed only to detect and read certain data in an electronic manner and perform no use apart from that, specifically no safety-related use. This sensor product does not include self-checking redundant circuitry, and the failure of this sensor product could cause either an energized or de-energized output condition, which could result in death, serious bodily injury, or property damage.

For the most current information on this product, visit our Web site: www.eaton.com

For Customer Service in the U.S. call 1-877-ETN CARE (386-2273), in Canada call 1-800-268-3578. For Application Assistance in the U.S. and Canada call 1-800-426-9184.

Product Selection

Complete Assembled Switches with Spring Return Heads ^①

Operating Data—Nominal

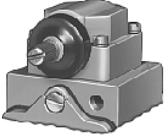
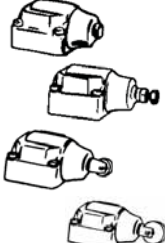
Head Type	Travel to Operate Contacts	Travel to Reset Contacts	Total Travel	Force to Operate Contacts	Minimum Return Force	Body Type	Contacts	Catalog Number	
Side Rotary Operated ^② 	Standard, 10° Pre-Travel ^③								
	10°	4°	50°	3.0 in-lbs	4.5 in-oz	Type LX	1NO-1NC ^④	10316H1002	
							2NO	10316H1039	
							1NO and 1NC ^④	10316H1049	
							2NC	10316H1059	
						Type CX	1NO-1NC ^④	10316H2200	
							1NO and 1NC ^④	10316H2176	
							2NC	10316H2178	
						Type CB	1NO-1NC ^④	10316H2149	
							2NC	10316H2140	
						Type CBX	1NO-1NC ^④	10316H2168	
							2NC	10316H2159	
		Narrow Differential 5° Pre-Travel ^③							
	5°	2°	50°	6.0 in-lbs	4.5 in-oz	Type LX	1NO-1NC ^④	10316H1146	
						Type CX	1NO-1NC ^④	10316H2197	
	Neutral Position, 18° Pre-Travel ^③								
18°	6°	50°	1.8 in-lbs	2.5 in-oz	Type LX	2NO	10316H1071		
						2NC	10316H1072		
					Type CX	2NO	10316H2179		
					Type CBX	2NC	10316H2160		
Side Push Operated 	Pushbutton								
	0.07 in (1.8 mm)	0.03 in (0.76 mm)	0.29 in (7.4 mm)	4 lbs	8 oz	Type LX	1NO and 1NC ^④	10316H1213	
	Adjustable Pushbutton								
	0.07 in (1.8 mm)	0.03 in (0.76 mm)	0.29 in (7.4 mm)	4 lbs	8 oz	Type LX	1NO-1NC ^④	10316H1192	
	Vertical Roller, 0.44 in (11.2 mm) Diameter								
	0.07 in (1.8 mm)	0.03 in (0.76 mm)	0.29 in (7.4 mm)	4 lbs	8 oz	Type LX	1NO-1NC ^④	10316H1007	
Vertical Roller, 0.75 in (19.1 mm) Diameter									
0.07 in (1.8 mm)	0.03 in (0.76 mm)	0.29 in (7.4 mm)	4 lbs	8 oz	Type LX	1NO-1NC ^④	10316H1194		

Notes

- ① Contact Eaton's Sensor Applications Engineering at 1-800-426-9184 for replacement contact blocks.
- ② For operating levers, see **Page V8-T2-80**. Only levers with Nylatron rods or rollers should be used with explosion-proof limit switches.
- ③ Field convertible to clockwise only or counterclockwise only operation.
- ④ 1NO-1NC contacts must be same polarity when both circuits are used—1NO and 1NC contacts have isolated poles and may be used on opposite polarity.
- ⑤ Neutral position switches operate one circuit in each direction.

Complete Assembled Switches with Spring Return Heads, continued ^①

Operating Data—Nominal

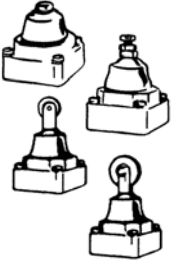
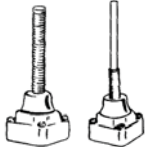
Head Type	Travel to Operate Contacts	Travel to Reset Contacts	Total Travel	Force to Operate Contacts	Minimum Return Force	Body Type	Contacts	Catalog Number
Top Push Operated 	Pushbutton							
	0.04 in (1 mm)	0.02 in (0.5 mm)	0.28 in (7.1 mm)	4 lbs	8 oz	Type LX	1NO-1NC ^②	10316H1004
						Type CX	1NO and 1NC ^②	10316H2188
	Adjustable Pushbutton							
	0.04 in (1 mm)	0.02 in (0.5 mm)	0.28 in (7.1 mm)	4 lbs	8 oz	Type LX	1NO-1NC ^②	10316H1191
							1NO and 1NC ^②	10316H1212
	Roller, 0.44 in (11.2 mm) Diameter							
	0.04 in (1 mm)	0.02 in (0.5 mm)	0.28 in (7.1 mm)	4 lbs	8 oz	Type LX	1NO-1NC ^②	10316H1006
						Type CBX	1NO-1NC ^②	10316H2170
	Roller, 0.75 in (19.1 mm) Diameter							
0.04 in (1 mm)	0.02 in (0.5 mm)	0.28 in (7.1 mm)	4 lbs	8 oz	Type LX	1NO-1NC ^②	10316H1193	
Wobble Operated 	Spring							
	10° ^③	6°	15°	1 in-lb	2.4 in-oz	Type LX	1NO-1NC ^②	10316H1237
	Nylon Rod							
	10° ^③	6°	15°	2 in-lbs	5.6 in-oz	Type LX	1NO-1NC ^②	10316H1009

Technical Data and Specifications

Hazardous Location Limit Switches

Description	Specification
Material of construction	
LX, CX	Cast aluminum die cast
CB, CBX	Silicon bronze
Conduit entrance	
LX	1/2 in pipe tap
CB, CBX, CX	3/4 in pipe tap
Mounting	Surface mount
Enclosure rating	
LX, CX, CBX	NEMA 7 Div. 1, Class I BCD; NEMA 9 Div. 1, Class II, EFG ^④
CB, CBX	NEMA 1, 4, 4X, 13 ^④
CX	NEMA 1, 4, 13 ^④
Ambient operating temperature	-20° to 200°F (-29° to 93°C) ^⑤
Approximate shipping weight	
LX	2 lbs
CX	2.5 lbs
CB, CBX	6 lbs

Notes

- ^① Contact Eaton's Sensor Applications Engineering at 1-800-426-9184 for replacement contact blocks.
- ^② 1NO-1NC contacts must be same polarity when both circuits are used—1NO and 1NC contacts have isolated poles and may be used on opposite polarity.
- ^③ Travel with force applied at one-in (25.4 mm) radius. Applied at end of operator, travel is approximately 14.
- ^④ A conduit seal-off kit is required for these switches
- ^⑤ Ranges below 32°F (0°C) are based on absence of freezing moisture or water.

Electrical Data—Maximum Contact Ratings, per Pole

AC Volts	Current, Amperes			Volt Amperes		DC Volts	DC Current, Ampere
	Make	Break	Cont. ①	Make	Break		
1NO-1NC Switches							
NEMA A600, R300 rating							
120	60	6	10	7200	720	125	0.2
240	30	3	10	7200	720	250	0.1
480	15	1.5	10	7200	720	250	0.1
600	12	1.2	10	7200	720	250	0.1
All Other Switches, B600							
120	30	3	5	3600	360	120	0.1
240	15	1.5	5	3600	360	240	0.05
480	7.5	0.75	5	3600	360	240	0.05
600	6	0.60	5	3600	360	240	0.05

Dimensions

Approximate Dimensions in Inches or Inches (mm)

Type LX Switch with Side Rotary Head

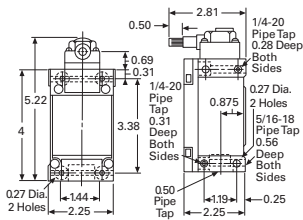

Side Pushbutton Head

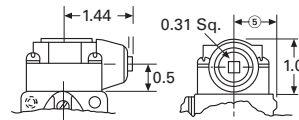

Top Pushbutton Head

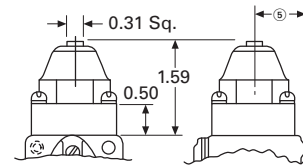

Side Push, Vertical Roller Head

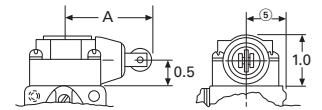

Dimension "A"

With 0.44 (11.2) dia. roller	1.78 (45.2)
With 0.75 (19.1) dia. roller	2.09 (53.1)

Type CX, CB and CBX Switches with Side Rotary Head

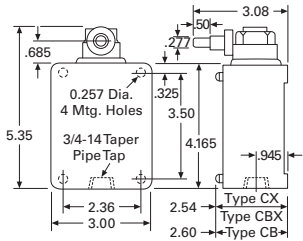

Adjustable Top Pushbutton Head

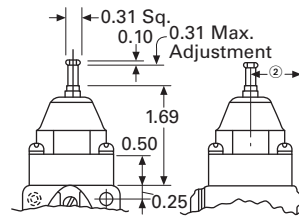

Wobble Operators

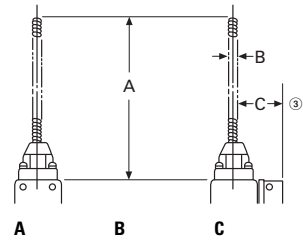

Notes

- 1NO-1NC contacts must be same polarity when both circuits are used—1NO and 1NC contacts have isolated poles and may be used on opposite polarities.
- Dimension from centerline of head to mounting surface is 0.78 in (20 mm).
- Center to mounting surface.

Adjustable Side Pushbutton Head

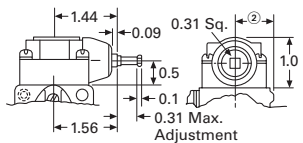

Top Push Roller Head

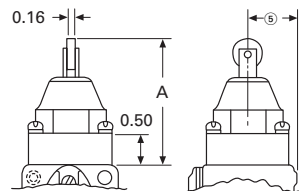

Dimension "A"

With 0.44 (11.2) dia. roller	2.03 (51.6)
With 0.75 (19.1) dia. roller	2.34 (59.4)

Wobble Spring

5.44 (138.2)	0.31 (7.9)	0.94 (23.9)
--------------	------------	-------------

Nylon Red

4.5 (114.3)	0.25 (6.4)	0.94 (23.9)
-------------	------------	-------------

Special Purpose Limit Switches

2



Contents

Description	Page
Special Purpose Limit Switches	
Product Selection	
Roller Lever Switches	V8-T2-97
Rotating Shaft Switches	V8-T2-97
Pneumatic Time Delay Switches	V8-T2-98
Precision Switches	V8-T2-98
Technical Data and Specifications	V8-T2-99
Dimensions	V8-T2-101

Special Purpose Limit Switches

Product Description

Special Purpose (Type F), Rotating Shaft (Type J), Pneumatic Time Delay (Type LP) and Precision and Cabinet Door Interlock (Type PS) Limit Switches from Eaton's electrical sector serve a variety of special purpose industrial applications for MRO and User Replacement requirements.

Features

- UL Listed
- CSA Certified (PS and J only)

Standards and Certifications

Type J

- UL Listed
- CSA Certified

Type LP

- UL Listed

Type PS

- UL Recognized
- CSA Certified



⚠ DANGER

THIS SENSOR IS NOT A SAFETY DEVICE AND IS NOT INTENDED TO BE USED AS A SAFETY DEVICE. This sensor is designed only to detect and read certain data in an electronic manner and perform no use apart from that, specifically no safety-related use. This sensor product does not include self-checking redundant circuitry, and the failure of this sensor product could cause either an energized or de-energized output condition, which could result in death, serious bodily injury, or property damage.

For the most current information on this product, visit our Web site: www.eaton.com

For Customer Service in the U.S. call 1-877-ETN CARE (386-2273), in Canada call 1-800-268-3578.
For Application Assistance in the U.S. and Canada call 1-800-426-9184.

Product Selection

Roller Lever Switches

Roller Lever



Type F Switches ^①

Operator	Circuit	Travel to Operate Contacts	Travel to Reset Contacts	Total Travel	Over-Travel	Catalog Number
Roller lever (CW and CCW operation, spring return)	1NO-1NC	40°	35°	65°	25°	10316H18
	2NO-2NC	17°	6°	60°	43°	10316H320

Rotating Shaft Switches

Type J

Rotating Shaft Limit Switches allow the shaft to be rotated a preset number of revolutions (adjustable from 1/2 to 100 with an accuracy of 1/20 of a turn) before the contacts will switch. A second set of

contacts will trip when reaching a preset limit in the opposite direction. These switches are typically used in crane and hoist applications to provide end of travel stops for the hook assembly.

Rotating Shaft



Type J Switches

Shaft to Cam Ratio	Max. Turns to Trip Contacts	Min. Turns to Trip Contacts	Over-Travel Before Resetting Contacts	Reversal After Tripping to Reset Contacts	Circuit ^②	Enclosure Rating	Catalog Number
103:1	100 input shaft turns	1/2 input shaft turns	103 input shaft turns max.	1/8 input shaft turns min.	2NC	NEMA 1	10316H50
					2NO-2NC ^③	NEMA 4	10316H54 ^③

Notes

- ① Replacement operator head is available with part number **86-862-22**. Replacement roller lever is available with part number **24-1712**. Replacement key pin and washer for roller is available with part number **16-906**.
- ② For replacement NO contacts, order **17-1403**; NC contacts, order **17-702**.
- ③ 10316H54 has factory set circuits, but is easily convertible to any of three circuits (2NO-2NC, 4NO or 4NC). Full instructions enclosed with every switch.

Pneumatic Time Delay Switches

2

Pneumatic Time Delay**Type LP Switches**

Operator	Total Travel	Pre-Travel	Circuit	Timed Contacts	Direction of Rotation ^②	Catalog Number
Side rotary (Spring return to center) ^①	50°	10°	1NO-1NC	ON delay	CW	10316H1580
					CW and CCW	10316H1600
				OFF delay	CW	10316H1610
					CW and CCW	10316H1630

Precision Switches**Cabinet Door Interlock****Type PS Switches**

Operator	Circuits— SPDT 1NO-1NC Catalog Number	Circuits— DPDT 2NO-2NC Catalog Number	Operator Only Catalog Number
Precision Switch Devices			
Precision switch only	10316H89	10316H2000	—
Pushbutton with oiltight plunger	—	10316H2006	—
Roller with oiltight plunger perpendicular to mounting holes	—	10316H2012	—
Roller with oiltight plunger in line with mounting holes	10316H110	—	—
6 in lever with top and right-hand mounting bracket	10316H113	—	10316H143
6 in lever with top and left-hand mounting bracket	—	—	10316H144
Roller lever with top and right-hand mounting bracket	10316H119	—	10316H145
Roller lever with top and left-hand mounting bracket	10316H122	—	10316H146
One way roller lever with top and right-hand mounting bracket	—	—	10316H147
One way roller lever with top and left-hand mounting bracket	—	—	10316H148
Cabinet Door Interlocks			
Precision switch only	10316H828	10316H829A	—
Cabinet door interlock operator with one precision switch and with red (defeated ^③) indicator	10316H1028	10316H2042	10316H150
Cabinet door interlock operator with two each of listed precision switches and with red (defeated ^③) indicator	10316H1029	—	—

Notes

- ① Requires an operating lever, see **Page V8-T2-80**.
 ② Field convertible.
 ③ The plunger exposes a red band when pulled out to indicate that interlock is defeated.

Technical Data and Specifications

Special Purpose Limit Switches

Description	Specification
Roller Lever Switches— Type F	
Enclosure rating	NEMA 4
Operating temperature	0° to 180°F (–18° to 82°C)
Conduit entrance	0.5 in NPT
Shipping weight	4.0 lbs
Rotating Shaft Switches— Type J	
Shipping weight	
NEMA 1 models	5.5 lbs
NEMA 4 models	13 lbs
Pneumatic Time Delay Switches— Type LP	
Timing range	0.05 to 60 seconds
ON delay function	Timing begins when lever is actuated and held
OFF delay function	Timing begins when lever is released
Repeat accuracy ^①	With 15 second or higher interval between timing periods: ±10% of setting maximum With less than 15 second interval between timing periods: ±25% of setting maximum
Operating frequency	250 operations per minute maximum
Enclosure rating	NEMA 4, 13
Ambient operating temperature	32° to 150°F (0° to 65°C)
Conduit entrance	0.5 in NPT
Shipping weight	2 lbs

Note

^① To maintain operating accuracy during the timing cycle, the switch lever must be faster than the timed setting.

Type F—Maximum Ampere Ratings

Circuit	State	AC Volts				DC Volts		
		120	240	480	600	120	240	600
1NO-1NC	Make	60	30	20	15	—	—	—
	Break	6	3	1.5	1.2	2.2	1.1	0.40
2NO-2NC	Make	40	20	10	8	—	—	—
	Break	15	10	6	5	0.5	0.2	0.02

Type J—Maximum Ampere Ratings

State	AC Volts				DC Volts		
	120	240	480	600	120	240	600
Make	60	30	15	12	2.2	1.1	—
Break	6	3	1.5	1.2	2.2	1.1	—
Continuous ^①	10	10	10	10	10	10	—

Type LP— Electrical Data, Maximum Contact Ratings/Pole

AC Volts	Current, Amperes			Volt Amperes		DC Volts	DC Current Amperes
	Make	Break	Cont. ^①	Make	Break		
All Switches 1NO-1NC							
NEMA A600, R300 Rating							
120	60	6	10	7200	720	120	0.2
240	30	3	10	7200	720	240	0.1
480	15	1.5	10	7200	720	240	0.1
600	12	1.2	10	7200	720	240	0.1

Type PS—Maximum Ampere Ratings

Type	State	AC Volts				DC Volts Double Throw		
		120	240	480	600	120	240	600
Heavy-Duty 1/2 hp, 250 Vac Maximum								
Single-pole	Make	40	20	10	8	2.0	0.5	0.1
	Break	15	10	6	5	0.5	0.2	0.02
Double-pole	Make	30	15	8	6	0.5	0.2	0.2
	Break	3	1.5	1	0.8	0.2	0.1	—

Note

^① Thermal rating. Valid only if switch does not have to make or break.

Dimensions

Approximate Dimensions in Inches (mm)

Roller Lever Switches

Type F

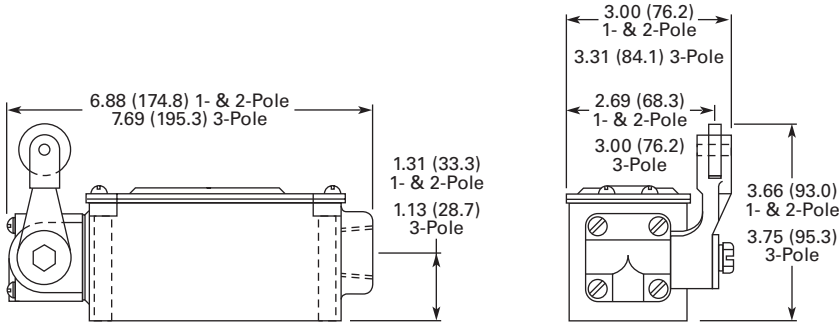

Approximate Dimensions in Inches only

Rotating Shaft Switches

Type J—NEMA 1 Models

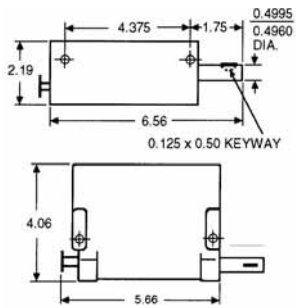

Type J—NEMA 4 Models

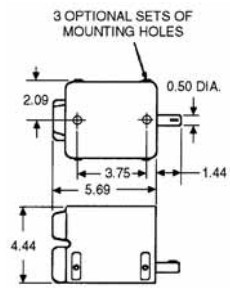

Pneumatic Time Delay Switches

Type LP

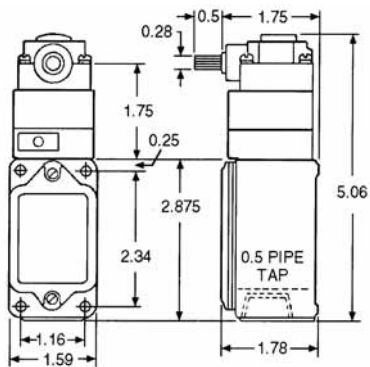

Approximate Dimensions in Inches [mm]

2

Precision Switches

Type PS

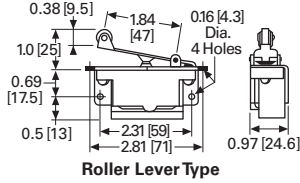
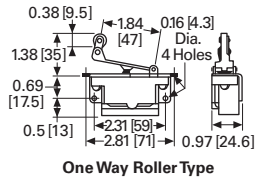
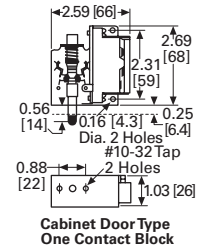
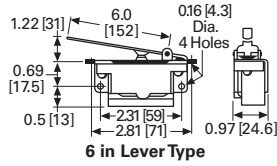
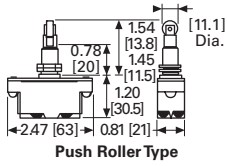
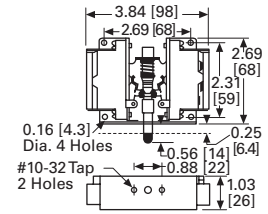
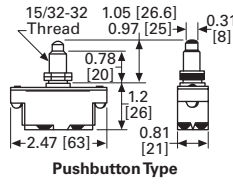
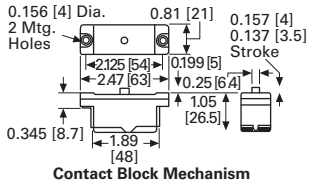

iProx



E57P Performance



AccuProx



E56 Pancake



Nonmetallic Tubular



E52 Cube Style



E51, Factory Sealed



3.0 Introduction	Quick Reference Guide	V8-T3-2
3.1 iProx Sensors	Product Description	V8-T3-11
3.2 E57P Performance Series Sensors	Product Description	V8-T3-18
3.3 E57PS Performance Short Body Sensors	Product Description	V8-T3-24
3.4 E57G General Purpose Proximity Sensors	Product Description	V8-T3-29
3.5 E57 Two-Wire (AC, AC/DC, DC) Proximity Sensors	Product Description	V8-T3-35
3.6 AccuProx Analog Sensors	Product Description	V8-T3-49
3.7 Ferrous Only Tubular Sensors	Product Description	V8-T3-55
3.8 Metal Face Sensors	Product Description	V8-T3-58
3.9 High Current Output Sensors	Product Description	V8-T3-62
3.10 Small Diameter (4, 5, 6.5, 8 mm) Sensors	Product Description	V8-T3-65
3.11 E56 Pancake Sensors	Product Description	V8-T3-71
3.12 Nonmetallic Tubular Sensors	Product Description	V8-T3-76
3.13 E52 Cube Style Sensors	Product Description	V8-T3-79
3.14 E52 Rectangular Style Sensors	Product Description	V8-T3-83
3.15 E55 Limit Switch Style Sensors with Nonmetallic Housings	Product Description	V8-T3-86
3.16 E51 Modular Limit Switch Style Sensors	Product Description	V8-T3-88
3.17 E51 Limit Switch Style, Factory Sealed 6P+ Sensors	Product Description	V8-T3-97



Unless otherwise noted, the products contained in this section should not be used for functional safety applications. These products were not designed or tested to IEC 60947-5-3 or recommended for functional safety.

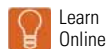

Learn
Online

For Customer Service in the U.S. call 1-877-ETN CARE (386-2273),
in Canada call 1-800-268-3578.
For Application Assistance in the U.S. and Canada
call 1-800-426-9184.

Quick Reference Guide

Inductive Proximity Sensors

3

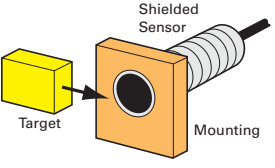
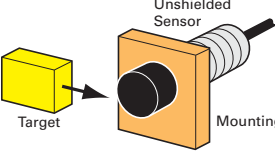
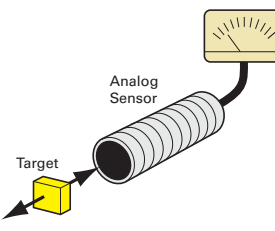
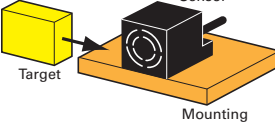
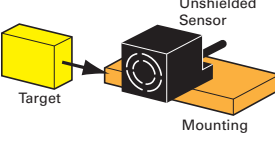
Sensing Application	Sensing Style	Size	Max Range	Product Family	Page
	Shielded tubular	4 mm	0.8 mm	Small Diameter Sensors	V8-T3-65
		5 mm	0.8 mm	Small Diameter Sensors	V8-T3-65
		6.5 mm	1 mm	Small Diameter Sensors	V8-T3-65
		8 mm	3 mm	Small Diameter Sensors	V8-T3-65
		12 mm	4 mm	iProx™ Sensors	V8-T3-11
			4 mm	E57P Performance Sensors	V8-T3-18, V8-T3-24
			4 mm	E57G General Purpose Sensors	V8-T3-29
		18 mm	8 mm	iProx Sensors	V8-T3-11
			8 mm	E57P Performance Sensors	V8-T3-18, V8-T3-24
			8 mm	E57G General Purpose Sensors	V8-T3-29
30 mm	15 mm	iProx Sensors	V8-T3-11		
	15 mm	E57P Performance Sensors	V8-T3-18, V8-T3-24		
	15 mm	E57G General Purpose Sensors	V8-T3-29		
	Unshielded tubular	6.5 mm	2 mm	Small Diameter	V8-T3-65
		8 mm	6 mm	Small Diameter	V8-T3-65
		12 mm	10 mm	iProx Sensors	V8-T3-11
			8 mm	E57P Performance Sensors	V8-T3-18, V8-T3-24
			8 mm	E57G General Purpose Sensors	V8-T3-29
		18 mm	18 mm	iProx Sensors	V8-T3-11
			12 mm	E57P Performance Sensors	V8-T3-18, V8-T3-24
			12 mm	E57G General Purpose Sensors	V8-T3-29
30 mm	29 mm	iProx Sensors	V8-T3-11		
	22 mm	E57P Performance Sensors	V8-T3-18, V8-T3-24		
	22 mm	E57G General Purpose Sensors	V8-T3-29		
	Analog tubular	12 mm	8 mm	AccuProx™ Analog Sensors	V8-T3-49
		18 mm	15 mm	AccuProx Analog Sensors	V8-T3-49
		30 mm	25 mm	AccuProx Analog Sensors	V8-T3-49
	Shielded cube	40 x 40 x 40 mm	20 mm	E52 Cube Style Sensors	V8-T3-79
	Unshielded cube	40 x 40 x 40 mm	40 mm	E52 Cube Style Sensors	V8-T3-79

Inductive Proximity Sensors, continued

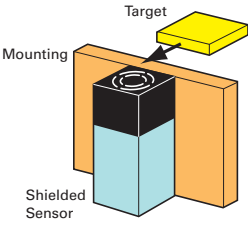
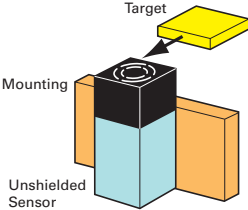
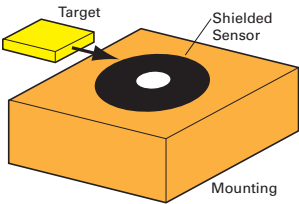
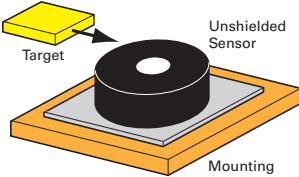
Sensing Application	Sensing Style	Size	Max Range	Product Family	Page
	Shielded limit switch	118 x 40 x 40 mm 114 x 39 x 38.4 mm	13 mm	E51 Modular Limit Switch Style Sensors E51 Limit Switch Style, Factory Sealed 6P+ Sensors E55 Limit Switch Style Sensors with Nonmetallic Housings	V8-T3-88, V8-T3-97
	Unshielded limit switch	118 x 40 x 40 mm 114 x 39 x 38.4 mm	24 mm	E51 Series E55 Series	V8-T3-88, V8-T3-97
	Shielded pancake	79 x 79 x 39 mm	40 mm	E56 Series	V8-T3-71
	Unshielded pancake	79 x 79 x 39 mm 110 x 110 x 41 mm 171.5 x 171.5 x 67.5 mm	100 mm	E56 Series	V8-T3-71

Technical Reference

Inductive Proximity Sensors

3



General

There are a number of factors which should be considered when applying induction proximity sensors. A detailed discussion of these factors can be found on **Page V8-T12-4**. Presented below are a few of the more important considerations for quick reference.

Mounting

Inductive proximity sensors are available in two classifications: shielded (also known as embeddable or flush mountable) and unshielded (non-embeddable or non-flush mountable). What these terms refer to is the distance to surrounding metal that the device can be mounted. In the case of a shielded sensor the device can be mounted with the sensor completely surrounded by metal.

In the case of an unshielded sensor, a metal free zone must be provided when mounting the sensor. The size of the metal free zone is dependent on both the size of the sensor and the type of sensing range it has, for example, standard or extended.

Mounting Ranges

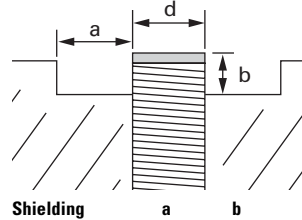

Shielding	a	b
Standard Range		
Shielded	0	0
Unshielded	2 x Sn	Cap height
Extended Range		
Semi-shielded	Sn	d
Non-embeddable	2 x Sn	Cap height

Where **a** and **b** are the metal free dimensions.

When mounting the sensors, do not exceed the following recommended torque specifications.

Torque Specifications

Stainless Steel	Nickel-Plated Brass
12 mm Diameter	
35 lb-in (4.0 Nm)	20 lb-in (2.3 Nm)
18 mm Diameter	
70 lb-in (7.9 Nm)	70 lb-in (7.9 Nm)
30 mm Diameter	
70 lb-in (7.9 Nm)	70 lb-in (7.9 Nm)

Extended Range Sensors

Extended range proximity sensors by Eaton’s Electrical Sector offer sensing distances almost three times greater than conventional devices. They are available in semi-shielded designs: mounted similar to an embeddable sensor—and non-embeddable designs requiring more metal free zone area than conventional unshielded sensors. All are available in a variety of circuits and terminations.

Target Material

When manufacturers of inductive proximity sensors state the sensing range of their devices, they are usually based upon a ferrous target made of carbon-rolled steel (IE FE 360) defined by ISO630. For example, in this product guide the E57P-18SPN5-C2 has a sensing range of 5 mm based upon a target of mild steel.

Sensing ranges to targets made of non-ferrous metals have to have a correction factor applied as listed in the table below. To use this table, multiply the sensing distance of the device by the factor given.

Example: The E57P-18SPN5-C2 has a sensing range of 5 mm. When used to sense a brass target, the sensing range becomes 2.25 mm (5 mm x 0.45).

Table of Correction Factors

Multiply sensing range of device by factor given below.

Correction Factors

Target	Sensor Size				Limit Switch
	4–8 mm	12 mm	18 mm	30 mm	
Stainless steel 400	0.90	0.90	1.0	1.0	1.0
Stainless steel 300	0.65	0.70	0.70	0.75	0.85
Brass	0.35	0.45	0.45	0.45	0.5
Aluminum	0.35	0.40	0.45	0.40	0.47
Copper	0.30	0.25	0.35	0.30	0.40

Target Size

Often overlooked when applying sensors is the fact that the manufacturer’s stated sensing ranges are also dependent upon target size. The table below reflects the standard target sizes which were used to determine sensing ranges.

If targets are the same size or greater than standard, no reduction in sensing distance will occur. However, a smaller target size will result in a decrease in sensing range.

A general rule of thumb is that the target size shall be three times the range or the size of the sensor face, whichever is larger.

Standard Target Size ①

Target	Standard Sensing Range		Extended Sensing Range	
	Shielded Devices	Unshielded Devices	Semi-Shield Devices	Non-Embeddable Devices
4 mm	4 mm square	4 mm square	—	—
5 mm	5 mm square	5 mm square	—	—
6.5 mm	6.5 mm square	6.5 mm square	—	—
8 mm	8 mm square	8 mm square	—	—
12 mm	12 mm square	12 mm square	18 mm square	30 mm square
18 mm	18 mm square	24 mm square	36 mm square	60 mm square
30 mm	30 mm square	45 mm square	66 mm square	—
Limit switch	45 mm square	72 mm square	—	—

Note

① Targets are 1 mm thick.

Product Selection Guide

iProx

E57P Performance Series

E57PS Performance Short Body

E57G General Purpose

3



Page V8-T3-11

Overview

Designed to be the highest performing tubular inductive sensor. Standard features include extended sensing ranges, high noise-immunity, extreme durability and includes Autoconfigure Technology. Advanced features include output delay, speed detection and cloning with ProxView Software.

Applications

Automotive, machine tool, material handling where high sensing performance and inventory consolidation is a priority.

Product Features

Auto-configure technology automatically detects a sinking (NPN) or sourcing (PNP) connection and switches the sensor accordingly, without any user intervention. Optional computer programming cable and Windows-based ProxView configuration software makes it easy to customize sensors.

Clone the sensor to match the characteristics of more than 4,800 competitive models, or configure it to match your specific application needs.

Advanced programmable features such as dual outputs, output delay, speed detection and more.

Technical Data and Specifications

Current ratings—

AC: 250 mA

DC: 300 mA

Enclosure ratings—

NEMA® 4, 4X, 6, 6P, 12, 13

IEC IP67, IP69K

Construction—

Stainless steel

Approvals

cUL® Listed



Page V8-T3-18

Overview

High performance inductive sensors. Extended and standard ranges available.

Applications

Automotive, machine tool, material handling where high sensing performance and inventory consolidation is a priority.

Product Features

12, 18 and 30 mm diameters

Three-wire DC sensors

360° LED indicators standard

NO or NC outputs

Short-circuit protection

Resettable short-circuit protected and reverse polarity on select models

Robust stainless steel tubes, shock-resistant front caps, polycarbonate end bells, and impact-absorbing potting compound are resistant to physical and environmental abuse in high temperature, high pressure washdown and high shock and vibration applications.

Technical Data and Specifications

Current ratings—

DC: 300 mA

Enclosure ratings—IP67, IP69K;

NEMA 4, 4X, 6, 6P

Construction—

Stainless steel housing and nuts

Approvals

CE

cULus Listed



Page V8-T3-24

Overview

High performance inductive sensors with the ability to fit into tighter spaces.

Applications

Automotive, machine tool, material handling where high sensing performance and inventory consolidation is a priority.

Product Features

12, 18 and 30 mm diameters

Three-wire DC sensors

360° LED indicators standard

NO or NC outputs

Short-circuit protection

Resettable short-circuit protected and reverse polarity on select models

Robust stainless steel tubes, shock-resistant front caps, polycarbonate end bells, and impact-absorbing potting compound are resistant to physical and environmental abuse in high temperature, high pressure washdown and high shock and vibration applications.

Technical Data and Specifications

Current ratings—

DC: 300 mA

Enclosure ratings—IP67, IP69K;

NEMA 4, 4X, 6, 6P

Construction—

Stainless steel housing and nuts

Approvals

CE

cULus Listed



Page V8-T3-29

Overview

This full-line, tubular proximity sensor family provides a cost-effective solution for high volume OEM use.

Applications

Machine tool detection, press applications, cam detection, material handling, valve and shaft position, automotive assembly.

Product Features

12, 18 and 30 mm diameters

Three-wire DC sensors

360° LED indicators standard

NO or NC outputs

Short-circuit protection

Resettable short-circuit protected and reverse polarity on select models

Robust stainless steel tubes, shock-resistant front caps, polycarbonate end bells, and impact-absorbing potting compound are resistant to physical and environmental abuse in high temperature, high pressure washdown and high shock and vibration applications.

Technical Data and Specifications

Current ratings—

DC: 100 mA

Enclosure ratings—IP67;

NEMA 4, 4X, 6, 6P

Construction—

Stainless steel housing and nickel-brass nuts

Approvals

CE

cULus Listed



E57 Two-Wire (AC, AC/DC, DC) Proximity



Page V8-T3-35

Overview

Various models available in two-wire configurations:
 Stainless steel (AC, AC/DC)
 Stainless steel short body (AC, AC/DC)
 Nickel-brass (AC, DC)

Applications

Machine tool detection, press applications, cam detection, material handling, valve and shaft position, automotive assembly.

Product Features

12, 18 and 30 mm diameters
 Two-wire AC, AC/DC, DC
 Shielded and unshielded models
 Standard and extended ranges
 LED indicators
 Cable and micro-connector
 NO or NC outputs

Technical Data and Specifications

Stainless steel:
 Current ratings—
 500 mA maximum
 Enclosure ratings—IP67, IP69K;
 NEMA 4, 4X, 6, 6P, 12, 13
 Nickel-Brass:
 Current ratings—
 200 mA (AC); 100 mA (DC)
 Enclosure ratings—
 IP69K, IP67

Approvals

cULus (Stainless Steel)
 cCSAus (Nickel-Brass)
 CE (SS: AC/DC only, NiBr: DC only)



AccuProx



Page V8-T3-49

Overview

AccuProx sensors feature analog outputs that change linearly as the target moves closer or further from the sensor face.

Applications

Part positioning, distance, size and thickness measurement, general inspection and error proofing (such as material imperfection or blemish detection), eccentricity or absolute angle detection, identification of different metals

Product Features

Extended linear sensing range of up to 25 mm—three times longer than standard tubular analog inductive sensors
 Outputs available in current (4–20 or 0–20 mA) and voltage (0–10 V)
 High output resolution and repeatability for applications requiring precision sensing performance
 Robust stainless steel barrel, shock-resistant front cap, polycarbonate end bell and impact-absorbing potting compound
 Ideal for extreme temperature or high pressure washdown environments

Technical Data and Specifications

Current ratings—
 0–10 Vdc, 0–20 mA, 4–20 mA
 Enclosure ratings—
 NEMA 4, 4X, 6, 6P, 13
 Construction—
 Stainless steel

Approvals

cUL Listed



Ferrous Only Tubular



Page V8-T3-55

Overview

Sensors designed to detect only ferrous metals (steel/iron).

Applications

Workcell applications, automotive and aircraft production.

Product Features

18 mm diameters
 Two-wire AC or three-wire DC
 NO or NC outputs
 Micro- and mini-pin terminations
 LED indicators

Technical Data and Specifications

Current ratings—
 AC: 500 mA continuous
 DC: 200 mA continuous
 Enclosure ratings—
 NEMA 4, 4X, 6, 6P, 12, 13
 IEC IP67
 Construction—
 Stainless steel

Approvals

UL Listed
 CSA Certified



Metal Face



Page V8-T3-58

Overview

Tough sensors with thick stainless steel sensing faces and barrels.

Applications

Metal cutting operations where damage to sensor face could occur.

Product Features

12, 18 and 30 mm diameters
 Two-wire AC or three-wire DC
 20 mil thick stainless steel face
 303 stainless steel barrel
 LED indicator
 2-meter cable, micro- and mini-pin connections

Technical Data and Specifications

Current ratings—
 AC: 500 mA continuous
 DC: 200 mA continuous
 Enclosure ratings—
 NEMA 4, 4X, 6, 6P, 12, 13
 IEC IP67
 Construction—
 Stainless steel

Approvals

UL Listed
 CSA Certified



High Current Output



Page V8-T3-62

Overview

DC sensors which can carry extremely large continuous inrush current.

Applications

Heavy-duty vehicles, cement mixers, lift trucks, front end loaders, farm equipment.

Product Features

30 mm diameter stainless steel housing
Solid-state output for 12 ampere continuous, 50 ampere inrush capacity
-40° to 158°F (-40° to 70°C) temperature range
NO and NC isolated outputs
Heavy gauge SJO cable

Technical Data and Specifications

Current ratings—
Varies by model
Enclosure ratings—
NEMA 4, 4X, 6, 6P, 12, 13
IEC IP67
Construction—
Stainless steel

Approvals

—

Ferrous Only Tubular



Page V8-T3-55

Overview

Sensors designed to detect only ferrous metals (steel/iron).

Applications

Workcell applications, automotive and aircraft production

Product Features

18 mm diameters
Two-wire AC or three-wire DC
NO or NC outputs
Micro- and mini-pin terminations
LED indicators

Technical Data and Specifications

Current ratings—
AC: 500 mA continuous
DC: 200 mA continuous
Enclosure ratings—
NEMA 4, 4X, 6, 6P, 12, 13
IEC IP67
Construction—
Stainless steel

Approvals

UL Listed
CSA Certified



Small Diameter



Page V8-T3-65

Overview

Small diameter and short body (4, 5, 6.5 and 8 mm) tubular housings for tight sensing applications.

Applications

Automation equipment, robotics, machine tool, counting, sorting

Product Features

Variety of diameters in stainless steel housings
PVC cable, micro- and nano-pin connections
LED indicators standard
Short overall lengths
Short circuit and reverse polarity protection

Technical Data and Specifications

Current ratings—
DC: 200 mA maximum
Enclosure ratings—
NEMA 4, 4X, 6, 6P, 12, 13
IEC IP67
Construction—
Stainless steel

Approvals

CE



E56 Pancake



Page V8-T3-71

Overview

Self-contained sensors capable of sensing up to 3.94 inches (100 mm).

Applications

Oil rig operations, floor conveyors, automotive assembly, overhead cranes

Product Features

40, 50, 70 and 100 mm sensing distances
Four-wire DC models have complementary outputs (1 NO/1 NC)
Four-wire DC models use auto-configure technology, which allows the sensor to automatically adapt for NPN or PNP without user intervention
Available in two-wire AC versions
Power and output LED indicator
Quick disconnect option
Short-circuit protected in DC
Longest sensing distances available

Technical Data and Specifications

Current ratings—
AC: 500 mA continuous
DC: 200 mA continuous
Enclosure ratings—
NEMA 4, 4X, 12, 13
(some models also rated NEMA 6)
IEC IP66
Construction—
PPS

Approvals

cULus Listed



Tubular, Nonmetallic Housing



Page V8-T3-76

Overview

Tubular sensors with nonmetallic housings offer high corrosion resistance.

Applications

Food processing lines, high washdown environments

Product Features

12, 18 and 30 mm diameters shielded and unshielded sensing
 Normally open or closed outputs
 AC and DC voltages
 Tough ABS plastic housing
 Output LED on all models

Technical Data and Specifications

Current ratings—
 AC: 150 mA
 DC: 200 mA
 Enclosure ratings—
 NEMA 3, 3S, 4, 4X, 13
 IEC IP66
 Construction—
 ABS plastic

Approvals

—

E52 Cube Style



Page V8-T3-79

Overview

A family of industry-standard, cube-sized inductive sensors with long range capabilities.

Applications

Automotive, manufacturing, machinery OEMs

Product Features

Long inductive proximity ranges available (up to 40 mm sensing distance)
 Four-wire DC models have complementary outputs (1 NO/1 NC)
 Four-wire DC models use auto-configure technology, which allows the sensor to automatically adapt for NPN or PNP without user intervention
 Robust design featuring vibration and impact-absorbing potting compound
 Ideal for extreme temperatures or high pressure washdown environments

Technical Data and Specifications

Current ratings—
 DC: 300 mA maximum
 Enclosure ratings—
 NEMA 4, 4X, 6, 6P, 12, 13
 IEC IP67
 Construction—
 Zinc alloy/PPS, PL

Approvals

cULus Listed



E52 Rectangular Style

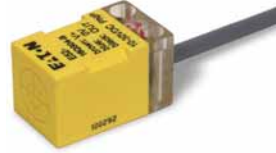

Page V8-T3-83

Overview

A variety of small rectangular sensors for limited space applications.

Applications

Tight applications where conventional sensor are too large

Product Features

Variety of housing styles R12, R18, Q16, Q25
 10 to 30 Vdc
 NPN and PNP output
 Short-circuit protection
 LED indicator for output status

Technical Data and Specifications

Current ratings—
 DC: 100 mA maximum
 Enclosure ratings—
 NEMA 1, 2, 3, 3S, 4, 12
 IEC IP66
 Construction—
 PBT composition housing

Approvals

—

E55 Limit Switch Style, Nonmetallic Housing



Page V8-T3-86

Overview

These nonmetallic sensors provide corrosion resistance in a limit switch style housing.

Applications

Food processing lines, high washdown environments

Product Features

- 5 position head can be top mounted or in any of four side positions
- Long sensing ranges up to 40 mm
- Normally open or closed outputs
- AC voltages
- Tough PBT resin housing

Technical Data and Specifications

- Current ratings—AC: 400 mA
- Enclosure ratings—NEMA 4, 4X, 6, 12, 13 IEC IP67
- Construction—PBT resin

Approvals

—

E51 Limit Switch Style, Factory Sealed 6P +



Page V8-T3-88

Overview

Completely epoxy filled in unitized, one piece limit switch style construction for reliable performance under the most adverse of environmental conditions.

Applications

All corrosive environments: Coolants/cutting oils, automotive applications

Product Features

- One piece housing on switch body/receptacle
- Head and housing totally epoxy encapsulated
- Side sensing head can be unfastened and moved to any of four positions
- Quick disconnect options
- Corrosive resistant epoxy coated housing

Technical Data and Specifications

- Current ratings—AC: 1 ampere continuous DC: 0.6 ampere continuous
- Enclosure ratings—NEMA 3, 3S, 4, 4X, 6, 6P, 12, 13 IEC IP67
- Construction—Die cast zinc
- Gasket material: Viton®

Approvals

cUL Listed



E51 Limit Switch Style, Modular



Page V8-T3-97

Overview

Modular design allows maximum use of inventories in these limit switch style housings. Solid-state circuitry in a variety of sensing ranges.

Applications

Machine tool, punch presses, automotive, conveyor systems

Product Features

- Modular heads, switch bodies, receptacles
- Shielded or unshielded sensing ranges
- Solid-state electronics
- Viton gasket seals
- LED indicators for power and output status
- Top and side sensing heads
- Alternate frequency for side by side operation
- Components individually labeled for easy identification

Technical Data and Specifications

- Current ratings—AC: 1 ampere continuous DC: 0.6 ampere continuous
- Enclosure ratings—NEMA 3, 3S, 4, 4X, 6, 6P, 12, 13 IEC IP67
- Class I, Class II, Division 2 Groups A, B, C, D, F and G; Class III
- Construction—Die cast zinc
- Gasket material: Viton

Approvals

UL Listed
CSA Certified (most models)



iProx Sensors



iProx Sensors

Product Description

The iProx represents the highest performance, most versatile tubular inductive sensor offered by Eaton's Electrical Sector. By utilizing an embedded microprocessor and exclusive SmartSense™ technology, iProx can sense up to three times farther than typical sensors of its class, while providing an unheard-of level of customization.

Both shielded and unshielded versions of iProx feature extended sensing ranges. This allows the sensor to be mounted farther from the target, thereby reducing the potential for target impacts and increasing the sensing reliability of your application.

The iProx also includes a wide range of advanced features that can be enabled via optional programming tools. Using the ProxView Windows-based software package, an entirely custom sensor can be programmed to perfectly fit an application.

For the most current information on this product, visit our Web site: www.eaton.com

Sensor characteristics, such as sensing range, can be customized down to the nearest tenth of a millimeter. Outputs can be changed from NO to NC. The iProx even features built-in timing delays and speed detection logic—no PLC programming is necessary.

With extended sensing range, quality construction and the ability to adapt to its environment, iProx is the ideal choice for even the most demanding inductive sensing applications.

Application Description

Typical Applications

- Automotive
- Machine tool
- Material handling
- Metalworking

Features

- Available in AC two-wire, DC three-wire and unique DC four-wire with complementary (NO-NC) or dual NO outputs
- Reliably detect metal targets at up to three times the range of conventional shielded or unshielded tubular inductive sensors

Contents

Description

Page

iProx Sensors	
Product Selection	
iProx Sensors	V8-T3-12
Complementary and Dual Output Sensors	V8-T3-14
Compatible Connector Cables	V8-T3-15
Accessories	V8-T3-15
Technical Data and Specifications	V8-T3-16
Wiring Diagrams	V8-T3-17
Dimensions	V8-T3-17

- Quality construction using a stainless steel barrel, 360-degree dual-color LED indicator, Ryton® impact-resistant face cap and vibration-absorbing potting compound
- Auto-configure technology automatically detects a sinking (NPN) or sourcing (PNP) connection and switches the sensor accordingly, without any user intervention
- Exclusive SmartSense embedded microprocessor technology allows for customizable range, band sensing, nuisance metal rejection, timing delays and over/under speed detection
- Optional computer programming cable and Windows-based ProxView configuration software makes it easy to customize sensors
- Withstands high electrical noise (up to 20 V/m)
- Resistant to extreme temperatures (–40 °F [–40 °C])

Standards and Certifications

- cUL Listed
- CE



⚠ DANGER

THIS SENSOR IS NOT A SAFETY DEVICE AND IS NOT INTENDED TO BE USED AS A SAFETY DEVICE. This sensor is designed only to detect and read certain data in an electronic manner and perform no use apart from that, specifically no safety-related use. This sensor product does not include self-checking redundant circuitry, and the failure of this sensor product could cause either an energized or de-energized output condition, which could result in death, serious bodily injury, or property damage.

For Customer Service in the U.S. call 1-877-ETN CARE (386-2273), in Canada call 1-800-268-3578. For Application Assistance in the U.S. and Canada call 1-800-426-9184.

3.1

Inductive Proximity Sensors

iProx Sensors







Product Selection

iProx Sensors

Note: Custom iProx models can also be ordered directly from the factory with pre-set ranges, outputs and connectors. Consult the Eaton Application Engineers at 1-800-426-9184 for more information.

3

Two-Wire Sensors

	Operating Voltage	Sensing Range	Shielding	Connection Type ^①	NO Output Catalog Number ^②	NC Output Catalog Number ^②
12 mm Diameter						
Standard Range 	20–132 Vac	4 mm	Shielded	3-pin micro AC connector	E59-M12A105A01-A1 ☺	E59-M12A105A01-A2 ☺
				3-pin micro AC pigtail ^③	E59-M12A105A01P-A1 ☺	E59-M12A105A01P-A2 ☺
				3-pin mini AC pigtail ^③	E59-M12A105A01PB-A1 ☺	E59-M12A105A01PB-A2 ☺
				2-meter cable	E59-M12A105C02-A1	E59-M12A105C02-A2
Extended Range 		10 mm	Unshielded	3-pin micro AC connector	E59-M12C110A01-A1 ☺	E59-M12C110A01-A2 ☺
				3-pin micro AC pigtail ^③	E59-M12C110A01P-A1 ☺	E59-M12C110A01P-A2 ☺
				3-pin mini AC pigtail ^③	E59-M12C110A01PB-A1 ☺	E59-M12C110A01PB-A2 ☺
				2-meter cable	E59-M12C110C02-A1	E59-M12C110C02-A2
18 mm Diameter						
Standard Range 	20–132 Vac	8 mm	Shielded	3-pin micro AC connector	E59-M18A109A01-A1 ☺	E59-M18A109A01-A2 ☺
				3-pin micro AC pigtail ^③	E59-M18A109A01P-A1 ☺	E59-M18A109A01P-A2 ☺
				3-pin mini AC pigtail ^③	E59-M18A109A01PB-A1 ☺	E59-M18A109A01PB-A2 ☺
				2-meter cable	E59-M18A109C02-A1	E59-M18A109C02-A2
Extended Range 		18 mm	Unshielded	3-pin micro AC connector	E59-M18C118A01-A1 ☺	E59-M18C118A01-A2 ☺
				3-pin micro AC pigtail ^③	E59-M18C118A01P-A1 ☺	E59-M18C118A01P-A2 ☺
				3-pin mini AC pigtail ^③	E59-M18C118A01PB-A1 ☺	E59-M18C118A01PB-A2 ☺
				2-meter cable	E59-M18C118C02-A1	E59-M18C118C02-A2
30 mm Diameter						
Standard Range 	20–132 Vac	15 mm	Shielded	3-pin micro AC connector	E59-M30A115A01-A1 ☺	E59-M30A115A01-A2 ☺
				3-pin micro AC pigtail ^③	E59-M30A115A01P-A1 ☺	E59-M30A115A01P-A2 ☺
				3-pin mini AC pigtail ^③	E59-M30A115A01PB-A1 ☺	E59-M30A115A01PB-A2 ☺
				2-meter cable	E59-M30A115C02-A1	E59-M30A115C02-A2
Extended Range 		29 mm	Unshielded	3-pin micro AC connector	E59-M30C129A01-A1 ☺	E59-M30C129A01-A2 ☺
				3-pin micro AC pigtail ^③	E59-M30C129A01P-A1 ☺	E59-M30C129A01P-A2 ☺
				3-pin mini AC pigtail ^③	E59-M30C129A01PB-A1 ☺	E59-M30C129A01PB-A2 ☺
				2-meter cable	E59-M30C129C02-A1	E59-M30C129C02-A2

Notes

☺ See listing of compatible connector cables on **Page V8-T3-15**.







① For sensors with custom cable lengths or PUR jackets, contact Application Engineering at 1-800-426-9184.

② Sensors are ordered with pre-set outputs from the factory, but can be later programmed either NO or NC using the ProxView software.

③ Standard pigtail cable length is 12 in.

Note: Custom iProx models can also be ordered directly from the factory with pre-set ranges, outputs and connectors. Consult the Eaton Application Engineers at 1-800-426-9184 for more information.

Three-Wire Sensors

	Operating Voltage	Sensing Range	Shielding	Connection Type ^①	NO Output Catalog Number ^②	NC Output Catalog Number ^②
12 mm Diameter						
Standard Range 	6–48 Vdc	4 mm	Shielded	4-pin micro DC connector	E59-M12A105D01-D1 ☺	E59-M12A105D01-D2 ☺
				4-pin micro DC pigtail ^③	E59-M12A105D01P-D1 ☺	E59-M12A105D01P-D2 ☺
				2-meter cable	E59-M12A105C02-D1	E59-M12A105C02-D2
Extended Range 		10 mm	Unshielded	4-pin micro DC connector	E59-M12C110D01-D1 ☺	E59-M12C110D01-D2 ☺
				4-pin micro DC pigtail ^③	E59-M12C110D01P-D1 ☺	E59-M12C110D01P-D2 ☺
				2-meter cable	E59-M12C110C02-D1	E59-M12C110C02-D2
18 mm Diameter						
Standard Range 	6–48 Vdc	8 mm	Shielded	4-pin micro DC connector	E59-M18A108D01-D1 ☺	E59-M18A108D01-D2 ☺
				4-pin micro DC pigtail ^③	E59-M18A108D01P-D1 ☺	E59-M18A108D01P-D2 ☺
				2-meter cable	E59-M18A108C02-D1	E59-M18A108C02-D2
Extended Range 		18 mm	Unshielded	4-pin micro DC connector	E59-M18C116D01-D1 ☺	E59-M18C116D01-D2 ☺
				4-pin micro DC pigtail ^③	E59-M18C116D01P-D1 ☺	E59-M18C116D01P-D2 ☺
				2-meter cable	E59-M18C116C02-D1	E59-M18C116C02-D2
30 mm Diameter						
Standard Range 	6–48 Vdc	15 mm	Shielded	4-pin micro DC connector	E59-M30A115D01-D1 ☺	E59-M30A115D01-D2 ☺
				4-pin micro DC pigtail ^③	E59-M30A115D01P-D1 ☺	E59-M30A115D01P-D2 ☺
				2-meter cable	E59-M30A115C02-D1	E59-M30A115C02-D2
Extended Range 		29 mm	Unshielded	4-pin micro DC connector	E59-M30C129D01-D1 ☺	E59-M30C129D01-D2 ☺
				4-pin micro DC pigtail ^③	E59-M30C129D01P-D1 ☺	E59-M30C129D01P-D2 ☺
				2-meter cable	E59-M30C129C02-D1	E59-M30C129C02-D2

Notes

☺ See listing of compatible connector cables on [Page V8-T3-15](#).

^① For sensors with custom cable lengths or PUR jackets, contact Application Engineering at 1-800-426-9184.

^② Sensors are ordered with pre-set outputs from the factory, but can be later programmed either NO or NC using the ProxView software.

^③ Standard pigtail cable length is 12 in.

3.1













Inductive Proximity Sensors

iProx Sensors

Complementary and Dual Output Sensors

Four-Wire Sensors

3

	Operating Voltage	Sensing Range	Shielding	Output Type	Connection Type	Complementary Output (1NO-1NC) Catalog Number	Dual NO Output Catalog Number ^①
12 mm Diameter							
Standard Range 	6–48 Vdc	4 mm	Shielded	NPN (sinking)	4-pin micro DC connector	E59-M12A105D01-D3NN ☹	E59-M12A105D01-D1NN ☹
					2-meter cable	E59-M12A105C02-D3NN	E59-M12A105C02-D1NN
Extended Range 				PNP (sourcing)	4-pin micro DC connector	E59-M12A105D01-D3PP ☹	E59-M12A105D01-D1PP ☹
					2-meter cable	E59-M12A105C02-D3PP	E59-M12A105C02-D1PP
Standard Range 	6–48 Vdc	10 mm	Unshielded	NPN (sinking)	4-pin micro DC connector	E59-M12C110D01-D3NN ☹	E59-M12C110D01-D1NN ☹
					2-meter cable	E59-M12C110C02-D3NN	E59-M12C110C02-D1NN
Extended Range 				PNP (sourcing)	4-pin micro DC connector	E59-M12C110D01-D3PP ☹	E59-M12C110D01-D1PP ☹
					2-meter cable	E59-M12C110C02-D3PP	E59-M12C110C02-D1PP
18 mm Diameter							
Standard Range 	6–48 Vdc	8 mm	Shielded	NPN (sinking)	4-pin micro DC connector	E59-M18A108D01-D3NN ☹	E59-M18A108D01-D1NN ☹
					2-meter cable	E59-M18A108C02-D3NN	E59-M18A108C02-D1NN
Extended Range 				PNP (sourcing)	4-pin micro DC connector	E59-M18A108D01-D3PP ☹	E59-M18A108D01-D1PP ☹
					2-meter cable	E59-M18A108C02-D3PP	E59-M18A108C02-D1PP
Standard Range 	6–48 Vdc	18 mm	Unshielded	NPN (sinking)	4-pin micro DC connector	E59-M18C116D01-D3NN ☹	E59-M18C116D01-D1NN ☹
					2-meter cable	E59-M18C116C02-D3NN	E59-M18C116C02-D1NN
Extended Range 				PNP (sourcing)	4-pin micro DC connector	E59-M18C116D01-D3PP ☹	E59-M18C116D01-D1PP ☹
					2-meter cable	E59-M18C116C02-D3PP	E59-M18C116C02-D1PP
30 mm Diameter							
Standard Range 	6–48 Vdc	15 mm	Shielded	NPN (sinking)	4-pin micro DC connector	E59-M30A115D01-D3NN ☹	E59-M30A115D01-D1NN ☹
					2-meter cable	E59-M30A115C02-D3NN	E59-M30A115C02-D1NN
Extended Range 				PNP (sourcing)	4-pin micro DC connector	E59-M30A115D01-D3PP ☹	E59-M30A115D01-D1PP ☹
					2-meter cable	E59-M30A115C02-D3PP	E59-M30A115C02-D1PP
Standard Range 	6–48 Vdc	29 mm	Unshielded	NPN (sinking)	4-pin micro DC connector	E59-M30C129D01-D3NN ☹	E59-M30C129D01-D1NN ☹
					2-meter cable	E59-M30C129C02-D3NN	E59-M30C129C02-D1NN
Extended Range 				PNP (sourcing)	4-pin micro DC connector	E59-M30C129D01-D3PP ☹	E59-M30C129D01-D1PP ☹
					2-meter cable	E59-M30C129C02-D3PP	E59-M30C129C02-D1PP





Notes

☹ See listing of compatible connector cables on **Page V8-T3-15**.

① At this time, iProx Complementary and Dual Output models are not available with auto-sink/source detection. Therefore, PNP (sourcing) and NPN (sinking) models must be ordered separately.



Compatible Connector Cables

Standard Cables ^①

	Current Rating at 600 V	Voltage Style	Number of Pins	Gauge	Length	Pin Configuration/Wire Colors (Face View Female Shown)	PVC Jacket Catalog Number	PUR Jacket Catalog Number
Micro-Style Straight Female 	Micro-Style, Straight Female							
	—	AC	3-pin, 3-wire	22 AWG	6.0 ft (2m)	 1-Green 2-Red/Black 3-Red/White	CSAS3F3CY2202	CSAS3F3RY2202
Mini-Style Straight Female 	Mini-Style, Straight Female							
	13 A	—	3-pin	16 AWG	6 ft (2m)	 1-Brown 2-White 3-Blue 4-Black	CSDS4A4CY2202	CSDS4A4RY2202
							Catalog Number	
							CSMS3F3CY1602	

Accessories

iProx Sensors

	Description	Catalog Number
Software 	Step-by-step programming software required to program iProx. Compatible with Microsoft Windows® and Windows® Mobile devices.	E59SW1
Cable 	The iProx programming cable is used to program individual iProx sensors, providing a connection between the computer and the sensor. Connects to computer via a serial (RS-232) or USB port. (USB connection requires an adapter which is included with purchase.)	E59RP1
Labels 	Field applied labels for iProx sensor (100 pcs)	E59LABEL

Note

^① For a full selection of connector cables, see **Tab 10, section 10.1**.

Starter Kit



iProx Starter Kits

Description	Catalog Number
Interested in custom programming iProx sensors to fit your application?	
These kits include everything needed to get the most out of iProx: a sensor, a programming cable (E59RP1), a micro connector cable (CSDS4A4CY2202) and ProxView software on CD-ROM (E59SW1).	
Starter kit includes:	
12 mm AC unshielded iProx sensor (E59-M12C110A01-A1)	E5912ACKIT
12 mm DC unshielded iProx sensor (E59-M12C110D01-D1)	E5912DCKIT
18 mm AC unshielded iProx sensor (E59-M18C118A01-A1)	E5918ACKIT
18 mm DC unshielded iProx sensor (E59-M18C116D01-D1)	E5918DCKIT
30 mm AC unshielded iProx sensor (E59-M30C129A01-A1)	E5930ACKIT
30 mm DC unshielded iProx sensor (E59-M30C129D01-D1)	E5930DCKIT

Technical Data and Specifications

iProx Sensors

Description	Two-Wire Sensors	Three-Wire Sensors
Input voltage	20–132 Vac	6–48 Vdc
Load current	250 mA	300 mA
Leakage current	≤1.7 mA at 32 °F (0 °C), 2.0 mA at –40 °F (–40 °C)	≤150 µA
Voltage drop	<5 Vac	≤2.5 Vdc
Burden current	—	≤15 mA
Protection	None	Auto reset
Switching hysteresis	<15% rated sensing distance	<15% rated sensing distance
Repeat accuracy	Shielded models: <1% sensing distance; Unshielded models: <3% sensing distance	Shielded models: <1% sensing distance; Unshielded models: <3% sensing distance
Surge capacity	3 A/30 ms	—
Temperature range	–40 to 158 °F (–40 to 70 °C)	–40 to 158 °F (–40 to 70 °C)
Material of construction	303 stainless steel; end bells: polycarbonate; face caps: Ryton®; cable: AWM style 20387 (PVC)	303 stainless steel; end bells: polycarbonate; face caps: Ryton®; cable: AWM style 20387 (PVC)
Vibration and shock	Vibration: 10 to 55 Hz, 1 mm amplitude, IEC 60068-2-6; shock: 30 g, 11 ms per IEC 68-2-27	Vibration: 10 to 55 Hz, 1 mm amplitude, IEC 60068-2-6; shock: 30 g, 11 ms per IEC 68-2-27
Indicator LED	360° viewable LED	360° viewable LED
Enclosure ratings	NEMA 4, 4X, 6, 6P, 12 and 13 (IP67) IP69K ①	NEMA 4, 4X, 6, 6P, 12 and 13 (IP67) IP69K ①

Response Time ②

Description	Two-Wire Sensors All Two-Wire Models	Three-Wire Sensors Shielded			Unshielded		
		12 mm	18 mm	30 mm	12 mm	18 mm	30 mm
Factory default mode	Shipped in “Side by Side Mode” by default (20 V/m)	580 Hz (10 V/m)	390 Hz (10 V/m)	240 Hz (10 V/m)	300 Hz (10 V/m)	150 Hz (10 V/m)	145 Hz (10 V/m)
Side by side ③	30 Hz (10 V/m)	50 Hz (20 V/m)	50 Hz (20 V/m)	50 Hz (20 V/m)	50 Hz (20 V/m)	50 Hz (20 V/m)	50 Hz (20 V/m)
High noise immunity mode	10 Hz (>20 V/m)	10 Hz (>20 V/m)	10 Hz (>20 V/m)	10 Hz (>20 V/m)	10 Hz (>20 V/m)	10 Hz (>20 V/m)	10 Hz (>20 V/m)

Notes

Ryton® is a registered trademark of Phillips Chemical (division of Phillips Petroleum).

① Our products conform to NEMA® tests as indicated, however, some severe washdown applications can exceed these NEMA test specifications.

② iProx sensors may be programmed to perform in side by side or high noise immunity applications using the iProx programming cable (E59RP1) and ProxView software (E59SW1).

③ Use the side by side response time parameter when using the iProx Tray Programmer (E59TP1), iProx programming cable (E59RP1) and ProxView software (E59SW1).

Wiring Diagrams

Pin numbers are for reference, rely on pin location when wiring.

iProx Sensors

Operating Voltage	Output	Cable Models	Connector Models (Face View Male Shown)	
			Micro	Mini
Two-Wire Sensors				
20–132 Vac	NO and NC			
Three-Wire Sensors				
6–48 Vdc	NO and NC (NPN and PNP) ①	②	②	—
Four-Wire Dual Output and Complementary Sensors				
6–48 Vdc	NO and NC (NPN)	③	③	—
	NO and NC (PNP)	③	③	—

Dimensions

Approximate Dimensions in Inches (mm)

Cable Models

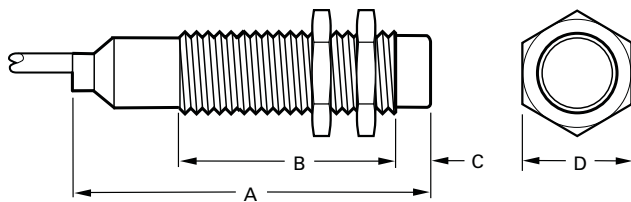

Size	Shielding	A	B	C	D
12 mm	Shielded	2.46 (62.4)	1.98 (50.3)	0.02 (0.5)	0.67 (17)
	Unshielded	2.46 (62.4)	1.64 (41.6)	0.36 (9)	0.67 (17)
18 mm	Shielded	2.54 (64.5)	2.00 (50.9)	0.02 (0.5)	0.94 (24)
	Unshielded	2.54 (64.5)	1.47 (37.4)	0.55 (14)	0.94 (24)
30 mm	Shielded	2.74 (69.6)	2.13 (54.1)	0.03 (0.75)	1.41 (36)
	Unshielded	2.74 (69.6)	1.41 (35.8)	0.75 (19)	1.41 (36)

Micro-Connector Models

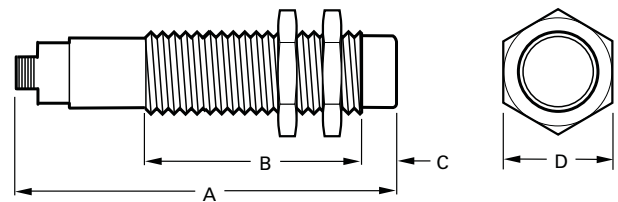

Size	Shielding	A	B	C	D
12 mm	Shielded	2.71 (68.7)	1.98 (50.3)	0.02 (0.5)	0.67 (17)
	Unshielded	2.71 (68.7)	1.64 (41.6)	0.36 (9)	0.67 (17)
18 mm	Shielded	2.73 (69.3)	2.00 (50.9)	0.02 (0.5)	0.94 (24)
	Unshielded	2.73 (69.3)	1.47 (37.4)	0.55 (14)	0.94 (24)
30 mm	Shielded	2.92 (74.1)	2.13 (54.1)	0.03 (0.75)	1.41 (36)
	Unshielded	2.92 (74.1)	1.41 (35.8)	0.75 (19)	1.41 (36)

Notes

- ① The three-wire DC version of iProx automatically configures itself to NPN or PNP based on field wiring. No user intervention is required.
- ② Pin numbers 2 and 4 are internally jumpered together. Either pin may be used.
- ③ The complementary (1NO-1NC) output models feature the NC output on pin 2 (white).

E57P Performance Series Sensors

3



Contents

<i>Description</i>	<i>Page</i>
E57P Performance Series Sensors	
Product Selection	
E57P Performance Sensors	V8-T3-19
Compatible Connector Cables	V8-T3-20
Accessories	V8-T3-20
Technical Data and Specifications	V8-T3-21
Wiring Diagrams	V8-T3-22
Dimensions	V8-T3-23

E57P Performance Series Sensors

Product Description

For sensing applications requiring more demanding specifications, the new E57P Performance series incorporates premium features without the premium price. With its stainless steel tubular body, IP69K rating, wide temperature range (down to -40 °C), fast switching speed and laser-etched markings, the E57P series provides value at a low price point.

Features

- 360° LED indicator
- Stainless steel tube
- 10–48 Vdc operating voltage
- Short-circuit protection
- -40 to 70 °C temperature range
- IP69K environmental rating
- Durable laser-engraved label
- Available in cable and micro-connector styles

Standards and Certifications

- cULus Listed
- CE



⚠ DANGER

THIS SENSOR IS NOT A SAFETY DEVICE AND IS NOT INTENDED TO BE USED AS A SAFETY DEVICE. This sensor is designed only to detect and read certain data in an electronic manner and perform no use apart from that, specifically no safety-related use. This sensor product does not include self-checking redundant circuitry, and the failure of this sensor product could cause either an energized or de-energized output condition, which could result in death, serious bodily injury, or property damage.



For the most current information on this product, visit our Web site: www.eaton.com

For Customer Service in the U.S. call 1-877-ETN CARE (386-2273), in Canada call 1-800-268-3578. For Application Assistance in the U.S. and Canada call 1-800-426-9184.

Product Selection

E57P Performance Sensors

Three-Wire Sensors

	Operating Voltage	Sensing Range (Sn)	Shielding	Connection Type ^①	NO Output Catalog Number	NC Output Catalog Number
12 mm 	12 mm Diameter End Sensing					
	10–48 Vdc	2 mm (standard range)	Shielded (PNP)	2-meter cable	E57P-12SPN2-C2	E57P-12SPC2-C2
				4-pin micro DC connector	E57P-12SPN2-Q	E57P-12SPC2-Q
			Shielded (NPN)	2-meter cable	E57P-12SNN2-C2	E57P-12SNC2-C2
			4-pin micro DC connector	E57P-12SNN2-Q	E57P-12SNC2-Q	
		4 mm (standard range)	Unshielded (PNP)	2-meter cable	E57P-12UPN4-C2	E57P-12UPC4-C2
				4-pin micro DC connector	E57P-12UPN4-Q	E57P-12UPC4-Q
	4 mm (extended range)	Unshielded (NPN)	2-meter cable	E57P-12UNN4-C2	E57P-12UNC4-C2	
			4-pin micro DC connector	E57P-12UNN4-Q	E57P-12UNC4-Q	
	4 mm (extended range)	Shielded (PNP)	2-meter cable	E57P-12SPN4-C2	E57P-12SPC4-C2	
			4-pin micro DC connector	E57P-12SPN4-Q	E57P-12SPC4-Q	
	4 mm (extended range)	Shielded (NPN)	2-meter cable	E57P-12SNN4-C2	E57P-12SNC4-C2	
			4-pin micro DC connector	E57P-12SNN4-Q	E57P-12SNC4-Q	
	8 mm (extended range)	Unshielded (PNP)	2-meter cable	E57P-12UPN8-C2	E57P-12UPC8-C2	
4-pin micro DC connector			E57P-12UPN8-Q	E57P-12UPC8-Q		
8 mm (extended range)	Unshielded (NPN)	2-meter cable	E57P-12UNN8-C2	E57P-12UNC8-C2		
		4-pin micro DC connector	E57P-12UNN8-Q	E57P-12UNC8-Q		
18 mm 	18 mm Diameter End Sensing					
	10–48 Vdc	5 mm (standard range)	Shielded (PNP)	2-meter cable	E57P-18SPN5-C2	E57P-18SPC5-C2
				4-pin micro DC connector	E57P-18SPN5-Q	E57P-18SPC5-Q
			Shielded (NPN)	2-meter cable	E57P-18SNN5-C2	E57P-18SNC5-C2
			4-pin micro DC connector	E57P-18SNN5-Q	E57P-18SNC5-Q	
		8 mm (standard range)	Unshielded (PNP)	2-meter cable	E57P-18UPN8-C2	E57P-18UPC8-C2
				4-pin micro DC connector	E57P-18UPN8-Q	E57P-18UPC8-Q
	8 mm (standard range)	Unshielded (NPN)	2-meter cable	E57P-18UNN8-C2	E57P-18UNC8-C2	
			4-pin micro DC connector	E57P-18UNN8-Q	E57P-18UNC8-Q	
	8 mm (extended range)	Shielded (PNP)	2-meter cable	E57P-18SPN8-C2	E57P-18SPC8-C2	
			4-pin micro DC connector	E57P-18SPN8-Q	E57P-18SPC8-Q	
	8 mm (extended range)	Shielded (NPN)	2-meter cable	E57P-18SNN8-C2	E57P-18SNC8-C2	
			4-pin micro DC connector	E57P-18SNN8-Q	E57P-18SNC8-Q	
	12 mm (extended range)	Unshielded (PNP)	2-meter cable	E57P-18UPN12-C2	E57P-18UPC12-C2	
4-pin micro DC connector			E57P-18UPN12-Q	E57P-18UPC12-Q		
12 mm (extended range)	Unshielded (NPN)	2-meter cable	E57P-18UNN12-C2	E57P-18UNC12-C2		
		4-pin micro DC connector	E57P-18UNN12-Q	E57P-18UNC12-Q		

Notes

⊕ See listing of compatible connector cables on **Page V8-T3-20**.

① For cable lengths longer than 2 meters, add the number of the desired length in meters to the end of the listed catalog number (for catalog numbers ending with a number, add an **S** and then the length). Examples for a 5-meter cable: E57-18LE12-A becomes E57-18LE12-A5; E57LAL12A2 becomes E57LAL12A2S5.



Three-Wire Sensors, continued

Operating Voltage	Sensing Range (Sn)	Shielding	Connection Type ①	NO Output Catalog Number	NC Output Catalog Number	
30 mm						
30 mm Diameter End Sensing						
10–48 Vdc	10 mm (standard range)	Shielded (PNP)	2-meter cable	E57P-30SPN10-C2	E57P-30SPC10-C2	
			4-pin micro DC connector	E57P-30SPN10-Q	E57P-30SPC10-Q	
		Shielded (NPN)	2-meter cable	E57P-30SNN10-C2	E57P-30SNC10-C2	
			4-pin micro DC connector	E57P-30SNN10-Q	E57P-30SNC10-Q	
		15 mm (standard range)	Unshielded (PNP)	2-meter cable	E57P-30UPN15-C2	E57P-30UPC15-C2
				4-pin micro DC connector	E57P-30UPN15-Q	E57P-30UPC15-Q
	Unshielded (NPN)		2-meter cable	E57P-30UNN15-C2	E57P-30UNC15-C2	
			4-pin micro DC connector	E57P-30UNN15-Q	E57P-30UNC15-Q	
	15 mm (extended range)	Shielded (PNP)	2-meter cable	E57P-30SPN15-C2	E57P-30SPC15-C2	
			4-pin micro DC connector	E57P-30SPN15-Q	E57P-30SPC15-Q	
		Shielded (NPN)	2-meter cable	E57P-30SNN15-C2	E57P-30SNC15-C2	
			4-pin micro DC connector	E57P-30SNN15-Q	E57P-30SNC15-Q	
Unshielded (PNP)		2-meter cable	E57P-30UPN22-C2	E57P-30UPC22-C2		
		4-pin micro DC connector	E57P-30UPN22-Q	E57P-30UPC22-Q		
Unshielded (NPN)	2-meter cable	E57P-30UNN22-C2	E57P-30UNC22-C2			
	4-pin micro DC connector	E57P-30UNN22-Q	E57P-30UNC22-Q			

Compatible Connector Cables

Standard Cables ①

Current Rating at 600 V	Voltage Style	Number of Pins	Gauge	Length	Pin Configuration/Wire Colors (Face View Female Shown)	PVC Jacket Catalog Number	PUR Jacket Catalog Number
Micro-Style, Straight Female							
—	DC	4-pin, 4-wire	22 AWG	6.0 ft (2m)		CSDS4A4CY2202	CSDS4A4RY2202

Accessories

E57P Performance Sensors

Description	Reference
Mounting brackets	See Tab 8, section 8.2
Replacement mounting nuts and other accessories	See Tab 8, section 8.3
Connector cables	See Tab 10, section 10.1

Notes

⊕ See listing of compatible connector cables on **Page V8-T3-20**.

① For cable lengths longer than 2 meters, add the number of the desired length in meters to the end of the listed catalog number (for catalog numbers ending with a number, add an **S** and then the length). Examples for a 5-meter cable: E57-18LE12-A becomes E57-18LE12-A**5**; E57LAL12A2 becomes E57LAL12A**2S5**.

② For a full selection of connector cables, see **Tab 10, section 10.1**.

Technical Data and Specifications

E57P Performance Sensors

Description	Performance Three-Wire DC Sensors
Operating voltage	10–48 Vdc
Output current (continuous)	300 mA
Switching frequency [Hz]	Standard range: 12 mm—Shielded: 2000; Unshielded: 2000 18 mm—Shielded: 1200; Unshielded: 1200 30 mm—Shielded: 600; Unshielded: 500 Extended range: 12 mm—Shielded: 1200; Unshielded: 500 18 mm—Shielded: 300; Unshielded: 300 30 mm—Shielded: 400; Unshielded: 200
Leakage current	<100 µA
Output voltage drop [Vsat]	<2.5 V
Current consumption	<10 mA
Short-circuit protection	Yes (Auto Reset)
Hysteresis [% of Sr]	2–20%
Repeat accuracy	1% shielded, 3% unshielded
Time delay before availability	<200 ms
Output indicator LED	360° amber LED
Operating temperature range	–40 to 70 °C
Ingress protection	IEC IP67, IP69K, UL Type 1, NEMA Type 6P, NEMA Type 4X
Shock	30 g, 11 ms per IEC 68-2-76
Vibration	10 to 55 Hz, 1 mm amplitude
Housing materials	Front face: Rytton Tube: Stainless steel End bells: M12 body: Polycarbonate Cable end bell: Polycarbonate Nuts: Stainless steel
Cable	AWM style 20387 (PVC)

Recommended Mounting Clearances

For unshielded standard range sensors and extended range sensors, clearance must be provided around the sensor when mounting for reliable performance. (“Sn” is the sensing range of the sensor, “d” is the sensor diameter.)

E57P Performance Sensors, Mounting

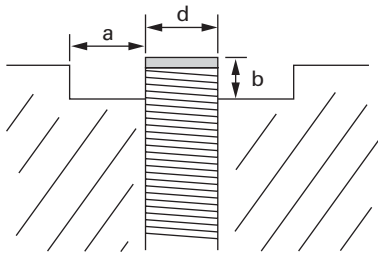

Type	Shielding	a	b
Standard range	Shielded	0	0
	Unshielded	Cap height	2 x 5n
Extended range	Shielded	0	0
	Unshielded	Cap height	2 x Sn

Note

Rytton® is a registered trademark of Phillips Chemical (division of Phillips Petroleum).

① 40–240 Vac at <–4 °F (<–20 °C).

Wiring Diagrams

Pin numbers are for reference, rely on pin location when wiring.

E57P Performance Sensors

3

Operating Voltage	Output	Cable Models	Connector Models (Face View Male Shown) Micro
Three-Wire Sensors			
10–48 Vdc	NO (NPN)		
	NO (PNP)		
	NC (NPN)		
	NC (PNP)		

Dimensions

Approximate Dimensions in Inches (mm)

E57P Performance Series Sensors, End Sensing ^①

Cable Models

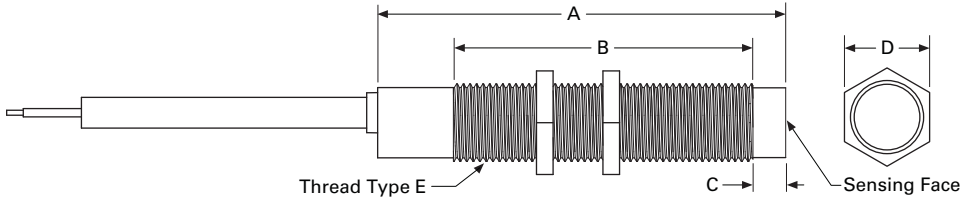

Connector Models

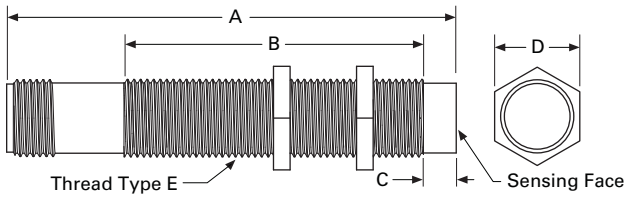

Size	Shielding	Overall Length A	Threaded Length B	Cap Height C	Nut Width D	Thread Size E
Three-Wire DC Sensors—Cable Models						
12 mm	Shielded	2.52 (64.1)	1.98 (50.3)	—	0.67 (16.8)	M12 x 1
	Unshielded	2.52 (64.1)	1.80 (45.8)	0.20 (5.0)	0.67 (16.8)	M12 x 1
18 mm	Shielded	2.59 (65.9)	2.00 (50.9)	—	0.94 (23.8)	M18 x 1
	Unshielded	2.59 (65.9)	1.75 (44.4)	0.28 (7.0)	0.94 (23.8)	M18 x 1
30 mm	Shielded	2.67 (67.7)	1.98 (50.3)	—	1.41 (35.9)	M30 x 1.5
	Unshielded	2.67 (67.7)	1.49 (37.8)	0.51 (13.0)	1.41 (35.9)	M30 x 1.5
Three-Wire DC Sensors—Micro-Connector Models						
12 mm	Shielded	2.70 (68.7)	1.98 (50.3)	—	0.67 (16.8)	M12 x 1
	Unshielded	2.70 (68.7)	1.80 (45.8)	0.20 (5.0)	0.67 (16.8)	M12 x 1
18 mm	Shielded	2.72 (69.2)	2.00 (50.9)	—	0.94 (23.8)	M18 x 1
	Unshielded	2.72 (69.2)	1.75 (44.4)	0.28 (7.0)	0.94 (23.8)	M18 x 1
30 mm	Shielded	2.79 (70.9)	1.98 (50.3)	—	1.41 (35.9)	M30 x 1.5
	Unshielded	2.79 (70.9)	1.49 (37.8)	0.51 (13.0)	1.41 (35.9)	M30 x 1.5

Note

^① These dimensions apply to the Performance Series models in this section.

E57PS Performance Short Body Sensors

3



Contents

Description	Page
E57PS Performance Short Body Sensors	
Product Selection	
E57PS Performance Short Body Sensors . . .	V8-T3-25
Compatible Connector Cables	V8-T3-25
Accessories	V8-T3-26
Technical Data and Specifications	V8-T3-26
Wiring Diagrams	V8-T3-27
Dimensions	V8-T3-27

E57PS Performance Short Body Sensors

Product Description

For demanding sensing applications in areas too small for standard length units, the E57PS Performance Short Body series is an ideal solution as it incorporates the premium features of the E57P series but in a shorter body length. With its stainless steel tubular body, IP69K rating, wide temperature range (down to -40 °C), fast switching speed and laser-etched markings, the E57PS series provides value at a low price point.

Features

- 360° LED indicator
- Stainless steel tube
- 10–48 Vdc operating voltage
- Short-circuit protection
- -40 to 70 °C temperature range
- IP69K environmental rating
- Durable laser-engraved label
- Available in cable and micro-connector styles

Standards and Certifications

- cULus Listed
- CE



⚠ DANGER

THIS SENSOR IS NOT A SAFETY DEVICE AND IS NOT INTENDED TO BE USED AS A SAFETY DEVICE. This sensor is designed only to detect and read certain data in an electronic manner and perform no use apart from that, specifically no safety-related use. This sensor product does not include self-checking redundant circuitry, and the failure of this sensor product could cause either an energized or de-energized output condition, which could result in death, serious bodily injury, or property damage.



For the most current information on this product, visit our Web site: www.eaton.com

For Customer Service in the U.S. call 1-877-ETN CARE (386-2273), in Canada call 1-800-268-3578. For Application Assistance in the U.S. and Canada call 1-800-426-9184.

Product Selection



E57PS Performance Short Body Sensors

Three-Wire Sensors

	Operating Voltage	Sensing Range (Sn)	Shielding	Connection Type ^①	NO Output Catalog Number	NC Output Catalog Number
	12 mm Diameter					
	10–48 Vdc	2 mm (standard range)	Shielded (PNP)	2-meter cable	E57PS-12SPN2-C2	E57PS-12SPC2-C2
				4-pin micro DC connector	E57PS-12SPN2-Q [⊕]	E57PS-12SPC2-Q [⊕]
		4 mm (standard range)	Shielded (NPN)	2-meter cable	E57PS-12SNN2-C2	E57PS-12SNC2-C2
				4-pin micro DC connector	E57PS-12SNN2-Q [⊕]	E57PS-12SNC2-Q [⊕]
		Unshielded (PNP)	2-meter cable	E57PS-12UPN4-C2	E57PS-12UPC4-C2	
4-pin micro DC connector			E57PS-12UPN4-Q [⊕]	E57PS-12UPC4-Q [⊕]		
Unshielded (NPN)	2-meter cable	E57PS-12UNN4-C2	E57PS-12UNC4-C2			
	4-pin micro DC connector	E57PS-12UNN4-Q [⊕]	E57PS-12UNC4-Q [⊕]			
	18 mm Diameter					
	10–48 Vdc	5 mm (standard range)	Shielded (PNP)	2-meter cable	E57PS-18SPN5-C2	E57PS-18SPC5-C2
				4-pin micro DC connector	E57PS-18SPN5-Q [⊕]	E57PS-18SPC5-Q [⊕]
		8 mm (standard range)	Shielded (NPN)	2-meter cable	E57PS-18SNN5-C2	E57PS-18SNC5-C2
				4-pin micro DC connector	E57PS-18SNN5-Q [⊕]	E57PS-18SNC5-Q [⊕]
		Unshielded (PNP)	2-meter cable	E57PS-18UPN8-C2	E57PS-18UPC8-C2	
4-pin micro DC connector			E57PS-18UPN8-Q [⊕]	E57PS-18UPC8-Q [⊕]		
Unshielded (NPN)	2-meter cable	E57PS-18UNN8-C2	E57PS-18UNC8-C2			
	4-pin micro DC connector	E57PS-18UNN8-Q [⊕]	E57PS-18UNC8-Q [⊕]			
	30 mm Diameter					
	10–48 Vdc	10 mm (standard range)	Shielded (PNP)	2-meter cable	E57PS-30SPN10-C2	E57PS-30SPC10-C2
				4-pin micro DC connector	E57PS-30SPN10-Q [⊕]	E57PS-30SPC10-Q [⊕]
		15 mm (standard range)	Shielded (NPN)	2-meter cable	E57PS-30SNN10-C2	E57PS-30SNC10-C2
				4-pin micro DC connector	E57PS-30SNN10-Q [⊕]	E57PS-30SNC10-Q [⊕]
		Unshielded (PNP)	2-meter cable	E57PS-30UPN15-C2	E57PS-30UPC15-C2	
4-pin micro DC connector			E57PS-30UPN15-Q [⊕]	E57PS-30UPC15-Q [⊕]		
Unshielded (NPN)	2-meter cable	E57PS-30UNN15-C2	E57PS-30UNC15-C2			
	4-pin micro DC connector	E57PS-30UNN15-Q [⊕]	E57PS-30UNC15-Q [⊕]			

Compatible Connector Cables

Standard Cables ^②

	Voltage Style	Number of Pins	Gauge	Length	Pin Configuration/Wire Colors (Face View Female Shown)	PVC Jacket Catalog Number	PUR Jacket Catalog Number
	Micro-Style, Straight Female						
	DC	4-pin, 4-wire	22 AWG	6.0 ft (2m)	 1-Brown 2-White 3-Blue 4-Black	CSDS4A4CY2202	CSDS4A4RY2202

Notes

[⊕] See listing of compatible connector cables above.

^① Cable models are supplied as standard with a 2-meter cable. A 5-meter cable is available by adding **S5** to the catalog number. Example: E57SAL12T110 becomes E57SAL12T110**S5**.

^② For a full selection of connector cables, see **Tab 10, section 10.1**.

Accessories

E57PS Performance Short Body Sensors

Description	Reference
Mounting brackets	See Tab 8, section 8.2
Replacement mounting nuts and other accessories	See Tab 8, section 8.3
Connector cables	See Tab 10, section 10.1

Technical Data and Specifications

E57PS Performance Short Body Sensors

Description	Three-Wire DC Sensors
Operating voltage	10–48 Vdc
Maximum load current	300 mA
Switching frequency [Hz]	12 mm—Shielded: 2000; Unshielded: 2000 18 mm—Shielded: 1200; Unshielded: 1200 30 mm—Shielded: 600; Unshielded: 500
Leakage current	100 μ A maximum
Voltage drop	≤ 2.5 V
Holding current	≤ 10 mA
Short-circuit protection	Yes (Auto Reset)
Switching hysteresis	2–20% of rated sensing distance
Repeat accuracy	1% shielded, 3% unshielded
Output indicator LED	360° amber LED
Operating temperature	–40 to 158 °F (–40 to 70 °C)
Enclosure ratings	IP67, IP69K; NEMA 4, 4X, 6, 6P
Shock	30 g sine wave, 11 ms per IEC68-2-76
Vibration	10 to 55 Hz, 1 mm amplitude
Material of construction	Stainless steel, polycarbonate end bells, Ryton® front cap
Cable	AWM Style 20387 (PVC)

Note

Ryton® is a registered trademark of Phillips Chemical (division of Phillips Petroleum).

Wiring Diagrams

Pin numbers are for reference, rely on pin location when wiring.

E57PS Performance Short Body Sensors

Operating Voltage	Output	Cable Models	Micro-Connector Models (Face View Male Shown)
Three-Wire Sensors			
10–48 Vdc	NO (NPN)		
	NO (PNP)		
	NC (NPN)		
	NC (PNP)		

Dimensions

Approximate Dimensions in Inches (mm)

E57PS Performance Short Body Sensors—Cable Models

12 mm

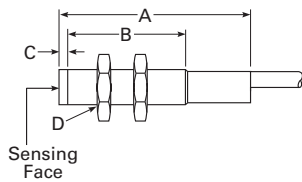

18 mm

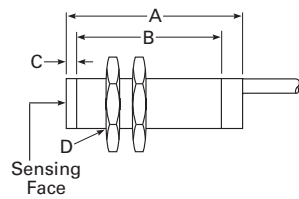

30 mm

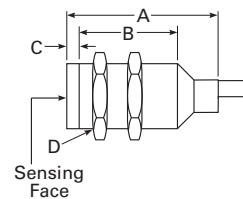

Size	Shielding	Overall Length A	Threaded Length B	Cap Height C	Thread Size D
Three-Wire DC Sensors					
12 mm	Shielded	1.61 (40.9)	1.07 (27.2)	—	M12 x 1
	Unshielded	1.61 (40.9)	0.89 (22.7)	0.20 (5.0)	M12 x 1
18 mm	Shielded	1.77 (44.9)	1.17 (29.8)	—	M18 x 1
	Unshielded	1.77 (44.9)	0.92 (23.3)	0.28 (7.0)	M18 x 1
30 mm	Shielded	1.84 (46.6)	1.15 (29.3)	—	M30 x 1.5
	Unshielded	1.84 (46.6)	0.66 (16.8)	0.51 (13.0)	M30 x 1.5

3.3

Inductive Proximity Sensors

E57PS Performance Short Body Sensors

Approximate Dimensions in Inches (mm)

E57PS Performance Short Body Sensors—Micro-Connector Models

12 mm

18 mm

30 mm

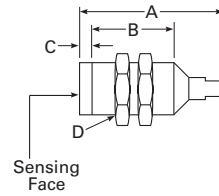
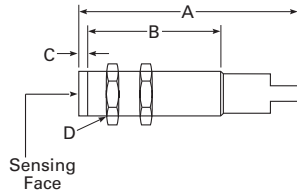
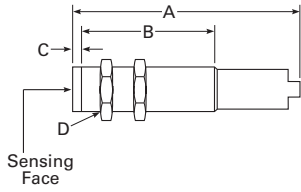

Size	Shielding	Overall Length A	Threaded Length B	Cap Height C	Thread Size D
Three-Wire DC Sensors					
12 mm	Shielded	1.64 (41.5)	1.07 (27.2)	—	M12 x 1
	Unshielded	1.64 (41.5)	0.89 (22.7)	0.20 (5.0)	M12 x 1
18 mm	Shielded	1.59 (40.3)	1.17 (29.8)	—	M18 x 1
	Unshielded	1.59 (40.3)	0.92 (23.3)	0.28 (7.0)	M18 x 1
30 mm	Shielded	1.77 (45.0)	1.15 (29.3)	—	M30 x 1.5
	Unshielded	1.96 (49.7)	0.66 (16.8)	0.51 (13.0)	M30 x 1.5

E57G General Purpose Proximity Sensors



Contents

Description

	<i>Page</i>
E57G General Purpose Proximity Sensors	
Product Selection	
E57G General Purpose Proximity Sensors	V8-T3-30
Compatible Connector Cables	V8-T3-31
Accessories	V8-T3-31
Technical Data and Specifications	V8-T3-32
Wiring Diagrams	V8-T3-33
Dimensions	V8-T3-34

E57G General Purpose Proximity Sensors

Product Description

For global sensing applications, the E57G General Purpose series is designed for most standard inductive sensing needs. With its stainless steel tubular body, 360 degree visible LED, fast switching speed and laser-etched markings, the E57G series is an ideal cost-effective solution.

Features

- 360° LED indicator
- Stainless steel tube
- 10–30 Vdc operating voltage
- Short-circuit protection
- –25 to 70 °C temperature range
- IP67 environmental rating
- Durable laser-engraved label
- Available in cable and micro-connector styles
- Nickel-brass mounting nuts

Standards and Certifications

- cULus Listed
- CE



⚠ DANGER

THIS SENSOR IS NOT A SAFETY DEVICE AND IS NOT INTENDED TO BE USED AS A SAFETY DEVICE. This sensor is designed only to detect and read certain data in an electronic manner and perform no use apart from that, specifically no safety-related use. This sensor product does not include self-checking redundant circuitry, and the failure of this sensor product could cause either an energized or de-energized output condition, which could result in death, serious bodily injury, or property damage.

For the most current information on this product, visit our Web site: www.eaton.com

For Customer Service in the U.S. call 1-877-ETN CARE (386-2273), in Canada call 1-800-268-3578. For Application Assistance in the U.S. and Canada call 1-800-426-9184.

Product Selection

E57G General Purpose Proximity Sensors

3

Three-Wire Sensors

Operating Voltage	Sensing Range	Shielding	Output Type	Connection Type	NO Output Catalog Number	NC Output Catalog Number
12 mm						
12 mm Diameter						
10–30 Vdc	2 mm (standard range)	Shielded	PNP	2-meter cable	E57G-12SPN2-C2	E57G-12SPC2-C2
				4-pin micro DC connector	E57G-12SPN2-Q	E57G-12SPC2-Q
			NPN	2-meter cable	E57G-12SNN2-C2	E57G-12SNC2-C2
				4-pin micro DC connector	E57G-12SNN2-Q	E57G-12SNC2-Q
	4 mm (standard range)	Unshielded	PNP	2-meter cable	E57G-12UPN4-C2	E57G-12UPC4-C2
				4-pin micro DC connector	E57G-12UPN4-Q	E57G-12UPC4-Q
			NPN	2-meter cable	E57G-12UNN4-C2	E57G-12UNC4-C2
				4-pin micro DC connector	E57G-12UNN4-Q	E57G-12UNC4-Q
	4 mm (extended range)	Shielded	PNP	2-meter cable	E57G-12SPN4-C2	E57G-12SPC4-C2
				4-pin micro DC connector	E57G-12SPN4-Q	E57G-12SPC4-Q
			NPN	2-meter cable	E57G-12SNN4-C2	E57G-12SNC4-C2
				4-pin micro DC connector	E57G-12SNN4-Q	E57G-12SNC4-Q
8 mm (extended range)	Unshielded	PNP	2-meter cable	E57G-12UPN8-C2	E57G-12UPC8-C2	
			4-pin micro DC connector	E57G-12UPN8-Q	E57G-12UPC8-Q	
		NPN	2-meter cable	E57G-12UNN8-C2	E57G-12UNC8-C2	
			4-pin micro DC connector	E57G-12UNN8-Q	E57G-12UNC8-Q	
18 mm						
18 mm Diameter						
10–30 Vdc	5 mm (standard range)	Shielded	PNP	2-meter cable	E57G-18SPN5-C2	E57G-18SPC5-C2
				4-pin micro DC connector	E57G-18SPN5-Q	E57G-18SPC5-Q
			NPN	2-meter cable	E57G-18SNN5-C2	E57G-18SNC5-C2
				4-pin micro DC connector	E57G-18SNN5-Q	E57G-18SNC5-Q
	8 mm (standard range)	Unshielded	PNP	2-meter cable	E57G-18UPN8-C2	E57G-18UPC8-C2
				4-pin micro DC connector	E57G-18UPN8-Q	E57G-18UPC8-Q
			NPN	2-meter cable	E57G-18UNN8-C2	E57G-18UNC8-C2
				4-pin micro DC connector	E57G-18UNN8-Q	E57G-18UNC8-Q
	8 mm (extended range)	Shielded	PNP	2-meter cable	E57G-18SPN8-C2	E57G-18SPC8-C2
				4-pin micro DC connector	E57G-18SPN8-Q	E57G-18SPC8-Q
			NPN	2-meter cable	E57G-18SNN8-C2	E57G-18SNC8-C2
				4-pin micro DC connector	E57G-18SNN8-Q	E57G-18SNC8-Q
	12 mm (extended range)	Unshielded	PNP	2-meter cable	E57G-18UPN12-C2	E57G-18UPC12-C2
				4-pin micro DC connector	E57G-18UPN12-Q	E57G-18UPC12-Q
			NPN	2-meter cable	E57G-18UNN12-C2	E57G-18UNC12-C2
				4-pin micro DC connector	E57G-18UNN12-Q	E57G-18UNC12-Q

Note

⊕⊖ See listing of compatible connector cables on **Page V8-T3-31**.

Three-Wire Sensors, continued

30 mm



Operating Voltage	Sensing Range	Shielding	Output Type	Connection Type	NO Output Catalog Number	NC Output Catalog Number		
30 mm Diameter								
10–30 Vdc	10 mm (standard range)	Shielded	PNP	2-meter cable	E57G-30SPN10-C2	E57G-30SPC10-C2		
				4-pin micro DC connector	E57G-30SPN10-Q	E57G-30SPC10-Q		
			NPN	2-meter cable	E57G-30SNN10-C2	E57G-30SNC10-C2		
				4-pin micro DC connector	E57G-30SNN10-Q	E57G-30SNC10-Q		
			15 mm (standard range)	Unshielded	PNP	2-meter cable	E57G-30UPN15-C2	E57G-30UPC15-C2
						4-pin micro DC connector	E57G-30UPN15-Q	E57G-30UPC15-Q
	NPN	2-meter cable			E57G-30UNN15-C2	E57G-30UNC15-C2		
		4-pin micro DC connector			E57G-30UNN15-Q	E57G-30UNC15-Q		
	15 mm (extended range)	Shielded			PNP	2-meter cable	E57G-30SPN15-C2	E57G-30SPC15-C2
						4-pin micro DC connector	E57G-30SPN15-Q	E57G-30SPC15-Q
			NPN	2-meter cable	E57G-30SNN15-C2	E57G-30SNC15-C2		
				4-pin micro DC connector	E57G-30SNN15-Q	E57G-30SNC15-Q		
22 mm (extended range)			Unshielded	PNP	2-meter cable	E57G-30UPN22-C2	E57G-30UPC22-C2	
					4-pin micro DC connector	E57G-30UPN22-Q	E57G-30UPC22-Q	
	NPN	2-meter cable		E57G-30UNN22-C2	E57G-30UNC22-C2			
		4-pin micro DC connector		E57G-30UNN22-Q	E57G-30UNC22-Q			

3

Compatible Connector Cables

Standard Cables ①

Micro-Style Straight Female



Voltage Style	Number of Pins	Gauge	Length	Pin Configuration/Wire Colors (Face View Female Shown)	PVC Jacket Catalog Number	PUR Jacket Catalog Number
Micro-Style, Straight Female						
DC	4-pin, 3-wire	22 AWG	6.0 ft (2m)		CSDS4A3CY2202	CSDS4A3RY2202

Accessories

E57G General Purpose Proximity Sensors

Description	Reference
Mounting brackets	See Tab 8, section 8.2
Replacement mounting nuts and other accessories	See Tab 8, section 8.3
Connector cables	See Tab 10, section 10.1

Notes

- ⊕ See listing of compatible connector cables on **Page V8-T3-31**.
- ① For a full selection of connector cables, see **Tab 10, section 10.1**.

Technical Data and Specifications

E57G General Purpose Proximity Sensors

Description	Three-Wire DC Sensors
Operating voltage	10–30 Vdc
Output current (continuous)	100 mA
Switching frequency [Hz]	Standard range: 12 mm—Shielded: 2000; Unshielded: 2000 18 mm—Shielded: 1200; Unshielded: 1200 30 mm—Shielded: 600; Unshielded: 500 Extended range: 12 mm—Shielded: 1200; Unshielded: 500 18 mm—Shielded: 300; Unshielded: 300 30 mm—Shielded: 400; Unshielded: 200
Leakage current	<100 μ A
Output voltage drop [Vsat]	<2.5 V
Current consumption	<10 mA
Short-circuit protection	Yes (Auto Reset)
Hysteresis [% of Sr]	2–20%
Repeat accuracy	1% shielded, 3% unshielded
Time delay before availability	<200 ms
Output indicator LED	360° amber LED
Operating temperature range	–25 to 70 °C
Ingress protection	IEC IP67, UL Type 1
Mechanical shock	IEC 60947-5-2 30 G half-sine wave, 11 mS
Vibration	IEC 60947-5-2 10–55 Hz, 1 mm amplitude
Housing materials	Front face: Ryton Tube: stainless steel End bells: M12 body: Polycarbonate Cable end bell: Polycarbonate Nuts: Ni-Brass
Cable	AWM style 20387 (PVC)

Wiring Diagrams

Pin numbers are for reference, rely on pin location when wiring.

E57G General Purpose Proximity Sensors

Operating Voltage	Output	Cable Models	Connector Models (Face View Male Shown) Micro
Three-Wire Sensors			
10–30 Vdc	NO (NPN)		
	NO (PNP)		
	NC (NPN)		
	NC (PNP)		

3.4

Inductive Proximity Sensors

E57G General Purpose Proximity Sensors

Dimensions

Approximate Dimensions in Inches (mm)

E57G General Purpose Proximity Sensors

3

Cable Models

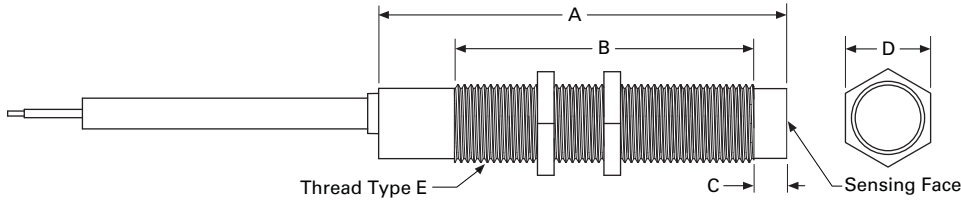

Connector Models

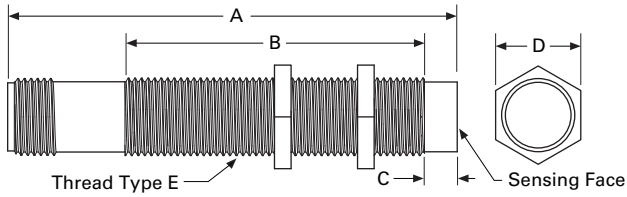

Size	Shielding	Overall Length A	Threaded Length B	Cap Height C	Nut Width D	Thread Size E
Three-Wire DC Sensors—Cable Models						
12 mm	Shielded	2.52 (64.1)	1.98 (50.3)	—	0.67 (16.8)	M12 x 1
	Unshielded	2.52 (64.1)	1.80 (45.8)	0.20 (5.0)	0.67 (16.8)	M12 x 1
18 mm	Shielded	2.59 (65.9)	2.00 (50.9)	—	0.94 (23.8)	M18 x 1
	Unshielded	2.59 (65.9)	1.75 (44.4)	0.28 (7.0)	0.94 (23.8)	M18 x 1
30 mm	Shielded	2.67 (67.7)	1.98 (50.3)	—	1.41 (35.9)	M30 x 1.5
	Unshielded	2.67 (67.7)	1.49 (37.8)	0.51 (13.0)	1.41 (35.9)	M30 x 1.5
Three-Wire DC Sensors—Micro-Connector Models						
12 mm	Shielded	2.70 (68.7)	1.98 (50.3)	—	0.67 (16.8)	M12 x 1
	Unshielded	2.70 (68.7)	1.80 (45.8)	0.20 (5.0)	0.67 (16.8)	M12 x 1
18 mm	Shielded	2.72 (69.2)	2.00 (50.9)	—	0.94 (23.8)	M18 x 1
	Unshielded	2.72 (69.2)	1.75 (44.4)	0.28 (7.0)	0.94 (23.8)	M18 x 1
30 mm	Shielded	2.79 (70.9)	1.98 (50.3)	—	1.41 (35.9)	M30 x 1.5
	Unshielded	2.79 (70.9)	1.49 (37.8)	0.51 (13.0)	1.41 (35.9)	M30 x 1.5

E57 Two-Wire (AC, AC/DC, DC) Proximity Sensors



E57 Two-Wire (AC, AC/DC, DC) Proximity Sensors

Product Description

Eaton carries several options for your sensing needs in the E57 two-wire family. The stainless steel models are available in a standard length or short body, while available in AC or AC/DC configurations. The nickel-brass body models are available in standard length and either AC or DC two-wire configurations.

All of these are available in NPN or PNP with cable connections or micro connectors. The stainless steel standard length models are also available with mini connectors.

The stainless steel models in both lengths have 360 degree LEDs while the nickel-brass models have a single LED indicator.

Extended sensing ranges are also available in the stainless steel and nickel-brass standard length models, while shielded and unshielded models are offered throughout the E57 two-wire sensor products.

Contents

Description

E57 Two-Wire (AC, AC/DC, DC) Proximity Sensors	
Product Selection	
Stainless Steel Body (Standard Length) . . .	V8-T3-36
Stainless Steel Short Body	V8-T3-38
Nickel-Brass Body	V8-T3-39
Compatible Connector Cables	V8-T3-40
Accessories	V8-T3-40
Technical Data and Specifications	V8-T3-41
Wiring Diagrams	V8-T3-43
Dimensions	V8-T3-45

Page

3

Standards and Certifications

Stainless steel body:

- cULus Listed
- CE (AC/DC models only)



Nickel-brass body:

- cCSAus
- CE (DC models only)



⚠ DANGER

THIS SENSOR IS NOT A SAFETY DEVICE AND IS NOT INTENDED TO BE USED AS A SAFETY DEVICE. This sensor is designed only to detect and read certain data in an electronic manner and perform no use apart from that, specifically no safety-related use. This sensor product does not include self-checking redundant circuitry, and the failure of this sensor product could cause either an energized or de-energized output condition, which could result in death, serious bodily injury, or property damage.

Highlighted Comparisons

Description	Stainless Steel	Stainless Steel Short Body	Nickel-Brass
Current ratings	250–500 mA	250–500 mA	200 mA
Enclosure ratings	NEMA 4, 4K, 6, 6P, 12, 13, IEC IP6, IP69K7	NEMA 4, 4K, 6, 6P, 12, 13, IEC IP67	IP67, IP69K
Operating temperature	–25 to 70 °C	–25 to 70 °C	–25 to 70 °C
Indicator	360° LED	360° LED	LED
Increased shock and vibration ratings	Yes	Yes	No

For the most current information on this product, visit our Web site: www.eaton.com



For Customer Service in the U.S. call 1-877-ETN CARE (386-2273), in Canada call 1-800-268-3578. For Application Assistance in the U.S. and Canada call 1-800-426-9184.

Product Selection

Stainless Steel Body (Standard Length)

3

Two-Wire Sensors

Operating Voltage	Sensing Range (Sn)	Shielding	Connection Type ^①	NO Output Catalog Number	NC Output Catalog Number		
12 mm							
12 mm Diameter End Sensing							
	20–250 Vac	2 mm (standard range)	Shielded	2-meter cable	E57LAL12A2	E57LBL12A2	
			Unshielded	3-pin micro AC connector	E57LAL12A2SA ☺	E57LBL12A2SA ☺	
				3-pin micro AC pigtail connector	E57LAL12A2SP ☺	E57LBL12A2SP ☺	
	4 mm (standard range)	Unshielded	2-meter cable	E57LAL12A2E	E57LBL12A2E		
			3-pin micro AC connector	E57LAL12A2EA ☺	E57LBL12A2EA ☺		
			3-pin micro AC pigtail connector	E57LAL12A2EP ☺	E57LBL12A2EP ☺		
	20–132 Vac	6 mm (extended range)	Semi-shielded	2-meter cable	E57-12LE06-A	E57-12LE06-A1	
				3-pin micro AC connector	E57-12LE06-AA ☺	E57-12LE06-A1A ☺	
				3-pin micro AC pigtail connector	E57-12LE06-AP ☺	—	
		10 mm (extended range)	Non-embeddable	2-meter cable	E57-12LE10-A	E57-12LE10-A1	
				3-pin micro AC connector	E57-12LE10-AA ☺	E57-12LE10-A1A ☺	
				3-pin micro AC pigtail connector	E57-12LE10-AP ☺	E57-12LE10-A1P ☺	
40–250 Vac 50/60 Hz ^② 20–250 Vdc	2 mm (standard range)	Shielded	2-meter cable	E57SAL12A2	E57SBL12A2		
			3-pin micro AC connector	E57SAL12A2SA ☺	E57SBL12A2SA ☺		
			3-pin mini-connector	E57MAL12A2B1 ☺	—		
	4 mm (standard range)	Unshielded	2-meter cable	E57SAL12A2E	E57SBL12A2E		
			3-pin micro AC connector	E57SAL12A2EA ☺	E57SBL12A2EA ☺		
			3-pin micro AC connector	E57SAL12A2EA ☺	E57SBL12A2EA ☺		
18 mm							
18 mm Diameter End Sensing							
	20–250 Vac	5 mm (standard range)	Shielded	2-meter cable	E57LAL18A2	E57LBL18A2	
				Unshielded	3-pin micro AC connector	E57LAL18A2SA ☺	E57LBL18A2SA ☺
					3-pin micro AC pigtail connector	E57LAL18A2SP ☺	E57LBL18A2SP ☺
			8 mm (standard range)	Unshielded	2-meter cable	E57LAL18A2E	E57LBL18A2E
					3-pin micro AC connector	E57LAL18A2EA ☺	E57LBL18A2EA ☺
					3-pin micro AC pigtail connector	E57LAL18A2EP ☺	E57LBL18A2EP ☺
		20–132 Vac	12 mm (extended range)	Semi-shielded	2-meter cable	E57-18LE12-A	E57-18LE12-A1
					3-pin micro AC connector	E57-18LE12-AA ☺	E57-18LE12-A1A ☺
					3-pin micro AC pigtail connector	E57-18LE12-AP ☺	E57-18LE12-A1P ☺
			18 mm (extended range)	Non-embeddable	2-meter cable	E57-18LE20-A	E57-18LE20-A1
					3-pin micro AC connector	E57-18LE20-AA ☺	E57-18LE20-A1A ☺
					3-pin micro AC pigtail connector	E57-18LE20-AP ☺	E57-18LE20-A1P ☺
	40–250 Vac 50/60 Hz ^② 20–250 Vdc	5 mm (standard range)	Shielded	2-meter cable	E57SAL18A2	E57SBL18A2	
				3-pin micro AC connector	E57SAL18A2SA ☺	E57SBL18A2SA ☺	
				3-pin mini-connector	E57MAL18A2B1 ☺	—	
		8 mm (standard range)	Unshielded	2-meter cable	E57SAL18A2E	E57SBL18A2E	
				3-pin micro AC connector	E57SAL18A2EA ☺	E57SBL18A2EA ☺	
				3-pin micro AC connector	E57SAL18A2EA ☺	E57SBL18A2EA ☺	

Notes

☺ See listing of compatible connector cables on **Page V8-T3-40**.

① For cable lengths longer than 2 meters, add the number of the desired length in meters to the end of the listed catalog number (for catalog numbers ending with a number, add an **S** and then the length). Examples for a 5-meter cable: E57-18LE12-A becomes E57-18LE12-A5; E57LAL12A2 becomes E57LAL12A2S5.

② Avoid wiring these AC/DC models in series as the sensors may not perform reliably. Contact Eaton's Applications Engineering at 1-800-426-9184 with questions.

Stainless Steel Body (Standard Length)

Two-Wire Sensors, continued

	Operating Voltage	Sensing Range (Sn)	Shielding	Connection Type ^①	NO Output Catalog Number	NC Output Catalog Number	
Right Angle 	18 mm Diameter Right Angle Sensing						
	20–250 Vac	5 mm	Shielded	2-meter cable	E57RAL18A2	E57RBL18A2	
				3-pin micro AC connector	E57RAL18A2SA ☺	E57RBL18A2SA ☺	
				3-pin micro AC pigtail connector	E57RAL18A2SP ☺	E57RBL18A2SP ☺	
				3-pin mini-connector	E57RAL18A2B1 ☺	E57RBL18A2B1 ☺	
	8 mm	Unshielded	2-meter cable	E57RAL18A2E	E57RBL18A2E		
			3-pin micro AC connector	E57RAL18A2EA ☺	E57RBL18A2EA ☺		
			3-pin micro AC pigtail connector	E57RAL18A2EP ☺	E57RBL18A2EP ☺		
			3-pin mini-connector	E57RAL18A2EB1 ☺	E57RBL18A2EB1 ☺		
			30 mm Diameter End Sensing				
20–250 Vac			10 mm (standard range)	Shielded	2-meter cable	E57LAL30A2	E57LBL30A2
	3-pin micro AC connector	E57LAL30A2SA ☺			E57LBL30A2SA ☺		
	3-pin micro AC pigtail connector	E57LAL30A2SP ☺			E57LBL30A2SP ☺		
	3-pin mini-connector	E57MAL30A2B1 ☺			E57MBL30A2B1 ☺		
	15 mm (standard range)	Unshielded	2-meter cable	E57LAL30A2E	E57LBL30A2E		
			3-pin micro AC connector	E57LAL30A2EA ☺	E57LBL30A2EA ☺		
			3-pin micro AC pigtail connector	E57LAL30A2EP ☺	E57LBL30A2EP ☺		
			3-pin mini-connector	E57MAL30A2EB1 ☺	E57MBL30A2EB1 ☺		
	20–132 Vac	22 mm (extended range)	Semi-shielded	2-meter cable	E57-30LE22-A	E57-30LE22-A1	
				3-pin micro AC connector	E57-30LE22-AA ☺	E57-30LE22-A1A ☺	
				3-pin micro AC pigtail connector	E57-30LE22-AP ☺	E57-30LE22-A1P ☺	
				3-pin mini-connector	E57-30LE22-AB ☺	E57-30LE22-A1B ☺	
40–250 Vac 50/60 Hz ^② 20–250 Vdc	10 mm (standard range)	Shielded	2-meter cable	E57SAL30A2	E57SBL30A2		
			3-pin micro AC connector	E57SAL30A2SA ☺	E57SBL30A2SA ☺		
	15 mm (standard range)	Unshielded	2-meter cable	E57SAL30A2E	E57SBL30A2E		
			3-pin micro AC connector	E57SAL30A2EA ☺	E57SBL30A2EA ☺		

Notes

☺ See listing of compatible connector cables on **Page V8-T3-40**.

① For cable lengths longer than 2 meters, add the number of the desired length in meters to the end of the listed catalog number (for catalog numbers ending with a number, add an **S** and then the length). Examples for a 5-meter cable: E57-18LE12-A becomes E57-18LE12-A5; E57LAL12A2 becomes E57LAL12A2S5.

② Avoid wiring these AC/DC models in series as the sensors may not perform reliably. Contact Eaton's Applications Engineering at 1-800-426-9184 with questions.

Stainless Steel Short Body

3

Two-Wire Sensors

Operating Voltage	Sensing Range (Sn)	Shielding	Connection Type ^①	NO Output Catalog Number	NC Output Catalog Number	
12 mm						
12 mm Diameter						
20–250 Vac	2 mm	Shielded	2-meter cable	E57SAL12A4	E57SBL12A4	
			3-pin micro AC connector	E57SAL12A4SA ☹	E57SBL12A4SA ☹	
		4 mm	Unshielded	2-meter cable	E57SAL12A4E	E57SBL12A4E
	3-pin micro AC connector			E57SAL12A4EA ☹	E57SBL12A4EA ☹	
	40–250 Vac 50/60 Hz ^② 20–250 Vdc	2 mm	Shielded	2-meter cable	E57SAL12A2	E57SBL12A2
				3-pin micro AC connector	E57SAL12A2SA ☹	E57SBL12A2SA ☹
4 mm			Unshielded	2-meter cable	E57SAL12A2E	E57SBL12A2E
		3-pin micro AC connector		E57SAL12A2EA ☹	E57SBL12A2EA ☹	
18 mm						
18 mm Diameter						
20–250 Vac	5 mm	Shielded	2-meter cable	E57SAL18A4	E57SBL18A4	
			3-pin micro AC connector	E57SAL18A4SA ☹	E57SBL18A4SA ☹	
		8 mm	Unshielded	2-meter cable	E57SAL18A4E	E57SBL18A4E
	3-pin micro AC connector			E57SAL18A4EA ☹	E57SBL18A4EA ☹	
	40–250 Vac 50/60 Hz ^② 20–250 Vdc	5 mm	Shielded	2-meter cable	E57SAL18A2	E57SBL18A2
				3-pin micro AC connector	E57SAL18A2SA ☹	E57SBL18A2SA ☹
8 mm			Unshielded	2-meter cable	E57SAL18A2E	E57SBL18A2E
		3-pin micro AC connector		E57SAL18A2EA ☹	E57SBL18A2EA ☹	
30 mm						
30 mm Diameter						
20–250 Vac	10 mm	Shielded	2-meter cable	E57SAL30A4	E57SBL30A4	
			3-pin micro AC connector	E57SAL30A4SA ☹	E57SBL30A4SA ☹	
		15 mm	Unshielded	2-meter cable	E57SAL30A4E	E57SBL30A4E
	3-pin micro AC connector			E57SAL30A4EA ☹	E57SBL30A4EA ☹	
	40–250 Vac 50/60 Hz ^② 20–250 Vdc	10 mm	Shielded	2-meter cable	E57SAL30A2	E57SBL30A2
				3-pin micro AC connector	E57SAL30A2SA ☹	E57SBL30A2SA ☹
15 mm			Unshielded	2-meter cable	E57SAL30A2E	E57SBL30A2E
		3-pin micro AC connector		E57SAL30A2EA ☹	E57SBL30A2EA ☹	

Notes



☹ See listing of compatible connector cables on **Page V8-T3-40**.

① Cable models are supplied as standard with a 2-meter cable. A 5-meter cable is available by adding **S5** to the catalog number. Example: E57SAL12T110 becomes E57SAL12T110**S5**.

② Avoid wiring these AC/DC models in series as the sensors may not perform reliably. Contact Eaton's Applications Engineering at 1-800-426-9184 with questions.

Nickel-Brass Body

Two-Wire Sensors

	Operating Voltage	Sensing Range	Shielding	Output Type	Connection Type	NO Output Catalog Number	NC Output Catalog Number	
	12 mm Diameter							
	20–250 Vac	2 mm	Shielded	—	2-meter cable	E57-12GS02-A	E57-12GS02-A1	
					3-pin micro AC connector	E57-12GS02-AAB ☺	E57-12GS02-A1AB ☺	
		4 mm	Unshielded	—	2-meter cable	E57-12GU04-A	E57-12GU04-A1	
					3-pin micro AC connector	E57-12GU04-AAB ☺	E57-12GU04-A1AB ☺	
	10–30 Vdc	2 mm	Shielded	NPN/PNP	2-meter cable	E57-12GS02-D	E57-12GS02-D1	
					4-pin micro DC connector	E57-12GS02-DDB ☺	E57-12GS02-D1DB ☺	
		4 mm	Unshielded	NPN/PNP	2-meter cable	E57-12GU04-D	E57-12GU04-D1	
					4-pin micro DC connector	E57-12GU04-DDB ☺	E57-12GU04-D1DB ☺	
		8 mm (extended range)			NPN/PNP	2-meter cable	E57-12GE08-D	E57-12GE08-D1
						4-pin micro DC connector	E57-12GE08-DDB ☺	E57-12GE08-D1DB ☺
		18 mm Diameter						
20–250 Vac		5 mm	Shielded	—	2-meter cable	E57-18GS05-A	E57-18GS05-A1	
					3-pin micro AC connector	E57-18GS05-AAB ☺	E57-18GS05-A1AB ☺	
		8 mm	Unshielded	—	2-meter cable	E57-18GU08-A	E57-18GU08-A1	
					3-pin micro AC connector	E57-18GU08-AAB ☺	E57-18GU08-A1AB ☺	
		16 mm				3-pin micro AC connector	E57-18GE16-AAB ☺	E57-18GE16-A1AB ☺
10–30 Vdc		5 mm	Shielded	NPN/PNP	2-meter cable	E57-18GS05-D	E57-18GS05-D1	
					4-pin micro DC connector	E57-18GS05-DDB ☺	E57-18GS05-D1DB ☺	
		8 mm	Unshielded	NPN/PNP	2-meter cable	E57-18GU08-D	E57-18GU08-D1	
					4-pin micro DC connector	E57-18GU08-DDB ☺	E57-18GU08-D1DB ☺	
		16 mm (extended range)			NPN/PNP	2-meter cable	E57-18GE16-D	E57-18GE16-D1
	4-pin micro DC connector					E57-18GE16-DDB ☺	E57-18GE16-D1DB ☺	
	30 mm Diameter							
	20–250 Vac	10 mm	Shielded	—	2-meter cable	E57-30GS10-A	E57-30GS10-A1	
					3-pin micro AC connector	E57-30GS10-AAB ☺	E57-30GS10-A1AB ☺	
		15 mm	Unshielded	—	2-meter cable	E57-30GU15-A	E57-30GU15-A1	
					3-pin micro AC connector	E57-30GU15-AAB ☺	E57-30GU15-A1AB ☺	
		10–30 Vdc	10 mm	Shielded	NPN/PNP	2-meter cable	E57-30GS10-D	E57-30GS10-D1
						4-pin micro DC connector	E57-30GS10-DDB ☺	E57-30GS10-D1DB ☺
	15 mm		Unshielded	NPN/PNP	2-meter cable	E57-30GU15-D	E57-30GU15-D1	
					4-pin micro DC connector	E57-30GU15-DDB ☺	E57-30GU15-D1DB ☺	
	25 mm (extended range)				NPN/PNP	2-meter cable	E57-30GE25-D	E57-30GE25-D1
						4-pin micro DC connector	E57-30GE25-DDB ☺	E57-30GE25-D1DB ☺

Note

☺☺ See listing of compatible connector cables on [Page V8-T3-40](#).

Compatible Connector Cables

Standard Cables ^①

3

Micro-Style
Straight Female



Voltage Style	Number of Pins	Gauge	Length	Pin Configuration/Wire Colors (Face View Female Shown)	PVC Jacket Catalog Number	PUR Jacket Catalog Number
Micro-Style, Straight Female						
AC	3-pin, 3-wire	22 AWG	6.0 ft (2m)	 <ul style="list-style-type: none"> 1-Green 2-Red/Black 3-Red/White 	CSAS3F3CY2202	CSAS3F3RY2202

Accessories

E57 Two-Wire Proximity Sensors

Description	Reference
Mounting brackets	See Tab 8, section 8.2
Replacement mounting nuts and other accessories	See Tab 8, section 8.3
Connector cables	See Tab 10, section 10.1

Note

^① For a full selection of connector cables, see **Tab 10, section 10.1**.

Technical Data and Specifications

Stainless Steel Body

Description	Two-Wire AC/DC Sensors		
	Two-Wire AC Sensors	AC Operation	DC Operation
Operating voltage	40–250 Vac	40–250 Vac	20–250 Vdc
Maximum load current	250 mA	200 mA	200 mA
Switching frequency	20 Hz	60 Hz	60 Hz
Leakage current	1.7 mA maximum at 70 °C	1.7V mA maximum at 120 Vac	≤2.0 mA
Voltage drop	7V maximum	≤4 V at >25 mA	12 V at <10 mA
Holding current	5 mA minimum	5 mA minimum	5 mA maximum
Protection	—	Resettable short circuit; overload protection	Resettable short circuit; overload protection
Switching hysteresis	2–20% of rated sensing distance	2–20% of rated sensing distance	2–20% of rated sensing distance
Repeat accuracy	<3% sensing distance	<3% sensing distance	<3% sensing distance
Output indicator LED	360° viewable LED	360° viewable LED	360° viewable LED
Operating temperature	–13 to 158 °F (–25 to 70 °C) ①	–13 to 158 °F (–25 to 70 °C) ①	–13 to 158 °F (–25 to 70 °C) ①
Enclosure ratings	NEMA 4, 4X, 6, 6P, 12 and 13 (IP67)	NEMA 4, 4X, 6, 6P, 12 and 13 (IP67)	NEMA 4, 4X, 6, 6P, 12 and 13 (IP67)
Shock	30 g sine wave, 11 ms per IEC68-2-76	30 g sine wave, 11 ms per IEC68-2-76	30 g sine wave, 11 ms per IEC68-2-76
Vibration	10 to 55 Hz, 1 mm amplitude	10 to 55 Hz, 1 mm amplitude	10 to 55 Hz, 1 mm amplitude
Material of construction	Stainless steel, polycarbonate end bells, Ryton® front cap	Stainless steel, polycarbonate end bells, Ryton® front cap	Stainless steel, polycarbonate end bells, Ryton® front cap
Cable	AWM Style 20387 (PVC)	AWM Style 20387 (PVC)	AWM Style 20387 (PVC)

Notes

Ryton® is a registered trademark of Phillips Chemical (division of Phillips Petroleum).

① 240 Vac operation is limited to less than 122 °F (50 °C) in two-wire AC/DC models.

Nickel-Brass Body

Description	Two-Wire AC Sensors	Two-Wire DC Sensors
Operating voltage	20–250 Vac	10–30 Vdc
OFF-state leakage	<1.8 mA	<0.8 mA
Maximum load current	200 mA	100 mA
Minimum load current	5 mA	3 mA
Surge current	5 A (20 ms)	—
Voltage drop	<8 Vac at 400 mA	<6 V
Switching frequency		
8 mm diameter	—	—
12 mm diameter	25 Hz	1 kHz (shielded); 1 kHz (unshielded)
18 mm diameter	25 Hz	1 kHz (shielded); 500 Hz (unshielded)
30 mm diameter	25 Hz	500 Hz (shielded); 200 Hz (unshielded)
Short-circuit protection	No	Yes
Overload trip point	—	>120 mA
Time delay before availability	—	—
Transient protection	—	2 kV, 1 ms, 1 kohm
Repeat accuracy	Shielded: <1.0%/Unshielded: <3.0% (Sr)	<2.0% (Sr)
Switching hysteresis	<15%	<15%
Operating temperature	–13 to 158 °F (–25 to 70 °C) (32 to 140 °F [0 to 60 °C] for all extended range models)	–13 to 158 °F (–25 to 70 °C) (32 to 140 °F [0 to 60 °C] for all extended range models)
Temperature drift	<10% (Sr)	<10% (Sr)
Protection	IP67, IP69K	IP67, IP69K
Housing material	Nickel plated brass (stainless steel for 8 mm diameter, nano-connector models)	Nickel plated brass (stainless steel for 8 mm diameter, nano-connector models)
Cable	PVC jacket, 2-meter length	PVC jacket, 2-meter length

Recommended Mounting Clearances

For unshielded standard range sensors and extended range sensors, clearance must be provided around the sensor when mounting for reliable performance. ("Sn" is the sensing range of the sensor, "d" is the sensor diameter.)

E57 Premium Sensors, Mounting

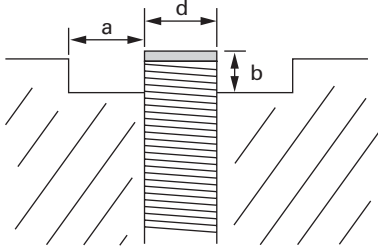

Type	Shielding	a	b
Standard range	Shielded	0	0
	Unshielded	Cap height	2 x Sn
Extended range	Semi-shielded	d	Sn
	Non-embeddable	Cap height	2 x Sn

Wiring Diagrams

Pin numbers are for reference, rely on pin location when wiring.

Stainless Steel Body

Operating Voltage	Output	Cable Models	Connector Models (Face View Male Shown)	
			Micro	Mini
Two-Wire Sensors				
20–250 Vac/dc and AC-only AC wiring example	NO and NC			
20–250 Vac/dc DC wiring example	NO and NC (NPN)			—
	NO and NC (PNP)			—

3.5

Inductive Proximity Sensors

E57 Two-Wire (AC, AC/DC, DC) Proximity Sensors

Nickel-Brass Body

Operating Voltage	Output	Cable Models	Connector Models (Face View Male Shown) Micro
Two-Wire Sensors			
20–250 Vac	NO	<p>* Internally connected to housing (use of this wire is optional)</p>	<p>* Internally connected to housing (use of this wire is optional)</p>
10–30 Vdc	NO (NPN)		
	NO (PNP)		

3

Dimensions

Approximate Dimensions in Inches (mm)

Stainless Steel Body (Standard Length) ^{①②}

Cable Models

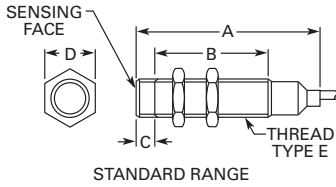

Connector Models

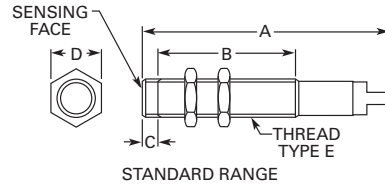

Size	Shielding	Overall Length A	Threaded Length B	Cap Height C	Nut Width D	Thread Size E
Two-Wire AC Sensors—Cable Models						
12 mm	Shielded	2.46 (62.4)	1.98 (50.3)	—	0.67 (16.8)	M12 x 1
	Semi-shielded	2.87 (72.8)	2.28 (57.9)	0.06 (1.62)	0.67 (16.8)	M12 x 1
	Unshielded	2.87 (72.7)	1.98 (50.3)	0.36 (9.14)	0.67 (16.8)	M12 x 1
18 mm	Shielded	2.54 (64.5)	2.00 (50.9)	—	0.94 (23.8)	M18 x 1
	Semi-shielded	2.60 (66.1)	1.90 (48.2)	0.10 (2.54)	0.94 (23.8)	M18 x 1
	Unshielded	2.60 (66.0)	1.47 (37.2)	0.56 (14.1)	0.94 (23.8)	M18 x 1
30 mm	Shielded	2.73 (69.3)	1.98 (50.3)	—	1.41 (35.9)	M30 x 1.5
	Semi-shielded	2.67 (67.8)	1.90 (48.2)	0.13 (3.30)	1.41 (35.9)	M30 x 1.5
	Unshielded	2.73 (69.3)	1.49 (37.8)	0.52 (13.26)	1.41 (35.9)	M30 x 1.5
Two-Wire AC Sensors—Micro-Connector Models						
12 mm	Shielded	2.69 (68.4)	1.98 (50.3)	—	0.67 (16.8)	M12 x 1
	Semi-shielded	3.04 (77.2)	2.28 (57.9)	0.06 (1.62)	0.67 (16.8)	M12 x 1
	Unshielded	3.06 (77.7)	1.98 (50.3)	0.36 (9.14)	0.36 (9.14)	M12 x 1
18 mm	Shielded	2.72 (69.06)	2.00 (50.9)	—	0.94 (23.8)	M18 x 1
	Semi-shielded	2.72 (69.1)	1.90 (48.2)	0.10 (2.54)	0.94 (23.8)	M18 x 1
	Unshielded	2.74 (69.4)	1.47 (37.2)	0.56 (14.1)	0.94 (23.8)	M18 x 1
30 mm	Shielded	2.91 (73.8)	1.98 (50.3)	—	1.41 (35.9)	M30 x 1.5
	Semi-shielded	2.78 (70.6)	1.90 (48.2)	0.13 (3.30)	1.41 (35.9)	M30 x 1.5
	Unshielded	2.91 (73.8)	1.49 (37.8)	0.52 (13.26)	1.41 (35.9)	M30 x 1.5

Notes

- ① These dimensions apply to the Premium+ Series models in this section. Not indicated Premium Series models.
- ② For short body model dimensions (E57SAL ...) refer to **Page V8-T3-24**.

Approximate Dimensions in Inches (mm)

Stainless Steel Body (Standard Length) ①②

Cable Models, continued

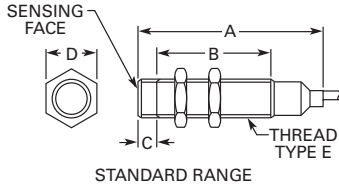

Connector Models, continued

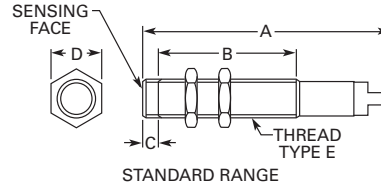

Size	Shielding	Overall Length A	Threaded Length B	Cap Height C	Nut Width D	Thread Size E
Two-Wire AC/DC Sensors—Cable Models						
12 mm	Shielded	2.45 (62.4)	1.98 (50.3)	—	0.67 (16.8)	M12 x 1
	Unshielded	2.45 (62.4)	1.80 (45.8)	0.20 (5)	0.67 (16.8)	M12 x 1
18 mm	Shielded	2.54 (64.5)	2.00 (50.9)	—	0.94 (23.8)	M18 x 1
	Unshielded	2.54 (64.5)	1.75 (44.4)	0.28 (7)	0.94 (23.8)	M18 x 1
30 mm	Shielded	2.72 (69.3)	2.12 (53.8)	—	1.41 (35.9)	M30 x 1.5
	Unshielded	2.72 (69.3)	1.63 (41.4)	0.52 (13.26)	1.41 (35.9)	M30 x 1.5
Two-Wire AC/DC Sensors—Micro-Connector Models						
12 mm	Shielded	2.69 (68.4)	1.98 (50.3)	—	0.67 (16.8)	M12 x 1
	Unshielded	2.69 (68.4)	1.80 (45.8)	0.20 (5)	0.67 (16.8)	M12 x 1
18 mm	Shielded	2.72 (69.06)	2.00 (50.9)	—	0.94 (23.8)	M18 x 1
	Unshielded	2.72 (69.06)	1.75 (44.4)	0.28 (7)	0.94 (23.8)	M18 x 1
30 mm	Shielded	2.91 (73.8)	1.98 (50.3)	—	1.41 (35.9)	M30 x 1.5
	Unshielded	2.91 (73.8)	1.49 (37.8)	0.52 (13.26)	1.41 (35.9)	M30 x 1.5
Two-Wire AC Sensors—Mini-Connector Models						
18 mm	Shielded	3.39 (86.1)	2.00 (50.8)	0.02 (0.5)	0.94 (23.8)	M18 x 1
	Semi-shielded	3.39 (86.0)	1.90 (48.2)	0.10 (2.54)	0.94 (23.8)	M18 x 1
	Unshielded	3.39 (86.1)	1.46 (37.0)	0.57 (14.5)	0.94 (23.8)	M18 x 1
30 mm	Shielded	3.39 (86.1)	2.1 (53.3)	0.03 (0.8)	1.41 (35.9)	M30 x 1.5
	Semi-shielded	3.44 (87.4)	1.90 (48.2)	0.13 (3.30)	1.41 (35.9)	M30 x 1.5
	Unshielded	3.39 (86.1)	1.55 (39.4)	0.55 (14.0)	1.41 (35.9)	M30 x 1.5

Notes

- ① These dimensions apply to the Premium+ Series models in this section. Not indicated Premium Series models.
- ② For short body model dimensions (E57SAL ...) refer to **Page V8-T3-24**.

Approximate Dimensions in Inches (mm)

Stainless Steel Short Body (Cable Connector Models)

12 mm

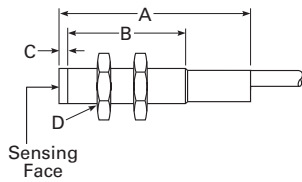

18 mm

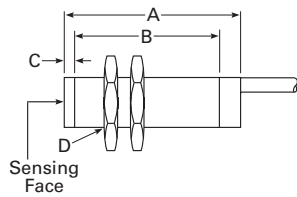

30 mm

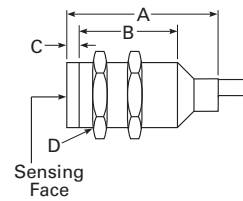

Size	Shielding	Overall Length A	Threaded Length B	Cap Height C	Thread Size D
Two-Wire AC Sensors					
12 mm	Shielded	2.04 (51.7)	1.56 (39.6)	0.02 (0.5)	M12 x 1
	Unshielded	2.04 (51.7)	1.38 (35.1)	0.20 (5)	M12 x 1
18 mm	Shielded	1.39 (35.3)	0.86 (21.82)	0.02 (0.5)	M18 x 1
	Unshielded	1.39 (35.3)	0.60 (15.32)	0.28 (7)	M18 x 1
30 mm	Shielded	1.58 (40.2)	0.99 (25.15)	0.03 (0.8)	M30 x 1.5
	Unshielded	1.77 (44.9)	0.68 (17.27)	0.52 (13.26)	M30 x 1.5
Two-Wire AC/DC Sensors					
12 mm	Shielded	2.46 (62.4)	1.98 (50.27)	—	M12 x 1
	Unshielded	2.46 (62.4)	1.80 (45.77)	0.20 (5)	M12 x 1
18 mm	Shielded	2.54 (64.5)	2.00 (50.9)	—	M18 x 1
	Unshielded	2.54 (64.5)	1.75 (44.4)	0.28 (7)	M18 x 1
30 mm	Shielded	2.72 (69.3)	2.12 (53.8)	—	M30 x 1.5
	Unshielded	2.72 (69.3)	1.63 (41.4)	0.52 (13.26)	M30 x 1.5

Stainless Steel Short Body (Micro-Connector Models)

12 mm

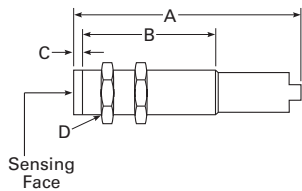

18 mm

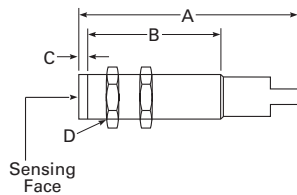

30 mm

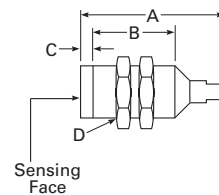

Size	Shielding	Overall Length A	Threaded Length B	Cap Height C	Thread Size D
Two-Wire AC Sensors					
12 mm	Shielded	2.27 (57.8)	1.56 (39.6)	0.02 (0.5)	M12 x 1
	Unshielded	2.27 (57.8)	1.38 (35.1)	0.20 (5)	M12 x 1
18 mm	Shielded	1.57 (40.0)	0.86 (21.82)	0.02 (0.5)	M18 x 1
	Unshielded	1.57 (40.0)	0.60 (15.32)	0.28 (7)	M18 x 1
30 mm	Shielded	1.76 (44.8)	0.99 (25.15)	0.03 (0.8)	M30 x 1.5
	Unshielded	1.95 (49.5)	0.68 (17.27)	0.52 (13.26)	M30 x 1.5
Two-Wire AC/DC Sensors					
12 mm	Shielded	2.69 (68.4)	1.98 (50.27)	—	M12 x 1
	Unshielded	2.69 (68.4)	1.80 (45.77)	0.20 (5)	M12 x 1
18 mm	Shielded	2.72 (69.06)	2.00 (50.9)	—	M18 x 1
	Unshielded	2.72 (69.06)	1.75 (44.4)	0.28 (7)	M18 x 1
30 mm	Shielded	2.91 (73.8)	2.12 (53.8)	—	M30 x 1.5
	Unshielded	2.91 (73.8)	1.63 (41.4)	0.52 (13.26)	M30 x 1.5

3.5

Inductive Proximity Sensors

E57 Two-Wire (AC, AC/DC, DC) Proximity Sensors

Approximate Dimensions in mm

Nickel-Brass Body

Cable Models

Two-Wire Sensors

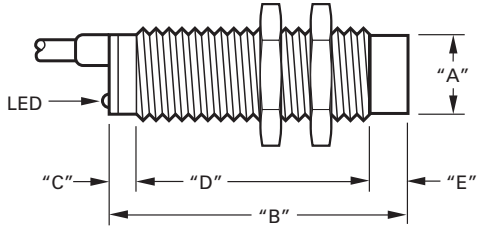

Catalog Number	Operating Voltage	A	B	C	D	E
E57-12GS02-A	20–250 Vac	M12x1	65	15	50	—
E57-12GU04-A		M12x1	60	15	42	8
E57-18GS05-A		M18x1	80	20	60	—
E57-18GU08-A		M18x1	80	20	48	12
E57-30GS10-A		M30x1.5	80	20	60	—
E57-30GU15-A		M30x1.5	80	20	45	15
E57-12GS02-D	10–30 Vdc	M12x1	50	—	50	—
E57-12GU04-D		M12x1	50	—	42	8
E57-12GE08-D		M12x1	50	—	42	8
E57-12GE08-D1		M12x1	50	—	42	8
E57-18GS05-D		M18x1	55	5	50	—
E57-18GU08-D		M18x1	55	5	38	12
E57-18GE16-D		M18x1	55	5	38	12
E57-18GE16-D1		M18x1	55	5	38	12
E57-30GS10-D		M30x1.5	55	5	50	—
E57-30GU15-D		M30x1.5	55	5	35	15
E57-30GE25-D		M30x1.5	55	5	35	15
E57-30GE25-D1		M30x1.5	55	5	35	15

Connector Models

Two-Wire Sensors

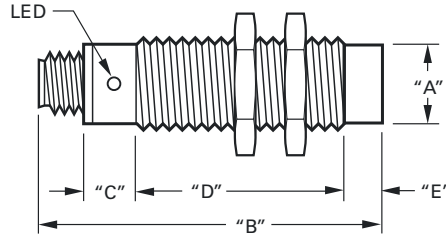

Catalog Number ^①	Operating Voltage	A	B	C	D	E
E57-12GS02-AAB	20–250 Vac	M12x1	68	16	42	—
E57-12GU04-AAB		M12x1	68	16	34	8
E57-18GS05-AAB		M18x1	91	20	60	—
E57-18GU08-AAB		M18x1	91	20	48	12
E57-18GE16-AAB		M18x1	79.2	15	37	11.5
E57-30GS10-AAB		M30x1.5	80	20	60	—
E57-30GU15-AAB		M30x1.5	91	20	45	15
E57-12GS02-DBB	10–30 Vdc	M12x1	69	16	42	—
E57-12GU04-DBB		M12x1	68	16	34	8
E57-12GE08-DBB		M12x1	68	10	50	8
E57-12GE08-D1DB		M12x1	68	10	50	8
E57-18GS05-DBB		M18x1	76	15	61	—
E57-18GU08-DBB		M18x1	80	15	49	12
E57-18GE16-DBB		M18x1	79	15	52	12
E57-30GS10-DBB		M30x1.5	75	15	60	—
E57-30GU15-DBB		M30x1.5	79	15	45	15
E57-30GE25-DBB		M30x1.5	78	15	48	15

Note

^① Normally closed models are dimensionally indicated to equivalent normally open models.

AccuProx Analog Sensors



AccuProx Analog Sensors

Product Description

The AccuProx from Eaton's Electrical Sector is a high performance analog inductive proximity sensor. The AccuProx family of analog sensors provide unmatched sensing range, linearity and resolution in an affordable and compact tubular package.

Unlike standard inductive sensors, which send an open or close signal upon target presence or absence, AccuProx analog sensors provide an electrical signal that varies in proportion to the position of the metal target within its sensing range. This makes AccuProx ideal for applications requiring precise position sensing and measurement.

The sensing performance of AccuProx sets it apart from traditional analog inductive designs. Utilizing components from the cutting-edge iProx family, AccuProx provides sensing ranges of three to four times that of typical tubular analog inductive sensors—all without compromising accuracy.

Unlike many competitive products, which are often hampered by an "S-shaped" output curve, AccuProx outputs are linear.

AccuProx has the range and precision to solve your most difficult measurement applications.

Application Description

Typical Applications

- Part positioning
- Distance, size and thickness measurement
- General inspection and error proofing, such as material imperfection or blemish detection
- Eccentricity or absolute angle detection
- Identification of different metals

See the Application Guide on **Page V8-T3-50** for more detail.

Contents

Description

	<i>Page</i>
AccuProx Analog Sensors	
Application Guide	V8-T3-50
Product Selection	
AccuProx Analog Sensors	V8-T3-51
Compatible Connector Cables	V8-T3-51
Technical Data and Specifications	V8-T3-52
Wiring Diagrams	V8-T3-54
Dimensions	V8-T3-54

Features

- Extended linear sensing range of up to 25 millimeters—three times longer than standard tubular analog inductive sensors
- Outputs available in current (4–20 or 0–20 mA) and voltage (0–10 V)
- High output resolution and repeatability for applications requiring precision sensing performance
- Robust stainless steel barrel, shock-resistant front cap, polycarbonate end bell and impact-absorbing potting compound
- Ideal for extreme temperature or high pressure washdown environments
- High noise immunity of 20 V/m prevents many problems associated with electrical noise

Standards and Certifications

- cUL Listed
- CE



⚠ DANGER

THIS SENSOR IS NOT A SAFETY DEVICE AND IS NOT INTENDED TO BE USED AS A SAFETY DEVICE. This sensor is designed only to detect and read certain data in an electronic manner and perform no use apart from that, specifically no safety-related use. This sensor product does not include self-checking redundant circuitry, and the failure of this sensor product could cause either an energized or de-energized output condition, which could result in death, serious bodily injury, or property damage.

For the most current information on this product, visit our Web site: www.eaton.com

For Customer Service in the U.S. call 1-877-ETN CARE (386-2273), in Canada call 1-800-268-3578. For Application Assistance in the U.S. and Canada call 1-800-426-9184.

Application Guide

Presenting AccuProx— Unmatched Analog Range in a Proven Package

3

Historically, analog sensors have been limited by very short sensing ranges—as little as one or two millimeters. By utilizing technology first perfected in the iProx family of digital inductive sensors, AccuProx can sense objects as far as 25 millimeters. This extended range can be achieved without making compromises often found in competitive products, such as reduced output accuracy.

AccuProx utilizes many of the proven materials found in other tubular sensor families. The threaded barrel and included mounting nuts are made of stainless steel, which exhibits superior corrosion and abrasion resistance versus nickel-plated brass. AccuProx also features a proprietary internal potting compound that absorbs impacts and vibration while sealing out moisture. The materials used in the construction of AccuProx are time-tested and proven to work.

High Output Accuracy

Analog inductive sensors are often used in applications that require a higher level of precision than a standard digital sensor. For example, applications such as part inspection require a sensor that can detect very small variances. AccuProx has been designed with these applications in mind.

Output accuracy is determined by the repeat accuracy, linearity, resolution and response time of the sensor.

Repeat accuracy refers to the variations in sensing distance between successive sensor operations due to component tolerances, where all operating conditions are kept the same. The repeat accuracy of an 18 millimeter, unshielded AccuProx sensor is less than 20 micrometers. See the chart below for a repeat accuracy comparison of AccuProx versus the competition.

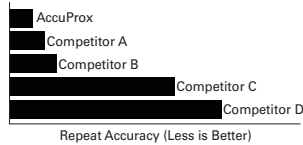

Linearity refers to the shape of the output curve. Many competitive analog sensors exhibit a wavy or “S-shaped” output curve. This means that a change in target distance may not always translate into an equivalent change in output, particularly at the innermost and outermost ranges of a non-linear analog sensor. AccuProx features a linear output. See the diagram below for an example of AccuProx versus a non-linear competitive offering.

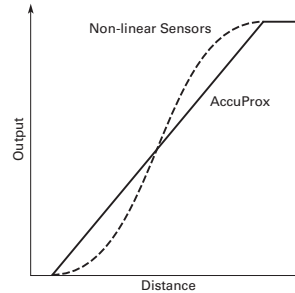

Resolution refers to the number of “steps” in the sensor output. A higher resolution is ideal because it will allow the sensor to detect smaller changes in target position.

An 18 millimeter, unshielded AccuProx features more than 350 output steps, ensuring consistent performance.

Typical Analog Applications Material Imperfection or Blemish Detection

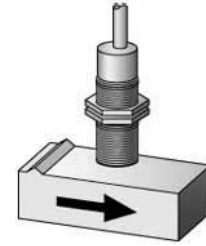

Eccentricity or Absolute Angle Detection



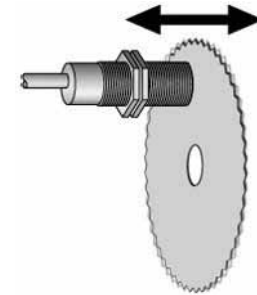

Saw Blade Deflection



Product Selection



AccuProx Analog Sensors

Three-/Four-Wire Sensors

	Operating Voltage	Sensing Range ^①	Shielding	Connection Type	Current (0–20 mA) and Voltage (0–10 V) Output ^② Catalog Number	Current (4–20 mA) Output Only ^② Catalog Number
12 mm 	12 mm Diameter					
	15–30 Vdc	0.5–4 mm	Shielded	4-pin micro DC connector	E59-A12A104D01-CV ☹	E59-A12A104D01-C1 ☹
				4-pin micro DC pigtail	E59-A12A104D01P-CV ☹	E59-A12A104D01P-C1 ☹
				2-meter cable	E59-A12A104C02-CV	E59-A12A104C02-C1
	1–8 mm	Unshielded	4-pin micro DC connector	E59-A12C108D01-CV ☹	E59-A12C108D01-C1 ☹	
			4-pin micro DC pigtail	E59-A12C108D01P-CV ☹	E59-A12C108D01P-C1 ☹	
2-meter cable			E59-A12C108C02-CV	E59-A12C108C02-C1		
18 mm 	18 mm Diameter					
	15–30 Vdc	1–7 mm	Shielded	4-pin micro DC connector	E59-A18A107D01-CV ☹	E59-A18A107D01-C1 ☹
				4-pin micro DC pigtail	E59-A18A107D01P-CV ☹	E59-A18A107D01P-C1 ☹
				2-meter cable	E59-A18A107C02-CV	E59-A18A107C02-C1
	1–15 mm	Unshielded	4-pin micro DC connector	E59-A18C115D01-CV ☹	E59-A18C115D01-C1 ☹	
			4-pin micro DC pigtail	E59-A18C115D01P-CV ☹	E59-A18C115D01P-C1 ☹	
2-meter cable			E59-A18C115C02-CV	E59-A18C115C02-C1		
30 mm 	30 mm Diameter					
	15–30 Vdc	1–12 mm	Shielded	4-pin micro DC connector	E59-A30A112D01-CV ☹	E59-A30A112D01-C1 ☹
				4-pin micro DC pigtail	E59-A30A112D01P-CV ☹	E59-A30A112D01P-C1 ☹
				2-meter cable	E59-A30A112C02-CV	E59-A30A112C02-C1
	1–25 mm	Unshielded	4-pin micro DC connector	E59-A30C125D01-CV ☹	E59-A30C125D01-C1 ☹	
			4-pin micro DC pigtail	E59-A30C125D01P-CV ☹	E59-A30C125D01P-C1 ☹	
2-meter cable			E59-A30C125C02-CV	E59-A30C125C02-C1		

Compatible Connector Cables

Standard Cables ^③

Voltage Style	Number of Pins	Gauge	Length	Pin Configuration/Wire Colors (Face View Female Shown)	PVC Jacket Catalog Number	PUR Jacket Catalog Number
Micro-Style Straight Female 	Micro-Style, Straight Female					
	DC	4-pin, 3-wire	22 AWG	6.0 ft (2m)	 1-Brown 2-No Wire 3-Blue 4-Black	CSDS4A3CY2202
DC	4-pin, 4-wire	22 AWG	6.0 ft (2m)	 1-Brown 2-White 3-Blue 4-Black	CSDS4A4CY2202	CSDS4A4RY2202

Notes

- ☹ See listing of compatible connector cables above.
- ① Published range data is based on a 1 mm thick square target made of Type FE 360 steel per ISO Standard 630.
- ② Models available in custom output configurations (for example, 1–5 V, 0–5 V). Contact factory for details.
- ③ For a full selection of connector cables, see **Tab 10, section 10.1**.

Technical Data and Specifications

AccuProx Analog Sensors

3

Description	12 mm Models		18 mm Models		30 mm Models	
	Shielded	Unshielded	Shielded	Unshielded	Shielded	Unshielded
Performance						
Analog operating range ^①	0.5–4 mm	1–8 mm	1–7 mm	1–15 mm	1–12 mm	1–25 mm
Temperature range	–40 to 158 °F (–40 to 70 °C)	–40 to 158 °F (–40 to 70 °C)	–40 to 158 °F (–40 to 70 °C)	–40 to 158 °F (–40 to 70 °C)	–40 to 158 °F (–40 to 70 °C)	–40 to 158 °F (–40 to 70 °C)
Temperature drift	<± 10%	<± 10%	<± 10%	<± 10%	<± 10%	<± 10%
Conformity	<± 10%	<± 10%	<± 10%	<± 10%	<± 10%	<± 10%
Repeat accuracy	<25 μm ^②	<20 μm ^②	<40 μm ^②	<20 μm ^②	<50 μm ^②	<30 μm ^②
Minimum repeat accuracy	<3.0% at max. range	<1.1% at max. range	<2.2% at max. range	<1.2% at max. range	<1.2% at max. range	<0.8% at max. range
Recovery time	<1.0 ms	<1.1 ms	<1.5 ms	<2.0 ms	<2.0 ms	<3.0 ms
Response time	200 Hz	100 Hz	200 Hz	100 Hz	140 Hz	100 Hz
Linearity tolerance	<± 1.0% of full scale	<± 1.0% of full scale	<± 1.0% of full scale	<± 1.0% of full scale	<± 1.0% of full scale	<± 1.0% of full scale
Resolution	23 μm max.	16 μm max.	40 μm max.	21 μm max.	50 μm max.	30 μm max.
Electrical						
Style	AccuProx Analog, three-/four-wire DC	AccuProx Analog, three-/four-wire DC	AccuProx Analog, three-/four-wire DC	AccuProx Analog, three-/four-wire DC	AccuProx Analog, three-/four-wire DC	AccuProx Analog, three-/four-wire DC
Operating voltage	15–30 Vdc	15–30 Vdc	15–30 Vdc	15–30 Vdc	15–30 Vdc	15–30 Vdc
Current output signal	0–20 mA or 4–20 mA by model	0–20 mA or 4–20 mA by model	0–20 mA or 4–20 mA by model	0–20 mA or 4–20 mA by model	0–20 mA or 4–20 mA by model	0–20 mA or 4–20 mA by model
Current output load resistance	400–500 ohms	400–500 ohms	400–500 ohms	400–500 ohms	400–500 ohms	400–500 ohms
Current output ripple content	± 40 μA max.	± 40 μA max.	± 40 μA max.	± 40 μA max.	± 40 μA max.	± 40 μA max.
Current output minimum change	30 μA	20 μA	50 μA	28 μA	66 μA	40 μA
Voltage output signal ^③	0–10 V	0–10 V	0–10 V	0–10 V	0–10 V	0–10 V
Voltage output load resistance	4.7–5.0 kohm (2.5 mA max.)	4.7–5.0 kohm (2.5 mA max.)	4.7–5.0 kohm (2.5 mA max.)	4.7–5.0 kohm (2.5 mA max.)	4.7–5.0 kohm (2.5 mA max.)	4.7–5.0 kohm (2.5 mA max.)
Voltage output ripple content	± 10 mV max.	± 10 mV max.	± 10 mV max.	± 10 mV max.	± 10 mV max.	± 10 mV max.
Voltage output minimum change	15 mV	10 mV	25 mV	14 mV	33 mV	20 mV
Burden current	<20 mA	<20 mA	<20 mA	<20 mA	<20 mA	<20 mA
Output LED	Dual-color, 360° viewable	Dual-color, 360° viewable	Dual-color, 360° viewable	Dual-color, 360° viewable	Dual-color, 360° viewable	Dual-color, 360° viewable
Short-circuit protection	Incorporated ^④	Incorporated ^④	Incorporated ^④	Incorporated ^④	Incorporated ^④	Incorporated ^④
Wire breakage protection	Incorporated	Incorporated	Incorporated	Incorporated	Incorporated	Incorporated
Reverse polarity protection	Incorporated	Incorporated	Incorporated	Incorporated	Incorporated	Incorporated
Physical						
Size	See Dimensions on Page V8-T3-54 .					
Enclosure protection	NEMA 4, 4X, 6, 6P, 13	NEMA 4, 4X, 6, 6P, 13	NEMA 4, 4X, 6, 6P, 13	NEMA 4, 4X, 6, 6P, 13	NEMA 4, 4X, 6, 6P, 13	NEMA 4, 4X, 6, 6P, 13
Shock	30 g half-sine at 11 ms	30 g half-sine at 11 ms	30 g half-sine at 11 ms	30 g half-sine at 11 ms	30 g half-sine at 11 ms	30 g half-sine at 11 ms
Vibration	10–55 Hz, 1 mm amplitude	10–55 Hz, 1 mm amplitude	10–55 Hz, 1 mm amplitude	10–55 Hz, 1 mm amplitude	10–55 Hz, 1 mm amplitude	10–55 Hz, 1 mm amplitude
Housing material	Stainless steel, polycarbonate end bell, polyphenylene sulfide front cap	Stainless steel, polycarbonate end bell, polyphenylene sulfide front cap	Stainless steel, polycarbonate end bell, polyphenylene sulfide front cap	Stainless steel, polycarbonate end bell, polyphenylene sulfide front cap	Stainless steel, polycarbonate end bell, polyphenylene sulfide front cap	Stainless steel, polycarbonate end bell, polyphenylene sulfide front cap
Termination	Micro-connector, potted cable, 2m; Pigtail, micro-connector, 2m	Micro-connector, potted cable, 2m; Pigtail, micro-connector, 2m	Micro-connector, potted cable, 2m; Pigtail, micro-connector, 2m	Micro-connector, potted cable, 2m; Pigtail, micro-connector, 2m	Micro-connector, potted cable, 2m; Pigtail, micro-connector, 2m	Micro-connector, potted cable, 2m; Pigtail, micro-connector, 2m

Notes

- ① Published range data is based on a 1 mm thick square target made of Type FE 360 steel per ISO Standard 630.
- ② The sensor achieves its maximum repeat accuracy after warming up for a period of at least one hour.
- ③ Voltage outputs available on models ending in **-CV**.
- ④ Continuous short-circuits can exceed power dissipation ratings and cause eventual destruction.

AccuProx Analog Performance Graphs

Linear Output

12 mm

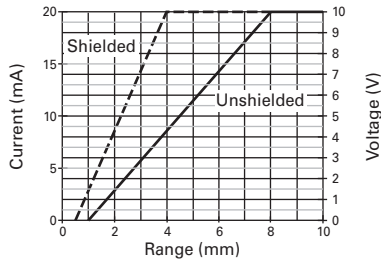

18 mm

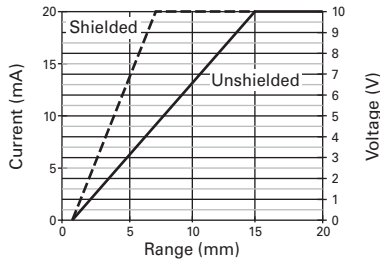

30 mm

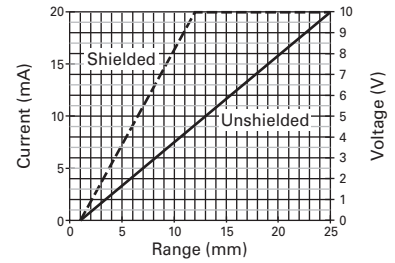

Measurement Resolution ①

12 mm

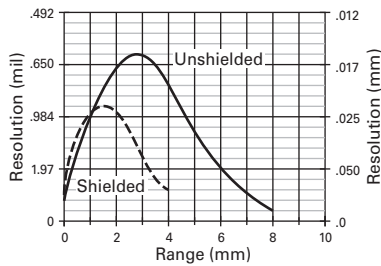

18 mm

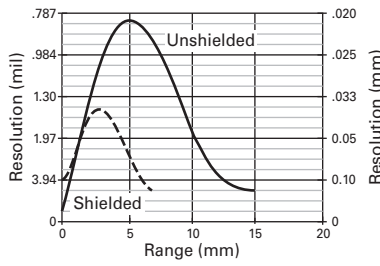

30 mm

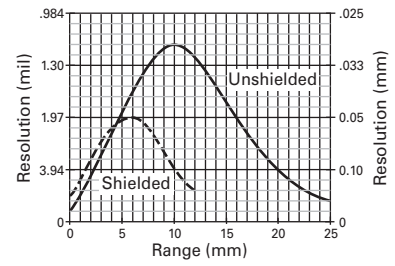

Output Resolution ②

12 mm

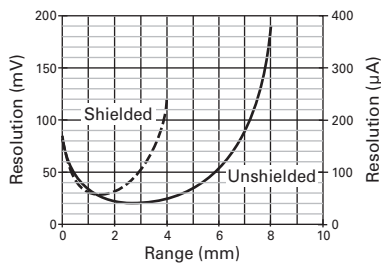

18 mm

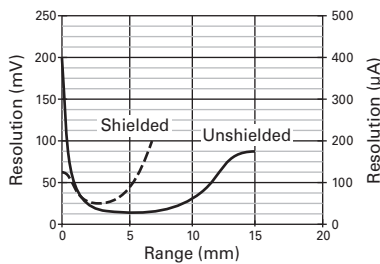

30 mm

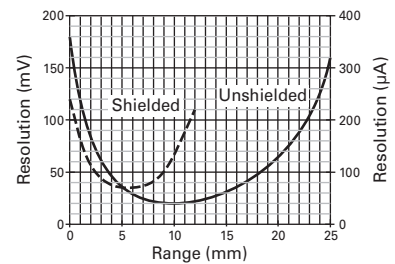

Notes

- ① Measurement resolution is the sensor's ability to detect a change in target position. The measurement resolution is the finest at the highest point in the curve.
- ② Output resolution is the change in output signal relative to target position. The minimum change in output resolution is defined by the lowest point in the curve.

3.6

Inductive Proximity Sensors

AccuProx Analog Sensors

Wiring Diagrams

Pin numbers are for reference, rely on pin location when wiring.

AccuProx Analog Sensors

3

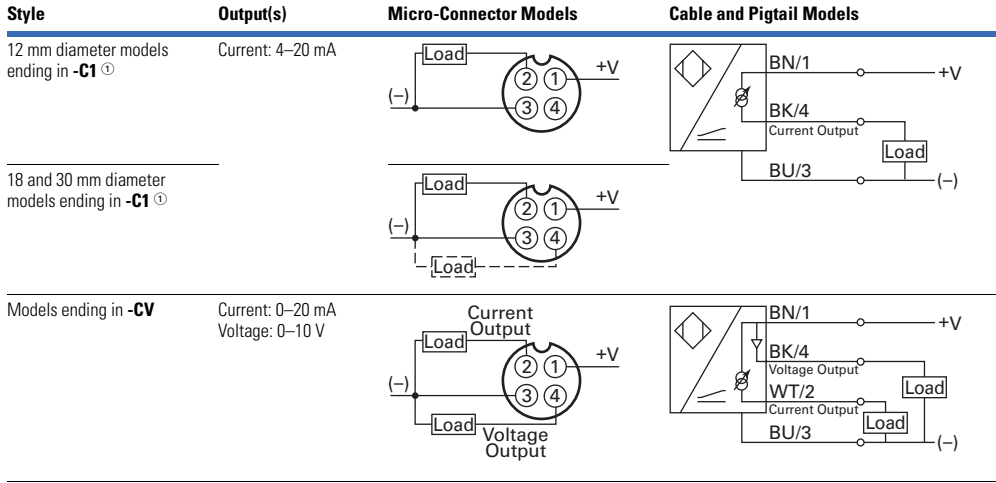

Dimensions

Approximate Dimensions in Inches (mm)

Micro-Connector Models

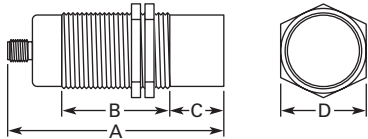

Size	Shielding	A	B	C	D
12 mm	Shielded	3.05 (77.5)	1.98 (50.3)	0.02 (0.50)	0.67 (17)
	Unshielded	3.05 (77.5)	1.64 (41.6)	0.36 (9)	0.67 (17)
18 mm	Shielded	2.73 (69.3)	2.00 (50.9)	0.02 (0.50)	0.94 (24)
	Unshielded	2.73 (69.3)	1.47 (37.4)	0.55 (14)	0.94 (24)
30 mm	Shielded	2.92 (74.1)	2.13 (54.1)	0.03 (0.75)	1.41 (36)
	Unshielded	2.92 (74.1)	1.41 (35.8)	0.75 (19)	1.41 (36)

Cable and Pigtail Models

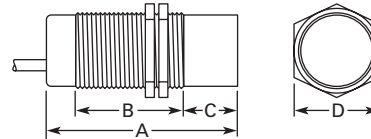

Size	Shielding	A	B	C	D
12 mm	Shielded	2.46 (62.4)	1.98 (50.3)	0.02 (0.5)	0.67 (17)
	Unshielded	2.46 (62.4)	1.64 (41.6)	0.36 (9)	0.67 (17)
18 mm	Shielded	2.54 (64.5)	2.00 (50.9)	0.02 (0.5)	0.94 (24)
	Unshielded	2.54 (64.5)	1.47 (37.4)	0.55 (14)	0.94 (24)
30 mm	Shielded	2.74 (69.6)	2.13 (54.1)	0.03 (0.75)	1.41 (36)
	Unshielded	2.74 (69.6)	1.41 (35.8)	0.75 (19)	1.41 (36)

Note

- ① For models ending in **-C1** (current output only models), pins 2 and 4 are intentionally connected.
Do not connect outputs of **-C1** models to separate loads—this sensor should only be connected to a single-output load.

Ferrous Only Tubular Sensors



Contents

Description

Ferrous Only Tubular Sensors

Product Selection

Ferrous Only Tubular Sensors

Compatible Connector Cables

Accessories

Technical Data and Specifications

Wiring Diagrams

Dimensions

Page

V8-T3-56

V8-T3-56

V8-T3-56

V8-T3-57

V8-T3-57

V8-T3-57

3

Ferrous Only Tubular Sensors

Product Description

These unique Inductive Proximity Sensors have been specially made by Eaton's Electrical Sector to detect only a specific type of metal. Ferrous Only models will detect only ferrous metals such as steel, iron, nickel or cobalt.

A typical application for **Ferrous Only** sensors would be in workcell applications where cutting tools, tool pallets and fixtures must be detected for proper workpiece manipulation. The sensors detect ferrous objects while ignoring aluminum.

These sensors are available in a standard 18 mm diameter, and are epoxy filled for shock/vibration resistance and heat tolerance.

Features

- Ferrous Only sensors detect ferrous metals, such as steel or iron, while ignoring non-ferrous metals
- Selection of two-wire and three-wire, AC/DC and DC-only sensor models
- Wide operating temperature range: -13 to 158 °F (-25 to 70 °C)

DANGER

THIS SENSOR IS NOT A SAFETY DEVICE AND IS NOT INTENDED TO BE USED AS A SAFETY DEVICE. This sensor is designed only to detect and read certain data in an electronic manner and perform no use apart from that, specifically no safety-related use. This sensor product does not include self-checking redundant circuitry, and the failure of this sensor product could cause either an energized or de-energized output condition, which could result in death, serious bodily injury, or property damage.

For the most current information on this product, visit our Web site: www.eaton.com

For Customer Service in the U.S. call 1-877-ETN CARE (386-2273), in Canada call 1-800-268-3578. For Application Assistance in the U.S. and Canada call 1-800-426-9184.

Product Selection

Ferrous Only Tubular Sensors

3

Two-Wire Sensors

Operating Voltage	Sensing Range (Sn)	Shielding	Connection Type	NO Output Catalog Number
18 mm Diameter				
20–250 Vac/dc 50/60 Hz	5.0 mm	Shielded	3-pin micro AC connector	E57FAL18A2SA ☼
			3-pin mini-connector	E57FAL18A2B1 ☼





Three-Wire Sensors

Operating Voltage	Sensing Range (Sn)	Shielding	Connection Type	NO Output Catalog Number
18 mm Diameter				
10–30 Vdc	5.0 mm	Shielded (PNP)	4-pin micro DC connector	E57FAL18T111SD ☼



Compatible Connector Cables

Standard Cables ①

Current Rating at 600 V	Voltage Style	Number of Pins	Gauge	Length	Pin Configuration/Wire Colors (Face View Female Shown)	PVC Jacket Catalog Number	PUR Jacket Catalog Number
Micro-Style, Straight Female							
—	AC	3-pin, 3-wire	22 AWG	6.0 ft (2m)	 1-Green 2-Red/Black 3-Red/White	CSAS3F3CY2202	CSAS3F3RY2202
	DC	4-pin, 3-wire	22 AWG	6.0 ft (2m)	 1-Brown 2-No Wire 3-Blue 4-Black	CSDS4A3CY2202	CSDS4A3RY2202
Mini-Style, Straight Female							
13 A	—	3-pin	16 AWG	6.0 ft (2m)	 1-Green 2-Black 3-White	CSMS3F3CY1602	



Accessories

Ferrous Only Tubular Sensors

Description	Reference
Mounting brackets	See Tab 8, section 8.2
Replacement mounting nuts and other accessories	See Tab 8, section 8.3
Connector cables	See Tab 10, section 10.1

Notes

☼☼ See listing of compatible connector cables above.

① For a full selection of connector cables, see **Tab 10, section 10.1**.

Technical Data and Specifications

Ferrous Only Tubular Sensors

Description	Two-Wire AC/DC Sensors	Three-Wire DC Sensors
Operating voltage	20–250 Vac/dc	10–30 Vdc
Maximum load current	100 mA	100 mA
Switching frequency	15 Hz	1000 Hz
Leakage current	2.5 mA maximum	<0.01 mA
Voltage drop	10 V maximum	1.5 V maximum
Holding current	5 mA minimum	—
Burden current	—	17 mA
Protection	Transient, power on false pulse suppression	Short-circuit protection
Switching hysteresis	<15% rated sensing distance	<15% rated sensing distance
Repeat accuracy	<1% sensing distance	<1% sensing distance
Time delay before availability	<10 ms	<10 ms
Output indicator LED	Lights when output is ON	Lights when output is ON
Operating temperature	–13 to 131 °F (–25 to 55 °C)	–13 to 131 °F (–25 to 55 °C)
Enclosure ratings	NEMA 4, 4X, 6, 6P, 12 and 13 (IP67)	NEMA 4, 4X, 6, 6P, 12 and 13 (IP67)
Shock	30 g sine wave, 11 ms per IEC68-2-76	30 g sine wave, 11 ms per IEC68-2-76
Vibration	10 to 55 Hz, 1 mm amplitude in all three planes	10 to 55 Hz, 1 mm amplitude in all three planes
Housing material	Stainless steel	Stainless steel

Wiring Diagrams

Pin numbers are for reference, rely on pin location when wiring.

Ferrous Only Tubular Sensors

Operating Voltage	Output	Connector Models (Face View Male Shown)	
		Micro	Mini
Two-Wire Sensors			
20–250 Vac/dc 50/60 Hz	NO		
Three-Wire Sensors			
10–30 Vdc	NO (PNP)	—	

Dimensions

Approximate Dimensions in Inches (mm)

Ferrous Only Tubular Sensors

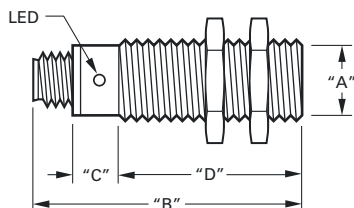

Connector Models

Catalog Number	A	B	C	D
Two-Wire Models				
E57FAL18A2SA	M18 x 1	3.11 (79)	1.38 (35)	1.73 (44)
E57FAL18A2B1	M18 x 1	3.90 (99)	1.34 (34)	2.56 (65)
Three-Wire Models				
E57FAL18T111SD	M18 x 1	3.11 (79)	1.14 (29)	1.97 (50)

Metal Face Sensors

3



Metal Face Sensors

Product Description

Metal Face Inductive Proximity Sensors by Eaton's Electrical Sector incorporate tough stainless steel sensing faces in place of the plastic faces found in standard sensors. This provides a higher level of protection for more reliable operation and longer life in harsh environments.

The sensors stand up to abrasion and impact caused by flying metal chips, grit, and misaligned or vibrating targets. In addition, the stainless steel body resists corrosion and chemical attack.

Common sensor diameters, voltage styles and wiring connections make it easy to retrofit your existing, damaged sensors. Solve the problem of damaged sensors permanently with Eaton's Metal Face Sensors.

Features

- Two-wire AC/DC models and three-wire DC models are compatible with your existing wiring
- Common 12 mm, 18 mm and 30 mm housing diameters allow easy changeout of existing damaged sensors
- The 20 mil stainless steel sensing face is thicker than competing units for a higher level of protection
- The stainless steel body is damage and corrosion resistant
- Wide operating temperature range: -13 to 158 °F (-25 to 70 °C)

Contents

Description

	<i>Page</i>
Metal Face Sensors	
Product Selection	
Metal Face Sensors	V8-T3-59
Compatible Connector Cables	V8-T3-56
Accessories	V8-T3-60
Technical Data and Specifications	V8-T3-60
Wiring Diagrams	V8-T3-61
Dimensions	V8-T3-61

DANGER

THIS SENSOR IS NOT A SAFETY DEVICE AND IS NOT INTENDED TO BE USED AS A SAFETY DEVICE. This sensor is designed only to detect and read certain data in an electronic manner and perform no use apart from that, specifically no safety-related use. This sensor product does not include self-checking redundant circuitry, and the failure of this sensor product could cause either an energized or de-energized output condition, which could result in death, serious bodily injury, or property damage.



For the most current information on this product, visit our Web site: www.eaton.com

For Customer Service in the U.S. call 1-877-ETN CARE (386-2273), in Canada call 1-800-268-3578. For Application Assistance in the U.S. and Canada call 1-800-426-9184.



Product Selection

Metal Face Sensors

Two-Wire Sensors



	Operating Voltage	Sensing Range (Sn)	Shielding	Connection Type	NO Output Catalog Number
12 mm	12 mm Diameter				
	20–250 Vac/dc 50/60 Hz	2 mm	Shielded	3-pin micro AC connector	E57FAL12A2SA-M ⓘ
30 mm	30 mm Diameter				
	20–250 Vac/dc 50/60 Hz	10 mm	Shielded	3-pin micro AC connector	E57FAL30A2SA-M ⓘ

Three-Wire Sensors

	Operating Voltage	Sensing Range (Sn)	Shielding	Connection Type	NO Output Catalog Number
12 mm	12 mm Diameter				
	10–30 Vdc	2 mm	Shielded (PNP)	4-pin micro DC connector	E57FAL12T111SD-M ⓘ
18 mm	18 mm Diameter				
	10–30 Vdc	5 mm	Shielded (PNP)	4-pin micro DC connector	E57FAL18T111SD-M ⓘ

Compatible Connector Cables

Standard Cables ⓘ

	Voltage Style	Number of Pins	Gauge	Length	Pin Configuration/Wire Colors (Face View Female Shown)	PVC Jacket Catalog Number	PUR Jacket Catalog Number
	Micro-Style, Straight Female						
	AC	3-pin, 3-wire	22 AWG	6.0 ft (2m)	 1-Green 2-Red/Black 3-Red/White	CSAS3F3CY2202	CSAS3F3RY2202
	DC	4-pin, 4-wire	22 AWG	6.0 ft (2m)	 1-Brown 2-White 3-Blue 4-Black	CSDS4A4CY2202	CSDS4A4RY2202

Notes

ⓘ See listing of compatible connector cables above.

Ⓜ For a full selection of connector cables, see **Tab 10, section 10.1**.

Accessories

Metal Face Sensors

Description	Reference
Mounting brackets	See Tab 8, section 8.2
Replacement mounting nuts and other accessories	See Tab 8, section 8.3
Connector cables	See Tab 10, section 10.1

Technical Data and Specifications

Metal Face Sensors

Description	Two-Wire AC/DC Sensors	Three-Wire DC Only Sensors
Operating voltage	20–250 Vac/dc	10–30 Vdc
Maximum load current	100 mA	100 mA
Switching frequency		
12 mm	15 Hz	2000 Hz
18 mm	—	1000 Hz
30 mm	—	300 Hz
Leakage current	2.5 mA maximum	600 µA maximum
Voltage drop	10 V maximum	1.5 V maximum
Holding current	5 mA minimum	—
Burden current	—	17 mA
Protection	Transient, power on false pulse suppression	Short-circuit protection
Switching hysteresis	<15% rated sensing distance	<15% rated sensing distance
Repeat accuracy	<1% sensing distance	<1% sensing distance
Time delay before availability	<200 ms	<200 ms
Output indicator LED	Lights when output is ON	Lights when output is ON
Operating temperature	–13 to 131 °F (–25 to 55 °C)	–13 to 131 °F (–25 to 55 °C)
Enclosure ratings	NEMA 4, 4X, 6, 6P, 12 and 13 (IP67)	NEMA 4, 4X, 6, 6P, 12 and 13 (IP67)
Shock	30 g sine wave, 11 ms per IEC68-2-76	30 g sine wave, 11 ms per IEC68-2-76
Vibration	10 to 55 Hz, 1 mm amplitude in all three planes	10 to 55 Hz, 1 mm amplitude in all three planes
Housing material	303 stainless steel	303 stainless steel
Face thickness	20 mils	20 mils

Wiring Diagrams

Pin numbers are for reference, rely on pin location when wiring.

Metal Face Sensors

Operating Voltage	Output	Micro-Connector Models (Face View Male Shown)
Two-Wire Sensors		
20–250 Vac/dc 50/60 Hz	NO	
Three-Wire Sensors		
10–30 Vdc	NO (NPN)	
	NO (PNP)	

Dimensions

Approximate Dimensions in Inches (mm)

Metal Face Sensors

Connector Models

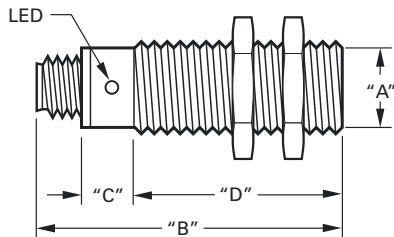

Catalog Number	A	B	C	D
Two-Wire Models				
E57FAL12A2SA-M	M x 12	2.67 (68)	1.10 (28)	1.58 (40)
E57FAL30A2SA-M	M x 30	3.70 (94)	1.34 (34)	2.36 (60)
Three-Wire Models				
E57FAL12T111SD-M	M x 12	2.67 (68)	1.02 (26)	1.65 (42)
E57FAL18T110SD-M	M x 18	3.11 (79)	1.14 (29)	1.97 (50)
E57FAL18T111SD-M	M x 18	3.11 (79)	1.14 (29)	1.97 (50)

High Current Output Sensors

3



Contents

Description

Page

High Current Output Sensors	
Product Selection	V8-T3-63
Accessories	V8-T3-63
Technical Data and Specifications	V8-T3-64
Wiring Diagrams	V8-T3-64
Dimensions	V8-T3-64

High Current Output Sensors

Product Description

Now there is an alternative to limit switches for position sensing on industrial vehicles. High Current Output Sensors feature a continuous output current rating from 2 to 8 A. These sensors from Eaton's Electrical Sector are ideally suited to handle high current loads found on such industrial vehicles as aerial lift trucks, fork lifts, refuse trucks, cement mixers, dump trucks, hook and ladder trucks, front end loaders, farm equipment and hundreds of other vehicles that are constantly subjected to mechanical (shock, vibration, collisions) and environmental (dirt, grease, ice, rain) abuse that create havoc with mechanical devices.

Features

- Solid-state output can handle up to 8 A continuous
- Ideal for vehicle use to replace mechanical limit switches, typically required to handle high currents
- Wide voltage and temperature range covers most vehicle power supplies and operating environments
- Normally Open and Normally Closed isolated outputs
- SJO cable is available in custom lengths
- Dual colored 360° LED indicating light, green as power ON and red as output

DANGER

THIS SENSOR IS NOT A SAFETY DEVICE AND IS NOT INTENDED TO BE USED AS A SAFETY DEVICE. This sensor is designed only to detect and read certain data in an electronic manner and perform no use apart from that, specifically no safety-related use. This sensor product does not include self-checking redundant circuitry, and the failure of this sensor product could cause either an energized or de-energized output condition, which could result in death, serious bodily injury, or property damage.

For the most current information on this product, visit our Web site: www.eaton.com

For Customer Service in the U.S. call 1-877-ETN CARE (386-2273), in Canada call 1-800-268-3578. For Application Assistance in the U.S. and Canada call 1-800-426-9184.

Product Selection

High Current Output Sensors

30 mm



Four-Wire Sensors

Operating Voltage	Sensing Range	Shielding	Output Type	Output Rating		Connection Type ^①	Catalog Number
				Continuous	<100 ms Pulse		
30 mm Diameter							
10–55 Vdc	10 mm	Shielded	NO and NC (PNP)	3.5 A	20 A	2-meter cable	E57-30JS10-H

30 mm



Six-Wire Sensors ^②

Operating Voltage	Sensing Range	Shielding	Output Type	Output Rating		Connection Type ^①	Catalog Number
				Continuous	<100 ms Pulse		
30 mm Diameter							
10–30 Vdc	10 mm	Shielded	NO and NO, or NC and NC (NPN or PNP)	8 A	50 A	2-meter cable	E57-30HS10-K

Accessories

High Current Output Sensors

Description	Reference
Mounting brackets	See Tab 8, section 8.2
Replacement mounting nuts and other accessories	See Tab 8, section 8.3

Notes

- ① For additional cable length other than 2-meter, add desired length in meters to listed catalog number.
Example: For an E57-30JS10-H with a 5-meter cable, order E57-30JS10-H5.
- ② 50 Amp surge, 12 Amp at 50% duty cycle and 8 Amp continuous.

Technical Data and Specifications

High Current Output Sensors

3

Description	Four-Wire Sensors	Six-Wire Sensors
Operating voltage	10 to 55 Vdc	10 to 30 Vdc
Switching rate	250 Hz	100 Hz
Off-state current	100 A μ maximum	100 A μ maximum
Voltage drop	1.2 V	2.0 V
Burden current	10 mA at 55 volts	30 mA at 30 volts
Time delay before availability	<100 ms	<100 ms
Output indicator LED	360° visibility	360° visibility
Output type	Solid-state	Solid-state, isolated
Protection	Transient and power on false pulse	Transient and power on false pulse
Enclosure ratings	NEMA 4, 4X, 6, 6P, 12 and 13 (IEC IP67)	NEMA 4, 4X, 6, 6P, 12 and 13 (IEC IP67)
Ambient temperature range	-40 to 158 °F (-40 to 70 °C)	-40 to 158 °F (-40 to 70 °C)
Barrel material	303 stainless steel	303 stainless steel
Cable	2m standard SJO water resistive (18 AWG)	2m standard SJO water resistive (18 AWG)
Shock	30 g sine wave, 11 ms	30 g sine wave, 11 ms
Vibration	10 to 55 Hz, 2 mm amplitude in all 3 planes	10 to 55 Hz, 2 mm amplitude in all 3 planes

Wiring Diagrams

Four-Wire—PNP

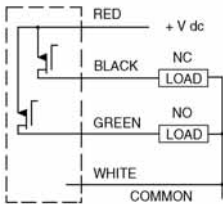

Six-Wire—NO/NO Output Configuration

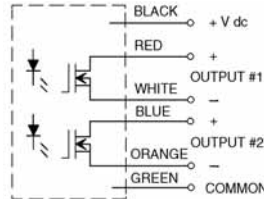

Six-Wire—NC/NC Output Configuration

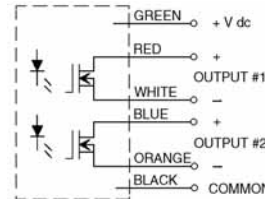

Dimensions

Approximate Dimensions in Inches (mm)

High Current Output Sensors

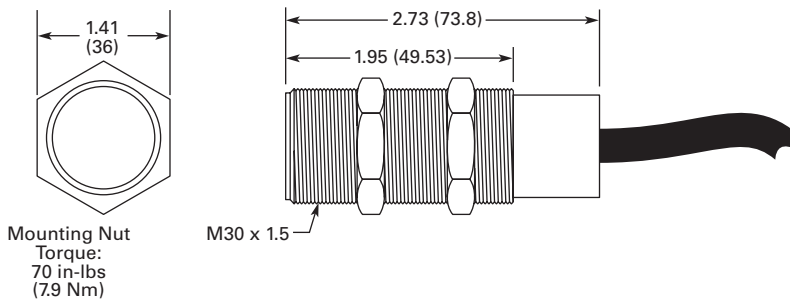

Small Diameter (4, 5, 6.5, 8 mm) Sensors



Contents

Description

Description	Page
Small Diameter (4, 5, 6.5, 8 mm) Sensors	
Product Selection	
Small Diameter (4, 5, 6.5, 8 mm) Sensors	V8-T3-66
Compatible Connector Cables	V8-T3-68
Accessories	V8-T3-56
Technical Data and Specifications	V8-T3-69
Wiring Diagrams	V8-T3-69
Dimensions	V8-T3-70

Small Diameter (4, 5, 6.5, 8 mm) Sensors

Product Description

These unique Inductive Proximity Sensors by Eaton's Electrical Sector are designed to be used in extremely small spaces. A wide variety of models are available with housing diameters from 8 mm all the way down to 4 mm, allowing you to choose the one that best fits your application. The sensors are three-wire devices that operate from 10 to 30 Vdc. Both shielded and unshielded versions are available.

Application Description

Typical Applications

- Automation equipment
- Robotics
- Machine tool
- Counting
- Sorting

Features

- Small 4, 5, 6.5 and 8 mm diameters for use in applications with limited space for mounting sensors
- Stainless steel housings
- All models include an LED indicator to show output status
- Short circuit and reverse polarity protection
- Rated NEMA 4, 4X, 6, 6P, 12 and 13 (IP67) for high resistance to environmental factors

Standards and Certifications

- cCSAus (8 mm only)
- CE



⚠ DANGER

THIS SENSOR IS NOT A SAFETY DEVICE AND IS NOT INTENDED TO BE USED AS A SAFETY DEVICE. This sensor is designed only to detect and read certain data in an electronic manner and perform no use apart from that, specifically no safety-related use. This sensor product does not include self-checking redundant circuitry, and the failure of this sensor product could cause either an energized or de-energized output condition, which could result in death, serious bodily injury, or property damage.

For the most current information on this product, visit our Web site: www.eaton.com

For Customer Service in the U.S. call 1-877-ETN CARE (386-2273), in Canada call 1-800-268-3578.
For Application Assistance in the U.S. and Canada call 1-800-426-9184.

3.10

Inductive Proximity Sensors





Small Diameter (4, 5, 6.5, 8 mm) Sensors

Product Selection

Small Diameter (4, 5, 6.5, 8 mm) Sensors

3

Three-Wire Sensors

	Operating Voltage	Sensing Range (Sn)	Shielding	Connection Type	NO Output Catalog Number	NC Output Catalog Number
	4 mm Diameter (Unthreaded)					
	10–30 Vdc	0.8 mm	Shielded (NPN)	2-meter cable	E57EAL4T110SP	—
				3-pin nano-connector	E57EAL4T110SN ☺	—
			Shielded (PNP)	2-meter cable	E57EAL4T111SP	—
				3-pin nano-connector	E57EAL4T111SN ☺	—
	5 mm Diameter					
	10–30 Vdc	0.8 mm	Shielded (NPN)	2-meter cable	E57EAL5T110SP	—
				3-pin nano-connector	E57EAL5T110SN ☺	—
			Shielded (PNP)	2-meter cable	E57EAL5T111SP	—
				3-pin nano-connector	E57EAL5T111SN ☺	—
6.5 mm Diameter (Unthreaded)						
	10–30 Vdc	1 mm	Shielded (NPN)	2-meter cable	E57EAL6T110SP	—
				3-pin nano-connector	E57EAL6T110SN ☺	—
				4-pin micro DC connector	E57EAL6T110SD ☺	—
			Shielded (PNP)	2-meter cable	E57EAL6T111SP	—
				3-pin nano-connector	E57EAL6T111SN ☺	—
				4-pin micro DC connector	E57EAL6T111SD ☺	—
	2 mm	Unshielded (NPN)	2-meter cable	E57EAL6T110EP	—	
			3-pin nano-connector	E57EAL6T110EN ☺	—	
			2-meter cable	E57EAL6T111EP	—	
			3-pin nano-connector	E57EAL6T111EN ☺	—	
8 mm Diameter Short Body						
	10–30 Vdc	1 mm	Shielded (NPN)	2-meter cable	E57EAL8T110SP	E57EBL8T110SP
				3-pin nano-connector	E57EAL8T110SN ☺	E57EBL8T110SN ☺
				4-pin micro DC connector	E57EAL8T110SD ☺	E57EBL8T110SD ☺
			Shielded (PNP)	2-meter cable	E57EAL8T111SP	E57EBL8T111SP
				3-pin nano-connector	E57EAL8T111SN ☺	E57EBL8T111SN ☺
				4-pin micro DC connector	E57EAL8T111SD ☺	E57EBL8T111SD ☺
		2 mm	Unshielded (NPN)	2-meter cable	E57EAL8T110EP	E57EBL8T110EP
				3-pin nano-connector	E57EAL8T110EN ☺	E57EBL8T110EN ☺
				4-pin micro DC connector	E57EAL8T110ED ☺	E57EBL8T110ED ☺
			Unshielded (PNP)	2-meter cable	E57EAL8T111EP	E57EBL8T111EP
				3-pin nano-connector	E57EAL8T111EN ☺	E57EBL8T111EN ☺
				4-pin micro DC connector	E57EAL8T111ED ☺	E57EBL8T111ED ☺

Note

☺☺ See listing of compatible connector cables on [Page V8-T3-68](#).

Three-Wire Sensors, continued

Operating Voltage	Sensing Range	Shielding	Output Type	Connection Type	NO Output Catalog Number	NC Output Catalog Number			
8 mm Standard Length	8 mm Diameter Standard Length								
	10–30 Vdc	1 mm	Shielded	NPN	2-meter cable	E57-08GS01-C	E57-08GS01-C1		
					3-pin nano-connector	E57-08GS01-CNB ☺	E57-08GS01-C1NB ☺		
					4-pin micro DC connector	E57-08GS01-CDB ☺	E57-08GS01-C1DB ☺		
		3 mm (extended range)	NPN	Shielded	NPN	2-meter cable	E57-08GE03-C	E57-08GE03-C1	
						3-pin nano-connector	E57-08GE03-CNB ☺	E57-08GE03-C1NB ☺	
						4-pin micro DC connector	E57-08GE03-CDB ☺	E57-08GE03-C1DB ☺	
			PNP	Shielded	PNP	2-meter cable	E57-08GS01-G	E57-08GS01-G1	
						3-pin nano-connector	E57-08GS01-GNB ☺	E57-08GS01-G1NB ☺	
						4-pin micro DC connector	E57-08GS01-GDB ☺	E57-08GS01-G1DB ☺	
	Unshielded			PNP	PNP	2-meter cable	E57-08GE03-G	E57-08GE03-G1	
						3-pin nano-connector	E57-08GE03-GNB ☺	E57-08GE03-G1NB ☺	
						4-pin micro DC connector	E57-08GE03-GDB ☺	E57-08GE03-G1DB ☺	
	2 mm	Unshielded	NPN	NPN	2-meter cable	E57-08GU02-C	E57-08GU02-C1		
					3-pin nano-connector	E57-08GU02-CNB ☺	E57-08GU02-C1NB ☺		
					4-pin micro DC connector	E57-08GU02-CDB ☺	E57-08GU02-C1DB ☺		
		PNP	Unshielded	PNP	2-meter cable	E57-08GU02-G	E57-08GU02-G1		
					3-pin nano-connector	E57-08GU02-GNB ☺	E57-08GU02-G1NB ☺		
					4-pin micro DC connector	E57-08GU02-GDB ☺	E57-08GU02-G1DB ☺		
			6 mm (extended range)	Unshielded	NPN	NPN	2-meter cable	E57-08GE06-C	E57-08GE06-C1
							4-pin micro DC connector	E57-08GE06-CDB ☺	E57-08GE06-C1DB ☺
							PNP	2-meter cable	E57-08GE06-G
	4-pin micro DC connector	E57-08GE06-GDB ☺	E57-08GE06-G1DB ☺						

Note

☺☺ See listing of compatible connector cables on **Page V8-T3-31**.



3.10



Inductive Proximity Sensors

Small Diameter (4, 5, 6.5, 8 mm) Sensors

Compatible Connector Cables

3

Standard Cables^①

Voltage Style	Number of Pins	Gauge	Length	Pin Configuration/Wire Colors (Face View Female Shown)	PVC Jacket Catalog Number	PUR Jacket Catalog Number
Micro-Style, Straight Female						
DC	4-pin, 3-wire	22 AWG	6.0 ft (2m)	 1-Brown 2-No Wire 3-Blue 4-Black	CSDS4A3CY2202	CSDS4A3RY2202
	4-pin, 4-wire	22 AWG	6.0 ft (2m)	 1-Brown 2-White 3-Blue 4-Black	CSDS4A4CY2202	CSDS4A4RY2202
Nano-Style, Straight Female						
—	3-pin	24 AWG	6.0 ft (2m)	 1-Brown 3-Blue 4-Black	CSNS3A3CY2402	CSNS3A3RY2402

Accessories

Small Diameter Sensors

Description	Reference
Mounting brackets	See Tab 8, section 8.2
Replacement mounting nuts and other accessories	See Tab 8, section 8.3
Connector cables	See Tab 10, section 10.1

Note

① For a full selection of connector cables, see **Tab 10, section 10.1**.

Technical Data and Specifications

Small Diameter Sensors

Description	Three-Wire DC Only Sensors
Operating voltage	10–30 Vdc
Maximum load current	200 mA
Switching frequency	2 kHz
Leakage current	0.01 mA maximum
Voltage drop	1.5 V maximum
Burden current	10 mA maximum
Protection	Transient, power on false pulse suppression, auto reset short circuit
Switching hysteresis	<15% rated sensing distance
Repeat accuracy	<1% sensing distance
Time delay before availability	<50 ms
Output indicator LED	Lights when output is ON
Operating temperature	–13 to 158 °F (–25 to 70 °C)
Enclosure ratings	NEMA 4, 4X, 6, 6P, 12 and 13 (IP67)
Housing material	Stainless steel
Cable	PVC high flex, oil/water resistant, 22 AWG

Wiring Diagrams

Pin numbers are for reference, rely on pin location when wiring.

Small Diameter Sensors

Operating Voltage	Output	Cable Models	Connector Models (Face View Male Shown)	
			Micro	Nano
Three-Wire Sensors				
10–30 Vdc	NO (NPN)			
	NO (PNP)			
	NC (NPN)			
	NC (PNP)			

3.10

Inductive Proximity Sensors

Small Diameter (4, 5, 6.5, 8 mm) Sensors

Dimensions

Approximate Dimensions in Inches (mm)

Cable Models

Unthreaded Barrel

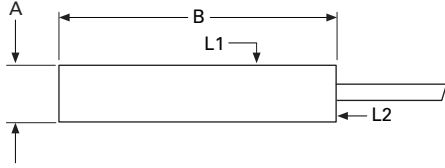

Threaded Barrel

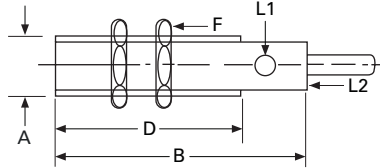

Size A [ⓐ]	Barrel Type	Length B	D	Thread Size	Nut Width F	Connector Diameter G	LED Location
Cable Models							
4 mm (S, Std)	Unthreaded	1.0 (25)	—	—	—	—	L1
5 mm (S, Std)	Threaded	1.0 (25)	0.8 (21)	M5 x 0.5	SW8	—	L1
6.5 mm (S/U, Std)	Unthreaded	1.8 (45)	—	—	—	—	L2
8 mm Short Body (S/U, Std)	Threaded	1.2 (30)	1.2 (30)	M8 x 1	SW13	—	L2
Standard Length							
8 mm (S, Std)	Threaded	1.77 (45)	1.77 (45)	M8 x 1	SW13	—	L2
8 mm (S, Ext)	Threaded	1.81 (46)	1.57 (40)	M8 x 1	SW13	—	L2
8 mm (U, Std)	Threaded	1.77 (45)	1.61 (41)	M8 x 1	SW13	—	L2
8 mm (U, Ext)	Threaded	1.77 (45)	1.61 (41)	M8 x 1	SW13	—	L2

Connector Models

Unthreaded Barrel

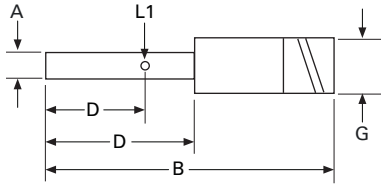

Threaded Barrel

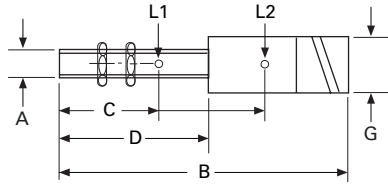

Standard Length 8 mm

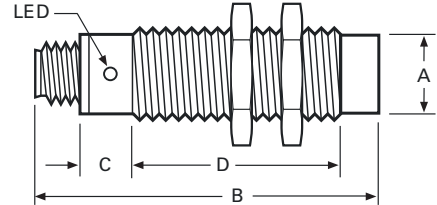

Size A [ⓐ]	Barrel Type	Length B	C	D	Thread Size	Nut Width F	Connector Diameter G	LED Location
Nano-Connector Models								
4 mm (S, Std)	Unthreaded	1.6 (40)	0.7 (18)	0.8 (21)	—	—	0.31 (8)	L1
5 mm (S, Std)	Threaded	1.6 (40)	0.7 (18)	0.8 (21)	M5 x 0.5	SW8	0.31 (8)	L1
6.5 mm (S/U, Std)	Unthreaded	2.4 (60)	1.5 (39)	2.0 (50)	—	—	0.31 (8)	L1
8 mm Short Body (S/U, Std)	Threaded	1.8 (45)	1.0 (25)	1.4 (36)	M8 x 1	SW13	0.31 (8)	L1
Standard Length								
8 mm (S, Std)	Threaded	2.36 (60)	0.79 (20)	1.57 (40)	M8 x 1	SW13	0.31 (8)	L2
8 mm (S, Ext)	Threaded	2.40 (61)	0.75 (19)	1.65 (42)	M8 x 1	SW13	0.31 (8)	L2
8 mm (U, Std)	Threaded	2.36 (60)	0.79 (20)	1.42 (36)	M8 x 1	SW13	0.31 (8)	L2
Micro-Connector Models								
6.5 mm (S/U, Std)	Unthreaded	2.9 (70)	1.4 (36)	1.5 (39)	—	—	0.47 (12)	L1
8 mm Short Body (S/U, Std)	Threaded	2.0 (50)	1.6 (40)	1.0 (25)	M8 x 1	SW13	0.47 (12)	L2
Standard Length								
8 mm (S, Std)	Threaded	2.76 (70)	0.83 (21)	1.93 (49)	M8 x 1	SW13	0.47 (12)	L2
8 mm (S, Ext)	Threaded	2.80 (71)	1.02 (26)	1.42 (36)	M8 x 1	SW13	0.47 (12)	L2
8 mm (U, Std)	Threaded	2.76 (70)	0.83 (21)	1.77 (45)	M8 x 1	SW13	0.47 (12)	L2
8 mm (U, Ext)	Threaded	2.76 (70)	1.22 (31)	1.38 (35)	M8 x 1	SW13	0.47 (12)	L2

Note

[ⓐ] U = Unshielded (4 mm cap), S = Shielded; Std = Standard Range, Ext = Extended Range.

E56 Pancake Sensors



E56 Pancake Sensors

Product Description

The E56 Pancake Sensor from Eaton's Electrical Sector is a high performance inductive proximity sensor. The E56 Pancake provides greater sensing ranges than other inductive sensor package types.

The E56 Pancake family provides convenience and ease of wiring with auto-configurable, complementary outputs. (Auto-configurable outputs automatically detect an NPN or PNP output configuration and switch the sensor accordingly, without user intervention.) Power and output LEDs make troubleshooting much easier than conventional proximity sensors, which usually only feature output LEDs. These convenience features, combined with the performance of the E56 Pancake, make it an excellent inductive sensing solution for applications requiring an extremely rugged, long-range sensing solution.

Application Description

Typical Applications

- Heavy-duty trucks, cranes and machinery
- Steel mills
- Pipe and rod manufacturing
- Automotive manufacturing
- Amusement parks

Contents

Description

	<i>Page</i>
E56 Pancake Sensors	
Product Selection	
E56 Pancake Sensors	V8-T3-72
Compatible Connector Cables	V8-T3-73
Technical Data and Specifications	V8-T3-74
Wiring Diagrams	V8-T3-75
Dimensions	V8-T3-75

Features

- Longest inductive sensing ranges available (up to 100 mm)
- Three sizes to meet your application needs, with maximum ranges of 50, 70 or 100 mm
- Complementary outputs (1NO/1NC) on four-wire DC models
- Auto-configure output technology on four-wire DC models, which automatically detect how the sensor has been wired (NPN or PNP) and switch the sensor without user intervention
- Small diameter, two-wire AC models feature a selector switch inside the housing, enabling output contacts to be used as either NO or NC
- Robust design featuring vibration and impact-absorbing potting compound
- Ideal for extreme temperatures or high pressure washdown environments

Standards and Certifications

- CE



⚠ DANGER

THIS SENSOR IS NOT A SAFETY DEVICE AND IS NOT INTENDED TO BE USED AS A SAFETY DEVICE. This sensor is designed only to detect and read certain data in an electronic manner and perform no use apart from that, specifically no safety-related use. This sensor product does not include self-checking redundant circuitry, and the failure of this sensor product could cause either an energized or de-energized output condition, which could result in death, serious bodily injury, or property damage.

For the most current information on this product, visit our Web site: www.eaton.com

For Customer Service in the U.S. call 1-877-ETN CARE (386-2273), in Canada call 1-800-268-3578. For Application Assistance in the U.S. and Canada call 1-800-426-9184.

Product Selection

E56 Pancake Sensors

3

Pancake Style



Two-Wire Sensors

Voltage Type	Output Configuration	Output Contacts	Shielding	Sensing Range	Connector Style	Catalog Number
Pancake Style						
20–250 Vac 45/65 Hz	—	NO or NC	Unshielded	1.57 in (40 mm)	Screw terminals	E56CDL40A2
					3-pin mini-connector	E56CDL40A2B1 ☹️
		NO or NC	Unshielded	2 in (50 mm)	Screw terminals	E56CDL50A2E
					3-pin mini-connector	E56CDL50A2EB1 ☹️
90–260 Vac 45/65 Hz	—	NO	Unshielded	2.75 in (70 mm) ①	3-pin mini-connector	E56CAL70B1S1 ☹️
				3.94 in (100 mm) ①	3-pin mini-connector	E56CAL100B1S1 ☹️

DC Four-Wire Sensors

Small Diameter



Voltage Type	Output Configuration	Output Contacts	Shielding	Sensing Range	Connector Style	Catalog Number
Small Diameter (79 x 79 x 39 mm)						
10–42 Vdc	NPN/PNP autoconfigure ②	1 NO and 1 NC	Shielded	1.57 in (40 mm)	DC screw	E56ADL40SA
					DC 4-pin mini	E56ADL40SAE01 ☹️
					DC 4-pin micro	E56ADL40SAD01 ☹️
			Unshielded	1.57 in (40 mm)	DC screw	E56ADL40UA
					DC 4-pin mini	E56ADL40UAE01 ☹️
					DC 4-pin micro	E56ADL40UAD01 ☹️
Unshielded	2 in (50 mm)	DC screw	E56ADL50UA			
		DC 4-pin mini	E56ADL50UAE01 ☹️			
		DC 4-pin micro	E56ADL50UAD01 ☹️			

Medium Diameter



Medium Diameter (110 x 110 x 41 mm)						
10–42 Vdc	NPN/PNP autoconfigure ②	1 NO and 1 NC	Unshielded	2.75 in (70 mm)	DC 4-pin mini	E56BDL70UAE01 ☹️
					DC 4-pin micro	E56BDL70UAD01 ☹️

Large Diameter



Large Diameter (172 x 172 x 68 mm)						
10–42 Vdc	NPN/PNP autoconfigure ②	1 NO and 1 NC	Unshielded	3.94 in (100 mm)	DC 4-pin mini	E56CDL100UAE01 ☹️
					DC 4-pin micro	E56CDL100UAD01 ☹️

Notes













☹️ ☹️ See listing of compatible connector cables on **Page V8-T3-73**.

① Includes potentiometer for adjustment of sensing range.

② Autoconfigure technology allows the sensor to automatically adapt to NPN or PNP without user intervention.

Compatible Connector Cables

Standard Cables ^①

	Current Rating at 600 V	Voltage Style	Number of Pins	Gauge	Length	Pin Configuration/Wire Colors (Face View Female Shown)	PVC Jacket Catalog Number	PUR Jacket Catalog Number	
Micro-Style Straight Female 	Micro-Style, Straight Female								
	—	AC	3-pin, 3-wire	22 AWG	6.0 ft (2m) 16.4 ft (5m) 32.8 ft (10m)	 1-Green 2-Red/Black 3-Red/White	CSAS3F3CY2202	CSAS3F3RY2202	
	—	DC	4-pin, 4-wire	22 AWG	6.0 ft (2m) 16.4 ft (5m) 32.8 ft (10m)	 1-Brown 2-White 3-Blue 4-Black	CSDS4A4CY2202	CSDS4A4RY2202	
	—	DC	4-pin, 4-wire	22 AWG	6.0 ft (2m) 16.4 ft (5m) 32.8 ft (10m)	 1-Brown 2-White 3-Blue 4-Black	CSDS4A4CY2205	CSDS4A4RY2205	
	—	DC	4-pin, 4-wire	22 AWG	6.0 ft (2m) 16.4 ft (5m) 32.8 ft (10m)	 1-Brown 2-White 3-Blue 4-Black	CSDS4A4CY2210	CSDS4A4RY2210	
	—	DC	4-pin, 4-wire	22 AWG	6.0 ft (2m) 16.4 ft (5m) 32.8 ft (10m)	 1-Brown 2-White 3-Blue 4-Black	CSDS4A4CY2210	CSDS4A4RY2210	
Mini-Style Straight Female 	Mini-Style, Straight Female								
	13 A	—	3-pin, 3-wire	16 AWG	6.0 ft (2m) 13.1 ft (4m)	 1-Green 2-Black 3-White	CSMS3F3CY1602	—	
	13 A	—	3-pin, 3-wire	16 AWG	6.0 ft (2m) 13.1 ft (4m)	 1-Green 2-Black 3-White	CSMS3F3CY1604	—	
	10 A	AC/DC	4-pin, 4-wire	16 AWG	6.0 ft (2m) 13.1 ft (4m) 19.7 ft (6m)	 1-Black 2-Blue 3-Brown 4-White	CSMS4A4CY1602	—	
10 A	AC/DC	4-pin, 4-wire	16 AWG	6.0 ft (2m) 13.1 ft (4m) 19.7 ft (6m)	 1-Black 2-Blue 3-Brown 4-White	CSMS4A4CY1604	—		
10 A	AC/DC	4-pin, 4-wire	16 AWG	6.0 ft (2m) 13.1 ft (4m) 19.7 ft (6m)	 1-Black 2-Blue 3-Brown 4-White	CSMS4A4CY1606	—		

Note

^① For a full selection of connector cables, see **Tab 10, section 10.1**.

Technical Data and Specifications

Two-Wire

3

Description	AC Two-Wire		
	Small Diameter	Medium Diameter	Large Diameter
Operating voltage	20–250 Vac	20–250 Vac	20–250 Vac
Load current (maximum)	400 mA	400 mA	400 mA
Off-state leakage	At or above 32 °F (0 °C): <1.7 mA; below 32 °F (0 °C): 2.0 mA	At or above 32 °F (0 °C): <1.7 mA; below 32 °F (0 °C): 2.0 mA	At or above 32 °F (0 °C): <1.7 mA; below 32 °F (0 °C): 2.0 mA
Voltage drop	<10 V (5 V nominal)	<10 V (5 V nominal)	<10 V (5 V nominal)
Outputs	NO or NC (switch selectable)	NO or NC by model	NO or NC by model
Sensing range (maximum)	50 mm	70 mm	100 mm
Range adjustment	Not adjustable	Potentiometer adjustable down to 50% of rated maximum range	Potentiometer adjustable down to 50% of rated maximum range
Standard target size (mild steel)	150 mm	210 mm	300 mm
Frequency of operation	30 Hz	10 Hz	10 Hz
Repeatability	<3%	<3%	<3%
Hysteresis (maximum)	10–15%	10–15%	10–15%
Time delay before availability	300 ms	300 ms	300 ms
Circuit protection	Short-circuit protection with auto reset	Short-circuit protection with auto reset	Short-circuit protection with auto reset
Operating temperature	–13 to 158 °F (–25 to 70 °C) ^①	–13 to 158 °F (–25 to 70 °C) ^①	–13 to 158 °F (–25 to 70 °C) ^①
Temperature drift	±10%	±10%	±10%
Enclosure rating	NEMA 4, 4X, 6, 6P, 12 and 13 (IP67)	NEMA 4, 4X, 6, 6P, 12 and 13 (IP67)	NEMA 4, 4X, 6, 6P, 12 and 13 (IP67)
Indicator LEDs	Output status	Output status	Output status
Materials of construction	PPS housing	PPS housing; aluminum baseplate	PPS housing; aluminum baseplate

Four-Wire

Description	DC Four-Wire		
	Small Diameter	Medium Diameter	Large Diameter
Operating voltage	10–42 Vdc	10–42 Vdc	10–42 Vdc
Load current (maximum)	300 mA	300 mA	300 mA
Burden current	<25 mA	<25 mA	<25 mA
Off-state leakage	<150 µA per output	<150 µA per output	<150 µA per output
Voltage drop	<2.5 V	<2.5 V	<2.5 V
Outputs	1 NO/1 NC (complementary)	1 NO/1 NC (complementary)	1 NO/1 NC (complementary)
Sensing range (maximum)	50 mm	70 mm	100 mm
Range adjustment	Not adjustable	Potentiometer adjustable down to 50% of rated maximum range	Potentiometer adjustable down to 50% of rated maximum range
Standard target size (mild steel)	150 mm	210 mm	300 mm
Frequency of operation	70 Hz	40 Hz	30 Hz
Repeatability	<3%	<3%	<3%
Hysteresis (maximum)	10–15%	10–15%	10–15%
Time delay before availability	300 ms	300 ms	300 ms
Circuit protection	Short-circuit protection with auto reset	Short-circuit protection with auto reset	Short-circuit protection with auto reset
Operating temperature	–13 to 158 °F (–25 to 70 °C) ^①	–13 to 158 °F (–25 to 70 °C) ^①	–13 to 158 °F (–25 to 70 °C) ^①
Temperature drift	±10%	±10%	±10%
Enclosure rating	NEMA 4, 4X, 6, 6P, 12 and 13 (IP67)	NEMA 4, 4X, 6, 6P, 12 and 13 (IP67)	NEMA 4, 4X, 6, 6P, 12 and 13 (IP67)
Indicator LEDs	Green: power; Red: output status	Green: power; Red: output status	Green: power; Red: output status
Materials of construction	PPS housing	PPS housing; aluminum baseplate	PPS housing; aluminum baseplate

Note

^① Small diameter DC unshielded models are rated at –40 °F (–40 °C). All other models can be operated at –40 °F (–40 °C), but range drift will occur.

Wiring Diagrams

Pin numbers are for reference, rely on pin location when wiring.

E56 Pancake Sensors

Voltage Type

Micro-Connector Models

Mini-Connector Models

Screw Terminal Models

DC four-wire

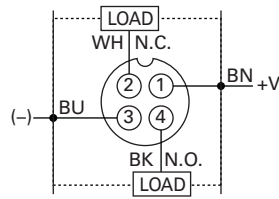

AutoConfigure enables load to be wired to +V or (-)

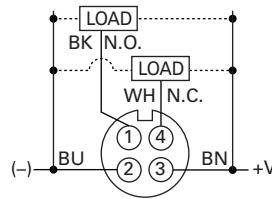

AutoConfigure enables load to be wired to +V or (-)

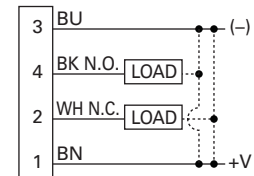

AutoConfigure enables load to be wired to +V or (-)

AC two-wire

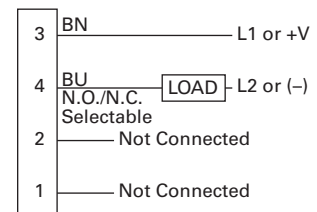
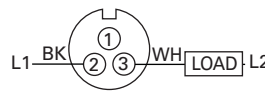
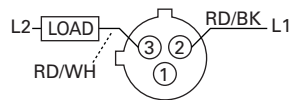

Dimensions

Approximate Dimensions in Inches (mm)

E56 Pancake Sensors

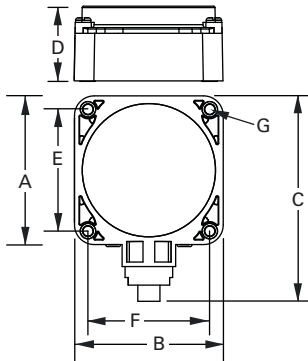

Model	A (Depth)	B (Width)	C (Depth)	D (Height)	E (Mounting)	F (Mounting)	G (Diameter)
Small Diameter Models							
Micro-connector	3.13 (79.0)	3.13 (79.0)	4.32 (110.0)	1.54 (39.0)	2.56 (65.0)	2.56 (65.0)	0.21 (5.0)
Mini-connector	3.13 (79.0)	3.13 (79.0)	4.67 (119.0)	1.54 (39.0)	2.56 (65.0)	2.56 (65.0)	0.21 (5.0)
Screw terminal	3.13 (79.0)	3.13 (79.0)	3.87 (92.0)	1.54 (39.0)	2.56 (65.0)	2.56 (65.0)	0.21 (5.0)
Medium Diameter Models							
Micro-connector	4.35 (110.0)	4.35 (110.0)	4.94 (125.4)	1.63 (41.0)	3.625 (92.0)	3.625 (92.0)	0.218 (5.5)
Mini-connector	4.35 (110.0)	4.35 (110.0)	5.29 (134.4)	1.63 (41.0)	3.625 (92.0)	3.625 (92.0)	0.218 (5.5)
Large Diameter Models							
Micro-connector	6.75 (171.5)	6.75 (171.5)	7.26 (184.4)	2.66 (67.5)	5.875 (149.0)	5.875 (149.0)	0.266 (7.0)
Mini-connector	6.75 (171.5)	6.75 (171.5)	7.61 (193.3)	2.66 (67.5)	5.875 (149.0)	5.875 (149.0)	0.266 (7.0)

Nonmetallic Tubular Sensors



3

Nonmetallic Tubular Sensors

Product Description

E55 Tubular Inductive Proximity Sensors by Eaton's Electrical Sector are constructed of corrosion resistant PBT plastic. They are ideally suited for wash down applications such as those found in food processing plants. They are available in 12 mm, 18 mm and 30 mm diameters, shielded or unshielded. Shielded units can be embedded in metallic surfaces.

Features

- Models available that operate on two-wire AC or three-wire DC power
- Threaded tubular housings in three diameters allow easy integration into new and existing applications
- Nonmetallic construction offers excellent resistance to corrosion
- Output indicator LED is standard on all models

Contents

Description

	<i>Page</i>
Nonmetallic Tubular Sensors	
Product Selection	V8-T3-77
Technical Data and Specifications	V8-T3-78
Wiring Diagrams	V8-T3-78
Dimensions	V8-T3-78

⚠ DANGER

THIS SENSOR IS NOT A SAFETY DEVICE AND IS NOT INTENDED TO BE USED AS A SAFETY DEVICE. This sensor is designed only to detect and read certain data in an electronic manner and perform no use apart from that, specifically no safety-related use. This sensor product does not include self-checking redundant circuitry, and the failure of this sensor product could cause either an energized or de-energized output condition, which could result in death, serious bodily injury, or property damage.



For the most current information on this product, visit our Web site: www.eaton.com

For Customer Service in the U.S. call 1-877-ETN CARE (386-2273),
in Canada call 1-800-268-3578.
For Application Assistance in the U.S. and Canada
call 1-800-426-9184.



Product Selection

Nonmetallic Tubular Sensors

Two-Wire Sensors ^①

	Operating Voltage	Sensing Range (Sn)	Shielding	Connection Type	NO Output Catalog Number	NC Output Catalog Number
12 mm 	12 mm Diameter					
	20–250 Vac 50/60 Hz	2 mm	Shielded	2-meter cable	E55CAL12A2	E55CBL12A2
4 mm		Unshielded	2-meter cable	E55CAL12A2E	E55CBL12A2E	
18 mm 	18 mm Diameter					
	20–250 Vac 50/60 Hz	5 mm	Shielded	2-meter cable	E55CAL18A2	E55CBL18A2
8 mm		Unshielded	2-meter cable	E55CAL18A2E	E55CBL18A2E	
30 mm 	30 mm Diameter					
	20–250 Vac 50/60 Hz	10 mm	Shielded	2-meter cable	E55CAL30A2	E55CBL30A2
15 mm		Unshielded	2-meter cable	E55CAL30A2E	E55CBL30A2E	

Three-Wire Sensors ^①

	Operating Voltage	Sensing Range (Sn)	Shielding	Connection Type	NO Output Catalog Number	NC Output Catalog Number
12 mm 	12 mm Diameter					
	10–30 Vdc	2 mm	Shielded (NPN)	2-meter cable	E55CAL12T110	E55CBL12T110
			Shielded (PNP)	2-meter cable	E55CAL12T111	E55CBL12T111
		4 mm	Unshielded (NPN)	2-meter cable	E55CAL12T110E	E55CBL12T110E
Unshielded (PNP)			2-meter cable	E55CAL12T111E	E55CBL12T111E	
18 mm 	18 mm Diameter					
	10–30 Vdc	5 mm	Shielded (NPN)	2-meter cable	E55CAL18T110	E55CBL18T110
			Shielded (PNP)	2-meter cable	E55CAL18T111	E55CBL18T111
		8 mm	Unshielded (NPN)	2-meter cable	E55CAL18T110E	E55CBL18T110E
Unshielded (PNP)			2-meter cable	E55CAL18T111E	E55CBL18T111E	
30 mm 	30 mm Diameter					
	10–30 Vdc	10 mm	Shielded (NPN)	2-meter cable	E55CAL30T110	E55CBL30T110
			Shielded (PNP)	2-meter cable	E55CAL30T111	E55CBL30T111
		15 mm	Unshielded (NPN)	2-meter cable	E55CAL30T110E	E55CBL30T110E
Unshielded (PNP)			2-meter cable	E55CAL30T111E	E55CBL30T111E	

Note

^① For a selection of mounting brackets and other accessories for use with these sensors, see **Tab 8, section 8.2**.

Technical Data and Specifications

Nonmetallic Tubular Sensors

3

Description	Two-Wire AC Models	Three-Wire DC Models
Operating voltage	20–250 Vac, 50/60 Hz	10–30 Vdc
Maximum load current	150 mA	200 mA
Switching frequency		
12 mm	25 Hz	2000 Hz (shielded); 1000 Hz (unshielded)
18 mm	25 Hz	1000 Hz (shielded); 500 Hz (unshielded)
30 mm	25 Hz	300 Hz (shielded); 150 Hz (unshielded)
Protection	—	Short circuit and reverse polarity
Temperature range	–13 to 158 °F (–25 to 70 °C)	–13 to 158 °F (–25 to 70 °C)
Enclosure material	Polybutylene Teraphtalate (PBT)	Polybutylene Teraphtalate (PBT)
Enclosure rating	NEMA 3, 3S, 4, 4X, 13 (IP66)	NEMA 3, 3S, 4, 4X, 13 (IP66)
Indicator LED	Lights when output is ON	Lights when output is ON

Wiring Diagrams

Nonmetallic Tubular Sensors

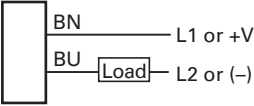
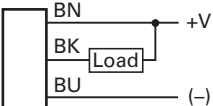
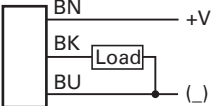
Operating Voltage	Output	Cable Models	Operating Voltage	Output	Cable Models
Two-Wire Sensors			Three-Wire Sensors		
20–250 Vac 50/60 Hz	All		10–30 Vdc	NPN	
				PNP	

Dimensions

Approximate Dimensions in Inches (mm)

12 and 18 mm

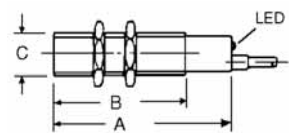

A	B	Thread Size C
12 mm		
2.17 (55)	1.77 (45)	M12 x 1
18 mm		
2.17 (55)	1.77 (45)	M18 x 1

30 mm

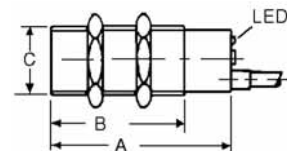

A	B	Thread Size C
30 mm		
3.15 (80)	2.36 (60)	M30 x 1.5

E52 Cube Style Sensors



Contents

<i>Description</i>	<i>Page</i>
E52 Cube Style Sensors	
Product Selection	
E52 Cube Style Sensors	V8-T3-80
Compatible Connector Cables	V8-T3-80
Technical Data and Specifications	V8-T3-81
Wiring Diagrams	V8-T3-81
Dimensions	V8-T3-82

E52 Cube Style Sensors

Product Description

The E52 Cube Sensor from Eaton's Electrical Sector is a high performance inductive proximity sensor, providing long sensing ranges in a compact, industry-standard package.

The E52 Cube family features Eaton's Autoconfigure output technology, which automatically detects NPN or PNP wiring states and switches the sensor accordingly, without user intervention. The E52 also utilizes complementary outputs to further reduce the number of models needed to cover a wide array of inductive sensing applications. Individual power and output LEDs make installation and troubleshooting easy. Combine the above features with the range and five-way mounting flexibility of the E52 Cube family, and chances are there's an E52 solution to your sensing needs.

The E52 Cube was designed with the most heavy-duty applications in mind. Some of those applications include automotive manufacturing, aggregate machinery, and metalworking applications. Try the E52 Cube in some of your most demanding applications today.

Application Description

Typical Applications

- Automotive manufacturing
- Metalworking
- Machinery OEMs
- Pipe and rod manufacturing
- Block and brick manufacturing equipment
- Amusement parks
- Heavy-duty trucks, cranes and lifts

Features

- Long inductive proximity ranges available (up to 40 mm sensing distance)
- Four-wire DC models have complementary outputs (1NO-1NC)
- Four-wire DC models use auto-configure technology, which allows the sensor to automatically adapt for NPN or PNP without user intervention
- Robust design featuring vibration and impact-absorbing potting compound
- Ideal for extreme temperatures or high pressure washdown environments

Standards and Certifications

- CE



⚠ DANGER

THIS SENSOR IS NOT A SAFETY DEVICE AND IS NOT INTENDED TO BE USED AS A SAFETY DEVICE. This sensor is designed only to detect and read certain data in an electronic manner and perform no use apart from that, specifically no safety-related use. This sensor product does not include self-checking redundant circuitry, and the failure of this sensor product could cause either an energized or de-energized output condition, which could result in death, serious bodily injury, or property damage.

For the most current information on this product, visit our Web site: www.eaton.com



For Customer Service in the U.S. call 1-877-ETN CARE (386-2273), in Canada call 1-800-268-3578. For Application Assistance in the U.S. and Canada call 1-800-426-9184.

Product Selection

E52 Cube Style Sensors





3

DC Four-Wire Sensors

	Voltage Type	Output Configuration	Shielding	Output Type	Sensing Range	Connector Style	Catalog Number
Mini-Connector 	Cube Package (40 x 40 x 40 mm)						
	10–48 Vdc	NPN/PNP autoconfigure ①	Shielded	1 NO and 1 NC	15 mm	DC 4-pin micro	E52Q-DL15SAD01 ⓘ
						DC 4-pin mini	E52Q-DL15SAE01 ⓘ
			Unshielded	1 NO and 1 NC	15 mm	DC 4-pin micro	E52Q-DL15UAD01 ⓘ
						DC 4-pin mini	E52Q-DL15UAE01 ⓘ
	10–48 Vdc	NPN/PNP autoconfigure ①	Shielded	1 NO and 1 NC	20 mm	DC 4-pin micro	E52Q-DL20SAD01 ⓘ
						DC 4-pin mini	E52Q-DL20SAE01 ⓘ
			Unshielded	1 NO and 1 NC	20 mm	DC 4-pin micro	E52Q-DL20UAD01 ⓘ
DC 4-pin mini						E52Q-DL20UAE01 ⓘ	
Micro-Connector 						DC 4-pin micro	E52Q-DL25UAD01 ⓘ
						DC 4-pin mini	E52Q-DL25UAE01 ⓘ
						DC 4-pin micro	E52Q-DL30UAD01 ⓘ
						DC 4-pin mini	E52Q-DL30UAE01 ⓘ
						DC 4-pin micro	E52Q-DL35UAD01 ⓘ
						DC 4-pin mini	E52Q-DL35UAE01 ⓘ
						DC 4-pin micro	E52Q-DL40UAD01 ⓘ
						DC 4-pin mini	E52Q-DL40UAE01 ⓘ

Compatible Connector Cables

Standard Cables ②

	Current Rating at 600 V	Voltage Style	Number of Pins	Gauge	Length	Pin Configuration/Wire Colors (Face View Female Shown)	PVC Jacket Catalog Number	PUR Jacket Catalog Number
Micro-Style Straight Female 	Micro-Style, Straight Female							
	—	DC	4-pin, 4-wire	22 AWG	6.0 ft (2m)	 1-Brown 2-White 3-Blue 4-Black	CSDS4A4CY2202	CSDS4A4RY2202
					16.4 ft (5m)		CSDS4A4CY2205	CSDS4A4RY2205
					32.8 ft (10m)		CSDS4A4CY2210	CSDS4A4RY2210
Mini-Style Straight Female 	Mini-Style, Straight Female							
	10 A	AC/DC	4-pin, 4-wire	16 AWG	6.0 ft (2m)	 1-Black 2-Blue 3-Brown 4-White	CSMS4A4CY1602	—
					13.1 ft (4m)		CSMS4A4CY1604	—
					19.7 ft (6m)		CSMS4A4CY1606	—

Notes

- ⓘ See listing of compatible connector cables above.
- ① Autoconfigure technology allows the sensor to automatically adapt to NPN or PNP without user intervention.
- ② For a full selection of connector cables, see **Tab 10, section 10.1**.

Technical Data and Specifications

E52 Cube Style Sensors

Description	DC Four-Wire
Operating voltage	10–48 Vdc
Load current (maximum)	300 mA
Burden current	<25 mA
Off-state leakage	<150 μ A per output
Voltage drop	<2.5 V
Outputs	1 NO/1 NC (complementary)
Standard target size (mild steel)	120 mm
Frequency of operation	100 Hz
Repeatability	<3%
Hysteresis (maximum)	10–15%
Time delay before availability	300 ms
Circuit protection	Short-circuit protection with auto reset
Operating temperature ^①	–25 to 158 °F (–25 to 70 °C)
Temperature drift	\pm 10%
Enclosure rating	NEMA 4, 4X, 6, 6P, 12 and 13 (IP67, IP68)
Indicator LEDs	Green: power; Red: output status
Material of construction	Zinc alloy housing, PPS, PC

Wiring Diagrams

Pin numbers are for reference, rely on pin location when wiring.

E52 Cube Style Sensors

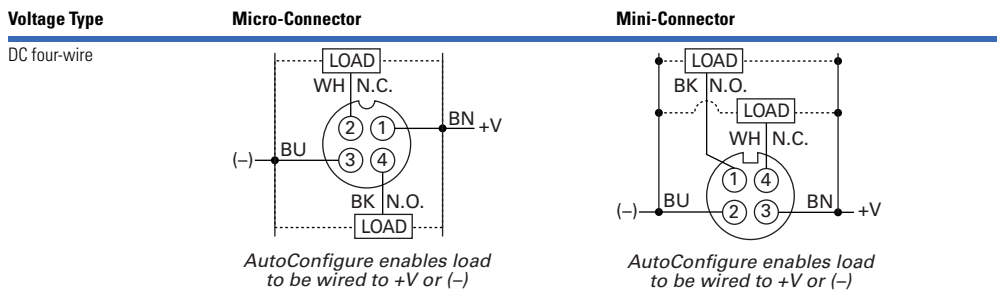

Note

^① Will operate at –40 °F (–40 °C), but range drift will occur.

3.13

Inductive Proximity Sensors

E52 Cube Style Sensors

Dimensions

Approximate Dimensions in Inches (mm)

E52 Cube Style Sensors

3

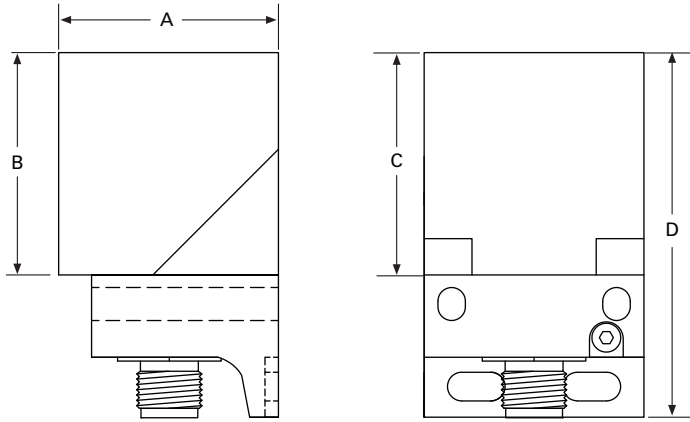

Model	Width A	Depth B	Height C	Overall Height D
Micro-connector	1.57 (40)	1.57 (40)	1.57 (40)	2.725 (69.2)
Mini-connector	1.57 (40)	1.57 (40)	1.57 (40)	2.965 (75.3)

E52 Rectangular Style Sensors



E52 Rectangular Style Sensors

Product Description

Rectangular E52 Inductive Proximity Sensors from Eaton's Electrical Sector feature a small, thin, compact space-saving design for applications where tubular type sensors cannot be used. Sensors are self-contained for direct connection to a logic circuit, relay, counter, programmable controller, and so on.

Features

- Small, low-profile design for use in space restrictive applications
- Three-wire DC operation
- Choose from a variety of sizes, and side or end sensing configurations
- Output indicator included on all models
- Epoxy filled cavities stop fluids from contacting any electrical component
- Convenient mounting holes integrated into each sensor housing

Contents

Description

E52 Rectangular Style Sensors

Product Selection

E52 Rectangular Style Sensors

V8-T3-84

Compatible Connector Cables

V8-T3-84

Technical Data and Specifications

V8-T3-84

Wiring Diagrams

V8-T3-85

Dimensions

V8-T3-85

 **DANGER**

THIS SENSOR IS NOT A SAFETY DEVICE AND IS NOT INTENDED TO BE USED AS A SAFETY DEVICE. This sensor is designed only to detect and read certain data in an electronic manner and perform no use apart from that, specifically no safety-related use. This sensor product does not include self-checking redundant circuitry, and the failure of this sensor product could cause either an energized or de-energized output condition, which could result in death, serious bodily injury, or property damage.





For the most current information on this product, visit our Web site: www.eaton.com

For Customer Service in the U.S. call 1-877-ETN CARE (386-2273),
in Canada call 1-800-268-3578.
For Application Assistance in the U.S. and Canada
call 1-800-426-9184.

Product Selection



E52 Rectangular Style Sensors

Three-Wire Models

	Voltage	Sensing Range	Frequency	Shielding	Connection Type	NO Output Catalog Number	NC Output Catalog Number
R12 Side Sensing	R12 Side Sensing						
	12–24 Vdc	0.12 in (3 mm)	Standard	Shielded (NPN)	1-meter cable	E52RAL12T110	—
				Shielded (PNP)		E52RAL12T111	—
			Alternate	Shielded (NPN)	1-meter cable	E52RAL12T110AF	—
				Shielded (PNP)		E52RAL12T111AF	—
Q16 End Sensing	Q16 End Sensing						
	12–30 Vdc	0.20 in (5 mm)	Standard	Unshielded (NPN)	2-meter cable	E52-16QS04-C	E52-16QS04-C1
				Unshielded (PNP)	2-meter cable	E52-16QS04-B	E52-16QS04-B1
R18 Side Sensing	R18 Side Sensing						
	10–30 Vdc	0.16 in (4 mm)	Standard	Unshielded (NPN)	2-meter cable	E52-18RU04-C	E52-18RU04-C1
					3-pin nano-connector	E52-18RU04-CN Ⓢ	E52-18RU04-C1N Ⓢ
				Unshielded (PNP)	2-meter cable	E52-18RU04-B	E52-18RU04-B1
					3-pin nano-connector	E52-18RU04-BN Ⓢ	E52-18RU04-B1N Ⓢ
Q25 End Sensing	Q25 End Sensing						
	10–30 Vdc	0.39 in (10 mm)	Standard	Shielded (NPN)	2-meter cable	E52-25QS10-C	E52-25QS10-C1
				Shielded (PNP)	2-meter cable	E52-25QS10-B	E52-25QS10-B1

Compatible Connector Cables

Standard Cables ①

	Voltage Style	Number of Pins	Gauge	Length	Pin Configuration/Wire Colors (Face View Female Shown)	PVC Jacket Catalog Number	PUR Jacket Catalog Number
Nano-Style Straight Female	Nano-Style, Straight Female						
	DC	3-pin	24 AWG	6.0 ft (2m)	 1-Brown 2-Blue 3-Black	CSNS3A3CY2402	CSNS3A3RY2402

Technical Data and Specifications

E52 Rectangular Style Sensors

Description	Specification
Input current	Less than 10 mA
Load current	100 mA maximum
Switching rate	500 operations per second
Circuit protection	Short circuit
Ambient temperature range	–13 to 130 °F (–10 to 55 °C)
Enclosure rating	NEMA 1, 2, 3, 3S, 4, 12 (IEC IP66)
Enclosure material	PBT composition
Output indicator LED	Lights when output is ON

Notes

Ⓢ See listing of compatible connector cables above.

① For a full selection of connector cables, see **Tab 10, section 10.1**.

Wiring Diagrams

Pin numbers are for reference, rely on pin location when wiring.

E52 Rectangular Style Sensors

Operating Voltage	Output	Cable Models	Nano-Connector Models (Face View Male Shown)
Three-Wire Sensors			
DC	NPN		
	PNP		

Dimensions

Approximate Dimensions in Inches (mm) except where noted

E52 Rectangular Style Sensors

R12

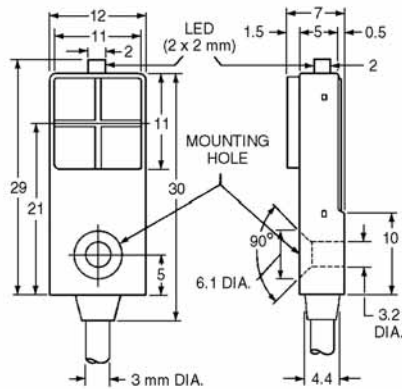

Note: Dimensions are mm only.

Q16

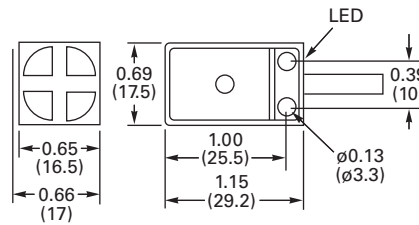

Q25

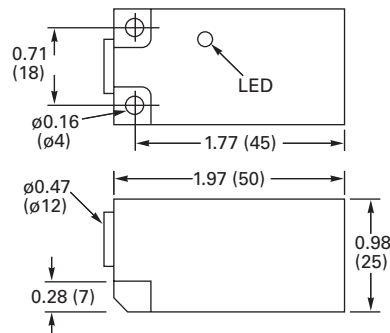

R18

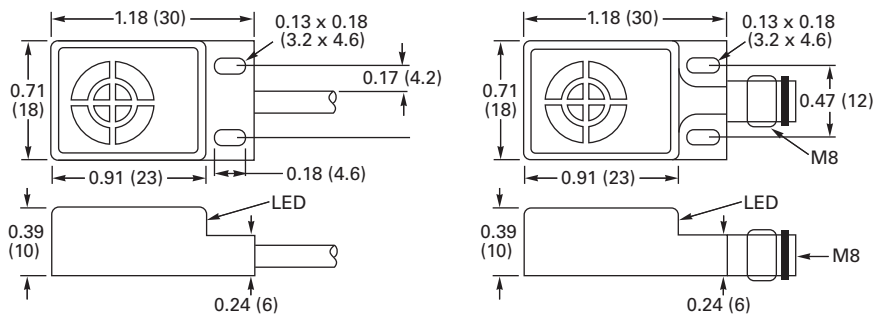

E55 Limit Switch Style Sensors with Nonmetallic Housings



Contents

Description

	<i>Page</i>
E55 Limit Switch Style Sensors with Nonmetallic Housings	
Product Selection	V8-T3-86
Technical Data and Specifications	V8-T3-87
Wiring Diagrams	V8-T3-87
Dimensions	V8-T3-87

E55 Limit Switch Style Sensors with Nonmetallic Housings

Product Description

These sensors from Eaton’s Electrical Sector feature PBT resin housings for high resistance to corrosion. The housing is sized to offer a direct replacement for standard limit switches. The unique sensing head is factory assembled for top sensing, but can be easily converted in the field to any one of four side sensing positions. Models are available with sensing ranges from 15 mm to 40 mm. The sensors can be wired for NO or NC operation.

Features

- Nonmetallic housing offers excellent resistance to corrosion
- Same form factor and mounting as standard limit switches for easy retrofit
- Sensor head features five sensing positions (top and all four sides) that can be easily changed in the field
- Long sensing ranges up to 40 mm



DANGER

THIS SENSOR IS NOT A SAFETY DEVICE AND IS NOT INTENDED TO BE USED AS A SAFETY DEVICE. This sensor is designed only to detect and read certain data in an electronic manner and perform no use apart from that, specifically no safety-related use. This sensor product does not include self-checking redundant circuitry, and the failure of this sensor product could cause either an energized or de-energized output condition, which could result in death, serious bodily injury, or property damage.

Product Selection

E55 Limit Switch Style Sensors

E55 Limit Switch

Two-Wire Sensors



Voltage Type	Sensing Range (Sn)	Shielding	Output	Connection Type	Catalog Number
35–250 Vac	15 mm	Shielded	NO or NC	Terminal wiring	E55BLT1C
	20 mm	Unshielded			E55BLT1D
	30 mm				E55BLT1E
	40 mm				E55BLT1F

For the most current information on this product, visit our Web site: www.eaton.com

For Customer Service in the U.S. call 1-877-ETN CARE (386-2273), in Canada call 1-800-268-3578. For Application Assistance in the U.S. and Canada call 1-800-426-9184.

Technical Data and Specifications

E55 Limit Switch Style Sensors

Description	Specification
Operating voltage	35–250 Vac
Maximum load current	400 mA
Switching frequency	25 Hz maximum
Leakage current	1.8 mA
Voltage drop	8V maximum
Inrush	5 A maximum for 20 ms
Indicator LEDs	Two LEDs: One lights when power is ON, the other lights when output is ON
Operating temperature	–13 to 158 °F (–25 to 70 °C)
Enclosure ratings	NEMA 4, 4X, 6, 12, 13 (IP67)
Housing material	PBT resin

Wiring Diagrams

Pin numbers are for reference, rely on pin location when wiring.

E55 Limit Switch Style Sensors

Operating Voltage	Output	Terminal Models
Two-Wire Sensors		
35–250 Vac ①	NO	
	NC	

Dimensions

Approximate Dimensions in Inches (mm)

E55 Limit Switch Style Sensors

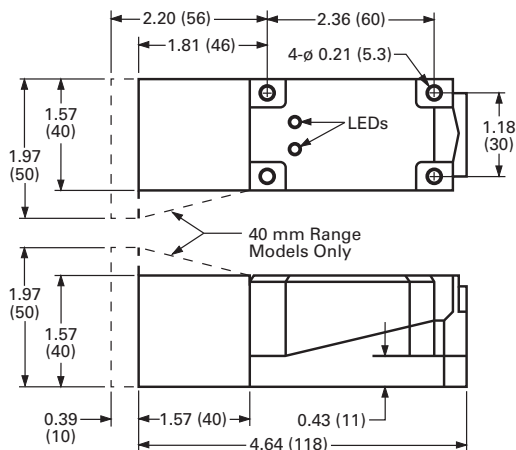

Note

① Switches are shipped as NO configuration. Internal jumpers must be moved to program for NC.

E51 Modular Limit Switch Style Sensors

3



Contents

<i>Description</i>	<i>Page</i>
E51 Modular Limit Switch Style Sensors	
Product Selection	
Standard Sensors—	
Assembled with Terminal Wiring	V8-T3-89
Standard Sensors—	
Assembled with Receptacles	V8-T3-90
Sensor Heads	V8-T3-90
Sensor Bodies	V8-T3-91
Logic Module	V8-T3-91
Receptacles	V8-T3-92
Compatible Connector Cables	V8-T3-93
Accessories	V8-T3-93
Technical Data and Specifications	V8-T3-94
Wiring Diagrams	V8-T3-94
Dimensions	V8-T3-95

E51 Modular Limit Switch Style Sensors

Product Description

The E51 Inductive Proximity Sensor family from Eaton's Electrical Sector combines high performance with a familiar limit switch style housing. Modular, plug-in components provide application flexibility, ease of maintenance, less downtime and reduced inventory. Choose from two-wire sensors in either AC/DC operation, or four-wire sensors in either AC or DC styles. Connection options include terminal, mini-connector or various lengths of cable.

Choose from standard sensors that detect all types of metallic targets. The next page provides more detail on these sensors.

Features

- Rugged construction is ideal for industrial environments
- Viton gaskets ensure a positive seal and high resistance to industry chemicals
- Direct replacement for worn out limit switches
- Sensor heads and bodies feature captive screws to eliminate loss
- All sensor heads include a selector switch to program output function to either NO or NC
- Sensor bodies feature bifurcated engagement prongs for a reliable connection when plugging into receptacle stabs
- Engagement key between sensor body and receptacle prevents improper assembly
- Sensors accommodate both U.S. and DIN mounting dimensions
- Wiring terminals feature captive pressure plate saddles for #18 to #12 AWG wire. A green screw identified ground terminal is also included
- Logic modules are available to provide additional control functions

Standards and Certifications

- UL Listed
- CSA Certified
- CE (where shown)



⚠ DANGER

THIS SENSOR IS NOT A SAFETY DEVICE AND IS NOT INTENDED TO BE USED AS A SAFETY DEVICE. This sensor is designed only to detect and read certain data in an electronic manner and perform no use apart from that, specifically no safety-related use. This sensor product does not include self-checking redundant circuitry, and the failure of this sensor product could cause either an energized or de-energized output condition, which could result in death, serious bodily injury, or property damage.

For the most current information on this product, visit our Web site: www.eaton.com

For Customer Service in the U.S. call 1-877-ETN CARE (386-2273), in Canada call 1-800-268-3578.
For Application Assistance in the U.S. and Canada call 1-800-426-9184.

Product Selection

Standard Sensors—Assembled with Terminal Wiring

Standard E51 sensors feature long sensing ranges and a choice of top or side sensing heads. Alternate frequency units eliminate interference when mounted close to standard frequency units. Order sensors in component form, as assembled plug-in units, or in a sealed version where the sensor body is factory assembled to an epoxy filled receptacle with tamper-proof screws to ensure a lasting seal.

Assembled Sensor



Sensor Heads ①

Top Sensing



Side Sensing



Assembled Sensors—Standard (with Terminal Wiring)

Sensor Body and Receptacle



Operating voltage	20–264 Vac/dc	Two-Wire Sensors		Four-Wire Sensors	
Output	NO or NC ①	120 Vac		10–30 Vdc	
Sensor body	E51SAL	E51SCL	E51SCN Accepts logic modules ②	E51SPL PNP	E51SNL NPN
Receptacle ③	E51RA	E51RC	E51RCB	E51RN	E51RN

Sensing Range

Shielding

Frequency

Sensor Head Only Catalog Number

Assembled Sensors with Head, Sensor Body and Receptacle Catalog Number

Top Sensing		Side Sensing		Sensor Head Only Catalog Number		Assembled Sensors with Head, Sensor Body and Receptacle Catalog Number					
0.51 in (13 mm)	Shielded	Standard	E51DT1	E51ALT1	☐☐	E51CLT1	E51CNT1	E51PLT1	☐☐	E51NLT1	☐☐
		Alternate	E51DT2	E51ALT2	☐☐	E51CLT2	E51CNT2	E51PLT2	☐☐	E51NLT2	☐☐
0.94 in (24 mm)	Unshielded	Standard	E51DT5	E51ALT5	☐☐	E51CLT5	E51CNT5	E51PLT5	☐☐	E51NLT5	☐☐
		Alternate	E51DT6	E51ALT6	☐☐	E51CLT6	E51CNT6	E51PLT6	☐☐	E51NLT6	☐☐
0.51 in (13 mm)	Shielded	Standard	E51DS1	E51ALS1	☐☐	E51CLS1	E51CNS1	E51PLS1	☐☐	E51NLS1	☐☐
		Alternate	E51DS2	E51ALS2	☐☐	E51CLS2	E51CNS2	E51PLS2	☐☐	E51NLS2	☐☐
0.94 in (24 mm)	Unshielded	Standard	E51DS5	E51ALS5	☐☐	E51CLS5	E51CNS5	E51PLS5	☐☐	E51NLS5	☐☐
		Alternate	E51DS6	E51ALS6	☐☐	E51CLS6	E51CNS6	E51PLS6	☐☐	E51NLS6	☐☐

Notes

① All sensor heads feature a programmable output selector switch for NO or NC operation. Operation is as follows:

For This Output Type:	Set Selector Position:	
	"TARGET"	"NO TARGET"
NO	Target present	Target absent
NC	Target absent	Target present

② Logic module must be ordered separately, see **Page V8-T3-91**. These sensor bodies are rated NEMA 4, 4X and 13.

③ Receptacles feature terminal wiring with a 1/2 in NPT thread at the conduit entrance. Other connection options are available:

Connection Option	Catalog Number	Code Suffix	Example
20 mm thread at the conduit entrance	—	20	E51ALT120
Mini-connector termination with epoxy filled receptacle, see Page V8-T3-92 for additional receptacle options	Two-wire, 3-pin connector	CSMS3F3CY1602	P3 E51ALT1P3
	Four-wire, 5-pin connector	CSMS5D5CY1602	P5 E51CLT1P5
Pre-wired cable with epoxy filled receptacle	8 ft long	—	S E51ALT1S
	12 ft long	—	S12 E51ALT1S12
	20 ft long	—	S20 E51ALT1S20

3.16

Inductive Proximity Sensors

E51 Modular Limit Switch Style Sensors

Standard Sensors—Assembled with Receptacles

Sensor body is attached to receptacle with tamper-proof screws.

Assembled Sensor



Assembled Sensors—Standard (with Epoxy Filled Receptacles and Pre-wired Cables)



Sensor Base Type with 8 ft Cable ^②

	Two-Wire Sensors	Four-Wire Sensors
Operating voltage	20–264 Vac/dc	120 Vac 10–30 Vdc
Output	NO or NC ^①	NO and NC complementary PNP NPN

Sensor Heads ^①

Top Sensing



Sensing Range	Shielding	Frequency	Sensor Head Only Catalog Number	Assembled Sensors with Head and Sensor Base Catalog Number
Top Sensing				
0.51 in (13 mm)	Shielded	Standard	E51DT1	E51ALT16P ☹ ☹ E51CLT16P E51PLT16P ☹ ☹ E51NLT16P ☹ ☹
		Alternate	E51DT2	E51ALT26P E51CLT26P E51PLT26P ☹ ☹ E51NLT26P ☹ ☹
0.94 in (24 mm)	Unshielded	Standard	E51DT5	E51ALT56P ☹ ☹ E51CLT56P E51PLT56P ☹ ☹ E51NLT56P ☹ ☹
		Alternate	E51DT6	E51ALT66P ☹ ☹ E51CLT66P E51PLT66P ☹ ☹ E51NLT66P ☹ ☹
Side Sensing				
0.51 in (13 mm)	Shielded	Standard	E51DS1	E51ALS16P ☹ ☹ E51CLS16P E51PLS16P ☹ ☹ E51NLS16P ☹ ☹
		Alternate	E51DS2	E51ALS26P ☹ ☹ E51CLS26P E51PLS26P ☹ ☹ E51NLS26P ☹ ☹
0.94 in (24 mm)	Unshielded	Standard	E51DS5	E51ALS56P ☹ ☹ E51CLS56P E51PLS56P ☹ ☹ E51NLS56P ☹ ☹
		Alternate	E51DS6	E51ALS66P ☹ ☹ E51CLS66P E51PLS66P ☹ ☹ E51NLS66P ☹ ☹

Side Sensing



Sensor Heads

Sensor Heads ^①

Top Sensing



Sensing Range	Shielding	Frequency	Target Material	Catalog Number
Top Sensing				
0.51 in (13 mm)	Shielded	Standard	All metals	E51DT1
		Alternate		E51DT2
0.94 in (24 mm)	Unshielded	Standard	All metals	E51DT5
		Alternate		E51DT6
Side Sensing				
0.51 in (13 mm)	Shielded	Standard	All metals	E51DS1
		Alternate		E51DS2
0.94 in (24 mm)	Unshielded	Standard	All metals	E51DS5
		Alternate		E51DS6

Side Sensing



Notes

^① All sensor heads feature a programmable output selector switch for NO or NC operation. Operation is as follows:

For This Output Type:	Set Selector Position:	
	"TARGET"	"NO TARGET"
NO	Target present	Target absent
NC	Target absent	Target present

^② Switch bases feature 8 ft of SOOW-A cable. Other connection options are available:

Connection Option ^③	Suffix	Example
Mini-connector mounted on 3 ft (0.9m) pigtail cable	T	E51ALT16PT
Mini-connector mounted to switch base	C	E51ALT16PC
Cable longer than 8 feet, add required length in 1 ft increments to listed catalog number—20 ft maximum	Length in ft	E51ALT16P12 for 12 ft

^③ See listing of compatible connector cables on **Page V8-T3-93**.

Sensor Bodies

Two-Wire Sensors

Operating Voltage	Output	Protection	Output Rating Continuous	Type	Catalog Number
AC/DC	AC/DC				
20–264 Vac/dc, 50/60 Hz	1 output, load powered, NO or NC, programmable from head; off state leakage current: <1.7 mA at 120 Vac/dc, <2.0 mA at 240 Vac	Latching short circuit and overload	0.5 A	—	E51SAL ① CE



Four-Wire Sensors

Operating Voltage	Output	Protection	Output Rating Continuous	Type	Catalog Number
AC (E51SCN Shown)	AC				
120 Vac, 50/60 Hz	2 complementary outputs, line powered, NO and NC	—	1.0 A to 158 °F (70 °C), linearly derated to 0.6 A at 176 °F (80 °C)	—	E51SCL ①
			1.0 A to 113 °F (45 °C), linearly derated to 0.3 A at 176 °F (80 °C)	—	E51SCN ②③
DC	DC				
10–30 Vdc	2 complementary outputs, line powered, NO and NC	Reverse polarity	0.6 A to 104 °F (40 °C), linearly derated to 0.36A at 176 °F (80 °C)	NPN	E51SNL ①
				PNP	E51SPL ①



Logic Module

Logic Module (for E51SCN Sensor Body Only)

Type	Description	Timing Range ④	Catalog Number
Logic Module ⑤	ON and OFF delay Adjustable delay between time object is sensed and time switch function occurs Adjustable delay between time object leaves sensing field and time switch transfers back to non-sensing state	0.15 to 15.0 seconds	E51MTB







Notes

- ① This sensor body is available in a factory-sealed, non plug-in configuration (with 8-ft cable), add **6P** to listed catalog number. Example: E51SAL**6P**.
- ② Sensor body is black. E51SCN sensor bodies are rated NEMA 4, 4X and 13.
- ③ This sensor accepts logic modules, as seen in chart above.
- ④ Repeatability of the timing cycle is ±1% at constant voltage, ambient temperature and reset time.
- ⑤ Reset time is 25 ms minimum. Rated NEMA 4, 4X and 13.

Receptacles

Receptacles

3

	Description	Style	Details	Cable Length	Conduit Entrance	
					1/2 in NPT Catalog Number	20 mm Catalog Number
Surface Mount 	Surface Mount					
	Conduit entrance, front or rear mounting	Two-wire, AC/DC	—	—	E51RA	E51RA20
		Four-wire, AC	Gray	—	E51RC	E51RC20
			Black ①	—	E51RCB	E51RCB20
Four-wire, DC	—	—	E51RN	E51RN20		
Mini-Connector 	Mini-Connector					
	Epoxy filled receptacle with pre-wired mini-connector	Two-wire, AC/DC	3-pin	—	E51RAP3 ☺	—
		Four-wire, AC	5-pin	—	E51RCP5 ☺	—
Four-wire, DC		5-pin	—	E51RNP5 ☺	—	
Pigtail with Mini-Connector 	Pigtail with Mini-Connector					
	Epoxy filled receptacle with mini-connector mounted on 3 ft (0.9m) cable	Two-wire, AC/DC	3-pin	3 ft (0.9m)	E51RAP3T ☺	—
		Four-wire, AC	5-pin	3 ft (0.9m)	E51RCP5T ☺	—
Four-wire, DC		5-pin	3 ft (0.9m)	E51RNP5T ☺	—	
Pre-Wired Cable 	Pre-Wired Cable					
	Epoxy filled receptacle with pre-wired 16 gauge, yellow jacketed, type SOOW-A cable. Cable enters through hole threaded for conduit	Two-wire, AC/DC	3-conductor	8 ft (2.4m)	E51RAS	E51RA20S
				12 ft (3.6m)	E51RAS12	—
				20 ft (6m)	E51RAS20	—
		Four-wire, AC	5-conductor	8 ft (2.4m)	E51RCS	E51RC20S
				12 ft (3.6m)	E51RCS12	—
				20 ft (6m)	E51RCS20	—
		Four-wire, DC	5-conductor	8 ft (2.4m)	E51RNS	E51RN20S
				12 ft (3.6m)	E51RNS12	—
20 ft (6m)				E51RNS20	—	





Notes

☺☺ See listing of compatible connector cables on [Page V8-T3-93](#).

① Black receptacle is for color compatibility with E51SCN sensor body.





Compatible Connector Cables

Standard Cables ^①

	Current Rating at 600 V	Voltage Style	Number of Pins	Gauge	Length	Pin Configuration/Wire Colors (Face View Female Shown)	Catalog Number
Micro-Style Straight Female 	Micro-Style, Straight Female						
	13 A	—	3-pin	16 AWG	6 ft (2m)	 1-Green 2-Black 3-White	CSMS3F3CY1602
	10 A	AC/DC	4-pin, four-wire	16 AWG	6 ft (2m)	 1-Black 2-Blue 3-Brown 4-White	CSMS4A4CY1602
	8 A	—	5-pin	16 AWG	6 ft (2m)	 1-White 2-Red 3-Green 4-Orange 5-Black	CSMS5D5CY1602

Accessories

E51 Modular Limit Switch Style Sensors

	Description	Catalog Number
One Hole 	Universal Mounting Bracket One hole, includes mounting hardware, stainless steel	E51KH2
Two Holes 	Universal Mounting Bracket Two holes, includes mounting hardware, steel	E51KH4
Machine Mounting Bracket 	Machine Mounting Bracket Zinc die cast construction	E50KH3
Stand-Off Mounting Bracket 	Stand-Off Mounting Bracket Steel construction	E51KH3
Remote Sensor Head Assembly 	Remote Sensor Head Assembly Permits mounting sensor head up to 3 ft (0.9m) from sensor body	E51KRM

Dimensions, see Page V8-T3-95.

Note

^① For a full selection of connector cables, see **Tab 10, section 10.1**.

Technical Data and Specifications

E51 Modular Limit Switch Style Sensors

Description	Specification
Output rating (NEMA D150)	
AC/DC models	0.5 A continuous
AC models	1 A continuous
DC models	0.6 A continuous
Protection	Latching short-circuit protection on two-wire AC/DC models; DC models: resettable short-circuit protection
Switching rate	AC models: 15 Hz; DC models: 50 Hz
Indicator LEDs	Lights when output is ON. One LED for each output
Alternate frequency	Standard and alternate frequencies allow side-by-side operation without interference
Enclosure material	Zinc die cast
Gasket material	Viton
Enclosure ratings	NEMA 3, 3S, 4, 4X, 6, 6P, 12 and 13 (IP67); E51SCN sensor body only: NEMA 4, 4X and 13
Hazardous locations ratings	
Class I	Division II—GRPS ABCD
Class II	Division II—GRPS F and G
Class III	Division 2
Temperature range	-13 to 158 °F (-25 to 70 °C)
Torque requirements	Switch body screws: 25–30 in-lbs; sensing head screws: 14–18 in-lbs
Vibration	10–55 Hz, 1 mm amplitude
Shock	30 g, 11 ms, 1/2 sine wave
Humidity	95% non-condensing
Burden current	<25 mA
OFF-state leakage	DC version: 120 µA; two-wire AC: 1.9 mA maximum; three-wire AC: 1.1 mA
ON-state leakage	<2.5 Vdc
Power-up delay	<150 ms

Wiring Diagrams

Pin numbers are for reference, rely on pin location when wiring.

E51 Modular Limit Switch Style Sensors

Operating Voltage	Output	Terminal and Cable Models	Mini-Connector Models (Face View Male Shown)
Two-Wire Sensors			
20–264 Vac or Vdc 50/60 Hz	NO or NC (NO shown, can be changed to NC using switch on sensor head)		
Four-Wire Sensors			
120 Vac 50/60 Hz	NO and NC ①		
10–30 Vdc	NO and NC NPN ①		
	NO and NC PNP ①		

Note

① Changing output switch on sensor head will reverse output function (NO becomes NC, and NC becomes NO).

Dimensions

Approximate Dimensions in mm [in]

E51 Modular Limit Switch Style Sensors

Standard Sensors

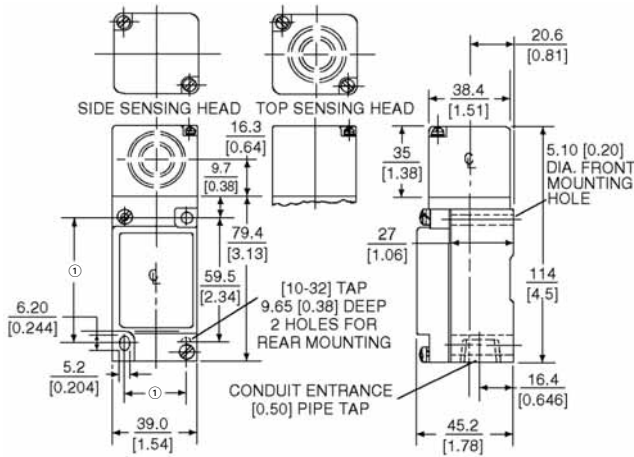

Sensor with Logic Module

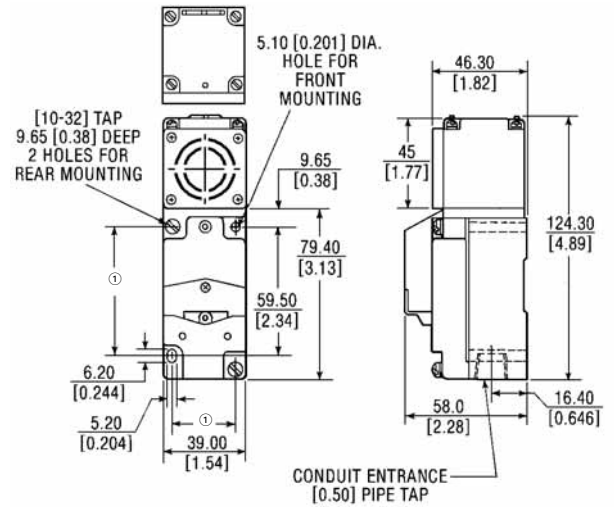

Accessories

Approximate Dimensions in Inches [mm]

Universal Mounting Bracket—One Hole

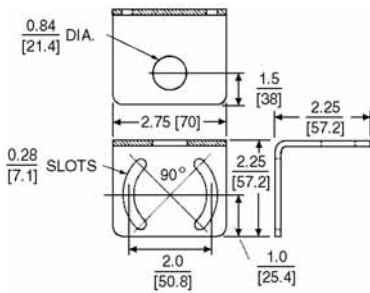

Universal Mounting Bracket—Two Holes

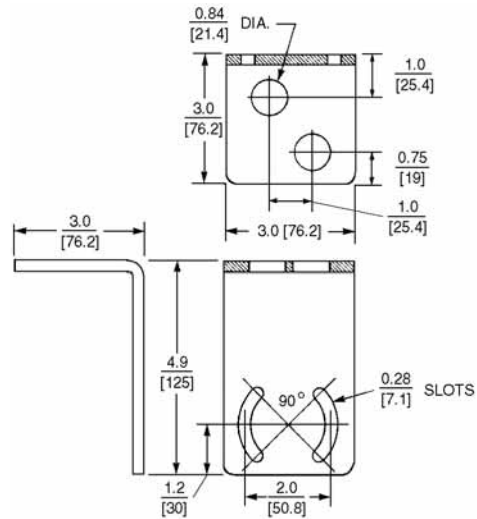

Note

① Can accommodate both U.S., 29.4 [1.16] x 59.5 [2.34] and DIN, 30 [1.18] x 60 [2.36], mounting dimensions are in mm [in].

3.16

Inductive Proximity Sensors

E51 Modular Limit Switch Style Sensors

Approximate Dimensions in mm [in]

Machine Mounting Bracket

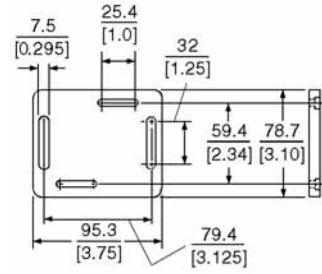

Stand-Off Mounting Bracket

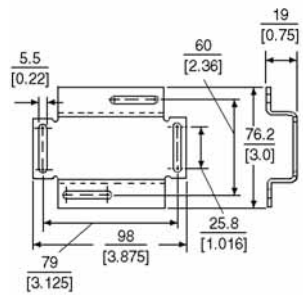

Remote Sensor Head Assembly

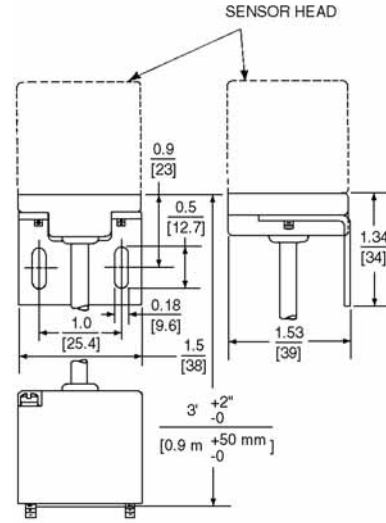

3

E51 Limit Switch Style, Factory Sealed 6P+ Sensors



Contents

Description

E51 Limit Switch Style, Factory Sealed 6P+ Sensors

	<i>Page</i>
Product Selection	
Unitized Sensors	V8-T3-98
Compatible Connector Cables	V8-T3-98
Accessories	V8-T3-99
Technical Data and Specifications	V8-T3-99
Wiring Diagrams	V8-T3-100
Dimensions	V8-T3-100

E51 Limit Switch Style, Factory Sealed 6P+ Sensors

Product Description

E51 6P+ Inductive Proximity Sensors from Eaton's Electrical Sector are fully sealed, pre-wired and designed specifically to ensure reliability under the most adverse of environmental conditions. They have been proven to withstand the penetrating properties of dirt, dust, grit, extreme temperatures and humidity. The unitized design eliminates plug-in connections that can lead to reliability problems in rugged environments.

Features

- The one-piece body and sensing head are both epoxy filled to protect internal components from contamination
- The head is hard-wired to the sensor body to ensure trouble-free performance
- Choose from top and side sensing heads
- Side sensing heads can be rotated to any of four positions
- Mounting dimensions allow direct replacement of worn out limit switches
- Rugged zinc die cast construction withstands physical abuse
- Connection options include pre-wired cable, body mounted connector and pigtail connector

DANGER

THIS SENSOR IS NOT A SAFETY DEVICE AND IS NOT INTENDED TO BE USED AS A SAFETY DEVICE. This sensor is designed only to detect and read certain data in an electronic manner and perform no use apart from that, specifically no safety-related use. This sensor product does not include self-checking redundant circuitry, and the failure of this sensor product could cause either an energized or de-energized output condition, which could result in death, serious bodily injury, or property damage.

For the most current information on this product, visit our Web site: www.eaton.com

For Customer Service in the U.S. call 1-877-ETN CARE (386-2273), in Canada call 1-800-268-3578.
For Application Assistance in the U.S. and Canada call 1-800-426-9184.

Product Selection

Unitized Sensors

3

Assembled Sensor with 8 ft Cable ^①



Sensor Heads ^②

Top Sensing ^②



Side Sensing ^②



Factory Sealed 6P+ Assembled Sensors

			Two-Wire Sensors		Four-Wire Sensors		
Operating voltage			20–264 Vac/dc		120 Vac	10–30 Vdc	
Output			NO	NC	NO and NC complementary	NO and NC complementary PNP NPN	

Assembled Sensor with Head, Sensor Body and Receptacle

Sensing Range	Shielding	Frequency ^③	Assembled Sensor with Head, Sensor Body and Receptacle Catalog Number					
---------------	-----------	------------------------	--	--	--	--	--	--

Top Sensing								
0.51 in (13 mm)	Shielded	Standard	E51ALT16PU	E51BLT16PU	E51CLT16PU	E51PLT16PU	E51NLT16PU	
		Alternate	E51ALT26PU	E51BLT26PU	E51CLT26PU	E51PLT26PU	E51NLT26PU	
0.94 in (24 mm)	Unshielded	Standard	E51ALT56PU	E51BLT56PU	E51CLT56PU	E51PLT56PU	E51NLT56PU	
		Alternate	E51ALT66PU	E51BLT66PU	E51CLT66PU	E51PLT66PU	E51NLT66PU	

Side Sensing								
0.51 in (13 mm)	Shielded	Standard	E51ALS16PU	E51BLS16PU	E51CLS16PU	E51PLS16PU	E51NLS16PU	
		Alternate	E51ALS26PU	E51BLS26PU	E51CLS26PU	E51PLS26PU	E51NLS26PU	
0.94 in (24 mm)	Unshielded	Standard	E51ALS56PU	E51BLS56PU	E51CLS56PU	E51PLS56PU	E51NLS56PU	
		Alternate	E51ALS66PU	E51BLS66PU	E51CLS66PU	E51PLS66PU	E51NLS66PU	

Compatible Connector Cables

Standard Cables ^④

Current Rating at 600 V	Voltage Style	Number of Pins	Gauge	Length	Pin Configuration/Wire Colors (Face View Female Shown)	Catalog Number
Mini-Style, Straight Female						
13 A	—	3-pin	16 AWG	6 ft (2m)	1-Green 2-Black 3-White	CSMS3F3CY1602
10 A	—	4-pin	16 AWG	6 ft (2m)	1-Black 2-Blue 3-Brown 4-White	CSMS4A4CY1602
8 A	AC/DC	5-pin, 5-wire	16 AWG	6 ft (2m)	1-Black 2-Blue 3-Orange 4-Brown 5-White	CSMS5A5CY1602

Notes

^① Switch bases feature 8 ft of SOOW-A cable. Other connection options are available:

Connection Option ^④	Instructions	Example
Mini-connector mounted on 3 ft (0.9m) pigtail cable (3-pin for two-wire sensors; 5-pin for four-wire sensors)	Add the letter T before U	E51ALT16PTU
Mini-connector mounted to switch base (3-pin for two-wire sensors; 5-pin for four-wire sensors)	Add the letter C before U	E51ALT16PCU
Cable longer than 8 ft, add required length in 1 ft increments to listed catalog number—20 ft maximum	Add length in feet to end of catalog number	E51ALT16PU12 ^⑤

^② Sensor head is hard wired to sensor body and cannot be detached. Side sensing head can be unfastened and rotated to any of four positions.

^③ Sensor heads feature color coded target symbols: Yellow for standard frequency; Green for alternate frequency.





^④ See listing of compatible connector cables above.

^⑤ For 12 ft.

^⑥ For a full selection of connector cables, see **Tab 10, section 10.1**.

Accessories

E51 Limit Switch Style, Factory Sealed 6P+ ①

	Description	Catalog Number
One Hole 	Universal Mounting Bracket Includes mounting hardware, stainless steel	E51KH2
Two Holes 	Includes mounting hardware, steel	E51KH4
Machine Mounting Bracket 	Machine Mounting Bracket Zinc die cast construction	E50KH3
Stand-Off Mounting Bracket 	Stand-Off Mounting Bracket Steel construction	E51KH3
Dimensions , see Page V8-T3-100 .		

Technical Data and Specifications

E51 Limit Switch Style, Factory Sealed 6P+

Description	Specification
Output rating (NEMA D150)	
AC/DC models	0.5 A continuous
AC models	1 A continuous
DC models	0.6 A continuous
Protection	Latching short-circuit protection on two-wire AC/DC and three-wire DC models
Switching rate	AC models: 15 Hz; DC models: 50 Hz
Indicator LEDs	Lights when output is ON. One LED for each output
Alternate frequency	Standard and alternate frequencies allow side-by-side operation without interference
Enclosure material	Cast metal
Gasket material	Zinc die cast
Enclosure ratings	NEMA 3, 3S, 4, 4X, 6, 6P, 12 and 13 (IP68)
Temperature range	-13 to 158 °F (-25 to 70 °C)
Torque requirements	Switch body screws: 25–30 in-lbs; sensing head screws: 14–18 in-lbs
OFF-state leakage	DC version: 120 µA; two-wire AC: 1.9 mA maximum; three-wire AC: 1.1 mA
ON-state leakage	<2.5 Vdc

Note

① For a full selection of connector cables, see **Tab 10, section 10.1**.

3.17

Inductive Proximity Sensors

E51 Limit Switch Style, Factory Sealed 6P+ Sensors

Wiring Diagrams

Pin numbers are for reference, rely on pin location when wiring.

E51 Limit Switch Style, Factory Sealed 6P+

3

Operating Voltage	Output	Cable Models	Mini-Connector Models (Face View Male Shown)
Two-Wire Sensors			
20–264 Vac or Vdc 50/60 Hz	NO or NC (NO shown)		
Four-Wire Sensors			
120 Vac 50/60 Hz	NO and NC		
10–30 Vdc	NO and NC NPN		
	NO and NC PNP		

Dimensions

Approximate Dimensions in mm [in]

E51 Limit Switch Style, Factory Sealed 6P+

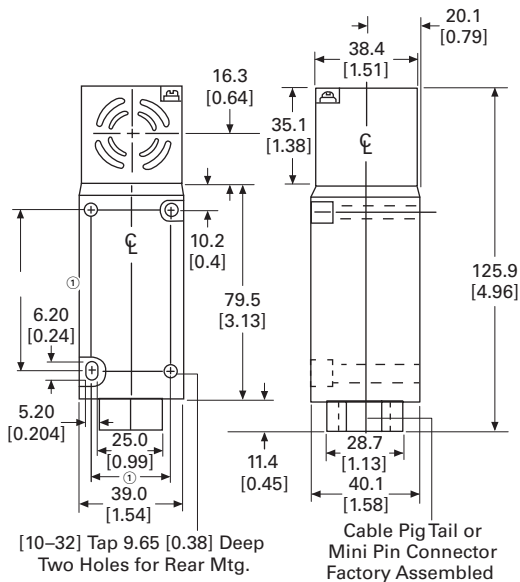

Note

① Can accommodate both U.S., 29.4 [1.16] x 59.5 [2.34] and DIN, 30 [1.18] x 60 [2.36], mounting dimensions.

Approximate Dimensions in Inches [mm]

Accessories

Universal Mounting Bracket—One Hole

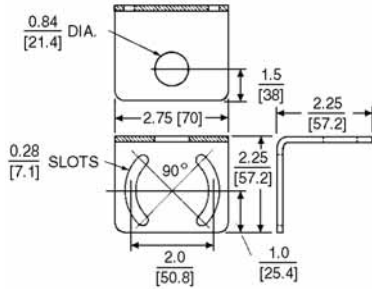

Universal Mounting Bracket—Two Holes

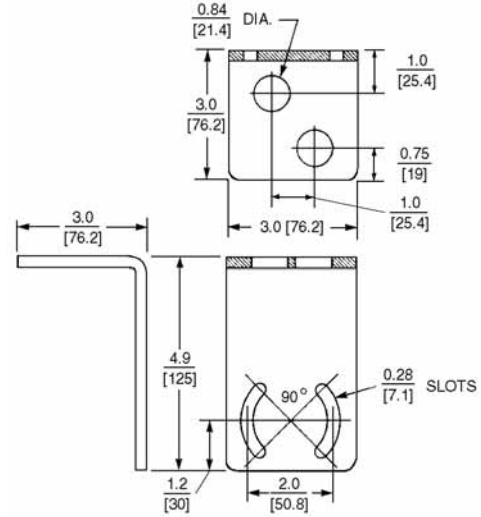

Approximate Dimensions in mm [in]

Machine Mounting Bracket

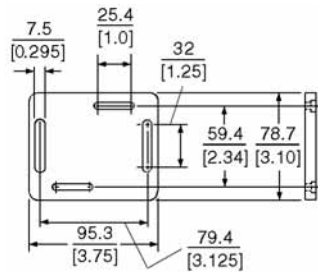

Stand-Off Mounting Bracket

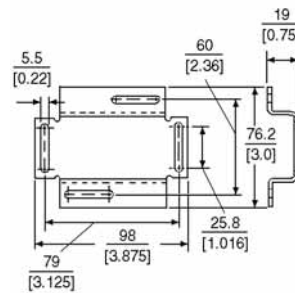

Note

- ① Can accommodate both U.S., 29.4 [1.16] x 59.5 [2.34] and DIN, 30 [1.18] x 60 [2.36], mounting dimensions.

Threaded Body



Smooth Body



4.0 Introduction

Technical Reference	V8-T4-2
Product Selection Guide	V8-T4-5

4.1 Threaded Body Sensors

Product Description	V8-T4-6
Features	V8-T4-6
Product Selection	V8-T4-7
Technical Data and Specifications	V8-T4-8
Wiring Diagrams	V8-T4-9
Dimensions	V8-T4-9

4.2 Smooth Body Sensors

Product Description	V8-T4-10
Features	V8-T4-10
Product Selection	V8-T4-11
Technical Data and Specifications	V8-T4-12
Wiring Diagrams	V8-T4-12
Dimensions	V8-T4-12



Unless otherwise noted, the products contained in this section should not be used for functional safety applications. These products were not designed or tested to IEC 60947-5-3 or recommended for functional safety.



For Customer Service in the U.S. call 1-877-ETN CARE (386-2273),
in Canada call 1-800-268-3578.
For Application Assistance in the U.S. and Canada
call 1-800-426-9184.

Technical Reference

Capacitive Proximity Sensors

4



Capacitive proximity sensors are designed to detect both metallic and nonmetallic targets. They are ideally suited for liquid level control and for sensing powdered or granulated material.

Strengths and Weaknesses

Consider these strengths and weaknesses of the capacitive proximity sensor:

Capacitive Proximity Sensor Attributes

Attributes

Strengths

Can detect both metallic and nonmetallic objects at greater ranges than inductive sensors

High switching rate for rapid response applications (counting)

Can detect liquid targets through non-metallic barriers (glass, plastic)

Long operation life, solid-state output for "bounce free" signals

Weaknesses

Affected by varying temperature, humidity and moisture conditions

Not as accurate as inductive proximity sensors

Applications

Here are some examples showing how the detection power of capacitive proximity sensors is used:

- **Liquid level detection applications**, such as preventing overfilling or underfilling, are common in the packaging industry
- **Material level control applications**, such as assuring that a sleeve of labels on a labeling line is not empty
- **Counting applications**, such as tracking units passing a point on a conveyor
- **Induction molding process**, detection of level of plastic pellets in feed hopper

Operation of the Capacitive Proximity Sensor

A capacitor consists of two metal plates separated by an insulator (called a **dielectric**). **The operation of this type of sensor is based on dielectric capacitance**, which is the ability of a dielectric to store an electrical charge.

The distance between the plates determines the ability of the capacitor to store a charge.

Measuring the change in capacitance as an object enters the electrical field can be used as an ON/OFF switching function.

Capacitor Operation

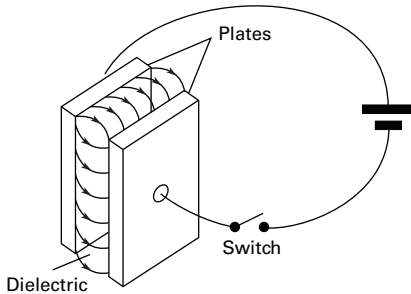

When this principle is applied to the capacitive proximity sensor, **one capacitive plate is part of the switch, the enclosure (the sensor face) is the insulator. The target is the other "plate."** Ground is the common path.

Capacitive proximity sensors can detect any target that has a dielectric constant greater than air. Liquids have high dielectric constants. Metal also makes a good target.

Capacitive Proximity Sensor Operation

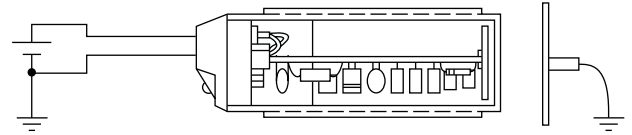

The capacitive proximity sensor has four basic elements: a sensor (which is a dielectric), an oscillator circuit, a detector circuit and an output circuit.

As an object approaches the sensor, the **dielectric constant of the capacitor changes**. The oscillator circuit's **oscillation begins when feedback capacitance is detected**. This is just the opposite in the inductive proximity sensor, where the oscillation is damped when the target is present.

Oscillator Damping

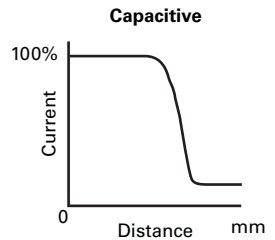
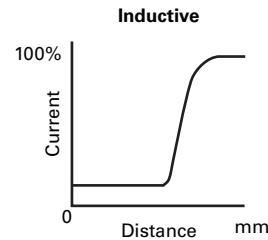

The **detector circuit** monitors the oscillator's output. When it detects sufficient change in the field, it switches on the output circuit.

The **output circuit** remains active until the target leaves the sensing field. The oscillator responds with a decrease in amplitude, and when it is no longer receiving sufficient capacitance feedback, the detector circuit switches OFF.

There is a built-in **difference between the operate and release amplitudes to provide hysteresis**.

Capacitive Proximity Sensor Influences

Many of the same factors that influence the sensing range of inductive proximity sensors, also influence the sensing range of capacitive proximity sensors.

Typically, capacitive sensors have a greater sensing range than inductive sensors.

Sensing distance for capacitive proximity sensors is dependent on plate diameter. With inductive proximity sensors, the size of the coil is the determining factor.

Typical Proximity Sensing Ranges

Sensor with a Tubular Diameter of:	Inductive Unshielded Sensor	Capacitive Unshielded Sensor
18 mm	8 mm	15 mm
30 mm	15 mm	25 mm
34 mm	—	35 mm

Sensitivity Adjustment

Most capacitive proximity sensors are equipped with sensitivity adjustment potentiometers. Because the sensor measures a dielectric gap, it is important to be able to compensate for target and application conditions and adjust the sensing range.

Target Material and Size

A capacitive sensor should not be hand-held during set up. Because your hand has a dielectric constant greater than air, the sensor may detect your hand rather than the intended target.

Capacitive sensors can detect both ferrous and non-ferrous materials equally well. **There is no derating factor to be applied when sensing metal targets.** But, other materials do affect the sensing range.

Because they can be used to detect liquid through a nonmetallic material such as glass or plastic, you need to ensure that the sensor detects just the liquid, not the container. **The transparency of the container has no effect on the sensing.**

Environment

Many of the same factors that affect inductive proximity sensors, also affect capacitive sensors, only more so.

- Embeddable mounting—capacitive sensors are generally treated as **non-shielded devices**, and therefore, **are not embeddable**
- Flying chips—they are **more sensitive to both metallic and nonmetallic chips** and residue
- Adjacent sensors—**more space between devices is required** due to the greater, non-shielded sensing range
- Target background—because of both the greater sensing range, and its ability to sense metallic and nonmetallic materials, **greater care in applying these sensors is needed when background conditions are present**
- Ambient atmosphere—the **amount of humidity in the air may cause a capacitive sensor to operate** even when no target is present
- Welding magnetic fields—capacitive sensors **are generally not applied in a welding environment**
- Radio Frequency Interference (RFI)—in the same way that inductive proximity sensors are affected, **RFI interferes with capacitive sensor circuitry**
- Showering arc (EFT)—**induced electrical noise affects these sensors** in the same way it does for an inductive sensor

Product Selection Guide

Threaded Body Capacitive Proximity Sensors



Page V8-T4-6

Overview

These self-contained devices will detect both metallic and nonmetallic targets. A full threaded housing provides ease of mounting.

Applications

Liquid level control
Nonmetallic targets

Product Features

18 and 30 mm diameters with threaded housing
Shielded and unshielded sensing
Two-wire AC—20 to 250V
Three-wire DC—10 to 30V, NPN and PNP
2-meter PVC cable or 4-pin micro-connector
Short circuit and reverse polarity protected (DC models)
LED indicator
Sensitivity adjustment

Technical Data and Specifications

Contact ratings—
AC: 300 mA
DC: 300 mA
Enclosure ratings—
NEMA® 1, 2, 3, 3S, 4, 12, 13
IP65
Construction—
POM
Nuts, nylon 66

Approvals

CE



Smooth Body Capacitive Proximity Sensors



Page V8-T4-10

Overview

Smooth body capacitive models feature longer ranges than our threaded body models and include a convenient mounting bracket.

Applications

Liquid level control
Nonmetallic targets

Product Features

34 mm diameter
Shielded and unshielded sensing
Two-wire AC—20 to 250V
Three-wire DC—10 to 30V, NPN and PNP
2-meter PVC cable or 4-pin micro-connector
Short circuit and reverse polarity protected (DC models)
LED indicator
Sensitivity adjustment
Includes mounting bracket

Technical Data and Specifications

Contact ratings—
AC: 300 mA
DC: 300 mA
Enclosure ratings—
NEMA 1, 2, 3, 3S, 4, 12, 13
IP65
Construction—
POM
Nuts, nylon 66

Approvals

CE



Threaded Body Sensors



4

Contents

Description

Page

Threaded Body Sensors

Product Selection

E53 Threaded Body Sensors

V8-T4-7

Compatible Connector Cables

V8-T4-8

Technical Data and Specifications

V8-T4-8

Wiring Diagrams

V8-T4-9

Dimensions

V8-T4-9

Threaded Body Sensors

Product Description

Type E53 Capacitive Proximity Sensors from Eaton's electrical sector are self-contained devices designed to detect both metallic and nonmetallic targets. They are ideally suited for liquid level control and for sensing powdered or granulated material. For best operation, they should be used in an environment having relatively constant temperature and humidity.

Features

- Detect liquids, powders and other materials that are difficult or impossible to detect with other sensor types
- Plastic body is corrosion resistant
- Sensitivity adjustment
- Output indicator LED



DANGER

THIS SENSOR IS NOT A SAFETY DEVICE AND IS NOT INTENDED TO BE USED AS A SAFETY DEVICE. This sensor is designed only to detect and read certain data in an electronic manner and perform no use apart from that, specifically no safety-related use. This sensor product does not include self-checking redundant circuitry, and the failure of this sensor product could cause either an energized or de-energized output condition, which could result in death, serious bodily injury, or property damage.



For the most current information on this product, visit our Web site: www.eaton.com

For Customer Service in the U.S. call 1-877-ETN CARE (386-2273),
in Canada call 1-800-268-3578.
For Application Assistance in the U.S. and Canada
call 1-800-426-9184.



Product Selection

E53 Threaded Body Sensors

Two-Wire Sensors

	Operating Voltage	Sensing Range (Sn)	Shielding	Connection Type	NO Output Catalog Number	NC Output Catalog Number
 <p>18 mm Diameter</p>	18 mm Diameter					
	20–250 Vac	0.31 in (8 mm)	Shielded	2-meter cable	E53KAL18A2	E53KBL18A2
				3-pin micro AC connector	E53KAL18A2SA Ⓢ	E53KBL18A2SA Ⓢ
		0.59 in (15 mm)	Unshielded	2-meter cable	E53KAL18A2E	E53KBL18A2E
				3-pin micro AC connector	E53KAL18A2EA Ⓢ	E53KBL18A2EA Ⓢ
	 <p>30 mm Diameter</p>	30 mm Diameter				
20–250 Vac		0.79 in (20 mm)	Shielded	2-meter cable	E53KAL30A2	E53KBL30A2
				3-pin micro AC connector	E53KAL30A2SA Ⓢ	E53KBL30A2SA Ⓢ
		0.98 in (25 mm)	Unshielded	2-meter cable	E53KAL30A2E	E53KBL30A2E
				3-pin micro AC connector	E53KAL30A2EA Ⓢ	E53KBL30A2EA Ⓢ

Three-Wire Sensors

	Operating Voltage	Sensing Range (Sn)	Shielding	Connection Type	NO Output Catalog Number	NC Output Catalog Number		
 <p>18 mm Diameter</p>	18 mm Diameter							
	10–30 Vdc	0.31 in (8 mm)	Shielded (NPN)	2-meter cable	E53KAL18T110	E53KBL18T110		
				4-pin micro DC connector	E53KAL18T110SD Ⓢ	E53KBL18T110SD Ⓢ		
			Shielded (PNP)	2-meter cable	E53KAL18T111	E53KBL18T111		
				4-pin micro DC connector	E53KAL18T111SD Ⓢ	E53KBL18T111SD Ⓢ		
			0.59 in (15 mm)	Unshielded (NPN)	2-meter cable	E53KAL18T110E	E53KBL18T110E	
					4-pin micro DC connector	E53KAL18T110ED Ⓢ	E53KBL18T110ED Ⓢ	
		0.59 in (15 mm)	Unshielded (PNP)	2-meter cable	E53KAL18T111E	E53KBL18T111E		
				4-pin micro DC connector	E53KAL18T111ED Ⓢ	E53KBL18T111ED Ⓢ		
			 <p>30 mm Diameter</p>	30 mm Diameter				
10–30 Vdc				0.79 in (20 mm)	Shielded (NPN)	2-meter cable	E53KAL30T110	E53KBL30T110
	4-pin micro DC connector	E53KAL30T110SD Ⓢ				E53KBL30T110SD Ⓢ		
	Shielded (PNP)	2-meter cable			E53KAL30T111	E53KBL30T111		
		4-pin micro DC connector			E53KAL30T111SD Ⓢ	E53KBL30T111SD Ⓢ		
	0.98 in (30 mm)	Unshielded (NPN)			2-meter cable	E53KAL30T110E	E53KBL30T110E	
			4-pin micro DC connector		E53KAL30T110ED Ⓢ	E53KBL30T110ED Ⓢ		
	0.98 in (30 mm)	Unshielded (PNP)	2-meter cable	E53KAL30T111E	E53KBL30T111E			
			4-pin micro DC connector	E53KAL30T111ED Ⓢ	E53KBL30T111ED Ⓢ			

Note

Ⓢ See listing of compatible connector cables on **Page V8-T4-8**.

Compatible Connector Cables

Micro-Style
Straight Female



Standard Cables ^{①②}

Current Rating at 600V	Voltage Style	Number of Pins	Gauge	Length	Pin Configuration/Wire Colors (Face View Female Shown)	Catalog Number
Micro-Style, Straight Female						
13A	Vac	3-pin, 3-wire	22 AWG	6 ft (2m)	1-Green 2-Red/Black 3-Red/White	CSAS3F3CY2202
10A	Vdc	4-pin, 3-wire	22 AWG	6 ft (2m)	1-Brown 2-No Wire 3-Blue 4-Black	CSDS4A3CY2202
		4-pin, 4-wire	22 AWG	6 ft (2m)	1-Brown 2-White 3-Blue 4-Black	CSDS4A4CY2202

Technical Data and Specifications

Threaded Body Sensors

Description	AC Models	DC Models
AC residual	2.5 mA maximum	—
Maximum load current	300 mA	300 mA
Switching rate	15 operations per second	250 operations per second
Circuit protection	—	Short circuit and reverse polarity
Output indicator LED	Lights when output is ON	Lights when output is ON
Ambient temperature range	-13° to 158°F (-25° to 70°C)	-13° to 158°F (-25° to 70°C)
Enclosure ratings	NEMA 1, 2, 3, 3S, 4, 12, 13 (IEC IP65)	NEMA 1, 2, 3, 3S, 4, 12, 13 (IEC IP65)
Sensitivity adjustment	Included	Included
Housing material	Polyoxymethylene (POM) plastic mounting nuts molded of nylon 66 (PA66)	Polyoxymethylene (POM) Plastic mounting nuts molded of nylon 66 (PA66)

Notes

- ① For a full selection of connector cables, see **Tab 10, section 10.1**.
- ② Use four-wire connector cable on NC output versions.

Wiring Diagrams

Pin numbers are for reference, rely on pin location when wiring.

Threaded Body Sensors

Operating Voltage	Output	Cable Models	Micro-Connector Models (Face View Male Shown)
Two-Wire Sensors			
20–250 Vac	NO and NC		
Three-Wire Sensors			
10–30 Vdc	NO (NPN)		
	NO (PNP)		—
	NC (NPN)		
	NC (PNP)		

Dimensions

Approximate Dimensions in mm

18 mm Diameter Threaded Body Sensor

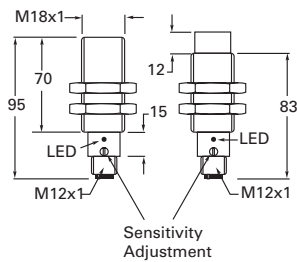

30 mm Diameter Threaded Body Sensor

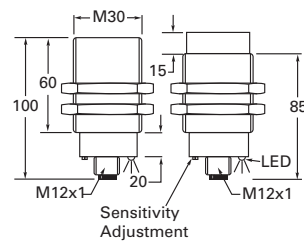

18 and 30 mm Cable

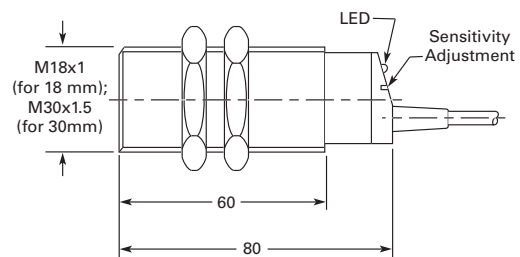

Smooth Body Sensors

4



Contents

Description

Page

Smooth Body Sensors	
Product Selection	
E53 Smooth Body Sensors	V8-T4-11
Compatible Connector Cables	V8-T4-11
Technical Data and Specifications	V8-T4-12
Wiring Diagrams	V8-T4-12
Dimensions	V8-T4-12

Smooth Body Sensors

Product Description

Type E53 Capacitive Proximity Sensors from Eaton’s electrical sector are self-contained devices designed to detect both metallic and nonmetallic targets. They are ideally suited for liquid level control and for sensing powdered or granulated material. For best operation, they should be used in an environment having relatively constant temperature and humidity.

Features

- Detect liquids, powders and other materials that are difficult or impossible to detect with other sensor types
- Plastic body is corrosion resistant
- Sensitivity adjustment

DANGER

THIS SENSOR IS NOT A SAFETY DEVICE AND IS NOT INTENDED TO BE USED AS A SAFETY DEVICE. This sensor is designed only to detect and read certain data in an electronic manner and perform no use apart from that, specifically no safety-related use. This sensor product does not include self-checking redundant circuitry, and the failure of this sensor product could cause either an energized or de-energized output condition, which could result in death, serious bodily injury, or property damage.

For the most current information on this product, visit our Web site: www.eaton.com

For Customer Service in the U.S. call 1-877-ETN CARE (386-2273), in Canada call 1-800-268-3578.
For Application Assistance in the U.S. and Canada call 1-800-426-9184.

Product Selection

E53 Smooth Body Sensors

Two-Wire Sensors



	Operating Voltage	Sensing Range (Sn)	Shielding	Connection Type	NO Output Catalog Number	NC Output Catalog Number
34 mm Diameter 	34 mm Diameter ①					
	20–250 Vac	1.38 in (35 mm)	Unshielded	2-meter cable	E53KAL34A2E	E53KBL34A2E
				3-pin micro AC connector	E53KAL34A2EA ⊕	E53KBL34A2EA ⊕

Three-Wire Sensors

	Operating Voltage	Sensing Range (Sn)	Shielding	Connection Type	NO Output Catalog Number	NC Output Catalog Number	
34 mm Diameter 	34 mm Diameter ①						
	10–30 Vdc	0.98in (25 mm)	Shielded (NPN)	2-meter cable	E53KAL34T110	E53KBL34T110	
				4-pin micro DC connector	E53KAL34T110SD ⊕	E53KBL34T110SD ⊕	
			Shielded (PNP)	2-meter cable	E53KAL34T111	E53KBL34T111	
				4-pin micro DC connector	E53KAL34T111SD ⊕	E53KBL34T111SD ⊕	
			1.38 in (35 mm)	Unshielded (NPN)	2-meter cable	E53KAL34T110E	E53KBL34T110E
					4-pin micro DC connector	E53KAL34T110ED ⊕	E53KBL34T110ED ⊕
	Unshielded (PNP)	2-meter cable	E53KAL34T111E	E53KBL34T111E			
4-pin micro DC connector		E53KAL34T111ED ⊕	E53KBL34T111ED ⊕				

Compatible Connector Cables

Standard Cables ②

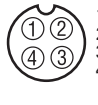
Micro-Style Straight Female 	Current Rating at 600V	Voltage Style	Number of Pins	Gauge	Length	Pin Configuration/Wire Colors (Face View Female Shown)	Catalog Number						
Micro-Style, Straight Female													
13A	AC	3-pin, 4-wire	22 AWG	6 ft (2m)		1-Green 2-Red/Black 3-Red/White	CSAS3F3CY2202						
						10A	DC	4-pin, 3-wire	22 AWG	6 ft (2m)		1-Brown 2-No Wire 3-Blue 4-Black	CSDS4A3CY2202
												4-pin, 4-wire	22 AWG

Notes

- ⊕ ⊕ See listing of compatible connector cables above.
- ① Includes mounting bracket.
- ② For a full selection of connector cables, see **Tab 10, section 10.1**.

Technical Data and Specifications

Smooth Body Sensors

Description	AC Models	DC Models
Residual current	2.5 mA maximum	—
Maximum load current	300 mA	300 mA
Switching rate	15 operations per second	250 operations per second
Circuit protection	—	Short circuit and reverse polarity
Output indicator LED	Lights when output is ON	Lights when output is ON
Ambient temperature range	-13° to 158°F (-25° to 70°C)	-13° to 158°F (-25° to 70°C)
Enclosure ratings	NEMA 1, 2, 3, 3S, 4, 12, 13 (IEC IP65)	NEMA 1, 2, 3, 3S, 4, 12, 13 (IEC IP65)
Sensitivity adjustment	Included	Included

Wiring Diagrams

Pin numbers are for reference, rely on pin location when wiring.

Smooth Body Sensors

Operating Voltage	Output	Cable Models	Micro-Connector Models (Face View Male Shown)
Two-Wire Sensors			
20–250 Vac	NO and NC		
Three-Wire Sensors			
10–30 Vdc	NO (NPN)		
	NO (PNP)		
	NC (NPN)		
	NC (PNP)		

Dimensions

Approximate Dimensions in mm

34 mm Diameter Smooth Body Sensor

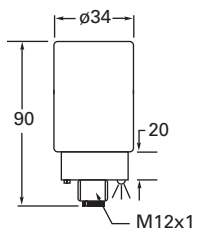

Mounting Bracket (Included with Sensor)

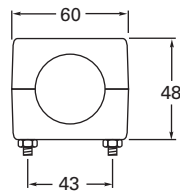

34 mm Cable

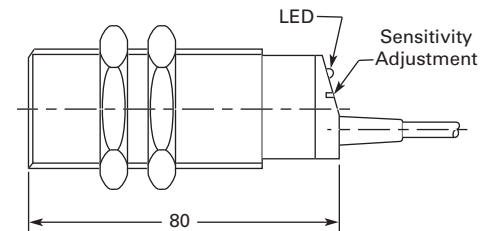

Enhanced 50 Series Sensors



NanoView Series Sensors



SM Series Sensors



5.0 Introduction

Quick Reference Guide	V8-T5-2
Technical Reference	V8-T5-4
Product Selection Guide	V8-T5-6

5.1 Enhanced 50 Series Sensors

Product Description	V8-T5-9
Product Selection	V8-T5-10

5.2 NanoView Series Sensors

Product Description	V8-T5-27
Product Selection	V8-T5-28

5.3 IntelliView Series Sensors

Product Description	V8-T5-33
Product Selection	V8-T5-34

5.4 SM Series Sensors

Product Description	V8-T5-48
Product Selection	V8-T5-50

5.5 Comet Series Sensors

Product Description	V8-T5-54
Product Selection	V8-T5-56

5.6 Prism Series Sensors

Product Description	V8-T5-69
Product Selection	V8-T5-70

5.7 OEM Prism Series Sensors

Product Description	V8-T5-78
Product Selection	V8-T5-79

5.8 E58 Harsh Duty Series Sensors

Product Description	V8-T5-84
Product Selection	V8-T5-86

5.9 E67 Long Range Perfect Prox Series Sensors

Product Description	V8-T5-93
Product Selection	V8-T5-94

5.10 E51 Limit Switch Style, Modular Sensors

Product Description	V8-T5-97
Product Selection	V8-T5-98



Unless otherwise noted, the products contained in this section should not be used for functional safety applications. These products were not designed or tested to IEC 60947-5-3 or recommended for functional safety.

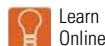

For Customer Service in the U.S. call 1-877-ETN CARE (386-2273),
in Canada call 1-800-268-3578.
For Application Assistance in the U.S. and Canada
call 1-800-426-9184.

Quick Reference Guide

Photoelectric Sensors

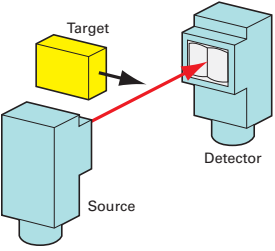
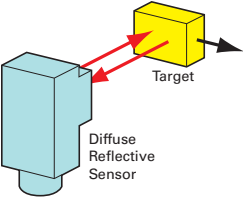
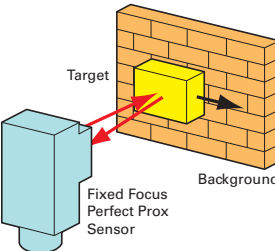
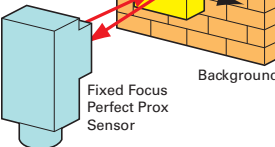
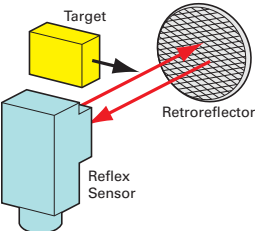
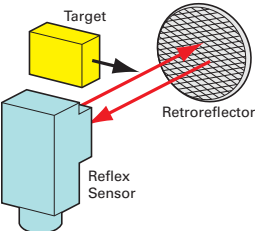
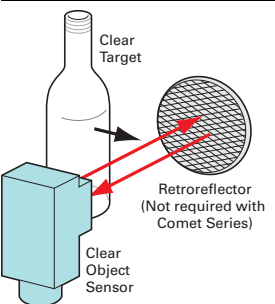
Sensing Application	Sensing Style	Maximum Range	Product Family	Page
	Through beam	500 ft (152m)	Enhanced 50 Series Sensors	V8-T5-9
		50 ft (15m)	SM Series Sensors	V8-T5-48
		80 ft (24m)	Comet® Series Sensors	V8-T5-54
		20 ft (6m)	Prism™ Series Sensors	V8-T5-69
		800 ft (250m)	E58 Harsh Duty Series Sensors	V8-T5-84
		19 ft (6m)	NanoView Series Sensors	V8-T5-27
	Diffuse reflective	10 ft (3m)	Enhanced 50 Series Sensors	V8-T5-9
		2 ft (610 mm)	Comet Series Sensors	V8-T5-54
		8 in (200 mm)	SM Series Sensors	V8-T5-48
		8 in (200 mm)	Prism Series Sensors	V8-T5-69
		13.8 in (350 mm)	NanoView Series Sensors	V8-T5-27
	Fixed Focus Perfect Prox®	4 in (50 mm)	SM Series Sensors	V8-T5-48
		9 in (225 mm)	Comet Series Sensors	V8-T5-54
		11 in (280 mm)	E58 Harsh Duty Series Sensors	V8-T5-84
		79 in (200 cm)	E67 Long Range Perfect Prox Series Sensors	V8-T5-93
		3.9 in (100 mm)	NanoView Series Sensors	V8-T5-27
	Background suppression	47.2 in (120 cm)	IntelliView Series Sensors	V8-T5-33
	Standard reflex	30 ft (9m)	Enhanced 50 Series Sensors	V8-T5-9
		25 ft (7.6m)	Comet Series Sensors	V8-T5-54
		15 ft (4.5m)	Prism Series Sensors	V8-T5-69
		59 ft (18m)	E58 Harsh Duty Series Sensors	V8-T5-84
	Polarized reflex	16 ft (4.9m)	Enhanced 50 Series Sensors	V8-T5-9
		15 ft (4.5m)	Comet Series Sensors	V8-T5-54
		10 ft (3m)	SM Series Sensors	V8-T5-48
		34 ft (10m)	E58 Harsh Duty Series Sensors	V8-T5-84
		8.2 ft (2.5m)	NanoView Series Sensors	V8-T5-27
	Clear object detector	45 in (120 cm)	Enhanced 50 Series Sensors	V8-T5-9
		31.5 in (80 cm)	NanoView Series Sensors	V8-T5-27
		6 in (150 mm)	Comet Series Sensors (wide-angle)	V8-T5-54

Photoelectric Sensors, continued

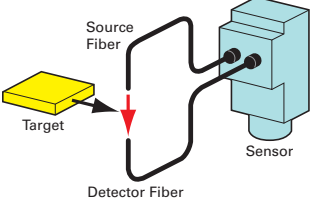
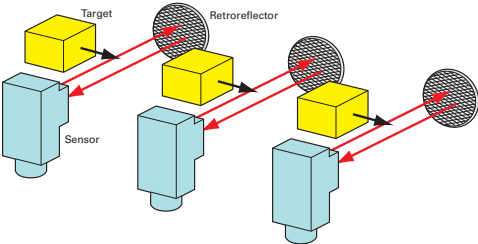
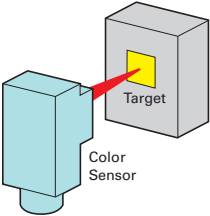
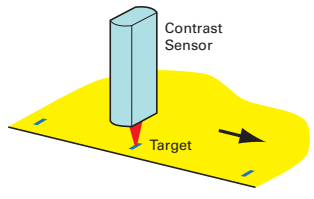
Sensing Application	Sensing Style	Maximum Range	Product Family	Page
	Fiber optic infrared LED glass cable	Depends on fiber selected	Enhanced 50 Series Sensors	V8-T5-9
	Fiber optic visible LED plastic cable	Depends on fiber selected	Comet Series Sensors	V8-T5-54
	Fiber optic infrared LED glass cable	Depends on fiber selected	Enhanced 50 Series Sensors	V8-T5-9
	Fiber optic visible LED plastic cable	Depends on fiber selected	Comet Series Sensors	V8-T5-54
	Conveyor sensor system	10 ft (3m)	E68 Series Integral Sensor Valve	V8-T6-3
		10 ft (3m)	200 Series Zero Pressure Accumulation	V8-T6-14
	Color sensing	1.77 in (45 mm)	IntelliView Series Sensors	V8-T5-33
	Contrast sensing	0.39 in (10 mm)	IntelliView Series Sensors	V8-T5-33

Technical Reference

Photoelectric Sensors

5



Introduction

Photoelectric sensors use light to detect the presence or absence of an object. The main advantages of photoelectric sensors are noncontact sensing of objects and greatly extended sensing ranges.

Choosing the Right Sensor

There are many factors to consider when choosing a photoelectric sensor. The specific demands of your application will dictate the sensor required for the job. Some of the questions you should consider, and suggested areas to find more information:

- What range is required (how far is the sensor from the object to be detected)? (See "Modes of Detection," "Range" and "Excess Gain")
- What is the nature of the environment? (See "Contamination")
- What access do you have to both sides of the object to be detected (is wiring possible on one or both sides of the object)? (See "Modes of Detection")
- What size is the object being detected? (See "Modes of Detection")
- Is the object consistent in size, shape, and reflectivity? (See "Modes of Detection, Perfect Prox")
- What are the mechanical and electrical requirements? (Check the electrical specifications of the desired sensor)
- What kind of output do you need? (Check the electrical specifications of the desired sensor)
- Are logic functions needed at the sensing point? (If so, look for sensors with logic modules or built-in logic functions)

Modes of Detection

Thru-Beam

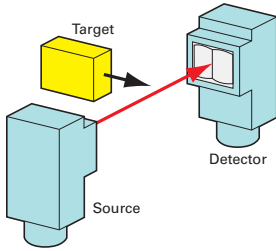

Source and detector elements are mounted in separate housings and aligned facing each other across an area which the target object crosses. Detection occurs when an object blocks the entire effective beam (the column of light that travels in a straight line between lenses). See **Page V8-T12-27**.

Reflex

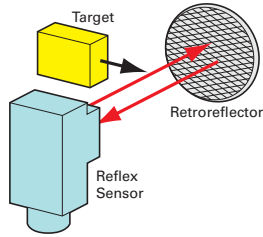

The source and detector are mounted in a single sensor housing and are positioned parallel to one another on the same side of the object to be detected. The light beam is transmitted from the source to a retroreflector that returns the light to the detector. Detection occurs when the target object blocks the entire effective beam. See **Page V8-T12-28**.

Diffuse Reflective

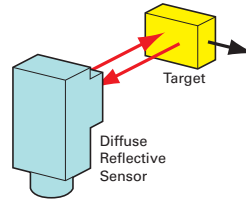

The source and detector elements are mounted in a single sensor housing and are positioned on the same side of the object to be detected and aligned with crossed fields of view. When the target moves into this area light from the source is reflected off the target surface back to the detector and detection occurs. See **Page V8-T12-28**.

Perfect Prox

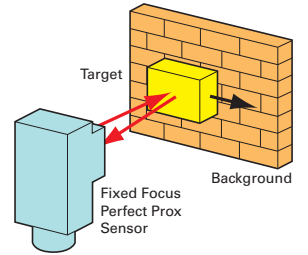

Perfect Prox is a special type of diffuse reflective sensor that combines extremely high sensing power (excess gain) with a sharp optical cutoff. This allows the sensor to reliably detect targets regardless of variations in color, reflectance, contrast or surface shape, while ignoring background objects that are just slightly beyond the target range. See **Page V8-T12-28**.

Reflex Detection Mode

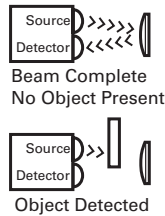

Diffuse Reflective Detection Mode

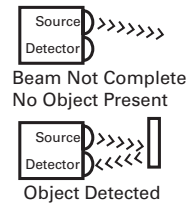

Range

Each sensor listed in this catalog has a specific operating range. In general, thru-beam sensors offer the greatest range (most power), followed by reflex and then diffuse reflective sensors. Operating ranges vary, and there is some overlap among types and models. See Applying Excess Gain on **Page V8-T12-30**.

Excess Gain

Excess gain is a measure of the sensing power available in excess of that required to detect an object. The following excess gain chart shows this measurement graphically. Find your required range on the x-axis of the graph. Then move up to the

curve to read the excess gain value from the y-axis. An excess gain value of 1 is the minimum level required for sensor operation. Eaton normally recommends excess gain levels ≥ 10 for reliable sensor operation. See **Page V8-T12-30**.

Photoelectric Sensor Excess Gain Graph

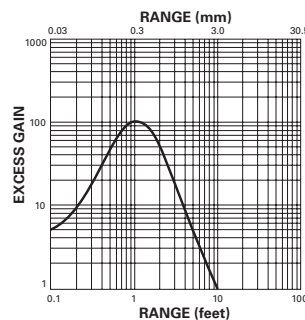

Note: The excess gain charts in this catalog represent the minimum excess gain provided by the sensor (unless otherwise noted). Actual performance may be better.

Contamination

The chart on **Page V8-T12-32** shows the excess gain recommended in environments with varying levels of contamination for each sensing mode.

Product Selection Guide

Enhanced 50 Series Sensors



Page V8-T5-9

Overview

The Enhanced 50 Series family provides outstanding optical performance and application flexibility in a self-contained, industry-standard package.

Sensing Types and Ranges

Thru-beam: 200 and 500 ft
 Reflex: 30 ft
 Polarized reflex: 16 ft
 Diffuse reflective: 5 and 10 ft
 Clear object detector: 45 in
 Infrared fiber optic: range varies with fiber
 Visible fiber optic: range varies with fiber

Product Features

High optical performance including 10 ft diffuse and 500 ft thru-beam versions
 Output options include a high-current 10 Amp SPDT relay
 Built-in light/dark selection on all models
 Logic options include ON-delay, OFF-delay and one-shot delay
 Multiple connector and cable options
 Industry standard package size

Technical Data and Specifications

Operating voltage—
 24–240 Vac and 12–240 Vdc; 10–40 Vdc
 Output function—
 Selectable light or dark operate
 Maximum load current—
 DC units: 250 mA
 AC/DC units: 300 mA to 10A
 Enclosure ratings—
 IP67, IP69K
 Response time range—
 DC operation: 2 ms
 AC operation: 15 ms

Approvals

CSA® Approved
 Certified to UL® Standard, UL 508
 CE



NanoView Series Sensors



Page V8-T5-27

Overview

The NanoView™ Series from Eaton is a family of miniature rectangular photoelectric sensors designed for optimum value and sensing performance in a wide range of applications.

Sensing Types and Ranges

Thru-beam: 20 ft
 Polarized reflex: 8.2 ft
 Diffuse reflective: 13 in
 Fixed focus diffuse: 4 in
 Clear object detector: 2.6 ft

Product Features

Less than 1.5 in long and half an in deep
 Fixed focus diffuse models sense very small targets at a 4-in focal point
 Clear object detection models are ideal for sensing plastic bottles, molds, cartons, films and glass objects

Technical Data and Specifications

Input voltage—
 10–30 Vdc
 Output saturation voltage—
 2V max.
 Enclosure ratings—
 Thru-beam: IP67
 Polarized reflex: IP66
 Diffuse reflective: IP66
 Fixed focus diffuse: IP67
 Clear object detector: IP66
 Response time range—
 1 ms max.

Approvals

UL Listed
 cUL® Listed
 CE



IntelliView Series Sensors



Page V8-T5-33

Overview

The IntelliView™ Series from Eaton is a family of compact, high performance specialty photoelectric sensors designed to solve a wide array of sensing challenges.

Sensing Types and Ranges

Foreground/background suppression
 Distance sensing
 Color, contrast, luminescence, and grayscale sensing

Product Features

Sensing technologies for detecting color, contrast, luminescence and distance—
 with great accuracy
 Available in either compact rectangular or flat-tubular package sizes
 Most models include a teach mode, allowing for quick and simple installation and setup
 For the first time, Eaton offers a fully field-adjustable background suppression photoelectric sensor capable of detecting targets as far as 3.9 ft (47 in) away

Technical Data and Specifications

Input voltage—
 Foreground models: 10–30 Vdc
 Distance models: 16–28 Vdc
 Output saturation voltage—
 All models: < 2V max.
 Enclosure ratings—
 Foreground models:
 E75-PPA_: IP65
 E75-PP1_: IP67
 Distance models: IP67
 Response time range—
 Varies by model

Approvals

UL Listed
 cUL Listed
 CE



SM Series Sensors



Page V8-T5-48

Overview

SM Series photoelectric sensors provide high performance and ease of use in an economical, compact package.

Sensing Types and Ranges

Thru-beam: 50 ft
 Polarized reflex: 10 ft
 Diffuse reflective: 8 in
 Perfect Prox background rejection: 2 and 4 in

Product Features

Highly visible LED indicators for power, output and alignment (TargetLock™)
 TargetLock™ simplifies setup and ensures that the sensor operates at the highest level of reliability possible
 Perfect Prox models sense different colored targets at the same range and ignore objects in the background
 Visible beam on all models lets you see exactly where the sensor is pointing
 Small size
 Reverse polarity, overload and short circuit protection on all models

Technical Data and Specifications

Operating voltage—
 18–264 Vac and 18–50 Vdc; 10–30 Vdc
 Output function—
 Light and dark operate models available
 Maximum load current—
 AC/DC units—200 mA
 DC units—100 mA (NPN or PNP)
 Enclosure ratings—
 NEMA® 1, 3, 4, 4X, 6, 6P, 12 and 13
 IP68, IP69K
 Response time range—
 DC operation: 1 ms
 AC operation: 16 ms

Approvals

UL Listed
 cUL Listed
 CE



Comet Series Sensors



Page V8-T5-54

Overview

This high performance, 18 mm tubular sensor family features a wide variety of models in all sensing modes to solve all of your sensing problems.

Sensing Types and Ranges

Thru-beam: 20 and 80 ft
 Reflex: 25 ft
 Polarized reflex: 15 and 10 ft
 Diffuse reflective: 8 and 24 in
 Focused diffuse reflective: 1.6 in
 See **Page V8-T5-54** for wide angle diffuse and Perfect Prox information

Product Features

The 18 mm tubular body has flat sides for added mounting flexibility
 Available in universal voltage AC/DC versions as well as DC only models
 Short circuit protection on all models
 RIM (Reaction Injection Molding) process completely encapsulates circuits and produces a rugged package

Technical Data and Specifications

Operating voltage—
 90–132 Vac and 18–50 Vdc
 20–264 Vac and 15–30 Vdc; 10–30 Vdc
 Output function—
 Selectable light or dark operate
 Maximum load current—
 AC/DC units—300 mA
 DC units—250 mA (NPN), 100 mA (PNP)
 Enclosure ratings—
 NEMA 1, 2, 3, 4, 4X, 6, 12, 13 and IP69K
 Response time range—
 DC operation: 1 ms/AC operation: 10 ms
 2W AC/DC operation: 32 ms

Approvals

UL Recognized
 cUL Recognized
 CE



Prism Series Sensors



Page V8-T5-69

Overview

Prism is a cost-effective line of 18 mm tubular photoelectric sensors with twice the optical gain of other sensors in this product class.

Sensing Types and Ranges

Thru-beam: 20 ft
 Reflex: 15 ft
 Polarized reflex: 10 ft
 Diffuse reflective: 8 in
 Glass fiber optic: range varies with fiber

Product Features

Isolated output simplifies wiring and allows each sensor to switch AC or DC loads, sink or source
 Forward or right angle viewing units have identical optical performance
 The 18 mm tubular body has flat sides for added mounting flexibility
 Short circuit protection for loads less than 32 Vac or Vdc
 High noise immunity
 AC/DC and DC-only versions available

Technical Data and Specifications

Operating voltage—
 20–132 Vac and 15–30 Vdc; 10–30 Vdc
 Output function—
 Isolated VMOS solid-state relay output
 Light and dark operate models available
 Maximum load current—
 80 mA AC load
 110 mA at 132 Vdc
 Enclosure ratings—
 NEMA 1, 2, 3, 4, 4X, 6, 12 and 13
 Response time range—
 3 ms

Approvals

UL Recognized
 cUL Recognized
 CE



OEM Prism Series Sensors



Page V8-T5-78

Overview

OEM Prism Sensors are similar to our standard cost-effective Prism family and are optimized for high volume OEM use.

Sensing Types and Ranges

Polarized reflex: 10 ft
 Diffuse reflective: 8 and 24 in

Product Features

The 18 mm tubular body has flat sides for added mounting flexibility
 Forward or right angle viewing units have identical optical performance
 Sensors are shipped bulk-packaged for the convenience of high volume users
 Dual discrete outputs for simple wiring
 All models 10–30 Vdc only to meet the evolving needs of your customers

Technical Data and Specifications

Operating voltage—
 10–30 Vdc
 Output function—
 Light and dark operate models available
 Maximum load current—
 100 mA
 Enclosure ratings—
 NEMA 1, 2, 3, 4, 4X, 6, 12 and 13
 Response time range—
 1.2 ms

Approvals

CE



E58 Harsh Duty Series Sensors



Page V8-T5-84

Overview

E58 Harsh Duty Photoelectric Sensors were designed to withstand your harshest physical, chemical and optical environments, 18 and 30 mm tubular enclosures.

Sensing Types and Ranges

Thru-beam: 800 ft
 Reflex: 59 ft
 Polarized reflex: 34 ft
 Perfect Prox background rejection: 2, 4, 6 and 11 in

Product Features

Designed to be the most rugged photoelectric sensor available
 Perfect Prox background rejection technology for unmatched optical performance
 Output status indicator is the brightest available and is visible from any angle and in any lighting condition
 Available in universal voltage AC/DC versions as well as DC only models
 18 mm and 30 mm models available

Technical Data and Specifications

Operating voltage—
 See **Page V8-T5-84** for more information
 Output function—
 Light and dark operate models available
 Maximum load current—
 AC/DC units—300 mA (100 mA for 18 mm diameter units)
 DC units—250 mA (NPN), 100 mA (PNP)
 Enclosure ratings—
 NEMA 1, 2, 3, 3R, 3S, 4, 4X, 6, 6P, 12, 12K, 13 and IP69K
 Response time range—
 2 ms to 35 ms

Approvals

UL Listed
 cUL Listed



E67 Long Range Perfect Prox Series Sensors



Page V8-T5-93

Overview

This is the highest performance long-range sensor you can buy with background rejection.

Sensing Types and Ranges

Perfect Prox 24 to 96 in
Standard model pre-set at 6 ft. Fixed ranges of 2–8 ft are available.

Product Features

Extended sensing ranges (up to 8 ft) available with background rejection technology
No user adjustments required
Dual indicators communicate both output and power status from easy-to-see location on the top of the sensor
AC/DC models offer isolated contact output for wiring flexibility
DC sensors offer both NPN and PNP output
Two mounting options for maximum flexibility

Technical Data and Specifications

Operating voltage—
18–30 Vdc and 20–132 Vac/dc
Output function—
NPN and PNP (DC)
Solid-state relay, 1500V isolation (AC/DC)
Light and dark operate models available
Maximum load current—
100 mA DC
75 mA AC/DC
Enclosure ratings—
NEMA 1, 2, 3, 4, 4X, 6, 12 and 13
Response time range—
50 ms (AC/DC) and 15 ms (DC)

Approvals

—

E51 Limit Switch Style, Modular Sensors



Page V8-T5-97

Overview

This versatile sensing family features modular construction, a variety of operating modes and a familiar limit switch style housing.

Sensing Types and Ranges

Thru-beam: 300 ft
Reflex: 18 and 35 ft
Polarized reflex: 15 ft
Diffuse reflective: 8, 18 and 40 in
Glass fiber optic: range varies with fiber

Product Features

Modular construction consisting of a head, sensor body and receptacle
Most E51 photoelectric and inductive heads are interchangeable on all E51 sensor bodies for substantial inventory reduction
Same general configurations and dimensions as the E50 limit switch
Order as complete assemblies or components for stocking and manufacturing flexibility
Keyed, for directional head positioning

Technical Data and Specifications

Operating voltage—
20–264 Vac/dc; 120 Vac; 10–30 Vdc
Output function—
NO or NC (programmable); or NO and NC (complementary) sensor bodies are available
Maximum load current—
AC—1.0A continuous
DC—0.6A continuous
Enclosure ratings—
NEMA 3, 3S, 4, 4X, 6, 6P and 13
Class I, II, III, Division 2, Groups A, B, C, D, F and G (conduit entry only)
Response time range—
1 ms to 30 ms

Approvals

UL Listed
CSA Certified
CE (where shown)



Listed

Legacy Sensor Products

See **Tab 11** for product information and ordering information for these legacy products:

- E58 18 mm Tubular Series
- E64 Terminal Base Series
- E65 Miniature Series
- 11 Series
- 20 Series
- 50 Series
- 55 Series
- 60 Series
- 70 Series
- 80 Series

Enhanced 50 Series Sensors



Enhanced 50 Series Sensors

Product Description

The new Enhanced versions of the 50 Series™ Photoelectric Sensors from Eaton's Electrical Sector offer flexibility, durability and high optical performance in a cost-effective self-contained package. Choose from three output types, four time delay functions, six sensing modes and four connection styles to tailor the sensor to exactly meet your needs.

Sensors are available in thru-beam, reflex, polarized reflex, diffuse reflective, clear object, and fiber optic sensing modes. Brackets are available for easy mounting and to allow precise adjustment of sensor alignment.

Features

- High optical performance models including a 500 ft (152m) thru-beam and a 10 ft (3m) diffuse reflective unit
- Output options include a 3 Amp SPDT relay
- All units offer light/dark selection
- Logic options include ON-delay, OFF-delay, ON/OFF-delay and one-shot delay
- Fiber optic sensors operate in thru-beam or diffuse reflective mode depending on the fiber optic cable selected
- Fully potted construction for use in areas subject to washdown, high shock and/or vibration
- Choice of pre-wired power cable, built-in mini-connector, built-in micro-connector and pigtail micro-connector versions. Standard pre-wired cable length is 6 ft (2m)
- Variety of brackets available including ball swivel

Contents

Description

	<i>Page</i>
Enhanced 50 Series Sensors	
Product Selection	
Thru-Beam Sensors	V8-T5-10
Reflex Sensors	V8-T5-12
Diffuse Sensors	V8-T5-14
Clear Object Sensors	V8-T5-16
Fiber Optic Sensors	V8-T5-17
Compatible Connector Cables	V8-T5-19
Fiber Optic Cables	V8-T5-20
Accessories	V8-T5-21
Technical Data and Specifications	V8-T5-21
Excess Gain	V8-T5-22
Wiring Diagrams	V8-T5-23
Dimensions	V8-T5-24

Standards and Certifications

- CSA Approved
- Certified to UL Standard, UL 508



⚠ DANGER

THIS SENSOR IS NOT A SAFETY DEVICE AND IS NOT INTENDED TO BE USED AS A SAFETY DEVICE. This sensor is designed only to detect and read certain data in an electronic manner and perform no use apart from that, specifically no safety-related use. This sensor product does not include self-checking redundant circuitry, and the failure of this sensor product could cause either an energized or de-energized output condition, which could result in death, serious bodily injury, or property damage.

For the most current information on this product, visit our Web site: www.eaton.com

For Customer Service in the U.S. call 1-877-ETN CARE (386-2273), in Canada call 1-800-268-3578. For Application Assistance in the U.S. and Canada call 1-800-426-9184.

Product Selection Guide

Connection Options

Cable Version



Mini QD (Body)



Micro or Euro (Micro) QD (Body)



Micro or Euro (Micro) QD (Pigtail)



5

Product Selection

Thru-Beam Sensors

Field of View: 2.4°



Thru-Beam Standard Range ①②

Voltage Range	Sensing Range	Optimum Range	Sensing Beam	Thru-Beam Component	Output Type	Time Delay	Connection Type	Catalog Number	
10–40 Vdc	200 ft (61m)	0.1 to 100 ft (0.03 to 31m)	Infrared	Source	N/A	N/A	6 ft cable	1150E-6517	
				Detector	NPN/PNP 250 mA	no		1250E-6517	
						yes		1250E-8517	
				Source	N/A	N/A	4-pin Euro (micro) connector	1150E-6547 ☹	
								Detector	NPN/PNP 250 mA
				yes	1250E-8547 ☹				
				Source	N/A	N/A		4-pin Euro (micro) connector (pigtail)	1150E-6537 ☹
									Detector
				yes	1250E-8537 ☹				
				Source	N/A	N/A	4-pin mini-connector		1150E-6507 ☹
									Detector
				yes	1250E-8507 ☹				
12–240 Vdc 24–240 Vac	200 ft (61m)	0.1 to 100 ft (0.03 to 31m)	Infrared	Source	N/A	N/A		6 ft cable	1150E-6513
				Detector	Isolated output solid-state relay 300 mA at 240 Vac/dc	no			1250E-6513
						yes			1250E-8513
				Source	N/A	N/A	4-pin micro-connector	1150E-6534 ☹	
								Detector	Isolated output solid-state relay 300 mA at 240 Vac/dc
				yes	1250E-8534 ☹				
				Source	N/A	N/A		4-pin micro-connector (pigtail)	1150E-6534 ☹
									Detector
				yes	1250E-8533 ☹				
				Source	N/A	N/A	5-pin micro-connector (pigtail)		1250E-6534 ☹
									Detector
				yes	1250E-8534 ☹				
Source	N/A	N/A	4-pin mini-connector	1150E-6504 ☹					
				Detector	Isolated output solid-state relay 300 mA at 240 Vac/dc	no		1250E-6503 ☹	
yes	1250E-8503 ☹								
Source	N/A	N/A		5-pin mini-connector	1250E-6504 ☹				
					Detector	SPDT EM relay 3A at 120 Vac	no	1250E-8504 ☹	
yes	1250E-8504 ☹								

Notes

☹☹ See listing of compatible connector cables on **Page V8-T5-19**.

① For a complete system, order one sensor and one detector.

② For brackets compatible with these sensors, see Accessories on **Page V8-T5-21**.

Field of View: 2.4°



Thru-Beam Extended Range ①②

Voltage Range	Sensing Range	Optimum Range	Sensing Beam	Thru-Beam Component	Output Type	Time Delay	Connection Type	Catalog Number					
10–40 Vdc	500 ft (152m)	0.1 to 250 ft (0.03 to 77m)	Infrared	Source	N/A	N/A	6 ft cable	1151E-6517					
				Detector	NPN/PNP 250 mA	no		1251E-6517					
						yes		1251E-8517					
				Source	N/A	N/A		4-pin Euro (micro) connector	1151E-6547 ☹				
				Detector	NPN/PNP 250 mA	no			1251E-6547 ☹				
						yes			1251E-8547 ☹				
				Source	N/A	N/A	4-pin Euro (micro) connector (pigtail)		1151E-6537 ☹				
				Detector	NPN/PNP 250 mA	no			1251E-6537 ☹				
						yes			1251E-8537 ☹				
				Source	N/A	N/A		4-pin mini-connector	1151E-6507 ☹				
				Detector	NPN/PNP 250 mA	no			1251E-6507 ☹				
						yes			1251E-8507 ☹				
				12–240 Vdc 24–240 Vac	500 ft (152m)	0.1 to 250 ft (0.03 to 77m)	Infrared		Source	N/A	N/A	6 ft cable	1151E-6513
									Detector	Isolated output solid-state relay 300 mA at 240 Vac/dc	no		1251E-6513
											yes		1251E-8513
								Detector	SPDT EM relay 3A at 120 Vac	no	1251E-6514		
										yes	1251E-8514		
								Source	N/A	N/A	4-pin micro-connector		1151E-6543 ☹
Detector	Isolated output solid-state relay 300 mA at 240 Vac/dc	no	1251E-6543 ☹										
		yes	1251E-8543 ☹										
Source	N/A	N/A	4-pin micro-connector (pigtail)					1151E-6534 ☹					
Detector	Isolated output solid-state relay 300 mA at 240 Vac/dc	no						1251E-6533 ☹					
		yes						1251E-8533 ☹					
Detector	SPDT EM relay 3A at 120 Vac	no						1251E-6534 ☹					
		yes						1251E-8534 ☹					
Source	N/A	N/A						4-pin mini-connector	1151E-6504 ☹				
Detector	Isolated output solid-state relay 300 mA at 240 Vac/dc	no	1251E-6503 ☹										
		yes	1251E-8503 ☹										
Detector	SPDT EM relay 3A at 120 Vac	no	1251E-6504 ☹										
		yes	1251E-8504 ☹										

Notes

☹☹ See listing of compatible connector cables on **Page V8-T5-19**.

① For a complete system, order one sensor and one detector.

② For brackets compatible with these sensors, see Accessories on **Page V8-T5-21**.

Reflex Sensors

Field of View: 1.0°



5

Standard Reflex ^{①②}

Voltage Range	Sensing Range ^③	Optimum Range ^③	Sensing Beam	Output Type	Time Delay	Connection Type	Catalog Number	
10–40 Vdc 24–240 Vac	30 ft (9m)	0.5 to 15 ft (0.2 to 4.6m)	Visible red	NPN/PNP 250 mA	no	6 ft cable	1450E-6517	
					yes		1450E-8517	
					no	4-pin Euro (micro) connector	1450E-6547 ☹	
					yes		1450E-8547 ☹	
					no	4-pin Euro (micro) connector (pigtail)	1450E-6537 ☹	
					yes		1450E-8537 ☹	
					no	4-pin mini-connector	1450E-6507 ☹	
					yes		1450E-8507 ☹	
					Isolated output solid-state relay 300 mA at 240 Vac/dc	no	6 ft cable	1450E-6513
						yes		1450E-8513
						no	4-pin micro-connector	1450E-6543 ☹
						yes		1450E-8543 ☹
						no	4-pin micro-connector (pigtail)	1450E-6533 ☹
						yes		1450E-8533 ☹
no	4-pin mini-connector	1450E-6503 ☹						
yes		1450E-8503 ☹						
SPDT EM relay 3A at 120 Vac	no	6 ft cable	1450E-6514					
	yes		1450E-8514					
	no	5-pin micro-connector (pigtail)	1450E-6534 ☹					
	yes		1450E-8534 ☹					
	no	5-pin mini-connector	1450E-6504 ☹					
	yes		1450E-8504 ☹					

Notes

☹☹ See listing of compatible connector cables on [Page V8-T5-19](#).① For a complete system, order one sensor and one retroreflector (see [Tab 8, section 8.1](#)).② For brackets compatible with these sensors, see Accessories on [Page V8-T5-21](#).

③ Ranges based on 3 in retroreflector for reflex sensors.

Field of View: 1.0°



Polarized Reflex ①②③

Voltage Range	Sensing Range ④	Optimum Range ④	Sensing Beam	Output Type	Time Delay	Connection Type	Catalog Number					
10–40 Vdc	16 ft (4.9m)	0.5 to 8 ft (0.2 to 2.5m)	Visible red	NPN/PNP 250 mA	no	6 ft cable	1451E-6517					
					yes		1451E-8517					
					no	4-pin Euro (micro) connector	1451E-6547 ☹️					
					yes		1451E-8547 ☹️					
					no	4-pin Euro (micro) connector (pigtail)	1451E-6537 ☹️					
					yes		1451E-8537 ☹️					
					no	4-pin mini-connector	1451E-6507 ☹️					
					yes		1451E-8507 ☹️					
					12–240 Vdc 24–240 Vac	16 ft (4.9m)	0.5 to 8 ft (0.2 to 2.5m)	Visible red	Isolated output solid-state relay 300 mA at 240 Vac/dc	no	6 ft cable	1451E-6513
										yes		1451E-8513
										no	4-pin micro-connector	1451E-6543 ☹️
										yes		1451E-8543 ☹️
no	4-pin micro-connector (pigtail)	1451E-6533 ☹️										
yes		1451E-8533 ☹️										
no	4-pin mini-connector	1451E-6503 ☹️										
yes		1451E-8503 ☹️										
SPDT EM relay 3A at 120 Vac	no	6 ft cable	1451E-6514									
	yes		1451E-8514									
	no	5-pin micro-connector (pigtail)	1451E-6534 ☹️									
	yes		1451E-8534 ☹️									
	no	5-pin mini-connector	1451E-6504 ☹️									
	yes		1451E-8504 ☹️									

Notes

- ☹️☹️ See listing of compatible connector cables on **Page V8-T5-19**.
- ① For a complete system, order one sensor and one retroreflector (see **Tab 8, section 8.1**).
- ② Polarized sensors may not operate with reflective tape. Test tape selection before installation.
- ③ For brackets compatible with these sensors, see Accessories on **Page V8-T5-21**.
- ④ Ranges based on 3 in retroreflector for reflex sensors.

Diffuse Sensors

Field of View: 2.8°



5

Diffuse Reflective ①

Voltage Range	Sensing Range ②	Optimum Range ②	Sensing Beam	Output Type	Time Delay	Connection Type	Catalog Number					
10–40 Vdc	5 ft (1.5m)	1 to 30 in (25 to 760 mm)	Infrared	NPN/PNP 250 mA	no	6 ft cable	1350E-6517					
					yes		1350E-8517					
					no	4-pin Euro (micro) connector	1350E-6547 ☹					
					yes		1350E-8547 ☹					
					no	4-pin Euro (micro) connector (pigtail)	1350E-6537 ☹					
					yes		1350E-8537 ☹					
					no	4-pin mini-connector	1350E-6507 ☹					
					yes		1350E-8507 ☹					
					12–240 Vdc 24–240 Vac	5 ft (1.5m)	1 to 30 in (25 to 760 mm)	Infrared	Isolated output solid-state relay 300 mA at 240 Vac/dc	no	6 ft cable	1350E-6513
										yes		1350E-8513
										no	4-pin micro-connector	1350E-6543 ☹
										yes		1350E-8543 ☹
										no	4-pin micro-connector (pigtail)	1350E-6533 ☹
										yes		1350E-8533 ☹
no	4-pin mini-connector	1350E-6503 ☹										
yes		1350E-8503 ☹										
SPDT EM relay 3A at 120 Vac	no	6 ft cable	1350E-6514									
	yes		1350E-8514									
	no	5-pin micro-connector (pigtail)	1350E-6534 ☹									
	yes		1350E-8534 ☹									
	no	5-pin mini-connector	1350E-6504 ☹									
	yes		1350E-8504 ☹									

Notes

☹☹ See listing of compatible connector cables on **Page V8-T5-19**.① For brackets compatible with these sensors, see Accessories on **Page V8-T5-21**.

② Ranges based on 90% reflectance white card for diffuse reflective sensors.

Field of View: 2.8°



Diffuse Reflective Extended Range ①

Voltage Range	Sensing Range ②	Optimum Range ②	Sensing Beam	Output Type	Time Delay	Connection Type	Catalog Number					
10–40 Vdc	10 ft (3m)	1 to 60 in (25 to 1520 mm)	Infrared	NPN/PNP 250 mA	no	6 ft cable	1351E-6517					
					yes		1351E-8517					
					no	4-pin Euro (micro) connector	1351E-6547 ☼					
					yes		1351E-8547 ☼					
					no	4-pin Euro (micro) connector (pigtail)	1351E-6537 ☼					
					yes		1351E-8537 ☼					
					no	4-pin mini-connector	1351E-6507 ☼					
					yes		1351E-8507 ☼					
					12–240 Vdc 24–240 Vac	10 ft (3m)	1 to 60 in (25 to 1520 mm)	Infrared	Isolated output solid-state relay 300 mA at 240 Vac/dc	no	6 ft cable	1351E-6513
										yes		1351E-8513
										no	4-pin micro-connector	1351E-6543 ☼
										yes		1351E-8543 ☼
no	4-pin micro-connector (pigtail)	1351E-6533 ☼										
yes		1351E-8533 ☼										
no	4-pin mini-connector	1351E-6503 ☼										
yes		1351E-8503 ☼										
SPDT EM relay 3A at 120 Vac										no	6 ft cable	1351E-6514
										yes		1351E-8514
										no	5-pin micro-connector (pigtail)	1351E-6534 ☼
										yes		1351E-8534 ☼
					no	5-pin mini-connector	1351E-6504 ☼					
					yes		1351E-8504 ☼					

Notes

☼☼ See listing of compatible connector cables on **Page V8-T5-19**.

① For brackets compatible with these sensors, see Accessories on **Page V8-T5-21**.

② Ranges based on 90% reflectance white card for diffuse reflective sensors.

Clear Object Sensors

Field of View: 0.68°

Clear Object Detector ^{①②}

Voltage Range	Sensing Range	Optimum Range	Sensing Beam	Output Type	Time Delay	Connection Type	Catalog Number					
10–40 Vdc	45 in (1.2m)	1 to 24 in (25 to 610 mm)	Visible red	NPN/PNP 250 mA	no	6 ft cable	1452E-6517					
					yes		1452E-8517					
					no	4-pin Euro (micro) connector	1452E-6547 ☹					
					yes		1452E-8547 ☹					
					no	4-pin Euro (micro) connector (pigtail)	1452E-6537 ☹					
					yes		1452E-8537 ☹					
					no	4-pin mini-connector	1452E-6507 ☹					
					yes		1452E-8507 ☹					
					12–240 Vdc 24–240 Vac	45 in (1.2m)	1 to 24 in (25 to 610 mm)	Visible red	Isolated output solid-state relay 300 mA at 240 Vac/dc	no	6 ft cable	1452E-6513
										yes		1452E-8513
										no	4-pin micro-connector	1452E-6543 ☹
										yes		1452E-8543 ☹
										no	4-pin micro-connector (pigtail)	1452E-6533 ☹
										yes		1452E-8533 ☹
no	4-pin mini-connector	1452E-6503 ☹										
yes		1452E-8503 ☹										
SPDT EM relay 3A at 120 Vac	no	6 ft cable	1452E-6514									
	yes		1452E-8514									
	no	5-pin micro-connector (pigtail)	1452E-6534 ☹									
	yes		1452E-8534 ☹									
	no	5-pin mini-connector	1452E-6504 ☹									
	yes		1452E-8504 ☹									

Notes

☹☹ See listing of compatible connector cables on **Pages V8-T5-19** and **V8-T5-20**.① For a complete system, order one sensor and one retroreflector (see **Tab 8, section 8.1**).② For brackets compatible with these sensors, see Accessories on **Page V8-T5-21**.

Fiber Optic Sensors

Field of View: ②③④



Fiber Optic Infrared ①

Voltage Range	Sensing Range	Optimum Range	Sensing Beam	Output Type	Time Delay	Connection Type	Catalog Number					
10–40 Vdc	Depends on fiber selected ⑤	Depends on fiber selected	Infrared	NPN/PNP 250 mA	no	6 ft cable	1550E-6517					
					yes		1550E-8517					
					no	4-pin Euro (micro) connector	1550E-6547 ☹					
					yes		1550E-8547 ☹					
					no	4-pin Euro (micro) connector (pigtail)	1550E-6537 ☹					
					yes		1550E-8537 ☹					
					no	4-pin mini-connector	1550E-6507 ☹					
					yes		1550E-8507 ☹					
					12–240 Vdc 24–240 Vac	Depends on fiber selected ⑤	Depends on fiber selected	Infrared	Isolated output solid-state relay 300 mA at 240 Vac/dc	no	6 ft cable	1550E-6513
										yes		1550E-8513
										no	4-pin micro-connector	1550E-6543 ☹
										yes		1550E-8543 ☹
no	4-pin micro-connector (pigtail)	1550E-6533 ☹										
yes		1550E-8533 ☹										
no	4-pin mini-connector	1550E-6503 ☹										
yes		1550E-8503 ☹										
SPDT EM relay 3A at 120 Vac										no	6 ft cable	1550E-6514
										yes		1550E-8514
										no	5-pin micro-connector (pigtail)	1550E-6534 ☹
										yes		1550E-8534 ☹
					no	5-pin mini-connector	1550E-6504 ☹					
					yes		1550E-8504 ☹					

Notes

- ☹☹ See listing of compatible connector cables on **Pages V8-T5-19** and **V8-T5-20**.
- ① For brackets compatible with these sensors, see Accessories on **Page V8-T5-21**.
- ② Field of view depends on fiber selected.
- ③ For a complete system, order one sensor and one fiber optic cable (see **Pages V8-T5-19** and **V8-T5-20**).
- ④ Infrared fiber optic sensors are compatible with glass fiber optic cables (E51KE_).
- ⑤ Diffuse mode—up to 6 in (152 mm); thru-beam—up to 35 in (890 mm).

Field of View: ②③④



Fiber Optic Visible ①

Voltage Range	Sensing Range	Optimum Range	Sensing Beam	Output Type	Time Delay	Connection Type	Catalog Number					
10–40 Vdc	Depends on fiber selected ⑤	Depends on fiber selected	Infrared	NPN/PNP 250 mA	no	6 ft cable	1551E-6517					
					yes		1551E-8517					
					no	4-pin Euro (micro) connector	1551E-6547 ☹					
					yes		1551E-8547 ☹					
					no	4-pin Euro (micro) connector (pigtail)	1551E-6537 ☹					
					yes		1551E-8537 ☹					
					no	4-pin mini-connector	1551E-6507 ☹					
					yes		1551E-8507 ☹					
					12–240 Vdc 24–240 Vac	Depends on fiber selected ⑤	Depends on fiber selected	Infrared	Isolated output solid-state relay 300 mA at 240 Vac/dc	no	6 ft cable	1551E-6513
										yes		1551E-8513
										no	4-pin micro-connector	1551E-6543 ☹
										yes		1551E-8543 ☹
no	4-pin micro-connector (pigtail)	1551E-6533 ☹										
yes		1551E-8533 ☹										
no	4-pin mini-connector	1551E-6503 ☹										
yes		1551E-8503 ☹										
SPDT EM relay 3A at 120 Vac										no	6 ft cable	1551E-6514
										yes		1551E-8514
										no	5-pin micro-connector (pigtail)	1551E-6534 ☹
										yes		1551E-8534 ☹
					no	5-pin mini-connector	1551E-6504 ☹					
					yes		1551E-8504 ☹					

Notes☹☹ See listing of compatible connector cables on **Page V8-T5-19**.① For brackets compatible with these sensors, see Accessories on **Page V8-T5-21**.

② Field of view depends on fiber selected.

③ For a complete system, order one sensor and one fiber optic cable (see **Page V8-T5-20**).

④ Visible fiber optic sensors are compatible with plastic fiber optic cables only.



⑤ Diffuse mode—up to 3 in (76 mm); thru-beam—up to 35 in (890 mm).

Compatible Connector Cables

Micro-Style,
Straight Female





Standard Cables—Micro ①

Voltage Style	Number of Pins	Gauge	Length	Pin Configuration/ Wire Colors (Face View Female Shown)	PVC Jacket Catalog Number	PUR Jacket Catalog Number	IRR PUR Jacket Catalog Number
Micro-Style, Straight Female							
AC Micro	4-pin, 4-wire	22 AWG	6 ft (2m)	 1-Red/Black 2-Red/White 3-Red 4-Green	CSAS4F4CY2202	CSAS4F4RY2202	CSAS4F4IO2202
	5-pin, 5-wire	22 AWG	6 ft (2m)	 1-Brown 2-White 3-Black 4-Gray 5-Blue	CSAS5A5CY2202	—	—
DC	4-pin, 4-wire	22 AWG	6 ft (2m)	 1-Brown 2-White 3-Blue 4-Black	CSDS4A4CY2202	CSDS4A4RY2202	CSDS4A4IO2202

Mini-Style,
Straight Female



Standard Cables—Mini ①

Current Rating at 600V	Voltage Style	Number of Pins	Gauge	Length	Pin Configuration/ Wire Colors (Face View Female Shown)	Catalog Number
Mini-Style, Straight Female						
8A	AC/DC	4-pin, 4-wire	16 AWG	6 ft (2m)	 1-Black 2-Blue 3-Brown 4-White	CSMS4A4CY1602
		5-pin, 5-wire	16 AWG	6 ft (2m)	 1-Black 2-Blue 3-Orange 4-Brown 5-White	CSMS5A5CY1602

Note



① For a full selection of connector cables, see **Tab 10, section 10.1**.

Fiber Optic Cables

Glass Fiber Optic Cables

5

Glass Fiber Optic Cables—Duplex Cables (for Diffuse Reflective Sensing)

Sensing Tip Style	Fiber Bundle Size A in In (mm)	Stainless Steel Jacket Catalog Number	PVC/Monocoil Jacket Catalog Number
Forward Viewing, Unthreaded	Forward Viewing, Unthreaded		
	0.125 (3.2)	E51KE713	E51KE313
Right Angle Viewing, Unthreaded	Right Angle Viewing, Unthreaded		
	0.125 (3.2)	E51KE733	E51KE333
Forward Viewing, Threaded Cable End	Forward Viewing, Threaded Cable End		
	0.125 (3.2)	E51KE723	E51KE323
Right Angle Viewing, Threaded Cable Shaft	Right Angle Viewing, Threaded Cable Shaft		
	0.125 (3.2)	E51KE7A3	E51KE3A3
Right Angle Viewing, Threaded Cable End	Right Angle Viewing, Threaded Cable End		
	0.125 (3.2)	E51KE7B3	E51KE3B3

Dimensions, see Page V8-T5-25.



Glass Fiber Optic Cables—Single Cables (for Thru-Beam Sensing)

Sensing Tip Style	Fiber Bundle Size A in In (mm)	Stainless Steel Jacket Catalog Number	PVC/Monocoil Jacket Catalog Number
Forward Viewing, Unthreaded	Forward Viewing, Unthreaded		
	0.125 (3.2)	E51KE813	E51KE413
Right Angle Viewing, Unthreaded	Right Angle Viewing, Unthreaded		
	0.125 (3.2)	E51KE833	E51KE433
Forward Viewing, Threaded Cable End	Forward Viewing, Threaded Cable End		
	0.125 (3.2)	E51KE823	E51KE423
Right Angle Viewing, Threaded Cable Shaft	Right Angle Viewing, Threaded Cable Shaft		
	0.125 (3.2)	E51KE8A3	E51KE4A3
Right Angle Viewing, Threaded Cable End	Right Angle Viewing, Threaded Cable End		
	0.125 (3.2)	E51KE8B3	E51KE4B3

Dimensions, see Page V8-T5-25.

Plastic Fiber Optic Cables

Plastic Fiber Optic Cables—Pre-Assembled Duplex Cables



Sensing Tip Style	Fiber Diameter in In (mm)	Catalog Number
Large Diameter, Threaded Tip	Large Diameter, Threaded Tip	
	0.059 (1.5)	6324E-6501 ①②
Large Diameter, Threaded Tip with Bendable Probe	Large Diameter, Threaded Tip with Bendable Probe	
	0.039 (1.0)	6324E-6502 ②

Dimensions, see Page V8-T5-25.

Notes

- ① Larger diameter (1.5 mm) fibers provide approximately 50% longer sensing range than small diameter (1 mm).
- ② One cable.
- ③ Set of two.



Plastic Fiber Optic Cables—Pre-Assembled Single Cables

Sensing Tip Style	Fiber Diameter in In (mm)	Catalog Number
Large Diameter, Threaded Tip	Large Diameter, Threaded Tip	
	0.059 (1.5)	6323E-6501 ①③
Large Diameter, Threaded Tip with Bendable Probe	Large Diameter, Threaded Tip with Bendable Probe	
	0.039 (1.0)	6323E-6502 ③

Dimensions, see Page V8-T5-25.

Accessories

Enhanced 50 Series Sensors

	Description	Catalog Number
 Mounting Bracket Right Angle—Short	Mounting Bracket Right Angle—Short Provides for full 360° rotation of sensor. Bracket slots allow for up to 1.5 in of vertical adjustment. Nickel plated	6150E-6501
 Mounting Bracket Right Angle—Tall	Mounting Bracket Right Angle—Tall Provides for full 360° rotation of sensor. Bracket slots allow for up to 1.5 in of vertical adjustment in each slot, and 3.5 in of overall positioning adjustment.	6150E-6502
 Mounting Bracket Right Angle—Ball Swivel	Mounting Bracket Right Angle—Ball Swivel Provides for full 360° rotation of sensor. Ball swivel allows for ±30° sensor angle.	6150E-6503
Retroreflectors		
Retroreflectors and retroreflective tape, see Tab 8, section 8.1		—
Connector Cables		
For use with connector version sensors, see Tab 10, section 10.1		—
Dimensions , see Page V8-T5-25 .		

Technical Data and Specifications

Enhanced 50 Series Sensors

Description	AC/DC EM Relay Model Specification	AC/DC Solid-state Relay Model Specification	DC Only Standard Range Model Specification	DC Only Extended Range Model Specification
Input voltage	12–240 Vdc; 24–240 Vac	12–240 Vdc; 24–240 Vac	10–40 Vdc	10–40 Vdc
Light/dark operation	Switch selectable	Switch selectable	Switch selectable	Switch selectable
Operating temperature	–13° to 131°F (–25° to 55°C)	–13° to 131°F (–25° to 55°C)	–13° to 131°F (–25° to 55°C)	–13° to 131°F (–25° to 55°C)
Humidity	95% Relative humidity, non-condensing	95% Relative humidity, non-condensing	95% Relative humidity, non-condensing	95% Relative humidity, non-condensing
Case material	Fiberglass reinforced plastic	Fiberglass reinforced plastic	Fiberglass reinforced plastic	Fiberglass reinforced plastic
Lens material	Acrylic	Acrylic	Acrylic	Acrylic
Vibration	IEC 60947-5-2 part 7.4.2	IEC 60947-5-2 part 7.4.2	IEC 60947-5-2 part 7.4.2	IEC 60947-5-2 part 7.4.2
Shock	IEC 60947-5-2 part 7.4.1	IEC 60947-5-2 part 7.4.1	IEC 60947-5-2 part 7.4.1	IEC 60947-5-2 part 7.4.1
Protection	—	Output short circuit and overcurrent protection Reverse polarity protection	Output short circuit and overcurrent protection Reverse polarity protection	Output short circuit and overcurrent protection Reverse polarity protection
Enclosure ratings	IP67, IP69K	IP67, IP69K	IP67, IP69K	IP67, IP69K
Output load	3A at 120 Vac; 3A at 240 Vac 3A at 28 Vac	300 mA at 240 Vac/dc	250 mA at 40 Vdc	250 mA at 40 Vdc
Response time	15 ms	2 ms	2 ms	2 ms
Timer timing response	0–15 sec.	0–15 sec.	0–15 sec.	0–15 sec.
No load current	<30 mA	<30 mA	<30 mA	<30 mA
Leakage current (max.)	—	1 mA at 240 Vac	<10 µA	<10 µA
Indicator LEDs	Green: output; yellow: power; red: alignment	Green: output; yellow: power; red: alignment	Green: output; yellow: power; red: alignment	Green: output; yellow: power; red: alignment
Emitter LED				
Diffuse, infrared fiber optic, thru-beam models	Infrared 880 nm	Infrared 880 nm	Infrared 880 nm	Infrared 880 nm
Reflex, polarized reflex, clear object, visible fiber optic units	Visible red 660 nm	Visible red 660 nm	Visible red 660 nm	Visible red 660 nm

Excess Gain

Thru-Beam

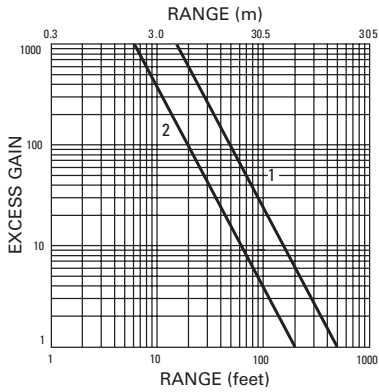

Thru-beam
 1. 1151E/1251E
 2. 1150E/1250E

Clear Object Detector

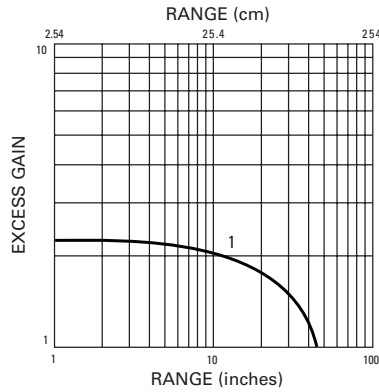

Clear object detector
 3 in retroreflector
 1. 1452E

Diffuse Reflective

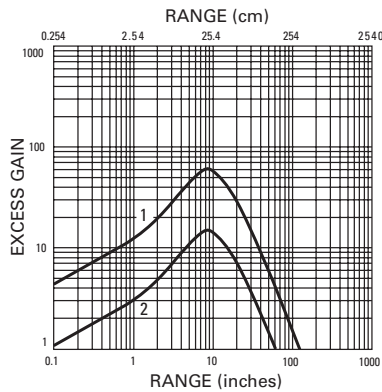

Diffuse reflective
 90% reflectance white card
 1. 1351E
 2. 1350E

Fiber Optic Diffuse

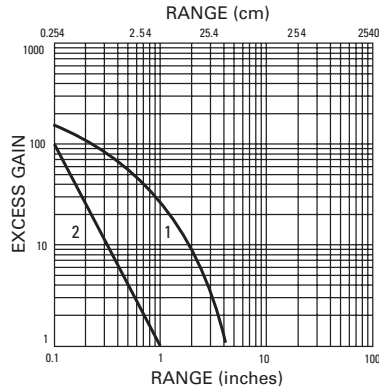

Fiber optic diffuse
 0.125 in dia. glass fiber 0.040 in dia. plastic fiber
 1. 1550E 2. 1551E

Reflex

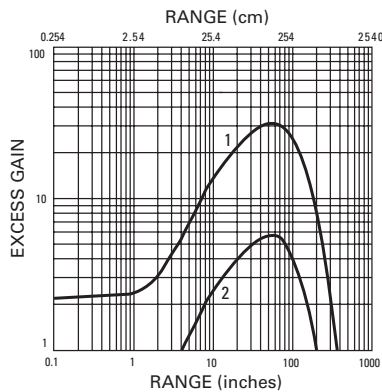

Reflex
 3 in retroreflector
 1. 1450E
 2. 1451E

Fiber Optic Thru-Beam

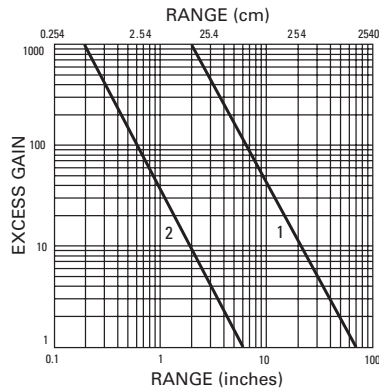

Fiber optic thru-beam
 0.125 in dia. glass fiber 0.040 in dia. plastic fiber
 1. 1550E 2. 1551E

Wiring Diagrams

Pin numbers are for reference, rely on pin location when wiring.

Enhanced 50 Series Sensors

Operating Voltage	Cable Model	Mini-Connector Model (Face View Male Shown)	Micro-Connector Model (Face View Male Shown)
Thru-Beam Source 10–40 Vdc			
All Others 10–40 Vdc			
Thru-Beam Source 12–240 Vdc or 24–240 Vac solid-state relay ②			
All Others with Isolated AC/DC Output 12–240 Vdc or 24–240 Vac solid-state relay ②			
Thru-Beam Source 12–240 Vdc or 24–240 Vac SPDT EM relay ②			
All Others 12–240 Vdc or 24–240 Vac SPDT EM relay ②			

Notes

- ① Connecting the test input to 0 Vdc allows you to switch the light source off for troubleshooting while leaving the sensor under power.
- ② Over current protection is to be provided in the field. Conductor size for 20 AWG: 5 amp; 22 AWG: 3 amp; 24 AWG: 2 amp.
- ③ Connect load to appropriate output for either sinking or sourcing operation.

5.1

Photoelectric Sensors

Enhanced 50 Series Sensors

Dimensions

Approximate Dimensions in Inches (mm)

Enhanced 50 Series Sensors

Cable and Pigtail Connector Versions

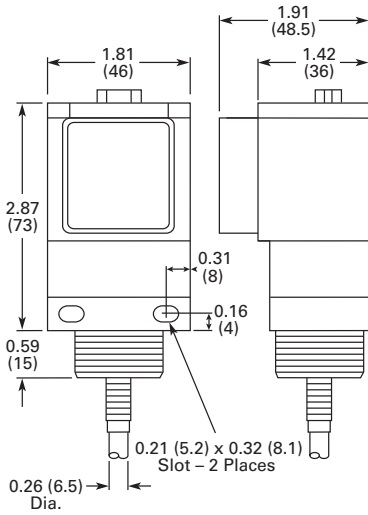

Mini-Connector Versions

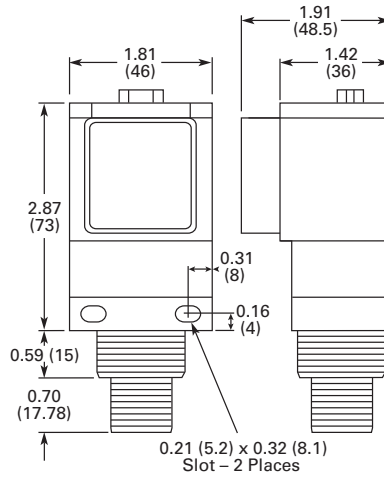

Clear Object Versions

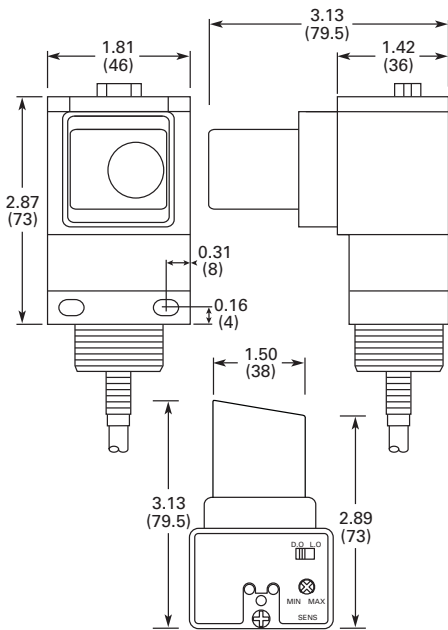

AC/DC Micro or Euro (Micro) Connector Versions

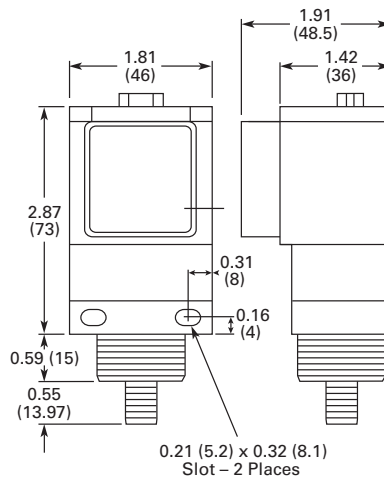

Top Views

With Timing

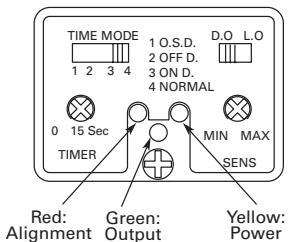

Without Timing

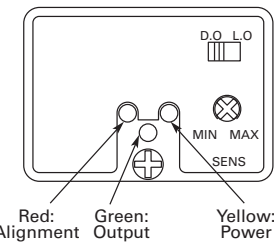

Approximate Dimensions in Inches (mm)

Glass Fiber Optic Cables—Duplex Cables

Stainless Steel Jacket shown for all.

Collar Mounting End



Forward Viewing, Unthreaded

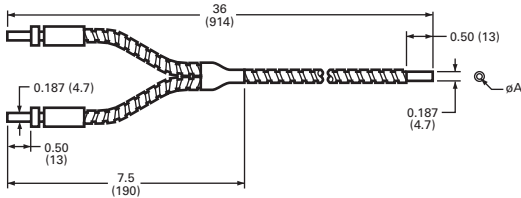

Right Angle Viewing, Unthreaded

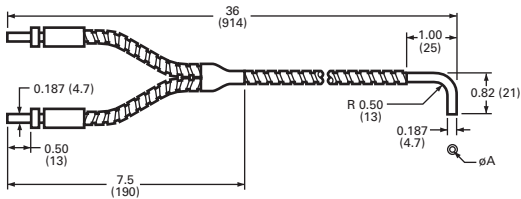

Forward Viewing, Threaded Cable End

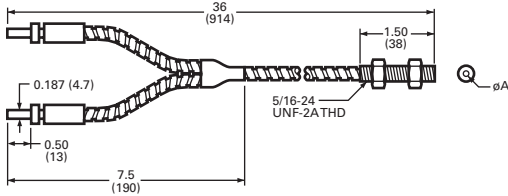

Right Angle Viewing, Threaded Cable Shaft

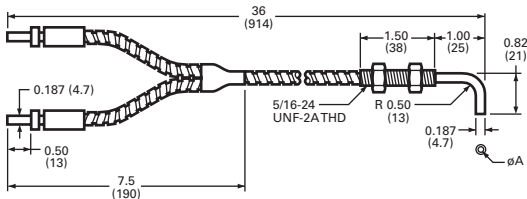

Right Angle Viewing, Threaded Cable End

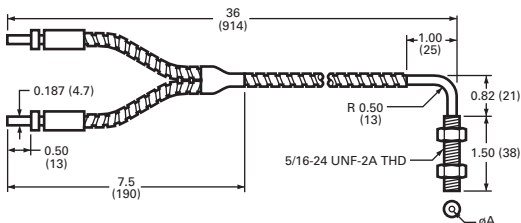

Glass Fiber Optic Cables—Single Cables

Stainless Steel Jacket shown for all.

Collar Mounting End

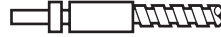

Forward Viewing, Unthreaded

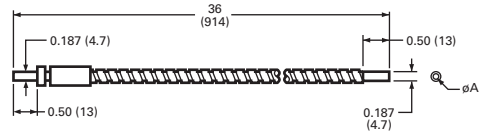

Right Angle Viewing, Unthreaded

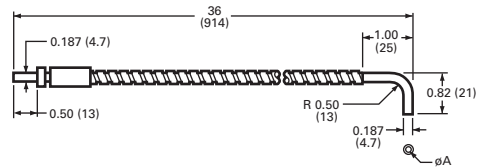

Forward Viewing, Threaded Cable End

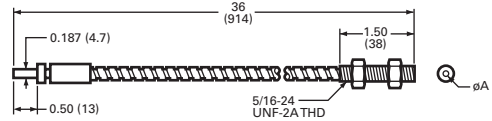

Right Angle Viewing, Threaded Cable Shaft

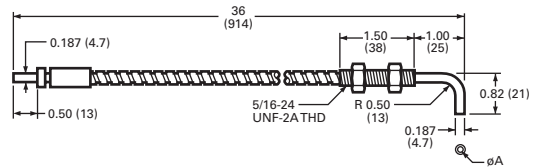

Right Angle Viewing, Threaded Cable End

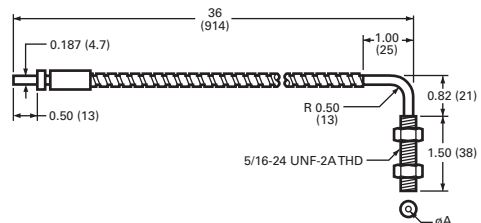

5.1

Photoelectric Sensors

Enhanced 50 Series Sensors

Approximate Dimensions in Inches (mm)

Plastic Fiber Optic Cables—Pre-Assembled Duplex Cables

Large Diameter, Threaded Tip

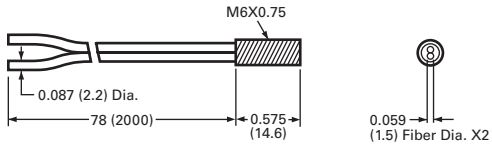

Plastic Fiber Optic Cables—Pre-Assembled Single Cables

Large Diameter, Threaded Tip

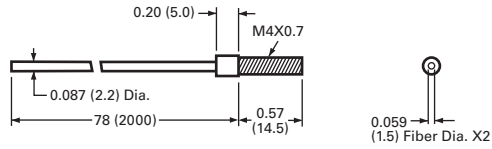

Large Diameter, Threaded Tip with Bendable Probe

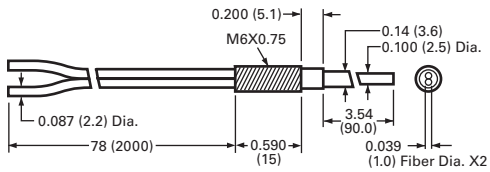

Large Diameter, Threaded Tip with Bendable Probe

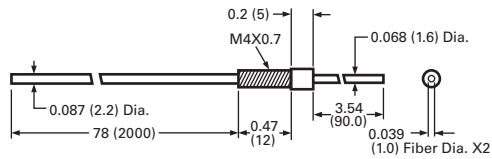

Accessories

Mounting Bracket Right Angle—Short

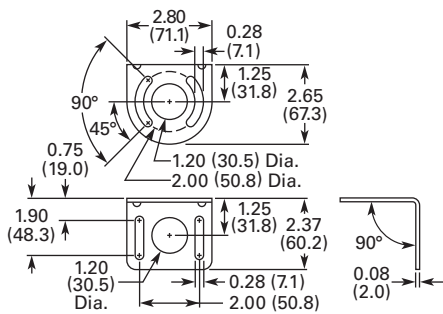

Mounting Bracket Right Angle—Ball Swivel

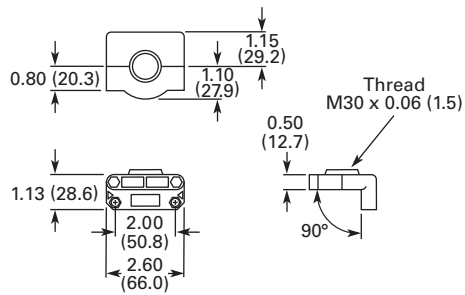

Mounting Bracket Right Angle—Tall

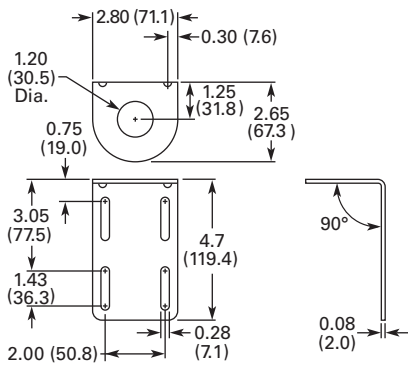

NanoView Series Sensors



Contents

Description

Page

NanoView Series Sensors	
Product Selection	
NanoView Series Sensors—	
Four-Wire Sensors	V8-T5-28
Compatible Connector Cables	V8-T5-29
Accessories	V8-T5-29
Technical Data and Specifications	V8-T5-30
Detection Diagrams	V8-T5-30
Wiring Diagrams	V8-T5-31
Dimensions	V8-T5-32

5

NanoView Series Sensors

Product Description

The NanoView™ Series from Eaton is a family of miniature rectangular photoelectric sensors designed for optimum value and sensing performance in a wide range of applications.

These small sensors are available in a variety of optical modes: polarized reflex; diffuse reflective; fixed-focus diffuse; thru-beam with narrow-beam option; and even a clear object detector.

NanoView sensors are housed in ABS enclosures rated IP66 or better. Two top-mounted indicator LEDs communicate power and output status. Each model includes both light operate and dark operate modes. Termination options include a 4-pin M8 connector cable or a built-in 6 ft (2m) cable.

NanoView is the ultimate solution to sensing challenges that require reduced dimensions and costs.

Features

- A Complete Family of Solutions—Models include an 8.2 ft (2.5m) polarized reflex, a 13 in (35 cm) diffuse reflective, a 4 in (10 cm) fixed-focus diffuse, a 20 ft (6m) thru-beam; and a 2.6 ft (80 cm) clear object detector for sensing plastic bottles, molds, cartons and films
- Small Size—At less than 1.5 in long and half an in deep, NanoView can fit into the smallest of spaces
- Fixed Focus Diffuse Models—Perfect for sensing very small targets at a 4-in focal point. A visible red LED beam makes it easy to set up
- Clear Object Detection Models—Ideal for sensing plastic bottles, molds, cartons, films and glass objects

Standards and Certifications

- UL Listed
- cUL Listed
- CE Approved

DANGER

THIS SENSOR IS NOT A SAFETY DEVICE AND IS NOT INTENDED TO BE USED AS A SAFETY DEVICE. This sensor is designed only to detect and read certain data in an electronic manner and perform no use apart from that, specifically no safety-related use. This sensor product does not include self-checking redundant circuitry, and the failure of this sensor product could cause either an energized or de-energized output condition, which could result in death, serious bodily injury, or property damage.

For the most current information on this product, visit our Web site: www.eaton.com

For Customer Service in the U.S. call 1-877-ETN CARE (386-2273), in Canada call 1-800-268-3578. For Application Assistance in the U.S. and Canada call 1-800-426-9184.

Product Selection





NanoView Series Sensors—Four-Wire Sensors

	Voltage Range	Sensing Mode	Sensing Range	Output Type	Connection Type	Catalog Number
Thru-Beam 	Thru-Beam					
	10–30 Vdc	Thru-beam detector	19 ft (6m)	NPN, light operate or dark operate (selectable)	6 ft cable	E71-TBRN-CA
					4-pin nano-connector ①	E71-TBRN-M8
				PNP, light operate or dark operate (selectable)	6 ft cable	E71-TBRP-CA
					4-pin nano-connector ①	E71-TBRP-M8
		Thru-beam source	19 ft (6m)	N/A	6 ft cable	E71-TBS-CA
4-pin nano-connector ①					E71-TBS-M8	
	Narrow beam Thru-beam source	4.9 ft (1.5m)	N/A	6 ft cable	E71-NTBS-CA	
				4-pin nano-connector ①	E71-NTBS-M8	
Polarized Reflex 	Polarized Reflex					
	10–30 Vdc	Polarized reflex	8.2 ft (2.5m)	NPN, light operate or dark operate (selectable)	6 ft cable	E71-PRN-CA
					4-pin nano-connector ①	E71-PRN-M8
				PNP, light operate or dark operate (selectable)	6 ft cable	E71-PRP-CA
					4-pin nano-connector ①	E71-PRP-M8
	Diffuse Reflective 	Diffuse Reflective				
10–30 Vdc		Diffuse reflective	13.8 in (35 cm)	NPN, light operate or dark operate (selectable)	6 ft cable	E71-SDN-CA
					4-pin nano-connector ①	E71-SDN-M8
				PNP, light operate or dark operate (selectable)	6 ft cable	E71-SDP-CA
	4-pin nano-connector ①				E71-SDP-M8	
Fixed Focus Diffuse Reflective 	Fixed Focus Diffuse Reflective					
	10–30 Vdc	Fixed-focus Diffuse reflective	3.9 in (10 cm) focal point	NPN, light operate or dark operate (selectable)	6 ft cable	E71-FFDN-CA
					4-pin nano-connector ①	E71-FFDN-M8
				PNP, light operate or dark operate (selectable)	6 ft cable	E71-FFDP-CA
4-pin nano-connector ①					E71-FFDP-M8	
Clear Object Detector 	Clear Object Detector					
	10–30 Vdc	Clear object detector	31.5 in (80 cm)	NPN, light operate or dark operate (selectable)	6 ft cable	E71-CON-CA
					4-pin nano-connector ①	E71-CON-M8
				PNP, light operate or dark operate (selectable)	6 ft cable	E71-COP-CA
4-pin nano-connector ①					E71-COP-M8	

Note① For compatible connector cables, see **Page V8-T5-29**.

Compatible Connector Cables

Standard Cables—Nano ①

	Voltage Style	Number of Pins	Gauge	Length	Pin Configuration/Wire Colors (Face View Female Shown)	PVC Yellow Jacket Catalog Number
M8 Nano-Connector, Straight Female 	DC	4-pin, 4-wire	24 AWG	6 ft (2m)		CSNS4A4CY2402
				16.4 ft (5m)		CSNS4A4CY2405
				32.8 ft (10m)		CSNS4A4CY2410
				Nano-Connector Cable, Right Angle Female		
M8 Nano-Connector, Right Angle Female 	DC	4-pin, 4-wire	24 AWG	6 ft (2m)		CSNR4A4CY2402
				16.4 ft (5m)		CSNR4A4CY2405
				32.8 ft (10m)		CSNR4A4CY2410

5

Accessories

NanoView Series Sensors

	Description	Catalog Number
Mounting Bracket 	Mounting Bracket	
	L-shaped mounting bracket for NanoView sensors	E71-MTB1
Dimensions , see Page V8-T5-32 .		

Note

① For a full selection of connector cables, see **Tab 10, section 10.1**.

Technical Data and Specifications

NanoView Series Sensors

Description	For E71-T/N (Thru-Beam) Specification	For E71-P (Polarized Reflex) Specification	For E71-S (Diffuse Reflective) Specification	For E71-F (Fixed Focus Diffuse) Specification	For E71-C (Clear Object Detector) Specification
Input voltage	10–30 Vdc	10–30 Vdc	10–30 Vdc	10–30 Vdc	10–30 Vdc
Current consumption (Output current excluded)	35 mA max.	35 mA max.	35 mA max.	35 mA max.	35 mA max.
Outputs	Light operate and dark operate; PNP or NPN by model; 30 Vdc max.	Light operate and dark operate; PNP or NPN by model; 30 Vdc max.	Light operate and dark operate; PNP or NPN by model; 30 Vdc max.	Light operate and dark operate; PNP or NPN by model; 30 Vdc max.	Light operate and dark operate; PNP or NPN by model; 30 Vdc max.
Output current	100 mA max.	100 mA max.	100 mA max.	100 mA max.	100 mA max.
Output saturation voltage	2V max.	2V max.	2V max.	2V max.	2V max.
Electrical protection	Short circuit and reverse polarity protection	Short circuit and reverse polarity protection	Short circuit and reverse polarity protection	Short circuit and reverse polarity protection	Short circuit and reverse polarity protection
Response time	1 ms max.	1 ms max.	1 ms max.	1 ms max.	1 ms max.
Switching frequency	500 Hz max.	500 Hz max.	500 Hz max.	500 Hz max.	500 Hz max.
Indicator LEDs	Output LED (yellow), stability LED (green), power LED (green)	Output LED (yellow), stability LED (green), power LED (green)	Output LED (yellow), stability LED (green), power LED (green)	Output LED (yellow), stability LED (green), power LED (green)	Output LED (yellow), stability LED (green), power LED (green)
Sensing adjustment	None	Adjustment pot	Adjustment pot	None	Adjustment pot
Temperature range					
Operating	–25° to 55°C (–13° to 131°F)	–25° to 55°C (–13° to 131°F)	–25° to 55°C (–13° to 131°F)	–25° to 55°C (–13° to 131°F)	–25° to 55°C (–13° to 131°F)
Storage	–25° to 70°C (–13° to 158°F)	–25° to 70°C (–13° to 158°F)	–25° to 70°C (–13° to 158°F)	–25° to 70°C (–13° to 158°F)	–25° to 70°C (–13° to 158°F)
Sensing range	Standard beam: 19.7 ft (6.0m) Narrow beam: 4.9 ft (1.5m)	8.2 ft (2.5m)	13.8 in (35 cm)	3.9 in (10 cm)	31.5 in (80 cm)
Beam type	Infrared LED (880 nm)	Visible red LED (660 nm)	Infrared LED (880 nm)	Visible red LED (660 nm)	Visible red LED (660 nm)
Vibration and shock	Vibration: 0.5 mm amplitude, 10–55 Hz for every axis (EN60068-2-6); Half sine, 30 g _r , 11 ms, 3 axes	Vibration: 0.5 mm amplitude, 10–55 Hz for every axis (EN60068-2-6); Half sine, 30 g _r , 11 ms, 3 axes	Vibration: 0.5 mm amplitude, 10–55 Hz for every axis (EN60068-2-6); Half sine, 30 g _r , 11 ms, 3 axes	Vibration: 0.5 mm amplitude, 10–55 Hz for every axis (EN60068-2-6); Half sine, 30 g _r , 11 ms, 3 axes	Vibration: 0.5 mm amplitude, 10–55 Hz for every axis (EN60068-2-6); Half sine, 30 g _r , 11 ms, 3 axes
Housing material	ABS UL 94V-0	ABS UL 94V-0	ABS UL 94V-0	ABS UL 94V-0	ABS UL 94V-0
Lens material	PMMA	PMMA	PMMA	PMMA	PMMA
Mechanical protection	IP67	IP66	IP66	IP67	IP66
Connections	M8 4-pin nano-connector; 6 ft (2m) cable	M8 4-pin nano-connector; 6 ft (2m) cable	M8 4-pin nano-connector; 6 ft (2m) cable	M8 4-pin nano-connector; 6 ft (2m) cable	M8 4-pin nano-connector; 6 ft (2m) cable
Weight	Connector models: 40g max. Cable models: 10g max.	Connector models: 40g max. Cable models: 10g max.	Connector models: 40g max. Cable models: 10g max.	Connector models: 40g max. Cable models: 10g max.	Connector models: 40g max. Cable models: 10g max.

Detection Diagrams

Thru-Beam Models

E71-N

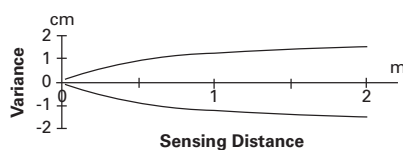

E71-T

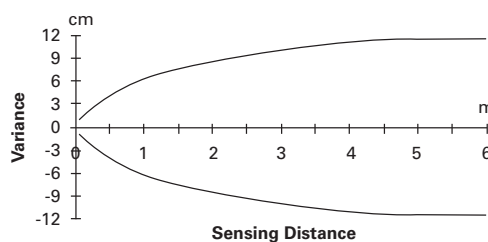

Polarized Reflex Models

E71-P

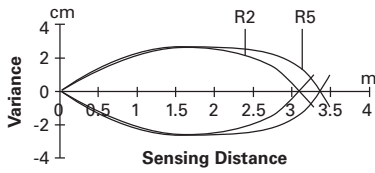

Fixed Focus Diffuse Models

E71-F ①

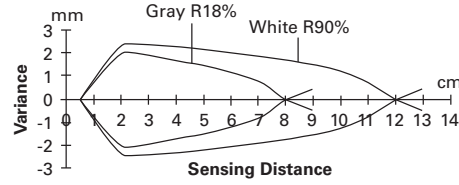

Diffuse Reflective Models

E71-S ①

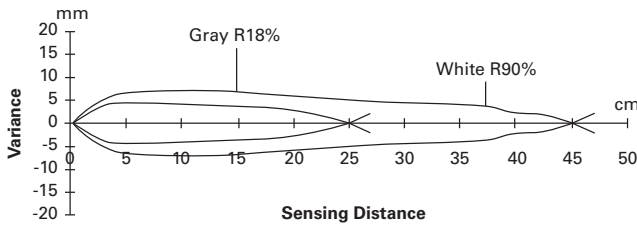

Clear Object Detector Models

E71-C

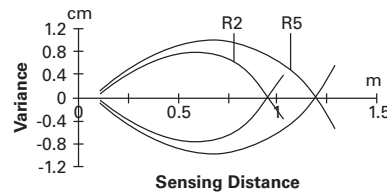

Wiring Diagrams

Pin numbers are for reference, rely on pin location when wiring.

NanoView Series Sensors

Model	Nano-Connector Diagram (Face View Male Shown)	Cable Diagram
All NPN models except thru-beam source		
All PNP models except thru-beam source		
All thru-beam source models		

Note

① These diagrams depict the width of the sensing beam over distance. These diagrams also show the sensing difference between white and gray targets. Because gray is less reflective than white, gray targets will typically need to come closer to the beam centerpoint to be detected.

Dimensions

Approximate Dimensions in Inches (mm)

Cable Models

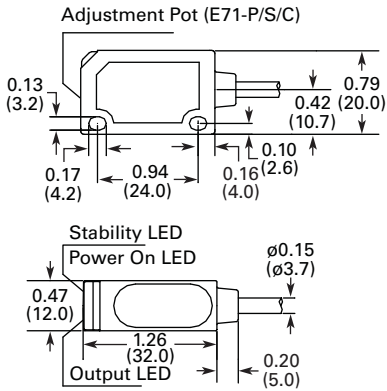

Nano-Connector Models

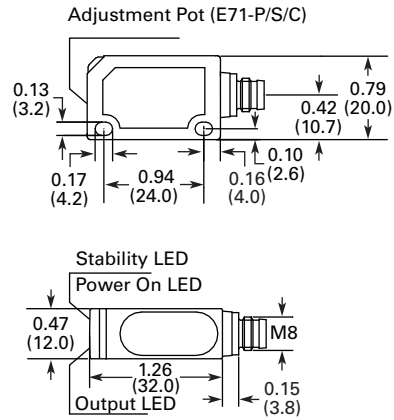

Accessories

E71-MTB1—Mounting Bracket

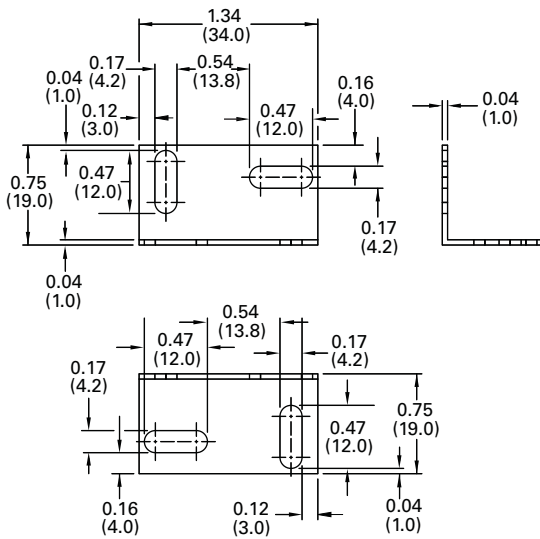

IntelliView Series Sensors



Contents

<i>Description</i>	<i>Page</i>
IntelliView Series Sensors	
Product Selection	
Foreground/Background Sensing	V8-T5-34
Distance Sensing	V8-T5-35
Color, Contrast and Luminescence Sensing	V8-T5-37
Compatible Connector Cables	V8-T5-38
Accessories	V8-T5-38
Technical Data and Specifications	V8-T5-39
Detection Diagrams	V8-T5-42
Wiring Diagrams	V8-T5-43
Dimensions	V8-T5-44

IntelliView Series Sensors

Product Description

The IntelliView™ Series from Eaton is a family of compact, high performance specialty photoelectric sensors designed to solve a wide array of sensing challenges.

IntelliView encompasses a variety of new sensing technologies: color, contrast and luminescence sensing; field-adjustable foreground and background suppression sensing; and long-range, high-precision laser distance sensing with analog outputs.

To fit into your application, IntelliView sensors are available in industry-standard M18 flat-tubular and compact rectangular package sizes. For ease of installation and replacement, all models are available with micro-connectors.

Features

- New Sensing Technologies—Now, Eaton has solutions for sensing color, contrast, luminescence and distance with great accuracy
- Small Size, Big Solutions—IntelliView sensors come in either compact rectangular or flat-tubular package sizes, both rugged sealed enclosures
- Simple “Teach In” Installation—Most models include a teach mode, allowing for quick and simple installation and setup
- Adjustable Background Suppression—For the first time, Eaton offers a fully field-adjustable background suppression photoelectric sensor capable of detecting targets as far as 3.9 ft (1.9m) away
- LED Indicators and Pushbuttons—Multiple LEDs communicate output and power status while built-in pushbuttons and adjustment potentiometers simplify the teaching of sensor settings

Standards and Certifications

- UL Listed
- cUL Listed
- CE



⚠ DANGER
THIS SENSOR IS NOT A SAFETY DEVICE AND IS NOT INTENDED TO BE USED AS A SAFETY DEVICE. This sensor is designed only to detect and read certain data in an electronic manner and perform no use apart from that, specifically no safety-related use. This sensor product does not include self-checking redundant circuitry, and the failure of this sensor product could cause either an energized or de-energized output condition, which could result in death, serious bodily injury, or property damage.

For the most current information on this product, visit our Web site: www.eaton.com

For Customer Service in the U.S. call 1-877-ETN CARE (386-2273), in Canada call 1-800-268-3578. For Application Assistance in the U.S. and Canada call 1-800-426-9184.

Product Selection

Overview—Foreground/Background Sensing



5

Adjustable Foreground/Background Suppression Models



- Ignores nuisance foreground or background objects
- Field-adjustable sensing ranges
- Compact 50x50 mm rectangular package size
- M12 micro-connector termination with 90- and 180-degree rotation options
- Sensing ranges up to 47.2 in (120 cm)

Foreground/Background Sensing Basics

Foreground/background suppression sensors allow the user to precisely set the minimum and maximum detection distance. This allows detection of a target only when it is inside a given area, avoiding the interference of objects lying before (foreground) and behind (background). This type of sensor is ideal for suppressing the detection of box edges and bottoms, sending an output only upon the presence of goods actually contained in the box.

Foreground/Background Sensing

Adjustable Foreground/Background Suppression

	Voltage Range	Output Type	Connection	Adjustable Sensing Range	Catalog Number
Compact Rectangular (50 x 50 x 18 mm) 	Background Suppression Models				
	10–30 Vdc	Light operate or dark operate (selectable), PNP	4-pin micro-connector ^①	3–10 cm (1.2–4.0 in)	E75-PPA010P-M12
				3–25 cm (1.2–9.8 in)	E75-PPA025P-M12
10–50 cm (4.0–19.7 in)	E75-PPA050P-M12				
Compact Rectangular (50 x 50 x 18 mm) 	Extended Range Background Suppression Models				
	10–30 Vdc	Light operate or dark operate (selectable), PNP	4-pin micro-connector ^①	6–120 cm (2.4–47.2 in)	E75-PP1MP-M12
Compact Rectangular (50 x 50 x 18 mm) 	Foreground/Background Suppression Models				
	10–30 Vdc	Light operate or dark operate (selectable), PNP	4-pin micro-connector ^①	Foreground: 5–20 cm (2.0–7.9 in) Background: 12–110 cm (4.7–43.3 in)	E75-PPA110P-M12

Note

^① For compatible connector cables, see [Page V8-T5-38](#).

Overview—Distance Sensing Models with Analog Outputs

Long-Range, High-Precision Laser Distance Measurement Sensor

Distance Sensing Models with Analog Outputs

- When within the effective range of the sensor, outputs a 0–10V signal proportional to the target's distance from the sensor face
- Class II laser emitter detects objects from 0.3 to 4m (1 to 13.1 ft) away
- Two additional PNP outputs can be programmed to switch at predetermined ranges
- Simple three-step teach routine to program range cutoffs
- Unmatched accuracy and resolution at long sensing distances
- When within the effective range of the sensor, outputs a 0–10V signal proportional to the target's distance from the sensor face
- Visible red LED emitter detects objects from 5 to 10 cm (1.9 to 3.9 in)
- Two indicator LEDs communicate sensor status: a yellow LED with light intensity proportional to the target's distance within the sensor's range, and a red LED that activates when the target is beyond maximum sensing range
- Flat tubular package can be mounted using the body threads or flat against a surface

Distance Sensing Explained

Distance sensors output a 0–10V analog signal in proportion to the measurement of the distance between the sensor and target. Optical triangulation, a technology similar to that used in Eaton's Perfect Prox or diffuse sensors, is used for short- to mid-range distance sensing applications that do not require a high degree of accuracy. Time-of-flight technology, a method of measuring the time it takes for the emitted beam to bounce off the target and return to the detector, is used for longer range distance sensing applications. Time-of-flight is highly accurate with precise resolution over long sensing distances.

Distance Sensing**Distance Sensing Models with Analog Outputs**

Voltage Range	Output Type	Connection	Adjustable Sensing Range	Catalog Number
Rectangular (80 x 53 x 31 mm)				
Long-Range Laser Distance Sensor with Time-of-Flight Technology				
19–28 Vdc	Analog output (0–10V), dual teachable PNP outputs, Light operate mode	5-pin micro-connector ^①	0.3–4.0m (1.0–13.1 ft)	E75-DST400A010-M12 ^②

**Notes**

- ^① For compatible connector cables, see **Page V8-T5-38**.
- ^② This sensor is a Class II laser device. Eye irradiation for over 0.25 seconds is dangerous. Refer to the Class II Standard (EN60825-1) for additional safety information.

Overview—Color and Contrast Sensing Models

5

Color Sensors

- Can be programmed to recognize three different colors independently
- Capable of sensing targets 5–45 mm away from the sensor face
- Rectangular plastic package features a four-digit display, two programming buttons and output status LEDs
- Optional serial connection (RS485) allows for remote communications
- Standard M12 8-pin micro-connector (mating cable available on **Page V8-T5-28**)

Contrast Sensors

- Ideal for detecting different colored or grayscale contrasts, such as registration marks
- Capable of sensing targets out to 10 mm from the sensor face
- Simple three-step setup routine for quick installation or optional “fine setup routine” for more complicated applications
- Complementary outputs can function in either light operate or dark operate modes
- Standard M12 4-pin micro-connector (mating cable available on **Page V8-T5-29**)

Color Sensing Basics

Color sensors work by using a “chromaticity” detection algorithm. Chromaticity is determined by two characteristics: hue and saturation. Hue is determined by the reflected light’s wavelength, while saturation indicates the pureness percentage (with white representing 0%). Eaton’s color sensor goes one step further and provides an optional “chromaticity plus intensity” algorithm. This mode provides a higher sensitivity to tone variations and is recommended for detection of different colors on the same type of material. It will also better distinguish between gray tones.

The color of a target is determined by the color components of the reflected source light. The target color is identified by analyzing the red (R), green (G) and blue (B) channels of reflected light. For example, yellow can be identified by the following reflections: R=50%, G=50%, B=0%; orange can be identified by R=75%, G=25%, B=0%; pink by R=50%, G=0%, B=0%. The RGB combinations are practically limitless. Applications for color sensors are common in many industries, ranging from quality and process control, to automatic material handling for identification, to orientation and selection of objects according to their color.

Contrast Sensing Basics

Contrast sensors (also defined as color mark readers, according to their most popular application) go beyond simple presence/absence detection to distinguish two surfaces according to the contrast produced by their difference in reflectivity. For example, a dark reference mark (low reflectivity) can be detected by comparing it against the contrast of the lighter surface (high reflectivity). A white LED light source is used for general purpose contrast sensing, enabling detection of the very slightest of contrast variations—even those that share the same general material and color. Contrast sensors are frequently used in automated packaging applications for registration mark detection to automate the folding, cutting and sorting phases.



Overview—Luminescence Sensing Models**Luminescence Sensors**

- Perfect for the detection of any luminescent target, even on reflective materials such as ceramics, metal or mirrored glass
- Capable of sensing from 8–20 mm from the sensor face
- Simple three-step setup routine and optional “fine setup routine” for more complicated applications
- Can function in either light operate or dark operate mode
- Standard M12 4-pin micro-connector (mating cable available on **Page V8-T5-30**)

Luminescence Sensing Basics

Luminescence is defined as visible light emission from fluorescent or phosphorescent substances. Luminescence sensors emit ultraviolet light, which is then reflected at a higher wavelength from the target surface. The UV emission from the sensor is modulated and the visible light received is synchronized, resulting in immunity against external interferences such as reflections caused by shiny objects. Luminescence sensors are used in various industries to detect labels, fluorescent marks or signs, fluorescent glues on paper, to distinguish cutting and sewing guides, and to check fluorescent paints or lubricants.

Color, Contrast and Luminescence Sensing**Color, Contrast and Luminescence Sensing Models**

	Voltage Range	Sensing Range	Connection ^①	Output Type	Catalog Number
Rectangular (50 x 50 x 25 mm) 	10–30 Vdc	5–45 mm (0.19–1.77 in) ^②	8-pin micro-connector ^①	3 NO PNP outputs	E76-CLRMKP-M12
				3 NO NPN outputs	E76-CLRMKN-M12
				3 NO NPN outputs, RS485 connection ^③	E76-CLRMKRS-M12
Flat Tubular (18 mm) 	10–30 Vdc	10 mm (0.39 in) ideal	4-pin micro-connector	Light operate or dark operate, PNP output	E76-CNT010P-M12
				Light operate or dark operate, NPN output	E76-CNT010N-M12
Flat Tubular (18 mm) 	10–30 Vdc	8–20 mm (0.31–0.79 in)	4-pin micro-connector	Light operate or dark operate, PNP output	E76-UV020P-M12

Notes

- ^① For complete connector cables, see **Page V8-T5-38**.
- ^② Refer to Detection Diagram on **Page V8-T5-43**.
- ^③ Sensing parameters may be adjusted using the RS485 serial interface. The RGB color data is not available through this serial link.

Compatible Connector Cables

M12 Micro-Connector, Straight Female



Standard Cables ①

Voltage Style	Number of Pins	Gauge	Length	Pin Configuration/Wire Colors (Face View Female Shown)	PVC Catalog Number	PUR Catalog Number	IRR PUR Catalog Number
Micro-Connector, Straight Female							
DC	4-pin, 4-wire	22 AWG	6 ft (2m)		CSDS4A4CY2202	CSDS4A4RY2202	CSDS4A4IO2202
			16.4 ft (5m)		CSDS4A4CY2205	CSDS4A4RY2205	CSDS4A4IO2205
			32.8 ft (10m)		CSDS4A4CY2210	CSDS4A4RY2210	CSDS4A4IO2210
	5-pin, 5-wire	22 AWG	6 ft (2m)		CSDS5A5CY2202	—	—
			16.4 ft (5m)		CSDS5A5CY2205	—	—
			32.8 ft (10m)		CSDS5A5CY2210	—	—
	8-pin, 8-wire	24 AWG	6 ft (2m)		CSDS8A8CB2402	—	—
			16.4 ft (5m)		CSDS8A8CB2405	—	—
			32.8 ft (10m)		CSDS8A8CB2410	—	—

5

Accessories

IntelliView Series Sensors

Mounting Brackets—L-Shaped



Description	Sensor Compatibility	Catalog Number
Mounting Brackets—L-Shaped		
L-shaped mounting bracket for IntelliView sensors Mounting hardware included	All models starting with E75-PPA_	E75-MTB1
Long L-shaped mounting bracket for IntelliView sensors Mounting hardware included	All models starting with E76-CLR_ and E75-PP1MP-M12	E76-MTB1
Adjustability: Allows some adjustment in one axis and allows for aiming of the sensor through a short arc Sensor mounting: Sensor mounts with two jam nuts and washers (included with sensor) Material of construction: Aluminum with chromate finish Packaging: Two per package	All 18 mm flat tubular sensors	6161AS6501

Mounting Bracket Ball Swivel



Allows 360° rotation and 10° vertical tilt Hole spacing is identical to our 50 and 55 series sensors Ideal for mounting Right Angle sensors Made of Noryl®	All 18 mm flat tubular sensors	6181AS5200
---	--------------------------------	-------------------

Additional Mounting Brackets

More mounting brackets compatible with IntelliView sensors, see **Tab 8, section 8.2**

Dimensions, see **Page V8-T5-47**.

Note

① For a full selection of connector cables, see **Tab 10, section 10.1**.

Technical Data and Specifications

Foreground/Background Suppression Models

Description	Specification
Input voltage	10–30 Vdc
Ripple	2 Vpp max.
Outputs	PNP, NO or NC; 30 Vdc max.
Output current	100 mA max. (short-circuit protected)
Output saturation voltage	< 2V max.
Response time	1 ms
Switching frequency	500 Hz
Indicator LEDs	For E75-PPA: Output LED (red), stability LED (green) For E75-PP1: Output LED (yellow), stability LED (green)
Gain adjustment	For E75-PPA: Adjustment screw (except for E75-PPA010P) For E75-PP1: Six-turn adjustment pot with numerical indicator
Operating temperature	–25° to 55°C (–13° to 131°F)
Storage temperature	–25° to 70°C (–13° to 158°F)
Electrical protection	Class 2
Sensing distance	Varies by model, see model selection table on Page V8-T5-37
Beam type	All models except E75-PPA010P-M12: Infrared LED 880 nm E75-PPA010P-M12: Red LED
Vibration	Amplitude: 0.5 mm Frequency: 10–55 Hz for every axis (EN60068-2-6)
Shock resistance	Half sine, 30 g _n , 11 ms, 3 axes
Housing material	ABS
Lens material	PMMA
Enclosure ratings	For E75-PPA_: IP65 For E75-PP1_: IP67
Connections	M12 4-pin micro-connector
Weight	40g max.

Distance Sensing Models—Long Range

Description	For E75-DST4_ (Long-Range Distance Sensor) Specification
Input voltage	16–28 Vdc
Ripple	2 Vpp max.
Current consumption (Output current excluded)	120 mA max.
Outputs	Analog, 0–10V 2 PNP outputs 30 Vdc max.
Output switching mode	Light operate (output on when target present)
Output current	100 mA max. (short-circuit protected)
Output saturation voltage	< 2V max.
Response time	12 ms
Switching frequency	42 Hz
Indicator LEDs	2 output LEDs (yellow) Power/alarm LED (green)
Distance adjustment	Dual buttons
Warm-up	15 min
Operating temperature	0° to 50°C (32° to 122°F)
Storage temperature	–20° to 70°C (–4° to 158°F)
Measurement range	0.3–4.0m (1.0–13.1 ft)
Linearity	< 1% (24 Vdc, 25°C, with 90% white target)
Repeatability	± 4 mm
Hysteresis	20 mm
Temperature drift	< 1 mm per °C
Beam type	Red laser (665 nm), Class 2 EN 60825-1 (1994) A1 (2002) A2 (2001)
Vibration	Amplitude: 0.5 mm Frequency: 10–55 Hz for every axis (EN60068-2-6)
Shock resistance	Half sine, 30 g _n , 11 ms, 3 axes
Material of construction	ABS
Lens material	PMMA
Enclosure ratings	IP67
Connections	M12 5-pin micro-connector
Weight	92g max.

Color Sensing Models

Description	Specification
Input voltage	10–30 Vdc
Ripple	2V max.
Current consumption (Output current excluded)	60 mA max.
Outputs	3 PNP outputs 30 Vdc max. (short-circuit protected)
Output switching mode	100 mA max.
Output saturation voltage	< 2V
Response time	650 μ s
Switching frequency	770 Hz
Indicator LEDs	4-digit display (green), Output LED (yellow), 3 status LEDs (green)
Sensing adjustment	SET, SEL buttons
Operating temperature	–10° to 55°C (14° to 131°F)
Storage temperature	–20° to 70°C (–4° to 158°F)
Protection	Class 2
Sensing distance	20 mm (0.79 in)
Beam spot dimension	Ø 4 mm
Beam type	White LED (400–700 nm)
Vibration	Amplitude: 0.5 mm Frequency: 10–55 Hz for every axis (EN60068-2-6)
Shock resistance	Half sine, 30 g _n , 11 ms, 3 axes
Material of construction	ABS thermoplastic
Lens material	Glass window and lens
Mechanical protection	IP67
Connections	M12 8-pin micro-connector

Contrast Sensing Models

Description	Specification
Input voltage	10–30 Vdc
Ripple	2V max.
Current consumption (Output current excluded)	25 mA max.
Outputs	PNP or NPN by model, NO and NC, 30 Vcc max. (short-circuit protected)
Output current	100 mA max.
Output saturation voltage	< 2V
Response time	185 μ s
Switching frequency	2.7 kHz
Indicator LEDs	Output LED (yellow) Ready/error LED (green/red)
Data retention	EEPROM non-volatile memory
Operating mode	Light operate on NO output Dark operate on NC output
Operating temperature	–10° to 55°C (14° to 131°F)
Storage temperature	–20° to 70°C (–4° to 158°F)
Operating distance	10 mm \pm 2 mm
Beam type	White LED (400–700 nm)
Vibration	Amplitude: 0.5 mm Frequency: 10–55 Hz for every axis (EN60068-2-6)
Shock resistance	Half sine, 30 g _n , 11 ms, 3 axes
Material of construction	PBT
Lens material	PMMA plastic
Enclosure ratings	IP67
Connections	M12 4-pin micro-connector cable
Weight	25g max.

Luminescence Sensing Models

Description	Specification
Input voltage	10–30 Vdc
Ripple	2V max.
Current consumption (Output current excluded)	25 mA max.
Outputs	PNP or NPN by model, NO and NC, 30 Vcc max. (short-circuit protected)
Output current	100 mA max.
Output saturation voltage	< 2V
Response time	1.1 ms
Switching frequency	445 Hz
Indicator LEDs	Output LED (yellow) Relay/error LED (green/red)
Data retention	EEPROM non-volatile memory
Operating mode	Light operate on NO output Dark operate on NC output
Operating temperature	–10° to 55°C (14° to 131°F)
Storage temperature	–10° to 70°C (–4° to 158°F)
Sensing distance	8–20 mm (best signal at 10 mm)
Beam type	White LED (400–700 nm)
Vibration	Amplitude: 0.5 mm Frequency: 10–55 Hz for every axis (EN60068-2-6)
Shock resistance	Half sine, 30 g _n , 11 ms, 3 axes
Material of construction	PBT
Lens material	PMMA plastic
Enclosure ratings	IP67
Connections	M12 4-pin micro-connector cable
Weight	25g max.

Detection Diagrams

Foreground/Background Suppression Models

Models starting with E75-PPA_ or E76-PP1_

Black/White Difference

E75-PPA010P-M12 ①

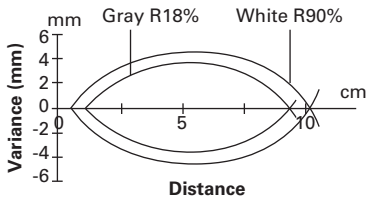

E75-PPA025P-M12 ①

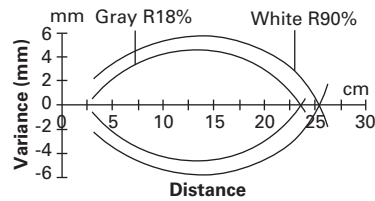

E75-PPA050P-M12 ①

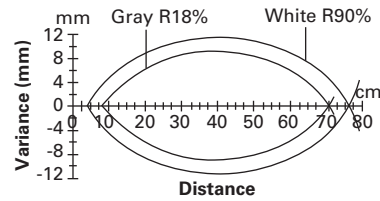

E75-PPA110P-M12

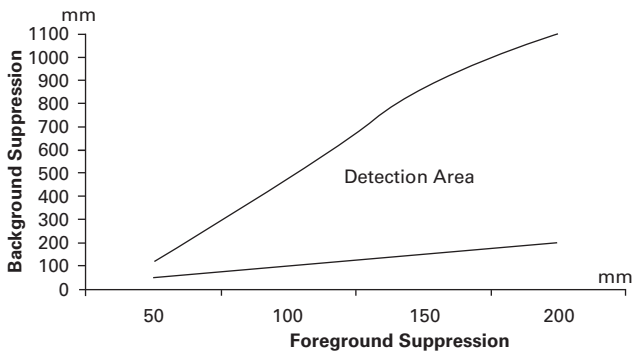

Distance Sensing Models (Rectangular Package Only)

Models E75-DST400A010-M12

Analog Output Diagram

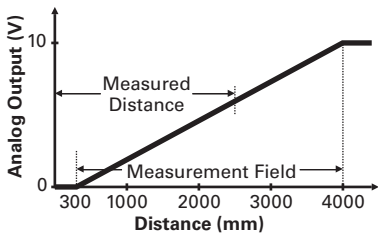

Digital Output Diagram

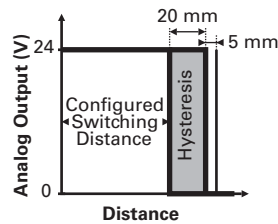

Black/White Difference

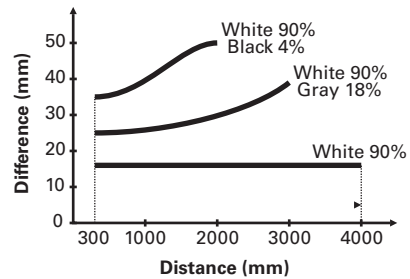

Note

① These diagrams depict the width of the sensing beam over distance. These diagrams also show the sensing difference between white and gray targets. Because gray is less reflective than white, gray targets will typically need to come closer to the beam centerpoint to be detected.

Color Sensing Models

Models E76-CLRMKN-M12,
E76-CLRMKP-M12,
E76-CLRMKRS-M12

Color Detection Diagram

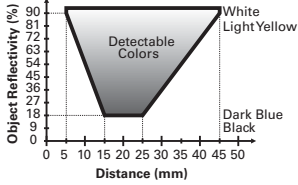

Luminescence Sensing Models

Models starting with
E76-CN_

Contrast Detection Diagram

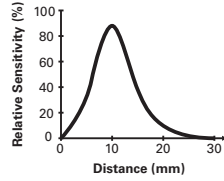

Models starting with
E76-UV_

Luminescence Detection Diagram

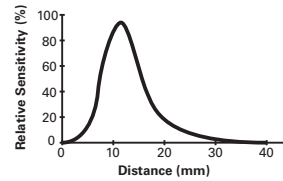

Wiring Diagrams

Pin numbers are for reference, rely on pin location when wiring.

IntelliView Series Sensors

Micro-Connector Diagram (Face View Male Shown)

Model

Foreground/Background Suppression Models

Models starting with
E75-PPA_ or E76-PP1_

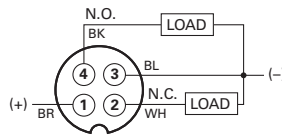

Distance Sensing Models (Rectangular Package Only)

E75-DST400A010-M12

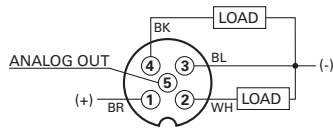

Note

① Available only on E76-CLRMKRS-M12 with RS485 serial connection.

Micro-Connector Diagram (Face View Male Shown)

Model

Color Sensing Models

E76-CLRMKN-M12,
E76-CLRMKP-M12,
E76-CLRMKRS-M12

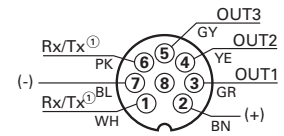

Contrast and Luminescence Sensing Models

Models starting with
E76-UV_ or E76-CN_

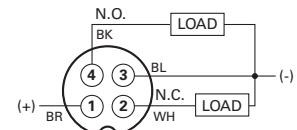

5.3

Photoelectric Sensors

IntelliView Series Sensors

Dimensions

Approximate Dimensions in Inches (mm)

Foreground/Background Suppression Models

Models starting with E75-PP1_

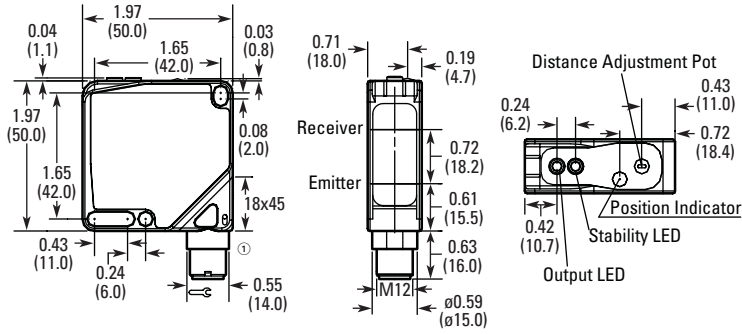

Models starting with E75-PPA_

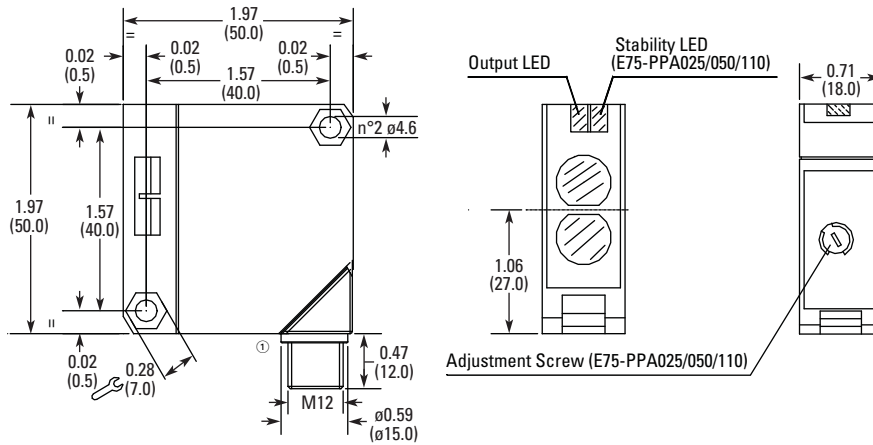

Note

① Connector can rotate 90 or 180 degrees to accept different sensor mounting orientations.

Approximate Dimensions in Inches (mm)

Distance Sensing Models (Rectangular Package Only)

E75-DST400A010-M12

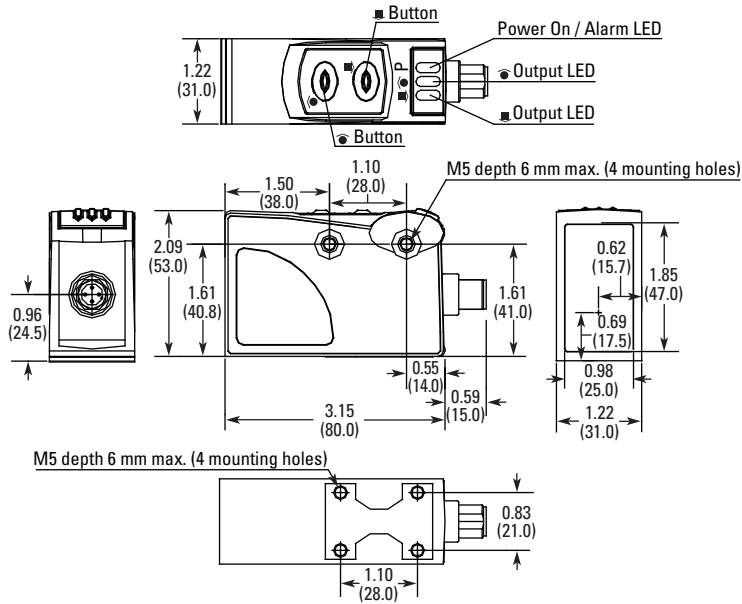

5.3

Photoelectric Sensors

IntelliView Series Sensors

Approximate Dimensions in Inches (mm)

Color Sensing Models

E76-CLRMKN-M12, E76-CLRMKP-M12, E76-CLRMKRS-M12

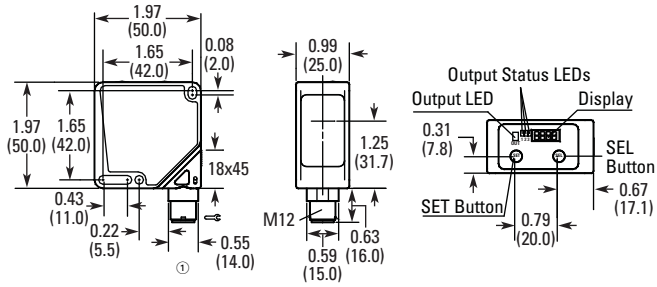

Contrast and Luminescence Sensing Models

Models starting with E76-UV_ or E76-CN_

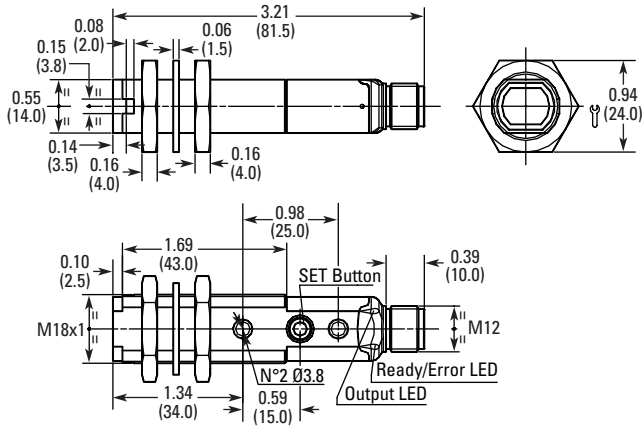

Note

① Connector can rotate 90 or 180 degrees to accept different sensor mounting orientations.

Approximate Dimensions in Inches (mm)

Accessories—Mounting Brackets

E76-MTB1—Long L-Shaped Mounting Bracket

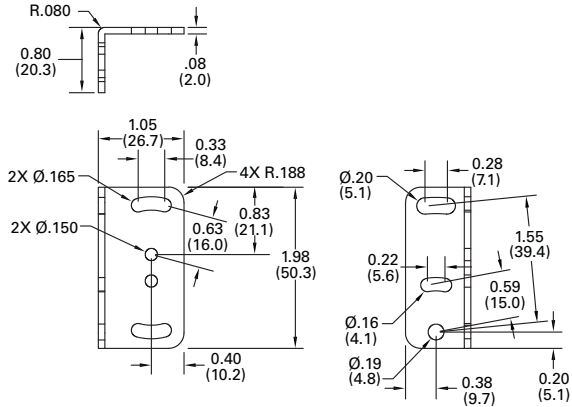

E75-MTB1—L-Shaped Mounting Bracket

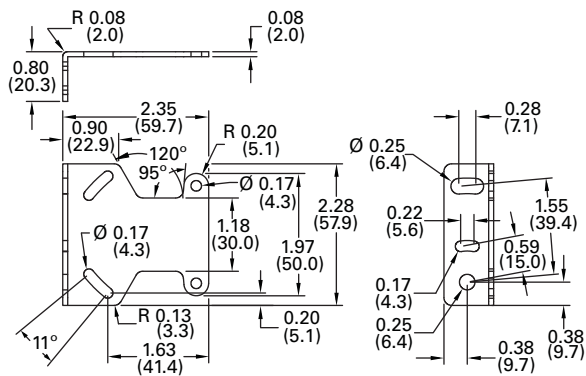

6181AS5200—Ball Swivel

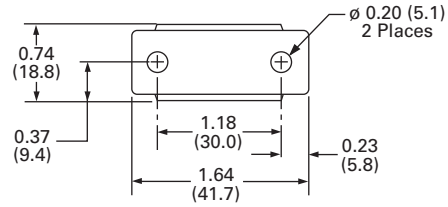

6161AS6501—L-Shaped

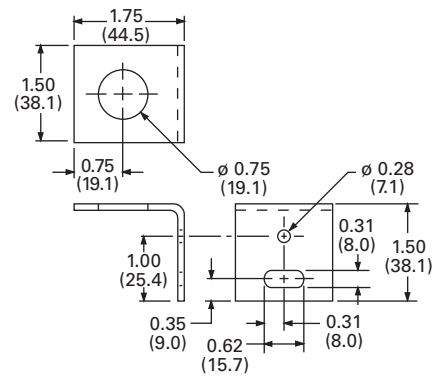

SM Series Sensors

5



SM Series Sensors

Product Description

The SM Series from Eaton's Electrical Sector provides high performance and ease of use in an economical, compact package.

Lock In on Great Performance with TargetLock

A sensor can have the greatest performance in the world, but if it is slightly misaligned or the target is positioned at the wrong range, you will have reliability problems sooner or later. TargetLock™ not only simplifies sensor setup but visually confirms your sensor is positioned to operate with the highest possible reliability. In addition, TargetLock provides diagnostic information during use to inform you of impending problems before they result in equipment downtime.

No Sensor Is Easier to Use

The SM Series includes many other features that simplify use. Visible sensing beams on all models show you exactly where the sensors are pointing. The durable housing features multiple mounting options to easily fit on your equipment in the tightest of spaces. Full protection from overvoltage, reverse polarity and short circuits reduces the chance of damage. Bright 360° LED indicators clearly show sensor status.

Application Description

Typical Applications

- Packaging machines
- Conveyors and other material handling equipment
- Food processing equipment
- Assembly machines
- Pharmaceutical machines

Contents

Description

	Page
SM Series Sensors	
Product Overview	V8-T5-49
Product Selection	
SM Series Sensors	V8-T5-50
Compatible Connector Cables	V8-T5-51
Accessories	V8-T5-51
Technical Data and Specifications	V8-T5-52
Excess Gain	V8-T5-52
Wiring Diagrams	V8-T5-53
Dimensions	V8-T5-53

Features

- Highly visible LED indicators for power, output and TargetLock
- TargetLock simplifies setup and ensures the sensor operates at the highest level of reliability possible
- Perfect Prox models sense different colored targets at the same range and ignore objects in the background
- AC/DC models operate on either 18–264 Vac or 18–50 Vdc
- DC-only models feature both NPN and PNP outputs
- Visible beam on all models lets you see exactly where the sensor is pointing
- Compact size to fit in tight spaces
- Multiple mounting options including industry standard 18 mm threads
- Reverse polarity, overload and short circuit protection
- Full family includes thru-beam, polarized reflex, diffuse reflective and Perfect Prox background rejection

Standards and Certifications

- UL Listed
- cUL Listed
- CE

**⚠ DANGER**

THIS SENSOR IS NOT A SAFETY DEVICE AND IS NOT INTENDED TO BE USED AS A SAFETY DEVICE. This sensor is designed only to detect and read certain data in an electronic manner and perform no use apart from that, specifically no safety-related use. This sensor product does not include self-checking redundant circuitry, and the failure of this sensor product could cause either an energized or de-energized output condition, which could result in death, serious bodily injury, or property damage.

For the most current information on this product, visit our Web site: www.eaton.com

For Customer Service in the U.S. call 1-877-ETN CARE (386-2273), in Canada call 1-800-268-3578.

For Application Assistance in the U.S. and Canada call 1-800-426-9184.

Product Overview

Unparalleled Optical Performance—Perfect Prox

Exceptional background rejection sets Perfect Prox apart from all other sensors. Just point the sensor's visible beam at the target and get reliable detection regardless of color, reflectance, contrast or surface shape, while ignoring background objects just a fraction of an inch away.

Fast and Easy Setup

The SM Series features an advanced 3-LED indicator display to provide valuable information at a glance. The bright display is clearly visible from 360°. In addition to LEDs for power and output status indication, the SM features a third LED that is part of the TargetLock system.

TargetLock is a microprocessor- controlled system that enables you to quickly and easily align the sensor and ensure it is operating most reliably.

- Alignment:** The TargetLock LED provides a quick and easy way to set up the sensor for optimum operation. On initial setup, when you have achieved the minimum signal required for the sensor to operate, the TargetLock LED will blink in a short flash pattern. As you improve the setup and approach the best alignment and range, the LED changes from short flash to long flash to a solid ON condition. This means that even after you reach a point where the sensor will operate in the application, you are able to further fine tune the setup for highest reliability.

- Maintenance:** Another valuable feature of the TargetLock LED is to indicate the need for maintenance prior to loss of sensor operation. Observing a change from the normal operation of the LED (for example, from solid ON to a long flash) indicates the gain has been reduced. Possible causes include bumping or vibrating out of alignment or contamination buildup on the lens. With the TargetLock LED, you are made aware of this condition before the sensor stops working, allowing you ample time to address the problem before your machine goes down.

Mounting

The SM sensor features two mounting holes in the rectangular section of the body for mounting to a surface with #6 or smaller hardware. The threaded barrel and jam nut allow mounting into any 0.75 in (19 mm) hole or a selection of accessory mounting brackets available from Eaton and detailed in **Tab 8, section 8.2**.

Mounting Sensor using #6 Hardware

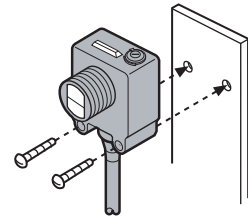

Mounting Sensor using a Jam Nut

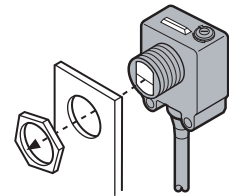

Mounted SM Sensor in 18 mm Ball Swivel Bracket

See **Tab 8, section 8.2**.



LED Indicators

LED	State	Thru-Beam/Reflex LED Condition	Diffuse/ Perfect Prox LED Condition
Power (green)	ON	Power is applied to sensor	Power is applied to sensor
	OFF	No power	No power
Output (red)	ON	Output is ON	Output is ON
	OFF	Output is OFF	Output is OFF
	Flashing	Output is short circuited or overloaded	Output is short circuited or overloaded
Target-Lock (orange)	ON	Excellent alignment; sensor is operating within optimum range	Target present—excellent gain; sensor is operating within optimum range
	Long flash	Good alignment ^①	Target present—good gain
	Short flash	Poor alignment ^①	Target present—poor gain
	OFF	Target is present; if no target present, sensor is out of alignment or beyond range	No target, or sensor is beyond range

Note

- ^① A target that doesn't fully block the effective sensing beam or is translucent may cause a flashing indication and unreliable performance.

See table (this page) for details of the function of each of the SM Series LED indicators.

Gain Adjustment

Thru-beam and diffuse reflective sensors include an adjustment control for optimizing the amount of gain for the application. The 3/4-turn pot provides a 10:1 adjustment of gain. A mechanical stop eliminates the possibility of sensor damage. Adjustment of the control does not require any special tools.

Product Selection

SM Series Sensors

Three-Wire and Four-Wire Sensors

	Operating Voltage	Sensing Range	Optimum Range	Cutoff Range	Field of View	Thru-Beam Component	Connection Type	Light Operate Catalog Number	Dark Operate Catalog Number
Thru-Beam ^①									
	Thru-Beam								
	18–30 Vdc	50 ft (15m)	0.1 to 25 ft (30 to 7.5m)	—	10 in (254 mm) diameter at 10 ft (3m)	Source	2m cable	E65-SMSTS15-HA	E65-SMSTS15-HA
							4-pin micro DC connector	E65-SMSTS15-HAD ⊕	E65-SMSTS15-HAD ⊕
						Detector	2m cable	E65-SMTD15-HL	E65-SMTD15-HD
							4-pin micro DC connector	E65-SMTD15-HLD ⊕	E65-SMTD15-HDD ⊕
Polarized Reflex ^②									
	Polarized Reflex								
	18–264 Vac 50/60 Hz or 18–50 Vdc	10 ft (3m)	0.1 to 5 ft (30 to 1.5m)	—	1 in (25 mm) diameter at 50 in (1.3m)	—	2m cable	E65-SMPR3-GL	E65-SMPR3-GD
							4-pin micro AC connector	E65-SMPR3-GLD ⊕	E65-SMPR3-GDD ⊕
	10–30 Vdc	10 ft (3m)	0.1 to 5 ft (30 to 1.5m)	—	1 in (25 mm) diameter at 50 in (1.3m)	—	2m cable	E65-SMPR3-HL	E65-SMPR3-HD
						4-pin micro DC connector	E65-SMPR3-HLD ⊕	E65-SMPR3-HDD ⊕	
Diffuse Reflective									
	Diffuse Reflective								
	18–264 Vac 50/60 Hz or 18–50 Vdc	8 in (200 mm) ③	0.25 to 5 in (6 to 127 mm)	—	2 in (50 mm) diameter at 5 in (127 mm)	—	2m cable	E65-SMSD200-GL	E65-SMSD200-GD
							4-pin micro AC connector	E65-SMSD200-GLD ⊕	E65-SMSD200-GDD ⊕
	10–30 Vdc	8 in (200 mm) ③	0.25 to 5 in (6 to 127 mm)	—	2 in (50 mm) diameter at 5 in (127 mm)	—	2m cable	E65-SMSD200-HL	E65-SMSD200-HD
						4-pin micro DC connector	E65-SMSD200-HLD ⊕	E65-SMSD200-HDD ⊕	
Perfect Prox									
	Perfect Prox								
	18–264 Vac 50/60 Hz or 18–50 Vdc	2 in (50 mm)	0.4 to 1.8 in (10 to 45 mm)	2.3 in (58 mm) and beyond ④	0.25 in (6 mm) diameter at 2.25 in (57 mm)	—	2m cable	E65-SMPP050-GL	E65-SMPP050-GD
							4-pin micro AC connector	E65-SMPP050-GLD ⊕	E65-SMPP050-GDD ⊕
		4 in (100 mm)	0.5 to 3 in (13 to 76 mm)	5 in (127 mm) and beyond ④	0.35 in (9 mm) diameter at 5 in (127 mm)	—	2m cable	E65-SMPP100-GL	E65-SMPP100-GD
							4-pin micro AC connector	E65-SMPP100-GLD ⊕	E65-SMPP100-GDD ⊕
	10–30 Vdc	2 in (50 mm)	0.4 to 1.8 in (10 to 45 mm)	2.3 in (58 mm) and beyond ④	0.25 in (6 mm) diameter at 2.25 in (57 mm)	—	2m cable	E65-SMPP050-HL	E65-SMPP050-HD
							4-pin micro DC connector	E65-SMPP050-HLD ⊕	E65-SMPP050-HDD ⊕
		4 in (100 mm)	0.5 to 3 in (13 to 76 mm)	5 in (127 mm) and beyond ④	0.35 in (9 mm) diameter at 5 in (127 mm)	—	2m cable	E65-SMPP100-HL	E65-SMPP100-HD
						4-pin micro DC connector	E65-SMPP100-HLD ⊕	E65-SMPP100-HDD ⊕	

Notes⊕ See listing of compatible connector cables on **Page V8-T5-51**.

① For a complete system, order one source and one detector

② For complete system, order sensor and retroreflector (see **Tab 8, section 8.1**).

③ Nominal range—sensor will detect a 90% reflectance white card at this range.



④ Sensor will ignore a 90% reflectance white card at this range.

Compatible Connector Cables

Micro-Style,
Straight Female



Standard Cables—Micro ①

Voltage Style	Number of Pins	Gauge	Length	Pin Configuration/Wire Colors (Face View Female Shown)	PVC Jacket Catalog Number	PUR Jacket Catalog Number	IRR PUR Jacket Catalog Number
Micro-Style, Straight Female							
AC	4-pin, 4-wire	22 AWG	6 ft (2m)	 1-Red/Black 2-Red/White 3-Red 4-Green	CSAS4F4CY2202	CSAS4F4RY2202	CSAS4F4IO2202
DC	4-pin, 4-wire	22 AWG	6 ft (2m)	 1-Brown 2-White 3-Blue 4-Black	CSDS4A4CY2202	CSDS4A4RY2202	CSDS4A4IO2202

Accessories

SM Series Sensors

Description	Reference
Retroreflectors and retroreflective tape	See Tab 8, section 8.1
Mounting brackets	See Tab 8, section 8.2
Replacement mounting nuts and other accessories	See Tab 8, section 8.3
Connector cables	See Tab 10, section 10.1

Note

① For a full selection of connector cables, see **Tab 10, section 10.1**.

Technical Data and Specifications

SM Series Sensors

Description	AC/DC Model AC Operation Specification	DC Operation Specification	DC Model Specification
Input voltage	18–264 Vac, 50/60 Hz	18–50 Vdc	10–30 Vdc
Power dissipation	4 VA maximum	4 VA maximum	2W maximum
Output type	VMOS (bi-directional)	NPN (sink)	NPN and PNP (dual outputs)
Current switching	200 mA maximum	200 mA maximum	100 mA maximum
Voltage switching	264 Vac	50 Vdc	30 Vdc maximum
OFF-state leakage	500 μ A maximum	500 μ A maximum	10 μ A maximum
Surge current	2A maximum	2A maximum	1A maximum
ON-state voltage drop	3.5V maximum	3.5V maximum	2.5V maximum
Response time	16 ms	1 ms	1 ms
Protection	①	①	①
Light/dark operation	By model	By model	By model
Temperature range			
Operating	–13° to 131°F (–25° to 55°C)	–13° to 131°F (–25° to 55°C)	–13° to 131°F (–25° to 55°C)
Storage	–13° to 158°F (–25° to 70°C)	–13° to 158°F (–25° to 70°C)	–13° to 158°F (–25° to 70°C)
Material of construction	Lens: Polycarbonate; cable jacket: PVC; body: Cyclooy	Lens: Polycarbonate; cable jacket: PVC; body: Cyclooy	Lens: Polycarbonate; cable jacket: PVC; body: Cyclooy
Cable/connector	Cable models: 6 ft (2m) four-wire cable; connector models: 4-pin, micro-connector (AC-key on AC/DC models; DC-key on DC models)	Cable models: 6 ft (2m) four-wire cable; connector models: 4-pin, micro-connector (AC-key on AC/DC models; DC-key on DC models)	Cable models: 6 ft (2m) four-wire cable; connector models: 4-pin, micro-connector (AC-key on AC/DC models; DC-key on DC models)
Vibration and shock	Vibration: 30g over 10 Hz to 2 kHz; shock: 50g for 10 ms 1/2 sinewave pulse	Vibration: 30g over 10 Hz to 2 kHz; shock: 50g for 10 ms 1/2 sinewave pulse	Vibration: 30g over 10 Hz to 2 kHz; shock: 50g for 10 ms 1/2 sinewave pulse
Indicator LEDs	Green LED: Power; red LED: Output; orange LED: TargetLock	Green LED: Power; red LED: Output; orange LED: TargetLock	Green LED: Power; red LED: Output; orange LED: TargetLock
Source light	Visible red, 660 nm	Visible red, 660 nm	Visible red, 660 nm
Gain adjustment	3/4-turn pot, 10:1 adjustment of gain (provided on thru-beam and diffuse reflective sensors only)	3/4-turn pot, 10:1 adjustment of gain (provided on thru-beam and diffuse reflective sensors only)	3/4-turn pot, 10:1 adjustment of gain (provided on thru-beam and diffuse reflective sensors only)
Sunlight immunity	Perfect Prox 5000 ft-candles; all others: 10,000 ft-candles	Perfect Prox 5000 ft-candles; all others: 10,000 ft-candles	Perfect Prox 5000 ft-candles; all others: 10,000 ft-candles
Enclosure ratings	NEMA 1, 3, 4, 4X, 6, 6P, 12 and 13; IP68, IP69K ②	NEMA 1, 3, 4, 4X, 6, 6P, 12 and 13; IP68, IP69K ②	NEMA 1, 3, 4, 4X, 6, 6P, 12 and 13; IP68, IP69K ②

Excess Gain

Thru-Beam

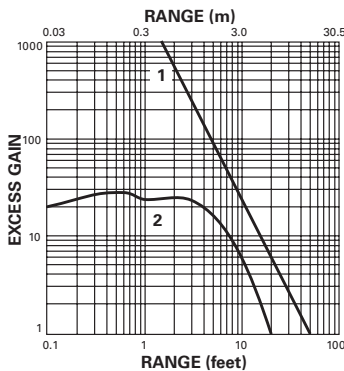

1. Thru-beam
2. Polarized reflex
(based on a 3 in diameter retroreflector)

Perfect Prox

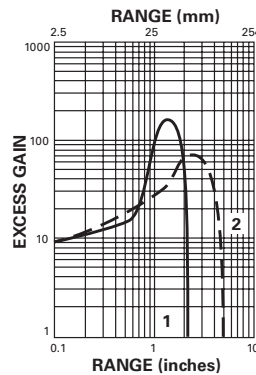

1. 50 mm Perfect Prox
2. 100 mm Perfect Prox

Diffuse Reflective

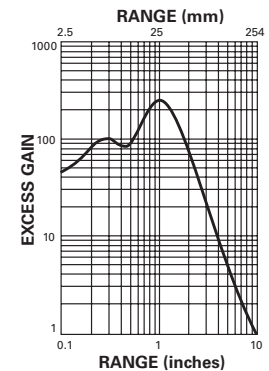

Diffuse reflective (based on a 90% reflectance white card)

Notes

- ① Short circuit and overload protection (output indicator LED will flash). Reverse polarity protection (sensor will reset automatically once fault is removed). **IMPORTANT:** During installation, correct power connections must be made first to ensure fail-safe short circuit protection of the outputs.
- ② Our products conform to NEMA tests as indicated, however, some severe washdown applications can exceed these NEMA test specifications. If you have questions about a specific application, contact our Applications Department.

Wiring Diagrams

Pin numbers are for reference, rely on pin location when wiring.

SM Series Sensors

Operating Voltage	Mode	Cable Model	Micro-Connector Model (Face View Male Shown)
Three-Wire Sensors			
18–264 Vac, 50/60 Hz or 18–50 Vdc	All sensors		
Four-Wire Sensors			
10–30 Vdc	Thru-beam source		
	All others		

Dimensions

Approximate Dimensions in Inches (mm)

SM Series Sensors

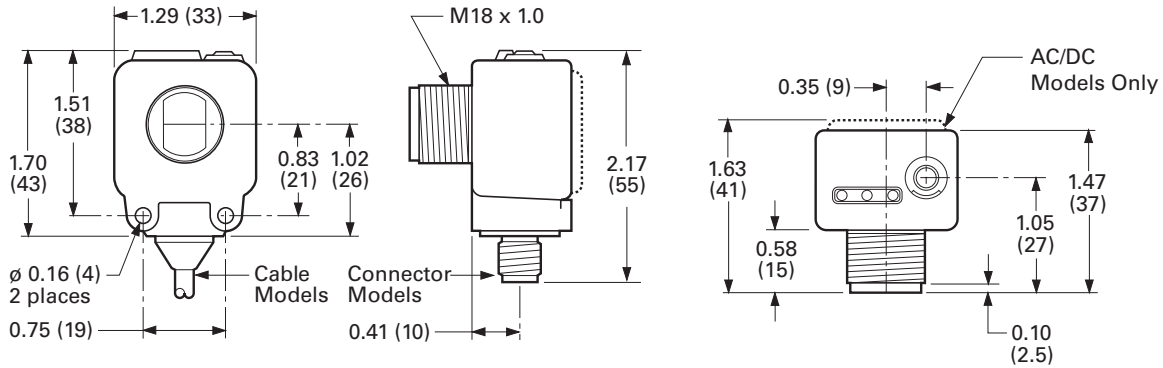

Comet Series Sensors



5

Comet Series Sensors

Product Description

The Comet Series from Eaton's Electrical Sector is a complete line of high performance, 18 mm tubular sensors with a variety of models and modes to solve virtually any sensing problem.

The sensors are available in thru-beam, reflex, polarized reflex, diffuse reflective, focused diffuse reflective, wide angle diffuse reflective, Perfect Prox, fine spot Perfect Prox and fiber optic sensing. Perfect Prox is one of the most powerful problem-solving sensors available. These sensors can reliably detect targets of different color, reflectance, contrast or surface shape at the same range, while ignoring background objects just a fraction of an inch away.

The Comet Series includes AC/DC and DC-only models with two-, three- and four-wire circuitry. Choose from cable or micro-connector. Mini-connectors are available

on two-wire models for easy retrofit. Each sensor features a Light/Dark Operation switch and a gain control to provide for quick adjustment to peak optical performance.

The unique threaded body with flat sides allows quick mounting in a 3/4 inch hole or against any flat surface. Internal components are rigidly sealed in a solid encapsulated package for excellent performance in high-vibration and high-shock applications.

Features

- Industry standard 18 mm diameter threaded body has flat sides allowing it to be mounted like a tubular sensor or against any flat surface
- Right Angle viewing models mount in a depth of only 6/10th of an inch
- Perfect Prox technology provides exceptional background rejection and application problem-solving

Contents

<i>Description</i>	<i>Page</i>
Comet Series Sensors	
Product Overview	V8-T5-55
Product Selection	
Thru-Beam Sensors	V8-T5-56
Reflex Sensors	V8-T5-57
Diffuse Reflective and Focused Diffuse Reflective Sensors	V8-T5-58
Perfect Prox Background Rejection Sensors	V8-T5-59
Fiber Optic Sensors	V8-T5-61
Glass Fiber Optic Adapter	V8-T5-61
Compatible Connector Cables	V8-T5-62
Accessories	V8-T5-62
Technical Data and Specifications	V8-T5-63
Excess Gain	V8-T5-65
Wiring Diagrams	V8-T5-66
Dimensions	V8-T5-66

- Visible sensing beams let you see where the beam is aimed for quick setup and alignment
- Solid polyurethane housing completely encapsulates internal circuits for high resistance to shock and vibration
- Adaptable modulation circuit provides immunity to crosstalk from other closely mounted sensors
- The industry's only background rejection sensors with a two-wire circuit design
- Models available with both AC and DC operation in a single unit—up to 264 Vac
- Four-wire DC sensors offer both NPN and PNP outputs
- Output status indicator visible from a wide 270° angle

Standards and Certifications

- UL Recognized
- cUL Recognized
- CE (except two-wire DC models)



⚠ DANGER

THIS SENSOR IS NOT A SAFETY DEVICE AND IS NOT INTENDED TO BE USED AS A SAFETY DEVICE. This sensor is designed only to detect and read certain data in an electronic manner and perform no use apart from that, specifically no safety-related use. This sensor product does not include self-checking redundant circuitry, and the failure of this sensor product could cause either an energized or de-energized output condition, which could result in death, serious bodily injury, or property damage.

For the most current information on this product, visit our Web site: www.eaton.com

For Customer Service in the U.S. call 1-877-ETN CARE (386-2273), in Canada call 1-800-268-3578.
For Application Assistance in the U.S. and Canada call 1-800-426-9184.

Product Overview

Product Comparison

Eaton's cost-effective Prism Series, OEM Prism and premium Comet Series all share the same 18 mm flat-sided housing. This results in the largest interchangeable sensor family available, allowing you to select from well over 250 different models to solve the widest variety of sensing applications.

Comparison

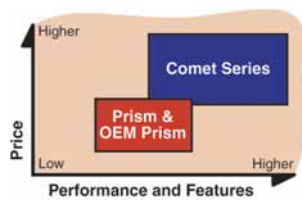

Compared to similar-looking Prism and OEM Prism, the Comet Series includes the following advantages:

- AC/DC two-wire versions available
- Light/dark output configuration
- Perfect Prox background rejection technology

Sensing Modes

Thru-Beam

This sensing mode is available with ranges of 20 and 80 ft (6 and 24m). The 20 ft (6m) range is available in forward and Right Angle viewing, and can be intermixed in any combination for the best fit in your application. Long range models feature a visible sensing beam to help simplify installation and alignment.

Reflex and Polarized Reflex

In reflex sensing, the sensing beam is reflected from a retroreflector back to the sensor. The Comet Series includes standard and polarized models with two-wire, three-wire and four-wire circuits. Right Angle models are also available. Polarized models feature a polarizing filter built into the sensor to ensure that only light reflected from a corner-cube retroreflector is recognized by the sensor. This allows reliable detection of shiny targets that could reflect light and be missed by a non-polarized sensor. Most models include a visible sensing beam for easy installation and alignment.

Diffuse Reflective, Focused Diffuse and Wide Angle Diffuse

A wide variety of diffuse reflective models are available with ranges of 8 in (200 mm) and 24 in (610 mm). Forward and Right Angle viewing configurations offer identical optical performance in this series. Focused diffuse reflective models feature a light beam that is focused at a point 1.6 in (40 mm) in front of the sensor lens for applications where you need to avoid sensing objects in front of or behind the target. Wide angle diffuse models provide a large spot and wide detection area.

Perfect Prox

This is a unique type of diffuse reflective sensor that combines extremely high sensing power (called "excess gain") with a sharp optical cutoff to ignore backgrounds. This allows the sensor to reliably detect targets regardless of variations in color, reflectance, contrast or surface shape, while ignoring objects that are just slightly outside the target range. This gives the Perfect Prox an outstanding ability to solve sensing applications that would be difficult or impossible to manage with other types of sensors. It also makes Perfect Prox one of the easiest photoelectric sensors to set up and use.

Eaton's Comet Series includes more background rejection models than any other family on the market. Choose from forward or Right Angle viewing, two-, three- or four-wire circuits, cable, micro or mini-connector terminations and a variety of sensing ranges. A visible sensing beam on most models lets you quickly confirm that the sensor is aligned correctly with the target. Fine spot models provide an extremely small 0.05 in (1.3 mm) light spot for accurately detecting tiny targets such as fine strands of wire or targets that are in or behind small diameter holes.

Fiber Optic

The Comet Series also includes sensors that utilize fiber optic cables to sense objects where space is restricted, temperatures are high, or tight viewing angles are required. Choose from models that accept low cost plastic fiber optic cables, or use our glass fiber optic adapter that inexpensively converts our standard diffuse reflective sensors for use with durable glass fiber optic cables.

Mounting

Comet Series sensors feature a threaded housing and include two jam nuts and washers for mounting into any 0.75 in (19 mm) hole or a selection of accessory mounting brackets available from Eaton. The flat sides of the sensor feature two mounting holes for easily attaching the sensor to any flat surface with #4 hardware.

Mounting Sensor using #4 Hardware

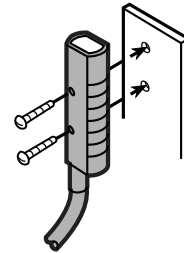

Mounting Sensor using a Jam Nut

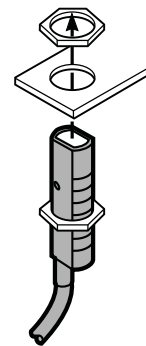



Note: See Pages V8-T5-62 and V8-T5-63, and Tab 8, section 8.2 for a full list of mounting brackets compatible with the Comet Series.

Product Selection

Thru-Beam Sensors

Three-Wire and Four-Wire Sensors

	Operating Voltage	Sensing Range	Optimum Range	Field of View	Thru-Beam Component	Connection Type	Catalog Number	
Thru-Beam Forward Viewing 	Thru-Beam Forward Viewing ^{①②}							
	20–264 Vac 50/60 Hz or 15–30 Vdc (NPN)	20 ft (6m)	0.1 to 10 ft (0.03 to 3m)	30 in (760 mm) diameter at 10 ft (3m) ^③	Source (Visible alignment beam)	6 ft cable	11100A6513	
					Detector	4-pin micro AC connector	11100AQD03 [⊕]	
					Detector	6 ft cable	12100A6513	
						4-pin micro AC connector	12100AQD03 [⊕]	
		80 ft (24m)	0.1 to 40 ft (0.03 to 12m)	40 in (1m) diameter at 40 ft (12m)	Source (Visible red beam)	6 ft cable	11102A6513	
	Detector				4-pin micro AC connector	11102AQD03 [⊕]		
					Detector	6 ft cable	12102A6513	
						4-pin micro AC connector	12102AQD03 [⊕]	
		10–30 Vdc (NPN and PNP)	20 ft (6m)	0.1 to 10 ft (0.03 to 3m)	30 in (760 mm) diameter at 10 ft (3m) ^③	Source (Visible alignment beam)	6 ft cable	11100A6517
	Detector					4-pin micro DC connector	11100AQD07 [⊕]	
					Detector	6 ft cable	12100A6517	
					4-pin micro DC connector	12100AQD07 [⊕]		
		80 ft (24m)	0.1 to 40 ft (0.03 to 12m)	40 in (1m) diameter at 40 ft (12m)	Source (Visible red beam)	6 ft cable	11102A6517	
					Detector	4-pin micro DC connector	11102AQD07 [⊕]	
				Detector	6 ft cable	12102A6517		
					4-pin micro DC connector	12102AQD07 [⊕]		
Thru-Beam Right Angle Viewing 	Thru-Beam Right Angle Viewing ^{①②}							
	20–264 Vac 50/60 Hz or 15–30 Vdc (NPN)	20 ft (6m)	0.1 to 10 ft (0.03 to 3m)	30 in (760 mm) diameter at 10 ft (3m) ^③	Source (Visible alignment beam)	6 ft cable	11100R6513	
					Detector	4-pin micro AC connector	11100RQD03 [⊕]	
					Detector	6 ft cable	12100R6513	
						4-pin micro AC connector	12100RQD03 [⊕]	
		10–30 Vdc (NPN and PNP)	20 ft (6m)	0.1 to 10 ft (0.03 to 3m)	30 in (760 mm) diameter at 10 ft (3m) ^③	Source (Visible alignment beam)	6 ft cable	11100R6517
Detector	4-pin micro DC connector					11100RQD07 [⊕]		
				Detector	6 ft cable	12100R6517		
					4-pin micro DC connector	12100RQD07 [⊕]		

Notes

⊕ See listing of compatible connector cables on **Page V8-T5-62**.



① For a complete system, order one source and one detector.

② 11100 sources and 12100 detectors may be interchanged in any combination. 11102 models must be used with 12102 models.





③ The effective beam (minimum object size that can be detected) is 0.25 in (6.5 mm) diameter.

Reflex Sensors

Two-Wire Sensors

	Operating Voltage	Sensing Range ^①	Optimum Range ^②	Field of View	Sensing Beam	Connection Type	Catalog Number
Standard Reflex Forward Viewing  Sensor Retroreflector ^③	Standard Reflex Forward Viewing						
	90–132 Vac 50/60 Hz or 18–50 Vdc	25 ft (7.6m)	0.1 to 15 ft (0.03 to 4.5m)	1 in (25 mm) diameter at 50 in (1.3m)	Visible red beam	6 ft cable	14102AS6515
						3-pin micro AC connector	14102ASQD05 Ⓢ
Polarized Reflex Forward Viewing  Sensor Retroreflector ^③	Polarized Reflex Forward Viewing ^④						
	90–132 Vac 50/60 Hz or 18–50 Vdc	15 ft (4.5m)	0.1 to 10 ft (0.03 to 3m)	1 in (25 mm) diameter at 50 in (1.3m)	Visible red beam	6 ft cable	14101AS6515
						3-pin micro AC connector	14101ASQD05 Ⓢ

Three-Wire and Four-Wire Sensors

	Operating Voltage	Sensing Range ^①	Optimum Range ^②	Field of View	Sensing Beam	Connection Type	Catalog Number
Standard Reflex Forward Viewing  Sensor Retroreflector ^③	Standard Reflex Forward Viewing ^⑤						
	20–264 Vac 50/60 Hz or 15–30 Vdc (NPN)	25 ft (7.6m)	0.1 to 15 ft (0.03 to 4.5m)	1 in (25 mm) diameter at 50 in (1.3m)	Visible red beam	6 ft cable	14102A6513
						4-pin micro AC connector	14102AQD03 Ⓢ
	10–30 Vdc (NPN and PNP)	25 ft (7.6m)	0.1 to 15 ft (0.03 to 4.5m)	1 in (25 mm) diameter at 50 in (1.3m)	Infrared beam	6 ft cable	14100A6513
						4-pin micro AC connector	14100AQD03 Ⓢ
	10–30 Vdc (NPN and PNP)	25 ft (7.6m)	0.1 to 15 ft (0.03 to 4.5m)	1 in (25 mm) diameter at 50 in (1.3m)	Visible red beam	6 ft cable	14102A6517
4-pin micro DC connector						14102AQD07 Ⓢ	
10–30 Vdc (NPN and PNP)	25 ft (7.6m)	0.1 to 15 ft (0.03 to 4.5m)	1 in (25 mm) diameter at 50 in (1.3m)	Infrared beam	6 ft cable	14100A6517	
					4-pin micro DC connector	14100AQD07 Ⓢ	
Standard Reflex Right Angle Viewing  Sensor Retroreflector ^③	Standard Reflex Right Angle Viewing ^⑤						
	20–264 Vac 50/60 Hz or 15–30 Vdc (NPN)	15 ft (4.5m)	0.1 to 10 ft (0.03 to 3m)	1 in (25 mm) diameter at 50 in (1.3m)	Visible red beam	6 ft cable	14102R6513
						4-pin micro AC connector	14102RQD03 Ⓢ
	10–30 Vdc (NPN and PNP)	15 ft (4.5m)	0.1 to 10 ft (0.03 to 3m)	1 in (25 mm) diameter at 50 in (1.3m)	Visible red beam	6 ft cable	14102R6517
4-pin micro DC connector						14102RQD07 Ⓢ	
Polarized Reflex Forward Viewing  Sensor Retroreflector ^③	Polarized Reflex Forward Viewing ^{④⑤}						
	20–264 Vac 50/60 Hz or 15–30 Vdc (NPN)	15 ft (4.5m)	0.1 to 10 ft (0.03 to 3m)	1 in (25 mm) diameter at 50 in (1.3m)	Visible red beam	6 ft cable	14101A6513
						4-pin micro AC connector	14101AQD03 Ⓢ
	10–30 Vdc (NPN and PNP)	15 ft (4.5m)	0.1 to 10 ft (0.03 to 3m)	1 in (25 mm) diameter at 50 in (1.3m)	Visible red beam	6 ft cable	14101A6517
4-pin micro DC connector						14101AQD07 Ⓢ	
Polarized Reflex Right Angle Viewing  Sensor Retroreflector ^③	Polarized Reflex Right Angle Viewing ^{②④⑤}						
	20–264 Vac 50/60 Hz or 15–30 Vdc (NPN)	10 ft (3m)	0.1 to 5 ft (0.03 to 1.5m)	1 in (25 mm) diameter at 50 in (1.3m)	Visible red beam	6 ft cable	14101R6513
						4-pin micro AC connector	14101RQD03 Ⓢ
	10–30 Vdc (NPN and PNP)	10 ft (3m)	0.1 to 5 ft (0.03 to 1.5m)	1 in (25 mm) diameter at 50 in (1.3m)	Visible red beam	6 ft cable	14101R6517
4-pin micro DC connector						14101RQD07 Ⓢ	

Notes

Ⓢ See listing of compatible connector cables on **Page V8-T5-62**.

① Ranges based on a 3 in diameter retroreflector.

② Right Angle viewing polarized reflex models are rated NEMA 1 only.

See Prism Series on **Page V8-T5-69** for a Right Angle viewing polarized reflex sensor rated NEMA 4X and 6.





③ Retroreflector is not included.

④ Polarized reflex sensors may not operate with retroreflective tape. Test selected tape prior to installation.

⑤ For complete system, order sensor and retroreflector, see **Tab 8, section 8.1**.

Diffuse Reflective and Focused Diffuse Reflective Sensors

Three-Wire and Four-Wire Sensors



	Operating Voltage	Sensing Range ①	Optimum Range	Field of View	Sensing Beam	Connection Type	Catalog Number
Diffuse Reflective Forward Viewing 	Diffuse Reflective Forward Viewing						
	20–264 Vac 50/60 Hz or 15–30 Vdc (NPN)	8 in (200 mm)	0.1 to 5 in (3 to 127 mm)	2 in (50 mm) diameter at 5 in (127 mm)	Infrared beam	6 ft cable	13106A6513
		24 in (610 mm)	0.1 to 15 in (3 to 380 mm)	5 in (127 mm) diameter at 15 in (380 mm)		4-pin micro AC connector	13106AQD03 ⊕
	10–30 Vdc (NPN and PNP)	8 in (200 mm)	0.1 to 5 in (3 to 127 mm)	2 in (50 mm) diameter at 5 in (127 mm)	Infrared beam	6 ft cable	13106A6517
		24 in (610 mm)	0.1 to 15 in (3 to 380 mm)	5 in (127 mm) diameter at 15 in (380 mm)		4-pin micro DC connector	13106AQD07 ⊕
		8 in (200 mm)	0.1 to 15 in (3 to 380 mm)	5 in (127 mm) diameter at 15 in (380 mm)	Infrared beam	6 ft cable	13100A6513
24 in (610 mm)		0.1 to 15 in (3 to 380 mm)	5 in (127 mm) diameter at 15 in (380 mm)	4-pin micro AC connector		13100AQD03 ⊕	
Diffuse Reflective Right Angle Viewing 	Diffuse Reflective Right Angle Viewing						
	20–264 Vac 50/60 Hz or 15–30 Vdc (NPN)	8 in (200 mm)	0.1 to 5 in (3 to 127 mm)	2 in (50 mm) diameter at 5 in (127 mm)	Infrared beam	6 ft cable	13106R6513
		24 in (610 mm)	0.1 to 15 in (3 to 380 mm)	5 in (127 mm) diameter at 15 in (380 mm)		4-pin micro AC connector	13106RQD03 ⊕
	10–30 Vdc (NPN and PNP)	8 in (200 mm)	0.1 to 5 in (3 to 127 mm)	2 in (50 mm) diameter at 5 in (127 mm)	Infrared beam	6 ft cable	13100R6513
		24 in (610 mm)	0.1 to 15 in (3 to 380 mm)	5 in (127 mm) diameter at 15 in (380 mm)		4-pin micro AC connector	13100RQD03 ⊕
		8 in (200 mm)	0.1 to 5 in (3 to 127 mm)	2 in (50 mm) diameter at 5 in (127 mm)	Infrared beam	6 ft cable	13106R6517
24 in (610 mm)		0.1 to 15 in (3 to 380 mm)	5 in (127 mm) diameter at 15 in (380 mm)	4-pin micro DC connector		13106RQD07 ⊕	
	8 in (200 mm)	0.1 to 5 in (3 to 127 mm)	2 in (50 mm) diameter at 5 in (127 mm)	Infrared beam	6 ft cable	13100R6517	
	24 in (610 mm)	0.1 to 15 in (3 to 380 mm)	5 in (127 mm) diameter at 15 in (380 mm)		4-pin micro DC connector	13100RQD07 ⊕	
Wide Beam Diffuse Reflective Forward Viewing 	Wide Beam Diffuse Reflective Forward Viewing						
	20–264 Vac 50/60 Hz or 15–30 Vdc (NPN)	6 in (150 mm)	0.1 to 4 in (3 to 101 mm)	4.3 in (109 mm) diameter at 3 in (76 mm)	Infrared beam	6 ft cable	13107AS6513
		10–30 Vdc (NPN and PNP)	6 in (150 mm)	0.1 to 4 in (3 to 101 mm)		4.3 in (109 mm) diameter at 3 in (76 mm)	4-pin micro AC connector
	6 in (150 mm)	0.1 to 4 in (3 to 101 mm)	4.3 in (109 mm) diameter at 3 in (76 mm)	Infrared beam	6 ft cable	13107AS6517	
	6 in (150 mm)	0.1 to 4 in (3 to 101 mm)	4.3 in (109 mm) diameter at 3 in (76 mm)		4-pin micro DC connector	13107ASQD07 ⊕	
Wide Beam Diffuse Reflective Right Angle Viewing 	Wide Beam Diffuse Reflective Right Angle Viewing						
	20–264 Vac 50/60 Hz or 15–30 Vdc (NPN)	6 in (150 mm)	0.1 to 4 in (3 to 101 mm)	4.3 in (109 mm) diameter at 3 in (76 mm)	Infrared beam	6 ft cable	13107RS6513
		10–30 Vdc (NPN and PNP)	6 in (150 mm)	0.1 to 4 in (3 to 101 mm)		4.3 in (109 mm) diameter at 3 in (76 mm)	4-pin micro AC connector
	6 in (150 mm)	0.1 to 4 in (3 to 101 mm)	4.3 in (109 mm) diameter at 3 in (76 mm)	Infrared beam	6 ft cable	13107RS6517	
	6 in (150 mm)	0.1 to 4 in (3 to 101 mm)	4.3 in (109 mm) diameter at 3 in (76 mm)		4-pin micro DC connector	13107RSQD07 ⊕	
Focused Diffuse Reflective Forward Viewing 	Focused Diffuse Reflective Forward Viewing						
	20–264 Vac 50/60 Hz or 15–30 Vdc (NPN)	Focused at 1.6 in (40 mm)	1.5 to 1.9 in (38 to 48 mm)	0.05 in (1.3 mm) diameter at 1.6 in (40 mm)	Visible red beam	6 ft cable	13102A6513
		10–30 Vdc (NPN and PNP)	Focused at 1.6 in (40 mm)	1.5 to 1.9 in (38 to 48 mm)		0.05 in (1.3 mm) diameter at 1.6 in (40 mm)	4-pin micro AC connector
	Focused at 1.6 in (40 mm)	1.5 to 1.9 in (38 to 48 mm)	0.05 in (1.3 mm) diameter at 1.6 in (40 mm)	Visible red beam	6 ft cable	13102A6517	
	Focused at 1.6 in (40 mm)	1.5 to 1.9 in (38 to 48 mm)	0.05 in (1.3 mm) diameter at 1.6 in (40 mm)		4-pin micro DC connector	13102AQD07 ⊕	

Notes⊕ See listing of compatible connector cables on [Page V8-T5-62](#).

① Sensor will detect a 90% reflective white card at this range.

Perfect Prox Background Rejection Sensors

Two-Wire Sensors

	Operating Voltage	Nominal Range ^①	Optimum Range	Cut-Off Range ^②	Filed of View	Sensing Beam	Connection Type	Catalog Number
 Perfect Prox Forward Viewing	Perfect Prox Forward Viewing							
	90–132 Vac 50/60 Hz or 18–50 Vdc	2 in (50 mm) sharp cutoff	0.4 to 1.8 in (10 to 45 mm)	2.25 in (57 mm) and beyond	0.25 in (6 mm) diameter at 2.25 in (64 mm)	Visible red	6 ft cable	13104A6515
							3-pin micro AC connector	13104AQD05 ☺
							3-pin mini-connector	13104AQD25 ☺
	4 in (100 mm) sharp cutoff	0.5 to 3 in (13 to 76 mm)	5 in (127 mm) and beyond	0.35 in (9 mm) diameter at 5 in (127 mm)	Visible red	6 ft cable	13101AS6515 ☺	
						3-pin micro AC connector	13101ASQD05 ☺ ☹	
3-pin mini-connector						13101ASQD25 ☺ ☹		
 Perfect Prox Right Angle Viewing	Perfect Prox Right Angle Viewing							
	90–132 Vac 50/60 Hz or 18–50 Vdc	2 in (50 mm) sharp cutoff	0.4 to 1.8 in (10 to 45 mm)	2.25 in (57 mm) and beyond	0.25 in (6 mm) diameter at 2.25 in (64 mm)	Visible red	6 ft cable	13104R6515
							3-pin micro AC connector	13104RQD05 ☺
							3-pin mini-connector	13104RQD25 ☺
	4 in (100 mm) sharp cutoff	0.5 to 3 in (13 to 76 mm)	5 in (127 mm) and beyond	0.35 in (9 mm) diameter at 5 in (127 mm)	Visible red	6 ft cable	13101RS6515 ☺	
						3-pin micro AC connector	13101RSQD05 ☺ ☹	
3-pin mini-connector						13101RSQD25 ☺ ☹		

Three-Wire and Four-Wire Sensors

	Operating Voltage	Nominal Range ^①	Optimum Range	Cut-Off Range ^②	Filed of View	Sensing Beam	Connection Type	Catalog Number	
 Perfect Prox Forward Viewing	Perfect Prox Forward Viewing								
	20–264 Vac 50/60 Hz or 15–30 Vdc (NPN)	2 in (50 mm) sharp cutoff	0.4 to 1.8 in (10 to 45 mm)	2.25 in (57 mm) and beyond	0.25 in (6 mm) diameter at 2.25 in (64 mm)	Visible red	6 ft cable	13104A6513	
							4-pin micro AC connector	13104AQD03 ☺	
								6 ft cable	13101A6513
								4-pin micro AC connector	13101AQD03 ☺
		6 in (150 mm) standard cutoff	0.1 to 4 in (3 to 100 mm)	9 in (228 mm) and beyond	0.6 in (15 mm) diameter at 6 in (150 mm)	Infrared	6 ft cable	13108A6513	
							4-pin micro AC connector	13108AQD03 ☺	
	9 in (225 mm) standard cutoff	0.1 to 6 in (3 to 150 mm)	12 in (304 mm) and beyond	0.9 in (23 mm) diameter at 9 in (225 mm)	Infrared	6 ft cable	13103A6513		
						4-pin micro AC connector	13103AQD03 ☺		
	10–30 Vdc (NPN and PNP)	2 in (50 mm) sharp cutoff	0.4 to 1.8 in (10 to 45 mm)	2.25 in (57 mm) and beyond	0.25 in (6 mm) diameter at 2.25 in (64 mm)	Visible red	6 ft cable	13104A6517	
							4-pin micro DC connector	13104AQD07 ☺	
								6 ft cable	13101A6517
							4-pin micro DC connector	13101AQD07 ☺	
6 in (150 mm) standard cutoff		0.1 to 4 in (3 to 100 mm)	9 in (228 mm) and beyond	0.6 in (15 mm) diameter at 6 in (150 mm)	Infrared	6 ft cable	13108A6517		
						4-pin micro DC connector	13108AQD07 ☺		
9 in (225 mm) standard cutoff	0.1 to 6 in (3 to 150 mm)	12 in (304 mm) and beyond	0.9 in (23 mm) diameter at 9 in (225 mm)	Infrared	6 ft cable	13103A6517			
					4-pin micro DC connector	13103AQD07 ☺			

Notes



☺☹ See listing of compatible connector cables on **Page V8-T5-62**.

① Sensor will detect a 90% reflectance card at this range.

② Sensor will ignore a 90% reflectance card at this range.

③ Consult factory for approval status.

Three-Wire and Four-Wire Sensors, continued

	Operating Voltage	Nominal Range ^①	Optimum Range	Cut-Off Range ^②	Filed of View	Sensing Beam	Connection Type	Catalog Number	
Perfect Prox Right Angle Viewing 	Perfect Prox Right Angle Viewing								
	20–264 Vac 50/60 Hz or 15–30 Vdc (NPN)	2 in (50 mm) sharp cutoff	0.4 to 1.8 in (10 to 45 mm)	2.25 in (57 mm) and beyond	0.25 in (6 mm) diameter at 2.25 in (64 mm)		Visible red	6 ft cable	13104R6513
								4-pin micro AC connector	13104RQD03 [⊕]
		4 in (100 mm) sharp cutoff	0.5 to 3 in (13 to 76 mm)	5 in (127 mm) and beyond	0.35 in (9 mm) diameter at 5 in (127 mm)			6 ft cable	13104RS5013
								4-pin micro AC connector	13104RS5003 [⊕]
	6 in (150 mm) standard cutoff	0.1 to 4 in (3 to 100 mm)	9 in (228 mm) and beyond	0.6 in (15 mm) diameter at 6 in (150 mm)		Infrared	6 ft cable	13108R6513	
							4-pin micro AC connector	13108RQD03 [⊕]	
		9 in (225 mm) standard cutoff	0.1 to 6 in (3 to 150 mm)	12 in (304 mm) and beyond			0.9 in (23 mm) diameter at 9 in (225 mm)	6 ft cable	13103R6513
								4-pin micro AC connector	13103RQD03 [⊕]
	10–30 Vdc (NPN and PNP)	2 in (50 mm) sharp cutoff	0.4 to 1.8 in (10 to 45 mm)	2.25 in (57 mm) and beyond	0.25 in (6 mm) diameter at 2.25 in (64 mm)		Visible red	6 ft cable	13104R6517
								4-pin micro DC connector	13104RQD07 [⊕]
		4 in (100 mm) sharp cutoff	0.5 to 3 in (13 to 76 mm)	5 in (127 mm) and beyond	0.35 in (9 mm) diameter at 5 in (127 mm)			6 ft cable	13104RS5020
4-pin micro DC connector								13104RS5007 [⊕]	
6 in (150 mm) standard cutoff	0.1 to 4 in (3 to 100 mm)	9 in (228 mm) and beyond	0.6 in (15 mm) diameter at 6 in (150 mm)		Infrared	6 ft cable	13108R6517		
						4-pin micro DC connector	13108RQD07 [⊕]		
	9 in (225 mm) standard cutoff	0.1 to 6 in (3 to 150 mm)	12 in (304 mm) and beyond			0.9 in (23 mm) diameter at 9 in (225 mm)	6 ft cable	13103R6517	
							4-pin micro DC connector	13103RQD07 [⊕]	
Fine Spot Perfect Prox Forward Viewing 	Fine Spot Perfect Prox Forward Viewing								
	20–264 Vac 50/60 Hz or 15–30 Vdc (NPN)	2 in (50 mm) sharp cutoff	0.9 to 1.8 in (23 to 45 mm)	2.25 in (57 mm) and beyond	0.05 in (1.3 mm) diameter at 1.7 in (43 mm)		Visible red	6 ft cable	13105A6513
								4-pin micro AC connector	13105AQD03 [⊕]
	10–30 Vdc (NPN and PNP)	2 in (50 mm) sharp cutoff	0.9 to 1.8 in (23 to 45 mm)	2.25 in (57 mm) and beyond	0.05 in (1.3 mm) diameter at 1.7 in (43 mm)			6 ft cable	13105A6517
								4-pin micro DC connector	13105AQD07 [⊕]

Notes

⊕ See listing of compatible connector cables on **Page V8-T5-62**.

- ① Sensor will detect a 90% reflectance card at this range.
- ② Sensor will ignore a 90% reflectance card at this range.
- ③ Consult factory for approval status.

Fiber Optic Sensors

Three-Wire and Four-Wire Sensors

Sensing Range (Optimum Range is 50% of Sensing Range) ①

Operating Voltage	Pre-Assembled Fiber Optic Cables						Connection Type	Catalog Number	
	Bulk Length Fibers ②		Thru-Beam Mode		Diffuse Reflective Mode				
	Thru-Beam Mode	Diffuse Reflective Mode	0.5 mm Diameter Fibers	1 mm Diameter Fibers	0.5 mm Diameter Fibers	1 mm Diameter Fibers			
Plastic Fiber Optic Forward Viewing 	18 mm Diameter Plastic Fiber Optic Forward Viewing								
	20–264 Vac 50/60 Hz or 15–30 Vdc (NPN)	5 in (123 mm)	1.5 in (38 mm)	2.1 in (53 mm)	5 in (127 mm)	0.6 in (15 mm)	1.5 in (38 mm)	6 ft cable	15100A6513
								4-pin micro AC connector	15100AQD03 ⊕
10–30 Vdc (NPN and PNP)	5 in (123 mm)	1.5 in (38 mm)	2.1 in (53 mm)	5 in (127 mm)	0.6 in (15 mm)	1.5 in (38 mm)	6 ft cable	15100A6517	
							4-pin micro DC connector	15100AQD07 ⊕	

Glass Fiber Optic Adapter

Use our glass fiber optic adapter with any diffuse reflective sensor model—see below for details.

Glass Fiber Optic Adapter

This simple adapter allows glass fiber optic cables to be used with standard Comet Series diffuse reflective sensors.

Glass Fiber Optic Adapter with Hex Wrench,



Glass Fiber Optic Adapter

Sensors	Fibers	Catalog Number
Glass Fiber Optic Adapter with Hex Wrench		
Forward viewing, diffuse reflective sensors (ordered separately, see Page V8-T5-58)	Glass fiber optic cables (ordered separately, see Tab 9, section 9.2)	6235A-6501
	Note: Use only with the E51KF series fibers.	

Notes

- ⊕ See listing of compatible connector cables on **Page V8-T5-62**.
- ① Ranges are with bare fibers—no lenses. Sensing range is affected by power of sensor, length of fiber optic cable and use of lenses. Lenses will increase ranges. As bulk fiber length increases, sensing range decreases—see table below. For example, for 100 ft of fiber (the total of source and detector fiber lengths), the excess gain shown in gain graphs below would be reduced to about 1/4 its nominal value.

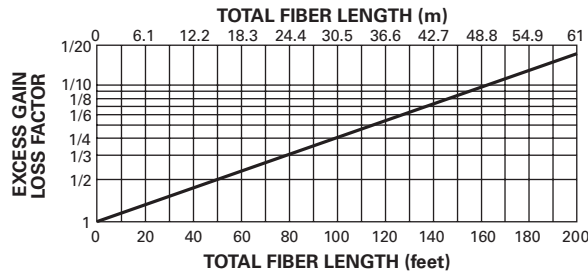



- ② Sensing range is based on 6 ft (2m) of plastic 1 mm diameter source and detector fiber optic cable for a total length of 13.1 ft (4m). To determine performance with longer lengths, see graph above. Compatible fiber optic cables are shown in **Tab 9, section 9.1**.

Compatible Connector Cables

Micro-Style,
Straight Female



Standard Cables—Micro ^①

Voltage Style	Number of Pins	Gauge	Length	Pin Configuration/ Wire Colors (Face View Female Shown)	PVC Jacket Catalog Number	PUR Jacket Catalog Number	IRR PUR Jacket Catalog Number
Micro-Style, Straight Female							
AC	3-pin, 3-wire	22 AWG	6 ft (2m)	 1-Green 2-Red/Black 3-Red/White	CSAS3F3CY2202	CSAS3F3RY2202	—
	4-pin, 4-wire	22 AWG	6 ft (2m)	 1-Red/Black 2-Red/White 3-Red 4-Green	CSAS4F4CY2202	CSAS4F4RY2202	CSAS4F4IO2202
DC	4-pin, 4-wire	22 AWG	6 ft (2m)	 1-Brown 2-White 3-Blue 4-Black	CSDS4A4CY2202	CSDS4A4RY2202	CSDS4A4IO2202

5

Mini-Style,
Straight Female





Standard Cables—Mini ^①

Current Rating at 600V	Voltage Style	Number of Pins	Gauge	Length	Pin Configuration/ Wire Colors (Face View Female Shown)	Catalog Number
Mini-Style, Straight Female						
13A	—	3-pin	16 AWG	6 ft (2m)	 1-Green 2-Black 3-White	CSMS3F3CY1602

Accessories



Comet Series Sensors

Description	Catalog Number
Retroreflectors	
Retroreflectors and retroreflective tape	See Tab 8, section 8.1
Mounting Brackets	
A wide variety of mounting brackets for tubular sensors	See Tab 8, section 8.2
Flush Mount Bracket	
 Contoured design is ideal for flush mounting of Right Angle Comet Series reflex to mounting surface using 1/4-in hardware. No alignment adjustment. Sensor mounts on #4 studs. 304 stainless steel	6161AS5296
 Same as above except without contour. Ideal for right angle diffuse and thru-beam sensors. 304 stainless steel	6161AS5297
Dimensions, see Page V8-T5-68.	

Note

^① For a full selection of connector cables, see **Tab 10, section 10.1.**

Comet Series Sensors, continued

Adjustable Protective Bracket	Description	Catalog Number
	Adjustable Protective Bracket Heavy-duty bracket protects the sensor from damage. Works with all Comet Series sensors except two inch Perfect Prox models. Ideal for material handling applications with Right Angle reflex sensors. Provides locking vertical and horizontal adjustments for independent adjustment in each axis. Sensor mounts on #4 studs. 10 ga. painted steel	E58KS5200
Comet Ball Swivel Bracket 	Comet Ball Swivel Bracket Allows 360° rotation and 10° vertical tilt. Hole spacing is identical to our 50 and 55 Series sensors. Ideal for mounting Right Angle sensors. Made of Noryl.	6181AS5200
Accessories		
Replacement mounting brackets, nuts and other accessories		See Tab 8, sections 8.2 and 8.3
Connector Cables		
A variety of cables, connector blocks and accessories		See Tab 10, section 10.1
Dimensions , see Page V8-T5-68 .		

Technical Data and Specifications

Glass Fiber Optic Adapter

Description	Specification
Sensor specifications	See Comet Series specifications on Page V8-T5-64
Material of construction	Adapter: 360 brass; gasket: silicone
Vibration (sensor/adapter)	30g over 10 Hz to 2 kHz
Shock (sensor/adapter)	50g for 10 ms 1/2 sinewave pulse
Enclosure ratings	NEMA 1 ^①

Note

- ^① The adapter will resist the entrance of moisture in the area between the lenses and the fiber ends when properly assembled. However, moisture entry is possible during direct high pressure sprays. Since the Comet Series sensors are rated NEMA 1, 2, 3, 4, 4X, 6, 12 and 13, this will not result in damage to the sensors themselves.

Comet Series Sensors

Three-Wire and Four-Wire Sensors

Description	AC/DC Models (AC Operation)	AC/DC Models (DC Operation)	DC-Only Models	Two-Wire Sensors AC Models	DC Models
Input voltage	20 to 264 Vac, 50/60 Hz	15 to 30 Vdc (15 to 24 Vdc above 131°F/55°C)	10 to 30 Vdc, (10 to 24 Vdc above 131°F/55°C)	90 to 132 Vac, 50/60 Hz	18 to 50 Vdc
Power dissipation	1.5W maximum	1.5W maximum	1W maximum	2W maximum	2W maximum
Output type	VMOS (bi-directional)	NPN (sink)	NPN and PNP (dual outputs)	DMOS	DMOS
Current switching	300 mA maximum	300 mA maximum	PNP: 100 mA maximum; NPN: 250 mA maximum (NPN: 120 mA maximum above 131°F/55°C)	300 mA	300 mA
Voltage switching	375V peak maximum	375V peak maximum	30 Vdc maximum	132 Vac maximum	50 Vdc maximum
Off-state leakage	250 μ A typical; 500 μ A maximum	250 μ A typical; 500 μ A maximum	10 μ A maximum	1.7 mA maximum	1.5 mA maximum
Surge current	2A maximum	2A maximum	1A maximum	1A maximum	1A maximum
On-state voltage drop	—	1.8V at 10 mA; 3.5V at 300 mA	NPN: 400 mV at 10 mA, 1.5V at 250 mA; PNP: 2.4V at 100 mA	10 Vac	8 Vdc
Response time	10 ms	10 ms	1 ms; 3.5 ms (thru-beam)	32 ms	32 ms
Time delay	Models with fixed time delay available—contact factory	Models with fixed time delay available—contact factory	Models with fixed time delay available—contact factory	Models with fixed time delay available—contact factory	Models with fixed time delay available—contact factory
Short circuit protection	①	①	②	Auto reset	Auto reset
Temperature range					
Thru-beam source	−4° to 158°F (−20° to 70°C)	−4° to 158°F (−20° to 70°C)	−4° to 158°F (−20° to 70°C)	−13° to 131°F (−25° to 55°C)	−13° to 131°F (−25° to 55°C)
All others	−40° to 158°F (−40° to 70°C)	−40° to 158°F (−40° to 70°C)	−40° to 158°F (−40° to 70°C)	—	—
Light/dark operation	Switch selectable	Switch selectable	Switch selectable	Switch selectable	Switch selectable

Description	All Models
Enclosure material	Lens: polycarbonate; cable jacket: PVC; body: structural polyurethane foam (do not expose to concentrated acids, alcohols or ketones)
Cable/connector	Cable versions: 6 ft cable (22 AWG) Connector versions: Male mini- and micro-connectors (refer to wiring diagrams for number of pins per model) on nominal 8 in pigtailed
Vibration and shock	Vibration: 30g over 10 Hz to 2 kHz; shock: 100g for 3 ms 1/2 sine wave pulse
Indicator LED	Lights steady when output is ON; flashes when short circuit protection is in latch condition (except two-wire models)
Sunlight immunity	Perfect Prox: 5000 ft-candles; all others: 10,000 ft-candles
Enclosure ratings	NEMA 1, 2, 3, 4, 4X, 6, 12 and 13 ③④; IP69K

Notes

- ① Sensor will turn off immediately when short or overload is detected (indicator LED flashes). Turn power OFF and back ON to reset.
IMPORTANT: During installation, correct power connections must be made first to ensure fail-safe short circuit protection of outputs.
- ② Sensor will turn off immediately when short or overload is detected (indicator LED flashes). Sensor will reset when short is removed.
- ③ These products conform to NEMA tests as indicated, however, some severe washdown applications can exceed these NEMA test specifications.
- ④ NEMA 6P models available—contact factory.

Excess Gain

Thru-Beam Sensors

Thru-Beam

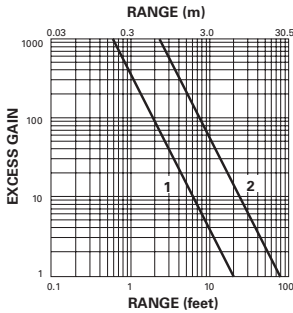

1. 12100A and 12100R detectors using 11100A or 11100R sources
2. 12102A detectors using 11102A sources

Reflex Sensors, Diffuse Reflective Sensors and Focused Diffuse Reflective Sensors

Reflex (3 In Diameter Retroreflector)

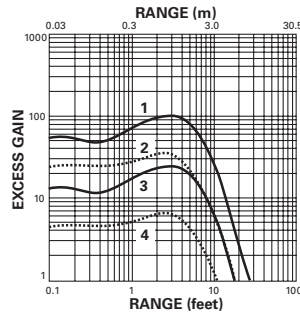

1. 14100A/14102A
2. 14102R
3. 14101A
4. 14101R

Diffuse Reflective (90% Reflective White Card)

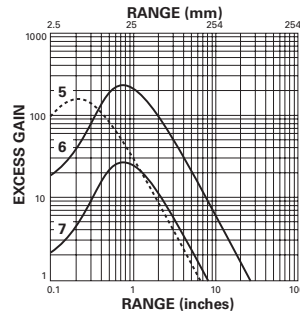

5. 13107
6. 13100
7. 13106

Focused Diffuse Reflective

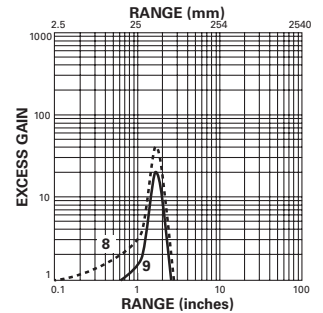

8. 13102A Typical
9. 13102A Minimum

Perfect Prox Sensors

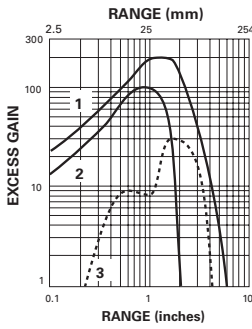

1. 13108A/13108R
2. 13104A
3. 13104RS

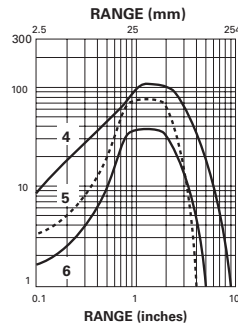

4. 13103A/13103R
5. 13101A Typical
6. 13101A Minimum

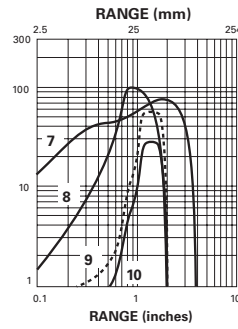

7. 13101AS
8. 13104R
9. 13105A Typical
10. 13105A Minimum

Fiber Optic Sensors (Performance using 13.1 ft [4m] of fiber)

Thru-Beam Mode

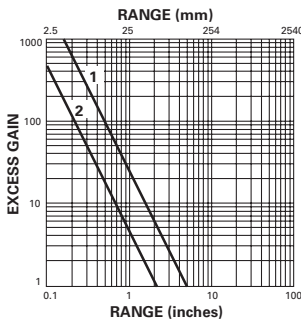

1. 15100 with 1 mm diameter fibers
2. 15100 with 0.5 mm diameter fibers

Diffuse Reflective Mode

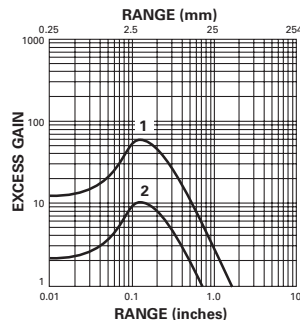

1. 15100 with 1 mm diameter fibers
2. 15100 with 0.5 mm diameter fibers

Glass Fiber Optic Adapters

When Using Single Fibers for Thru-Beam Sensing

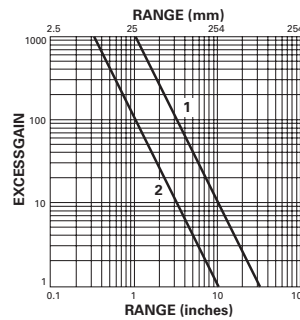

- Gain using E51KF823 fibers
1. 13100A Comet
 2. 13106A Comet

When Using Duplex Fibers for Diffuse Reflective Sensing

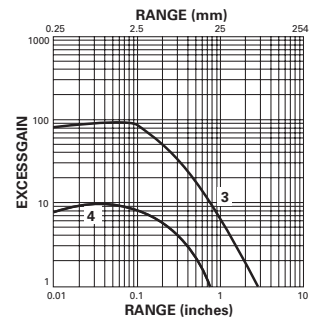

- Gain using E51KF723 fibers, based on 90% reflective white card
3. 13100A Comet
 4. 13106A Comet

Wiring Diagrams

Pin numbers are for reference, rely on pin location when wiring.

AC/DC Models (AC Connection)

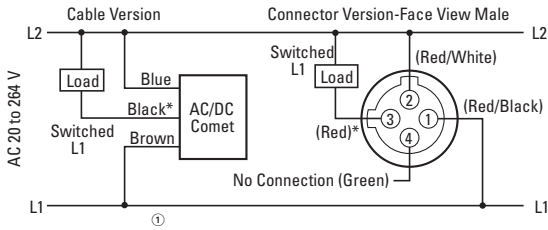

DC Models (Two-Wire)

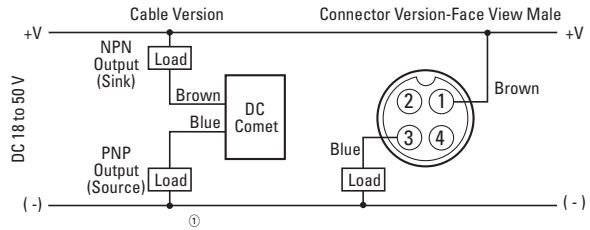

AC Models (AC Connection)

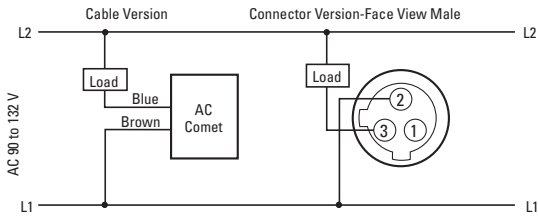

DC Models (Four-Wire)

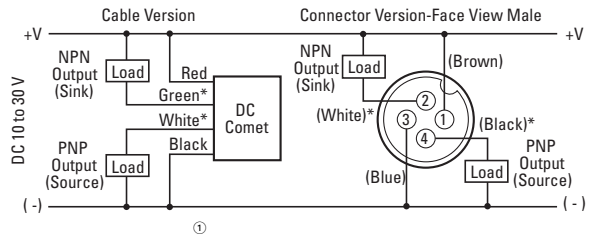

AC/DC Models (DC Connection)

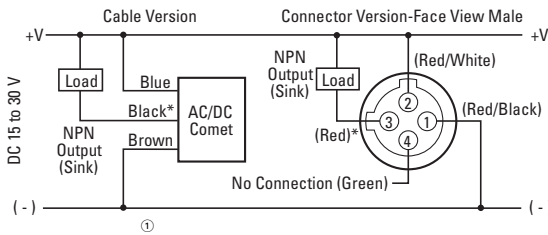

Notes

CAUTION: AC/DC connector version sensors use an AC-type connector. Use of DC power with AC-type connectors may not conform with established standards. For connector versions, the pin numbering and color codes shown are typical of several manufacturers. However, variations are possible. In case of discrepancies, rely on function indicated and pin location rather than pin number or color code.

* No connection when using thru-beam sources.

Dimensions

Approximate Dimensions in Inches (mm), unless otherwise noted

Sensor with Adapter Installed

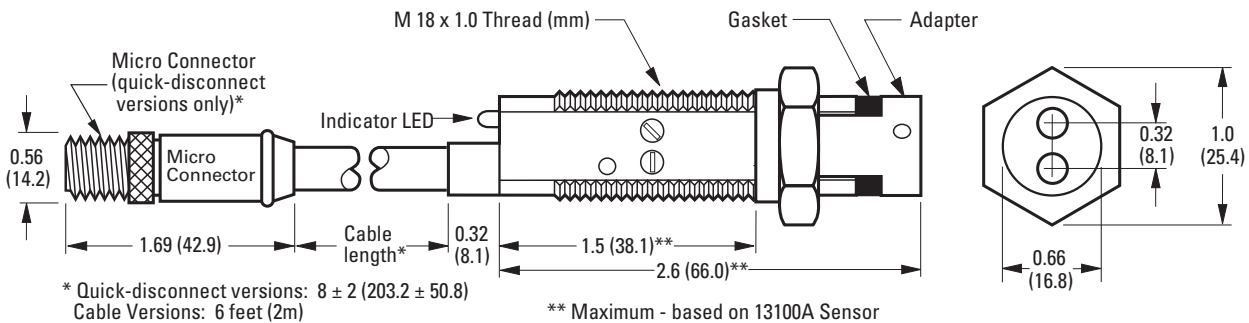

Approximate Dimensions in Inches (mm), unless otherwise noted

Comet Series Sensor Dimensions and Specifications

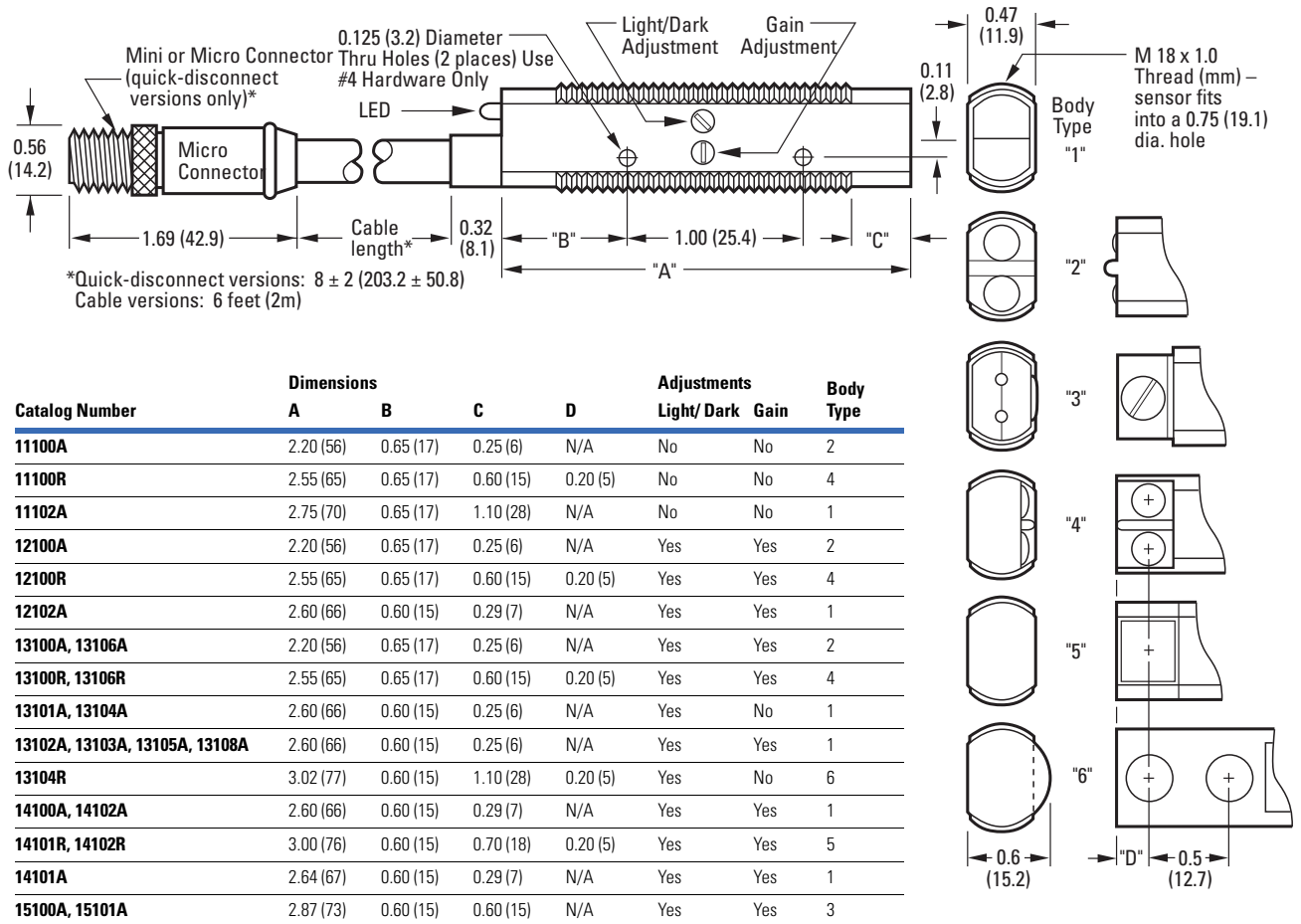

Approximate Dimensions in Inches (mm), unless otherwise noted

Accessories

Flush Mount Bracket—6161AS5296

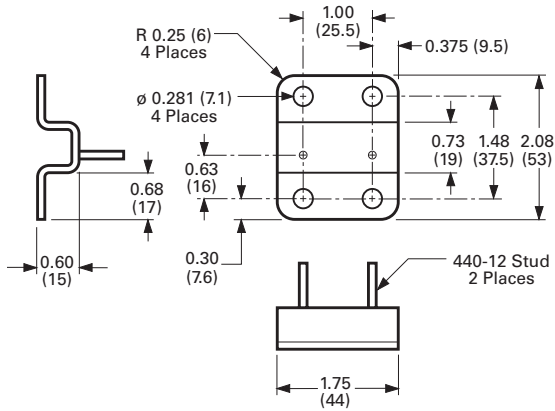

Adjustable Protective Bracket

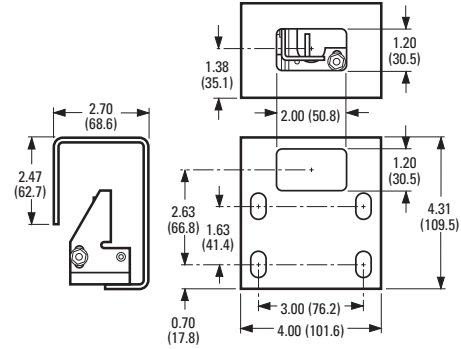

Flush Mount Bracket—6161AS5297

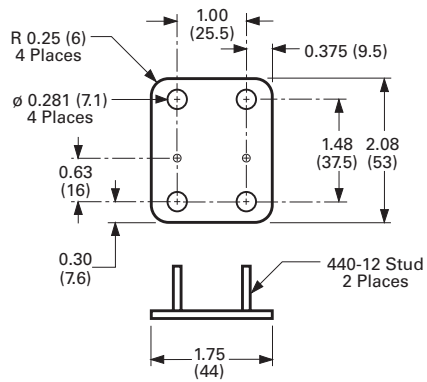

Comet Ball Swivel Bracket

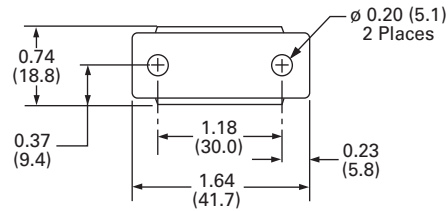

Prism Series Sensors



Prism Series Sensors

Product Description

The Prism Series from Eaton's Electrical Sector is a cost-effective line of miniature photoelectric sensors with twice the optical gain of other sensors in this product class. Forward and Right Angle viewing models feature identical gain and optical characteristics for the best fit on your machine. A gain control allows quick adjustment for peak optical performance in a variety of applications.

Four sensing modes are available, including polarized reflex to eliminate reliability problems when sensing shiny objects. Visible red sensing beams throughout the Prism Series allow you to see exactly where the sensors are aimed for easier setup. Models are available preconfigured in either light or dark operate modes.

The unique threaded body with flat sides allows quick mounting in a 3/4 in hole or against any flat surface. Internal components are rigidly sealed in a solid encapsulated package for excellent performance in high-vibration and high-shock applications.

See **Page V8-T5-73** for details on the Prism Series' flexible isolated output.

Contents

Description

	<i>Page</i>
Prism Series Sensors	
Product Overview	V8-T5-70
Product Selection	
Thru-Beam Sensors	V8-T5-70
Reflex and Diffuse Reflective Sensors	V8-T5-71
Glass Fiber Optic Adapter	V8-T5-71
Compatible Connector Cables	V8-T5-72
Accessories	V8-T5-72
Technical Data and Specifications	V8-T5-73
Excess Gain	V8-T5-74
Wiring Diagrams	V8-T5-75
Dimensions	V8-T5-76

Features

- Small size for use in a wide variety of applications and locations
- High sensing power for longer ranges and resistance to dust and dirt
- Adjustable gain control to ensure peak optical performance
- High noise immunity which greatly reduces problems associated with electrical noise
- AC/DC models which allow you to order and stock one model for both voltages
- DC only models which offer lower cost options in all sensing modes
- Isolated outputs for wiring flexibility
- Short circuit protection
- Quick 3 ms response time on all models
- Highly visible output status LED
- Built-in cable models allow for lowest cost wiring
- Micro-connector models provide for quick installation or replacement
- Custom cable length options

Standards and Certifications

- UL Recognized
- cUL Recognized
- CE

**⚠ DANGER**

THIS SENSOR IS NOT A SAFETY DEVICE AND IS NOT INTENDED TO BE USED AS A SAFETY DEVICE. This sensor is designed only to detect and read certain data in an electronic manner and perform no use apart from that, specifically no safety-related use. This sensor product does not include self-checking redundant circuitry, and the failure of this sensor product could cause either an energized or de-energized output condition, which could result in death, serious bodily injury, or property damage.

For Customer Service in the U.S. call 1-877-ETN CARE (386-2273), in Canada call 1-800-268-3578.
For Application Assistance in the U.S. and Canada call 1-800-426-9184.

For the most current information on this product, visit our Web site: www.eaton.com

Product Overview

Product Comparison

Eaton's cost-effective Prism Series, OEM Prism and premium Comet Series all share the same 18 mm flat-sided housing. This results in the largest interchangeable sensor family available, allowing you to select from well over 250 different models to solve the widest variety of sensing applications.

Comparison

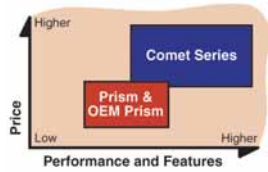

Compared to the similar-looking Comet, the Prism Series is optimized for just value, with a basic feature set best suited for OEMs:

- DC and AC/DC versions
- Isolated AC/DC solid-state outputs

Prism Series

Easy and Flexible Wiring

Prism's isolated output simplifies wiring because it acts like a mechanical relay contact but with solid-state speed and reliability. Use the most convenient available voltage for the sensor while switching to a different voltage with the isolated contact. NPN or PNP is easily determined by the way you wire the output.

Wiring the Prism Series for Logic

With Prism, you can perform simple "and/or" logic without the need for the added cost of an external controller. Low leakage (10 μ A) and resistance ratings (25 ohms) allow Prism sensor outputs to be wired in series or parallel. Two common logic examples are shown at right:

"OR" Function

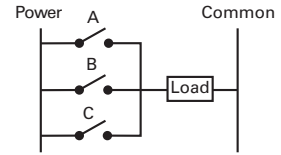

A	B	C	OUTPUT
off	off	off	off
ON	off	off	ON
off	ON	off	ON
off	off	ON	ON

"AND" Function

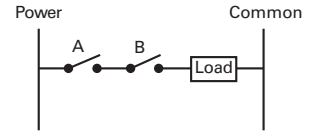

A	B	OUTPUT
off	off	off
ON	off	off
off	ON	off
ON	ON	ON

Product Selection

Thru-Beam Sensors

Three-Wire and Four-Wire Sensors

	Operating Voltage	Sensing Range	Optimum Range	Field of View	Thru-Beam Component	Connection Type	Light Operate Catalog Number	Dark Operate Catalog Number
Thru-Beam Forward Viewing 	Thru-Beam Forward Viewing							
	20–132 Vac 50/60 Hz or 15–30 Vdc	20 ft (6m)	0.1 to 10 ft (0.03 to 3m)	20 in (0.5m) diameter at 10 ft (3m)	Source	6 ft cable	11155AA14	11155AA14
						4-pin micro AC connector	11155AA04 ☼	11155AA04 ☼
					Detector	6 ft cable	12155AL10	12155AD10
						4-pin micro AC connector	12155AL04 ☼	12155AD04 ☼
	10–30 Vdc	20 ft (6m)	0.1 to 10 ft (0.03 to 3m)	20 in (0.5m) diameter at 10 ft (3m)	Source	6 ft cable	11155AA17	11155AA17
					4-pin micro DC connector	11155AA07 ☼	11155AA07 ☼	
Detector					6 ft cable	12155AL10	12155AD10	
					4-pin micro DC connector	12155AL07 ☼	12155AD07 ☼	
Thru-Beam Right Angle Viewing 	Thru-Beam Right Angle Viewing							
	20–132 Vac 50/60 Hz or 15–30 Vdc	20 ft (6m)	0.1 to 10 ft (0.03 to 3m)	20 in (0.5m) diameter at 10 ft (3m)	Source	6 ft cable	11155RA14	11155RA14
						4-pin micro AC connector	11155RA04 ☼	11155RA04 ☼
					Detector	6 ft cable	12155RL10	12155RD10
						4-pin micro AC connector	12155RL04 ☼	12155RD04 ☼
	10–30 Vdc	20 ft (6m)	0.1 to 10 ft (0.03 to 3m)	20 in (0.5m) diameter at 10 ft (3m)	Source	6 ft cable	11155RA17	11155RA17
					4-pin micro DC connector	11155RA07 ☼	11155RA07 ☼	
				Detector	6 ft cable	12155RL10	12155RD10	
					4-pin micro DC connector	12155RL07 ☼	12155RD07 ☼	

Wiring Diagrams, see Page V8-T5-75.





Notes

☼ See listing of compatible connector cables on Page V8-T5-72.

① Synchronous design requires source and detector to be wired to one another.

Reflex and Diffuse Reflective Sensors

Three-Wire and Four-Wire Sensors

	Operating Voltage	Type	Sensing Range	Optimum Range	Field of View	Connection Type	Light Operate Catalog Number	Dark Operate Catalog Number	
Reflex—Forward Viewing ^①  Sensor Retroreflector ^②	Reflex—Forward Viewing								
	20–132 Vac 50/60 Hz or 15–30 Vdc	Standard reflex	15 ft (4.5m) ^③	0.1 to 12 ft (0.03 to 3.6m)	3 in (76 mm) diameter at 12 ft (3.6m)	6 ft cable	14150AL14	14150AD14	
		Polarized reflex	10 ft (3m) ^③	0.1 to 8 ft (0.03 to 2.4m)		4-pin micro AC connector	14150AL04 ☹	14150AD04 ☹	
	10–30 Vdc	Standard reflex	15 ft (4.5m) ^③	0.1 to 12 ft (0.03 to 3.6m)	3 in (76 mm) diameter at 12 ft (3.6m)	6 ft cable	14150AL17	14150AD17	
		Polarized reflex	10 ft (3m) ^③	0.1 to 8 ft (0.03 to 2.4m)		4-pin micro DC connector	14150AL07 ☹	14150AD07 ☹	
		Standard reflex	15 ft (4.5m) ^③	0.1 to 12 ft (0.03 to 3.6m)	3 in (76 mm) diameter at 12 ft (3.6m)	6 ft cable	14151AL14	14151AD14	
Polarized reflex		10 ft (3m) ^③	0.1 to 8 ft (0.03 to 2.4m)		4-pin micro AC connector	14151AL04 ☹	14151AD04 ☹		
Reflex—Right Angle Viewing ^①  Retroreflector ^② Sensor	Reflex—Right Angle Viewing								
	20–132 Vac 50/60 Hz or 15–30 Vdc	Standard reflex	15 ft (4.5m) ^③	0.1 to 12 ft (0.03 to 3.6m)	3 in (76 mm) diameter at 12 ft (3.6m)	6 ft cable	14150RL14	14150RD14	
		Polarized reflex	10 ft (3m) ^③	0.1 to 8 ft (0.03 to 2.4m)		4-pin micro AC connector	14150RL04 ☹	14150RD04 ☹	
	10–30 Vdc	Standard reflex	15 ft (4.5m) ^③	0.1 to 12 ft (0.03 to 3.6m)	3 in (76 mm) diameter at 12 ft (3.6m)	6 ft cable	14150RL17	14150RD17	
		Polarized reflex	10 ft (3m) ^③	0.1 to 8 ft (0.03 to 2.4m)		4-pin micro DC connector	14150RL07 ☹	14150RD07 ☹	
		Standard reflex	15 ft (4.5m) ^③	0.1 to 12 ft (0.03 to 3.6m)	3 in (76 mm) diameter at 12 ft (3.6m)	6 ft cable	14151RL14	14151RD14	
Polarized reflex		10 ft (3m) ^③	0.1 to 8 ft (0.03 to 2.4m)		4-pin micro AC connector	14151RL04 ☹	14151RD04 ☹		
Diffuse Reflective Forward Viewing 	Diffuse Reflective Forward Viewing								
	20–132 Vac 50/60 Hz or 15–30 Vdc	—	8 in (200 mm) ^④	0.15 to 5 in (4 to 127 mm)	0.6 in (15 mm) diameter at 5 in (127 mm)	6 ft cable	13150AL14	13150AD14	
		—	8 in (200 mm) ^④	0.15 to 5 in (4 to 127 mm)	0.6 in (15 mm) diameter at 5 in (127 mm)	4-pin micro AC connector	13150AL04 ☹	13150AD04 ☹	
10–30 Vdc	—	8 in (200 mm) ^④	0.15 to 5 in (4 to 127 mm)	0.6 in (15 mm) diameter at 5 in (127 mm)	6 ft cable	13150AL17	13150AD17		
—	—	8 in (200 mm) ^④	0.15 to 5 in (4 to 127 mm)	0.6 in (15 mm) diameter at 5 in (127 mm)	4-pin micro DC connector	13150AL07 ☹	13150AD07 ☹		
Diffuse Reflective Right Angle Viewing 	Diffuse Reflective Right Angle Viewing								
	20–132 Vac 50/60 Hz or 15–30 Vdc	—	8 in (200 mm) ^④	0.15 to 5 in (4 to 127 mm)	0.6 in (15 mm) diameter at 5 in (127 mm)	6 ft cable	13150RL14	13150RD14	
		—	8 in (200 mm) ^④	0.15 to 5 in (4 to 127 mm)	0.6 in (15 mm) diameter at 5 in (127 mm)	4-pin micro AC connector	13150RL04 ☹	13150RD04 ☹	
10–30 Vdc	—	8 in (200 mm) ^④	0.15 to 5 in (4 to 127 mm)	0.6 in (15 mm) diameter at 5 in (127 mm)	6 ft cable	13150RL17	13150RD17		
—	—	8 in (200 mm) ^④	0.15 to 5 in (4 to 127 mm)	0.6 in (15 mm) diameter at 5 in (127 mm)	4-pin micro DC connector	13150RL07 ☹	13150RD07 ☹		

Glass Fiber Optic Adapter

This simple adapter allows glass fiber optic cables to be used with standard Comet Series diffuse reflective sensors.

Glass Fiber Optic Adapter with Hex Wrench



Glass Fiber Optic Adapter

Sensors	Fibers	Catalog Number
Glass Fiber Optic Adapter with Hex Wrench		
Forward viewing, diffuse reflective sensors (ordered separately, see table above)	Glass fiber optic cables (ordered separately, see Tab 9, section 9.2)	6235A-6501

Notes



- ☹ See listing of compatible connector cables on **Page V8-T5-72**.
- ① For complete system, order sensor and retroreflector (see **Tab 8, section 8.1**).
- ② Retroreflector not included.
- ③ Ranges based on a 3 in diameter retroreflector.
- ④ Sensor will detect a 90% reflectance white card at this range.

Compatible Connector Cables

Micro-Style,
Straight Female



Standard Cables—Micro ^①

Voltage Style	Number of Pins	Gauge	Length	Pin Configuration/ Wire Colors (Face View Female Shown)	PVC Jacket Catalog Number	PUR Jacket Catalog Number	IRR PUR Jacket Catalog Number
Micro-Style, Straight Female							
AC	4-pin, 4-wire	22 AWG	6 ft (2m)		CSAS4F4CY2202	CSAS4F4RY2202	CSAS4F4IO2202
DC	4-pin, 4-wire	22 AWG	6 ft (2m)		CSDS4A4CY2202	CSDS4A4RY2202	CSDS4A4IO2202

5

Accessories

Prism Series Sensors

Description	Catalog Number
Retroreflectors	
Retroreflectors and retroreflective tape	See Tab 8, section 8.1
Mounting Brackets	
A wide variety of mounting brackets for tubular sensors	See Tab 8, section 8.2
Flush Mount Bracket	
Flush Mount Bracket Contoured design is ideal for flush mounting of Right Angle Prism Series reflex to mounting surface using 1/4 in hardware. No alignment adjustment. Sensor mounts on #4 studs. 304 stainless steel	6161AS5296
Flush Mount Bracket Same as above except without contour. Ideal for right angle diffuse and thru-beam sensors. 304 Stainless Steel	6161AS5297
Adjustable Protective Bracket Heavy-duty bracket protects the sensor from damage. Works with all Prism Series sensors. Ideal for material handling applications with Prism right angle reflex sensors. Provides locking vertical and horizontal adjustments for independent adjustment in each axis. Sensor mounts on #4 studs. 10 ga. painted steel	E58KS5200
Comet/Prism Ball Swivel Bracket Allows 360° rotation and 10° vertical tilt. Hole spacing is identical to our 50 and 55 Series sensors. Ideal for mounting Right Angle sensors. Made of Noryl.	6181AS5200
Accessories	
Replacement mounting nuts and other accessories	See Tab 8, sections 8.2 and 8.3
Connector Cables	
A variety of cables, connector blocks and accessories	See Tab 10, section 10.1
Dimensions, see Page V8-T5-76.	
Note	
^① For a full selection of connector cables, see Tab 10, section 10.1.	

Technical Data and Specifications

Glass Fiber Optic Adapter

Description	Specification
Sensor specifications	See Prism Series specifications below
Material of construction	Adapter: 360 brass; gasket: silicone
Vibration (sensor/adapter)	30g over 10 Hz to 2 kHz
Shock (sensor/adapter)	50g for 10 ms 1/2 sinewave pulse
Enclosure ratings	NEMA 1 ^①

Prism Series Sensors

Description	AC/DC Models	DC Only Models
Input voltage	20 to 132 Vac, 50/60 Hz or 15 to 30 Vdc	10 to 30 Vdc
Power dissipation	Thru-beam: 2W maximum; All others: 1.5W maximum	Thru-beam: 1.5W maximum; All others: 1W maximum
Output type	Solid-state relay	Solid-state relay
Output isolation	400V maximum	400V maximum
Voltage switching capacity	200 Vac peak; 180 Vdc	200 Vac peak; 180 Vdc
Current switching capacity	80 mA AC load, 110 mA at 132 Vdc (derate to 100 mA at 180 Vdc)	80 mA AC load, 110 mA at 132 Vdc (derate to 100 mA at 180 Vdc)
Off-state leakage	10 μ A maximum	10 μ A maximum
On-state resistance	25 ohms maximum	25 ohms maximum
Short circuit protection	Protected (current limited) for loads less than 32 Vac or Vdc ^②	Protected (current limited) for loads less than 32 Vac or Vdc ^②
Response time	3 ms	3 ms
Light/dark operation	Specified by catalog number	Specified by catalog number
Temperature range		
Operating	-13° to 131°F (-25° to 55°C)	-13° to 131°F (-25° to 55°C)
Storage	-13° to 158°F (-25° to 70°C)	-13° to 158°F (-25° to 70°C)
Material of construction	Lens: polycarbonate; cable jacket: PVC; body: structural polyurethane foam ^③	Lens: polycarbonate; cable jacket: PVC; body: structural polyurethane foam ^③
Cable versions	2m length, 4-conductor cable; micro 4-pin male connector	2m length, 4-conductor cable; micro 4-pin male connector
Connector versions	Micro-connector 4-pin male AC or DC key (by model)	Micro-connector 4-pin male AC or DC key (by model)
Vibration and shock	Vibration: 30g over 10 Hz to 2 kHz; shock: 50g for 10 ms 1/2 sine wave pulse	Vibration: 30g over 10 Hz to 2 kHz; shock: 50g for 10 ms 1/2 sine wave pulse
LED indicator	Thru-beam source: Lights steady when power is ON; all others: Light steady when output is ON	Thru-beam source: Lights steady when power is ON; all others: Light steady when output is ON
Thru-beam alignment aid	Detector includes a visible LED behind lens that lights steady when beam is complete	Detector includes a visible LED behind lens that lights steady when beam is complete
Enclosure ratings	NEMA 1, 2, 3, 4, 4X, 6, 12 and 13 ^④	NEMA 1, 2, 3, 4, 4X, 6, 12 and 13 ^④

Notes

- ^① The adapter will resist the entrance of moisture in the area between the lenses and the fiber ends when properly assembled. However, moisture entry is possible during direct high pressure sprays. Since the Prism Series sensors are rated NEMA 1, 2, 3, 4, 4X, 6, 12 and 13, this will not result in damage to the sensors themselves.
- ^② **IMPORTANT:** Output will reset automatically when short is removed (there is no visual indication of a short circuit condition)
- ^③ Do not expose to concentrated acids, alcohols or ketones.
- ^④ Photoelectric sensors conform to NEMA tests as indicated above, however, some severe washdown applications can exceed these NEMA test specifications.

Excess Gain

Thru-Beam Sensors

Thru-Beam

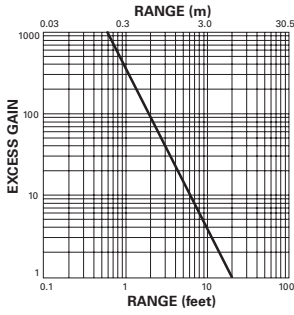

Reflex and Diffuse Reflective Sensors

Polarized Reflex (3 in diameter retroreflector)

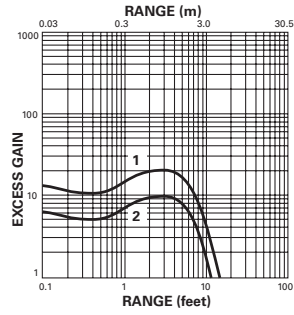

1. 14151 Typical performance
2. 14151 Minimum performance

Diffuse Reflective (90% reflective white card)

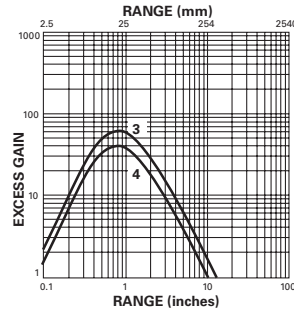

3. 13151 Typical performance
4. 13151 Minimum performance

Glass Fiber Optic Adapter

When Using Single Fibers for Thru-Beam Sensing

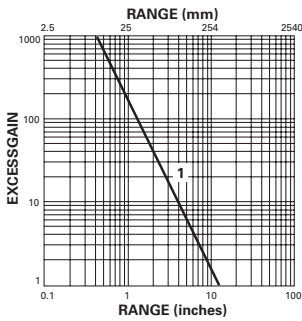

- Gain using E51KF823 fibers
1. 13150A Prism

When Using Duplex Fibers for Diffuse Reflective Sensing

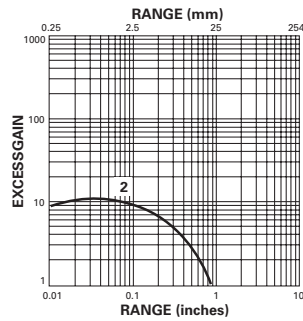

- Gain using E51KF723 fibers, based on 90% reflective white card
2. 13150A Prism

Wiring Diagrams

Pin numbers are for reference, rely on pin location when wiring.

Thru-Beam Sensors

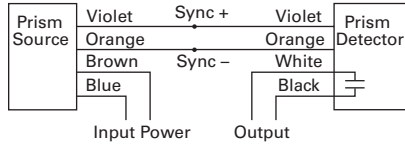

See Prism Series wiring diagrams below for details on wiring power and output.

Prism Series Sensors

AC/DC Models ①②

All AC/DC Models (except Thru-Beam)

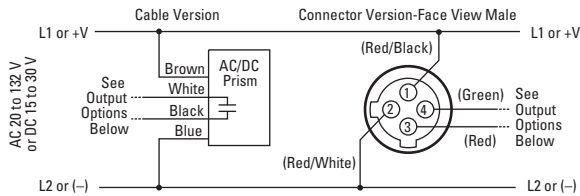

DC Models ①②③

All DC Models (except Thru-Beam)

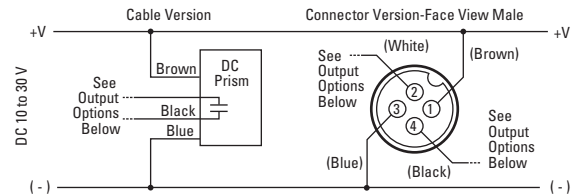

AC/DC Thru-Beam Wiring

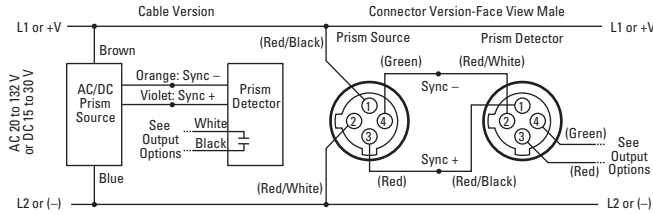

DC Thru-Beam Wiring

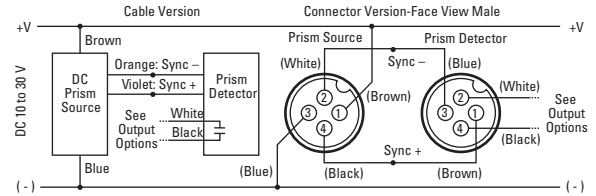

AC/DC Isolated Output Options

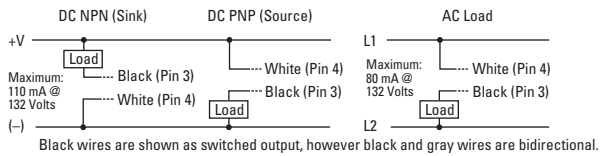

DC Isolated Output Options

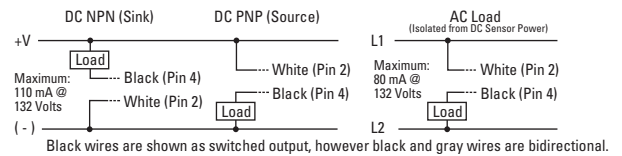

Notes

- ① Cable versions: The color codes are the actual wire colors emanating from the sensor.
- ② Connector versions: The pin numbering and wire colors, shown in (), are typical of several manufacturers, however, variations are possible. In case of discrepancies, rely on function indicated and pin location rather than pin number or wire color.
- ③ Sensor operates on DC voltage, but isolated output can switch AC or DC loads.

5.6

Photoelectric Sensors

Prism Series Sensors

Dimensions

Approximate Dimensions in Inches (mm) except where noted.

Sensor with Adapter Installed

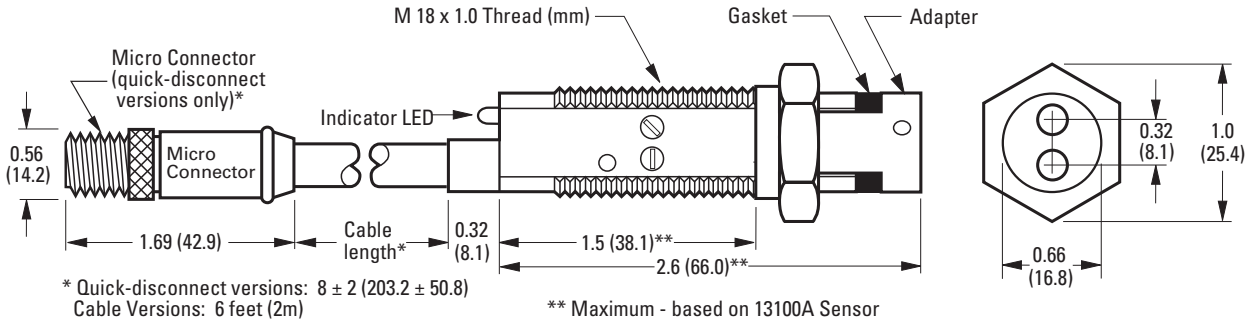

Reflex and Polarized Reflex Models

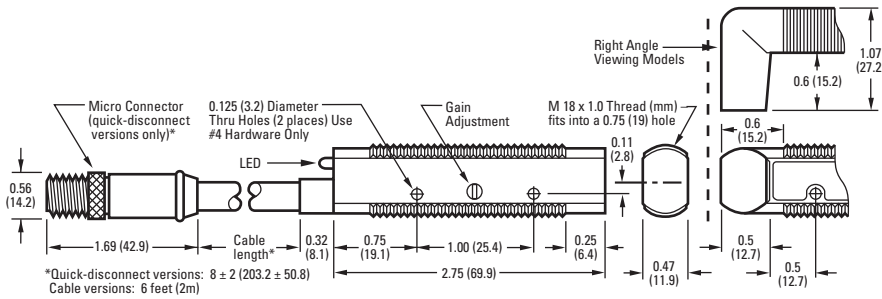

Diffuse Reflective and Thru-Beam Models

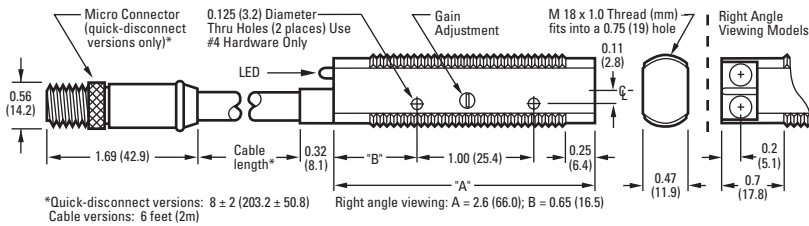

Approximate Dimensions in Inches (mm)

Accessories

Flush Mount Bracket—6161AS5296

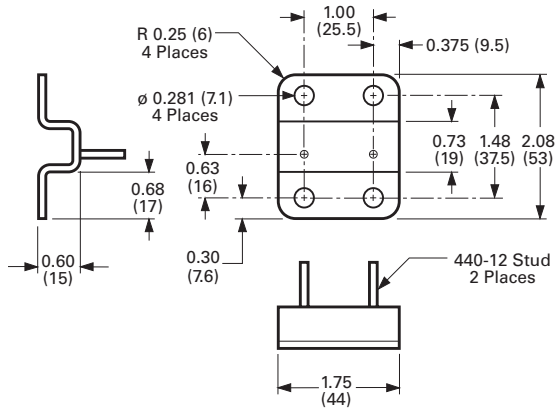

Adjustable Protective Bracket

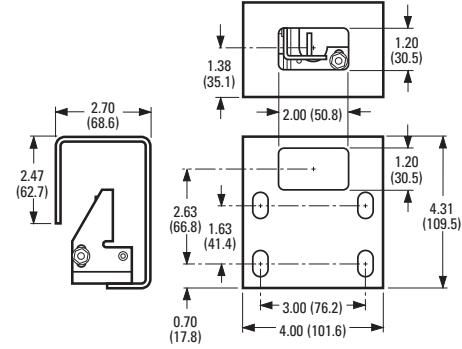

Flush Mount Bracket—6161AS5297

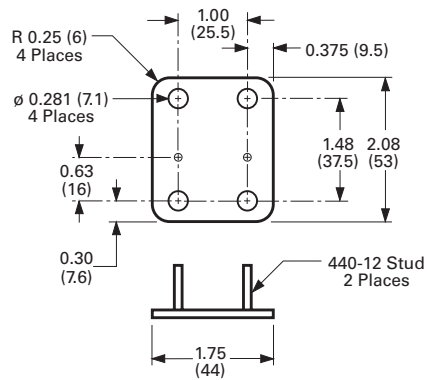

Comet/Prism Ball Swivel Bracket

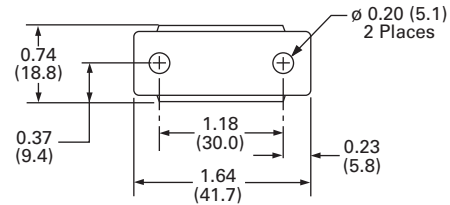

OEM Prism Series Sensors



5

OEM Prism Series Sensors

Product Description

The OEM Prism Series from Eaton's Electrical Sector is very similar to our standard cost-effective Prism Series and has been optimized for high volume OEM use. In place of the isolated output found in the standard models, the OEM Prism features dual or single discrete outputs for simple wiring. In addition, OEM Prism sensors are shipped bulk packaged for easier handling by both the receiver and the installer. Forward and Right Angle viewing models feature identical gain and optical characteristics for the best fit on your machine. A gain control allows quick adjustment for peak optical performance in a variety of applications. Both diffuse reflective and polarized reflex models are available.

All models are 10–30 Vdc only to meet the evolving needs of your customers. Polarized reflex units eliminate reliability problems when sensing shiny objects. Visible red sensing beams allow you to see exactly where the sensors are aimed for easier setup. Models are available preconfigured in either light or dark operate modes.

The unique threaded body with flat sides allows quick mounting in a 3/4 in hole or against any flat surface. Internal components are rigidly sealed in a solid encapsulated package for excellent performance in high-vibration and high-shock applications.

Contents

Description	Page
OEM Prism Series Sensors	
Product Overview	V8-T5-70
Product Selection	
OEM Prism Series Sensors	V8-T5-79
Compatible Connector Cables	V8-T5-80
Accessories	V8-T5-80
Technical Data and Specifications	V8-T5-81
Excess Gain	V8-T5-81
Wiring Diagrams	V8-T5-82
Dimensions	V8-T5-82

Features

- Small size for use in a wide variety of applications and locations
- Sensors are shipped bulk-packed for the convenience of high volume users
- High sensing power for longer ranges and resistance to dust and dirt
- Adjustable gain control to ensure peak optical performance
- High noise immunity, which greatly reduces problems associated with electrical noise
- NPN and PNP outputs provided in a single sensor for simple wiring
- Short circuit protection
- Quick 1.2 ms response time
- Output status LED is highly visible from a wide 300° angle
- Cable models allow for lowest cost wiring
- Micro-connector models provide for quick installation or replacement
- Custom cable length options

Standards and Certifications

- CE

DANGER

THIS SENSOR IS NOT A SAFETY DEVICE AND IS NOT INTENDED TO BE USED AS A SAFETY DEVICE. This sensor is designed only to detect and read certain data in an electronic manner and perform no use apart from that, specifically no safety-related use. This sensor product does not include self-checking redundant circuitry, and the failure of this sensor product could cause either an energized or de-energized output condition, which could result in death, serious bodily injury, or property damage.

For the most current information on this product, visit our Web site: www.eaton.com

For Customer Service in the U.S. call 1-877-ETN CARE (386-2273), in Canada call 1-800-268-3578.

For Application Assistance in the U.S. and Canada call 1-800-426-9184.

Product Overview

Product Comparison

Eaton’s cost-effective Prism Series, OEM Prism and premium Comet Series all share the same 18 mm flat-sided housing. This results in the largest interchangeable sensor family available, allowing you to select from well over 250 different models to solve the widest variety of sensing applications.

Comparison

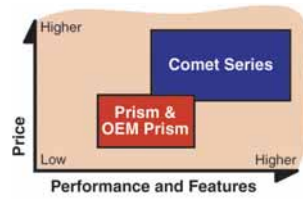



Compared to the similar-looking Comet, the OEM Prism is optimized for value, with a basic feature set best suited for OEMs.

Product Selection

OEM Prism Series Sensors

Three-Wire and Four-Wire Sensors

	Operating Voltage	Sensing Range	Optimum Range	Field of View	Output Type	Connection Type	Light Operate Catalog Number	Dark Operate Catalog Number
Polarized Reflex Forward Viewing ^{①②}								
Polarized Reflex Forward Viewing  Sensor Retroreflector ^③	10–30 Vdc	10 ft (3m) ^④	0.1 to 8 ft (0.03 to 2.4m)	3 in (76 mm) diameter at 12 ft (3.6m)	NPN and PNP	6 ft cable	14156AL17B1	14156AD17B1
						4-pin micro DC connector	14156AL07B1 [⊕]	14156AD07B1 [⊕]
Polarized Reflex Right Angle Viewing ^{①②}								
Polarized Reflex Right Angle Viewing  Retroreflector ^③ Sensor	10–30 Vdc	10 ft (3m) ^④	0.1 to 8 ft (0.03 to 2.4m)	3 in (76 mm) diameter at 12 ft (3.6m)	NPN and PNP	6 ft cable	14156RL17B1	14156RD17B1
						4-pin micro DC connector	14156RL07B1 [⊕]	14156RD07B1 [⊕]
Diffuse Reflective Right Angle Viewing ^①								
Diffuse Reflective Right Angle Viewing 	10–30 Vdc	8 in (200 mm) ^⑤	0.1 to 5 in (3 to 127 mm)	2 in (51 mm) diameter at 5 in (127 mm)	NPN and PNP	6 ft cable	13156RL17B1	13156RD17B1
		24 in (609 mm) ^⑤	0.1 to 15 in (3 to 381 mm)	6 in (152 mm) diameter at 15 in (381 mm)		4-pin micro DC connector	13156RL07B1 [⊕]	13156RD07B1 [⊕]
						6 ft cable	13157RL17B1	13157RD17B1
						4-pin micro DC connector	13157RL07B1 [⊕]	13157RD07B1 [⊕]

Notes

- ⊕ See listing of compatible connector cables on **Page V8-T5-80**.
- ① Contact factory for approval status.
- ② For a complete system, order sensor and retroreflector (see **Tab 8, section 8.1**).
- ③ Retroreflector not included.
- ④ Ranges based on a 3 in diameter retroreflector.
- ⑤ Sensor will detect a 90% reflectance white card at this range.

Compatible Connector Cables

Micro-Style,
Straight Female



Standard Cables—Micro ^①

Voltage Style	Number of Pins	Gauge	Length	Pin Configuration/ Wire Colors (Face View Female Shown)	PVC Jacket Catalog Number	PUR Jacket Catalog Number	IRR PUR Jacket Catalog Number
Micro-Style, Straight Female							
DC	4-pin, 4-wire	22 AWG	6 ft (2m)	 1-Brown 2-White 3-Blue 4-Black	CSDS4A4CY2202	CSDS4A4RY2202	CSDS4A4IQ2202

5

Accessories

OEM Prism Series Sensors

Description	Catalog Number
Retroreflectors	
Retroreflectors and retroreflective tape	See Tab 8, section 8.1
Mounting Brackets	
A wide variety of mounting brackets for tubular sensors	See Tab 8, section 8.2
Flush Mount Bracket	
Contoured design is ideal for flush mounting of right angle OEM Prism Series polarized reflex to mounting surface using 1/4 in hardware. No alignment adjustment. Sensor mounts on #4 studs. 304 stainless steel	6161AS5296
Flush Mount Bracket	
Same as above except without contour. Ideal for right angle diffuse sensors. 304 stainless steel	6161AS5297
Adjustable Protective Bracket	
Heavy-duty bracket protects the sensor from damage. Works with all OEM Prism Series sensors. Ideal for material handling applications with the OEM Prism Series right angle polarized reflex sensor. Provides locking vertical and horizontal adjustments for independent adjustment in each axis. Sensor mounts on #4 studs. 10 ga. painted steel	E58KS5200
Comet/Prism Ball Swivel Bracket	
Allows 360° rotation and 10° vertical tilt. Hole spacing is identical to our 50 and 55 Series sensors. Ideal for mounting Right Angle sensors. Made of Noryl.	6181AS5200
Accessories	
Replacement mounting nuts and other accessories	See Tab 8, sections 8.2 and 8.3
Connector Cables	
A variety of cables, connector blocks and accessories	See Tab 10, section 10.1
Dimensions, see Page V8-T5-77.	

Note

^① For a full selection of connector cables, see **Tab 10, section 10.1**.

Technical Data and Specifications

OEM Prism Series Sensors

Description	DC Only Models
Input voltage	10 to 30 Vdc
Power dissipation	1W maximum
Output type	NPN and PNP
Current switching capacity	100 mA maximum
OFF-state leakage	10 µA maximum
ON-state voltage drop	NPN: 2.0V at 100 mA; PNP: 2.5V at 100 mA
Short circuit protection	Sensor will turn off immediately when short or overload is detected (indicator LED flashes). Sensor will reset when short is removed.
Response time	1.2 ms
Light/dark operation	Specified by catalog number
Temperature range	
Operating	-13° to 131°F (-25° to 55°C)
Storage	-13° to 158°F (-25° to 70°C)
Sunlight immunity	1000 ft-candles
Material of construction	Lens: polycarbonate; cable jacket: PVC; body: structural polyurethane foam (do not expose to concentrated acids, alcohols or ketones)
Cable versions	2m length; 4 conductor cable
Connector versions	Micro-connector, 4-pin male, DC key, on nominal 8 in pigtail
Vibration and shock	Vibration: 30g over 10 Hz to 2 kHz; shock: 50g for 10 ms 1/2 sine wave pulse
Indicator LED	Lights steady when output is ON; OFF when output is OFF; OFF when output is in short circuit mode
Enclosure ratings	NEMA 1, 2, 3, 4, 4X, 6, 12 and 13 ①

Excess Gain

Polarized Reflex (3 in diameter retroreflector)

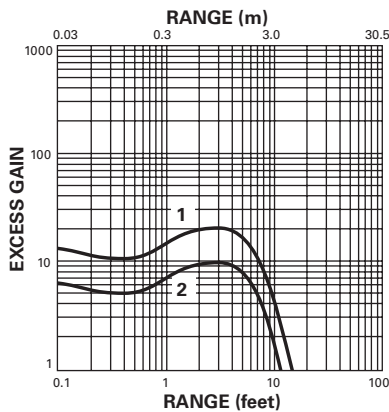

- 1. 14156 Typical performance
- 2. 14156 Minimum performance

Diffuse Reflective (90% reflective white card)

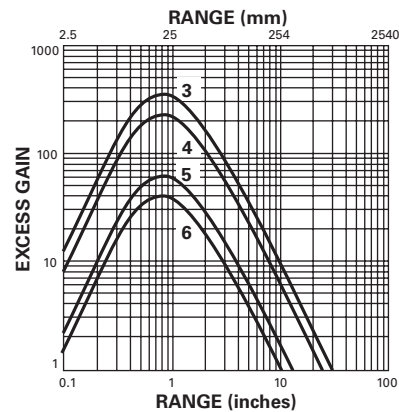

- 3. 13157 Typical performance
- 4. 13157 Minimum performance
- 5. 13156 Typical performance
- 6. 13156 Minimum performance

Note

① Photoelectric sensors conform to NEMA tests as indicated above, however, some severe washdown applications can exceed these NEMA test specifications.

Wiring Diagrams

Pin numbers are for reference, rely on pin location when wiring.

OEM Prism Series Sensors

Operating Voltage	Output	Cable Models	Micro-Connector Models (Face View Male Shown)
Four-Wire Sensors			
10–30 Vdc	NPN and PNP		

5

Dimensions

Approximate Dimensions in Inches (mm) except where noted

Polarized Reflex Models

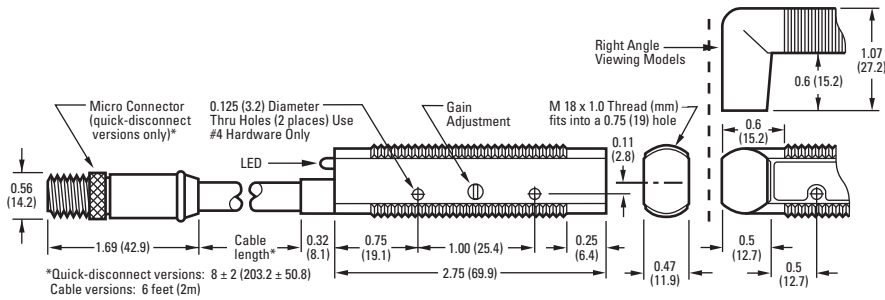

Diffuse Reflective Models

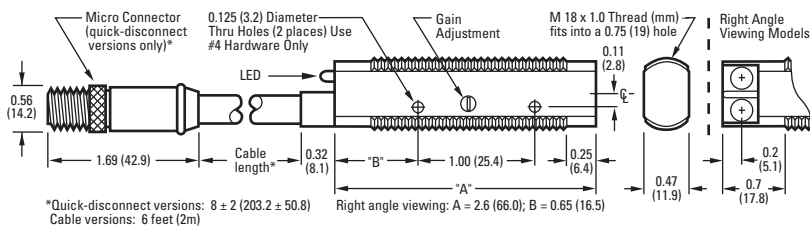

Approximate Dimensions in Inches (mm)

Accessories

Flush Mount Bracket—6161AS5296

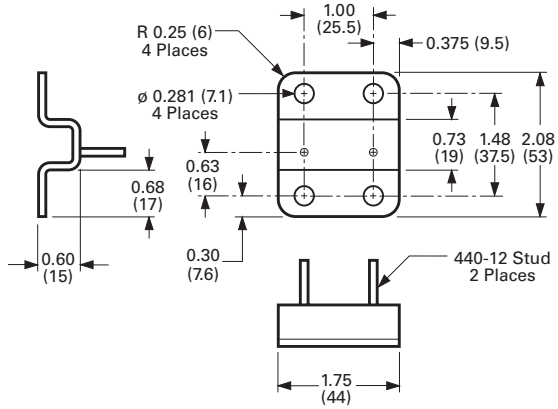

Adjustable Protective Bracket

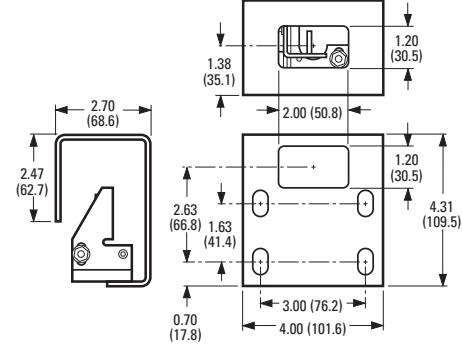

Flush Mount Bracket—6161AS5297

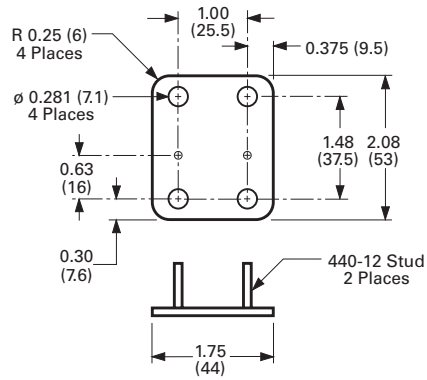

Comet/Prism Ball Swivel Bracket

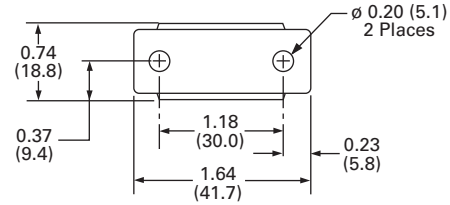

E58 Harsh Duty Series Sensors



5

E58 Harsh Duty Series Sensors

Product Description

The E58 Harsh Duty Series by Eaton's Electrical Sector was designed to withstand your harshest physical, chemical and optical environments.

Extensive research dictated the choice of materials used in this sensor. Stainless steel, PVDF and tempered glass components are mechanically assembled using Viton® seals to ensure complete sealing and resistance to industry chemicals. All adhesives and potting subject to failure from chemical attack have been eliminated from the design. The result is a sensor highly resistant to chemical attack and moisture intrusion, that can withstand heavy shock and vibration in almost any application.

E58 Harsh Duty sensors feature unparalleled optical performance. They are ideal for automotive applications where exposure to lubricants, cutting fluids, coolants and glycols is common. For food processing applications, a smooth body version simplifies high-pressure chemical washdowns, and withstands the use of sanitizers, surfactants, and cleaning agents including diluted bases and acids.

Features

- Sensors are available in 18 mm and 30 mm diameters
- Highly refined optics for long sensing ranges and to see through high levels of contamination—unmatched optical performance
- Perfect Prox technology provides exceptional background rejection and extremely high excess gain

Contents

<i>Description</i>	<i>Page</i>
E58 Harsh Duty Series Sensors	
Product Overview	V8-T5-85
Product Selection	
Thru-Beam and Reflex Sensors	V8-T5-86
Perfect Prox Background Rejection Sensors	V8-T5-87
Compatible Connector Cables	V8-T5-88
Accessories	V8-T5-88
Options	V8-T5-89
Technical Data and Specifications	V8-T5-90
Excess Gain	V8-T5-91
Wiring Diagrams	V8-T5-91
Dimensions	V8-T5-92

- Resistant to the wide range of chemicals used in the automotive, food processing and forest products industries
- Suitable for high temperature, high pressure washdown (1200 psi)
- Mechanical Viton seals hold up to extreme temperature variations
- Visible sensing beam on all models lets you see where the beam is aimed for quick setup and alignment
- Output status indicator is the brightest available and is visible from any angle and in any lighting condition
- The industry's only background rejection sensors with a two-wire circuit design
- Models available with both AC and DC operation in a single unit
- Four-wire DC sensors offer dual NPN and PNP outputs

Standards and Certifications

- UL Listed
- cUL Listed
- CE



⚠ DANGER

THIS SENSOR IS NOT A SAFETY DEVICE AND IS NOT INTENDED TO BE USED AS A SAFETY DEVICE. This sensor is designed only to detect and read certain data in an electronic manner and perform no use apart from that, specifically no safety-related use. This sensor product does not include self-checking redundant circuitry, and the failure of this sensor product could cause either an energized or de-energized output condition, which could result in death, serious bodily injury, or property damage.

For the most current information on this product, visit our Web site: www.eaton.com

For Customer Service in the U.S. call 1-877-ETN CARE (386-2273), in Canada call 1-800-268-3578. For Application Assistance in the U.S. and Canada call 1-800-426-9184.

Product Overview

E58 Harsh Duty Series Sensors Physical Attributes

Rugged physical construction

The E58 Harsh Duty Series was designed from the ground up to be the most rugged sensor family available. The strong metal housing, mechanical seals and surface mount electronics withstand heavy shock and vibration. The tempered glass lens cover provides protection in abrasive environments, and the sturdy cable is physically clamped to the sensor body.

Exceptional environmental protection and chemical resistance

The E58 Harsh Duty Series was designed to be used in the automotive, food processing and forest products industries. It is also well suited for applications in related industries such as pulp and paper, car wash and steel. These industries are all physically demanding on equipment and that's why we designed and tested these sensors to extreme levels of shock and vibration.

Many sensor failures, however, are actually due to chemical attack so we had to make them stand up to constant chemical exposure—day in and day out. To ensure resistance to the widest possible range of chemicals, we conducted extensive studies of the chemical agents commonly used in these industries.

We then selected only those materials that could withstand exposure to these chemicals without failure in the design of the E58 Harsh Duty Series. In addition, we eliminated adhesives in favor of more reliable Viton compression seals. Some of the more common chemicals against which this sensor has been tested are listed in the resistance chart.

This resistance chart reflects testing of the 303 stainless steel body used on the standard E58 Harsh Duty Series sensors. Additional chemical resistance for food industry applications is available using sensors with the optional 316 stainless steel body and hard-coated polycarbonate (or acrylic on reflex models) lens cover.

The E58 Harsh Duty Series was designed to resist the chemicals shown in this table under normal use and conditions. Extremes of environmental factors such as temperature, pressure, concentration, duration of exposure, ultraviolet sunlight and chemical interactions combined with the presence of these chemicals could result in premature material failure. For these cases, testing the sensor in the specific application is recommended.

E58 Harsh Duty Series Sensors Chemical Resistance Chart

Chemical Category	Commonly Found In
Oils, cutting fluids, aqueous coolants	Automotive, forest industry
Vegetable and mineral oil	Automotive, forest industry
Surfactants	Automotive, food processing
Dilute acids	Food processing
Dilute bases	Food processing
Sanitizers	Food processing

Sensing Modes

Perfect Prox

This is a unique type of diffuse reflective sensor that combines extremely high sensing power (called "excess gain") with a sharp optical cutoff to ignore backgrounds. This allows the sensor to reliably detect targets regardless of variations in color, reflectance, contrast or surface shape, while ignoring objects just slightly outside the target range. With Perfect Prox, the E58 Harsh Duty Series can act just like an inductive prox sensor—but with up to 20 times the range for mounting away from a moving target so you can avoid damage and downtime. 18 mm and 30 mm sizes, two-, three- and four-wire circuits, and cable, micro- and mini-connector terminations mean quick and easy replacement of damaged proximity sensors. A visible sensing beam lets you quickly confirm the sensor is aligned correctly in the application.

The 18 mm Perfect Prox has a sensing range of 2 or 4 in (50 or 100 mm), and the 30 mm version has a range of 6 or 11 in (150 or 280 mm).

This simplified application example shows the power of the Perfect Prox.

Application Example

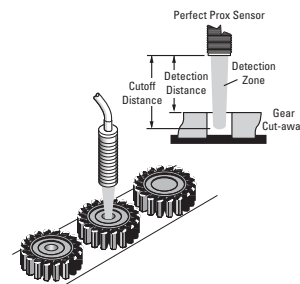

If the hole is present in the gear, the sensor will shine through the hole and ignore the belt—no detection event will occur.

If the hole in the gear is missing, the sensor will detect the surface of the gear and reject the part.

Thru-Beam

This sensing mode is available in the 30 mm models. Rated sensing range is 800 ft, among the longest ranges available on the market. This provides extremely high excess gain when the source and detector are positioned at closer, optimum ranges to see through high levels of contamination. A visible red sensing beam and wide field-of-view mean quick and easy installation and alignment.



Polarized Reflex

Another sensing mode available in the 30 mm models is polarized reflex. In this mode, the sensing beam is reflected from a retroreflector back to the sensor. The maximum range of 34 ft is also among the longest available on the sensor market. The polarizing filter built into the sensor ensures only light reflected off a corner cube retroreflector is recognized by the sensor. This allows reliable detection of shiny targets that could reflect light back to the sensor and be missed by a non-polarized version. As in all models, a visible sensing beam is featured for easy installation and alignment.

Product Selection

Thru-Beam and Reflex Sensors

Three-Wire and Four-Wire Sensors

	Operating Voltage	Sensing Range	Optimum Range	Field of View	Thru-Beam Component	Connection Type	Light Operate Catalog Number	Dark Operate Catalog Number
30 mm Diameter Thru-Beam  Source Detector	30 mm Diameter Thru-Beam ①							
	20–132 Vac 50/60 Hz or 15–30 Vdc	800 ft (250m)	0.1 to 300 ft (0.03 to 90m)	33 in (830 mm) diameter at 25 ft (7.6m)	Source	2m cable	E58–30TS250-GA	—
						4-pin micro AC connector	E58–30TS250-GAP ⊕	—
					Detector	2m cable	E58–30TD250-GL	E58–30TD250-GD
						4-pin micro AC connector	E58–30TD250-GLP ⊕	E58–30TD250-GDP ⊕
	10–30 Vdc	800 ft (250m)	0.1 to 300 ft (0.03 to 90m)	33 in (830 mm) diameter at 25 ft (7.6m)	Source	2m cable	E58–30TS250-HA	—
					4-pin micro DC connector	E58–30TS250-HAP ⊕	—	
				Detector	2m cable	E58–30TD250-HL	E58–30TD250-HD	
					4-pin micro DC connector	E58–30TD250-HLP ⊕	E58–30TD250-HDP ⊕	
30 mm Diameter Reflex  Sensor Retroreflector ③	30 mm Diameter Reflex ②							
	20–132 Vac 50/60 Hz or 15–30 Vdc	59 ft (18m)	1 to 40 ft (0.03 to 12m)	6 in (150 mm) diameter at 20 ft (6m)	—	2m cable	E58–30RS18-GL	E58–30RS18-GD
						4-pin micro AC connector	E58–30RS18-GLP ⊕	E58–30RS18-GDP ⊕
	10–30 Vdc	59 ft (18m)	1 to 40 ft (0.03 to 12m)	6 in (150 mm) diameter at 20 ft (6m)	—	2m cable	E58–30RS18-HL	E58–30RS18-HD
4-pin micro DC connector						E58–30RS18-HLP ⊕	E58–30RS18-HDP ⊕	
30 mm Diameter Polarized Reflex  Retroreflector ③	30 mm Diameter Polarized Reflex ②							
	20–132 Vac 50/60 Hz or 15–30 Vdc	34 ft (10m)	1 to 20 ft (0.03 to 6m)	6 in (150 mm) diameter at 20 ft (6m)	—	2m cable	E58–30RP10-GL	E58–30RP10-GD
						4-pin micro AC connector	E58–30RP10-GLP ⊕	E58–30RP10-GDP ⊕
	10–30 Vdc	34 ft (10m)	1 to 20 ft (0.03 to 6m)	6 in (150 mm) diameter at 20 ft (6m)	—	2m cable	E58–30RP10-HL	E58–30RP10-HD
4-pin micro DC connector						E58–30RP10-HLP ⊕	E58–30RP10-HDP ⊕	

Options, see Page V8-T5-89.

Notes

⊕ See listing of compatible connector cables on Page V8-T5-88.



① For a complete system, order one source and one detector.

② For a complete system, order sensor and retroreflector (see Tab 8, section 8.1).

③ Retroreflector not included.



Perfect Prox Background Rejection Sensors

Two-Wire Sensors

	Operating Voltage	Nominal Range ①	Optimum Range	Cutoff Range ②	Field of View	Connection Type	Light Operate Catalog Number	Dark Operate Catalog Number			
	18 mm Diameter Perfect Prox										
	90–132 Vac 50/60 Hz or 18–50 Vdc	2 in (50 mm)	0.4 to 1.8 in (10 to 45 mm)	2.25 in (57 mm) and beyond	0.25 in (6 mm) diameter at 2 in (50 mm)	2m cable	E58–18DP50-EL	E58–18DP50-ED			
						3-pin micro AC connector	E58–18DP50-ELP ☼	E58–18DP50-EDP ☼			
						3-pin mini-connector	E58–18DP50-ELPB ☼	E58–18DP50-EDPB ☼			
	4 in (100 mm)	0.5 to 3 in (13 to 76 mm)	5 in (127 mm) and beyond	0.38 in (10 mm) diameter at 4 in (100 mm)	2m cable	E58–18DP100-EL	E58–18DP100-ED				
					3-pin micro AC connector	E58–18DP100-ELP ☼	E58–18DP100-EDP ☼				
3-pin mini-connector					E58–18DP100-ELPB ☼	E58–18DP100-EDPB ☼					
18–50 Vdc	2 in (50 mm)	0.4 to 1.8 in (10 to 45 mm)	2.25 in (57 mm) and beyond	0.25 in (6 mm) diameter at 2 in (50 mm)	4-pin micro DC connector	E58–18DP50-DLP ☼	E58–18DP50-DDP ☼				
					4 in (100 mm)	0.5 to 3 in (13 to 76 mm)	5 in (127 mm) and beyond	0.38 in (10 mm) diameter at 4 in (100 mm)	4-pin micro DC connector	E58–18DP100-DLP ☼	E58–18DP100-DDP ☼
	30 mm Diameter Perfect Prox										
	90–132 Vac 50/60 Hz or 18–50 Vdc	6 in (150 mm)	1 to 6 in (26 to 150 mm)	6.5 in (165 mm) and beyond	0.75 in (19 mm) diameter at 6 in (150 mm)	2m cable	E58–30DP150-EL	E58–30DP150-ED			
						3-pin micro AC connector	E58–30DP150-ELP ☼	E58–30DP150-EDP ☼			
						3-pin mini-connector	E58–30DP150-ELPB ☼	E58–30DP150-EDPB ☼			
	11 in (280 mm)	1 to 9 in (26 to 228 mm)	12.5 in (318 mm)	1.0 in (26 mm) diameter at 11 in (280 mm)	2m cable	E58–30DPS280-EL	E58–30DPS280-ED				
					3-pin micro AC connector	E58–30DPS280-ELP ☼	E58–30DPS280-EDP ☼				
3-pin mini-connector					E58–30DPS280-ELPB ☼	E58–30DPS280-EDPB ☼					
18–50 Vdc	6 in (150 mm)	1 to 6 in (26 to 150 mm)	6.5 in (165 mm) and beyond	0.75 in (19 mm) diameter at 6 in (150 mm)	4-pin micro DC connector	E58–30DP150-DLP ☼	E58–30DP150-DDP ☼				

Options, see Page V8-T5-89.

Three-Wire and Four-Wire Sensors

	Operating Voltage	Nominal Range ①	Optimum Range	Cutoff Range ②	Field of View	Connection Type	Light Operate Catalog Number	Dark Operate Catalog Number
	18 mm Diameter Perfect Prox							
	10–30 Vdc	2 in (50 mm)	0.4 to 1.8 in (10 to 45 mm)	2.25 in (57 mm) and beyond	0.25 in (6 mm) diameter at 2 in (50 mm)	2m cable	E58–18DP50-HL	E58–18DP50-HD
						4-pin micro DC connector	E58–18DP50-HLP ☼	E58–18DP50-HDP ☼
4 in (100 mm)	0.5 to 3 in (13 to 76 mm)	5 in (127 mm) and beyond	0.38 in (10 mm) diameter at 4 in (100 mm)	2m cable	E58–18DP100-HL	E58–18DP100-HD		
				4-pin micro DC connector	E58–18DP100-HLP ☼	E58–18DP100-HDP ☼		
	30 mm Diameter Perfect Prox							
	20–132 Vac 50/60 Hz or 15–30 Vdc	6 in (150 mm)	1 to 6 in (26 to 150 mm)	6.5 in (165 mm) and beyond	0.75 in (19 mm) diameter at 6 in (150 mm)	2m cable	E58–30DP150-GL	E58–30DP150-GD
						4-pin micro AC connector	E58–30DP150-GLP ☼	E58–30DP150-GDP ☼
						11 in (280 mm)	1 to 9 in (26 to 228 mm)	12.5 in (318 mm)
	4-pin micro AC connector	E58–30DPS280-GLP ☼	E58–30DPS280-GDP ☼					
	10–30 Vdc	6 in (150 mm)	1 to 6 in (26 to 150 mm)	6.5 in (165 mm) and beyond	0.75 in (19 mm) diameter at 6 in (150 mm)	2m cable	E58–30DP150-HL	E58–30DP150-HD
4-pin micro DC connector						E58–30DP150-HLP ☼	E58–30DP150-HDP ☼	
11 in (280 mm)						1 to 9 in (26 to 228 mm)	12.5 in (318 mm)	1.0 in (26 mm) diameter at 11 in (280 mm)
	4-pin micro DC connector	E58–30DPS280-HLP ☼	E58–30DPS280-HDP ☼					

Options, see Page V8-T5-89.

Notes

☼ ☼ See listing of compatible connector cables on Page V8-T5-88.

① Sensor will detect a 90% reflectance card at this range.



② Sensor will ignore a 90% reflectance card at this range.

Compatible Connector Cables

Micro-Style,
Straight Female



Standard Cables—Micro ^①

Voltage Style	Number of Pins	Gauge	Length	Pin Configuration/ Wire Colors (Face View Female Shown)	PVC Jacket Catalog Number	PUR Jacket Catalog Number	IRR PUR Jacket Catalog Number
Micro-Style, Straight Female							
AC	3-pin, 3-wire	22 AWG	6 ft (2m)	 1-Green 2-Red/Black 3-Red/White	CSAS3F3CY2202	CSAS3F3RY2202	—
	4-pin, 4-wire	22 AWG	6 ft (2m)	 1-Red/Black 2-Red/White 3-Red 4-Green	CSAS4F4CY2202	CSAS4F4RY2202	CSAS4F4IO2202
DC	4-pin, 4-wire	22 AWG	6 ft (2m)	 1-Brown 2-White 3-Blue 4-Black	CSDS4A4CY2202	CSDS4A4RY2202	CSDS4A4IO2202

5

Mini-Style,
Straight Female



Standard Cables—Mini ^①

Current Rating at 600V	Voltage Style	Number of Pins	Gauge	Length	Pin Configuration/ Wire Colors (Face View Female Shown)	Catalog Number
Mini-Style, Straight Female						
13A	—	3-pin	16 AWG	6 ft (2m)	 1-Green 2-Black 3-White	CSMS3F3CY1602

Accessories

E58 Harsh Duty Series Sensors

Description	Reference
Retroreflectors and retroreflective tape	See Tab 8, section 8.1
Mounting brackets	See Tab 8, section 8.2
Mounting nuts and other accessories	See Tab 8, section 8.3
Connector cables	See Tab 10, section 10.1

Note

^① For a full selection of connector cables, see **Tab 10, section 10.1**.

Options

Sensor options are built-to-order, contact Eaton's Sensor Applications Department at 1-800-426-9184 for delivery lead times.

Thru-Beam and Reflex Sensors

Thru-Beam Apertured Versions

Reduces effective sensing beam to 0.2 x 0.9 in (5 x 23 mm) for accurate edge detection or sensing smaller objects. Factory installed behind lens cover for protection and sealing. Sensing range is reduced to 230 ft (70m).

To order, substitute "**070**" in place of "**250**" in source or detector catalog number.

Example:
E58-30TS**070**-GA

Food Processing Versions with Threaded Housings

Upgrade to a 316 stainless steel threaded body from 303, and change the lens cover to hard-coated polycarbonate (cast acrylic for reflex models) from glass.

To order, add the suffix "**-FC**" to the end of the catalog number.

Example:
E58-30RP10-GL-**FC**

Food Processing Versions with Smooth (Non-Threaded) Housings

Upgrade to a 316 stainless steel smooth (non-threaded) body from 303, and change the lens cover to hard-coated polycarbonate (cast acrylic for reflex models) from glass.

To order, add the suffix "**-FSC**" to the end of the catalog number.

Example:
E58-30RP10-GL-**FSC**

Perfect Prox 30 mm Diameter Model Sensors Only

Food Processing Versions with Threaded Housings

Upgrade to a 316 stainless steel threaded body from 303, and change the lens cover to hard-coated polycarbonate from glass.

To order, add the suffix "**-FC**" to the end of the catalog number.

Example:
E58-30DP150-EL-**FC**

Food Processing Versions with Smooth (Non-Threaded) Housings

Upgrade to a 316 stainless steel smooth (non-threaded) body from 303, and change the lens cover to hard-coated polycarbonate from glass.

To order, add the suffix "**-FSC**" to the end of the catalog number.

Example:
E58-30DP150-EL-**FSC**

Technical Data and Specifications

E58 Harsh Duty Series Sensors

Description	Three-Wire and Four-Wire Sensors			Two-Wire Sensors	
	AC/DC Models (AC Operation)	AC/DC Models (DC Operation)	DC Only Models	AC/DC Models (AC Operation)	DC Only and AC/DC Models (DC Operation)
Input voltage	20–132 Vac, 50/60 Hz	15–30 Vdc	10–30 Vdc	90–132 Vac, 50/60 Hz	18–50 Vdc
Power dissipation	3W maximum	3W maximum	2W maximum	3W maximum	3W maximum
Output type	VMOS (bi-directional)	NPN (sink)	Four-wire: NPN and PNP (dual outputs)	18 mm models: DMOS/bipolar; 30 mm models: DMOS	18 mm models: DMOS/bipolar; 30 mm models: DMOS
Current switching	300 mA maximum	300 mA maximum	PNP: 100 mA max. NPN: 18 mm models: 250 mA max.; 30 mm models: 100 mA max.	18 mm models: 100 mA; 30 mm models: 300 mA	18 mm models: 100 mA; 30 mm models: 300 mA
Voltage switching	186V peak maximum	186V peak maximum	30 Vdc maximum	186V peak maximum	50 Vdc maximum
OFF-state leakage	250 μ A typical; 500 μ A maximum	250 μ A typical; 500 μ A maximum	10 μ A maximum	1.7 mA maximum	18 mm models: 1.7 mA max. 30 mm models: 1.5 mA max.
Surge current	2A maximum	2A maximum	1A maximum	1A AC	1A DC
ON-state voltage drop	—	1.8V at 10 mA 4.0V at 300 mA	NPN: 1.2V at 10 mA; 18 mm models: 2.0V at 100 mA; 30 mm models: 2.0V at 250 mA; PNP: 2.8V at 100 mA	10 Vac rms	18 mm models: 10 Vdc 30 mm models: 8 Vdc
Response time	10 ms	2 ms	18 mm models: 1 ms; 30 mm models: 1.6 ms	35 ms	35 ms
Short circuit protection	Sensor will turn off immediately when a short or overload is detected (indicator LED will flash) ①	Sensor will turn off immediately when a short or overload is detected (indicator LED will flash) ①	Sensor will turn off immediately when a short or overload is detected (indicator LED will flash) ①	Auto reset	Auto reset
Operating and storage temperature range	–40° to 131°F (–40° to 55°C)	–40° to 131°F (–40° to 55°C)	–40° to 131°F (–40° to 55°C)	18 mm models: –40° to 158°F (–40° to 70°C) 30 mm models: –10° to 131°F (–25° to 55°C)	18 mm models: –40° to 158°F (–40° to 70°C) 30 mm models: –10° to 131°F (–25° to 55°C)

Description	All Models
Enclosure material	Cable jacket: PVC (poly vinyl chloride) Indicator ring: PVDF (high-density fluorinated polymer) Seals: Viton (registered trademark of Dupont) Lens cover: Thru-beam and Perfect Prox models: Tempered glass (or hard-coated polycarbonate for models ending in FC or FSC) Polarized reflex models: Glass (or cast acrylic for models ending in FC or FSC) Body: 303 stainless steel (or 316 stainless steel for models ending in FC or FSC)
Cable versions	2m cable length
Connector versions	Male mini- and micro-connectors on 7 in pigtail (refer to model selection for number of pins per model)
Vibration and shock	Vibration: 30g over 20 Hz to 2 kHz; shock: 100g for 3 ms 1/2 sinewave pulse
Indicator LED	Thru-beam source: Lights when power is ON; all other models: Lights steady when output is ON, flashes when short circuit protection is in latch condition (except two-wire models)
Sunlight immunity	Perfect Prox 5000 ft-candles others: 10,000 ft-candles
Enclosure ratings	NEMA 1, 2, 3, 3R, 3S, 4, 4X, 6, 6P, 12, 12K and 13 (IP69K); This product is suitable for high temperature, high pressure washdown (1200 psi).
Chemical resistance	This product was designed to withstand chemicals commonly used in the automotive, machine tool, food processing and forest industries.

Note

① Turn power OFF and back ON to reset. Sensor will reset when short is removed.

Excess Gain

Thru-Beam, Reflex and Polarized Reflex Sensors

All Models

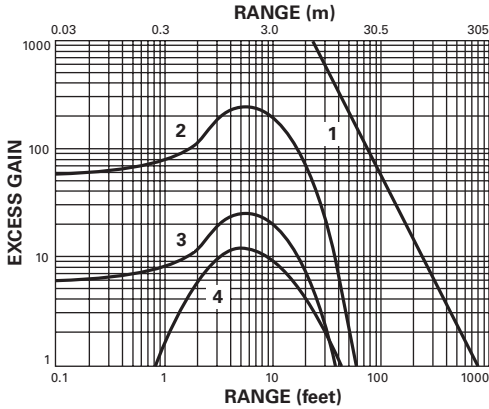

Thru-Beam

- 1. Thru-beam

Reflex

- 2. Performance to 3 in retroreflector

Polarized Reflex

- 3. Performance to 3 in retroreflector
- 4. Performance to corner-cube retroreflective tape

Perfect Prox Background Rejection Sensors

All Models

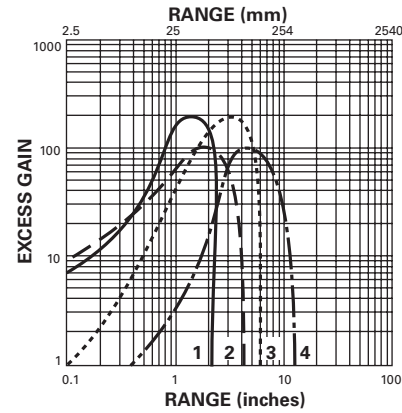

Perfect Prox

- 1. 18 mm diameter, 2 in (50 mm) range models
- 2. 18 mm diameter, 4 in (100 mm) range models
- 3. 30 mm diameter, 6 in (150 mm) range models
- 4. 30 mm diameter, 11 in (280 mm) range models

Wiring Diagrams

Pin numbers are for reference, rely on pin location when wiring.

Perfect Prox Background Rejection Sensors

Operating Voltage	Mode/Output	Cable Models	Connector Models (Face View Male Shown)	
			Micro	Mini
Two-Wire Sensors				
90–132 Vac 50/60 Hz or 18–50 Vdc	All			
18–50 Vdc	All (NPN)			—
	All (PNP)			—

Pin numbers are for reference, rely on pin location when wiring.

E58 Harsh Duty Series Sensors

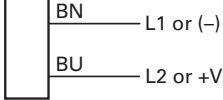
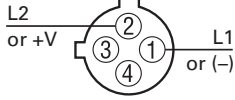
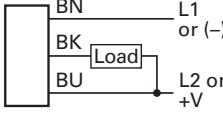
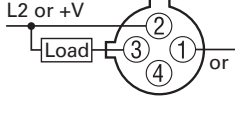
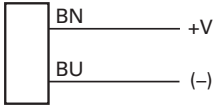
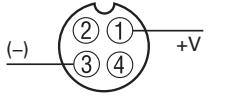
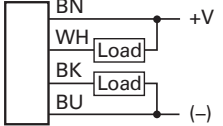
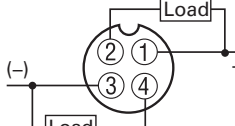
Operating Voltage	Mode/Output	Cable Models	Micro-Connector Models (Face View Male Shown)
Three-Wire and Four-Wire Sensors			
20–132 Vac 50/60 Hz or 15–30 Vdc	Thru-beam source		
	All others		
10–30 Vdc	Thru-beam source		
	All others (NPN and PNP)		

Dimensions

Approximate Dimensions in Inches (mm) except where noted

18 mm Diameter (Threaded Model Shown)

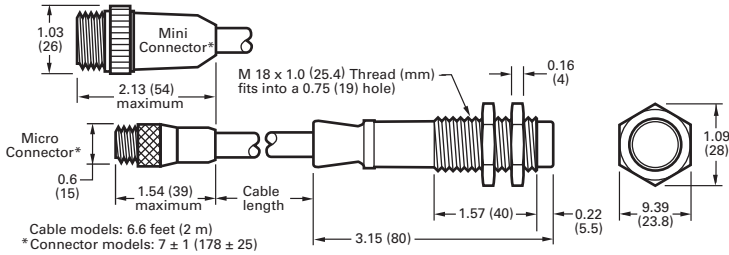

30 mm Diameter (Threaded Model Shown)

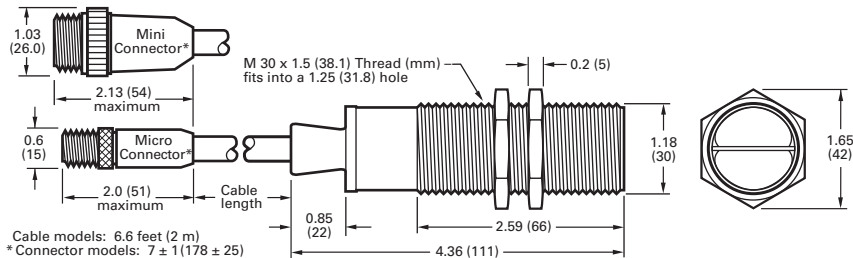

E67 Long Range Perfect Prox Series Sensors



Contents

<i>Description</i>	<i>Page</i>
E67 Long Range Perfect Prox Series Sensors	
Product Selection	V8-T5-94
Accessories	V8-T5-94
Technical Data and Specifications	V8-T5-95
Excess Gain	V8-T5-95
Wiring Diagrams	V8-T5-96
Dimensions	V8-T5-96

E67 Long Range Perfect Prox Series Sensors

Product Description

The E67 Long Range Perfect Prox Series from Eaton’s Electrical Sector, the highest performing long-range sensor you can buy with background rejection, is ideal for your most difficult sensing applications.

The E67 Long Range Perfect Prox Series reliably detects targets in range regardless of variations in color, reflectance, contrast or surface shape while ignoring objects just slightly outside the target range.

The standard E67 sensor is conveniently pre-set with a six ft range. Ranges of three to eight ft are available pre-set from the factory.

Features

- Perfect Prox technology provides exceptional background rejection and application problem solving
- Extended sensing ranges (up to eight ft) available
- No user adjustments required
- Dual indicators communicate both output and power status from an easy-to-see location at the top of the sensor housing
- Models available with both AC and DC operation in a single unit—up to 132 volts AC and DC
- AC/DC models offer isolated contact output for wiring flexibility
- DC-only sensors offer both NPN and PNP outputs
- Two mounting options for maximum flexibility
- Fully sealed package

⚠ DANGER

THIS SENSOR IS NOT A SAFETY DEVICE AND IS NOT INTENDED TO BE USED AS A SAFETY DEVICE. This sensor is designed only to detect and read certain data in an electronic manner and perform no use apart from that, specifically no safety-related use. This sensor product does not include self-checking redundant circuitry, and the failure of this sensor product could cause either an energized or de-energized output condition, which could result in death, serious bodily injury, or property damage.

Standards and Certifications

- CE



For the most current information on this product, visit our Web site: www.eaton.com

For Customer Service in the U.S. call 1-877-ETN CARE (386-2273), in Canada call 1-800-268-3578.
For Application Assistance in the U.S. and Canada call 1-800-426-9184.

Product Selection

E67 Long Range Perfect Prox Series Sensors

E67 Long Range



Four-Wire Sensors



Operating Voltage	Sensing Range ①②	Optimum Range ③	Cutoff Range ④	Field of View	Sensing Beam	Connection Type	Light Operate Catalog Number	Dark Operate Catalog Number
18–30 Vdc	79 in (200 cm)	12 to 60 in (30 to 150 cm)	91 in (230 cm)	6 in (15 cm) diameter at 79 in (200 cm)	Infrared beam	4-pin micro DC connector	E67-LRDP200-HLD ⓘ	E67-LRDP200-HDD ⓘ
	⑤	⑤	⑤	⑤	Infrared beam	4-pin micro DC connector	E67-LRDPXXX-HLD ⓘ	E67-LRDPXXX-HDD ⓘ
20–132 Vac 20–132 Vdc	79 in (200 cm)	12 to 60 in (30 to 150 cm)	91 in (230 cm)	6 in (15 cm) diameter at 79 in (200 cm)	Infrared beam	4-pin, micro AC connector	E67-LRDP200-KLD ⓘ	E67-LRDP200-KDD ⓘ
	⑤	⑤	⑤	⑤	Infrared beam	4-pin micro AC connector	E67-LRDPXXX-KLD ⓘ	E67-LRDPXXX-KDD ⓘ

Compatible Connector Cables

Micro-Style, Straight Female



Standard Cables—Micro ⓘ

Voltage Style	Number of Pins	Gauge	Length	Pin Configuration/ Wire Colors (Face View Female Shown)	PVC Jacket Catalog Number	PUR Jacket Catalog Number	IRR PUR Jacket Catalog Number
Micro-Style, Straight Female							
AC	4-pin, 4-wire	22 AWG	6 ft (2m)	 1-Red/Black 2-Red/White 3-Red 4-Green	CSAS4F4CY2202	CSAS4F4RY2202	CSAS4F4IO2202
DC	4-pin, 4-wire	22 AWG	6 ft (2m)	 1-Brown 2-White 3-Blue 4-Black	CSDS4A4CY2202	CSDS4A4RY2202	CSDS4A4IO2202

Accessories

E67 Long Range Perfect Prox Series Sensors

Description	Reference
Mounting brackets	See Tab 8, section 8.2
Connector cables	See Tab 10, section 10.1

Notes

ⓘ See listing of compatible connector cables on this page.

① Ranges based on an 18 in white card.

② Also consider the cutoff range when selecting a sensing range. Guaranteed cutoff will be approximately 12 in (30 cm) beyond the sensing range. If a background is present within this zone, adjustments to the application or the sensing range will need to be made.

③ Sensor will detect a 90% reflectance card at this range.

④ Sensor will ignore a 90% reflectance card at this range.

⑤ Custom ranges available:

Sensor Options (Built-to-order, contact Eaton's Sensor Applications Department at 1-800-426-9184 for delivery lead times).

The sensing range of this device can be set at the factory to between 60 cm and 240 cm in 10 cm increments. To order, substitute the range (in centimeters) in the model number in place of the standard **200** centimeters. For example, for a device that detects out to 4 ft (4 ft x 12 in/ft x 2.54 centimeters/in), that equates to 121.92 cm. Rounding up (or down, depending on your needs) to the nearest 10 cm yields a sensing range of 130 cm. Therefore, for a light-operate AC/DC device, you would order E67-LRDP**130**-KLD.

ⓘ For a full selection of connector cables, see **Tab 10, section 10.1**.

Technical Data and Specifications

E67 Long Range Perfect Prox Series Sensors

Description	AC/DC Models	DC Only Models
Input voltage	20 to 132 Vac, 50/60 Hz 20 to 132 Vdc	18 to 30 Vdc
Power dissipation	2W maximum	0.5W maximum
Output type	Solid-state relay, 1500 V isolation	NPN and PNP
Voltage switching capacity	400 Vac/dc	30 Vdc
Current switching capacity	75 mA maximum	100 mA maximum
OFF-state leakage	100 μ A maximum	50 μ A maximum
ON-state characteristics	35 ohms maximum resistance	NPN: 1.5V drop at 100 mA, maximum PNP: 2.5V drop at 100 mA, maximum
Short circuit protection	Thermally current limited at approximately 200 mA ^①	Protected against dead shorts only ^{①②}
Response time	50 ms	15 ms
Light/dark operation	Specified by catalog number	Specified by catalog number
Temperature range		
Operating	-31° to 131°F (-35° to 55°C)	-31° to 131°F (-35° to 55°C)
Storage	-40° to 158°F (-40° to 70°C)	-40° to 158°F (-40° to 70°C)

Description	All Models
Material of construction	Enclosure: Lexan [®] Polycarbonate; back cover: Cycloyl [®] Polycarbonate/ABS; indicator viewing window: Lexan [®] Polycarbonate; jam nut and connector: 15% glass-filled nylon 6/6; Threaded inserts: Brass ^③
Mounting	Jam-nut: Do not exceed 100 in-lbs mounting torque, minimum panel thickness 0.150 in Side-mounting: Sensor includes 2 sets of #10–32 threaded inserts Tighten to no more than 35 in-lbs Use #10–32 x 0.250 in fasteners with split-type washer for panel thickness between 0.048 in and 0.080 in For other panel thicknesses, choose fastener and washers to ensure minimum thread engagement of 0.120 in and a maximum thread engagement of 0.155 in
Connector models	Micro-connector, 4-pin male
Vibration and shock	Vibrations: 10g over 10 Hz to 2 kHz; shock: 30g for 6 ms 1/2 sine wave pulse
Indicator LED	Red: Lights steady when output is on; green: Lights steady when power is applied to sensor
Sunlight immunity	5000 ft-candles
Enclosure ratings	NEMA 1, 2, 3, 4, 4X, 6, 12 and 13 ^④

Excess Gain

Nominal Unit with Fixed 79 in Sensing Range

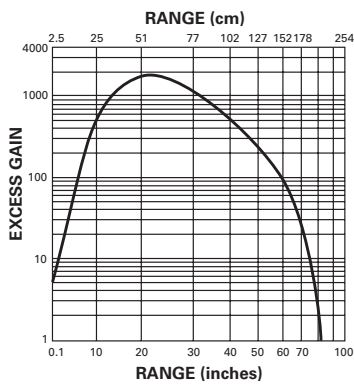

Notes

- ① **IMPORTANT:** Output will reset automatically when short is removed (there is no visual indication of a short circuit condition).
- ② **CAUTION:** Will not protect against overloads between 100 mA and 250 mA.
- ③ **IMPORTANT:** Do not expose to concentrated acids, alcohols or ketones.
- ④ These products conform to NEMA tests as indicated, however, some severe washdown applications can exceed these NEMA test specifications.

Wiring Diagrams

Pin numbers are for reference, rely on pin location when wiring.

AC/DC Models ①②

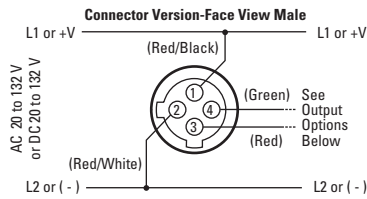

Isolated Output Options

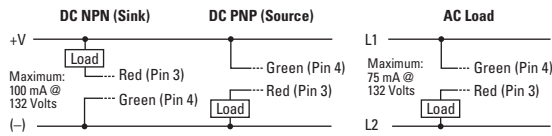

DC Only Models ①

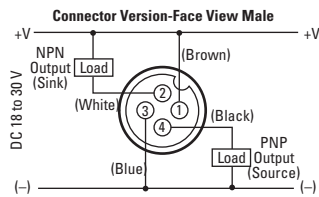

Dimensions

Approximate Dimensions in Inches (mm)

E67 Long Range Perfect Prox Series Sensors

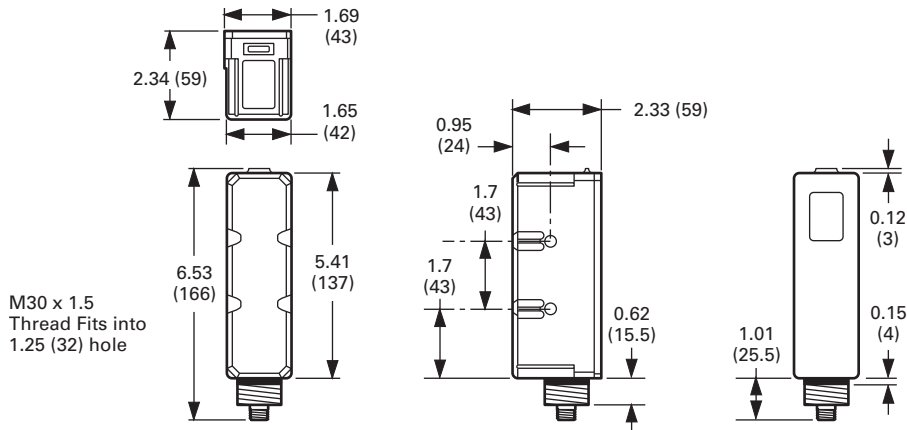

Notes

- ① Connector versions: The pin numbering and wire colors are typical of several manufacturers, however, variations are possible. In case of discrepancies, rely on function indicated and pin location rather than pin number or wire color.
- ② Sensor operates on DC voltage, but isolated output can switch AC or DC loads.

E51 Limit Switch Style, Modular Sensors



Contents

<i>Description</i>	<i>Page</i>
E51 Limit Switch Style, Modular Sensors	
Product Selection	
Assembled Sensors	V8-T5-98
Sensor Heads	V8-T5-100
Sensor Bodies	V8-T5-101
Logic Module	V8-T5-102
Receptacles	V8-T5-102
Compatible Connector Cables	V8-T5-103
Accessories	V8-T5-72
Technical Data and Specifications	V8-T5-104
Excess Gain	V8-T5-104
Wiring Diagrams	V8-T5-105
Dimensions	V8-T5-106

E51 Limit Switch Style, Modular Sensors

Product Description

E51 Limit Switch Style Modular Sensors from Eaton’s Electrical Sector are available in thru-beam, reflex, polarized reflex, diffuse reflective and fiber optic sensing modes to solve a wide variety of sensing applications. Modular, plug-in components are easy to maintain, meaning less downtime and reduced inventory. Choose between two-wire sensors with AC/DC operation and four-wire sensors in either AC or DC styles. Connection options include terminal, mini-connector and various lengths of cable. Sensors can be ordered in component form or as fully assembled units.

Features

- Choose from five different sensing modes including fiber optic
- All heads feature a selector switch for light or dark operation
- Logic modules are available to provide additional control functions
- Rugged construction, ideal for industrial environments
- Viton gaskets ensure a positive seal and high chemical resistance
- Sensor heads can be rotated to any of four positions
- Components are interchangeable with E51 proximity sensors
- Sensors accommodate both U.S. and DIN mounting dimensions
- Sensor bodies feature bifurcated engagement prongs for a reliable electrical connection when plugging into receptacle stabs

Standards and Certifications

- UL Listed
- CSA Certified
- CE (where shown)



⚠ DANGER

THIS SENSOR IS NOT A SAFETY DEVICE AND IS NOT INTENDED TO BE USED AS A SAFETY DEVICE. This sensor is designed only to detect and read certain data in an electronic manner and perform no use apart from that, specifically no safety-related use. This sensor product does not include self-checking redundant circuitry, and the failure of this sensor product could cause either an energized or de-energized output condition, which could result in death, serious bodily injury, or property damage.

For the most current information on this product, visit our Web site: www.eaton.com

For Customer Service in the U.S. call 1-877-ETN CARE (386-2273), in Canada call 1-800-268-3578. For Application Assistance in the U.S. and Canada call 1-800-426-9184.

Product Selection

Assembled Sensors

Assembled Sensor



Sensor Heads ^④

Reflex, Diffuse Reflective and Thru-Beam Sensors

Sensor Body and Receptacle



Operating voltage	20–264 Vac/dc	Two-Wire Sensors	120 Vac	Four-Wire Sensors	10–30 Vdc
Output	NO or NC ^①		NO and NC complementary		NO and NC complementary
Sensor body	E51SAL	E51SCL	E51SCN Accepts logic module ^②	E51SNL NPN	E51SPL PNP
Receptacle ^③	E51RA	E51RC	E51RCB	E51RN	E51RN

Sensing Range

Response Time

Sensing Beam

Sensor Head Only Catalog Number

Assembled Sensors with Head, Sensor Body and Receptacle Catalog Number

Reflex



Reflex

18 ft (5.5m)	Standard response	Infrared	E51DP1	E51ALP1	☺☺	E51CLP1	E51CNP1	E51NLP1	☺☺	E51PLP1	☺☺
35 ft (10.7m)	Standard response		E51DP3	—		E51CLP3	E51CNP3	E51NLP3	☺☺	E51PLP3	☺☺

Polarized Reflex



Polarized Reflex

15 ft (4.5m)	Standard response	Visible red	E51DP5	—		E51CLP5	E51CNP5	E51NLP5	☺☺	E51PLP5	☺☺
--------------	-------------------	-------------	---------------	---	--	----------------	----------------	----------------	----	----------------	----

Diffuse Reflective



Diffuse Reflective

8 in (200 mm)	Standard response	Infrared	E51DP2	E51ALP2	☺☺	E51CLP2	E51CNP2	E51NLP2	☺☺	E51PLP2	☺☺
	Fast response		E51DP22	—		E51CLP22	E51CNP22	E51NLP22	☺☺	E51PLP22	☺☺
18 in (450 mm)	Standard response		E51DP6	—		E51CLP6	E51CNP6	E51NLP6	☺☺	E51PLP6	☺☺
40 in (1m)	Standard response		E51DP4	—		E51CLP4	E51CNP4	E51NLP4	☺☺	E51PLP4	☺☺

Thru-Beam Detector



Thru-Beam Detector

300 ft (90m)	Standard response	—	E51DC1	E51ALC1	☺☺	E51CLC1	E51CNC1	E51NLC1	☺☺	E51PLC1	☺☺
--------------	-------------------	---	---------------	----------------	----	----------------	----------------	----------------	----	----------------	----

Thru-Beam Source



Thru-Beam Source ^③

300 ft (90m)	—	Infrared with visible red alignment aid	E51DEL	E51ELA ^⑤	E51ELA ^⑤	E51ELA ^⑤	E51ELA ^⑤	E51ELA ^⑤	E51ELA ^⑤
			E51DED	E51EDN ^⑥	E51EDN ^⑥	E51EDN ^⑥	E51EDN ^⑥	E51EDN ^⑥	E51EDN ^⑥

Notes

☺☺ See listing of compatible connector cables on [Page V8-T5-103](#).

① All sensor heads feature a light or dark operation selector switch which reverses the output function.

② Logic module must be ordered separately, see [Page V8-T5-102](#). These sensor bodies are rated NEMA 4, 4X and 13.

③ Receptacles feature terminal wiring with a 1/2 in NPT thread at the conduit entrance. Other connection options are available (see below and [Page V8-T5-103](#)).

Connection Option		Suffix	Example
20 mm thread at the conduit entrance		20	E51ALP120
Built-in mini-connector with epoxy filled receptacle	2-wire, 3-pin connector	P3	E51ALP1P3 ☺☺
	4-wire, 5-pin connector	P5	E51CLP1P5 ☺☺
Pigtail with mini-connector	2-wire, AC/DC	T3	E51RAPT3 ☺☺
	4-wire, AC	T5	E51RCP T5 ☺☺
	4-wire, DC	T5	E51RNPT5 ☺☺
Pre-wired cable with epoxy filled receptacle	8 ft long	S	E51ALP1S
	12 ft long	S12	E51ALP1S12
	20 ft long	S20	E51ALP1S20

④ Includes sensor head mounted to sensor body. Head can be rotated to any of four discrete positions on body, 90° apart, but is not separate from body.

⑤ 120 Vac operation.

⑥ 10–30 Vdc operation.

Assembled Sensor



Sensor Heads ①

Glass Fiber Optic, Standard Fiber Mounting Style



Glass Fiber Optic, Collar Fiber Mounting Style



Glass Fiber Optic Sensors

Sensor Body and Receptacle



Operating voltage
Output
Sensor body

Two-Wire Sensors

20–264 Vac/dc
NO or NC ①
E51SAL

Four-Wire Sensors

120 Vac
NO and NC complementary
E51SCL
E51SCN
Accepts logic module ②

10–30 Vdc
NO and NC complementary

E51SNL
NPN

E51SPL
PNP

Receptacle ③

E51RA

E51RC

E51RCB

E51RN

E51RN

Sensing Range

Response Time

Sensor Head Only Catalog Number

Assembled Sensors with Head, Sensor Body and Receptacle Catalog Number

Glass Fiber Optic, Standard Fiber Mounting Style ④

3 in (75 mm) ⑤ 25 in (650 mm) ⑥	Standard response	E51DF1	—	E51CLF1	E51CNF1	E51NLF1	Ⓢ Ⓢ	E51PLF1	Ⓢ Ⓢ
1 in (25 mm) ⑤ 9 in (225 mm) ⑥	Fast response	E51DF11	—	E51CLF11	E51CNF11	E51NLF11	Ⓢ Ⓢ	E51PLF11	Ⓢ Ⓢ

Glass Fiber Optic, Collar Fiber Mounting Style ④

3 in (75 mm) ⑤ 25 in (650 mm) ⑥	Standard response	E51DF3	—	E51CLF3	E51CNF3	E51NLF3	Ⓢ Ⓢ	E51PLF3	Ⓢ Ⓢ
1 in (25 mm) ⑤ 9 in (225 mm) ⑥	Fast response	E51DF33	—	E51CLF33	E51CNF33	E51NLF33	Ⓢ Ⓢ	E51PLF33	Ⓢ Ⓢ

Notes

ⓈⓈ See listing of compatible connector cables on **Page V8-T5-103**.

① All sensor heads feature a light or dark operation selector switch which reverses the output function.

② Logic module must be ordered separately, see **Page V8-T5-102**. These sensor bodies are rated NEMA 4, 4X and 13.

③ Receptacles feature terminal wiring with a 1/2 in NPT thread at the conduit entrance. Other connection options are available (see below and **Page V8-T5-103**).

Connection Option		Suffix	Example
20 mm thread at the conduit entrance		Z0	E51ALP120
Built-in mini-connector with epoxy filled receptacle	2-wire, 3-pin connector	P3	E51ALP1P3 ⓈⓈ
	4-wire, 5-pin connector	P5	E51CLP1P5 ⓈⓈ
Pigtail with mini-connector	2-wire, AC/DC	T3	E51RAPT3 ⓈⓈ
	4-wire, AC	T5	E51RCPT5 ⓈⓈ
	4-wire, DC	T5	E51RNPT5 ⓈⓈ
Pre-wired cable with epoxy filled receptacle	8 ft long	S	E51ALP1S
	12 ft long	S12	E51ALP1S12
	20 ft long	S20	E51ALP1S20





④ Requires glass fiber optic cables for operation (not included), see **Tab 9, section 9.2**.

⑤ Sensing range for diffuse reflective mode for 0.125 in (3.2 mm) diameter fibers. See **Page V8-T5-104** for complete sensing range specifications.

⑥ Sensing range in thru-beam mode for 0.125 in (3.2 mm) diameter fibers. See **Page V8-T5-104** for complete sensing range specifications.

Sensor Heads



Reflex, Diffuse Reflective and Thru-Beam Sensors ^①

	Sensing Range ^②	Field of View	Response Time				Sensing Beam	Adjustment	Input Voltage	Catalog Number
			ON AC Sensor	DC Sensor	OFF AC Sensor	DC Sensor				
Reflex	Reflex									
	18 ft (5.5m)	6 in (152 mm) diameter at 15 ft (4.6m)	20 ms	20 ms	30 ms	22 ms	Infrared	—	—	E51DP1
	35 ft (10.7m)	12 in (305 mm) diameter at 35 ft (10.7m)	20 ms	20 ms	30 ms	22 ms	Infrared	—	—	E51DP3
Polarized Reflex	Polarized Reflex									
	15 ft (4.5m)	6 in (152 mm) diameter at 15 ft (4.6m)	20 ms	20 ms	30 ms	22 ms	Visible red	—	—	E51DP5
Diffuse Reflective	Diffuse Reflective									
	8 in (200 mm)	1 in (25 mm) diameter at 4 in (101m)	20 ms	20 ms	30 ms	22 ms	Infrared	Near/far ^③	—	E51DP2
			1 ms	0.5 ms	9 ms	0.5 ms	Infrared	Near/far ^③	—	E51DP22
	18 in (450 mm)	1 in (25 mm) diameter at 9 in (228m)	20 ms	20 ms	30 ms	22 ms	Infrared	Near/far ^③	—	E51DP6
	40 in (1m)	1.5 in (38 mm) diameter at 40 in (1m)	20 ms	20 ms	30 ms	22 ms	Infrared	—	—	E51DP4
Thru-Beam Detector	Thru-Beam Detector									
	300 ft (90m)	18 in (457 mm) diameter at 20 ft (6.1m)	10 ms	5 ms	10 ms	5 ms	—	Sensitivity	—	E51DC1
Thru-Beam Source	Thru-Beam Source ^④									
	300 ft (90m)	36 in (914 mm) diameter at 20 ft (6.1m)	—	—	—	—	Infrared with visible red alignment aid	—	120 Vac	E51DEL
									10–30 Vdc	E51DED

Notes

- ^① All sensor heads feature a light or dark operation selector switch.
- ^② Reflex ranges are based on a 3 in retroreflector; diffuse reflective ranges are based on a 90% reflectance white card.
- ^③ These sensor heads have a mechanical Near/Far adjustment which adjust the head for optimum performance at the expected target distance. The adjustment, which move the optics and adjustment indicator, is made before the head is mounted on the sensor body. Excess gain graphs are shown in the "Far" setting.
- ^④ Includes sensor head mounted to sensor body. Use receptacles E51RA for AC or E51RN for DC sources. Head can be rotated to any of four discrete positions on body, 90° apart, but is not separate from the body.

Glass Fiber Optic Sensors ^①Sensing Range ^②

	Thru-Beam Mode		Diffuse Reflective Mode		Response Time				Sensing Beam	Adjustment	Catalog Number
	0.063 In Dia. Fibers	0.125 In Dia. Fibers	0.063 In Dia. Fibers	0.125 In Dia. Fibers	ON AC Sensor	DC Sensor	OFF AC Sensor	DC Sensor			
Standard Fiber Mounting Style ^③											
	8 in (200 mm)	25 in (650 mm)	0.6 in (15 mm)	3 in (75 mm)	20 ms	20 ms	30 ms	22 ms	Infrared	—	E51DF1
	3 in (75 mm)	9 in (225 mm)	0.25 in (6 mm)	1 in (25 mm)	0.5 ms	0.5 ms	9 ms	0.5 ms	Infrared	—	E51DF11
Collar Fiber Mounting Style ^③											
	8 in (200 mm)	25 in (650 mm)	0.6 in (15 mm)	3 in (75 mm)	20 ms	20 ms	30 ms	22 ms	Infrared	Sensitivity	E51DF3
	3 in (75 mm)	9 in (225 mm)	0.25 in (6 mm)	1 in (25 mm)	0.5 ms	0.5 ms	9 ms	0.5 ms	Infrared	Sensitivity	E51DF33
	10 in (250 mm)	40 in (1000 mm)	0.8 in (20 mm)	4.5 in (115 mm)	20 ms	20 ms	30 ms	22 ms	Infrared	—	E51DF4

Sensor Bodies

AC/DC



Two-Wire Sensors

Operating Voltage	Output	Protection	Output Rating Continuous	Type	Catalog Number
AC/DC					
20–264 Vac/dc, 50/60 Hz	One output, load powered, NO or NC, programmable from head; OFF-state leakage current: 1.7 mA at 120 Vac/dc, <2.0 mA at 240 Vac	Latching short circuit and overload	0.5A	—	E51SAL ^④ 

Four-Wire Sensors



AC (E51SCN Shown)



Operating Voltage	Output	Protection	Output Rating Continuous	Type	Catalog Number
AC					
120 Vac, 50/60 Hz	Two complementary outputs, line powered, NO and NC	—	1.0A to 158°F (70°C), linearly derated to 0.6A at 176°F (80°C)	—	E51SCL ^④
			1.0A to 113°F (45°C), linearly derated to 0.3A at 176°F (80°C)	Accepts logic modules (see Page V8-T5-102)	E51SCN ^⑤

DC



Operating Voltage	Output	Protection	Output Rating Continuous	Type	Catalog Number
DC					
10–30 Vdc	Two complementary outputs, line powered, NO and NC Burden current: <25 mA OFF-state leakage: <100 µA ON-state: <2.5 Vdc Power-up delay: <150 ms	Reverse polarity	0.6A to 104°F (40°C), linearly derated to 0.36A at 176°F (80°C)	NPN	E51SNL ^④ 
				PNP	E51SPL ^④ 

Notes

- ① All sensor heads feature a light or dark operation selector switch.
- ② Diffuse reflective ranges are based on a 90% reflectance white card.
- ③ Requires glass fiber optic cables for operation (not included), see **Tab 9, section 9.2**.
- ④ This sensor body is available in a factory-sealed, non plug-in configuration (with 8 ft cable), add **6P** to listed catalog number. Example: E51SAL6P.
- ⑤ Sensor body is black. E51SCN sensor bodies are rated NEMA 4, 4X and 13.

Logic Module

Logic Module ^①

Logic Module (for E51SCN Sensor Body Only)

Type	Reset Time	Description	Timing Range ^②	Catalog Number
ON and OFF delay	25 ms minimum	Adjustable delay between time object is sensed and time switch function occurs	0.15 to 15.0 seconds	E51MTB
		Adjustable delay between time object leaves sensing field and time switch transfers back to non-sensing state		

5

Receptacles

Receptacles for E51 Limit Switch

Description	Style	Details	Cable Length	Conduit Entrance		
				1/2 In NPT Catalog Number	20 mm Catalog Number	
Surface Mount						
Surface Mount						
Conduit entrance, front or rear mounting	2-wire, AC/DC	—	—	E51RA	E51RA20	
	4-wire, AC	Gray	—	E51RC	E51RC20	
		Black ^③	—	E51RCB	E51RCB20	
	4-wire, DC	—	—	E51RN	E51RN20	
Built-In Mini-Connector						
Built-In Mini-Connector						
Epoxy filled receptacle with pre-wired mini-connector	2-wire, AC/DC	3-pin	—	E51RAP3 ☼	—	
	4-wire, AC	5-pin	—	E51RCP5 ☼	—	
	4-wire, DC	5-pin	—	E51RNP5 ☼	—	
Pigtail with Mini-Connector						
Pigtail with Mini-Connector						
Epoxy filled receptacle with mini-connector mounted on 3 ft (900 mm) cable	2-wire, AC/DC	3-pin	3 ft (0.9m)	E51RAP3 ☼	—	
	4-wire, AC	5-pin	3 ft (0.9m)	E51RCP5 ☼	—	
	4-wire, DC	5-pin	3 ft (0.9m)	E51RNP5 ☼	—	
Prewired Cable						
Prewired Cable						
Epoxy filled receptacle with pre-wired 16 gauge, yellow jacketed, type SOOW-A cable. Cable enters through hole threaded for conduit	2-wire, AC/DC	3-conductor	8 ft (2.4m)	E51RAS	E51RA20S	
			12 ft (3.6m)	E51RAS12	—	
			20 ft (6m)	E51RAS20	—	
	4-wire, AC	5-conductor	8 ft (2.4m)	E51RCS	E51RC20S	
			12 ft (3.6m)	E51RCS12	—	
			20 ft (6m)	E51RCS20	—	
	4-wire, DC	5-conductor	8 ft (2.4m)	E51RNS	E51RN20S	
			12 ft (3.6m)	E51RNS12	—	
			20 ft (6m)	E51RNS20	—	

Notes

☼☼ See listing of compatible connector cables on [Page V8-T5-103](#).

① Rated NEMA 4, 4X and 13.

② Repeatability of the timing cycle is ±1% at constant voltage, ambient temperature and reset time.

③ Black receptacle is for color compatibility with E51SCN sensor body.

Compatible Connector Cables

Mini Style
Straight Female



E51 Limit Switch Style, Modular Sensors ①

Current Rating at 600V	Voltage Style	Number of Pins	Gauge	Length	Pin Configuration/Wire Colors (Face View Female Shown)	Catalog Number
Standard Cables—Mini Style						
13A	AC/DC	3-pin	16 AWG	6 ft (2m)	1-Green 2-Black 3-White	CSMS3F3CY1602
8A	AC/DC	5-pin	16 AWG	6 ft (2m)	1-White 2-Red 3-Green 4-Orange 5-Black	CSMS5D5CY1602

Accessories

E51 Limit Switch Style, Modular Sensors

Description	Catalog Number
<p>One-hole, Universal</p> <p>Universal Mounting Bracket</p> <p>One-hole, includes mounting hardware, stainless steel</p>	E51KH2
<p>Two-hole, Universal</p> <p>Universal Mounting Bracket</p> <p>Two-hole, includes mounting hardware, steel</p>	E51KH4
<p>Machine Mounting Bracket</p> <p>Machine Mounting Bracket</p> <p>Zinc die cast</p>	E50KH3
<p>Stand-Off Mounting Bracket</p> <p>Stand-Off Mounting Bracket</p> <p>Steel</p>	E51KH3
<p>Remote Sensor Head Assembly</p> <p>Remote Sensor Head Assembly</p> <p>Permits mounting sensor head up to 3 ft (0.9m) from sensor body</p>	E51KRM

Connector Cables

A variety of cables, connector blocks and accessories, see **Tab 10, section 10.1**

Dimensions, see **Page V8-T5-106**.

Note

① For a full selection of connector cables, see **Tab 10, section 10.1**.

Technical Data and Specifications

E51 Limit Switch Style, Modular Sensors

Description	Specification
Output ratings (NEMA D150)	
AC/DC models	0.5A continuous
AC models	1A continuous
DC models	0.6A continuous
Protection	Latching short circuit protection on two-wire AC/DC and four-wire DC models
Indicator LEDs	Lights when output is ON. One LED for each output
Enclosure material	Zinc die cast
Gasket material	Viton
Enclosure ratings	NEMA 3, 3S, 4, 4X, 6, 6P, 12 and 13 (IP67) E51SCN sensor body only: NEMA 4, 4X and 13 ①
Hazardous locations ratings	
Class I	Division II—GRPS ABCD
Class II	Division II—GRPS F and G
Class III	Division 2
Temperature range	-13° to 158°F (-25° to 70°C)
Torque requirements	Switch body screws: 25–30 in-lb; Sensing head screws: 14–18 in-lb
Vibration	10–55 Hz, 1 mm amplitude
Shock	30g, 11 ms, 1/2 sine wave
Humidity	95% non-condensing

Excess Gain

Sensor Heads—Reflex, Diffuse Reflective and Thru-Beam

Reflex (3 in diameter retroreflector)

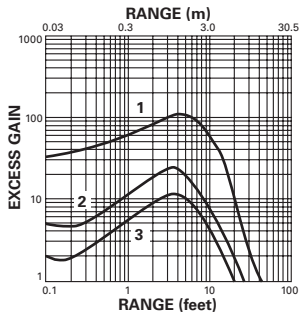

1. E51DP3
2. E51DP1
3. E51DP5

Diffuse Reflective (90% reflective white card)

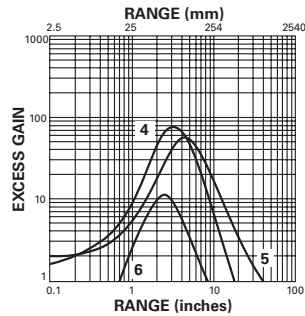

4. E51DP6
5. E51DP4
6. E51DP2 and E51DP22

Thru-Beam

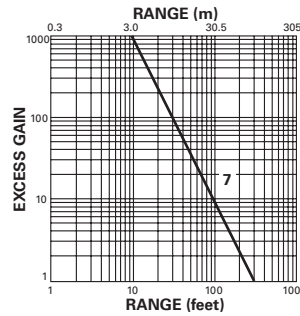

7. E51DEL and E51DED sources using E51DC1 detector

Note

① Our products conform to NEMA tests as indicated, however, some severe washdown applications can exceed these NEMA test specifications.

Sensor Heads—Glass Fiber Optic

Diffuse Reflective (90% reflective white card)

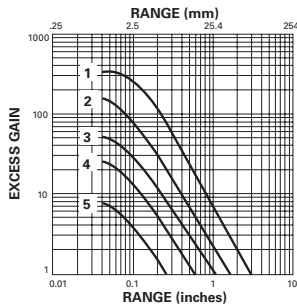

E51DF1 and E51DF3 high power sensor head with:

- 1. 0.125 in fiber bundle
- 2. 0.094 in fiber bundle
- 4. 0.063 in fiber bundle

E51DF33 fast response sensor head with:

- 3. 0.125 in fiber bundle
- 4. 0.094 in fiber bundle
- 5. 0.063 in fiber bundle

Thru-Beam

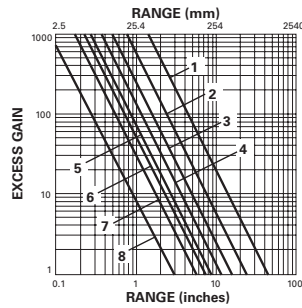

E51DF4 extended range sensor head with:

- 1. 0.125 in fiber bundle
- 4. 0.063 in fiber bundle

E51DF1 and E51DF3 high power sensor head with:

- 2. 0.125 in fiber bundle
- 3. 0.094 in fiber bundle
- 6. 0.063 in fiber bundle

E51DF33 fast response sensor head with:

- 5. 0.125 in fiber bundle
- 7. 0.094 in fiber bundle
- 8. 0.063 in fiber bundle

Wiring Diagrams

Pin numbers are for reference, rely on pin location when wiring.

E51 Limit Switch Style, Modular Sensors

Operating Voltage	Output ①	Terminal and Cable Models	Mini-Connector Models (Face View Male Shown)
Two-Wire Sensors			
20–264 Vac or Vdc 50/60 Hz	NO or NC		
Four-Wire Sensors			
120 Vac 50/60 Hz	NO and NC		
10–30 Vdc	NO and NC NPN		
	NO and NC PNP		

Note

① Changing light/dark switch on sensor head will reverse output function (NO becomes NC, and NC becomes NO).

5.10

Photoelectric Sensors

E51 Limit Switch Style, Modular Sensors

Dimensions

Approximate Dimensions in mm [in]

Standard Sensor

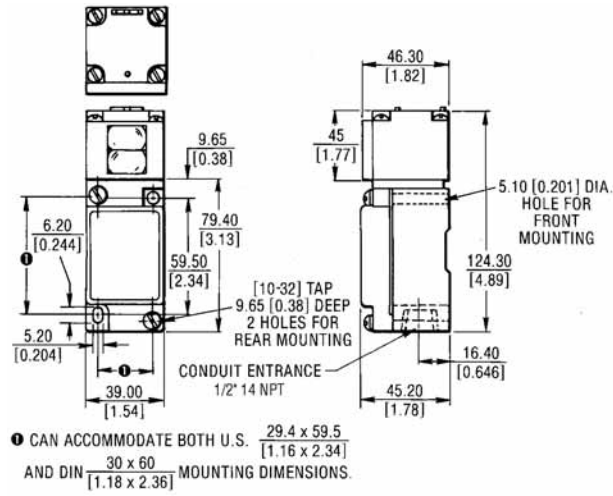

Sensor with Logic Module

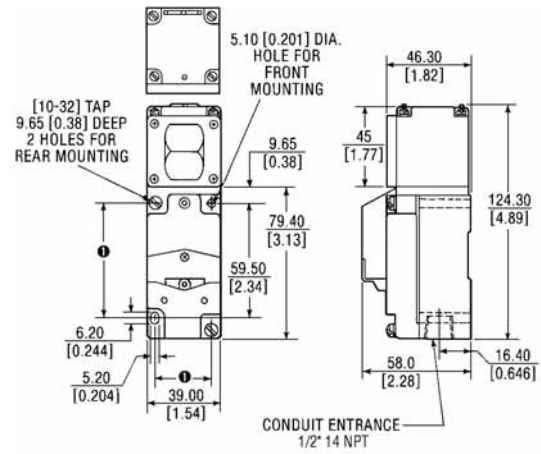

Accessories

Approximate Dimensions in Inches [mm]

Universal Mounting Bracket—E51KH2

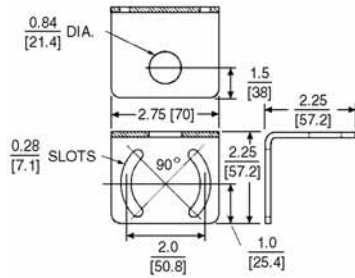

Universal Mounting Bracket—E51KH4

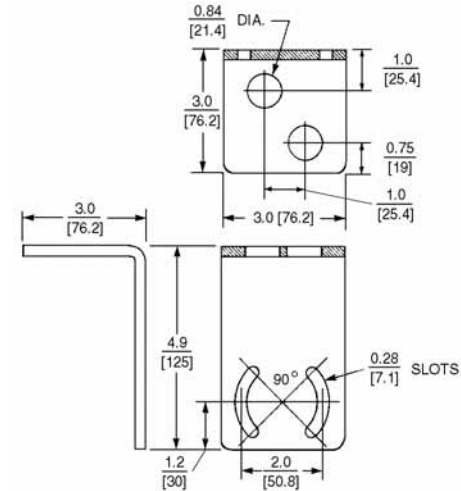

Approximate Dimensions in mm [in]

Machine Mounting Bracket

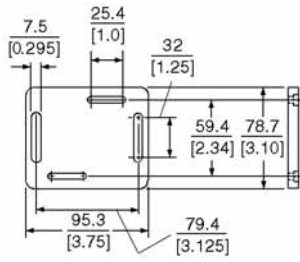

Stand-Off Mounting Bracket

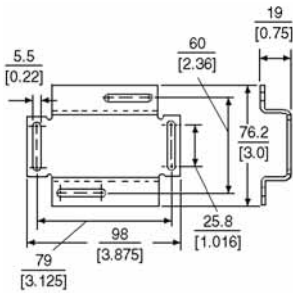

Approximate Dimensions in Inches [mm]

Remote Sensor Head Assembly

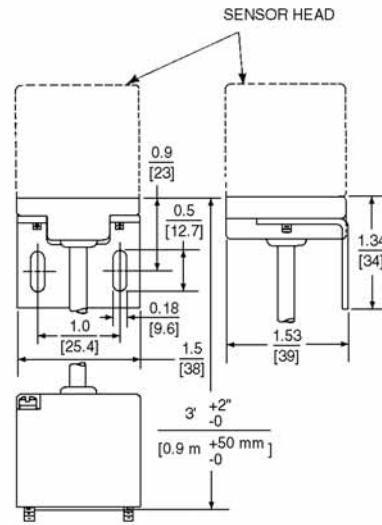

E68 Series Integral Sensor Valve



200 Series Zero Pressure Accumulation



Sensor Power Supplies



6.0	Introduction	
	Product Selection Guide	V8-T6-2
6.1	E68 Series Integral Sensor Valve	
	Product Description	V8-T6-3
	Product Selection	V8-T6-5
	Accessories	V8-T6-7
	Technical Data and Specifications	V8-T6-10
	Wiring Diagrams	V8-T6-11
	Dimensions	V8-T6-13
6.2	200 Series Zero Pressure Accumulation	
	Product Description	V8-T6-14
	Product Selection	V8-T6-16
	Accessories	V8-T6-19
	Technical Data and Specifications	V8-T6-21
	Wiring Diagrams	V8-T6-22
	Dimensions	V8-T6-24
6.3	Sensor Power Supply—NEMA 4 Universal Voltage	
	Product Description	V8-T6-25
	Product Selection	V8-T6-26
	Technical Data and Specifications	V8-T6-26
	Wiring Diagrams	V8-T6-27
	Dimensions	V8-T6-27
6.4	Sensor Power Supply—NEMA 1, 120 Vac	
	Product Description	V8-T6-28
	Product Selection	V8-T6-29
	Technical Data and Specifications	V8-T6-29
	Wiring Diagram	V8-T6-30
	Dimensions	V8-T6-30



Unless otherwise noted, the products contained in this section should not be used for functional safety applications. These products were not designed or tested to IEC 60947-5-3 or recommended for functional safety.

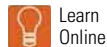

Learn
Online

For Customer Service in the U.S. call 1-877-ETN CARE (386-2273),
in Canada call 1-800-268-3578.
For Application Assistance in the U.S. and Canada
call 1-800-426-9184.

Product Selection Guide

E68 Integral Sensor Valve



Page V8-T6-3

Overview

A complete Zero Pressure Accumulation (ZPA) sensing and control solution. This system solves the problem of product damage and mishandling caused by mechanical sensor rollers on outdated ZPA conveyors.

Conveyor Systems

Self-contained package includes sensor, logic, air valve, and wiring
 Non-contact, true Zero Pressure Accumulation
 Multiple algorithms available to provide the exact functionality you require
 Multiple wiring options available—including NEMA® 4 and NEMA 1 varieties
 Low installation costs
 Integrated “beam status” contact available to allow direct integration into AC or DC control systems
 One-touch air fittings for quick installation
 Low-profile package allows easy integration into conveyor side-channel
 System designed with sub-4A 24 Vdc wiring for safety and reduced installation costs
 Easily interfaced to external control systems for singulated discharge and/or slug release
 Highly optimized, low-cost power supply

Technical Data and Specifications

Operations—Warranted for up to 60 million operations (3 years)
 Electrical ratings—
 100 mA current switching capacity; 132 Vac/dc maximum switching voltage; 400V isolation; 10 mA maximum off-state leakage; 25W maximum on-state resistance
 Enclosure ratings—
 NEMA 1 and NEMA 4 (by model)

Approvals

cULus



200 Series Zero Pressure Accumulation



Page V8-T6-14

Overview

A fully engineered non-contact, photoelectric sensor system with built-in accumulation control. This sensor system solves the problem of product damage and mishandling caused by mechanical sensor rollers on outdated ZPA conveyors.

Conveyor Systems

Non-contact, true Zero Pressure Accumulation control without a PLC
 Multiple algorithms available to provide the exact functionality you require
 Additional gap and compression timing versions available
 Low installation costs with pre-measured and connectorized wiring
 Fits zone lengths between 18 and 60 inches in 6-inch increments and conveyors up to 60 inches wide
 Compatible with commonly available solenoid-operated air valves
 Sensors are short circuit protected with automatic reset of sensor when short is removed
 System designed with sub-4A 24 Vdc wiring for safety and reduced costs
 Easily interfaced to external control systems for singulated discharge and/or slug release

Technical Data and Specifications

Operations—Warranted for up to 60 million operations (3 years)
 Electrical ratings—
 18 to 30 Vdc, 100 mA current switching capacity; 10 mA maximum off-state leakage; 8 mS response time; NPN or PNP
 Enclosure ratings—NEMA 1
 Material—Polycarbonate lens, cyclopol and lexan body, glass-filled PCT connector

Approvals

—

Sensor Power Supply—NEMA 4 Universal Voltage



Page V8-T6-25

Overview

Designed to be used with the 200 Series and E68 Series Zero Pressure Accumulation Systems, but is also suitable for use in a wide variety of general material handling applications. The unit delivers 100W output at 27 Vdc and supports easy, Class II wiring

Sensors

Integrated AC junction box features for one-step mounting and wiring without the need for additional accessories or enclosures
 Built-in DC power health contact allows easy monitoring of power supply status
 Unique design features a tamper-proof sealed construction to reduce the risk of damage associated with conventional open control-panel type supplies
 Built-in slug-release input converts an AC or DC input to the appropriate DC signal for integration with the 200 Series and E68 Series Zero Pressure Accumulation Systems
 Dual output connection terminals to make it easy and convenient to locate the power supply at the center of the cable run

Technical Data and Specifications

Electrical ratings—100 to 250 Vac operating voltage; 27 Vdc, 100 watt output; 15–132 Vac/dc 3 mA minimum slug input; PNP or NPN, switch selectable
 Enclosure ratings—NEMA 4X
 Material—Aluminum

Approvals

cULus Class 2



Sensor Power Supply—NEMA 1 120 Vac



Page V8-T6-28

Overview

Designed to be used with the 200 Series and E68 Series Zero Pressure Accumulation Systems, but is also suitable for use in a wide variety of general material handling applications. The unit delivers 100W output at 27 Vdc and supports easy, Class II wiring

Sensors

Integrated AC junction box for one-step mounting and wiring without the need for additional accessories
 Built-in DC power health contact allows easy monitoring of power supply status
 Unitized design features a tamper-proof encapsulated construction to reduce the risk of damage associated with conventional open control-panel type construction
 Built-in slug-release input converts an AC or DC input to the appropriate DC signal for integration with the 200 Series and E68 Series Zero Pressure Accumulation Systems
 Dual output connection terminals to make it easy and convenient to locate the power supply at the center of the cable run

Technical Data and Specifications

Electrical ratings—
 105 to 132 Vac operating voltage; 27 Vdc, 100 watt output; 15–132 Vac/dc 3 mA minimum slug input; PNP or NPN, switch selectable
 Enclosure ratings—NEMA 1
 Material—Die-cast aluminum

Approvals

UL® Listed
 cUL® Approved



E68 Series Integral Sensor Valve



E68 Series Integral Sensor Valve

Product Description

The E68 Series Integral Sensor Valve (ISV) from Eaton's electrical sector is a complete Zero Pressure Accumulation (ZPA) sensing and control solution. This system solves the problem of product damage and mishandling caused by mechanical sensor rollers on outdated ZPA conveyors.

A Complete, Pre-Engineered Solution

The ISV comes complete with all needed components including sensors, air valves, pre-measured connectors, power supplies and accessories. These components simply snap together to provide reliable conveyor control without the need to invest costly engineering time. The compact power supply, designed specifically for our ZPA products, includes an integral junction box to eliminate additional mounting enclosures.

Fast, Low Cost Installation and Retrofit

The unique ISV reduces installation costs by integrating the sensor, valve and control logic into one device. Only one device needs to be installed to provide a full zone's worth of control. Connections between zones are also included, eliminating the need to run any additional wiring. Wiring is optimized for an exact fit, eliminating unsightly cable loops that could be snagged and damaged.

Features

- Self-contained package includes sensor, logic, air valve, and wiring
- Non-contact, true Zero Pressure Accumulation
- Multiple algorithms available to provide the exact functionality you require
- Multiple wiring options available—including NEMA 4 and NEMA 1 varieties

Contents

Description	Page
E68 Series Integral Sensor Valve	
Product Overview	V8-T6-4
Product Selection	
Basic Logic Sensors	V8-T6-5
Progressive Logic Sensors	V8-T6-6
Accessories	V8-T6-7
Technical Data and Specifications	V8-T6-10
Excess Gain	V8-T6-11
Wiring Diagrams	V8-T6-11
Dimensions	V8-T6-13

- Low installation costs
- Integrated "beam status" contact available to allow direct integration into AC or DC control systems
- One-touch air fittings for quick installation
- Low-profile package allows easy integration into conveyor side-channel
- System designed with sub-4A 24 Vdc wiring for safety and reduced installation costs
- Easily interfaced to external control systems for singulated discharge and/or slug release
- Highly optimized, low-cost power supply
- Custom brackets and sensor/bracket assemblies available

Standards and Certifications

- cULus



⚠ DANGER

THIS SENSOR IS NOT A SAFETY DEVICE AND IS NOT INTENDED TO BE USED AS A SAFETY DEVICE. This sensor is designed only to detect and read certain data in an electronic manner and perform no use apart from that, specifically no safety-related use. This sensor product does not include self-checking redundant circuitry, and the failure of this sensor product could cause either an energized or de-energized output condition, which could result in death, serious bodily injury, or property damage.

For the most current information on this product, visit our Web site: www.eaton.com

For Customer Service in the U.S. call 1-877-ETN CARE (386-2273), in Canada call 1-800-268-3578. For Application Assistance in the U.S. and Canada call 1-800-426-9184.

Product Overview

High Reliability and Flexibility

ISV sensors are available in both polarized reflex and diffuse reflective sensing modes. Polarized sensors eliminate detection errors caused by shiny targets and provide the highest level of high sensing reliability when used at common conveyor widths.

Diffuse reflective models can be installed in low lift-height locations and other areas on the conveyor where it may not be possible to mount a polarized reflex sensor and reflector. These models have an extremely narrow field of view to allow for mounting below the level of the conveyor rollers in certain cases where necessary.

Choose a Sensor to Meet Your Specific Needs

To provide an ideal solution for a wide variety of Zero Pressure Accumulation needs, ISV sensors are available in two different embedded logic modes:

- The Basic Logic Series offers high-throughput smart Zero Pressure Accumulation control. This logic results in singulation and Zero Pressure Accumulation. Each sensor checks the status of the downstream zone and each zone always runs except when both the current and downstream zones are full
- The Progressive Logic Series offers even higher throughput than the Basic Logic. This logic does not singulate product, but does result in Zero Pressure Accumulation. Each zone always runs until all of the zones downstream are full, allowing maximum efficiency.

E68 Series System Components

Sensor



The ISV sensor has been specially designed with upstream communication abilities and internal logic to implement Zero Pressure Accumulation (ZPA) control. When combined with the following components, a complete ZPA conveyor control system can be literally snapped into place on your conveyor. Two versions are available depending upon the control you require: Basic Logic and Progressive Logic (described on this page).

Sensor with Integrated Beam Status Output

These ISV Sensors are the same as standard units in all respects, with the exception of a special output connector that is added to the sensor body. This allows you to conveniently access the beam status output of any zone by simply substituting a special sensor of this type in place of a standard unit. This is useful, for example, at the infeed end of a section of conveyor where a lane full signal is required, as a separate photo-eye need not be mounted.

Power Supply

A 4A Power Supply designed for use with the Conveyor Sensor systems. A single power supply can normally operate up to 50 zones. For more information, see **Page V8-T6-28**.

Power Supply Cable

This cable allows the power supply to be connected to any zone, while allowing use of that zone.

Release Cable

This cable is normally connected to the last zone and is tied to your external control to allow release of product from the conveyor system. The system can be wired to the power supply to enable either singulated product release or slug/train release from the conveyor's discharge end.

Buss Harness (Not required with Daisy-chained models)



The Buss Harness distributes power, slug release signals and provides communications links for Multi-drop versions of the ISV. Made from flat ribbon cable, it is available in 10, 50 and 100 ft lengths and is connectorized at intervals to match your zone length (18 to 60 inches in 6 inch increments). A buss link accessory can be used to join multiple sections together, while a zone jumper accessory may be used to skip unused zones. This harness is only required for Multi-drop connection versions of the ISV (described on this page).

It's So Easy to Get Started, All That's Needed Is ...

- Your conveyor zone length(s)
- Preferred ZPA algorithm
- Preferred connection style (see below)

Daisy-chained connection with NEMA 4 sealed micro-connectors





Daisy-chained connection with NEMA 1 unsealed connectors





Product Selection

Basic Logic Sensors

Polarized Reflex ^①

	Sensing Range	Optimum Range	Field of View	Connection Type	Operate Mode ^②	Option	Standard Catalog Number	
 E68-SVSPR3-B_	10 ft (3m)	0.1 to 8 ft (0.03 to 3.6m)	3 in (76 mm) diameter at 12 ft (3.6m)	Daisy-chain— NEMA 1	Air to drive	—	E68-SVSPR3-BLC	
						Isolated beam output	E68-SVSPR3-BLC-B	
						Air to brake	—	E68-SVSPR3-BDC
						Isolated beam output	E68-SVSPR3-BDC-B	
 E68-SVSPR3-B	10 ft (3m)	0.1 to 8 ft (0.03 to 3.6m)	3 in (76 mm) diameter at 12 ft (3.6m)	Daisy-chain— NEMA 4	Air to drive	—	E68-SVSPR3-BLP	
						Isolated beam output	E68-SVSPR3-BLP-B	
						Air to brake	—	E68-SVSPR3-BDP
						Isolated beam output	E68-SVSPR3-BDP-B	

Diffuse Reflective ^③



	Sensing Range	Optimum Range	Field of View	Connection Type	Operate Mode ^②	Option	Standard Catalog Number	
 E68-SVSSD1-B_	3 ft (1m)	0.2 to 2 ft (0.06 to 0.6m)	0.2 in (5 mm) diameter at 2 in (51 mm) 6 in (152 mm) diameter at 5 ft (1.5m)	Daisy-chain— NEMA 1	Air to drive	—	E68-SVSSD1-BLC	
						Isolated beam output	E68-SVSSD1-BLC-B	
						Air to brake	—	E68-SVSSD1-BDC
						Isolated beam output	E68-SVSSD1-BDC-B	
 E68-SVSSD1-B	3 ft (1m)	0.2 to 2 ft (0.06 to 0.6m)	0.2 in (5 mm) diameter at 2 in (51 mm) 6 in (152 mm) diameter at 5 ft (1.5m)	Daisy-chain— NEMA 4	Air to drive	—	E68-SVSSD1-BLP	
						Isolated beam output	E68-SVSSD1-BLP-B	
						Air to brake	—	E68-SVSSD1-BDP
						Isolated beam output	E68-SVSSD1-BDP-B	

Notes



- ① Ranges based on a 3 in diameter retroreflector.
- ② "Air to drive" refers to a conveyor system where air pressure must be supplied to air cylinders to cause the conveyor to run. "Air to brake" is just the opposite where air pressure must be supplied to air cylinders to cause the conveyor to stop.
- ③ Sensors will detect a 90% reflectance white card at this range.

Progressive Logic Sensors

Polarized Reflex ^①

	Sensing Range	Optimum Range	Field of View	Connection Type	Operate Mode ^②	Option	Standard Catalog Number
	10 ft (3m)	0.1 to 8 ft (0.03 to 3.6m)	3 in (76 mm) diameter at 12 ft (3.6m)	Daisy-chain— NEMA 1	Air to drive	—	E68-SVSPR3-PLC
						Isolated beam output	E68-SVSPR3-PLC-B
						Air to brake	E68-SVSPR3-PDC
						Isolated beam output	E68-SVSPR3-PDC-B
	10 ft (3m)	0.1 to 8 ft (0.03 to 3.6m)	3 in (76 mm) diameter at 12 ft (3.6m)	Daisy-chain— NEMA 4	Air to drive	—	E68-SVSPR3-PLP
						Isolated beam output	E68-SVSPR3-PLP-B
						Air to brake	E68-SVSPR3-PDP
						Isolated beam output	E68-SVSPR3-PDP-B

Diffuse Reflective ^③

	Sensing Range	Optimum Range	Field of View	Connection Type	Operate Mode ^②	Option	Standard Catalog Number
	3 ft (1m)	0.2 to 2 ft (0.06 to 0.6m)	0.2 in (5 mm) diameter at 2 in (51mm) 6 in (152 mm) diameter at 5 ft (1.5m)	Daisy-chain— NEMA 1	Air to drive	—	E68-SVSSD1-PLC
						Isolated beam output	E68-SVSSD1-PLC-B
						Air to brake	E68-SVSSD1-PDC
						Isolated beam output	E68-SVSSD1-PDC-B
	3 ft (1m)	0.2 to 2 ft (0.06 to 0.6m)	0.2 in (5 mm) diameter at 2 in (51mm) 6 in (152 mm) diameter at 5 ft (1.5m)	Daisy-chain— NEMA 4	Air to drive	—	E68-SVSSD1-PLP
						Isolated beam output	E68-SVSSD1-PLP-B
						Air to brake	E68-SVSSD1-PDP
						Isolated beam output	E68-SVSSD1-PD

Notes

- ① Ranges based on a 3 in diameter retroreflector.
- ② “Air to drive” refers to a conveyor system where air pressure must be supplied to air cylinders to cause the conveyor to run.
“Air to brake” is just the opposite where air pressure must be supplied to air cylinders to cause the conveyor to stop.
- ③ Sensors will detect a 90% reflectance white card at this range.

Accessories

Cables

Sensor Output Cables

Length	Description	Used with Sensors	Catalog Number
Beam Status Output Cable			
1m	Wires from the beam status output connector on the sensor to a remote PLC or other controller	E68....-xyz-B	E68-SVABEAM-1



Power Supply Cables

Length	Description	Used with Sensors	Catalog Number
Power Supply "T" Connection			
2m	This cable allows the power supply to be connected between any two zones, while allowing use of those zones. For best results, the power supply cable should be connected at the center of the zones being powered. Tinned leads on power supply end. 12 mm DC-key connector on power supply end.	E68....-xyC	E68-SVAPWR-C2
		E68....-xyP	E68-SVAPWR-P02
		E68....-xyP	E68-SVAPWR-P2



Length	Description	Used with Sensors	Catalog Number
Power Supply Cable			
2m	This cable allows the power supply to be connected to any zone, while allowing use of that zone. For best results, the power supply cable should be connected at the center of the zones being powered.	E68....-xy	BUS266PWR-01B1
50m		E68....-xy	BUS266PWR-5001B1



Length	Description	Used with Sensors	Catalog Number
Power Supply			
—	27 Vdc, 100W; short-circuit, overload and overvoltage protection (cycle power to reset). Power supply can normally power up to 50 ISV zones. See PG.05.06.T.E for more details.	E68....	PS256A-01B1



Release Cables

Length	Description	Used with Sensors	Catalog Number
E68-SVAREL2- Release Cable – With Release and Power Connection			
2m	This cable is connected to the last zone and allows singulate or slug discharge control from an external system. Both release and power connections are provided. If the power connections are used, a separate power supply "T" cable is not needed.	E68....-xyC	E68-SVAREL2-C2
		E68....-xyP	E68-SVAREL2-P2



Length	Description	Used with Sensors	Catalog Number
BUS266REL-01B1 Release Cable – With Release Connection Only			
2m	This cable is connected to the last zone and allows singulate or slug discharge control from an external system. Release connections only are provided.	E68....-xy	BUS266REL-01B1





Length	Description	Used with Sensors	Catalog Number
BUS266REL-01B1 Release Cable – With Release and Power Connection			
2m	This cable is connected to the last zone and allows singulate or slug discharge control from an external system. Both release and power connections are provided. If the power connections are used, a separate power supply cable is not needed.	E68....-xy	BUS266REL-02B1





Zone Extensions and Jumpers



Zone Extension Cable

	Length	Description	Used with Sensors	Catalog Number
E68-SVAEXT-C1	1m	Used for zone lengths >36 in	E68.....xyC	E68-SVAEXT-C1
				
E68-SVAEXT-P1			E68.....xyP	E68-SVAEXT-P1
				

Power Jumper

	Length	Description	Used with Sensors	Catalog Number
E68-SVAJMP1-C5	5m	Used to slave an asynchronous ZPA chain—does not pass accumulation signals.	E68.....xyC	E68-SVAJMP1-C5
				
E68-SVAJMP1-P5			E68.....xyP	E68-SVAJMP1-P5
				



Power Isolation Cable

	Length	Description	Used with Sensors	Catalog Number
E68-SVAISO-C	2 ft (0.6m)	Used to isolate parallel power supplies on an extended ZPA chain.	E68.....xyC	E68-SVAISO-C
				
E68-SVAISO-P			E68.....xyP	E68-SVAISO-P
				



Zone Jumper

	Length	Description	Used with Sensors	Catalog Number
QDJU266A-01B1	5 in	A zone jumper is required when a zone is skipped to allow communications to continue through the unused zone.	E68.....xy	QDJU266A-01B1
				

Slug Isolation Cable

	Length	Description	Used with Sensors	Catalog Number
E68-SVASLUG-C	2 ft (0.6m)	Used to break a slug release signal to affect closer control of product release. Insert between any two zones, and a slug release signal is isolated from all upstream zones.	E68.....xyC	E68-SVASLUG-C
				
E68-SVASLUG-P			E68.....xyP	E68-SVASLUG-P
				

Buss Link Cable

	Length	Description	Used with Sensors	Catalog Number
BUS266LINK-01B1 	10 cm	This cable allows two sections of buss harness to be connected together. ^① Passes power and ZPA signals.	E68....-xy	BUS266LINK-01B1
BUS266ISO-01B1 		Power isolation version. Passes ZPA signals but isolates power.	E68....-xy	BUS266ISO-01B1
BUS266JUMP15_ 	3m	This cable allows two sections of buss harness to be connected together. DC power is passed through the connection. Passes power only.	E68....-xy	BUS266JUMP15-01B1
		This cable allows two sections of buss harness to be connected together. Both DC power and the ZPA signal is passed through the connection. Passes power and ZPA signals.	E68....-xy	BUS266JUMP15-02B1

Power Curve Delay Module

	Length	Description	Used with Sensors	Catalog Number
1451BS_ 	—	Allows ZPA through a powered curve that is not divided into ZPA controlled zones. Installed adjacent to the sensor at the powered curve infeed. All required wiring is included.	E68...-xy E68...-xyC E68...-xyP	1451BSR1216 1451BSC1216 1451BSP1216

Connector Covers

	Description	Used with Sensors	Catalog Number
E68-SVAUSC-P 	Upstream Connector Cover Used to seal the upstream micro-connector on the most infeed sensor.	E68....-xyP	E68-SVAUSC-P

	Description	Used with Sensors	Catalog Number
E68-SVADSC-P 	Downstream Connector Cover Used to seal the downstream micro-connector on the discharge sensor (if a release cable is not connected).	E68....-xyP	E68-SVADSC-P

Mounting Brackets

	Description	Used with Sensors	Catalog Number
6161AS0285 	Mounting Bracket Mounting bracket for E68 sensor family. Can be used to mount E68 sensor to conveyor side channel. Can also be used to mount 3 in retroreflector (6200A-6506).	E68....	6161AS0285

Dimensions, see **Page V8-T6-13**.

Note

① 10 ft versions of buss harness have this connector built-in.

Technical Data and Specifications

E68 Series Integral Sensor Valve

Description	Specification
Input voltage	18–30 Vdc
Power dissipation	1.35W at 27 Vdc
Indicator LED	Red LED: Lights steady when air valve open
Response time	25 ms maximum to 90% air flow. 18.2 Hz maximum operation
Air to drive/Air to brake operation	Specified by catalog number
Beam status output (optional)	Solid-state relay; 400V isolation; 132 Vac/dc maximum switching voltage; 100 mA current switching capacity; 10 mA maximum off-state leakage; 25W maximum on-state resistance. Output protected (current limited) for loads less than 32V. ^①
Temperature range	Operating: 14° to 131°F (–10° to 55°C); Storage: –13° to 158°F (–25° to 70°C)
Material of construction	Lens: polycarbonate; cable jacket: polyvinylchloride; body: structural polyurethane foam; muffler: brass; fittings: brass, polybutylene terephthalate, polyacetel, BUNA-N; label overlay: polyester. ^②
Mounting	Mount with two #8 fasteners (not included). Torque to between 12 and 14 in-lbs
Connectors	Multi-drop models: Insulation-displacement connectors, factory installed Daisy-chain NEMA 1 models (unsealed): 4-pin AMP DESC Connector Daisy-chain NEMA 4 models (sealed): 4-pin, DC-key micro-connectors Beam status output: 3-pin male nano-connector
Vibration and shock	Vibration: 30g over 10 Hz to 2 kHz; shock: 100g for 3 ms 1/2 sine wave pulse
Sunlight immunity	10,000 ft-candles
Enclosure ratings	Multi-drop and unsealed Daisy-chain models: NEMA 1 only Sealed Daisy-chain models: NEMA 1, 4 ^③
Operations	100 million operations over 5 years. Warranty: 3 years (maximum 60 million operations)
Valve type	Three-way, vent to atmosphere
Valve specifications	Cv = 0.03; 0 to 75 psi operation ^④
Valve fittings	1/4 in "one-touch" fittings. ^⑤
Product packaging	Sensors are bulk packaged. Maximum 10 sensors per bag.

Optical Performance

All optical specifications are guaranteed to be the minimum performance under clean conditions of any product delivered from stock. Typical performance may be higher.

Dirt in the environment will affect optical performance by reducing the amount of light the control receives.

For best results, sensors should be used at distances where excess gain is higher than 1.5 (1.5 times the amount of sensing power required to detect an object under ideal conditions). Higher excess gain will allow the sensor to overcome higher levels of contamination on the lens.

Polarized Reflex

Description	Specification
Source	Visible red, 680 nm
Maximum range	10 ft
Optimum range	0.1 to 8 ft
Field of view	3 in dia. at 12 ft

Diffuse Reflective

Description	Specification
Source	Infrared
Maximum Range	3 ft
Optimum Range	3 in to 2 ft
Field of View	0.2 in dia. at 2 in; 6 in dia. at 5 ft

Notes

- ① Output will reset automatically when short is removed (there is no visual indication of a short-circuit condition).
- ② Do not expose to concentrated acids, alcohols or ketones.
- ③ These products conform to NEMA tests as indicated, however, some severe washdown applications can exceed these NEMA test specifications.
- ④ Dry or lubricated shop air, filtered to less than 5 micrometers required.
- ⑤ Fittings must be tightened to 10.6–17.7 in-lbs.

Excess Gain

Polarized Reflex (3 in diameter retroreflector)

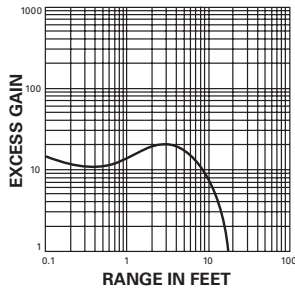

Diffuse Reflective (90% reflectance white card)

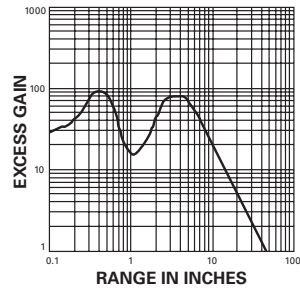

Wiring Diagrams

E68 Series Integral Sensor Valve

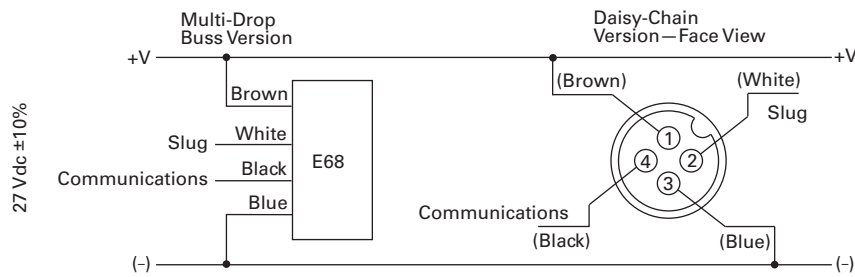

6.1

Conveyor Sensor Systems

E68 Series Integral Sensor Valve

Typical "Daisy-Chain" Wiring Example—Center Tap Arrangement

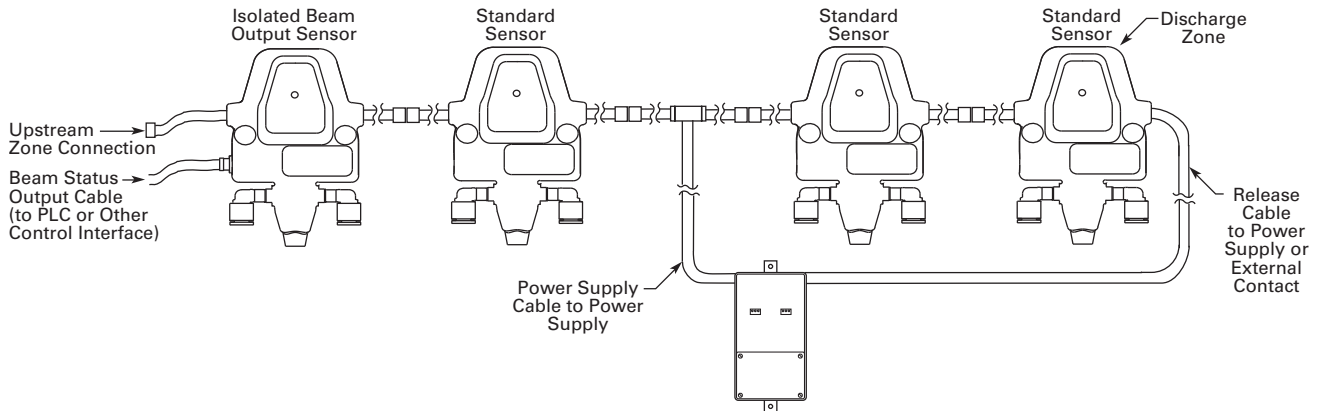

6

Typical "Daisy-Chain" Wiring Example—End Tap Arrangement

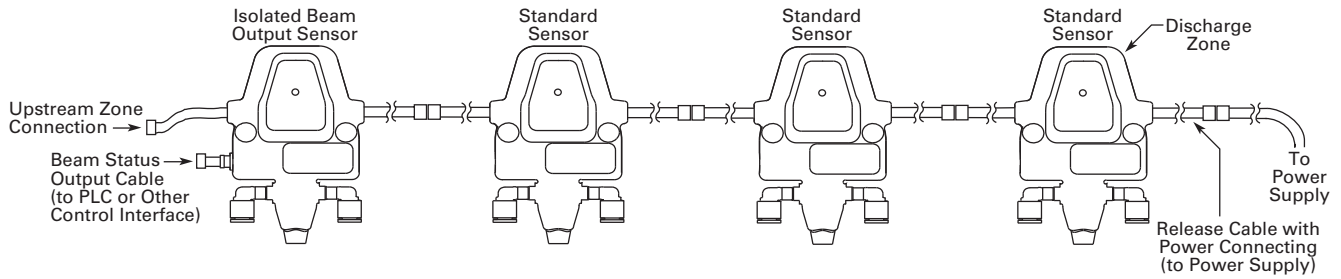

Dimensions

Approximate Dimensions in Inches (mm)

E68 Series Integral Sensor Valve ①

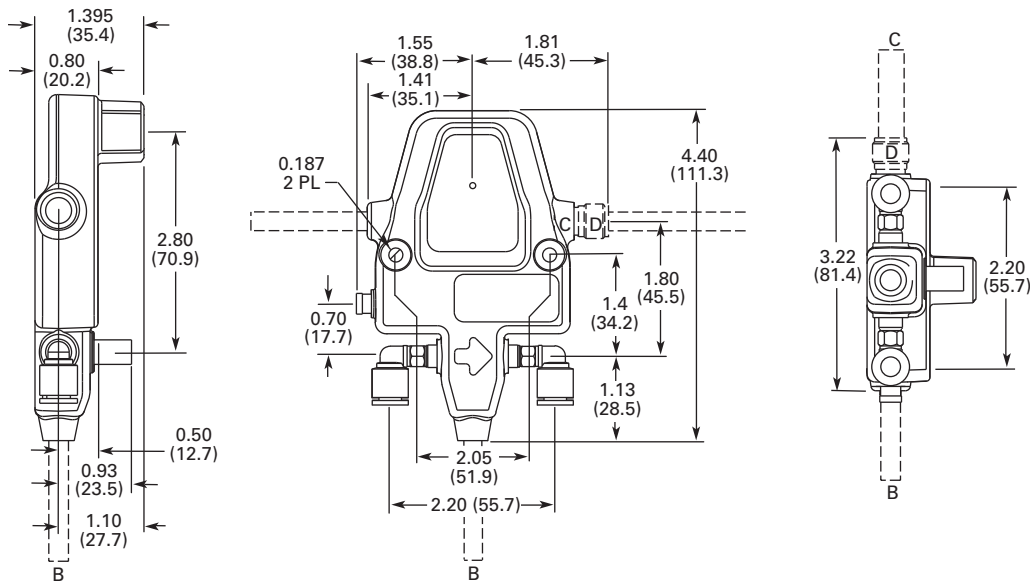

Mounting Bracket

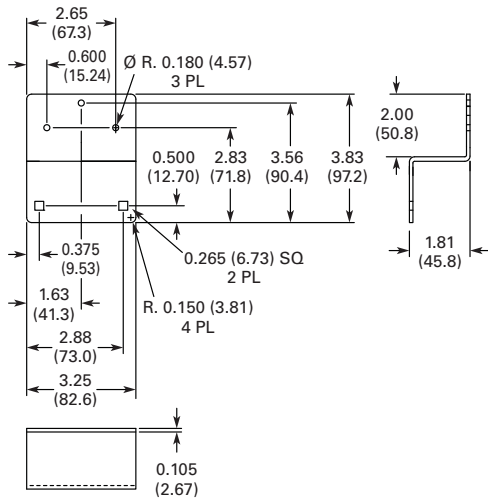

Note

- ① Above dimension diagrams display the following three models of the E68:
 A + D = Daisy-chain NEMA 4 sealed;
 A + C = Daisy-chain NEMA 1 unsealed;
 B = Multi-drop buss harness

200 Series Zero Pressure Accumulation



200 Series Zero Pressure Accumulation

Product Description

The 200 Series by Eaton's electrical sector is an easy to use Zero Pressure Accumulation (ZPA) sensing and control solution. This sensor system solves the problem of product damage and mishandling caused by mechanical sensor rollers on outdated ZPA conveyors.

A Complete, Pre-Engineered Solution

The 200 Series comes complete with all needed components including sensors, pre-measured cables, power supplies, and accessories. These components simply snap together to provide reliable Zero Pressure Accumulation conveyor control without the need to invest costly engineering time in a PLC-based system. The compact power supply, designed specifically for the 200 Series, includes an integral junction box to eliminate additional mounting enclosures.

Features

- Non-contact, true Zero Pressure Accumulation control without a PLC
- Multiple algorithms available to provide the exact functionality you require
- Additional gap and compression timing versions available
- Low installation costs with pre-measured and connectorized wiring
- Fits zone lengths between 18 and 60 inches in 6 inch increments and conveyors up to 60 inches wide
- Compatible with commonly available solenoid-operated air valves
- Sensors are short circuit protected with automatic reset of sensor when short is removed
- System designed with sub-4A 24 Vdc wiring for safety and reduced costs
- Easily interfaced to external control systems for singulated discharge and/or slug release
- Highly optimized, low-cost power supply
- Custom brackets and sensor/bracket assemblies available

Standards and Certifications

- Contact factory for latest list of agency approvals

⚠ DANGER

THIS SENSOR IS NOT A SAFETY DEVICE AND IS NOT INTENDED TO BE USED AS A SAFETY DEVICE. This sensor is designed only to detect and read certain data in an electronic manner and perform no use apart from that, specifically no safety-related use. This sensor product does not include self-checking redundant circuitry, and the failure of this sensor product could cause either an energized or de-energized output condition, which could result in death, serious bodily injury, or property damage.

Contents

<i>Description</i>	<i>Page</i>
200 Series Zero Pressure Accumulation	
Product Overview	V8-T6-15
Product Selection	
Basic and Progressive Logic Sensors	V8-T6-16
Standard Sensors	V8-T6-18
Accessories	V8-T6-19
Technical Data and Specifications	V8-T6-21
Excessive Gain	V8-T6-22
Wiring Diagrams	V8-T6-22
Dimensions	V8-T6-24

For Customer Service in the U.S. call 1-877-ETN CARE (386-2273), in Canada call 1-800-268-3578.
For Application Assistance in the U.S. and Canada call 1-800-426-9184.

For the most current information on this product, visit our Web site: www.eaton.com

Product Overview

Fast, Low Cost Installation and Retrofit

The unique 200 Series reduces installation costs by eliminating measuring, wire stripping and attachment of custom connectors. The main buss cable has connectors pre-installed at points to match your conveyor zone length. Zone length can be from 18 to 60 inches in 6 inch increments. Custom wiring harnesses are supplied for an exact fit-between the main buss cable, the solenoid, and the sensor to eliminate unsightly cable loops that might otherwise be snagged and damaged.

High Reliability

200 Series sensors operate in the polarized reflex sensing mode. Polarized sensors eliminate detection errors caused by shiny targets. The sensor's 10 ft maximum range provides high sensing reliability when used at common conveyor widths.

Choose a Sensor to Meet Your Specific Needs

To provide an ideal solution for a wide variety of zero-pressure accumulation needs, 200 Series sensors are available in two different embedded logic modes:

- The Basic Logic Series offers high-throughput smart Zero Pressure Accumulation control. This logic results in singulation and Zero Pressure Accumulation. Each sensor checks the status of the downstream zone and each zone always runs except when both the current and downstream zones are full. Models are available in either Zone Full Delay Timer or Zone Empty Timer configurations
- The Progressive Logic Series offers even higher throughput than the Basic Logic. This logic does not singulate product, but does result in Zero Pressure Accumulation. Each zone always runs until all of the zones downstream are full, allowing maximum efficiency. Models are available in either Zone Full Delay Timer or Zone Empty Timer configurations

Sensor



The 200 Series sensor has been specially designed with upstream communication abilities and internal logic to implement true zero pressure accumulation control. When combined with the components below, a complete ZPA conveyor control system can be literally snapped into place on your conveyor. Two versions are available depending upon the control you require: Basic Logic and Progressive Logic (described on this page).

Sensor with Additional Time Delay

These 200 Series sensors are the same as standard units in all respects, with the exception of additional time delay circuitry designed to afford you enhanced zero pressure accumulation control. Versions with a "Gap Timer" offer you an adjustable delay to insert additional gaps between adjacent products as they move down the conveyor (beyond those gaps normally present due to the operation of the built-in true zero pressure accumulation logic). Versions with a "Compression Timer" offer you an adjustable delay to compress packages together during the accumulation process.

Sensor Harness



The sensor harness connects the sensor to the buss harness and solenoid^①. This is the only custom part of the system—the length is optimized for an exact fit on your conveyor to eliminate cable loops that could otherwise be damaged.

Buss Harness



The buss harness distributes power, slug release signals and provides communications links. Made from flat ribbon cable, it is available in 10, 50 and 100 ft lengths and is connectorized at intervals to match your zone length (18 to 60 inches in 6 inch increments).

It's So Easy to Get Started, All That's Needed Is:

- Your conveyor zone length(s)
- Preferred ZPA algorithm
- Sensor harness cable lengths:
 - Distance from sensor to power buss harness
 - Distance from sensor to solenoid
- Solenoid valve manufacturer and model number

Note

^① A customer-supplied solenoid/valve is required at each zone to control the conveyor pneumatics. Eaton recommends a solenoid below 1.8 Watts.

Product Selection

Basic and Progressive Logic Sensors

Basic Logic Sensor



Basic Logic Sensors

Logic	Type	Sensing Range	Optimum Range	Field of View	Additional Timing	Operate Mode	Output	Standard Catalog Number
Basic logic	Polarized reflex	10 ft (3m)	0.1 to 8 ft (0.03 to 3.6 m)	3 in (76 mm) diameter at 12 ft (3.6m)	—	Air to drive	NPN	14266RLN17B1
							PNP	14266RLP17B1
						Air to brake	NPN	14266RDN17B1
							PNP	14266RDP17B1
Basic logic with timing	Polarized reflex	10 ft (3m)	0.1 to 8 ft (0.03 to 3.6 m)	3 in (76 mm) diameter at 12 ft (3.6m)	Compression timer	Air to drive	NPN	14266RLNT17B1
							PNP	14266RLPT17B1
						Air to brake	NPN	14266RDNT17B1
					PNP		14266RDPT17B1	
					Gap timer ①	Air to drive	PNP	14266RLPC17B1
						Air to brake ①	PNP	14266RDPC17B1

Progressive Logic Sensor



Progressive Logic Sensors

Logic	Type	Sensing Range	Optimum Range	Field of View	Additional Timing	Operate Mode	Output	Standard Catalog Number
Progressive logic	Polarized reflex	10 ft (3m)	0.1 to 8 ft (0.03 to 3.6 m)	3 in (76 mm) diameter at 12 ft (3.6m)	—	Air to drive	NPN	14286RLN17B1
							PNP	14286RLP17B1
						Air to brake	NPN	14286RDN17B1
							PNP	14286RDP17B1
Progressive logic with timing	Polarized reflex	10 ft (3m)	0.1 to 8 ft (0.03 to 3.6 m)	3 in (76 mm) diameter at 12 ft (3.6m)	Compression timer	Air to drive	NPN	14286RLNT17B1
							PNP	14286RLPT17B1
						Air to brake	PNP	14286RDPT17B1
					Gap timer		Air to drive	PNP
						Air to brake	PNP	14286RDPC17B1

Sensor Harness



Sensor Harnesses

Solenoid Connector ^②	Sensor to Buss Harness Length	Sensor to Solenoid Length	Used with Sensors	Catalog Number
3-pin AMP P/N 104257-2	12 in	12 in	14266_/14286_	QD266A12-1201B1
				QD266A12-1204B1
3-pin SMC P/N AXT661-12A	24 in	24 in		QD266A24-2404B1
	36 in	36 in		QD266A36-3604B1

Notes

- ① Models only available in PNP versions. To implement this timing functionality and retain access to slug release mode, all sensors in a given ZPA chain must be PNP output versions.
- ② If you require a solenoid connector other than those listed in this section, contact Eaton's Sensor Applications Department at 1-800-426-9184 with the valve manufacturer's name and model number.

10 ft Versions



Buss Harnesses

50 and 100 ft Versions



Zone Length	Nominal Length	Number of Zones	Used with Sensors	Catalog Number
18 in	10 ft (1.8m)	6 zones	14266_ /14286_	BUS266A18-6
	50 ft (3.6m)	33 zones		BUS266A18-33
	100 ft (6.1m)	66 zones		BUS266A18-66
24 in	10 ft (1.8m)	5 zones		BUS266A24-5
	50 ft (3.6m)	25 zones		BUS266A24-25
	100 ft (6.1m)	50 zones		BUS266A24-50
30 in	10 ft (1.8m)	4 zones		BUS266A30-4
	50 ft (3.6m)	20 zones		BUS266A30-20
	100 ft (6.1m)	40 zones		BUS266A30-40
36 in	10 ft (1.8m)	3 zones		BUS266A36-3
	50 ft (3.6m)	16 zones		BUS266A36-16
	100 ft (6.1m)	33 zones		BUS266A36-33
40 in	10 ft (1.8m)	3 zones		BUS266A40-3
	50 ft (3.6m)	15 zones		BUS266A40-15
	100 ft (6.1m)	30 zones		BUS266A40-30
42 in	10 ft (1.8m)	2 zones		BUS266A42-2
	50 ft (3.6m)	14 zones		BUS266A42-14
	100 ft (6.1m)	28 zones		BUS266A42-28
48 in	10 ft (1.8m)	2 zones		BUS266A48-2
	50 ft (3.6m)	12 zones		BUS266A48-12
	100 ft (6.1m)	25 zones		BUS266A48-25
54 in	10 ft (1.8m)	2 zones		BUS266A54-2
	50 ft (3.6m)	11 zones		BUS266A54-11
	100 ft (6.1m)	22 zones		BUS266A54-22
60 in	10 ft (1.8m)	2 zones		BUS266A60-10
	50 ft (3.6m)	10 zones		BUS266A60-2
	100 ft (6.1m)	20 zones		BUS266A60-20

Standard Sensors

The standard sensors in this section are similar to the embedded logic sensors in the previous sections except that the units do not contain on-board ZPA logic, the sensors directly actuate the solenoid valves to which they are connected.

Standard Sensor**Standard Sensors**

Type	Sensing Range	Optimum Range	Field of View	Connection Type	Operate Mode	Output	Standard Catalog Number
Polarized reflex	10 ft (3m)	0.1 to 8 ft (0.03 to 3.6 m)	3 in (76 mm) diameter at 12 ft (3.6m)	Multi-drop	Air to drive	NPN	14256RLN17B1
						PNP	14256RLP17B1
					Air to brake	NPN	14256RDN17B1
						PNP	14256RDP17B1
					Air to drive	Dual NPN and PNP	14256RL17B1
							14256RD17B1

Sensor Harness**Sensor Harnesses**

Solenoid Connector ^①	Sensor to Buss Harness Length	Sensor to Solenoid Length	Used with Sensors	Catalog Number
3-pin AMP P/N 104257-2	12 in	12 in	14256_	QD256A12-1201B1
3-pin SMC P/N AXT661-12A				QD256A12-1204B1

Buss Harness**Buss Harnesses**

Zone Length	Nominal Length	Number of Zones	Used with Sensors	Catalog Number
18 in	50 ft (3.6m)	33 zones	14266_/14286_	BUS256A18-33
	100 ft (6.1m)	66 zones		BUS256A18-66
24 in	50 ft (3.6m)	25 zones		BUS256A24-25
	100 ft (6.1m)	50 zones		BUS256A24-50
30 in	50 ft (3.6m)	20 zones		BUS256A30-20
	100 ft (6.1m)	40 zones		BUS256A30-40
36 in	50 ft (3.6m)	16 zones		BUS256A36-16
	100 ft (6.1m)	33 zones		BUS256A36-33
40 in	50 ft (3.6m)	15 zones		BUS256A40-15
	100 ft (6.1m)	30 zones		BUS256A40-30
42 in	50 ft (3.6m)	14 zones		BUS256A42-14
	100 ft (6.1m)	28 zones		BUS256A42-28
48 in	50 ft (3.6m)	12 zones		BUS256A48-12
	100 ft (6.1m)	25 zones		BUS256A48-25
54 in	50 ft (3.6m)	11 zones		BUS256A54-11
	100 ft (6.1m)	22 zones		BUS256A54-22
60 in	50 ft (3.6m)	10 zones		BUS256A60-10
	100 ft (6.1m)	20 zones		BUS256A60-20









Note

^① If you require a solenoid connector other than those listed in this section, contact Eaton's Sensor Applications Department at 1-800-426-9184 with the valve manufacturer's name and model number.

Accessories

Basic and Progressive Logic Sensors

Cables, Zone Jumpers and Power Supplies







	Description	Length	Notes	Catalog Number
 <p>Singulate Release Cable</p>	<p>Singulate Release Cable</p> <p>This cable is connected to the last zone and allows singulate or slug discharge control from an external system.</p>	2m	Release only	BUS266REL-01B1
				Both release and power connections are provided. If the power connection is used, a power supply cable is not needed
 <p>Zone Jumper</p>	<p>Zone Jumper</p> <p>A zone jumper is required when a zone is skipped to allow communications to continue through the unused zone.</p>	5 in	—	QDJU266A-01B1
 <p>Power Supply</p>	<p>Power Supply</p> <p>A 100W power supply designed for use with the 200 Series system. On systems with zone lengths up to 48 in, it will power up to 110 sensors with 0.67W solenoids (74 if the solenoids are 1.2W; 38 if the solenoids are 2.4W).</p>	—	—	PS256A-01B1 ①
				PS256A-04B1 ①
 <p>Power Supply Cable</p>	<p>Power Supply Cable</p> <p>This cable allows the power supply to be connected to any zone, while allowing use of that zone. For best results, the power supply cable should be connected at the center of the zones being powered.</p>	2m	—	BUS266PWR-01B1
		50 ft	—	BUS266PWR-5001B1
 <p>BUS266LINK-01B1</p>	<p>Buss Link Cable</p> <p>This cable allows two sections of buss harness to be connected together. NOTE: 10 ft versions of buss harness have this connector built-in.</p>	10 cm	Passes power and ZPA signals	BUS266LINK-01B1
 <p>BUS266ISO-01B1</p>		10 cm	Power isolation version. Passes ZPA signals but isolates power. This allows for connection of more than one power supply to a long section of ZPA conveyor.	BUS266ISO-01B1
 <p>BUS266JUMP15</p>	<p>This cable allows two sections of buss harness to be connected together. DC power is passed through the connection.</p>	3m	Passes power only	BUS266JUMP15-01B1
				<p>This cable allows two sections of buss harness to be connected together. Both DC power and the ZPA signal is passed through the connection.</p>
 <p>Power Curve Module</p>	<p>Power Curve Module</p> <p>Allows ZPA through a powered curve that is not divided into ZPA controlled zones. All required wiring is included.</p>	—	Install adjacent to the 200 Series sensor at the powered curve infeed. All required wiring included.	1451BSR1216

Note

① See Page V8-T6-28 for more details.

Standard Sensors

Cables

	Description	Length	Notes	Catalog Number
BUS256PWR-01B1	Power Supply Cable This cable allows the power supply to be connected to any zone, while allowing use of that zone. For best results, the power supply cable should be connected at the center of the zones being powered.	2m	Round cable	BUS256PWR-01B1
				
BUS256PWR20-02B1		6.7m	Round cable, 18 AWG conductors	BUS256PWR20-02B1
				
BUS256PWR120		3.3m	Flat ribbon cable	BUS256PWR120
				
BUS266LINK-01B1	Buss Link Cable This cable allows two sections of buss harness to be connected together.	10 cm	Passes power only	BUS266LINK-01B1
				
BUS266ISO-01B1		10 cm	Power isolation version. Passes ZPA signals but isolates power. This allows for connection of more than one power supply to a long section of ZPA conveyor.	BUS266ISO-01B1
				
BUSJUMP36		54 in	Flat ribbon cable—passes power only	BUSJUMP36
				

Note

① See **Page V8-T6-28** for more details.

Technical Data and Specifications

Basic and Progressive Logic Sensors

14266 and 14286 Models

Description	Specification
Input voltage	18 to 30 Vdc, reverse polarity protected
Power dissipation	250 mW maximum
Output type	NPN or PNP
Current switching capacity	100 mA maximum
OFF-state leakage	10 mA maximum
ON-state voltage drop	2.5V at 100 mA
Slug input	NPN: Integral diode isolates slug input; input is protected against mis-wiring and is active from "0" to a voltage level equal to the current "input voltage" minus 6 volts PNP: Integral diode isolates slug input; input is protected against mis-wiring and is active from 1–30 Vdc
Response time	8 ms
Connector	5-pin, works with mating plug AMP #104257-4; 2-pin, works with mating plug AMP #104257-1
Temperature range	Operating: –25° to 55°C (–13° to 131°F) Storage: –25° to 70°C (–13° to 158°F)
Material of construction	Lens: Polycarbonate; body: Cycoloy and Lexan; connector: glass-filled PCT
Vibration and shock	Vibration: 30g over 10 Hz to 2 kHz; shock: 30g for 10 ms 1/2 sinewave pulse
Enclosure ratings	NEMA 1
Cable-pull strength	20 pounds (static)
Short-circuit protection	The output is protected against dead shorts only. Operation: Output is continuously retried at 3 ms intervals and will automatically reset when short is removed (no visual indication of a short-circuit condition). ①
Indicator LED	Lights steady when output is ON; OFF when output is OFF; OFF when output is in short-circuit mode

Standard Sensors

14256 Models

Description	Specification
Input voltage	10 to 30 Vdc, reverse polarity protected
Power dissipation	120 mW maximum
Output type	NPN only or NPN and PNP dual output
Output operation—air to brake	ON when beam is blocked; OFF when beam is not blocked
Output operation—air to drive	ON when beam is not blocked; OFF when beam is blocked
Current switching capacity	100 mA maximum
OFF-state leakage	10 mA maximum
ON-state voltage drop	2.5V at 100 mA
Slug Input	Integral diode isolates slug input; input is protected against mis-wiring and is active from "0" to a voltage level equal to the current "input voltage" minus 6 volts
Response time	8 mS
Connector	Works with mating plug; AMP #104257-4
Temperature range	Operating: –25° to 55°C (–13° to 131°F) Storage: –25° to 70°C (–13° to 158°F)
Material of construction	Lens: Polycarbonate; body: Cycoloy and Lexan; connector: glass-filled PCT
Vibration and shock	Vibration: 30g over 10 Hz to 2 kHz; shock: 30g for 10 ms 1/2 sinewave pulse
Enclosure ratings	NEMA 1
Cable-pull strength	20 pounds (static)
Short-circuit protection	The output is protected against dead shorts on the NPN output only. Operation: output is continuously retried at 3 ms intervals and will automatically reset when short is removed (no visual indication of a short-circuit condition). ①
Indicator LED	Lights steady when output is ON; OFF when output is OFF; OFF when output is in short-circuit mode

Note

① **CAUTION:** Will not protect against overloads between 100–300 mA.

Optical Performance

Basic, Progressive Logic and Standard Sensors

All optical specifications are guaranteed to be the minimum performance under clean conditions of any product delivered from stock. Typical performance may be higher.

Dirt in the environment will affect optical performance by reducing the amount of light the control receives. For best results, sensors should be

used at distances where excess gain is higher than 1.5 (1.5 times the amount of sensing power required to detect an object under ideal conditions). Higher excess gain will allow the sensor to overcome higher levels of contamination on the lens. All ranges and excess gain graphs are based on a 3 in retroreflector.

Basic, Progressive Logic and Standard Sensors

Description	Specification
Source	Visible red, 680 nm
Maximum range	10 ft
Optimum rang	0.1 to 8 ft
Field of view	3 in dia. at 12 ft

Excessive Gain

Basic, Progressive Logic and Standard Sensors

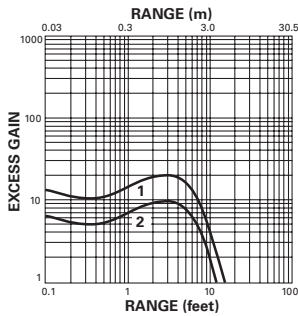

Performance measured to 3 in retroreflector.

1. Typical performance
2. Minimum performance

Wiring Diagrams

Basic and Progressive Logic Sensors

Sensors

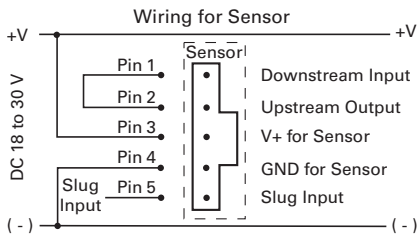

Solenoid Wiring

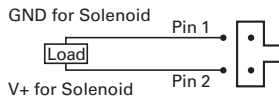

Typical Wiring Example—Nominal 10 ft Buss Harness Lengths

Example shows Power Buss Harness (BUS266A48-2) mounted to a conveyor with 4 ft zones / 8 ft bed sections.

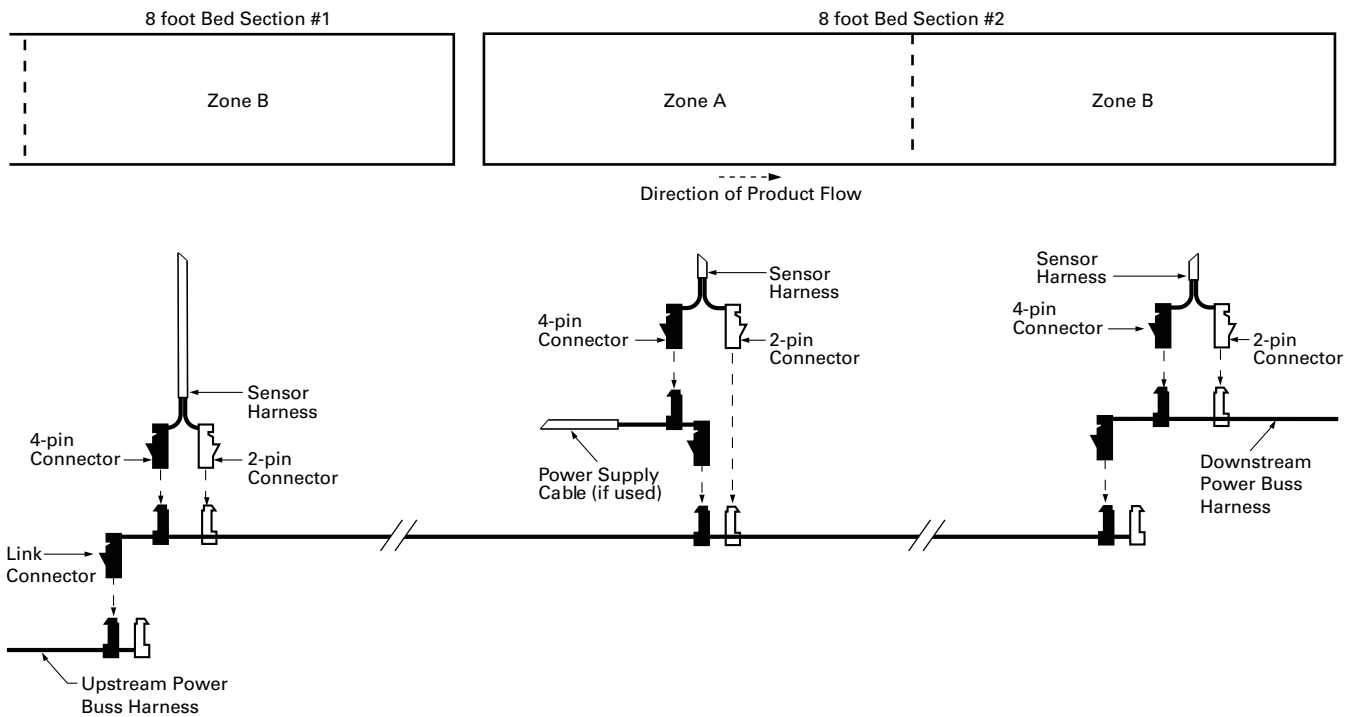

Typical Wiring Example—Nominal 50 ft and 100 ft Buss Harness Lengths

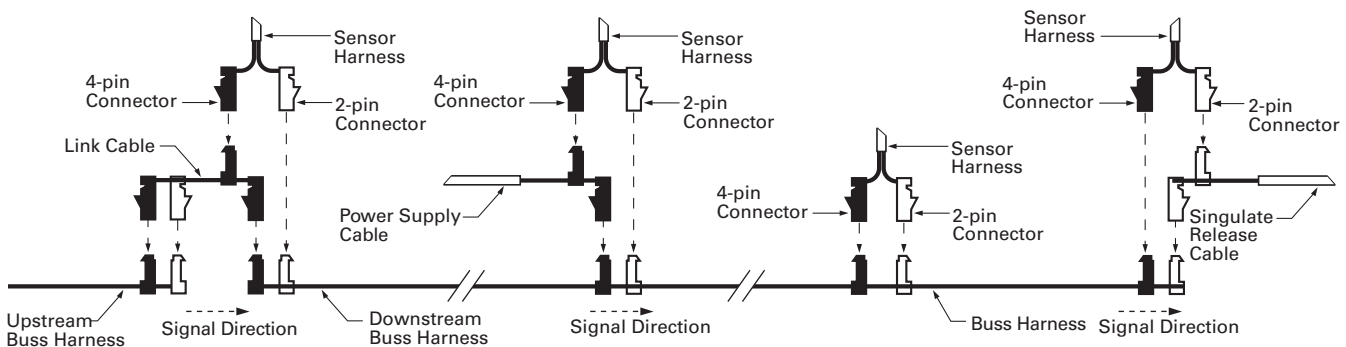

Standard Sensors

Sensors

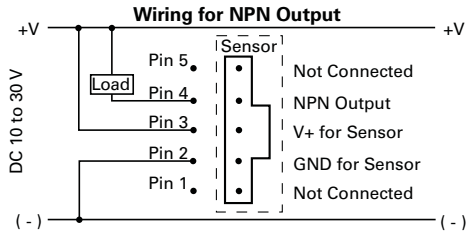
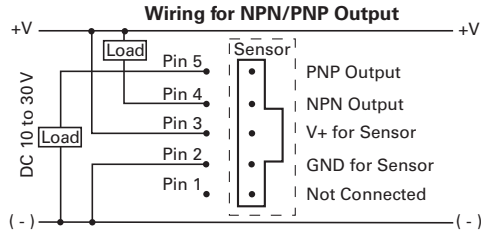
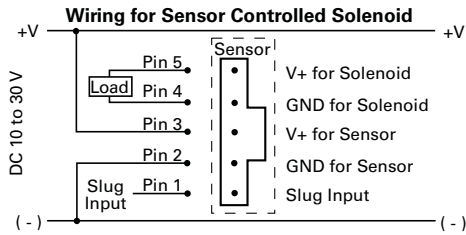

Typical Wiring Example

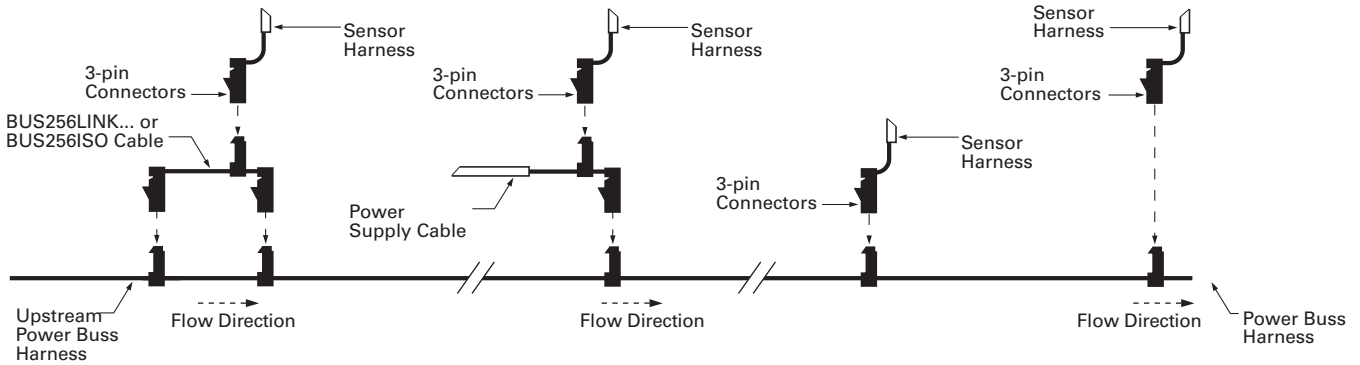

Dimensions

Approximate Dimensions in Inches (mm)

Basic and Progressive Logic Sensors

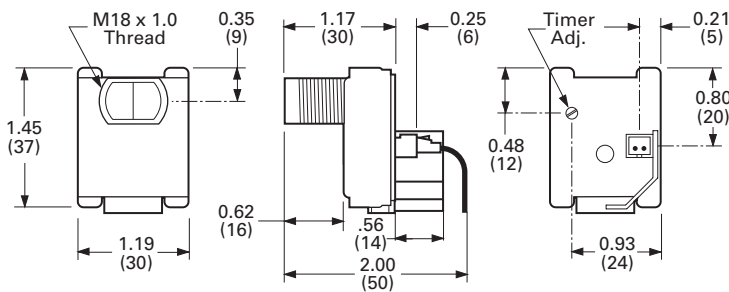

Standard Sensors

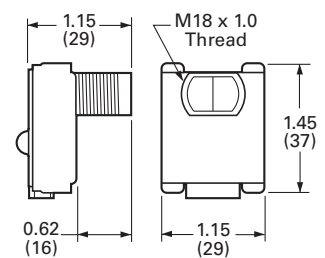

Sensor Power Supply—NEMA 4 Universal Voltage



Contents

<i>Description</i>	<i>Page</i>
Sensor Power Supply—NEMA 4 Universal Voltage	
Product Selection	V8-T6-26
Technical Data and Specifications	V8-T6-26
Wiring Diagrams	V8-T6-27
Dimensions	V8-T6-27

Sensor Power Supply—NEMA 4 Universal Voltage

Product Description

The Sensor Power Supply by Eaton's electrical sector was specially designed to be used with the 200 Series and E68 Series Zero Pressure Accumulation Systems, but is also suitable for use in a wide variety of general material handling applications. The unit delivers 100W output at 27 Vdc and supports easy, Class II wiring. The power supply is a tamper-proof, rugged component easily mounted to a conveyor side-channel or support. Internal components are fully protected in a sealed metal housing to stand up to rugged application, ensuring flawless performance in any material handling environment.

Features

- Integrated AC junction box features for one-step mounting and wiring without the need for additional accessories or enclosures
- Built-in DC power health contact allows easy monitoring of power supply status
- Unique design features a tamper-proof sealed construction to reduce the risk of damage associated with conventional open control-panel type supplies
- Built-in slug-release input converts an AC or DC input to the appropriate DC signal for integration with the 200 Series and E68 Series Zero Pressure Accumulation Systems
- Dual output connection terminals to make it easy and convenient to locate the power supply at the center of the cable run

Standards and Certifications

- cULus Class 2



⚠ DANGER

THIS SENSOR IS NOT A SAFETY DEVICE AND IS NOT INTENDED TO BE USED AS A SAFETY DEVICE. This sensor is designed only to detect and read certain data in an electronic manner and perform no use apart from that, specifically no safety-related use. This sensor product does not include self-checking redundant circuitry, and the failure of this sensor product could cause either an energized or de-energized output condition, which could result in death, serious bodily injury, or property damage.

For the most current information on this product, visit our Web site: www.eaton.com

For Customer Service in the U.S. call 1-877-ETN CARE (386-2273), in Canada call 1-800-268-3578. For Application Assistance in the U.S. and Canada call 1-800-426-9184.

Product Selection

NEMA 4
Universal Voltage

Sensor Power Supply—NEMA 4 Universal Voltage

Operating Voltage	Output	Slug Input	Type	Slug Output	Catalog Number
100–250 Vac	27 Vdc, 100W; short circuit, overload and overvoltage protection (cycle power to reset)	15–132 Vac/dc 3 mA minimum	Standard For use with 200 series and E68 systems	Sinking or sourcing, switch selectable; 80 mA maximum; short circuit protection for loads less than 32 Vac or Vdc (auto reset)	PS256B-01B1
			High current slug For use with solenoid valve systems requiring full current slug signals 4-pin DC M12 output connector	Sinking only; 100W output; short circuit, overload and overvoltage protection (cycle power to reset) ^①	PS256B-05B1

6

Technical Data and Specifications

Sensor Power Supply—NEMA 4 Universal Voltage

Description	PS256B-01B1	PS256B-05B1
Input power	115W, maximum inrush 30A from cold start	115W, maximum inrush 30A from cold start
Input voltage	100–250 Vac	100–250 Vac
Input current (full load)	115 Vac: 2A; 230 Vac: 4A	115 Vac: 2A; 230 Vac: 4A
Output power	100W	100W
Output voltage	27 Vdc	27 Vdc
Output protection	Short circuit, overload and overvoltage protection (auto-reset)	Short circuit, overload and overvoltage protection (auto-reset)
Regulation	±3%	±3%
Slug input	15–132 Vac/dc	15–132 Vac/dc
Slug output	Sinking or sourcing, switch selectable; 80 mA maximum; short circuit protection for loads less than 32 Vac or Vdc (auto reset)	Sinking only; 100W output; short circuit, overload and overvoltage protection (cycle power to reset) ^①
Indicators	Red LED: AC in; green LED: DC out	Red LED: AC in; green LED: DC out
DC power monitor output	NO contact, solid-state relay, 80 mA maximum	NO contact, solid-state relay, 80 mA maximum
Temperature range	–13° to 131°F (–25° to 55°C)	–13° to 131°F (–25° to 55°C)
Vibration	IEC 68-2-6 Test FC 10g	IEC 68-2-6 Test FC 10g
Enclosure material	Aluminum	Aluminum
Enclosure rating	NEMA 4X	NEMA 4X
Connections		
DC	Main output/slug output: One 6-position plug-in style connector ^②	Main output/slug output: One 6-position plug-in style connector ^②
AC	AC line input, DC fail indication and slug input: One 7-position plug-in style connector ^③	AC line input, DC fail indication and slug input: One 7-position plug-in style connector ^③

Notes

- ^① Total output power of supply is 100W. Total supply output power (100W) = main output power + slug output power.
- ^② On model PS256B-05B1, a single 12 mm DC key micro-connector is mounted to the outside of the enclosure and pre-wired to the internal connector (see above).
- ^③ On model PS256B-02B1, DC fail indication and slug input terminals are not active.

Wiring Diagrams

Models Ending 01B1, 04B1, 05B1

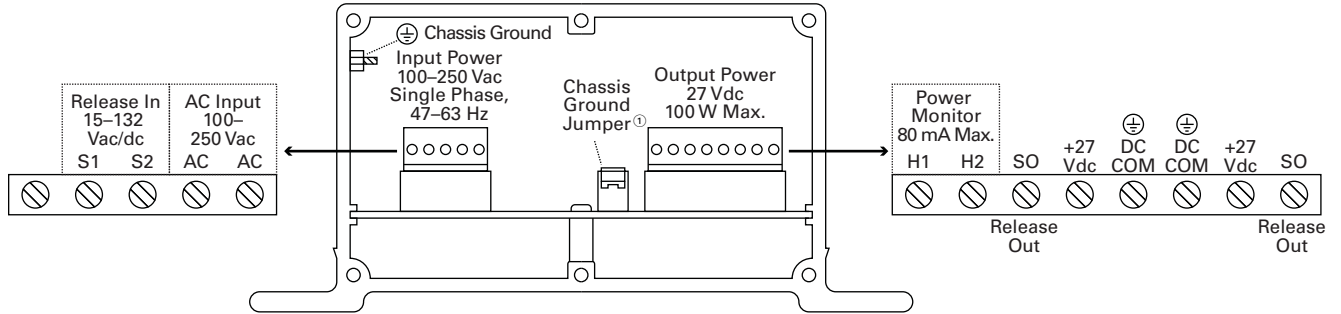

Models Ending 02B1

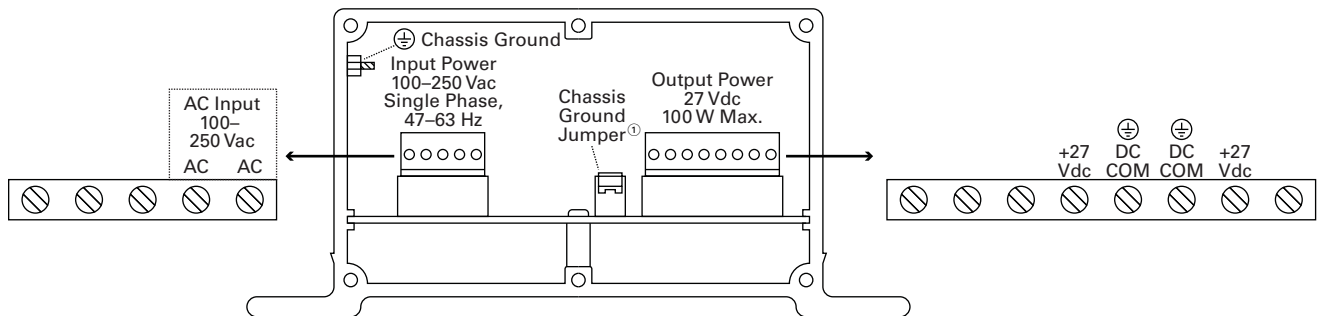

Dimensions

Approximate Dimensions in Inches (mm)

NEMA 4 Universal Voltage

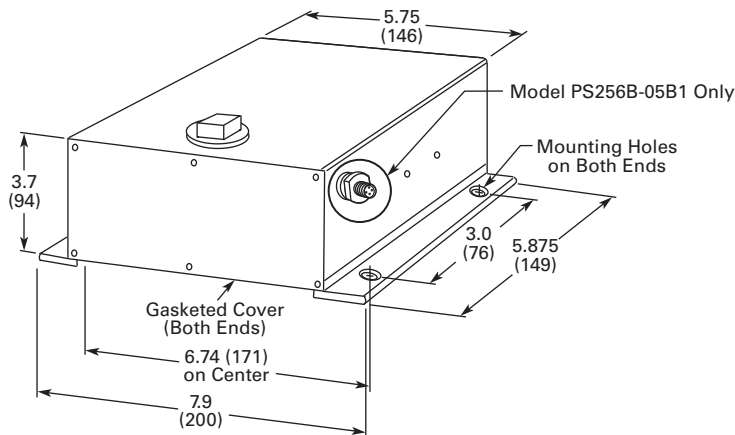

Note

① Install jumper for single power supply systems. In systems where multiple power supplies are connected to a DC bus, install the jumper in only one supply.

Sensor Power Supply—NEMA 1, 120 Vac



6

Sensor Power Supply—NEMA 1, 120 Vac

Product Description

The Sensor Power Supply by Eaton's electrical sector was specially designed to be used with the 200 Series and E68 Series Zero Pressure Accumulation Systems, but is also suitable for use in a wide variety of general material handling applications. The unit delivers 100W output at 27 Vdc and supports easy, Class II wiring. The power supply is a tamper-proof, rugged component easily mounted to a conveyor side-channel or support. Internal components are fully encapsulated in a strong die-cast housing to stand up to rugged handling, ensuring flawless performance in any material handling environment.

Features

- Integrated AC junction box for one-step mounting and wiring without the need for additional accessories
- Built-in DC power health contact allows easy monitoring of power supply status
- Unitized design features a tamper-proof encapsulated construction to reduce the risk of damage associated with conventional open control-panel type construction
- Built-in slug-release input converts an AC or DC input to the appropriate DC signal for integration with the 200 Series and E68 Series Zero Pressure Accumulation Systems
- Dual output connection terminals to make it easy and convenient to locate the power supply at the center of the cable run

Contents

Description

Description	Page
Sensor Power Supply—NEMA 1, 120 Vac	
Product Selection	V8-T6-29
Technical Data and Specifications	V8-T6-29
Wiring Diagram	V8-T6-30
Dimensions	V8-T6-30

Standards and Certifications

- UL Listed
- cUL Approved



⚠ DANGER

THIS SENSOR IS NOT A SAFETY DEVICE AND IS NOT INTENDED TO BE USED AS A SAFETY DEVICE. This sensor is designed only to detect and read certain data in an electronic manner and perform no use apart from that, specifically no safety-related use. This sensor product does not include self-checking redundant circuitry, and the failure of this sensor product could cause either an energized or de-energized output condition, which could result in death, serious bodily injury, or property damage.

For the most current information on this product, visit our Web site: www.eaton.com

For Customer Service in the U.S. call 1-877-ETN CARE (386-2273), in Canada call 1-800-268-3578. For Application Assistance in the U.S. and Canada call 1-800-426-9184.

Product Selection

NEMA 1, 120 Vac



Sensor Power Supply—NEMA 1, 120 Vac

Operating Voltage	Output	Slug Input	Type	Slug Output	Catalog Number
105–132 Vac	27 Vdc, 100W; short circuit, overload and overvoltage protection (cycle power to reset)	15–132 Vac/dc 3 mA minimum	Standard For use with 200 series and E68 systems	Sinking or sourcing, switch selectable; 80 mA maximum; short circuit protection for loads less than 32 Vac or Vdc (auto reset)	PS256A-01B1
			High current slug For use with solenoid valve systems requiring full current slug signals	Sinking only; 100W output; short circuit, overload and overvoltage protection (cycle power to reset) ^①	PS256A-04B1

Technical Data and Specifications

Sensor Power Supply—NEMA 1, 120 Vac

Description	PS256A-01B1	PS256A-04B1
Input power	144W, maximum inrush 30A from cold start	144W, maximum inrush 30A from cold start
Input voltage	105–132 Vac	105–132 Vac
Input current (full load)	105 Vac: 1.92A; 115 Vac: 1.65A; 132 Vac: 1.5A	105 Vac: 1.92A; 115 Vac: 1.65A; 132 Vac: 1.5A
Output power	100W	100W
Output voltage	27 Vdc	27 Vdc
Output protection	Short circuit, overload and overvoltage protection (cycle power to reset), diode protected	Short circuit, overload and overvoltage protection (cycle power to reset), diode protected
Regulation	±3%	±3%
Slug input	15–132 Vac/dc	15–132 Vac/dc
Slug output	Sinking or sourcing, switch selectable; 80 mA maximum; short circuit protection for loads less than 32 Vac or Vdc (auto reset)	Sinking only; 100W output; short circuit, overload and overvoltage protection (cycle power to reset) ^①
Indicators	Red LED: AC in; green LED: DC out	Red LED: AC in; green LED: DC out
DC fail indication output	NO contact, solid-state relay, 80 mA maximum	NO contact, solid-state relay, 80 mA maximum
Temperature range	–13° to 131°F (–25° to 55°C)	–13° to 131°F (–25° to 55°C)
Vibration	20g	20g
Enclosure material	Die-cast aluminum	Die-cast aluminum
Enclosure rating	NEMA 1	NEMA 1
Connections	Main output/slug output: Two 3-position finger protected barrier strips; AC line input, DC fail indication and slug input: 8-position screw terminal strip inside conduit entry box	Main output/slug output: Two 3-position finger protected barrier strips; AC line input, DC fail indication and slug input: 8-position screw terminal strip inside conduit entry box

Note

^① Total output power of supply is 100W. Total supply output power (100W) = main output power + slug output power.

Wiring Diagram

Pin numbers are for reference, rely on pin location when wiring.

Sensor Power Supply—NEMA 1, 120 Vac

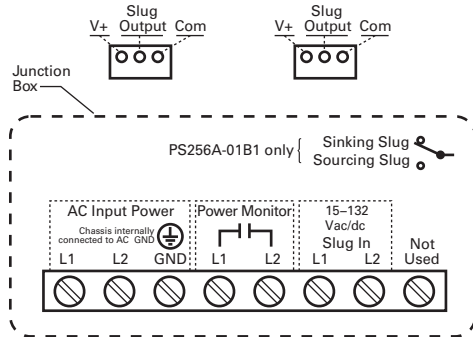

6

Dimensions

Approximate Dimensions in Inches (mm)

Sensor Power Supply—NEMA 1, 120 Vac

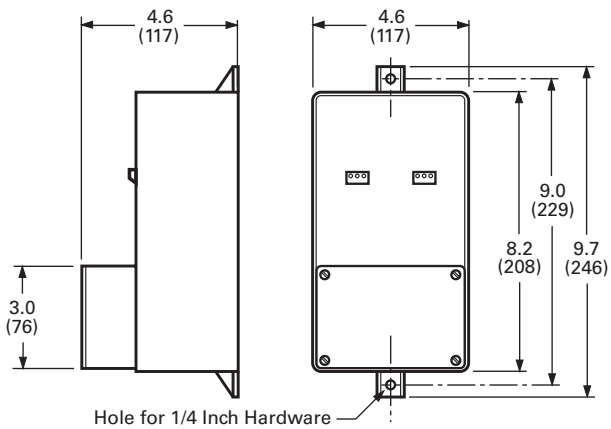

EVT Series VoltageWatch



ECSJ Series CurrentWatch Current Switch



EACR Series CurrentWatch Current Sensor



7.0	Introduction	
	Product Selection Guide	V8-T7-2
7.1	EVT Series VoltageWatch Voltage Sensors	
	Product Description	V8-T7-5
	Product Selection	V8-T7-6
7.2	ECS Series CurrentWatch Current Switches	
	Product Description	V8-T7-8
	Product Selection	V8-T7-9
7.3	ECSJ Series CurrentWatch Current Switches	
	Product Description	V8-T7-11
	Product Selection	V8-T7-12
7.4	ECS7 Series CurrentWatch Current Switches	
	Product Description	V8-T7-15
	Product Selection	V8-T7-16
7.5	ECSTD Series CurrentWatch Current Switches	
	Product Description	V8-T7-19
	Product Selection	V8-T7-20
7.6	ECSD Series CurrentWatch Current Switches	
	Product Description	V8-T7-23
	Product Selection	V8-T7-24
7.7	EAC Series CurrentWatch Current Sensors	
	Product Description	V8-T7-26
	Product Selection	V8-T7-27
7.8	EACR Series CurrentWatch Current Sensors	
	Product Description	V8-T7-30
	Product Selection	V8-T7-31
7.9	EDC Series CurrentWatch Current Sensors	
	Product Description	V8-T7-33
	Product Selection	V8-T7-34
7.10	EGF Series CurrentWatch Current Sensors	
	Product Description	V8-T7-37
	Product Selection	V8-T7-38
7.11	EGFL Series CurrentWatch Current Sensors	
	Product Description	V8-T7-42
	Product Selection	V8-T7-43



Unless otherwise noted, the products contained in this section should not be used for functional safety applications. These products were not designed or tested to IEC 60947-5-3 or recommended for functional safety.

For Customer Service in the U.S. call 1-877-ETN CARE (386-2273),
in Canada call 1-800-268-3578.

For Application Assistance in the U.S. and Canada
call 1-800-426-9184.

Product Selection Guide

EVT Series VoltageWatch Voltage Sensors



Page V8-T7-5

Overview

Eaton's VoltageWatch™ sensor is a high-performance, true RMS sensor for sensing voltage in single- and three-phase installations.

Applications

Detect below normal or “brown out” voltage conditions; protect against possible motor overheating

Identify phase-loss conditions by detecting voltage reduction in one or more phases of a three-phase motor

Monitor overvoltage conditions associated with regenerative voltage to help in diagnosing/avoiding motor drive issues

Detect voltage conditions that may cause stress in or damage to soft starter components (SCRs)

Product Features

True RMS output—allows for use in situations where power supplied is non-sinusoidal

Standard 4–20 mA loop powered output—industry standard output works easily and reliably with existing controllers

Input/output isolation—input and output circuitry is electrically isolated for improved safety

Compact DIN rail mount enclosure—space-saving 35 mm wide enclosure mounts quickly for an attractive installation

Voltage Range

120, 240, 480V

Approvals

UL®
CE (Pending)
RoHS Compliant



ECS Series CurrentWatch AC Current Switches



Page V8-T7-8

Overview

AC current switches for detecting overcurrent condition.

Applications

Electronic proof of flow—current operated switches eliminate the need for multiple pipe or duct penetrations and are more reliable than electro-mechanical pressure or flow switches

Conveyors—detect jams and overloads

Lighting circuits—easier to install and more accurate than photocells

Fans, pumps and heating elements—faster response than temperature sensors

Critical motors

Ancillary equipment

Product Features

Universal outputs—NO or NC solid-state switch for control circuits up to 240 Vac/dc, compatible with most automation systems

Self-powered—cuts installation and operating costs

Easily adjustable setpoint—increases application flexibility and speeds start-up

Solid- or split-core housings—versions tailored for each type of installation

LED indication—provides quick visual indication of contact status

Built-in mounting feet—simple, two-screw panel mount or attach with optional din-rail mounting kit accessory

Current Range

Fixed or adjustable set point, 1–150A

Approvals

UL Listed
cUL® Listed
cULus
CE



ECSJ Series CurrentWatch AC Current Switches



Page V8-T7-11

Overview

Jumper selectable AC switches with solid-state output.

Applications

Electronic proof of flow—current operated switches eliminate the need for multiple pipe or duct penetrations and are more reliable than electro-mechanical pressure or flow switches

Conveyors—detect jams and overloads

Lighting circuits—easier to install and more accurate than photocells

Fans, pumps and heating elements—faster response than temperature sensors

Critical motors

Ancillary equipment

Product Features

Choice of NO or NC solid-state outputs—
1A at 240 Vac
0.15A at 30 Vdc
15A at 120 Vac
3A at 120 Vac
0.15A at 30 Vdc, dual contact

Self-powered—cuts installation and operating costs

Easily adjustable setpoint—speeds start-up and reduces inventory

Solid- or split-core housings—choose the appropriate version for your application

LED indication—provides quick visual indication of output contact status

Built-in mounting feet—provide for a secure installation

Current Range

Adjustable set point, 1.75–200A

Approvals

UL Listed
cUL Listed
cULus
CE



ECS7 Series CurrentWatch AC Current Switches



Page V8-T7-15

Overview

Self-calibrating AC current switch with solid-state outputs.

Applications

Conveyors—use current overload models to detect conveyor jams caused by scenarios such as side-by-sides

Electronic proof of flow—more reliable than electro-mechanical pressure or flow switches, with no need for pipe or duct penetrations

Pump protection—provides overload (jams) and underload (suction loss) indication

Product Features

Self-powered and self-calibrating—reduces installation costs

Status monitoring, overload and operating window options—choose the operating style that matches your application

Universal output—AC or DC compatibility with any automation system

Current Range

Self-calibrating set point, 1.5–150A

Approvals

UL Listed
cUL Listed
cULus
CE



ECSTD Series CurrentWatch AC Current Switches



Page V8-T7-19

Overview

AC current switches with time delay.

Applications

Motor protection—serves as an electronic proof-of-operation; detects current draw changes in motors when they encounter problems such as pumps running dry or pending bearing failure; non-intrusive and less expensive to install than differential pressure flow sensors or thermal switches

High inrush or temporary overload current—adjustable start-up/delay timer allows 0–15 second delay to eliminate nuisance trips from high inrush or short overload conditions

Product Features

Adjustable start-up/delay timer—field adjustable from 0–15 seconds to eliminate nuisance alarms due to start-up inrush or temporary overcurrent conditions

Choice of NO/NC AC or universal outputs—contact ratings of 1.0A at 240 Vac or universal outputs of 0.15A at 240 Vac/dc (NO models) and 0.2A at 135 Vac/dc (NC models) for use with most standard motor control systems

Improved ease of installation and use—self-powered, split-core models simplify installation, 1.0A AC rating eliminates need for time delay relay, and status LED provides visual indication of setpoint trip and contact action

Current Range

Adjustable set point, 1.5–200A

Approvals

UL Listed
cUL Listed
CE



(ECSTD401 and 4025C—No approval)

ECSD Series CurrentWatch DC Current Switches



Page V8-T7-23

Overview

DC switch with solid-state or mechanical relay output.

Applications

Electronic proof of flow—current operated switches eliminate the need for multiple pipe or duct penetrations

Welders—Instant indication of equipment status

Large drive motors—provide monitoring for field loss protection

Power supplies—detect and signal over-current condition before equipment damage

UPS—monitors battery output

Ancillary equipment

Product Features

Choice of mechanical relay or solid-state outputs—SPDT (Form C) relay, 5.0A at 240 Vac or 30 Vdc

Solid-state, NO, 0.15A at 240 Vac/dc

Easily adjustable setpoint—speeds start-up and reduces inventory

Compact, one-piece design—easily fits in crowded control panels

Input isolation—safer than shunt/relay combinations

Adaptive hysteresis—hysteresis is five percent of setpoint, allowing closer control than fixed-hysteresis switches

Solid-core housings

Current Range

Varies by model

Approvals

UL Listed
cUL Listed
CE



Listed Listed

EAC Series CurrentWatch AC Current Sensors



Page V8-T7-26

Overview

AC current sensor with analog outputs and power supply options.

Applications

Automation equipment—analog current reading for remote monitoring and software alarms

Data loggers—self-powered sensor helps conserve data logger batteries

Panel meters—simple connection displays power consumption

Product Features

Highly accurate—factory matched and calibrated single-piece sensor is more accurate than traditional two-piece, field-installed solutions

Average responding—“average responding” algorithm gives an RMS output on pure sine waves, perfect for constant speed (linear) loads

Jumper selectable ranges—the ability to change input ranges reduces inventory and eliminates zero and span

Isolation—output is magnetically isolated from the input for safety and elimination of insertion loss (voltage drop)

Current Range

0–200A

Approvals

UL Listed
cUL Listed
cULus (except EACP models)
CE marked (except EACP models)



Listed Listed Listed (EACP models not listed)

EACR Series CurrentWatch RMS Current Sensors



Page V8-T7-30

Overview

True RMS AC current sensing with 4–20 mA output.

Applications

VFD controlled loads—monitoring Vdc output indicates how the motor and attached load are operating

SCR controlled loads—accurate measurement of phase angle fired or burst fired (time proportioned) SCRs, with faster current measurement than temperature sensors

Switching power supplies and electronic ballasts—true RMS sensing is the most accurate way to measure power supply or ballast input power

Product Features

True RMS output—true RMS technology is accurate on distorted waveforms like VFD or SCR outputs

Jumper-selectable ranges—reduces inventory and eliminates zero and span

Isolation—output is magnetically isolated from the input for safety and elimination of insertion loss (voltage drop)

Current Range

0–200A true RMS

Approvals

UL Listed
cUL Listed
cULus
CE



Listed Listed Listed

EDC Series CurrentWatch DC Current Sensors



Page V8-T7-33

Overview

Current sensing for DC loads up to 300A with analog outputs.

Applications

Battery banks—monitors load current, monitors charging current and verifies operation

Transportation—measures traction power or auxiliary loads

Electric heating elements—monitors heater loads with a faster response time than temperature sensors

Product Features

Jumper-selectable ranges—reduces inventory and eliminates zero or span pots

Isolation—output is magnetically isolated from the input for safety, also eliminating insertion loss (voltage drop)

Internal power regulation—cuts installation costs and works well, even with unregulated power

Split core design and built-in mounting brackets—makes installation quick and easy

Current Range

0–400A

Approvals

UL Listed (Pending)
CE



EGF Series CurrentWatch Ground Fault Sensors



Page V8-T7-37

Overview

Ground fault sensors with solid-state or mechanical relay outputs.

Applications

Personnel protection (typically 5 mA)—detects sensitive ground fault conditions, which could cause injury to people, and functions as a sensor and alarm trigger when applied as an input to an overall ground fault protection system

Equipment protection (typically 10 or 30 mA)—for applications where personnel protection is not the primary concern, higher setpoint capability helps eliminate nuisance tripping while still providing adequate ground fault detection to protect machine electronics

Product Features

Broad range of options to meet application needs—NO or NC, solid-state or mechanical relays, normally energized or normally de-energized contacts

Setpoint options maximize ease-of-use and application flexibility—field selectable 5, 10 or 30 mA setpoints on the EGF “Tri-set” models make user adjustments fast, sure and convenient

Compatible with standard equipment—application on single- and three-phases systems, ideal for use with shunt trip breakers, and magnetically isolated from monitored circuit and control power

Current Range

Fixed or adjustable 5/10/30 mA trip

Approvals

UL Recognized
CE



EGFL Series CurrentWatch Ground Fault Sensors

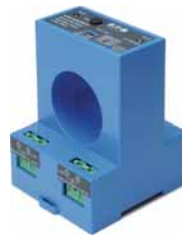

Page V8-T7-42

Overview

Ground fault sensors with mechanical relays.

Applications

Personnel protection (typically 5 mA)—detects sensitive ground fault conditions, which could cause injury to people

Equipment protection (typically 10 or 30 mA)—for applications where personnel protection is not the primary concern, higher setpoint capability helps eliminate nuisance tripping

Regulatory—meets requirements as stipulated by governmental and industrial regulatory groups for ground fault sensing

Product Features

Broad range of options to meet application needs—mechanical relays, normally energized or normally de-energized contacts

Setpoint options maximize ease-of-use and application flexibility—field selectable 5, 10 or 30 mA setpoints on the EGFL “tri-set” models make user adjustments fast, sure and convenient

Compatible with standard equipment—application on single- and three-phase systems, ideal for use with shunt trip breakers, and magnetically isolated from monitored circuit and control power

Current Range

Tri-Set Adjustable, 5, 10 or 30 mA

Approvals

UL Approved
cULus
CE



EVT Series VoltageWatch Voltage Sensors



Contents

Description	Page
EVT Series VoltageWatch Voltage Sensors	
Standards and Certifications	V8-T7-6
Catalog Number Selection	V8-T7-6
Product Selection	V8-T7-6
Technical Data and Specifications	V8-T7-7
Wiring Diagram	V8-T7-7
Dimensions	V8-T7-7

EVT Series VoltageWatch Voltage Sensors

Product Description

Eaton’s VoltageWatch™ sensor is a high-performance, true RMS sensor for sensing voltage in single- and three-phase installations. Applicable on nominal circuits of 120V, 240V and 480V, this voltage sensor provides a fully isolated analog output proportional to rated nominal voltage in both sinusoidal and non-sinusoidal (variable frequency) situations. It is housed in a slim, compact, easy-to-install DIN rail mount enclosure.

Ideal for situations where power quality is of interest or concern, the VoltageWatch sensor facilitates monitoring of supply voltage levels, identifying undervoltage or overvoltage conditions, and helping to protect critical motors and electronics. Designed with an industry-standard 4–20 mA output, VoltageWatch is easily coupled to a data logger, panel meter or PLC to enable basic trending of operational status of low voltage circuits up to real-time monitoring and reporting of supply voltage levels.

Application Description

True RMS Voltage Monitoring

- Detect below normal or “brown out” voltage conditions; protect against possible motor overheating
- Identify phase-loss conditions by detecting voltage reduction in one or more phases of a three-phase motor
- Monitor overvoltage conditions associated with regenerative voltage to help in diagnosing/avoiding motor drive issues
- Detect voltage conditions that may cause stress in or damage to soft starter components (SCRs)

Example Application—Phase Loss

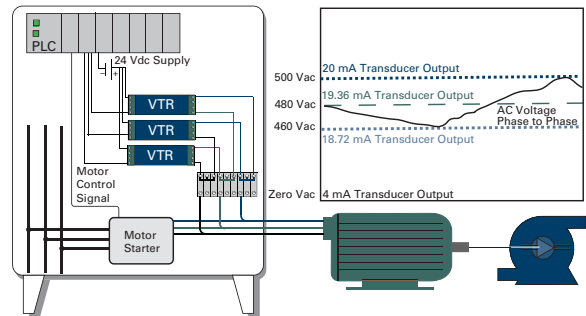

Features

- **True RMS Output**—Allows for use in situations where power supplied is non-sinusoidal, such as VFD applications, poor power quality installations or other electrically harsh/challenging environments
- **Standard 4–20 mA Loop Powered Output**—Industry standard output works easily and reliably with existing controllers, data loggers and SCADA equipment
- **Input/Output Isolation**—Input and output circuitry is electrically isolated for improved safety
- **Compact DIN Rail Mount Enclosure**—Space-saving 35 mm wide enclosure mounts quickly for an attractive installation

For the most current information on this product, visit our Web site: www.eaton.com

For Customer Service in the U.S. call 1-877-ETN CARE (386-2273), in Canada call 1-800-268-3578.

For Application Assistance in the U.S. and Canada call 1-800-426-9184.

Standards and Certifications

- UL
- CE (Pending)
- RoHS Compliant



⚠ DANGER

THIS SENSOR IS NOT A SAFETY DEVICE AND IS NOT INTENDED TO BE USED AS A SAFETY DEVICE. This sensor is designed only to detect and read certain data in an electronic manner and perform no use apart from that, specifically no safety-related use. This sensor product does not include self-checking redundant circuitry, and the failure of this sensor product could cause either an energized or de-energized output condition, which could result in death, serious bodily injury, or property damage.

Catalog Number Selection

VoltageWatch EVT Series—Top Terminal Current Sensors

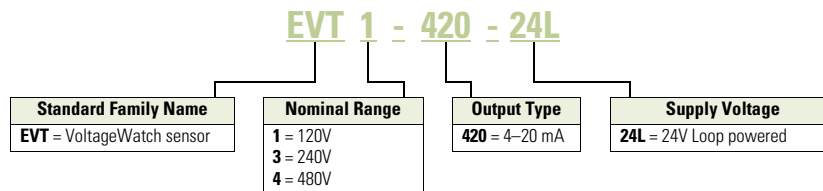

Product Selection

EVT Series



VoltageWatch EVT Series—Top Terminal Current Sensors

Power Supply	Output Signal	Nominal Voltage	Catalog Number
24 Vdc loop powered	4–20 mA	120	EVT1-420-24L
		240	EVT3-420-24L
		480	EVT4-420-24L

Technical Data and Specifications

VoltageWatch EVT Series

Description	Specification
Power supply	24 Vdc loop-powered
Input	120V, 240V, 480V
Input over-range	+15% of nominal range
Output	4–20 mA proportional; capped at 24 mA maximum
Response time	250 ms (to 90% value)
Accuracy	<1%
Linearity	<0.5%
Loading	<500 ohms
Isolation voltage	2500 Vac
Frequency range	40 Hz–5 kHz
Operating temperature	–22° to 140°F (–30° to 60°C)
Mounting	DIN rail compatible
Case	UL 94 V0 flammability rated; noncorrosive thermoplastic
Environmental	14° to 122°F (–10° to 50°C), 0–95% RH noncondensing
EMC/immunity	EN50081-1, EN50082-2
Ripple	<1% (peak to peak)
Listings	UL/cUL and CE pending

Wiring Diagram

VoltageWatch EVT Series

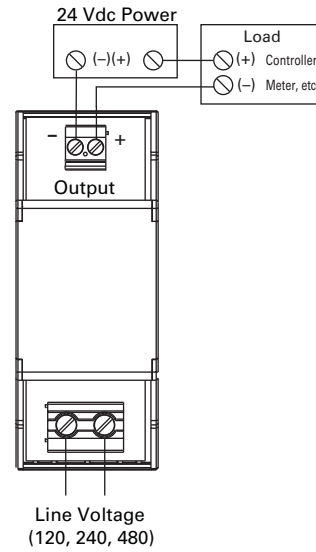

Dimensions

Approximate Dimensions in Inches (mm)

Complete Unit

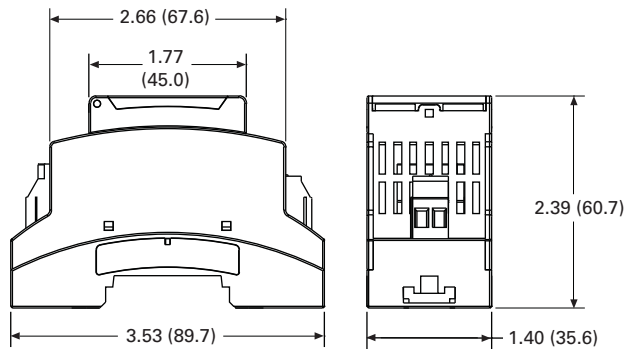

ECS Series CurrentWatch Current Switches



7

ECS Series CurrentWatch Current Switches

Product Description

The CurrentWatch™ ECS Series from Eaton's Electrical Sector is a family of solid-state adjustable current switches, ideal for providing status information on electrical equipment. The ECS is excellent for new installations, where the conductors run through the housing, requiring no cutting. These switches are also ideal for retrofits, since split-core models can be opened to fit around existing conductors. The current switch is accurate, reliable and easy to install.

The ECS can sense continuous currents from 1 to 150A and does not require any supply voltage, as the power required is induced from the monitored conductor. The output is a non-polarity-sensitive solid-state contact for switching AC and DC circuits up to 240 Vac/dc. This switch also includes an LED indicating two states: on and below trip point, and above trip point with contacts energized. All ECS Series switches carry an unconditional five-year warranty.

For the most current information on this product, visit our Web site: www.eaton.com

Any change in current can be sensed with the ECS Series. A change in current may indicate motor failure, belt loss/slippage or mechanical failure. Any of these events can cause the current to drop significantly, tripping the switch and notifying the controller.

Application Description

Typical Applications

- **Electronic Proof of Flow**—Current operated switches eliminate the need for multiple pipe or duct penetrations and are more reliable than electro-mechanical pressure or flow switches
- **Conveyors**—Detect jams and overloads
- **Lighting Circuits**—Easier to install and more accurate than photocells
- **Fans, Pumps and Heating Elements**—Faster response than temperature sensors
- **Critical Motors**
- **Ancillary Equipment**

Contents

Description

	<i>Page</i>
ECS Series CurrentWatch Current Switches	
Standards and Certifications	V8-T7-9
Product Selection	V8-T7-9
Accessories	V8-T7-9
Technical Data and Specifications	V8-T7-10
Wiring Diagram	V8-T7-10
Dimensions	V8-T7-10

Example Application — Pump Jam and Suction Loss Protection

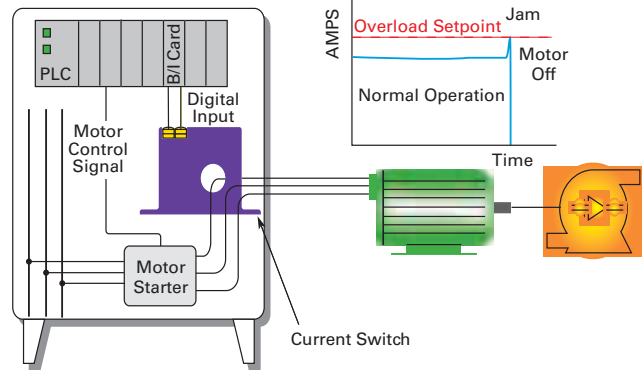

Features

- **Universal Outputs**—NO or NC solid-state switch for control circuits up to 240 Vac/dc, compatible with most automation systems
- **Self-Powered**—Cuts installation and operating costs
- **Easily Adjustable Setpoint**—Increases application flexibility and speeds start-up
- **Solid- or Split-Core Housings**—Versions tailored for each type of installation
- **LED Indication**—Provides quick visual indication of contact status
- **Built-In Mounting Feet**—Simple, two-screw panel mount or attach with optional DIN-rail mounting kit accessory

For Customer Service in the U.S. call 1-877-ETN CARE (386-2273), in Canada call 1-800-268-3578.

For Application Assistance in the U.S. and Canada call 1-800-426-9184.

Standards and Certifications

- UL Listed
- cUL Listed
- CE Certified





⚠ DANGER

THIS SENSOR IS NOT A SAFETY DEVICE AND IS NOT INTENDED TO BE USED AS A SAFETY DEVICE. This sensor is designed only to detect and read certain data in an electronic manner and perform no use apart from that, specifically no safety-related use. This sensor product does not include self-checking redundant circuitry, and the failure of this sensor product could cause either an energized or de-energized output condition, which could result in death, serious bodily injury, or property damage.

Product Selection

ECS Series CurrentWatch Current Switches

Top Terminal Current Switches

	Power Supply	Aperture Size	Output Signal	Setpoint and LED Configuration	Catalog Number			
Solid-Core Housing 	Solid-Core Housing Self powered (no external power needed)	0.74 in (19 mm)	Normally open	Adjustable 1–150A setpoint with LED	ECSNOASC			
				Fixed 1.0A setpoint no LED	ECSNOFSC			
				Fixed 5.5A setpoint no LED	ECSNOFSCY1			
						Normally closed	Adjustable 1–150A setpoint with LED	ECSNCASC
							Fixed 1.0A setpoint no LED	ECSNCFSC
Split-Core Housing 	Split-Core Housing Self powered (no external power needed)	0.85 in (21.6 mm)	Normally open	Adjustable 1.75–150A setpoint with LED	ECSNOASP			
				Fixed 1.5A setpoint no LED	ECSNOFSP			
						Normally closed	Adjustable 1.75–150A setpoint with LED	ECSNCASP
							Fixed 1.5A setpoint no LED	ECSNCFSP

Accessories

DIN Rail Mounting Kit



ECS Series CurrentWatch Current Switches

Description	Catalog Number
DIN rail mounting kit ①	EDINKIT

Note

① Sensor pictured for reference and not included in kit.

Technical Data and Specifications

ECS Series CurrentWatch Current Switches

Description	Specification
Power supply	Self-powered—no power supply needed
Output	Magnetically isolated solid-state switch
Output rating	NO version: 0.15A at 240 Vac/dc NC version: 0.2A at 135 Vac/dc Models ending Y1: 5.0A, 125 Vac, 30 Vdc
Off-state leakage	<10 μ A
Response time	120 ms
Setpoint range	Solid-core housings: 1–150A Split-core housings: 1.75–150A
Hysteresis	5% of setpoint

Description	Specification
Overload	Fixed setpoint, NO models: 6 sec. at 500A; 1 sec. at 1000A All other models: 6 sec. at 400A; 1 sec. at 1000A Maximum continuous Amps: 250A
Isolation voltage	UL listed to 1270 Vac, tested to 5000 Vac
Frequency range	6–100 Hz
Sensing aperture	Solid-core housings: 0.74 in (19 mm) Split-core housings: 0.85 in (21.6 mm)
Housing	UL94 V0 flammability rated
Environmental	Operating temperature: –58° to 122°F (–50° to 50°C) Humidity: 0–95% RH, non-condensing

7

Wiring Diagram

ECS Series CurrentWatch Current Switches

Normally open (NO) models shown

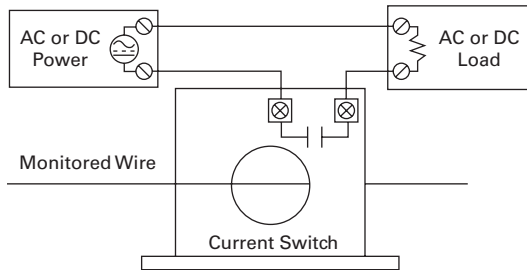

Dimensions

Approximate Dimensions in Inches (mm)

Solid-Core Housing

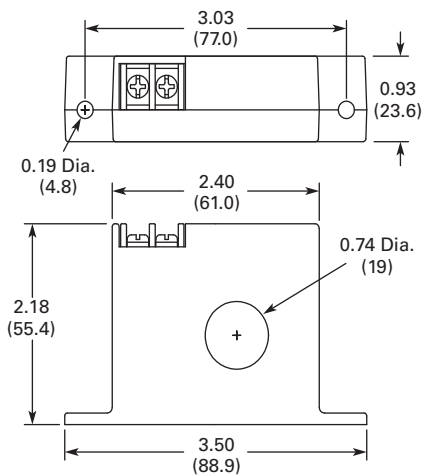

Split Core Housing

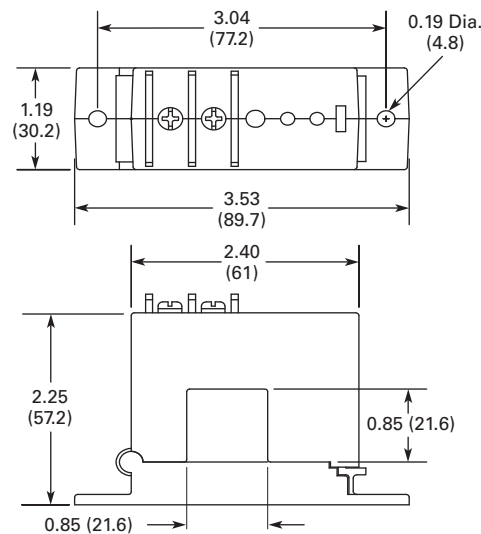

ECSJ Series CurrentWatch Current Switches



Contents

Description	Page
ECSJ Series CurrentWatch Current Switches	
Standards and Certifications	V8-T7-12
Product Selection	V8-T7-12
Accessories	V8-T7-13
Technical Data and Specifications	V8-T7-13
Wiring Diagrams	V8-T7-14
Dimensions	V8-T7-14

ECSJ Series CurrentWatch Current Switches

Product Description

The CurrentWatch ECSJ Series current operated switches from Eaton’s Electrical Sector provide the same dependable indication of status offered by the CurrentWatch ECS Series, but with the added benefit of increased setpoint precision. A choice of three, jumper-selectable input ranges allows the ECSJ Series to be tailored to an application, providing more precise control through improved setpoint resolution. Self-powering, isolated solid-state outputs, 1–6A, 6–40A and 40–200A input ranges, and a choice of split- or solid-core enclosures are standard.

For typical applications of the CurrentWatch ECSJ Series, see listing on this page.

Application Description

Typical Applications

- **Electronic Proof of Flow**—Current operated switches eliminate the need for multiple pipe or duct penetrations and are more reliable than electro-mechanical pressure or flow switches
- **Conveyors**—Detect jams and overloads
- **Lighting Circuits**—Easier to install and more accurate than photocells
- **Fans, Pumps and Heating Elements**—Faster response than temperature sensors
- **Critical Motors**
- **Ancillary Equipment**

Example Application— Pump Jam and Suction Loss Protection

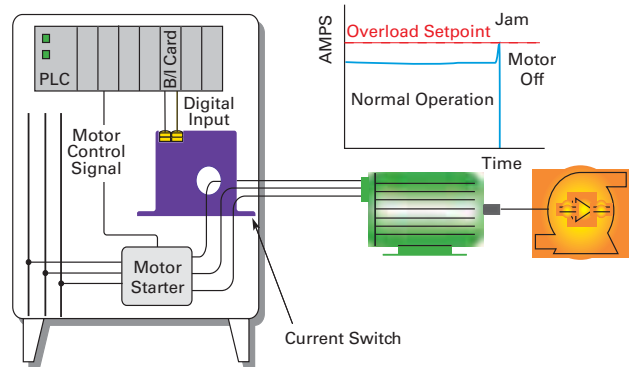

Features

- **Choice of NO or NC Solid-State Outputs**—
 - 1A at 240 Vac
 - 0.15A at 30 Vdc
 - 15A at 120 Vac
 - 3A at 120 Vac
 - 0.15A at 30 Vdc, dual contact
- **Self-Powered**—Cuts installation and operating costs
- **Easily Adjustable Setpoint**—Speeds start-up and reduces inventory
- **Solid- or Split-Core Housings**—Choose the appropriate version for your application
- **LED Indication**—Provides quick visual indication of output contact status
- **Built-In Mounting Feet**—Provide for a secure installation
- **UL, cUL and CE Approved**—Accepted worldwide

For Customer Service in the U.S. call 1-877-ETN CARE (386-2273), in Canada call 1-800-268-3578.

For Application Assistance in the U.S. and Canada call 1-800-426-9184.

For the most current information on this product, visit our Web site: www.eaton.com



Standards and Certifications

- UL Listed
- cUL Listed
- CE Certified
- UL 508 Industrial Control Equipment (USA and Canada)

DANGER

THIS SENSOR IS NOT A SAFETY DEVICE AND IS NOT INTENDED TO BE USED AS A SAFETY DEVICE. This sensor is designed only to detect and read certain data in an electronic manner and perform no use apart from that, specifically no safety-related use. This sensor product does not include self-checking redundant circuitry, and the failure of this sensor product could cause either an energized or de-energized output condition, which could result in death, serious bodily injury, or property damage.

Product Selection**ECSJ Series CurrentWatch Current Switches****Front and Top Terminal Switches**

	Power Supply	Aperture Size	Output Type, Voltage and Rating	Setpoint and LED Configuration	Catalog Number
Solid-Core Housing with Front Terminal 	Solid-Core Housing with Front Terminal				
	Self-powered (no external power needed)	0.55 in (14 mm)	Normally open, 1A at 240 Vac	Adjustable 1–6, 6–40 or 40–175A setpoint with LED	ECSJ400SC
			Normally open, 15A at 120 Vac, 10A at 240 Vac	Adjustable 1–6, 6–40 or 40–175A setpoint with LED	ECSJ406SC ①
			Normally closed, 1A at 240 Vac	Adjustable 1–6, 6–40 or 40–175A setpoint with LED	ECSJ401SC
			Normally closed, 15A at 120 Vac, 10A at 240 Vac	Adjustable 1–6, 6–40 or 40–175A setpoint with LED	ECSJ407SC ①
			Dual contact, NO and NC, 0.15A at 30 Vdc	Adjustable 1–6, 6–40 or 40–175A setpoint without LED	ECSJ430SC ①
			Normally open, 0.15A at 30 Vdc	Adjustable 1–6, 6–40 or 40–175A setpoint with LED	ECSJ420SC
			Normally closed, 0.15A at 30 Vdc	Adjustable 1–6, 6–40 or 40–175A setpoint without LED	ECSJ424SC
		Normally closed, 0.15A at 30 Vdc	Adjustable 1–6, 6–40 or 40–175A setpoint with LED	ECSJ421SC	
Solid-Core Housing with Top Terminal 	Solid-Core Housing with Top Terminal				
	Self-powered (no external power needed)	0.74 in (19 mm)	Normally open, 3A at 120 Vac	Adjustable 1–6, 6–40 or 40–175A setpoint with LED	ECSJ404SC
		Normally closed, 3A at 120 Vac	Adjustable 1–6, 6–40 or 40–175A setpoint with LED	ECSJ405SC	
Split-Core Housing 	Split-Core Housing				
	Self-powered (no external power needed)	0.85 in (21.6 mm)	Normally open, 1A at 240 Vac	Adjustable 1.75–6, 6–40 or 40–200A setpoint with LED	ECSJ402SP
			Normally closed, 1A at 240 Vac	Adjustable 1.75–6, 6–40 or 40–200A setpoint with LED	ECSJ403SP
			Normally open, 0.15A at 30 Vdc	Adjustable 1.75–6, 6–40 or 40–200A setpoint with LED	ECSJ422SP
		Normally closed, 0.15A at 30 Vdc	Adjustable 1.75–6, 6–40 or 40–200A setpoint with LED	ECSJ423SP	

Note

① Unit features built-in heatsink that adds to height. See dimension drawings on **Page V8-T7-14** for details.

Accessories

DIN Rail
Mounting KitECSJ Series CurrentWatch
Current Switches

Description	Catalog Number
DIN rail mounting kit ①	EDINKIT

Technical Data and Specifications

ECSJ Series CurrentWatch Current Switches

Description	AC Solid-State Output Specification	DC Solid-State Output Specification
Power supply	Self-powered—no power supply needed	Self-powered—no power supply needed
Output	Isolated solid-state switch	Isolated solid-state switch
Output rating		
Standard models	1.0A at 240 Vac	0.15A at 30 Vdc
High current switching models	ECSJ404SC and ECSJ405SC: 3.0A at 120 Vac	ECSJ430SC: 0.15A at 30 Vdc, dual contact, NO and NC
Very high current switching models	ECSJ406SC and ECSJ407SC: 15A at 120 Vac, 10A at 240 Vac	—
Off-state leakage	NO models: <10 μ A NC models: 2.5 mA	NO models: <10 μ A NC models: 2.5 mA
Response time	40–120 ms	40–120 ms
Setpoint range (adjustable)	Solid-core models: 1–6, 6–40 and 40–175A Split-core models: 1.75–6, 6–40 and 40–200A	Solid-core models: 1–6, 6–40 and 40–175A Split-core models: 1.75–6, 6–40 and 40–200A
Hysteresis	Low: 6%; mid: 4%; high: 3%	Low: 6%; mid: 4%; high: 3%
Isolation voltage	UL listed to 1270 Vac, tested to 5000 Vac	UL listed to 1270 Vac, tested to 5000 Vac
Frequency range	6–100 Hz	6–100 Hz
Sensing aperture	Solid-core, front terminal models: 0.55 in (14 mm) Solid-core, top terminal models: 0.74 in (19 mm) Split-core models: 0.85 in (21.6 mm) sq.	Solid-core, front terminal models: 0.55 in (14 mm) Solid-core, top terminal models: 0.74 in (19 mm) Split-core models: 0.85 in (21.6 mm) sq.
Housing	UL94 V0 flammability rated	UL94 V0 flammability rated
Environmental	Operating temperature: –58° to 122°F (–50° to 50°C) Humidity: 0–95% RH, non-condensing	Operating temperature: –58° to 122°F (–50° to 50°C) Humidity: 0–95% RH, non-condensing

Overload Ratings

Housing	Range	Maximum Amperes	
		Six Seconds	One Second
Solid-core	1–6A	400A	600A
	6–40A	500A	800A
	40–175A	800A	1200A
Split-core	1.75–6A	400A	600A
	6–40A	500A	800A
	40–200A	800A	1200A

Note

① Sensor pictured for reference and not included in kit.

Wiring Diagrams ^{①②}

All Normally Open (NO) Models

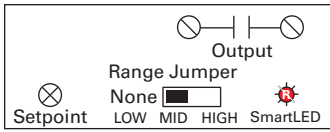

ECSJ430SC (Dual Contact, NO and NC)



All Normally Closed (NC) Models

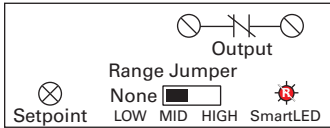

Dimensions

Approximate Dimensions in Inches (mm)

All Solid-Core Models with Front Terminals Except ECSJ406SC and ECSJ407SC

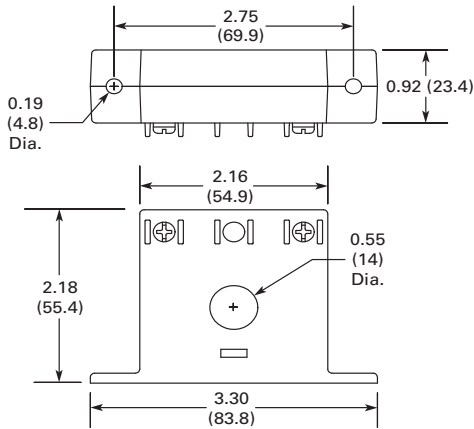

All Solid-Core Models with Top Terminals

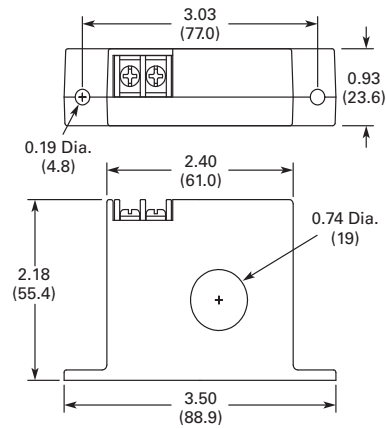

ECSJ406SC and ECSJ407SC Solid-Core Models with Front Terminals

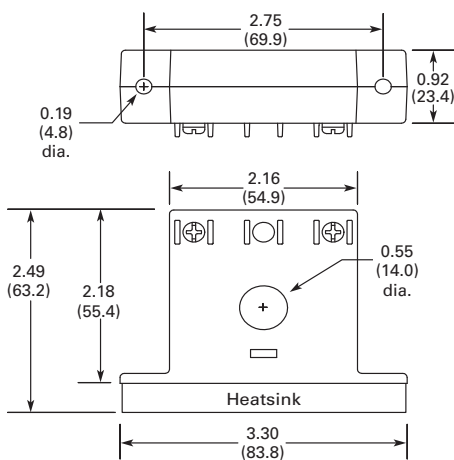

All Split-Core Models

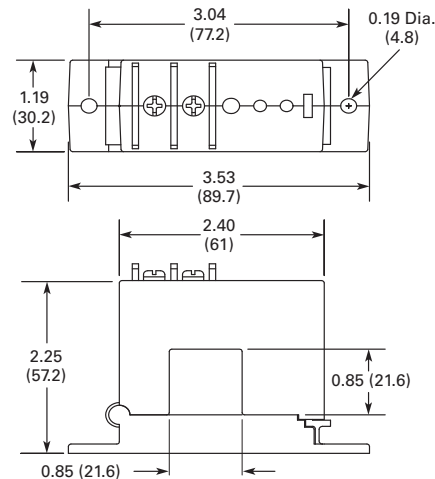

Notes

- ① Terminals are #6 screws.
- ② DC contacts are polarity sensitive.

ECS7 Series CurrentWatch Current Switches



Contents

<i>Description</i>	<i>Page</i>
ECS7 Series CurrentWatch Current Switches	
Product Selection	V8-T7-16
Accessories	V8-T7-16
Technical Data and Specifications	V8-T7-17
Wiring Diagram	V8-T7-18
Dimensions	V8-T7-18

ECS7 Series CurrentWatch Current Switches

Product Description

The CurrentWatch ECS7 Series load monitoring switches from Eaton’s Electrical Sector are designed for overload, underload or operating window applications. Upon sensing an average operating current, the ECS7 Series self-learns and establishes a limit-alarm trip point based on ±15% of the average expected current draw. The ECS7 Series is available in solid- or split-core housing styles.

For typical applications of the CurrentWatch ECS7 Series, see listing on this page.

Application Description

Typical Applications

- **Conveyors**—Use current overload models to detect conveyor jams caused by scenarios such as side-by-sides
- **Electronic Proof of Flow**—More reliable than electro-mechanical pressure or flow switches, with no need for pipe or duct penetrations
- **Pump Protection**—Provides overload (jams) and underload (suction loss) indication

Features

- **Self-Powered and Self-Calibrating**—Reduces installation costs
- **Status Monitoring, Overload and Operating Window Options**—Choose the operating style that matches your application
- **Universal Output**—AC or DC compatibility with any automation system
- **UL, cUL and CE Approved**—Accepted worldwide

Standards and Certifications

- UL Listed
- cUL Listed
- CE Certified
- UL 508 Industrial Control Equipment (USA and Canada)



⚠ DANGER

THIS SENSOR IS NOT A SAFETY DEVICE AND IS NOT INTENDED TO BE USED AS A SAFETY DEVICE. This sensor is designed only to detect and read certain data in an electronic manner and perform no use apart from that, specifically no safety-related use. This sensor product does not include self-checking redundant circuitry, and the failure of this sensor product could cause either an energized or de-energized output condition, which could result in death, serious bodily injury, or property damage.

For the most current information on this product, visit our Web site: www.eaton.com



For Customer Service in the U.S. call 1-877-ETN CARE (386-2273), in Canada call 1-800-268-3578.

For Application Assistance in the U.S. and Canada call 1-800-426-9184.

Product Selection

ECS7 Series CurrentWatch Current Switches

Front and Top Terminal Switches

	Power Supply	Output Type	Aperture Size	Intelligent Logic	Catalog Number
Solid-Core Housing 	Self-powered (no external power needed)	Normally open	0.74 in (19 mm)	Over/underload, 1.5–150A self-calibrating	ECS701SC ^①
				Overload only, 1.5–150A self-calibrating	ECS700SC
				Underload only, 1.5–150A self-calibrating	ECS702SC
				Split-Core Housing	
Split-Core Housing 	Self-powered (no external power needed)	Normally open	0.85 in (21.6 mm)	Over/underload, 2.8–150A self-calibrating	ECS711SP ^①
				Overload only, 2.8–150A self-calibrating	ECS710SP
				Underload only, 2.8–150A self-calibrating	ECS712SP

Accessories

DIN Rail
Mounting KitECS7 Series CurrentWatch
Current Switches

Description	Catalog Number
DIN rail mounting kit ^②	EDINKIT

Notes

- ^① Output is closed when current is within $\pm 15\%$ window.
^② Sensor pictured for reference and not included in kit.

Technical Data and Specifications

ECS7 Series CurrentWatch Current Switches

Description	Specification
Power supply	Self-powered—no power supply needed
Output	Magnetically isolated solid-state switch
Output rating	Normally open (NO) models: 0.3A at 135 Vac/dc Not polarity sensitive
Off-state leakage	<10 μ A
Response time	200 ms
Setpoint range	Solid-core models: 1.5 to 150A Split-core models: 2.8 to 150A
Setpoint	Overload models: +15% of load Underload models: -15% of load Operating window: \pm 5% of setpoint
Hysteresis	5% of setpoint
Overload	500A at 6 sec., 1000A at 1 sec.
Isolation voltage	UL listed to 1270 Vac, tested to 5000 Vac
Frequency range	6–100 Hz
Sensing aperture	Solid-core models: 0.74 in (19 mm) dia. Split-core models: 0.85 in (21.6 mm) sq.
Housing	UL94 V0 flammability rated
Environmental	Operating temperature: -58° to 122°F (-50° to 50°C) Humidity: 0–95% RH, non-condensing

Current Switch Operation

Underload Only Models

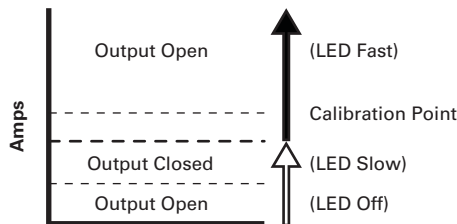

Overload Only Models

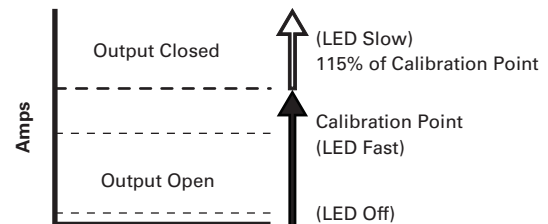

Over/Underload Models ①

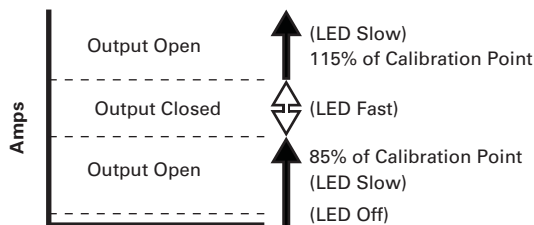

Note

① Output is closed when current is within \pm 15% window.

Wiring Diagram

ECS7 Series CurrentWatch Current Switches

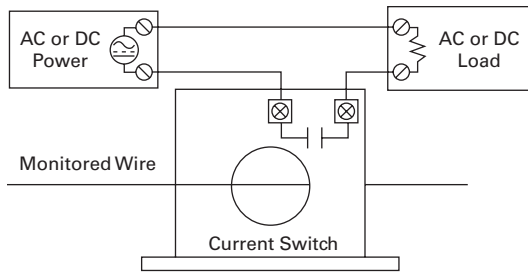

7

Dimensions

Approximate Dimensions in Inches (mm)

Solid-Core Housing

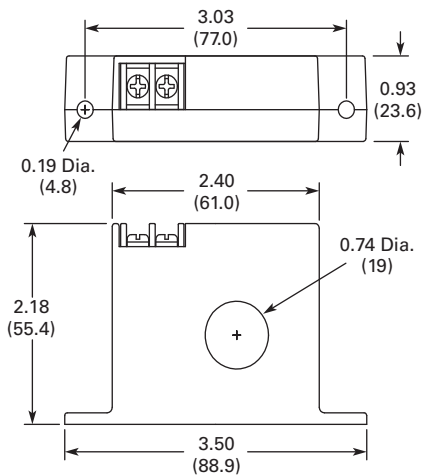

Split-Core Housing

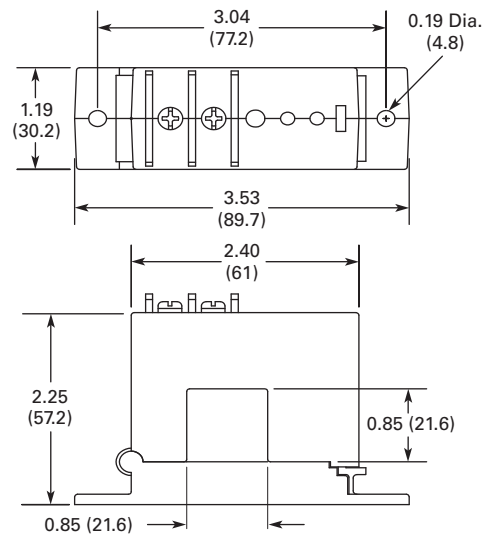

ECSTD Series CurrentWatch Current Switches



Contents

<i>Description</i>	<i>Page</i>
ECSTD Series CurrentWatch Current Switches	
Standards and Certifications	V8-T7-20
Product Selection	V8-T7-20
Accessories	V8-T7-21
Technical Data and Specifications	V8-T7-21
Wiring Diagram	V8-T7-22
Dimensions	V8-T7-22

ECSTD Series CurrentWatch Current Switches

Product Description

The CurrentWatch ECSTD Series from Eaton’s Electrical Sector is a family of high performance current-operated switches with field-adjustable time delay to help minimize nuisance trips during start-up and operation. Designed for motor status applications where setpoint accuracy and repeatability are critical, the ECSTD Series offers a linear setpoint characteristic and constant hysteresis. Standard features include self-powering, jumper-selectable ranges and a choice of outputs and housing styles.

For typical applications of the CurrentWatch ECSTD Series, see listing on this page.

Application Description

Typical Applications

- **Motor Protection**—Serves as an electronic proof-of-operation; detects current draw changes in motors when they encounter problems such as pumps running dry or pending bearing failure; non-intrusive and less expensive to install than differential pressure flow sensors or thermal switches; much quicker response time than Class 10 overload relays
- **High Inrush or Temporary Overload Current**—Adjustable start-up/delay timer allows 0–15 second delay to eliminate nuisance trips from high inrush or short overload conditions

Example Application—Isolated Alarm System Interfacing

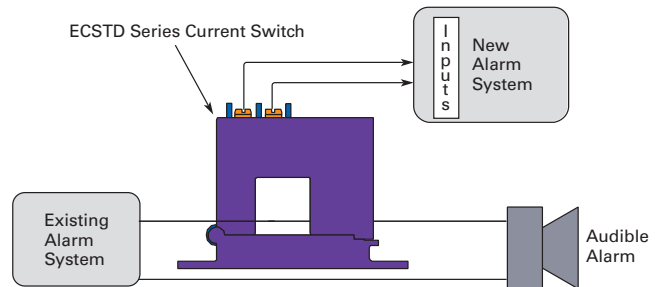

Features

- **Adjustable Start-Up/Delay Timer**—Field adjustable from 0–15 seconds to eliminate nuisance alarms due to start-up inrush or temporary overcurrent conditions
- **Choice of NO/NC AC or Universal Outputs**—Contact ratings of 1.0A at 240 Vac or universal outputs of 0.15A at 240 Vac/dc (NO models) and 0.2A at 135 Vac/dc (NC models) for use with most standard motor control systems
- **Improved Ease of Installation and Use**—Self-powered, split-core core models simplify installation, 1.0A AC rating eliminates need for time delay relay, and status LED provides visual indication of setpoint trip and contact action
- **Industrial Grade Performance**—Constant hysteresis and linear response characteristics enhance setpoint accuracy
- **Agency Approved**—UL Listed, CE pending

For the most current information on this product, visit our Web site: www.eaton.com

For Customer Service in the U.S. call 1-877-ETN CARE (386-2273), in Canada call 1-800-268-3578.

For Application Assistance in the U.S. and Canada call 1-800-426-9184.

Standards and Certifications

- UL Listed
- cUL Listed
- CE (Pending)
- UL 508 Industrial Control Equipment (USA and Canada)





⚠ DANGER



THIS SENSOR IS NOT A SAFETY DEVICE AND IS NOT INTENDED TO BE USED AS A SAFETY DEVICE. This sensor is designed only to detect and read certain data in an electronic manner and perform no use apart from that, specifically no safety-related use. This sensor product does not include self-checking redundant circuitry, and the failure of this sensor product could cause either an energized or de-energized output condition, which could result in death, serious bodily injury, or property damage.

7

Product Selection**ECSTD Series CurrentWatch Current Switches****AC Output Switches (NO/NC 1A at 240 Vac)**

	Power Supply	Aperture Size	Output Type	Setpoint Options	Catalog Number
Solid-Core Housing 	Self powered (no external power needed)	0.75 in (19 mm)	Normally open	Adjustable setpoints: 1.5–12, 12–55 or 50–175A	ECSTD401SC
			Normally closed	Adjustable setpoints: 1.5–12, 12–55 or 50–175A	ECSTD402SC
Split-Core Housing 	Self powered (no external power needed)	0.85 in (21.6 mm)	Normally open	Adjustable setpoints: 2–12, 12–55 or 50–200A	ECSTD404SP
			Normally closed	Adjustable setpoints: 2–12, 12–55 or 50–200A	ECSTD405SP

AC/DC Output Switches (NO 0.15A at 240 Vac/dc, NC 0.2A at 135 Vac/dc) ①

	Power Supply	Aperture Size	Output Type	Setpoint Options	Catalog Number
Solid-Core Housing 	Self powered (no external power needed)	0.75 in (19 mm)	Normally open	Adjustable setpoints: 1.5–12, 12–55 or 50–175A	ECSTD406SC
			Normally closed	Adjustable setpoints: 1.5–12, 12–55 or 50–175A	ECSTD407SC
Split-Core Housing 	Self powered (no external power needed)	0.85 in (21.6 mm)	Normally open	Adjustable setpoints: 2–12, 12–55 or 50–200A	ECSTD408SP
			Normally closed	Adjustable setpoints: 2–12, 12–55 or 50–200A	ECSTD409SP

Note

① Preferred for PLC inputs.

Accessories

DIN Rail Mounting Kit



ECSTD Series CurrentWatch Current Switches

Description	Catalog Number
DIN rail mounting kit ①	EDINKIT

Technical Data and Specifications

ECSTD Series CurrentWatch Current Switches

Description	Specification
Power supply	Self-powered—no power supply needed
Output	Magnetically isolated solid-state switch
Output rating	AC output models: NO/NC 1A at 240 Vac AC/DC output models: NO 0.15A at 240 Vac/dc; NC 0.20A at 135 Vac/dc
Off-state leakage	<10 μ A
Response time	Adjustable 0.2 to 15 sec.
Setpoint range	Solid-core: 1.5–12, 12–55 or 50–175A Split-core: 2–12, 12–55 or 50–200A (jumper selectable)
Hysteresis	5% (constant)
Isolation voltage	5000 Vac (tested)
Frequency range	50–100 Hz
Sensing aperture	Solid-core models: 0.75 in (19 mm) dia. Split-core models: 0.85 in (21.6 mm) sq.
Housing	UL94 V0 flammability rated
Environmental	Operating temperature: 5° to 122°F (–15° to 50°C) Humidity: 0–95% RH, non-condensing

Overload Ratings

Housing	Range	Maximum Amperes		
		Continuous	Six Seconds	One Second
Solid-core	1.5–175A	175A	400A	1000A
Split-core	2–200A	200A	400A	1000A

LED Indication/Output Status

Monitored Amps	Output		
	NO	NC	Smart-LED (If Present)
None or minimum	Open	Closed	Off
Below trip level	Open	Closed	Slow (2 sec.)
Above trip level	Closed	Open	Fast (0.5 sec.)

Note

① Sensor pictured for reference and not included in kit.

Wiring Diagram

ECSTD Series CurrentWatch Current Switches

Normally open (NO) models shown

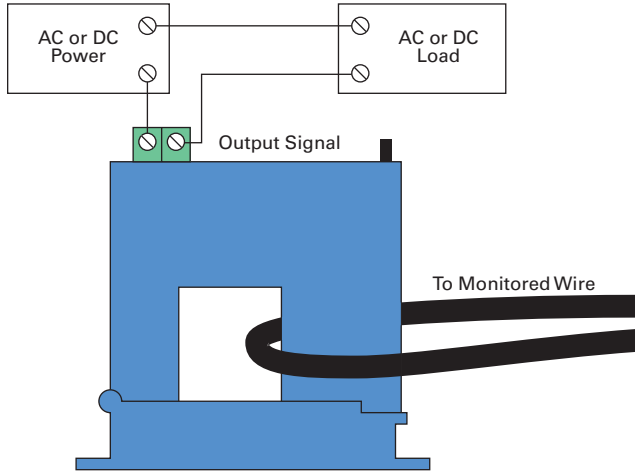

7

Dimensions

Approximate Dimensions in Inches (mm)

Solid-Core Housing

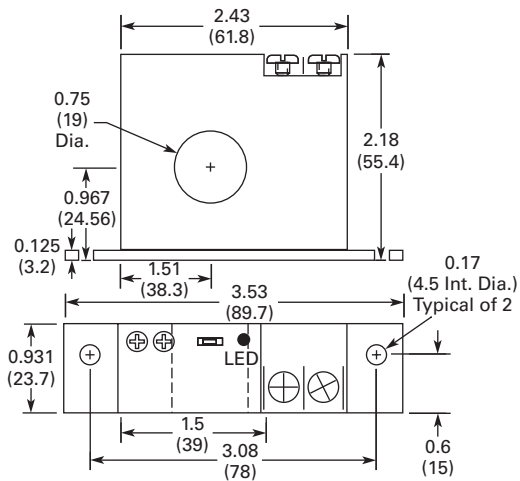

Split-Core Housing

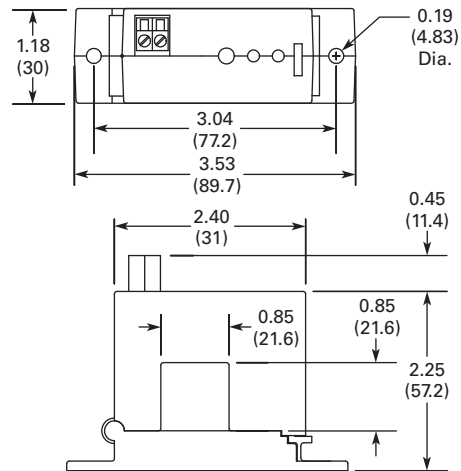

ECSD Series CurrentWatch Current Switches



Contents

<i>Description</i>	<i>Page</i>
ECSD Series CurrentWatch Current Switches	
Product Selection	V8-T7-24
Accessories	V8-T7-24
Technical Data and Specifications	V8-T7-24
Wiring Diagrams	V8-T7-25
Dimensions	V8-T7-25

ECSD Series CurrentWatch Current Switches

Product Description

The CurrentWatch ECSD Series current operated switches from Eaton’s Electrical Sector provides the same dependable indication of status offered by the CurrentWatch ECS Series, but with the added benefit of increased setpoint precision. A choice of three jumper-selectable input ranges allow the ECSD Series to be tailored to an application, providing more precise control through improved setpoint resolution. Features such as isolated solid-state or mechanical relay outputs; 4-20A, 10-50A, and 20-100A input ranges are standard.

For typical applications of the CurrentWatch ECSD Series, see the listing on this page.

Application Description

Typical Applications

- **Electronic Proof of Flow**—Current operated switches eliminate the need for multiple pipe or duct penetrations and are more reliable than electromechanical pressure or flow switches
- **Welders**—Instant indication of equipment status
- **Large Drive Motors**—Provide monitoring for field loss protection
- **Power Supplies**—Detect and signal over-current condition before equipment damage
- **UPS**—Monitors battery output
- **Ancillary Equipment**

Features

- **Choice of Mechanical Relay or Solid-state Outputs**
 - SPDT (Form C) relay, 5.0A at 240 Vac or 30 Vdc
 - Solid-state, NO, 0.15A at 240 Vac/dc
- **Easily Adjustable Setpoint**—Speeds start-up and reduces inventory
- **Compact, One-Piece Design**—Easily fits in crowded control panels
- **Input Isolation**—Safer than shunt/relay combinations
- **Adaptive Hysteresis**—Hysteresis is five percent of setpoint, allowing closer control than fixed-hysteresis switches
- **Solid-Core Housings**
- **LED Indication**—Provides quick visual indication of output contact status
- **Built-In Mounting Feet**—Provide for a secure installation

Standards and Certifications

- UL Listed
- cUL Listed
- CE



⚠ DANGER

THIS SENSOR IS NOT A SAFETY DEVICE AND IS NOT INTENDED TO BE USED AS A SAFETY DEVICE. This sensor is designed only to detect and read certain data in an electronic manner and perform no use apart from that, specifically no safety-related use. This sensor product does not include self-checking redundant circuitry, and the failure of this sensor product could cause either an energized or de-energized output condition, which could result in death, serious bodily injury, or property damage.

For the most current information on this product, visit our Web site: www.eaton.com

For Customer Service in the U.S. call 1-877-ETN CARE (386-2273), in Canada call 1-800-268-3578.

For Application Assistance in the U.S. and Canada call 1-800-426-9184.

Product Selection

ECSD Series CurrentWatch Current Switches

Top Terminal Switches

	Power Supply	Aperture Size	Output Type, Voltage and Rating	Setpoint and LED Configuration	Catalog Number
Solid-Core Housing with Top Terminal 	Solid-Core Housings with Top Terminal				
	12 Vac/dc	0.74 in (19 mm)	Solid-state, normally open, 0.15A at 240 Vac/dc	Adjustable: 4–20, 10–50, 20–100A	ECSD112SC
			Mechanical relay, SPDT (Form C), 5.0A at 240 Vac, 30 Vdc		ECSD212SC
	24 Vac/dc	0.74 in (19 mm)	Solid-state, normally open, 0.15A at 240 Vac/dc	Adjustable: 4–20, 10–50, 20–100A	ECSD124SC
			Mechanical relay, SPDT (Form C), 5.0A at 240 Vac, 30 Vdc		ECSD224SC

Accessories

DIN Rail Mounting Kit



ECSD Series CurrentWatch Current Switches

Description	Catalog Number
DIN rail mounting kit ①	EDINKIT

Technical Data and Specifications

ECSD Series CurrentWatch Current Switches

Description	Solid-State Output Models	Mechanical Relay Models
Power supply	12 Vac/dc (operates from 10–18 Vac/dc) 24 Vac/dc (operates from 20–28 Vac/dc)	12 Vac/dc (operates from 10–18 Vac/dc) 24 Vac/dc (operates from 20–28 Vac/dc)
Output	Isolated solid-state contact	Mechanical relay (SPDT)
Output rating	0.15A at 240 Vac/dc Normally open	5.0A at 240 Vac 5.0A at 30 Vdc
Off-state leakage	<10 μ A	—
Response time	100 ms at 10% above setpoint 20 ms at 100% above setpoint	—
Setpoint range	Adjustable: 4–20, 10–50, 20–100A	—
Hysteresis	5% of setpoint	—
Overload	1000% of range for 5 sec.	—
Isolation voltage	3 kV	—
Frequency range	DC to 400 Hz	—
Sensing aperture	Solid-core, 0.74 in (19 mm)	—
Housing	UL94 V0 flammability rated	—
Environmental	Operating temperature: –40° to 140°F (–40° to 60°C) Humidity: 0–95% RH, non-condensing	Operating temperature: –4° to 122°F (–20° to 50°C) Humidity: 0–95% RH, non-condensing

Note

① Sensor pictured for reference and not included with kit.

Wiring Diagrams

Solid-State Output Models

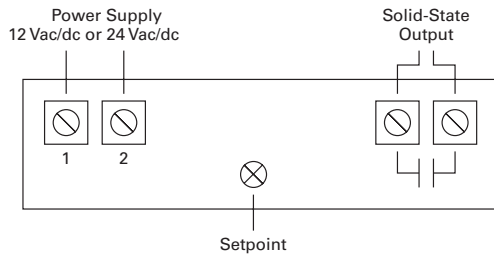

Mechanical Relay Models

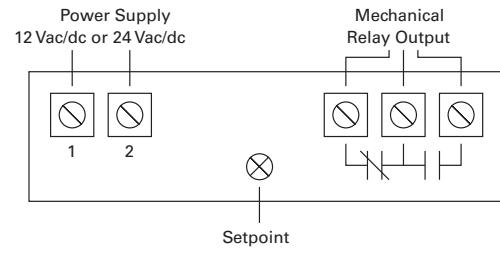

Dimensions

Approximate Dimensions in Inches (mm)

Solid-Core Models

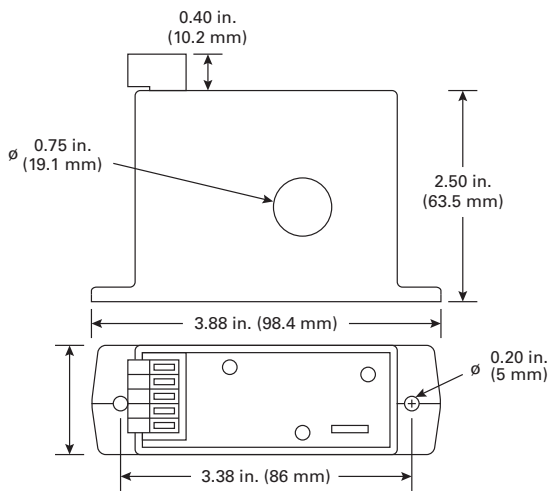

EAC Series CurrentWatch Current Sensors



7

Contents

Description

	<i>Page</i>
EAC Series CurrentWatch Current Sensors	
Standards and Certifications	V8-T7-27
Product Selection	V8-T7-27
Accessories	V8-T7-28
Technical Data and Specifications	V8-T7-28
Wiring Diagrams	V8-T7-29
Dimensions	V8-T7-29

EAC Series CurrentWatch Current Sensors

Product Description

The CurrentWatch EAC Series from Eaton's Electrical Sector combines a current transformer and signal conditioner into a single package. The EAC Series has jumper-selected current input ranges and industry standard outputs: 4–20 mA, 0–5 Vdc or 0–10 Vdc. This family of sensors is designed for application on “linear” or sinu-soidal AC loads. Available in split-core or solid-core housings.

For typical applications of the CurrentWatch EAC Series, see listing on this page.

Application Description

Typical Applications

- **Automation Equipment**—Analog current reading for remote monitoring and software alarms
- **Data Loggers**—Self-powered sensor helps conserve data logger batteries
- **Panel Meters**—Simple connection displays power consumption

Example Application— Preventative Maintenance of a Critical Lighting System

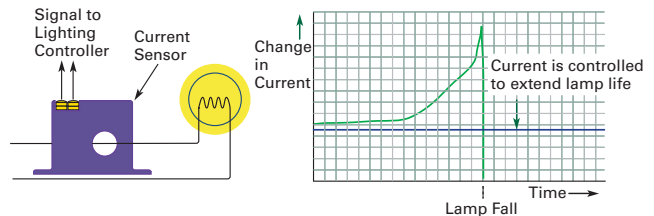

Features

- **Highly Accurate**—Factory matched and calibrated single-piece sensor is more accurate than traditional two-piece, field-installed solutions
- **Average Responding**—“Average Responding” algorithm gives an RMS output on pure sine waves, perfect for constant speed (linear) loads
- **Jumper Selectable Ranges**—The ability to change input ranges reduces inventory and eliminates zero and span
- **Isolation**—Output is magnetically isolated from the input for safety and elimination of insertion loss (voltage drop)
- **UL, cUL and CE Approved**—Accepted worldwide

For the most current information on this product, visit our Web site: www.eaton.com

For Customer Service in the U.S. call 1-877-ETN CARE (386-2273), in Canada call 1-800-268-3578.

For Application Assistance in the U.S. and Canada call 1-800-426-9184.

Standards and Certifications ①

- UL Listed
- cUL Listed
- CE Certified
- UL 508 Industrial Control Equipment (USA and Canada)





⚠ DANGER

THIS SENSOR IS NOT A SAFETY DEVICE AND IS NOT INTENDED TO BE USED AS A SAFETY DEVICE. This sensor is designed only to detect and read certain data in an electronic manner and perform no use apart from that, specifically no safety-related use. This sensor product does not include self-checking redundant circuitry, and the failure of this sensor product could cause either an energized or de-energized output condition, which could result in death, serious bodily injury, or property damage.

Product Selection

EAC Series CurrentWatch Current Sensors

Top Terminal Current Sensors

	Power Supply	Aperture Size	Output Signal	Current Range	Catalog Number	
Solid-Core Housing 	Solid-Core Housings					
	Self-powered (no external power needed)	0.74 in (19 mm)	0–5 Vdc	10, 20 or 50A	EAC105SC	
				100, 150 or 200A	EAC205SC	
	24 Vdc loop-powered		4–20 mA	0–10 Vdc	10, 20 or 50A	EAC110SC
				100, 150 or 200A	EAC210SC	
				2 or 5A	EAC0420SC	
10, 20 or 50A				EAC1420SC		
100, 150 or 200A	EAC2420SC					
Split-Core Housing 	Split-Core Housings—Self-Powered and 24 Vdc					
	Self-powered (no external power needed)	0.85 in (21.6 mm)	0–5 Vdc	10, 20 or 50A	EAC105SP	
				100, 150 or 200A	EAC205SP	
	24 Vdc loop-powered		4–20 mA	0–10 Vdc	10, 20 or 50A	EAC110SP
				100, 150 or 200A	EAC210SP	
				2 or 5A	EAC0420SP	
10, 20 or 50A				EAC1420SP		
100, 150 or 200A	EAC2420SP					
Split-Core Housing 	Split-Core Housings—120 Vac and 24 Vac/dc					
	120 Vac	0.85 in (21.6 mm)	4–20 mA	2 or 5A	EACP0420120SP ②	
				10, 20 or 50A	EACP1420120SP ②	
				100, 150 or 200A	EACP2420120SP ②	
	24 Vac/dc		4–20 mA	2 or 5A	EACP042024USP ②	
				10, 20 or 50A	EACP142024USP ②	
100, 150 or 200A				EACP242024USP ②		

Notes

- ① EACP models not listed.
- ② Not UL listed.

Accessories

DIN Rail
Mounting Kit

EAC Series CurrentWatch Current Sensors

Description	Catalog Number
DIN rail mounting kit ^①	EDINKIT

7

Technical Data and Specifications

EAC Series CurrentWatch Current Sensors

Description	Models with 0–5 Vdc Output Specification	Models with 0–10 Vdc Output Specification	Models with 4–20 mA Output Specification	EACP Series Only Specification
Power supply	Self-powered—no power supply needed	Self-powered—no power supply needed	12–40 Vdc loop-powered	Models ending -OSP: 120 Vac Models ending -USP: 24 Vac/dc (40V maximum)
Output signal	0–5 Vdc	0–10 Vdc	4–20 mA	4–20 mA
Output limit	8.2 Vdc	15 Vdc	23 mA	22.4 mA
Accuracy	1.0% FS	1.0% FS	1.0% FS	1% FS
Response time	100 ms	100 ms	300 ms	100 ms
Frequency range	50–60 Hz	50–60 Hz	20–100 Hz	40–100 Hz
Loading	1M ohm minimum rated accuracy 100 kohms, add 1.3% error	1M ohm minimum rated accuracy 100 kohms, add 1.3% error	See power supply above	50 kohms minimum 500 kohms maximum
Isolation voltage	UL listed to 1270 Vac (tested to 5kV)	UL listed to 1270 Vac (tested to 5kV)	UL listed to 1270 Vac (tested to 5kV)	UL listed to 1270 Vac (tested to 5kV)
Input ranges	Field selectable ranges from 0–200A ^③	Field selectable ranges from 0–200A ^③	Field selectable ranges from 0–200A ^③	0–200A jumper selectable
Sensing aperture	Solid-core: 0.74 in (19 mm) dia. Split-core: 0.85 in (21.6 mm) sq.	Solid-core: 0.74 in (19 mm) dia. Split-core: 0.85 in (21.6 mm) sq.	Solid-core: 0.74 in (19 mm) dia. Split-core: 0.85 in (21.6 mm) sq.	0.85 in (21.6 mm)
Housing	UL94 V0 flammability rated	UL94 V0 flammability rated	UL94 V0 flammability rated	UL94 V0 flammability rated
Environmental	Operating temperature: –4° to 122°F (–20° to 50°C) Humidity: 0–95% RH, non-condensing	Operating temperature: –4° to 122°F (–20° to 50°C) Humidity: 0–95% RH, non-condensing	Operating temperature: –4° to 122°F (–20° to 50°C) Humidity: 0–95% RH, non-condensing	Operating temperature: –4° to 122°F (–20° to 50°C) Humidity: 0–95% RH, non-condensing

Notes

- ① Sensor pictured for reference and not included in kit.
- ② Does not apply to EACP series.
- ③ Additional custom ranges available from factory.

Wiring Diagrams

EACP Models

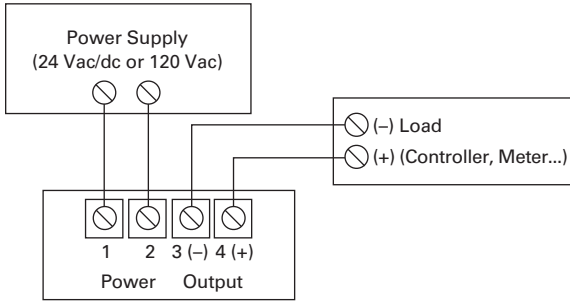

All Other Models ①

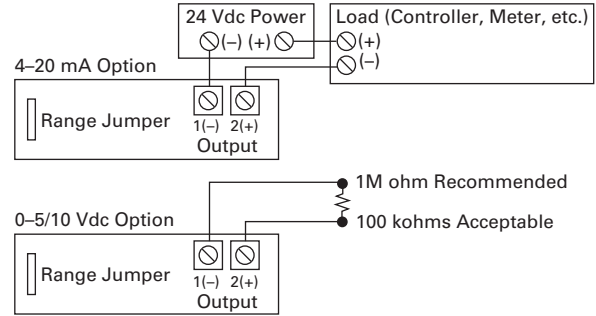

Dimensions

Approximate Dimensions in Inches (mm)

Solid-Core Housing

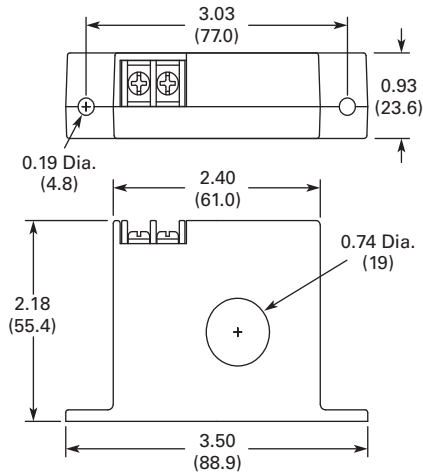

EACP Series

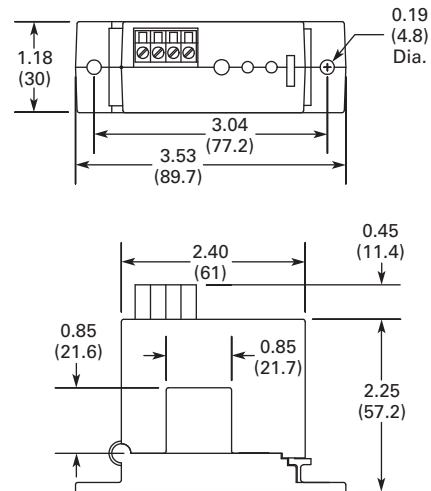

All Other Models

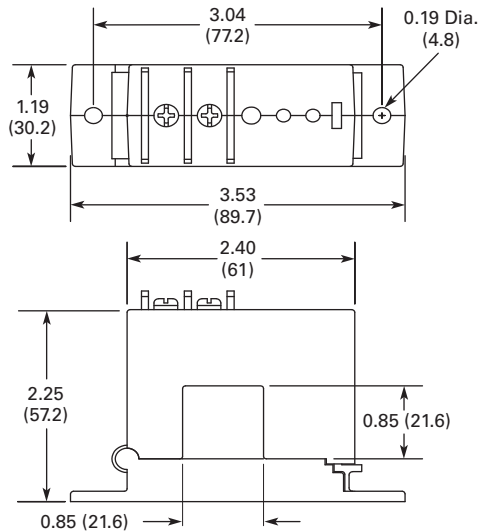

Note

- ① Pressure plate screw terminals. 12-22 AWG solid or stranded. Field adjustable setpoint.

EACR Series CurrentWatch Current Sensors



7

EACR Series CurrentWatch Current Sensors

Product Description

The CurrentWatch EACR Series current sensor family from Eaton's Electrical Sector combines a current sensor and a "True RMS" signal conditioner into a single package. The EACR Series provides True RMS output on distorted waveforms found on VFD or SCR outputs, and on linear loads in "noisy" power environments. Available in solid- or split-core housings.

For typical applications of the CurrentWatch EACR Series, see listing on this page.

Why "True RMS"?

The current waveform of a typical linear load is a pure sine wave. In VFD and SCR applications, however, output waveforms are rough approximations of a sine wave. There are numerous spikes and dips in each cycle. The CurrentWatch EACR Series current sensors use a mathematical algorithm called "True RMS" which

Application Description

Typical Applications

- **VFD Controlled Loads**—Monitoring VFD output indicates how the motor and attached load are operating
- **SCR Controlled Loads**—Accurate measurement of phase angle fired or burst fired (time proportioned) SCRs, with faster current measurement than temperature sensors
- **Switching Power Supplies and Electronic Ballasts**—True RMS sensing is the most accurate way to measure power supply or ballast input power

integrates the actual waveform over time. The output is the amperage component of the true power (heating value) of the AC current waveform. True RMS is the only way to accurately measure distorted AC waveforms. Select the EACR Series sensors for nonlinear loads in "noisy" power environments.

For the most current information on this product, visit our Web site: www.eaton.com

Contents

Description

	<i>Page</i>
EACR Series CurrentWatch Current Sensors	
Standards and Certifications	V8-T7-31
Product Selection	V8-T7-31
Accessories	V8-T7-31
Technical Data and Specifications	V8-T7-32
Wiring Diagram	V8-T7-32
Dimensions	V8-T7-32

Example Application— Current Sensing for Non-Linear AC Loads

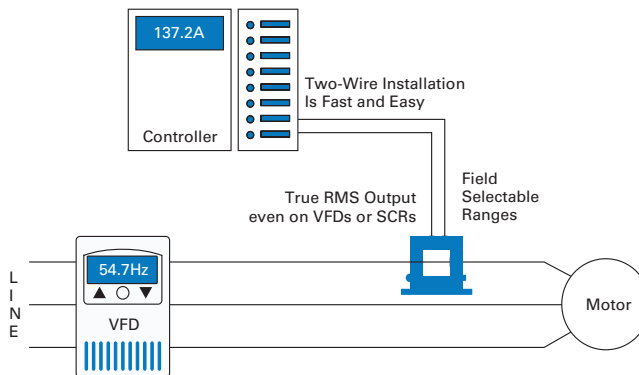

Features

- **True RMS Output**—True RMS technology is accurate on distorted waveforms like VFD or SCR outputs
- **Jumper-Selectable Ranges**—Reduces inventory and eliminates zero and span
- **Isolation**—Output is magnetically isolated from the input for safety and elimination of insertion loss (voltage drop)
- **UL, cUL and CE Approved**—Accepted worldwide

For Customer Service in the U.S. call 1-877-ETN CARE (386-2273), in Canada call 1-800-268-3578.

For Application Assistance in the U.S. and Canada call 1-800-426-9184.

Standards and Certifications

- UL Listed
- cUL Listed
- CE Certified
- UL 508 Industrial Control Equipment (USA and Canada)





⚠ DANGER

THIS SENSOR IS NOT A SAFETY DEVICE AND IS NOT INTENDED TO BE USED AS A SAFETY DEVICE. This sensor is designed only to detect and read certain data in an electronic manner and perform no use apart from that, specifically no safety-related use. This sensor product does not include self-checking redundant circuitry, and the failure of this sensor product could cause either an energized or de-energized output condition, which could result in death, serious bodily injury, or property damage.

Product Selection

EACR Series CurrentWatch Current Sensors

Top Terminal Current Sensors

	Power Supply	Aperture Size	Output Signal	Current Range	Catalog Number
Solid-Core Housing 	Solid-Core Housing 24 Vdc loop-powered	0.74 in (19 mm)	4–20 mA	2 or 5A	EACR0420SC
				10, 20 or 50A	EACR1420SC
				100, 150 or 200A	EACR2420SC
Split-Core Housing 	Split-Core Housing 24 Vdc loop-powered	0.85 in (21.6 mm)	4–20 mA	2 or 5A	EACR0420SP
				10, 20 or 50A	EACR1420SP
				100, 150 or 200A	EACR2420SP

Accessories

DIN Rail Mounting Kit



EACR Series CurrentWatch Current Sensors

Description	Catalog Number
DIN rail mounting kit ①	EDINKIT

Note

① Sensor pictured for reference and not included in kit.

Technical Data and Specifications

EACR Series CurrentWatch Current Sensors

Description	Specification
Power supply	24 Vdc loop-powered, 40 Vdc maximum
Output signal	4–20 mA
Output limit	23 mA
Accuracy	1.0% FS
Response time	600 ms (to 90% step change)
Frequency range	10–400 Hz
Isolation voltage	UL listed to 1270 Vac (Tested to 5 kV)
Input ranges	Field selectable ranges from 0–200A ^①
Sensing aperture	Solid-core: 0.74 in (19 mm) dia. Split-core: 0.85 in (21.6 mm) sq.
Housing	UL94 V0 flammability rated
Environmental	Operating temperature: –4° to 122°F (–20° to 50°C) Humidity: 0–95% RH, non-condensing

Wiring Diagram

EACR Series CurrentWatch Current Sensors ^②

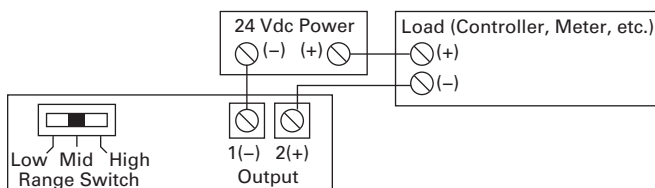

Dimensions

Approximate Dimensions in Inches (mm)

Solid-Core Housing

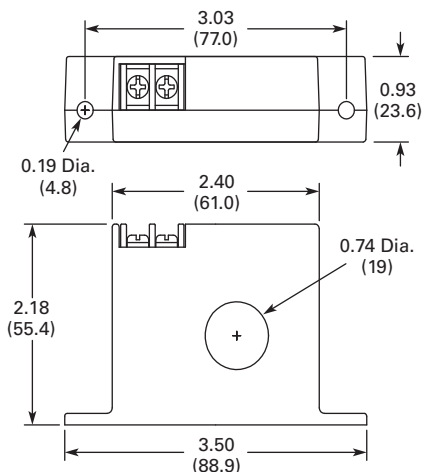

Split-Core Housing

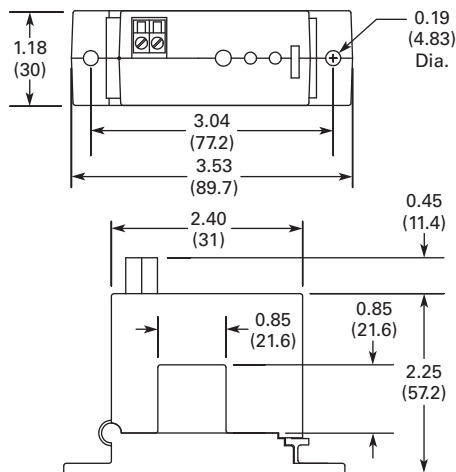

Notes

- ① Additional custom ranges available from factory.
- ② Deadfront captive screw terminals (split-core housing models only).
12–22 AWG solid or stranded.
Observe polarity.

EDC Series CurrentWatch Current Sensors

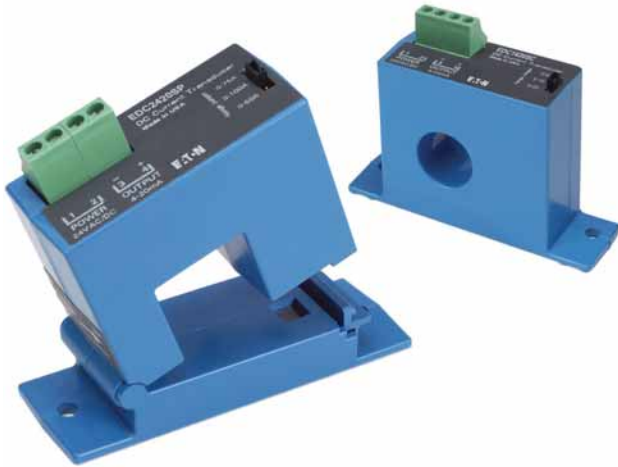

Contents

Description	Page
EDC Series CurrentWatch Current Sensors	
Standards and Certifications	V8-T7-34
Product Selection	V8-T7-34
Accessories	V8-T7-35
Technical Data and Specifications	V8-T7-35
Wiring Diagram	V8-T7-36
Dimensions	V8-T7-36

EDC Series CurrentWatch Current Sensors

Product Description

The CurrentWatch EDC Series from Eaton’s Electrical Sector combines a hall effect sensor and signal conditioner into a single package for use in DC current applications up to 300A. The EDC Series has jumper-selected current input ranges and industry standard outputs: 4–20 mA, 0–5 Vdc or 0–10 Vdc. Available in split-core models for quick and easy installation.

For typical applications of the CurrentWatch EDC Series, see listing on this page.

Application Description

Typical Applications

- **Battery Banks**—Monitor load current, monitor charging current and verify operation
- **Transportation**—Measures traction power or auxiliary loads
- **Electric Heating Elements**—Monitor heater loads with a faster response time than temperature sensors

Example Application—Battery Charging System

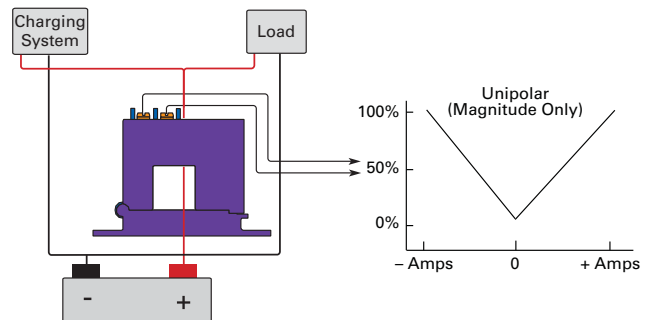

Features

- **Jumper-Selectable Ranges**—Reduce inventory and eliminate zero or span pots
- **Isolation**—Output is magnetically isolated from the input for safety, also eliminating insertion loss (voltage drop)
- **Internal Power Regulation**—Cuts installation costs and works well, even with unregulated power
- **Split Core Design and Built-In Mounting Brackets**—Make installation quick and easy
- **UL and CE Approved**

For the most current information on this product, visit our Web site: www.eaton.com

For Customer Service in the U.S. call 1-877-ETN CARE (386-2273), in Canada call 1-800-268-3578.

For Application Assistance in the U.S. and Canada call 1-800-426-9184.

Standards and Certifications

- UL Listed
- cUL Listed
- CE Certified
- UL 508 Industrial Control Equipment (USA and Canada)





⚠ DANGER

THIS SENSOR IS NOT A SAFETY DEVICE AND IS NOT INTENDED TO BE USED AS A SAFETY DEVICE. This sensor is designed only to detect and read certain data in an electronic manner and perform no use apart from that, specifically no safety-related use. This sensor product does not include self-checking redundant circuitry, and the failure of this sensor product could cause either an energized or de-energized output condition, which could result in death, serious bodily injury, or property damage.

Product Selection

EDC Series CurrentWatch Current Sensors

Top Terminal Current Sensors

	Power Supply	Aperture Size	Output Signal	Current Range	Catalog Number
	Split-Core Housing—Uni-Polar Output, see Output Graph on Page V8-T7-35				
	24 Vac/dc	0.85 in (21.6 mm)	0–5 Vdc	50, 75 or 100A	EDC205SP
				100, 150 or 200A	EDC305SP
				150, 225 or 300A	EDC405SP
	0–10 Vdc			50, 75 or 100A	EDC210SP
				100, 150 or 200A	EDC310SP
				150, 225 or 300A	EDC410SP
	4–20 mA			50, 75 or 100A	EDC2420SP
				100, 150 or 200A	EDC3420SP
150, 225 or 300A				EDC4420SP	
	Split-Core Housing—Bidirectional Output, see Output Graph on Page V8-T7-35				
	24 Vac/dc	0.85 in (21.6 mm)	–10 to +10 Vdc	0–100A	EDCB100SP
				0–300A	EDCB300SP
				0–400A	EDCB400SP
	Solid-Core Housing—Single-Polarity Output, see Output Graph on Page V8-T7-35				
	24 Vac/dc	0.75 in (19 mm)	4–20 mA	5, 10 or 20A	EDC1420SC

Accessories

DIN Rail Mounting Kit



CurrentWatch EDC Series

Description	Catalog Number
DIN rail mounting kit ①	EDINKIT

Technical Data and Specifications

EDC Series CurrentWatch Current Sensors

Description	Models with 0–5 Vdc Output Specification	Models with 0–10 Vdc Output Specification	Models with 4–20 mA Output Specification
Power supply	24 Vac/dc (22–38 Vac/dc) 2 VA maximum	24 Vac/dc (22–38 Vac/dc) 2 VA maximum	24 Vac/dc (22–38 Vac/dc) 2 VA maximum
Output signal	0–5 Vdc	0–10 Vdc	4–20 mA
Output limit	5.75 Vdc	11.5 Vdc	23 mA
Accuracy	Solid-core models: 1% FS Split-core models: 2% FS 300A models: 1.5% FS	Solid-core models: 1% FS Split-core models: 2% FS 300A models: 1.5% FS	Solid-core models: 1% FS Split-core models: 2% FS 300A models: 1.5% FS
Response time	Solid-core models: 20 ms (to 90% of step change) Split-core models: 100 ms (to 90% of step change)	Solid-core models: 20 ms (to 90% of step change) Split-core models: 100 ms (to 90% of step change)	Solid-core models: 20 ms (to 90% of step change) Split-core models: 100 ms (to 90% of step change)
Frequency range	DC	DC	DC
Loading	25 kohms minimum	50 kohms minimum	650 ohms maximum
Isolation voltage	3 kV (monitored line to output)	3 kV (monitored line to output)	3 kV (monitored line to output)
Linearity	0.75% FS	0.75% FS	0.75% FS
Current ranges	Field selectable ranges from 0–300A	Field selectable ranges from 0–300A	Field selectable ranges from 0–300A
Sensing aperture	Solid-core housings: 0.75 in (19 mm) dia. Split-core housings: 0.85 in (21.6 mm) sq.	Solid-core housings: 0.75 in (19 mm) dia. Split-core housings: 0.85 in (21.6 mm) sq.	Solid-core housings: 0.75 in (19 mm) dia. Split-core housings: 0.85 in (21.6 mm) sq.
Environmental	Operating temperature: –4° to 122°F (–20° to 50°C) Humidity: 0–95% RH, non-condensing	Operating temperature: –4° to 122°F (–20° to 50°C) Humidity: 0–95% RH, non-condensing	Operating temperature: –4° to 122°F (–20° to 50°C) Humidity: 0–95% RH, non-condensing

Output Graphs

Uni-Polar Output for Split-Core

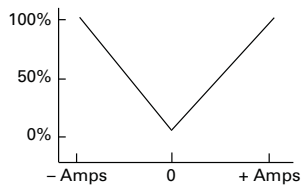

Bidirectional Output for Split-Core

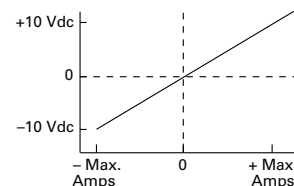

Standard Analog Output for Solid-Core

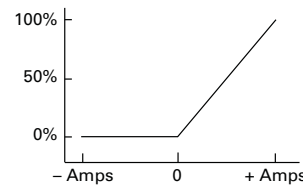

Note

① Sensor pictured for reference and not included in kit.

Wiring Diagram

EDC Series CurrentWatch Current Sensors

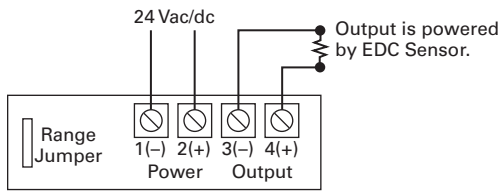

7

Dimensions

Approximate Dimensions in Inches (mm)

Split-Core Housing

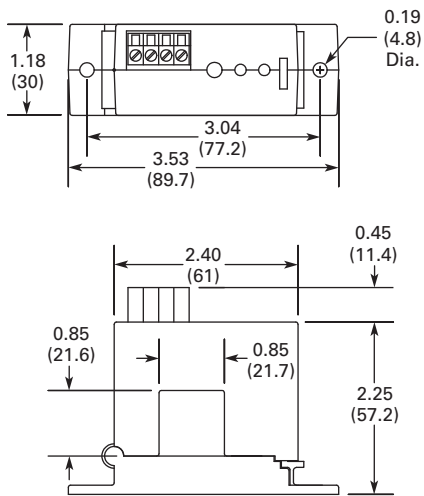

Solid-Core Housing

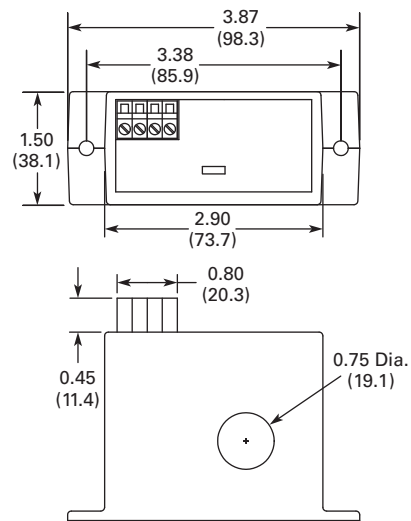

EGF Series CurrentWatch Current Sensors



Contents

<i>Description</i>	<i>Page</i>
EGF Series CurrentWatch Current Sensors	
Features	V8-T7-38
Standards and Certifications	V8-T7-38
Product Selection	V8-T7-38
Accessories	V8-T7-39
Technical Data and Specifications	V8-T7-40
Wiring Diagrams	V8-T7-41
Dimensions	V8-T7-41

EGF Series CurrentWatch Current Sensors

Product Description

The CurrentWatch EGF Series from Eaton’s Electrical Sector is a family of ground fault (earth leakage) sensors. Ground fault sensors help protect people, products and processes from damage by ground fault conditions by monitoring all current-carrying conductors in grounded single- and three-phase delta or wye systems.

The EGF Series with solid-state outputs offers the benefit of reliable, long-lasting solid-state switches. Solid-state design provides unlimited switch operating life, superior resistance to shock and vibration, zero off-state leakage, high switch speeds and high input-output isolation.

The EGF Series with mechanical relay outputs is available in solid-core housings with a choice of NO or NC SPST latching relays and a SPDT Form C relay with auto-reset.

Application Description

Typical Applications

- **Personnel Protection (Typically 5 mA)**—Detects sensitive ground fault conditions, which could cause injury to people, and functions as a sensor and alarm trigger when applied as an input to an overall ground fault protection system
- **Equipment Protection (Typically 10 or 30 mA)**—For applications where personnel protection is not the primary concern, higher setpoint capability helps eliminate nuisance tripping while still providing adequate ground fault detection to protect machine electronics
- **Regulatory**—Meets requirements as stipulated by governmental and industrial regulatory groups for ground fault sensing

Example Application—Insulation Breakdown Monitoring

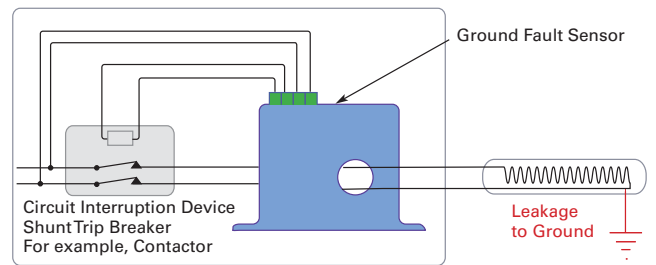

“Zero Sequence” Operating Principle

In three-phase delta and wye systems, under normal conditions, current in the “hot” leg of a two-wire load is equal in magnitude but opposite in sign to the current in a neutral leg. As a result, the electromagnetic fields surrounding these two conductors cancel, producing a “zero sum current.” As

soon as current leaks to ground (fault condition), the two currents become imbalanced and a net magnetic field results. The CurrentWatch EGF Series sensors monitor this field and trip the contacts when the leakage rises above the setpoint.

For the most current information on this product, visit our Web site: www.eaton.com

For Customer Service in the U.S. call 1-877-ETN CARE (386-2273), in Canada call 1-800-268-3578.

For Application Assistance in the U.S. and Canada call 1-800-426-9184.

Features

- **Broad Range of Options to Meet Application Needs**—NO or NC, solid-state or mechanical relays, normally energized or normally de-energized contacts
- **Setpoint Options Maximize Ease-of-Use and Application Flexibility**—Field selectable 5, 10 or 30 mA setpoints on the EGF “tri-set” models make user adjustments fast, sure and convenient
- **Compatible with Standard Equipment**—Application on single- and three-phases systems, ideal for use with shunt trip breakers, and magnetically isolated from monitored circuit and control power
- **Agency Approved**—UL and CE Certified, accepted worldwide

Standards and Certifications

- UL 1053, Class 1 Recognized
- CE



⚠ DANGER

THIS SENSOR IS NOT A SAFETY DEVICE AND IS NOT INTENDED TO BE USED AS A SAFETY DEVICE. This sensor is designed only to detect and read certain data in an electronic manner and perform no use apart from that, specifically no safety-related use. This sensor product does not include self-checking redundant circuitry, and the failure of this sensor product could cause either an energized or de-energized output condition, which could result in death, serious bodily injury, or property damage.

Product Selection

EGF Series CurrentWatch Current Sensors

Solid-State Output Sensors

Solid-Core Housing	Power Supply	Setpoint	AC Solid-State Output	DC Solid-State Output	Contacts	Catalog Number
	120 Vac	Fixed, 50 mA	Solid-state, NO, 1A at 240 Vac	—	Normally energized	EGF1NOACNE050
					Normally de-energized	EGF1NOACDE050
			Solid-state, NC, 1A at 240 Vac	—	Normally energized	EGF1NCACNE050
					Normally de-energized	EGF1NCACDE050
		—	Solid-state, NO, 0.15A at 30 Vdc	—	Normally energized	EGF1NODCNE050
					Normally de-energized	EGF1NODCDE050
			Solid-state, NC, 0.15A at 30 Vdc	—	Normally energized	EGF1NCDCNE050
					Normally de-energized	EGF1NCDCDE050
	120 Vac	Fixed, 100 mA	Solid-state, NO, 1A at 240 Vac	—	Normally energized	EGF1NOACNE100
					Normally de-energized	EGF1NOACDE100
			Solid-state, NC, 1A at 240 Vac	—	Normally energized	EGF1NCACNE100
					Normally de-energized	EGF1NCACDE100
		—	Solid-state, NO, 0.15A at 30 Vdc	—	Normally energized	EGF1NODCNE100
					Normally de-energized	EGF1NODCDE100
			Solid-state, NC, 0.15A at 30 Vdc	—	Normally energized	EGF1NCDCNE100
					Normally de-energized	EGF1NCDCDE100
120 Vac	Tri-set adjustable, 5, 10 or 30 mA	Solid-state, NO, 1A at 240 Vac	—	Normally energized	EGF3NOACNET3	
				Normally de-energized	EGF3NOACDET3	
		Solid-state, NC, 1A at 240 Vac	—	Normally energized	EGF3NCACNET3	
				Normally de-energized	EGF3NCACDET3	
		—	Solid-state, NO, 0.15A at 30 Vdc	—	Normally energized	EGF3NODCNET3
					Normally de-energized	EGF3NODCDET3
		—	Solid-state, NC, 0.15A at 30 Vdc	—	Normally energized	EGF3NCDCNET3
					Normally de-energized	EGF3NCDCDET3

Mechanical Relay Output Sensors

Solid-Core Housing



Power Supply	Setpoint	Mechanical Relay Output	Contacts	Catalog Number	
Solid-Core Housings					
120 Vac	Fixed, 50 mA	Mechanical relay, NO SPST relay, Form A (1A at 120 Vac, 2A at 30 Vdc)	Latching relay	EGF1NOLA050	
		Mechanical relay, NC SPST relay, Form B (1A at 120 Vac, 2A at 30 Vdc)	Latching relay	EGF1NCLA050	
		Mechanical relay, SPDT Form C, auto-reset (1A at 120 Vac, 2A at 30 Vdc)	Normally energized	EGF1SPDTNE050	
			Normally de-energized	EGF1SPDTDE050	
		Fixed, 100 mA	Mechanical relay, NO SPST relay, Form A (1A at 120 Vac, 2A at 30 Vdc)	Latching relay	EGF1NOLA100
			Mechanical relay, NC SPST relay, Form B (1A at 120 Vac, 2A at 30 Vdc)	Latching relay	EGF1NCLA100
	Mechanical relay, SPDT Form C, auto-reset (1A at 120 Vac, 2A at 30 Vdc)		Normally energized	EGF1SPDTNE100	
		Normally de-energized	EGF1SPDTDE100		
	Tri-set adjustable, 5, 10 or 30 mA	Mechanical relay, NO SPST relay, Form A (1A at 120 Vac, 2A at 30 Vdc)	Latching relay	EGF1NOLAT3	
			Mechanical relay, NC SPST relay, Form B (1A at 120 Vac, 2A at 30 Vdc)	Latching relay	EGF1NCLAT3
				Mechanical relay, SPDT Form C, auto-reset (1A at 120 Vac, 2A at 30 Vdc)	Normally energized
		Normally de-energized	EGF1SPDTDET3		
24 Vac/dc		Fixed, 50 mA	Mechanical relay, NO SPST relay, Form A (1A at 120 Vac, 2A at 30 Vdc)	Latching relay	EGF2NOLA050
			Mechanical relay, NC SPST relay, Form B (1A at 120 Vac, 2A at 30 Vdc)	Latching relay	EGF2NCLA050
	Mechanical relay, SPDT Form C, auto-reset (1A at 120 Vac, 2A at 30 Vdc)		Normally energized	EGF2SPDTNE050	
			Normally de-energized	EGF2SPDTDE050	
	Fixed, 100 mA		Mechanical relay, NO SPST relay, Form A (1A at 120 Vac, 2A at 30 Vdc)	Latching relay	EGF2NOLA100
			Mechanical relay, NC SPST relay, Form B (1A at 120 Vac, 2A at 30 Vdc)	Latching relay	EGF2NCLA100
		Mechanical relay, SPDT Form C, auto-reset (1A at 120 Vac, 2A at 30 Vdc)	Normally energized	EGF2SPDTNE100	
	Normally de-energized		EGF2SPDTDE100		
	Tri-set adjustable, 5, 10 or 30 mA	Mechanical relay, NO SPST relay, Form A (1A at 120 Vac, 2A at 30 Vdc)	Latching relay	EGF2NOLAT3	
			Mechanical relay, NC SPST relay, Form B (1A at 120 Vac, 2A at 30 Vdc)	Latching relay	EGF2NCLAT3
				Mechanical relay, SPDT Form C, auto-reset (1A at 120 Vac, 2A at 30 Vdc)	Normally energized
		Normally de-energized	EGF2SPDTDET3		

Accessories

DIN Rail Mounting Kit



EGF Series CurrentWatch Current Sensors

Description	Catalog Number
DIN rail mounting kit ①	EDINKIT

Note

① Sensor pictured for reference and not included in kit.

Technical Data and Specifications

EGF Series CurrentWatch Current Sensors

Description	Solid-State Output Models Specification	Mechanical Relay Output Models Specification
Power supply	120 Vac (55–110% of nominal voltage) 24 Vac/dc ($\pm 20\%$)	120 Vac (55–110% of nominal voltage) 24 Vac/dc ($\pm 20\%$)
Output contact type	Isolated dry contact	Mechanical relay
Output rating (switching current and switching voltage)	AC output switching models: 1A at 240 Vac DC output switching models: 0.15A at 30 Vdc	Auto reset models, SPDT relay: 1A at 120 Vac; 2A at 30 Vdc Latching models, SPST relay: 1A at 120 Vac; 2A at 30 Vdc
Off-state leakage	NO models: <10 μ A NC models: <2.5 mA	None
Response time	200 ms at 5% above trip point 60 ms at 50% above trip point 15 ms at 500% above trip point	200 ms at 5% above trip point 60 ms at 50% above trip point 15 ms at 500% above trip point
Frequency range	50–400 Hz (monitored circuit)	50–400 Hz (monitored circuit)
Loading	2 VA maximum	2 VA maximum
Isolation voltage	5000 Vac (tested)	5000 Vac (tested)
Sensing aperture	0.74 in (19 mm) diameter	0.74 in (19 mm) diameter
LED indicator	Green LED for power ON status; red LED for contact status	Green LED for power ON status; red LED for contact status
Housing	UL94 V0 flammability rated	UL94 V0 flammability rated
Environmental	Operating temperature: -4° to 122° F (-20° to 50° C) Humidity: 0–95% RH, non-condensing	Operating temperature: -4° to 122° F (-20° to 50° C) Humidity: 0–95% RH, non-condensing

Output Tables

Protection from faults and control power loss.

Normally Energized Models

	No Power	Control Power Applied	
		No Fault	Fault
Normally open models	Open	Closed	Open
Normally closed models	Closed	Open	Closed

Normally De-Energized Models

	No Power	Control Power Applied	
		No Fault	Fault
Normally open models	Open	Open	Closed
Normally closed models	Closed	Closed	Open

Latching (Mechanical Relay Output) Models

Latching models power up initially in the rest (normal) mode. If there is a fault condition or the test button is pushed, the output contacts will change state and latch.

The output will remain latched regardless of whether the fault is cleared or control power is removed. To reset the output, apply a momentary contact across “reset” terminals.

Wiring Diagrams

Solid-State Output Models

All Models

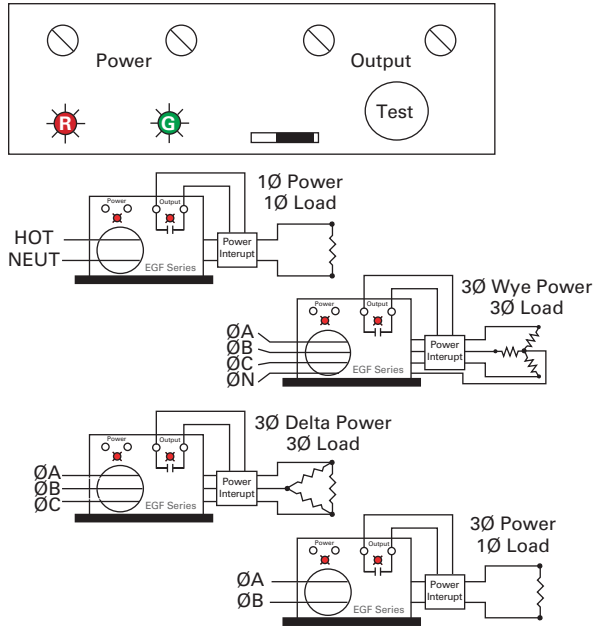

Mechanical Relay Output Models

Latching Models

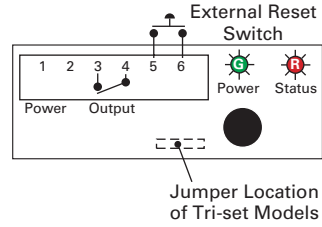

Auto Reset Models

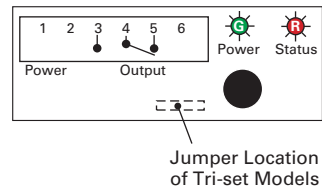

Dimensions

Approximate Dimensions in Inches (mm)

Solid-State Output Models

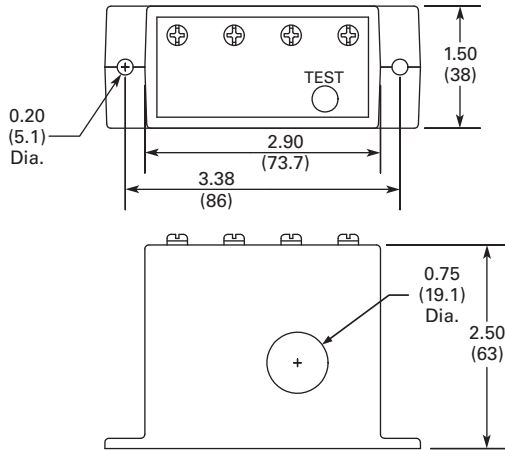

Mechanical Relay Models

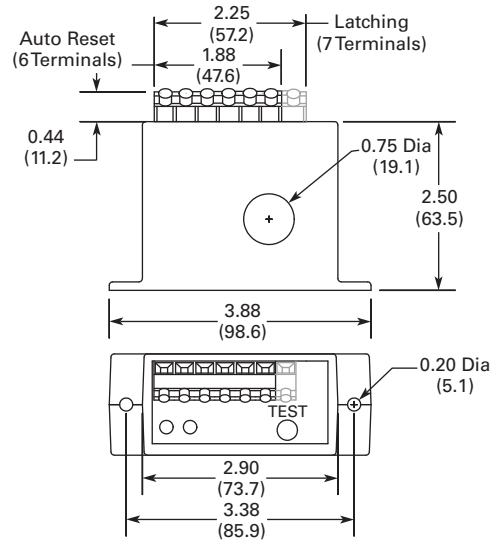

EGFL Series CurrentWatch Current Sensors



7

EGFL Series CurrentWatch Current Sensors

Product Description

The CurrentWatch EGFL Series from Eaton's Electrical Sector is a family of ground fault (earth leakage) sensors. Ground fault sensors help protect people, products and processes from damage by ground fault conditions by monitoring all current-carrying conductors in grounded single- and three-phase delta or wye systems. For more information, see "Zero Sequence" Operating Principle on this page. The EGFL Series is available with either solid-state or mechanical relay outputs.

The EGFL Series with mechanical relays are available in solid-core housings with a choice of NO or NC SPST latching relays and a SPDT Form C relay with auto-reset. All mechanical models can be ordered with a fixed setpoint or with a "tri-set" option, which provides three factory-set, field adjustable setpoints.

Application Description

Typical Applications

- Personnel Protection (Typically 5 mA)**—Detects sensitive ground fault conditions, which could cause injury to people, and functions as a sensor and alarm trigger when part of an overall ground fault protection system
- Equipment Protection (Typically 10 or 30 mA)**—For applications where personnel protection is not the primary concern, higher setpoint capability helps eliminate nuisance tripping while still providing adequate ground fault detection to protect machine electronics
- Regulatory**—Meets requirements as stipulated by governmental and industrial regulatory groups for ground fault sensing

Contents

Description

	<i>Page</i>
EGFL Series CurrentWatch Current Sensors	
Features	V8-T7-43
Standards and Certifications	V8-T7-38
Product Selection	V8-T7-43
Technical Data and Specifications	V8-T7-43
Wiring Diagrams	V8-T7-44
Dimensions	V8-T7-44

Example Application—Insulation Breakdown Monitoring

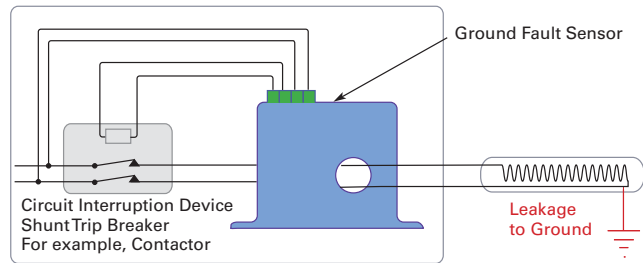

"Zero Sequence" Operating Principle

In three-phase delta and wye systems, under normal conditions, current in the "hot" leg of a two-wire load is equal in magnitude but opposite in sign to the current in a neutral leg. As a result, the electromagnetic fields surrounding these two conductors cancel, producing a "zero sum current." As

soon as current leaks to ground (fault condition), the two currents become imbalanced and a net magnetic field results. The CurrentWatch EGFL Series sensors monitor this field and trip alarm contacts when the leakage rises above the setpoint.

For the most current information on this product, visit our Web site: www.eaton.com

For Customer Service in the U.S. call 1-877-ETN CARE (386-2273), in Canada call 1-800-268-3578.

For Application Assistance in the U.S. and Canada call 1-800-426-9184.

Features

- **Broad Range of Options to Meet Application Needs**—Mechanical relays, normally energized or normally de-energized contacts
- **Setpoint Options Maximize Ease-of-Use and Application Flexibility**—Field selectable 5, 10 or 30 mA setpoints on the EGFL “tri-set” models make user adjustments fast, sure and convenient
- **Compatible with Standard Equipment**—Application on single- and three-phase systems, ideal for use with shunt trip breakers, and magnetically isolated from monitored circuit and control power
- **Agency Approved**—UL and CE Certified, accepted worldwide

Standards and Certifications

- UL Approved
- UL 1053, Class 1 Recognized
- CE
- cULus



DANGER

THIS SENSOR IS NOT A SAFETY DEVICE AND IS NOT INTENDED TO BE USED AS A SAFETY DEVICE. This sensor is designed only to detect and read certain data in an electronic manner and perform no use apart from that, specifically no safety-related use. This sensor product does not include self-checking redundant circuitry, and the failure of this sensor product could cause either an energized or de-energized output condition, which could result in death, serious bodily injury, or property damage.

Product Selection

EGFL Series CurrentWatch Current Sensors

Mechanical Relay Sensors

	Power Supply	Setpoint	Output Type	Contacts	Catalog Number
Solid-Core Housing 	Solid-Core Housings				
	120 Vac	Tri-set adjustable, 5, 10 or 30 mA	Mechanical relay, NO SPST relay, Form A	Latching relay	EGFL1NOLAT3
			Mechanical relay, NC SPST relay, Form B	Latching relay	EGFL1NCLAT3
			Mechanical relay, SPDT Form C, auto-reset	Normally energized	EGFL1SPDTNET3
	Normally de-energized	EGFL1SPDDET3			
	24 Vac/dc	Tri-set adjustable, 5, 10 or 30 mA	Mechanical relay, NO SPST relay, Form A	Latching relay	EGFL2NOLAT3
Mechanical relay, NC SPST relay, Form B			Latching relay	EGFL2NCLAT3	
Mechanical relay, SPDT Form C, auto-reset			Normally energized	EGFL2SPDTNET3	
	Normally de-energized	EGFL2SPDDET3			

Technical Data and Specifications

EGFL Series CurrentWatch Current Sensors

Description	Specifications
Power supply	120 Vac (55–110% of nominal voltage) 24 Vac/dc (± 20%)
Output signal	Mechanical relay
Output rating	Auto reset models, SPDT relay: 1A at 125 Vac; 2A at 30 Vdc Latching models, SPST relay: 1A at 125 Vac; 2A at 30 Vdc
OFF-state leakage	None
Response time	200 ms at 5% above trip point 60 ms at 50% above trip point 15 ms at 500% above trip point
Frequency range	50–400 Hz (monitored circuit)
Loading	2VA max.
Isolation voltage	5000 Vac (tested)
Sensing aperture	1.83 in (46.5 mm) diameter
LED indicator	Green LED for power ON status Red LED for contact status
Housing	UL94 V0 flammability rated
Environmental	Operating temperature: –4° to +122°F (–20° to +50°C) Humidity: 0–95% RH, non-condensing

7.11

Current and Voltage Sensors

CurrentWatch EGFL Series

Output Tables

Protection from faults and control power loss.

Normally Energized Models

	No Power	Control Power Applied	
		No Fault	Fault
Normally open models	Open	Closed	Open
Normally closed models	Closed	Open	Closed

Normally De-Energized Models

	No Power	Control Power Applied	
		No Fault	Fault
Normally open models	Open	Open	Closed
Normally closed models	Closed	Closed	Open

Wiring Diagrams

General Wiring Diagram for Ground Fault Sensors

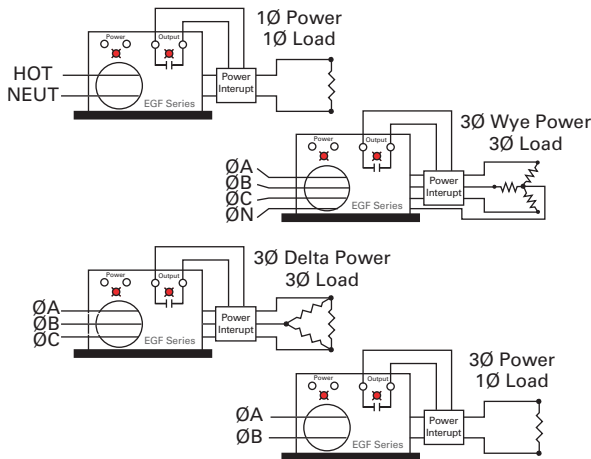

Latching Models

Latching models power up initially in the rest (normal) mode. If there is a fault condition or the test button is pushed, the output contacts will change state and latch. The output will remain latched regardless of whether the fault is cleared or control power is removed. To reset the output, apply a momentary contact across "reset" terminals.

Latching Models

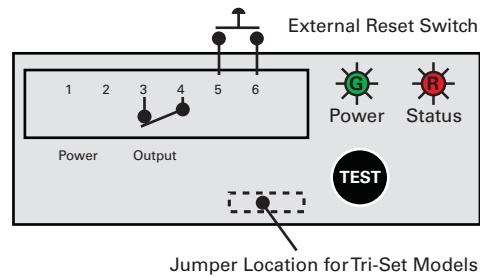

Auto Reset Models

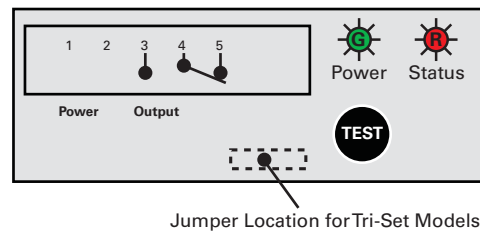

Dimensions

Approximate Dimensions in Inches (mm)

Mechanical Relay Models

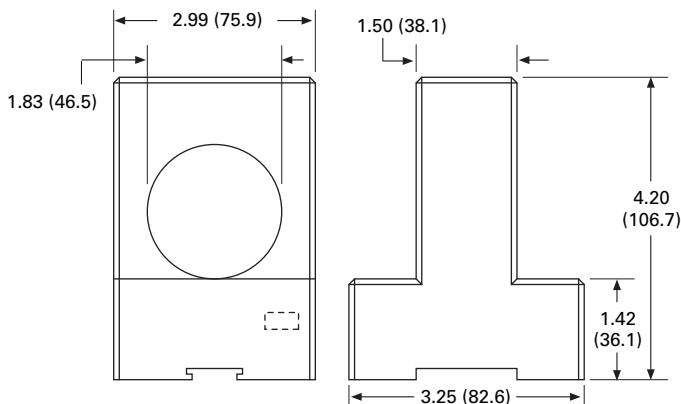

Retroreflectors



Sensor Mounting Brackets



Sensor Accessory—AC Sensor Tester/Demonstrator



Pilot Device—E65 Control Unit



8.1	Retroreflectors and Retroreflective Tape	
	Product Description	V8-T8-2
	Application Description	V8-T8-2
	Product Selection	V8-T8-3
	Dimensions	V8-T8-4
8.2	Sensor Mounting Brackets	
	Product Description	V8-T8-5
	Product Selection Guide	V8-T8-5
	Product Selection	V8-T8-6
	Dimensions	V8-T8-8
8.3	Sensor Accessories	
	Product Description	V8-T8-10
	Product Selection	V8-T8-10
	Dimensions	V8-T8-12
8.4	Pilot Devices	
	Product Description	V8-T8-13
	Product Selection	V8-T8-13
	Technical Data and Specifications	V8-T8-14
	Wiring Diagrams	V8-T8-14
	Dimensions	V8-T8-14



Unless otherwise noted, the products contained in this section should not be used for functional safety applications. These products were not designed or tested to IEC 60947-5-3 or recommended for functional safety.



Learn
Online

For Customer Service in the U.S. call 1-877-ETN CARE (386-2273),
in Canada call 1-800-268-3578.
For Application Assistance in the U.S. and Canada
call 1-800-426-9184.

Retroreflectors and Retroreflective Tape



Contents

Description

Page

Retroreflectors and Retroreflective Tape	
Product Selection	
Retroreflectors	V8-T8-3
Retroreflective Tape	V8-T8-3
Dimensions	V8-T8-4

Retroreflectors and Retroreflective Tape

Product Description

Retroreflectors from Eaton's Electrical Sector are used with reflex-type sensors. Two types of retroreflective target material are available: corner cube and embedded glass bead.

Application Description

Corner Cube Retroreflectors

This type provides the highest signal return to the sensor, typically 2000 to 3000 times the reflectivity of white paper. Three adjoining sides are arranged at right angles to each other. When a ray of light strikes one of these sides (A), it is reflected to the second (B), then the third (C), and then back to the source parallel to its original course. Thousands of these cube shapes are molded into a rugged plastic reflector or vinyl tape material. Corner cube retroreflectors are suitable for use with both standard reflex and polarized reflex sensors.

Corner Cube

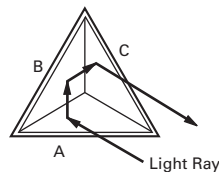

Retroreflector Size

The size of the retroreflective target has a significant effect on the excess gain and range of a reflex sensor. In general, we recommend you use the largest possible reflector in every reflex sensing application to maximize performance of the sensor and simplify alignment. To provide an even larger reflective area, multiple retroreflectors can be grouped together as shown.

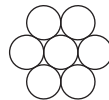

7 Retroreflectors Grouped Together

Using Retroreflectors with Polarized Reflex Sensors

Only corner cube retroreflective material can be used with polarized reflex sensors. When polarized light from the sensor's light source strikes a corner cube retroreflector, it is returned to the sensor in a depolarized state. This allows some of the light to pass through the detector's polarizer, which is positioned at 90° to the source polarizer, to allow the sensor to operate.

Glass bead retroreflectors do not depolarize light and will not work with polarized reflex sensors.

Molded plastic corner cube retroreflectors are always recommended as they provide the highest signal return to the sensor.

Corner cube tape works with polarized reflex sensors but returns less light to the sensor. In all cases, Eaton recommends testing sensor and tape prior to final installation.

For the most current information on this product, visit our Web site: www.eaton.com

For Customer Service in the U.S. call 1-877-ETN CARE (386-2273), in Canada call 1-800-268-3578. For Application Assistance in the U.S. and Canada call 1-800-426-9184.

Product Selection

Retroreflectors

6200A-6507



Corner Cube Retroreflector

Description	Catalog Number
1.5 x 3.25 in, adhesive backed, one per package	6200A-6507

Round Retroreflectors

6200A-6501



Description	Catalog Number
3 in diameter, with mounting hole, two per package	6200A-6501

Bulk packaged version of above (ordered quantity will be bulk packaged)	6200AS6501
---	------------

3 in diameter, with mounting hole, one per package	E51KR84
--	---------

6200A-6506



3 in diameter, metal backed, with mounting hole, one per package	6200A-6506
--	------------

6200A-6505



2.18 in diameter, with mounting hole, one per package	6200A-6505
---	------------

6200A-6502



2.18 in diameter, adhesive backed, one per package	6200A-6502
--	------------

6200A-6504



1.25 in diameter, adhesive backed, one per package	6200A-6504
--	------------

Bulk packaged version of above (ordered quantity will be sent bulk packaged)	6200AS6504
--	------------

1.25 in diameter, no adhesive, one per package	E51KR32
--	---------

Retroreflective Tape

6202A-XXXX

Corner Cube Style ^①

Description	Catalog Number
2 in wide, 1 piece, quantity is length in feet	6202A-XXXX

Note

^① Although corner cube tape works with polarized reflex sensors, we recommend testing sensor and tape prior to installation.

Dimensions

Approximate Dimensions in Inches (mm)

Round Retroreflectors

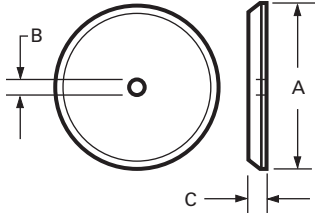

Catalog Number	Diameter A	Hole Size B	Thickness C
6200A-6501	3.30 (84)	0.20 (5)	0.35 (9)
6200A-6502	2.40 (61)	None	0.30 (7.5)
6200A-6504	1.30 (33)	None	0.25 (6)
6200A-6505	2.40 (61)	0.25 (6)	0.30 (7.5)
6200A-6506	3.30 (84)	0.20 (5)	0.30 (7.5)
E51KR32	1.25 (32)	None	0.35 (9)
E51KR84	3.30 (84)	0.20 (5)	0.35 (9)

Sensor Mounting Brackets**Contents****Description****Page**

Sensor Mounting Brackets

Product Selection

V8-T8-6

Dimensions

V8-T8-8**Sensor Mounting Brackets****Product Description**

Mounting brackets by Eaton's Electrical Sector found in this section are suited for use with 8 mm to 30 mm diameter tubular sensors only. Mounting brackets designed to specifically fit other types of sensors are found in the respective "Accessories" sections for those sensor families.

Product Selection Guide

When choosing a bracket, consider:

- **Adjustability**—Do you need minimal alignment capability (mounting an inductive proximity sensor), or a high level of alignment precision (mounting a long range photoelectric thru-beam sensor)?
- **Material of Construction**—This can be dictated by the sensing environment or the type of sensor you are using

For the most current information on this product, visit our Web site: www.eaton.com

For Customer Service in the U.S. call 1-877-ETN CARE (386-2273),
in Canada call 1-800-268-3578.
For Application Assistance in the U.S. and Canada
call 1-800-426-9184.

Product Selection

Sensor Mounting Brackets

Mounting Brackets for Tubular Sensors





	Description	Size	Catalog Number	
L-Shaped Bracket 	L-Shaped Bracket—E57KM_			
	Adjustability:	Allows some adjustment in two axes	8 mm	E57KM8
	Sensor mounting:	Sensor mounts with two jam nuts and washers ①	12 mm	E57KM12
	Material of construction:	Stainless steel	18 mm	E57KM18
	Packaging:	One per package	30 mm	E57KM30
L-Shaped Bracket 	L-Shaped Bracket—6161A_			
	Adjustability:	Allows some adjustment in one axis and allows for aiming of the sensor through a short arc	18 mm	6161A-6501
	Sensor mounting:	Sensor mounts with two jam nuts and washers ①		
	Material of construction:	Aluminum with chromate finish		
L-Shaped Bracket 	Packaging:	Two per package		
	Packaging:	Same as 6161A-6501 (above), except: Bulk packaged (ordered quantity will be sent bulk packed)	18 mm	6161AS6501
L-Shaped Bracket 	L-Shaped Bracket—6167A			
	Adjustability:	Allows a minimum range. Suitable for 30 mm sensors.	30 mm	6167A-6501
	Sensor mounting:	Allows some adjustment in one axis		
	Material of construction:	Sensor mounts with two jam nuts ①		
	Packaging:	Zinc dichromate One per package		
L-Shaped Bracket with Slot 	L-Shaped Bracket with Slot ②			
	Adjustability:	Allows some adjustment in one axis and allows for aiming of the sensor through a short arc	18 mm	6161AS7050
	Sensor mounting:	Sensor mounts with two jam nuts and washers ①		
	Material of construction:	Aluminum with chromate finish		
	Packaging:	Bulk packaged (ordered quantity will be sent bulk packed)		
Flat Bracket 	Flat Bracket			
	Adjustability:	Allows some adjustment in one axis and allows for aiming of the sensor through a short arc	18 mm	6161AS5295
	Sensor mounting:	Sensor mounts with two jam nuts and washers ①		
	Material of construction:	Aluminum with chromate finish		
	Packaging:	Bulk packaged (ordered quantity will be sent bulk packed)		
Adjustable Bracket 	Adjustable Bracket—E58KAM18_ ③			
	Adjustability:	Locking vertical and horizontal adjustments for independent adjustments in each axis	18 mm	E58KAM18
	Sensor mounting:	Sensor mounts with two jam nuts and washers ①		
	Material of construction:	304 stainless steel		
	Packaging:	One per package		
		Same as E58KAM18 , except not electrically isolated from mounting surface	18 mm	E58KAM18U

Dimensions, see **Page V8-T8-8**.

Notes

- ① Included with sensor.
- ② Allows installation of sensor with jam nuts already in place on sensor body, (Comet® and Prism™ sensors only).
- ③ Sensor is electrically isolated from mounting surface.

Mounting Brackets for Tubular Sensors, continued

	Description	Size	Catalog Number
Adjustable Bracket 	Adjustable Bracket—E58KAM30_ ^①		
	Adjustability: Locking vertical and horizontal adjustments for independent adjustment in each axis	30 mm	E58KAM30
	Sensor mounting: Sensor mounts with two jam nuts ^②		
	Material of construction: 304 stainless steel		
	Packaging: One per package		
	Same as E58KAM30 , except not electrically isolated from mounting surface.	30 mm	E58KAM30U
18 mm Ball Swivel Bracket 	18 mm Ball Swivel Bracket		
	Adjustability: Allows 360° rotation and 10° vertical tilt	18 mm	E58KAM18B
	Sensor mounting: Mounts directly to any 18 mm threaded sensor		
	Material of construction: 5% glass filled Valox [®]		
	Packaging: One per package		
Metal Ball Swivel Mount 	Metal Ball Swivel Mount ^③		
	Adjustability: Allows 5.5° rotation with screw lock to fix final position	0.75 in (18 mm)	6168A-6501
	Sensor mounting: Mounts directly to any 18 mm tubular sensor		
	Material of construction: Extremely rugged, made from zinc plated steel/Celenex [®]		
	Packaging: One per package		
Plastic Ball Swivel Mount 	Plastic Ball Swivel Mount—6143A		
	Adjustability: Allows 10° rotation on X and Y axes with a clamping action to hold adjustment	0.375 in (8 mm)	6143A-6501
	Sensor mounting: Mounts directly to any 8 mm tubular sensor		
	Material of construction: Noryl ^④		
	Operating temperature: -40° to 160°F (-40° to 71°C)		
	Packaging: One per package		
Plastic Ball Swivel Mount 	Plastic Ball Swivel Mount—6142A		
	Same as 6143A-6501 (above), except:	0.75 in (18 mm)	6142A-6501
	Sensor mounting: Mounts directly to any 18 mm tubular sensor		
Cushioned Sensor Mounts 	Cushioned Sensor Mounts		
	Precision machined, spring-loaded sleeves that hold tubular sensors to protect them from accidental impact due to overtravel of the target being sensed.	8 mm	E57KNZ8
		12 mm	E57KNZ12
	Used for inductive proximity sensors only.	18 mm	E57KNZ18
		30 mm	E57KNZ30

Dimensions, see **Page V8-T8-8**.

Notes

- ① Sensor is electrically isolated from mounting surface.
- ② Included with sensor.
- ③ Electrically isolates the sensor to prevent noise pick-up caused by poor grounding.
- ④ Avoid exposing to chlorinated halogenated or aromatic hydrocarbons.

Dimensions

Approximate Dimensions in Inches (mm)

Sensor Mounting Brackets for Tubular Sensors

L-Shaped Bracket—E57KM

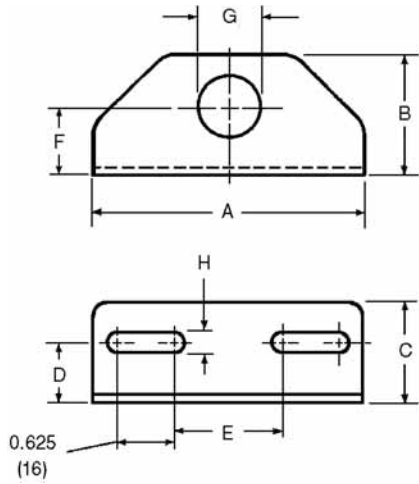

Size	A	B	C	D
8 mm	3.00 (76)	1.35 (34)	1.125 (29)	0.65 (17)
12 mm	3.00 (76)	1.35 (34)	1.125 (29)	0.65 (17)
18 mm	3.00 (76)	1.35 (34)	1.125 (29)	0.65 (17)
30 mm	4.25 (108)	2.15 (55)	1.75 (45)	1.00 (25)

	E	F	G	H
8 mm	1.20 (31)	0.75 (19)	0.323 (8)	0.218 (6)
12 mm	1.20 (31)	0.75 (19)	0.484 (12)	0.218 (6)
18 mm	1.20 (31)	0.75 (19)	0.718 (18)	0.218 (6)
30 mm	2.00 (51)	1.25 (29)	1.203 (30)	0.281 (7)

L-Shaped Bracket—6161A

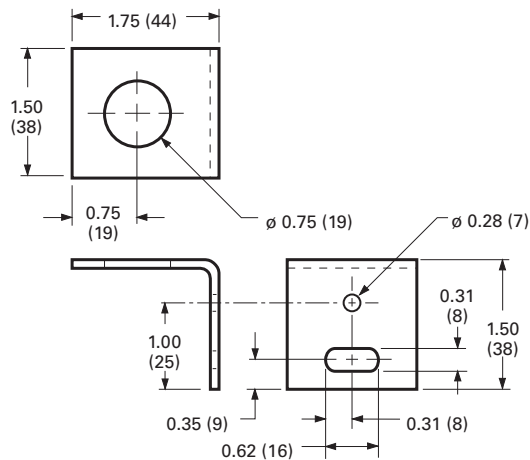

L-Shaped Bracket—6167A

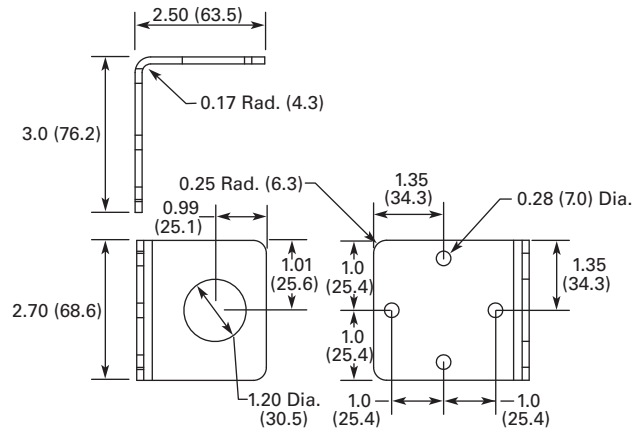

L-Shaped Bracket with Slot

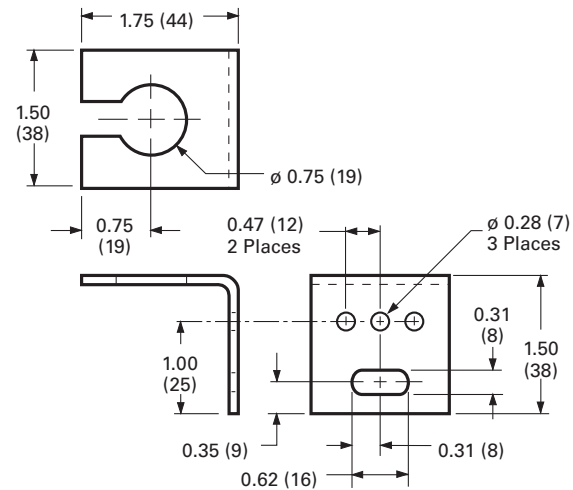

Flat Bracket

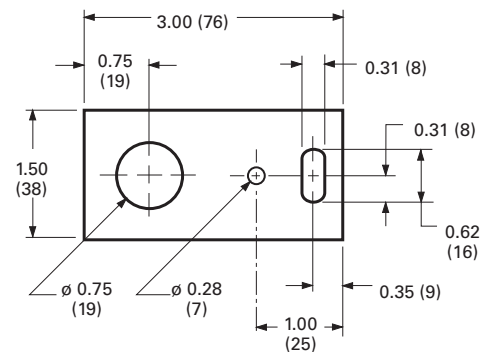

Approximate Dimensions in Inches (mm)

Adjustable Bracket—E58KAM18

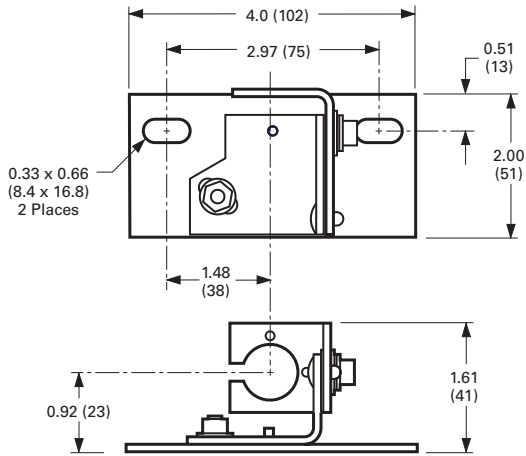

Adjustable Bracket—E58KAM30

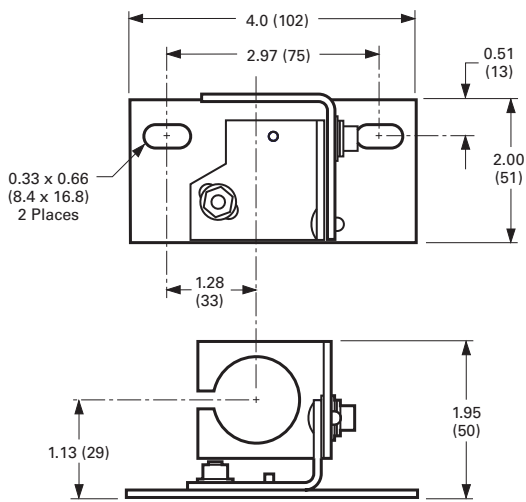

18 mm Ball Swivel Bracket

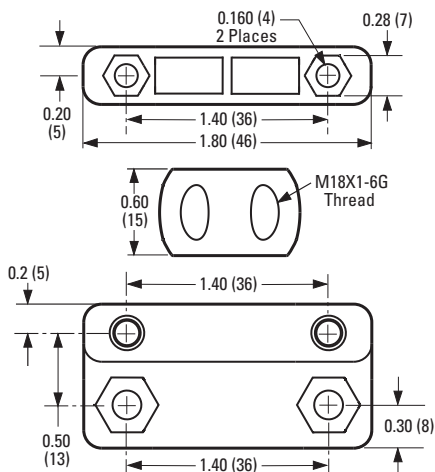

Metal Ball Swivel Mount

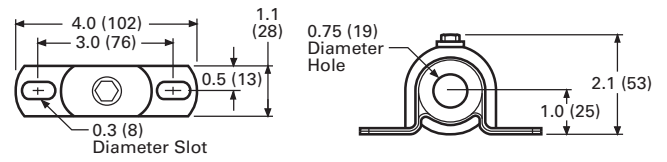

Plastic Ball Swivel Mount

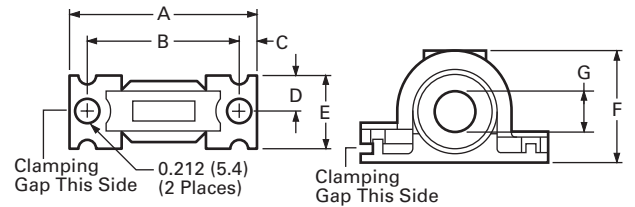

Size	A	B	C	D
8 mm	1.96 (49.8)	1.56 (39.6)	0.20 (5.1)	0.40 (10.2)
18 mm	2.80 (71.1)	2.25 (57.2)	0.275 (7.0)	0.50 (12.7)

	E	F	G
8 mm	0.80 (20.3)	1.05 (26.7)	0.375 (9.5)
18 mm	1.00 (25.4)	1.64 (41.7)	0.75 (19.1)

Cushioned Sensor Mounts

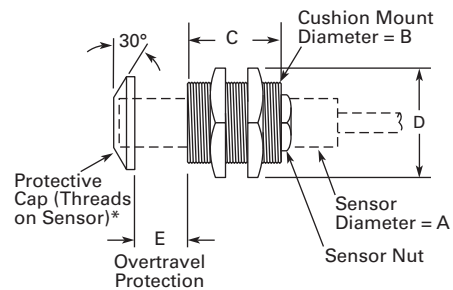

Size	A	B	C	D	E
8 mm	M8 x 1	M16 x 1.5	0.87 (22)	0.87 (22)	0.35 (9)
12 mm	M12 x 1	M22 x 1.5	0.87 (22)	1.12 (29)	0.41 (10)
18 mm	M18 x 1	M30 x 1.5	1.17 (30)	1.41 (36)	0.49 (12)
30 mm	M30 x 1.5	M47 x 1.5	1.47 (37)	1.72 (51)	0.57 (15)

Note

① Sensing range will be reduced by thickness of cap's wear surface: 0.030 in (0.76 mm) maximum.

Sensor Accessories



8

Contents

Description

<i>Description</i>	<i>Page</i>
Sensor Accessories	
Product Selection	V8-T8-10
Dimensions	V8-T8-12

Sensor Accessories



Product Description

Accessories from Eaton's Electrical Sector include portable power supplies for testing or demonstrating DC sensors, a variety of

replacement mounting nuts, protective end caps for tubular proximity sensors, and conduit adapters for tubular sensors.

Product Selection

Sensor Accessories

Description	Catalog Number
DC Sensor Tester/Demonstrator  <p>For two-, three- and four-wire DC sensors Provides 27 Vdc power from three 9V batteries (included) Test output connections for both NPN and PNP outputs</p>	9902A-6501
AC Sensor Tester/Demonstrator  <p>For AC sensors Provides AC power from wall mount Includes AC adapter</p>	9902A-6502
Dimensions, see Page V8-T8-12.	

For the most current information on this product, visit our Web site: www.eaton.com

For Customer Service in the U.S. call 1-877-ETN CARE (386-2273), in Canada call 1-800-268-3578. For Application Assistance in the U.S. and Canada call 1-800-426-9184.

Sensor Accessories, continued

	Description	Sensor Diameter	Catalog Number
Mounting Nut, E57KN_ 	Replacement Mounting Nuts—Stainless Steel, E57KN_ Where used: Harsh environment for tubular sensors Material of construction: Stainless steel Packaging: Two per package	8 mm 12 mm 18 mm 30 mm	E57KNM8 E57KNS12 E57KNS18 E57KNS30
Mounting Nut, E60KN18 	Replacement Mounting Nuts—Brass Where used: General purpose for tubular sensors ① Material of construction: Brass Packaging: Two nuts and two wave washers per package	18 mm	E60KNS18
Mounting Nut, E58KN_ 	Replacement Mounting Nuts—Stainless Steel, E58KN_ Where used: Harsh environment for tubular sensors Material of construction: Stainless steel Packaging: Two per package	18 mm 30 mm	E58KNS18 E58KNS30
Mounting Nut, E57KNC18 	Replacement Mounting Nuts—Plastic Where used: Harsh environment for tubular and SM series sensors Material of construction: Plastic Packaging: Two per package	18 mm	E57KNC18
Protective Cap, E57KP_ 	Protective Caps—E57KP_ Where used: Tubular Proximity Sensors Material of construction: Delrin Packaging: One per package	12 mm 18 mm 30 mm	E57KP12 E57KP18 E57KP30
Conduit Adapter, E57KC_ 	Conduit Adapters—E57KC_ Where used: To attach electrical conduit to rear of tubular sensors Material of construction: Die cast steel Packaging: One adapter and nut per package	8 mm 12 mm 18 mm 30 mm	E57KC8 E57KC12 E57KC18 E57KC30
Conduit Adapter, E58KC30 	Conduit Adapters—E58KC30 Where used: To attach E58 harsh duty 30 mm sensors to half-inch conduit fittings Material of construction: Stainless steel Packaging: One per package	30 mm	E58KC30
Dimensions, see Page V8-T8-12.			

Note

① These are the standard mounting nuts shipped with the Comet, Prism and OEM Prism photoelectric sensors.

Dimensions

Approximate Dimensions in Inches (mm)

DC Sensor Tester/Demonstrator

W	H	D
2.5 (65)	4.75 (120)	2.1 (55)

AC Sensor Tester/Demonstrator

W	H	D
2.5 (65)	4.5 (114)	1.5 (38)

8 Replacement Mounting Nuts—Stainless Steel and Brass

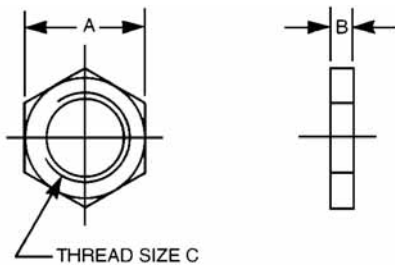

Size	A	B	C
8 mm	0.5 (13)	0.16 (4)	M8 x 1
12 mm	0.7 (17)	0.16 (4)	M12 x 1
18 mm	0.94 (24)	0.16 (4)	M18 x 1
30 mm	1.4 (36)	0.16 (4)	M30 x 1.5

Replacement Mounting Nuts—Plastic

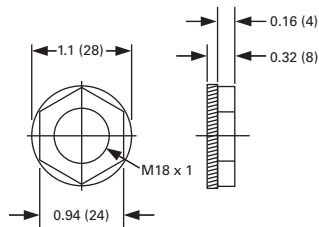

Protective Caps

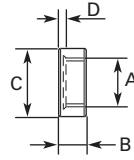

Size	Switch Size			Thickness D
	A	B	C	
12 mm	0.47 (12)	0.39 (10)	0.63 (16)	0.04 (1.0)
18 mm	0.71 (18)	0.36 (9.2)	0.83 (21.2)	0.04 (0.9)
30 mm	1.18 (30)	0.59 (15)	1.42 (36)	0.07 (1.7)

Conduit Adapters—E57KC_

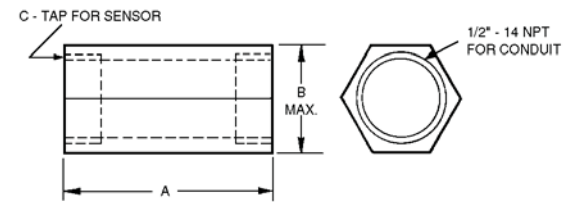

Size	Length A	Hex B	Tap C
8 mm	1.0 (25)	1.0 (25)	M8 x 1
12 mm	1.5 (38)	1.0 (25)	M12 x 1
18 mm	1.5 (38)	1.0 (25)	M18 x 1
30 mm	1.9 (48)	1.5 (38)	M30 x 1.5

Conduit Adapters—E58KC30

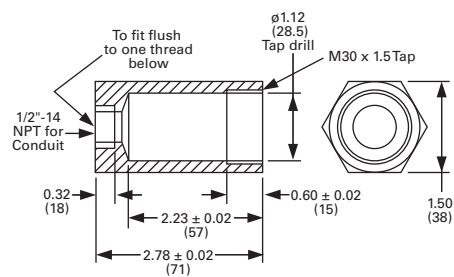

Pilot Devices



Contents

Description

Description	Page
Pilot Devices	
Product Selection	V8-T8-13
Technical Data and Specifications	V8-T8-14
Wiring Diagrams	V8-T8-14
Dimensions	V8-T8-14

Pilot Devices

Product Description

Type E65 control units from Eaton's Electrical Sector are designed for use with amplifier built-in sensors to provide an SPDT relay contact output (in addition to the solid-state output of the sensor), and to convert an

AC input voltage to stable 12 Vdc, permitting operation of a DC sensor from an AC input. Use only with NPN output sensors. A switch is provided in the output circuit for selecting either light or dark sense operation. These

control units are available with or without a selectable ON-delay, OFF-delay or one-shot timer having an adjustable timing range of 0.1 to 5 seconds. A red LED indicator glows when the output relay is energized.

Product Selection

E65 Control Unit



E65 Control Units

Voltage	Output Configuration	Features	Catalog Number
110 to 120V/220 to 240 Vac ± 10%, 50/50 Hz	Selectable light or dark sense	SPDT relay contact output	With external synchronization
			With delay timer ①
			Without delay timer
			E65PS

Note

① Selectable for ON-delay, OFF-delay or ONE-SHOT operation with an adjustable timing range of 0.1 to 5 seconds.

For the most current information on this product, visit our Web site: www.eaton.com

For Customer Service in the U.S. call 1-877-ETN CARE (386-2273), in Canada call 1-800-268-3578. For Application Assistance in the U.S. and Canada call 1-800-426-9184.

Technical Data and Specifications

Pilot Devices

Description	Specification
Input voltage	110 to 120V/220 to 240 Vac ± 10%, 50/60 Hz
Temperature range	14° to 122°F (-10° to 50°C)
Relative humidity	Less than 85%
Response time	Less than 20 ms
Output voltage	12 Vdc ± 10%, 100 mA maximum
Short-circuit and polarity protection	Incorporated
Power consumption	Less than 8 VA
Terminal connections	Screw and saddle clamp to accept 14 AWG wire
Output	SPDT relay contact rated 3A resistive at 250 Vac

Wiring Diagrams

Pin numbers are for reference, rely on pin location when wiring.

Output Circuits and Connections

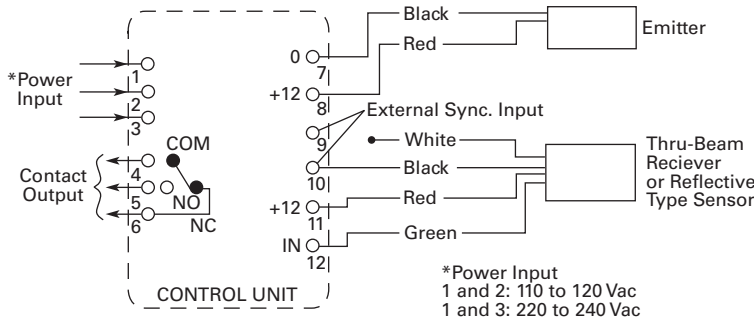

Relay Contact Output

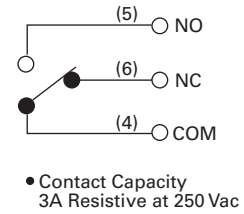

Dimensions

Approximate Dimensions in Inches (mm)

Control Unit

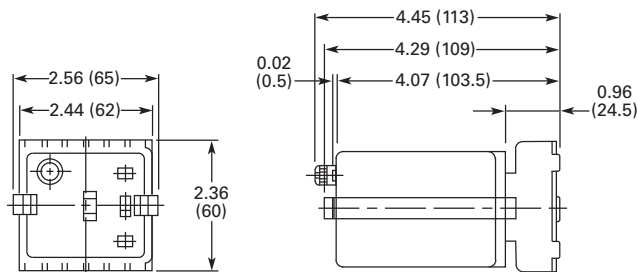

Socket with Terminals

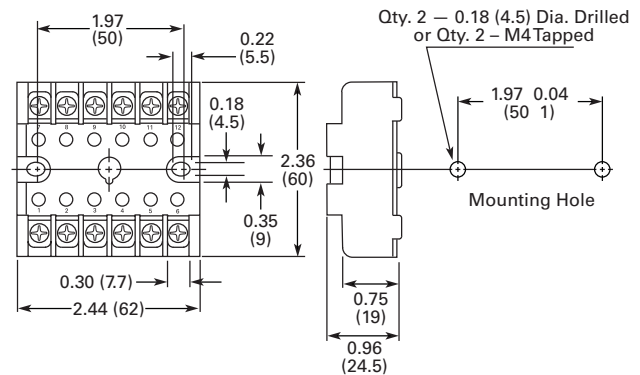

Plastic Fiber Optic Cables



Glass Fiber Optic Cables



9.1 Plastic Fiber Optic Cables

Product Description	V8-T9-2
Features	V8-T9-2
Product Selection	V8-T9-3
Accessories	V8-T9-4
Technical Data and Specifications	V8-T9-4
Dimensions	V8-T9-5

9.2 Glass Fiber Optic Cables

Product Description	V8-T9-7
Features	V8-T9-7
Product Overview	V8-T9-8
Product Selection	V8-T9-9
Accessories	V8-T9-11
Technical Data and Specifications	V8-T9-11
Dimensions	V8-T9-12



Unless otherwise noted, the products contained in this section should not be used for functional safety applications. These products were not designed or tested to IEC 60947-5-3 or recommended for functional safety.



For Customer Service in the U.S. call 1-877-ETN CARE (386-2273),
in Canada call 1-800-268-3578.
For Application Assistance in the U.S. and Canada
call 1-800-426-9184.

Plastic Fiber Optic Cables



Contents

Description

	<i>Page</i>
Plastic Fiber Optic Cables	
Product Selection	V8-T9-3
Accessories	V8-T9-4
Technical Data and Specifications	V8-T9-4
Dimensions	V8-T9-5

Plastic Fiber Optic Cables

Product Description

Plastic Fiber Optic Cables from Eaton’s electrical sector offer a lower-cost alternative to glass fibers. They are available as bulk cable or pre-assembled with sensing tips.

Bulk fiber optic cable is ordered by the foot and can be cut to length by the user with a special cutter accessory. It can be used with lenses, adapters and terminations. Single fiber is normally used for thru-beam sensing and duplex fiber (two isolated cables running in parallel) for diffuse reflective. Order single fiber cable for both source and detector cable runs. Order duplex fiber cable equal to the length of run—separate source and detector cable not required.

Pre-assembled fiber optic cables are special purpose cables to solve a variety of fiber optic sensing applications. A fiber optic cable cutter is included only for 1 mm bundle models. The cables are available in 1 mm and 0.5 mm diameters (0.5 mm cables cannot be cut to length). Single cable is used for thru-beam sensing, duplex for diffuse reflective sensing.

Features

- Fiber optic cables allow remote sensing in areas where space is restricted or tight viewing angles are required
- The economical plastic cable is easy to cut to length during installation for a perfect fit (see cutter accessory, 0.5 mm cable cannot be cut)
- Single cable styles are ideal for thru-beam sensing
- Duplex cable styles are typically used for diffuse reflective sensing
- Pre-assembled cables are available in 0.5 mm for sensing extremely small targets

DANGER

THIS SENSOR IS NOT A SAFETY DEVICE AND IS NOT INTENDED TO BE USED AS A SAFETY DEVICE. This sensor is designed only to detect and read certain data in an electronic manner and perform no use apart from that, specifically no safety-related use. This sensor product does not include self-checking redundant circuitry, and the failure of this sensor product could cause either an energized or de-energized output condition, which could result in death, serious bodily injury, or property damage.

For the most current information on this product, visit our Web site: www.eaton.com

For Customer Service in the U.S. call 1-877-ETN CARE (386-2273), in Canada call 1-800-268-3578.
For Application Assistance in the U.S. and Canada call 1-800-426-9184.

Product Selection

Bulk Fiber Optic Cable

Bulk Fiber Optic Cable

	Fiber Diameter	Cable Style	Catalog Number ^①
Bulk Fiber Optic Cable 	0.039 in (1 mm)	Duplex cable (for diffuse reflective sensing)	6324A-XXX
		Single cable (for thru-beam sensing)	6323A-XXX

Accessories, see Page V8-T9-4.

Pre-Assembled Fiber Optic Cables

Pre-Assembled Duplex Fiber Optic Cables (for Diffuse Reflective Sensing)

	Fiber Diameter	Catalog Number ^②
Large Diameter, Threaded Tip 	0.039 in (1.0 mm)	6324A-6501
	0.059 in (1.5 mm)	6324E-6501 ^③
Small Diameter, Threaded Tip 	0.020 in (0.5 mm)	6324A-6511
Large Diameter, Bendable Probe 	0.039 in (1.0 mm)	6324A-6502
	0.020 in (0.5 mm)	6324A-6512

Dimensions, see Page V8-T9-5.

Pre-Assembled Single Fiber Optic Cables (for Thru-Beam Sensing)

	Fiber Diameter	Catalog Number ^④
Large Diameter, Threaded Tip 	0.039 in (1.0 mm)	6323A-6501
	0.059 in (1.5 mm)	6323E-6501 ^③
Small Diameter, Threaded Tip 	0.020 in (0.5 mm)	6323A-6511
Large Diameter, Bendable Probe 	0.039 in (1.0 mm)	6323A-6502
	0.020 in (0.5 mm)	6323A-6512

Dimensions, see Page V8-T9-5.

Notes

- ① Quantity ordered indicates length, for example, a quantity of 5 equals five feet of fiber.
- ② One cable.
- ③ Larger diameter (1.5 mm) fibers provide approximately 50% longer sensing range than small diameter (1 mm).
- ④ Set of two.

Accessories

Cable Accessories

Bulk Fiber Optic Cable Accessories

Description	Range Increase	Catalog Number
Fiber Optic Cable Cutter		
For 1 mm diameter fiber, good for six cuts	—	8909A-6501
Fiber Optic Termination		
For mounting of 1 mm diameter bulk fiber. Sensing distance is the same as for bare fibers without lenses	—	6230A-6503

Dimensions, see Page V8-T9-6.



9

Lenses

For 1 mm diameter bulk cable only. Lenses extend the range of thru-beam sensors. Sold individually—two required for thru-beam sensing.

Lenses

Description	Range Increase	Catalog Number
Thru-Beam Lenses		
0.25 In Diameter Thru-Beam Lens	10X	6230A-6505
0.25 in diameter thru-beam lens		
0.5 In Diameter Thru-Beam Lens	100X	6230A-6509
0.5 in diameter thru-beam lens		
1.0 In Diameter Thru-Beam Lens	200X	6230A-6508
1.0 in diameter thru-beam lens		

Dimensions, see Page V8-T9-6.



Technical Data and Specifications

Plastic Fiber Optic Cables

Description	Specification
Storage and operating temperature	−22° to 158°F (−30° to 70°C)
Length, pre-assembled cables	6.6 ft (2m)
Sheathing	Polyethylene
Bend radius ^①	1 mm fiber: 2 in; 0.5 mm fiber: 1 in with no loss of optical signal. Tighter bends will result in some signal loss.

Note

^① **IMPORTANT:** Do not bend fibers within 0.5 in of either end.

Dimensions

Approximate Dimensions in Inches (mm)

Pre-Assembled Duplex Fiber Optic Cables (for Diffuse Reflective Sensing)

Large Diameter, Threaded Tip

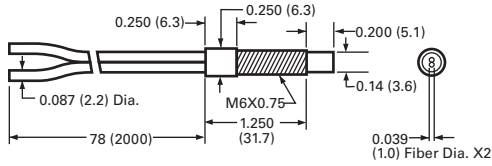

Large Diameter, Threaded Tip with Bendable Probe

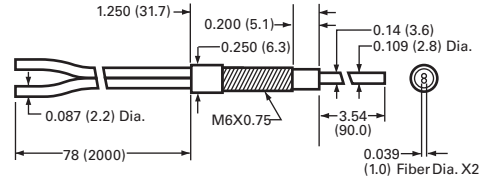

Small Diameter, Threaded Tip

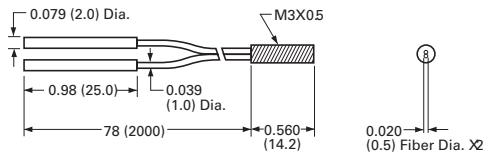

Small Diameter, Threaded Tip with Bendable Probe

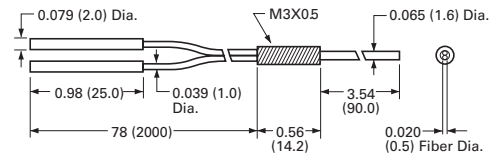

Pre-Assembled Single Fiber Optic Cables (for Thru-Beam Sensing)

Large Diameter, Threaded Tip

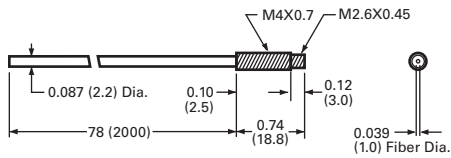

Large Diameter, Threaded Tip with Bendable Probe

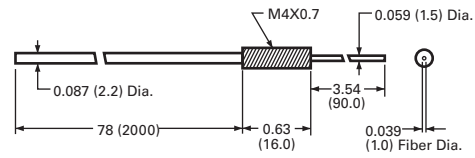

Small Diameter, Threaded Tip

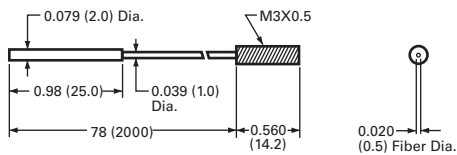

Small Diameter, Threaded Tip with Bendable Probe

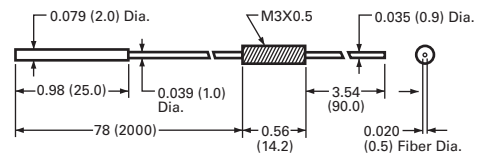

Approximate Dimensions in Inches

Accessories

Fiber Optic Termination

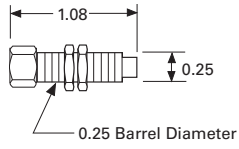

0.5 In Diameter Thru-Beam Lens

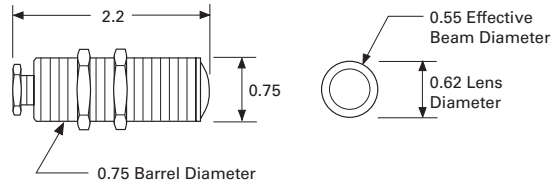

0.25 In Diameter Thru-Beam Lens

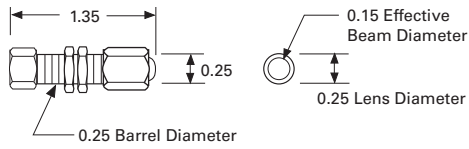

1.0 In Diameter Thru-Beam Lens

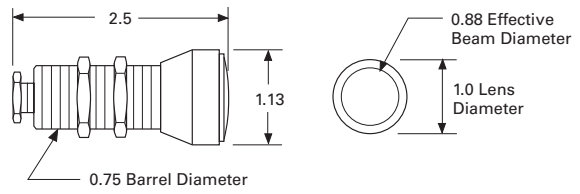

Glass Fiber Optic Cables



Contents

Description

	<i>Page</i>
Glass Fiber Optic Cables	
Product Overview	V8-T9-8
Product Selection	V8-T9-9
Accessories	V8-T9-11
Technical Data and Specifications	V8-T9-11
Dimensions	V8-T9-12

Glass Fiber Optic Cables

Product Description

Glass Fiber Optic Cables from Eaton’s electrical sector transmit light through a cable containing a bundle of tiny glass fibers. The cable can curve back and forth through equipment to the target and still transmit light with very little signal loss.

Two cable types are available:

Duplex fibers contain both source and detector fibers intermixed at the cable end for diffuse reflective sensing. One cable is required for sensing. (It is also possible to use this style of cable and a retroreflector for reflex sensing.)

Diffuse Reflective Sensing with a Single Duplex Fiber



Single fibers are used for thru-beam sensing. Separate cables are needed to carry the source light and the detector light, respectively. Two cables are required for sensing.

Thru-Beam Sensing with Two Single Fibers



Features

- Fiber optic cables allow remote sensing in areas where space is restricted or tight viewing angles are required
- Ideal for high temperature applications up to 480°F (249°C)
- Choose from many styles and lengths to exactly suit your needs
- Use PVC jacket models for most applications, stainless steel for high temperature and harsh environments
- Larger fiber bundle size offers higher excess gain for longer ranges. Small size is useful for sensing extremely small targets

DANGER

THIS SENSOR IS NOT A SAFETY DEVICE AND IS NOT INTENDED TO BE USED AS A SAFETY DEVICE. This sensor is designed only to detect and read certain data in an electronic manner and perform no use apart from that, specifically no safety-related use. This sensor product does not include self-checking redundant circuitry, and the failure of this sensor product could cause either an energized or de-energized output condition, which could result in death, serious bodily injury, or property damage.

For the most current information on this product, visit our Web site: www.eaton.com

For Customer Service in the U.S. call 1-877-ETN CARE (386-2273), in Canada call 1-800-268-3578. For Application Assistance in the U.S. and Canada call 1-800-426-9184.



Product Overview

Ordering Information

Mounting End Compatibility

Two mounting end styles are available; standard and collar. Collar mounting cables and standard mounting cables are not interchangeable and must be coupled to the correct sensor.

Mounting Ends

	Description	Compatible Fiber Optic Sensors	Catalog Number
Standard Mounting End 	Standard mounting end	Prism™ Series, Comet® Series, 50 Series, 55 Series, 80 Series, 70 Series and E51 Sensor Heads—Catalog Numbers E51DF1 and E51DF11	Starts with: E51KF_
Collar Mounting End 	Collar mounting end	E51 Sensor Heads—Catalog Numbers E51DF3, E51DF4 and E51DF33	Starts with: E51KT_

Non-Standard Cable Lengths

To order fiber optic cable in a non-standard length, replace last digit of listed catalog number with code suffix from table below. Example: For E51KF113 with a 10 ft cable, order E51KF11**10**. Built-to-order. May require minimum order quantity.

Non-Standard Cable Lengths

	Length of Fiber Optic Cable	Code Suffix
Glass Fiber Optic Cables 	18 in (1.5 ft)	15
	24 in (2.0 ft)	2
	48 in (4.0 ft)	4
	72 in (6.0 ft)	6
	120 in (10.0 ft)	10

Product Selection

Duplex Cables (for Diffuse Reflective Sensing)

Duplex Cables

	Fiber Bundle Size A	Mounting End Style ^①	Stainless Steel Jacket Catalog Number	PVC/Monocoil Jacket Catalog Number
 Forward Viewing, Unthreaded	Forward Viewing, Unthreaded			
	0.125 in (3.2 mm)	Standard	E51KF713	E51KF313
Collar		E51KT713	E51KT313	
 Right-Angle Viewing, Unthreaded	Right-Angle Viewing, Unthreaded			
	0.125 in (3.2 mm)	Standard	E51KF733	E51KF333
Collar		E51KT733	E51KT333	
 Forward Viewing, Threaded	Forward Viewing, Threaded Cable End			
	0.125 in (3.2 mm)	Standard	E51KF723	E51KF323
Collar		E51KT723	E51KT323	
 Forward Viewing, Rectangular	Forward Viewing, Rectangular Fiber Bundle, Threaded Cable End			
	0.020 x 0.154 in (0.5 x 3.9 mm)	Standard	E51KF593	E51KF193
Collar		E51KT593	E51KT193	
 Right-Angle Viewing, Threaded Cable Shaft	Right-Angle Viewing, Threaded Cable Shaft			
	0.125 in (3.2 mm)	Standard	E51KF7A3	E51KF3A3
 Right-Angle Viewing, Threaded Cable End	Right-Angle Viewing, Threaded Cable End			
	0.125 in (3.2 mm)	Standard	E51KF7B3	E51KF3B3
 Right-Angle Viewing, Tight Viewing Angle	Right-Angle Viewing, Tight Viewing Angle, Unthreaded			
	0.094 in (2.4 mm)	Standard	E51KF563	E51KF163
Collar		E51KT563	E51KT163	
 Forward Viewing, Miniature Probe	Forward Viewing, Miniature Probe, Unthreaded			
	0.0625 in (1.6 mm)	Standard	E51KF583	E51KF183
Collar		E51KT583	E51KT183	
 Right-Angle Viewing, Miniature Probe	Right-Angle Viewing, Miniature Probe, Unthreaded			
	0.0625 in (1.6 mm)	Standard	E51KF573	E51KF173
Collar		E51KT573	E51KT173	
 Forward Viewing, Fiber Bundle	Forward Viewing, Rectangular Fiber Bundle, Thru-Hole Mounting			
	0.032 x 0.382 in (0.8 x 9.7 mm)	Standard	E51KF743	E51KF343
		Collar	—	E51KT343
	0.020 x 0.154 in (0.5 x 3.9 mm)	Standard	E51KF543	E51KF143
Collar		—	—	
 Right-Angle Viewing, Fiber Bundle	Right-Angle Viewing, Rectangular Fiber Bundle, Thru-Hole Mounting			
	0.020 x 0.154 in (0.5 x 3.9 mm)	Standard	E51KF553	E51KF153
Collar		—	E51KT153	

Dimensions, see Page V8-T9-12.

Note

^① Collar mounting cables and standard mounting cables are not interchangeable and must be coupled to the correct sensor. See compatibility chart on Page V8-T9-8.

Single Cables (for Thru-Beam Sensing)

Single Cables

	Fiber Bundle Size A	Mounting End Style ^①	Stainless Steel Jacket Catalog Number	PVC/Monocoil Jacket Catalog Number
	Forward Viewing, Unthreaded			
	0.125 in (3.2 mm)	Standard	E51KF813	E51KF413
Collar		E51KT813	E51KT413	
	Right-Angle Viewing, Unthreaded			
	0.125 in (3.2 mm)	Standard	E51KF833	E51KF433
Collar		E51KT833	E51KT433	
	Forward Viewing, Threaded Cable End			
	0.125 in (3.2 mm)	Standard	E51KF823	E51KF423
Collar		E51KT823	E51KT423	
	Forward Viewing, Rectangular Fiber Bundle, Threaded Cable End			
	0.020 x 0.154 in (0.5 x 3.9 mm)	Standard	E51KF693	E51KF293
Collar		E51KT693	E51KT293	
	Right-Angle Viewing, Threaded Cable Shaft			
	0.125 in (3.2 mm)	Standard	E51KF8A3	E51KF4A3
Collar		E51KT8A3	—	
	Right-Angle Viewing, Threaded Cable End			
	0.125 in (3.2 mm)	Standard	E51KF8B3	E51KF4B3
Collar		E51KT8B3	—	
	Right-Angle Viewing, Tight Viewing Angle, Unthreaded			
	0.094 in (2.4 mm)	Standard	E51KF663	E51KF263
Collar		E51KT663	E51KT263	
	Forward Viewing, Miniature Probe, Unthreaded			
	0.0625 in (1.6 mm)	Standard	E51KF683	E51KF283
Collar		E51KT683	E51KT283	
	Right-Angle Viewing, Miniature Probe, Unthreaded			
	0.0625 in (1.6 mm)	Standard	E51KF673	E51KF273
Collar		E51KT673	E51KT273	
	Forward Viewing, Rectangular Fiber Bundle, Thru-Hole Mounting			
	0.032 x 0.382 in (0.8 x 9.7 mm)	Standard	E51KF843	E51KF443
		Collar	—	E51KT443
0.020 x 0.154 in (0.5 x 3.9 mm)	Standard	E51KF643	E51KF243	
	Right-Angle Viewing, Rectangular Fiber Bundle, Thru-Hole Mounting			
	0.020 x 0.154 in (0.5 x 3.9 mm)	Standard	E51KF653	E51KF253
Collar		—	E51KT253	

Dimensions, see Page V8-T9-13.

Note





^① Collar mounting cables and standard mounting cables are not interchangeable and must be coupled to the correct sensor. See compatibility chart on Page V8-T9-8.

Accessories

Lenses

Provide increased sensing range in thru-beam mode for use with fiber optic cables with threaded tip.

Lenses

	Description	Range Increase ^①	Catalog Number
	0.5 in diameter, threaded	15X	6230A-6501
	1.0 in diameter, threaded	30X	6230A-6502
	0.5 in diameter, smooth	7X	E51KFH1
	0.75 in diameter, smooth	18X	E51KFH2
	1.0 in diameter, smooth	35X	E51KFH3
Dimensions, see Page V8-T9-14.			

Technical Data and Specifications

Glass Fiber Optic Cables

Description	PVC/Monocoil Specification	Stainless Steel Specification
Temperature range	-40° to 221°F (-40° to 105°C)	-50° to 480°F (-45° to 249°C)
Bend radius	2.5X sheathing O.D. minimum	2.5X sheathing O.D. minimum
Cable length	3 ft (0.9m) standard; other lengths available, see Page V8-T9-8.	3 ft (0.9m) standard; other lengths available, see Page V8-T9-8.

Note

① Theoretical range increase with lens on both source and detector fiber optic cable.

Dimensions

Approximate Dimensions in Inches (mm)

Mounting Ends ①

Standard Mounting End



Collar Mounting End



Duplex Cables (for Diffuse Reflective Sensing)

Forward Viewing, Unthreaded

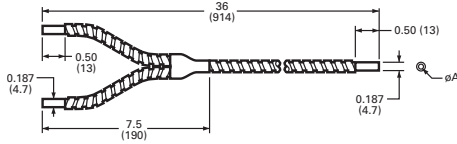

Right-Angle Viewing, Tight Viewing Angle, Unthreaded

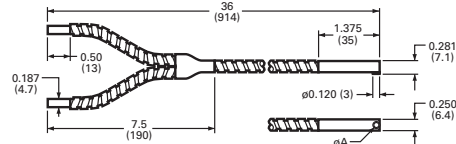

9

Right-Angle Viewing, Unthreaded

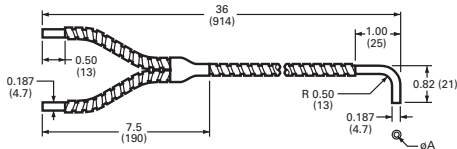

Forward Viewing, Miniature Probe, Unthreaded

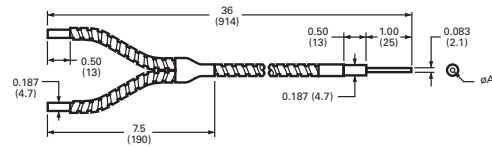

Forward Viewing, Threaded Cable End

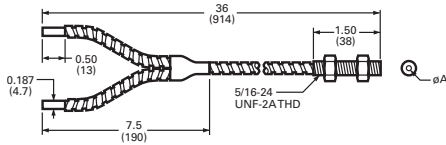

Right-Angle Viewing, Miniature Probe, Unthreaded

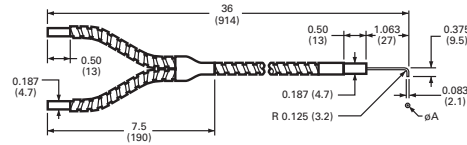

Forward Viewing, Rectangular Fiber Bundle, Threaded Cable End

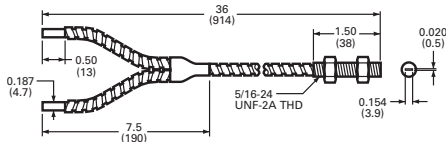

Forward Viewing, Rectangular Fiber Bundle, Thru-Hole Mounting

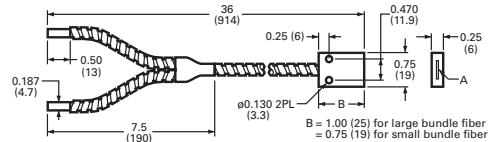

Right-Angle Viewing, Threaded Cable Shaft

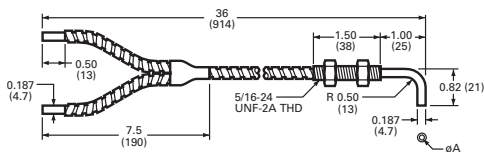

Right-Angle Viewing, Rectangular Fiber Bundle, Thru-Hole Mounting

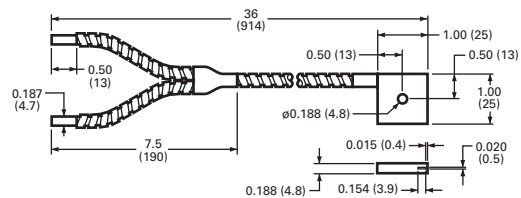

Right-Angle Viewing, Threaded Cable End

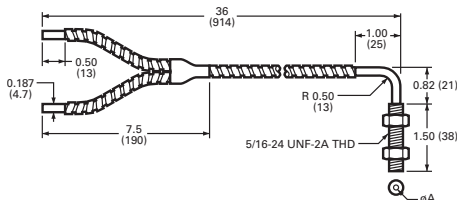

Note

① Collar mounting cables and standard mounting cables are not interchangeable and must be coupled to the correct sensor. See compatibility chart on [Page V8-T9-8](#).

Approximate Dimensions in Inches (mm)

Mounting Ends ①

Standard Mounting End



Collar Mounting End



Single Cables (for Thru-Beam Sensing)

Forward Viewing, Unthreaded

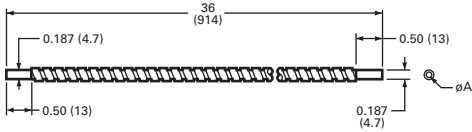

Right-Angle Viewing, Tight Viewing Angle, Unthreaded

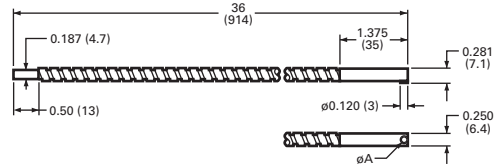

Right-Angle Viewing, Unthreaded

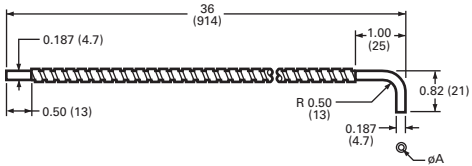

Forward Viewing, Miniature Probe, Unthreaded

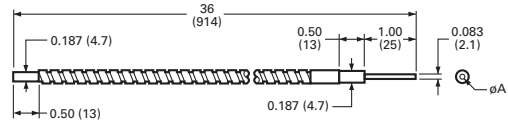

Forward Viewing, Threaded Cable End

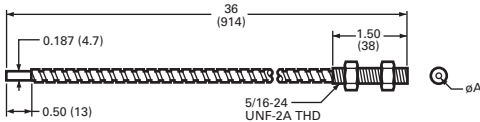

Right-Angle Viewing, Miniature Probe, Unthreaded

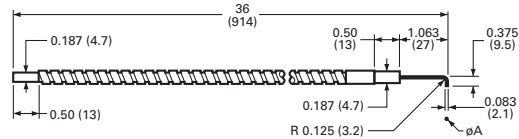

Forward Viewing, Rectangular Fiber Bundle, Threaded Cable End

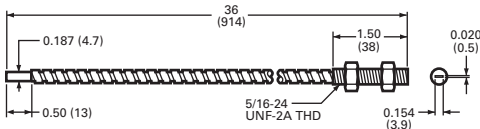

Forward Viewing, Rectangular Fiber Bundle, Thru-Hole Mounting

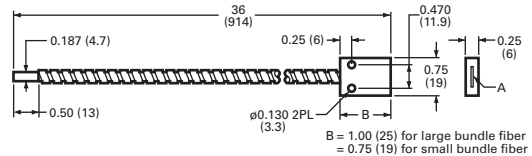

Right-Angle Viewing, Threaded Cable Shaft

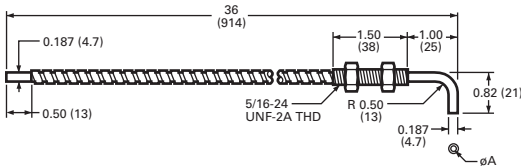

Right-Angle Viewing, Rectangular Fiber Bundle, Thru-Hole Mounting

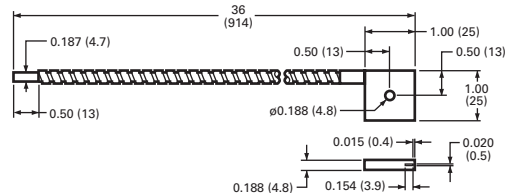

Right-Angle Viewing, Threaded Cable End

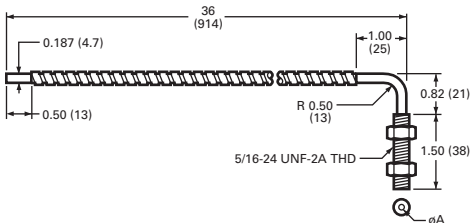

Note

① Collar mounting cables and standard mounting cables are not interchangeable and must be coupled to the correct sensor. See compatibility chart on [Page V8-T9-8](#).

Accessories—Lenses

Approximate Dimensions in Inches

0.5 In Diameter, Threaded

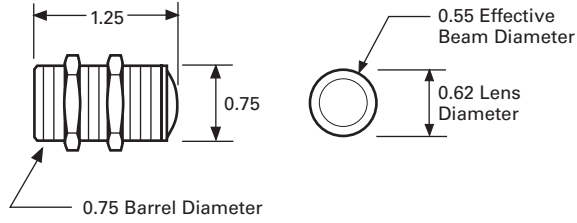

1 In Diameter, Threaded

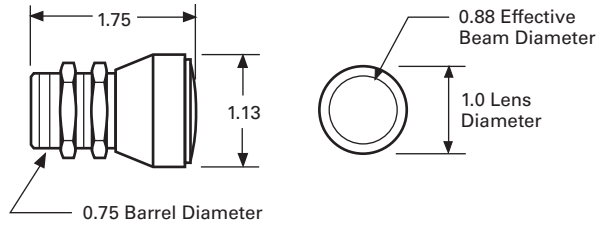

Approximate Dimensions in Inches (mm)

0.5 In Diameter, Smooth

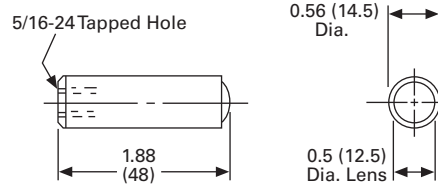

0.75 In Diameter, Smooth

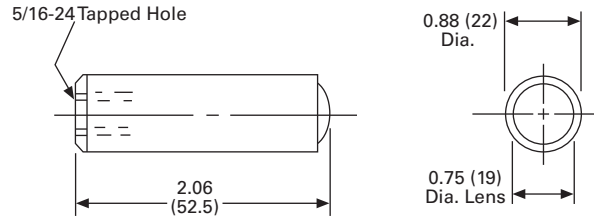

1.0 In Diameter, Smooth

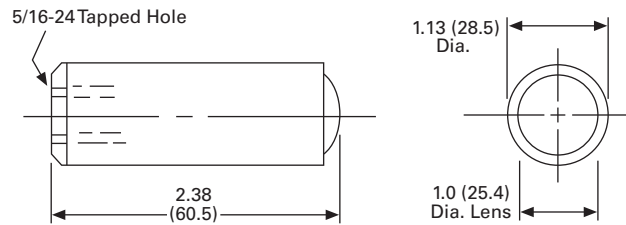

Global Plus Connector Cables



Multi-Connector Blocks



- 10.0 Introduction**
 - Product Selection Guide **V8-T10-2**
- 10.1 Global Plus Connector Cables**
 - Product Description **V8-T10-3**
 - Standards and Certifications **V8-T10-3**
 - Product Selection Guide **V8-T10-4**
 - Catalog Number Selection **V8-T10-4**
 - Product Selection **V8-T10-5**
 - Accessories **V8-T10-9**
 - Technical Data and Specifications **V8-T10-10**
 - Wiring Diagrams **V8-T10-10**
 - Dimensions **V8-T10-11**
- 10.2 Multi-Connector Blocks**
 - Product Description **V8-T10-13**
 - Application Description **V8-T10-13**
 - Features **V8-T10-13**
 - Standards and Certifications **V8-T10-13**
 - Product Selection **V8-T10-14**
 - Accessories **V8-T10-14**
 - Technical Data and Specifications **V8-T10-14**
 - Wiring Diagrams **V8-T10-15**
 - Dimensions **V8-T10-15**



Unless otherwise noted, the products contained in this section should not be used for functional safety applications. These products were not designed or tested to IEC 60947-5-3 or recommended for functional safety.



Learn
Online

For Customer Service in the U.S. call 1-877-ETN CARE (386-2273),
in Canada call 1-800-268-3578.
For Application Assistance in the U.S. and Canada
call 1-800-426-9184.

Product Selection Guide

Global Plus Connector Cables



Page V8-T10-3

Overview

Finish your sensor installation with high quality Connector Cables from Eaton's Electrical Sector. Our Global Plus line is designed to give you everything you want without paying extra for the features you don't want. It includes a wide variety of single- and double-connector cables in a variety of sizes (mini, micro, nano), lengths and jacket materials to fit any application

Sensing Types and Ranges

Nano (M8)
Micro (M12)
Mini
Double-ended, straight, right-angle, and field-installable connector styles

Product Features

Industry standard connector types
Industrial-duty polymer jackets consisting of PVC, PUR, or Irradiated PUR
Stranded copper conductors and polymer jackets provide a high resistance to bending motions
Right angle units for applications that have constricted space

Technical Data and Specifications

Operating voltage—
0–600 Vac/dc
Maximum load current—
0–13A
Enclosure ratings—
NEMA 6P, IP68

Approvals

UL®
cUL®
CSA®



Multi-Connector Blocks



Page V8-T10-13

Overview

Junction Blocks from Eaton's Electrical Sector allow users to quickly connect multiple sensors through one source of power

Sensing Types and Ranges

4-, 6- or 8-ports
Cable or connector models
Micro connector style

Product Features

LED status indicators for power and output status
Molded PUR cable models provide added protection from moisture and most cutting fluids
Pluggable terminal blocks provide easy and quick installation

Technical Data and Specifications

Operating voltage—
0–30 Vdc
Maximum load current—
4A per port
Enclosure ratings—
IP65

Approvals

cUL



Global Plus Connector Cables



Global Plus Connector Cables

Product Description

Finish your sensor installation with high quality connector cables from Eaton's Electrical Sector. Our Global Plus line is designed to give you everything you want without paying extra for the features you don't want. It includes a wide variety of single- and double-connector cables. Custom lengths are available upon request from the factory.

Standards and Certifications

- UL Recognized (Mini-Style)
- CSA Certified (Mini- and Nano-Styles)
- cUL Recognized (Micro- and Nano-Styles)



Contents

Description

Page

Global Plus Connector Cables	
Product Selection Guide	V8-T10-4
Catalog Number Selection	V8-T10-4
Product Selection	
Single Connector Cables	V8-T10-5
Double Connector Cables	V8-T10-8
Receptacles—Micro and Mini	V8-T10-9
Accessories	V8-T10-9
Technical Data and Specifications	V8-T10-10
Wiring Diagrams	V8-T10-10
Dimensions	V8-T10-11

DANGER

THIS SENSOR IS NOT A SAFETY DEVICE AND IS NOT INTENDED TO BE USED AS A SAFETY DEVICE. This sensor is designed only to detect and read certain data in an electronic manner and perform no use apart from that, specifically no safety-related use. This sensor product does not include self-checking redundant circuitry, and the failure of this sensor product could cause either an energized or de-energized output condition, which could result in death, serious bodily injury, or property damage.

For the most current information on this product, visit our Web site: www.eaton.com



For Customer Service in the U.S. call 1-877-ETN CARE (386-2273),
in Canada call 1-800-268-3578.
For Application Assistance in the U.S. and Canada
call 1-800-426-9184.

Product Selection Guide

What Type of Connector Cable Do You Need?

The majority of the sensors in this Product Guide are available with connectors for quick-disconnect installation.

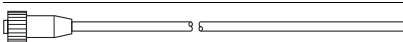
Global Plus Connector Cable Selection

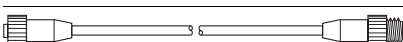
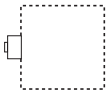
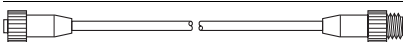
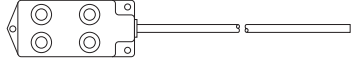
Sensor	Connector Cable Type	Style	Interfaces with ...	Style
	Single-Connector Cable		Junction Box or Control Panel	
		Micro (see Page V8-T10-5)	For hard-wiring into a typical junction box or control panel.	
		Mini (see Page V8-T10-6)		
		Nano (see Page V8-T10-7)		
	Double-Connector Cable		Connectorized Junction Box or Control Panel	
		Micro (see Page V8-T10-8)	For connecting to a junction box or control panel that has a receptacle connector interface.	
		Mini (see Page V8-T10-8)		
	Double-Connector Cable		Multi-Connector Block with Cable	
		Micro (see Page V8-T10-8)	Allows up to eight sensors to be consolidated into one cable for wiring to your control system	Micro (see Page V8-T10-8)

10

Catalog Number Selection

Global Plus Connector Cables ①

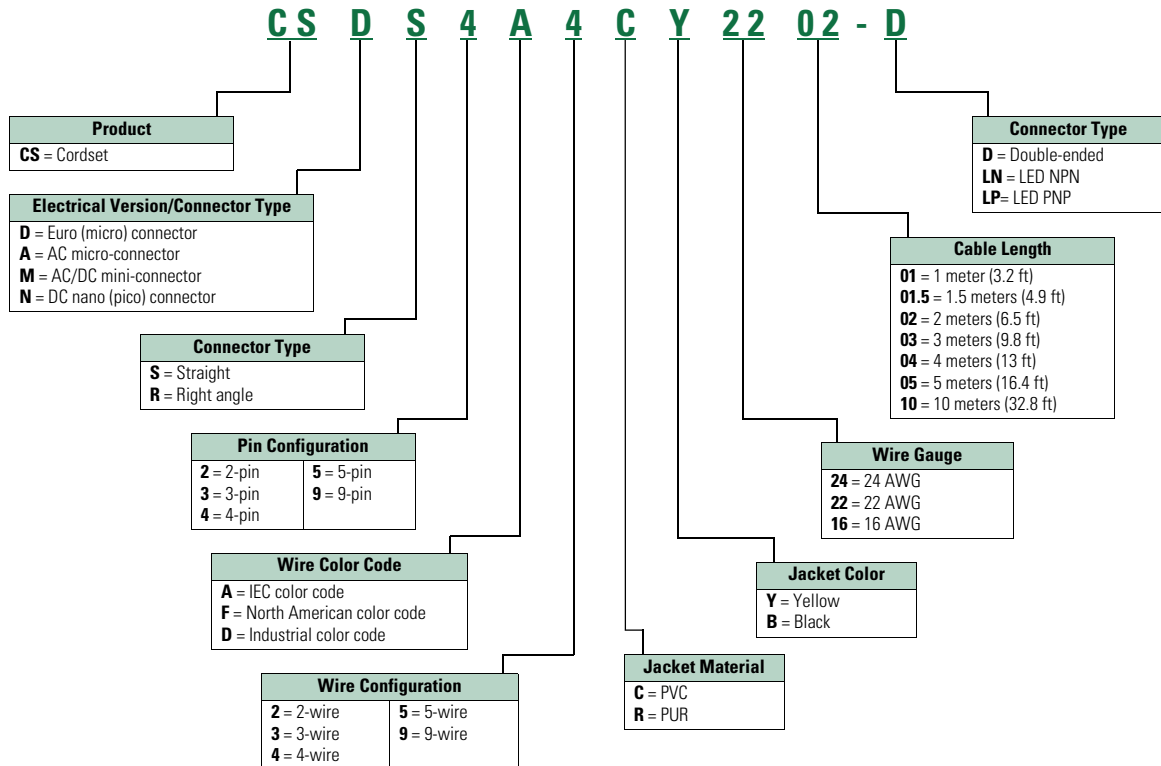

Note

① This is a representative guide to the catalog numbering system. All possible combinations may not be available for ordering. Please verify the number with the following pages or call Application Support at (800) 426-9194 before ordering.

Product Selection

Single Connector Cables

Micro-Style Straight Female



Micro-Style Straight Female

Voltage Style	Number of Pins	Gauge	Length	Pin Configuration/Wire Colors (Face View Female Shown)	PVC Jacket Catalog Number	PUR Jacket Catalog Number	
Standard Cables							
AC	3-pin, 3-wire	18 AWG	6.0 ft (2m)		CSAS3F3CY1802	—	
			16.4 ft (5m)		CSAS3F3CY1805	—	
			32.8 ft (10m)		CSAS3F3CY1810	—	
		22 AWG	6.0 ft (2m)	CSAS3F3CY2202	CSAS3F3RY2202		
			16.4 ft (5m)	CSAS3F3CY2205	CSAS3F3RY2205		
			32.8 ft (10m)	CSAS3F3CY2210	CSAS3F3RY2210		
		4-pin, 4-wire	18 AWG	6.0 ft (2m)		CSAS4F4CY1802	—
				16.4 ft (5m)		CSAS4F4CY1805	—
				32.8 ft (10m)		CSAS4F4CY1810	—
	22 AWG		6.0 ft (2m)	CSAS4F4CY2202	CSAS4F4RY2202		
			16.4 ft (5m)	CSAS4F4CY2205	CSAS4F4RY2205		
			32.8 ft (10m)	CSAS4F4CY2210	CSAS4F4RY2210		
	22 AWG	6.0 ft (2m)		CSAS4A4CY2202	—		
		16.4 ft (5m)		CSAS4A4CY2205	—		
		32.8 ft (10m)		CSAS4A4CY2210	—		
5-pin, 5-wire	22 AWG	6.0 ft (2m)		CSAS5A5CY2202	—		
		16.4 ft (5m)		CSAS5A5CY2205	—		
		32.8 ft (10m)		CSAS5A5CY2210	—		
DC	4-pin, 3-wire	22 AWG	6.0 ft (2m)		CSDS4A3CY2202	CSDS4A3RY2202	
			16.4 ft (5m)		CSDS4A3CY2205	CSDS4A3RY2205	
			32.8 ft (10m)		CSDS4A3CY2210	CSDS4A3RY2210	
	4-pin, 4-wire	22 AWG	6.0 ft (2m)		CSDS4A4CY2202	CSDS4A4RY2202	
			16.4 ft (5m)		CSDS4A4CY2205	CSDS4A4RY2205	
			32.8 ft (10m)		CSDS4A4CY2210	CSDS4A4RY2210	
	65.6 ft (20m)				CSDS4A4CY2220	—	
		5-pin, 5-wire	22 AWG	6.0 ft (2m)		CSDS5A5CY2202	—
				16.4 ft (5m)		CSDS5A5CY2205	—
	32.8 ft (10m)			CSDS5A5CY2210		—	
	8-pin, 8-wire	24 AWG	16.4 ft (5m)		CSDS8A8CB2405	—	
			32.8 ft (10m)		CSDS8A8CB2410	—	

Micro-Style Right Angle Female



Micro-Style Right Angle Female

Voltage Style	Number of Pins	Gauge	Length	Pin Configuration/Wire Colors (Face View Female Shown)	PVC Jacket Catalog Number	PUR Jacket Catalog Number	
Standard Cables							
AC	3-pin, 3-wire	18 AWG	6.0 ft (2m)		CSAR3F3CY1802	—	
			16.4 ft (5m)		CSAR3F3CY1805	—	
			32.8 ft (10m)		CSAR3F3CY1810	—	
	22 AWG	6.0 ft (2m)	CSAR3F3CY2202	CSAR3F3RY2202			
		16.4 ft (5m)	CSAR3F3CY2205	CSAR3F3RY2205			
		32.8 ft (10m)	CSAR3F3CY2210	CSAR3F3RY2210			
4-pin, 4-wire	18 AWG	6.0 ft (2m)		CSAR4F4CY1802	—		
				16.4 ft (5m)	CSAR4F4CY1805	—	
				32.8 ft (10m)	CSAR4F4CY1810	—	
	22 AWG	6.0 ft (2m)	CSAR4F4CY2202	CSAR4F4RY2202			
		16.4 ft (5m)	CSAR4F4CY2205	CSAR4F4RY2205			
		32.8 ft (10m)	CSAR4F4CY2210	CSAR4F4RY2210			
DC	4-pin, 3-wire	22 AWG	6.0 ft (2m)		CSDR4A3CY2202	CSDR4A3RY2202	
					16.4 ft (5m)	CSDR4A3CY2205	CSDR4A3RY2205
					32.8 ft (10m)	CSDR4A3CY2210	CSDR4A3RY2210
	4-pin, 4-wire	22 AWG	6.0 ft (2m)		CSDR4A4CY2202	CSDR4A4RY2202	
					16.4 ft (5m)	CSDR4A4CY2205	CSDR4A4RY2205
					32.8 ft (10m)	CSDR4A4CY2210	CSDR4A4RY2210
5-pin, 5-wire	22 AWG	6.0 ft (2m)		CSDR5A5CY2202	—		
				16.4 ft (5m)	CSDR5A5CY2205	—	
				32.8 ft (10m)	CSDR5A5CY2210	—	

Mini-Style Straight Female



Mini-Style Straight Female

Current Rating at 600V	Voltage Style	Number of Pins	Gauge	Length	Pin Configuration/Wire Colors (Face View Female Shown)	Catalog Number
Standard Cables						
13A	AC/DC	2-pin, 2-wire	16 AWG	6 ft (2m)		CSMS2D2CY1602
				12 ft (4m)		CSMS2D2CY1604
13A		3-pin, 3-wire	16 AWG	6 ft (2m)		CSMS3F3CY1602
				12 ft (4m)		CSMS3F3CY1604
10A		4-pin, 4-wire	16 AWG	6 ft (2m)		CSMS4F4CY1602
				12 ft (4m)		CSMS4F4CY1604

Mini-Style Straight Female



Mini-Style Straight Female, continued

Current Rating at 600V	Voltage Style	Number of Pins	Gauge	Length	Pin Configuration/Wire Colors (Face View Female Shown)	Catalog Number
Standard Cables						
10A	AC/DC	4-pin, 4-wire	16 AWG	6 ft (2m)		CSMS4A4CY1602
				13.12 ft (4m)		CSMS4A4CY1604
				19.69 ft (6m)		CSMS4A4CY1606
8A		5-pin, 5-wire	16 AWG	6 ft (2m)		CSMS5D5CY1602
				12 ft (4m)		CSMS5D5CY1604
8A		5-pin, 5-wire	16 AWG	6 ft (2m)		CSMS5A5CY1602
				13.12 ft (4m)		CSMS5A5CY1604
				19.69 ft (6m)		CSMS5A5CY1606
7A		9-pin, 9-wire	16 AWG	6 ft (2m)		CSMS9D9CY1602

10

Nano-Style Straight Female



Nano-Style Straight Female

Voltage Style	Number of Pins	Gauge	Length	Pin Configuration/Wire Colors (Face View Female Shown)	PVC Jacket Catalog Number	PUR Jacket Catalog Number
Standard Cables						
—	3-pin, 3-wire	24 AWG	6.0 ft (2m)		CSNS3A3CY2402	CSNS3A3RY2402
			16.4 ft (5m)		CSNS3A3CY2405	CSNS3A3RY2405
			32.8 ft (10m)		CSNS3A3CY2410	CSNS3A3RY2410
DC	4-pin, 4-wire	24 AWG	6.5 ft (2m)		CSNS4A4CY2402	—
			16.4 ft (5m)		CSNS4A4CY2405	—
			32.8 ft (10m)		CSNS4A4CY2410	—

Nano-Style Right Angle Female



Nano-Style Right Angle Female

Voltage Style	Number of Pins	Gauge	Length	Pin Configuration/Wire Colors (Face View Female Shown)	PVC Jacket Catalog Number	PUR Jacket Catalog Number
Standard Cables						
—	3-pin, 3-wire	24 AWG	6.0 ft (2m)		CSNR3A3CY2402	CSNR3A3RY2402
			16.4 ft (5m)		CSNR3A3CY2405	CSNR3A3RY2405
			32.8 ft (10m)		CSNR3A3CY2410	CSNR3A3RY2410

10.1

Sensor Connectivity

Global Plus Connector Cables

Double Connector Cables

Micro-Style Straight Female/Male



Micro-Style Straight Female/Male

Voltage Style	Number of Pins	Gauge	Length	Pin Configuration/Wire Colors (Face View Female Shown)	Catalog Number
DC	4-pin	22 AWG	3.0 ft (1m)		CSDS4A4CY2201-D
			5.0 ft (1.5m)		CSDS4A4CY2201.5-D
			6.0 ft (2m)		CSDS4A4CY2202-D
			10.0 ft (3m)		CSDS4A4CY2203-D
			16.4 ft (5m)		CSDS4A4CY2205-D
DC	5-pin	22 AWG	3.0 ft (1m)		CSDS5A5CY2201-D
			10.0 ft (3m)		CSDS5A5CY2203-D
			16.4 ft (5m)		CSDS5A5CY2205-D

10

Micro-Style Straight Female/Right Angle Male



Micro-Style Straight Female/Right Angle Male

Voltage Style	Number of Pins	Gauge	Length	Pin Configuration/Wire Colors (Face View Female Shown)	Catalog Number
DC	4-pin	22 AWG	3.0 ft (1m)		CSDR4A4CY2201-D
			5.0 ft (1.5m)		CSDR4A4CY2201.5-D
			6.0 ft (2m)		CSDR4A4CY2202-D
			10.0 ft (3m)		CSDR4A4CY2203-D
			16.4 ft (5m)		CSDR4A4CY2205-D

Receptacles—Micro and Mini

Micro-Style Straight Male



Micro and Mini

Voltage Style	Number of Pins	Gauge	Length	Mounting Hole Size	Pin Configuration	Catalog Number
Standard Cables—Micro						
DC	4-pin, 4-wire	22 AWG	1.0 ft (0.3m)	1/2 in NPT	1-Brown 2-White 3-Blue 4-Black	CSDS4A4CMR22.3
	5-pin, 5-wire	22 AWG	1.6 ft (0.5m)	PG9	1-Brown 2-White 3-Blue 4-Black 5-Gray	CSDS5A5CMR.5

Mini-Style Straight Male



Voltage Style	Number of Pins	Gauge	Length	Mounting Hole Size	Pin Configuration	Catalog Number
Standard Cables—Mini						
AC/DC	4-pin, 4-wire	22 AWG	1.6 ft (0.5m)	1/2 in NPT	1-Brown 2-White 3-Blue 4-Black	CSMS4A4CMR16.5

Accessories

Global Plus Accessories

	Description	Catalog Number
Field Wireable, Plastic	Micro female style, straight, four-position	CSDS4
	Micro female style, right angle, four-position	CSDR4
	Micro male style, straight, four-position	CSDSM4
	Micro male style, right angle, four-position	CSDRM4
	Nano female style, straight, three-position	CSNS3
	Nano male style, straight, three-position	CSNSM3
	Nano male style, straight, four-position	CSNSM4
	Nano female style, straight, four-position	CSNS4
	Nano female style, right angle, four-position	CSNR4
	Micro female style, y-splitter, three-position	CSDY3 ①
Micro female style, y-splitter, five-position	CSDY5 ①	
Closure Cap	Seals off unused connector ports on multi-connector blocks, micro female type	CBCAP
	Seals off unused parts on micro, male type	CBMCAP
Bulk Cable, Micro-Style	Four-conductor, 22 AWG, yellow jacket (blue, brown, white, black), compatible with micro-style field wireable connectors shown above	CS4ACY22XX ②
	Three-conductor, 24 AWG, yellow jacket (brown, blue, black), compatible with field wireable connectors shown above	CS3ACY24XX ①

Notes

- ① For wiring diagrams explaining the difference between three- and five-position models, see Wiring Diagrams on **Page V8-T10-10**.
- ② Quantity ordered indicates length (for example, quantity of 5 equals 5 ft).

Technical Data and Specifications

Global Plus Connector Cables

Description	Micro-Style Specification	Mini-Style Specification	Nano-Style Specification
Jacket material	PVC/PUR/Irradiated PUR ^①	PVC	PVC/PUR ^①
Contact material	Gold-plated copper alloy	Gold-plated brass	Gold-plated copper alloy
Coupling nut material	Nickel-plated die-cast zinc	Nickel-plated die-cast zinc	Nickel-plated die-cast zinc
O-ring	Nitrile rubber	None	Nitrile rubber
Cable	PVC/PUR/Irradiated PUR, insulation and jacket, stranded copper conductors	PVC/PUR/Irradiated PUR, insulation and jacket, stranded copper conductors	PVC/PUR/Irradiated PUR, insulation and jacket, stranded copper conductors
Cable strain relief	35 lbs minimum	35 lbs minimum	35 lbs minimum
Voltage rating	320V (24 Vdc for LED plugs) (30 Vdc for 8-pin, versions)	600V	100 Vdc
Current rating	4A	See model selection chart	4A
Contact resistance	5M ohms maximum	5M ohms maximum	5M ohms maximum
Isolation resistance	1000M ohms minimum	1000M ohms minimum	1000M ohms minimum
Protection	IP67	NEMA 6P, IP68	IP67
Temperature range	-13° to 176°F (-25° to 80°C)	-4° to 221°F (-20° to 105°C)	-4° to 221°F (-20° to 105°C)
Cable diameter	See Dimensions on Page V8-T10-11 .	See Dimensions on Page V8-T10-11 .	See Dimensions on Page V8-T10-11 .
Bend radius	Minimum recommended bend radius is 12X cable diameter	Minimum recommended bend radius is 12X cable diameter	Minimum recommended bend radius is 12X cable diameter

Wiring Diagrams

CSDY3

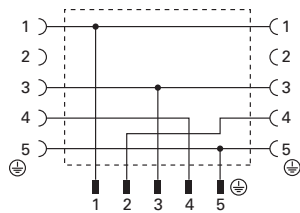

CSDY5

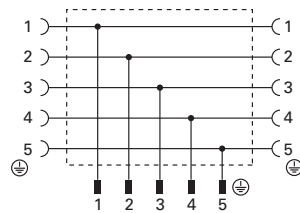

Note

^① Jacket material dependent upon model selection.

Dimensions

Approximate Dimensions in Inches (mm)

Single Connector Cable Dimensions

Micro-Style Single Connector Cables, Straight Female

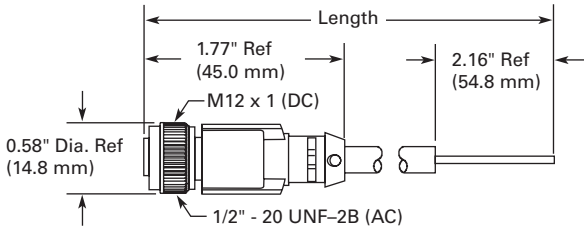

Micro-Style Single Connector Cables, Right Angle Female

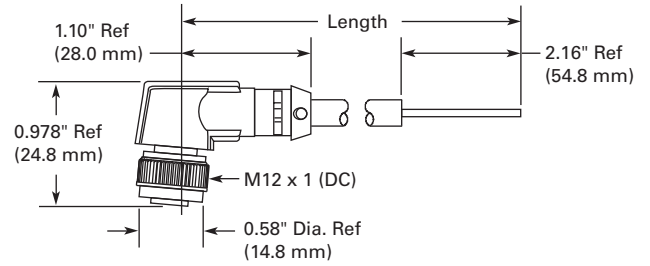

Mini-Style Single Connector Cables, 2-, 3-, 4- and 5-pin, Versions

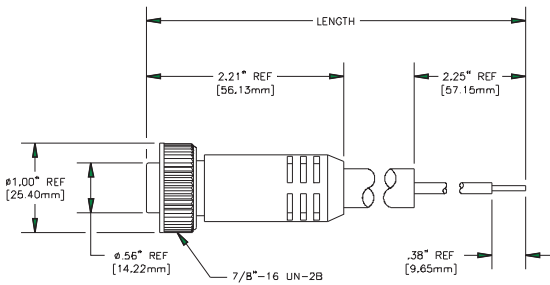

Mini-Style Single Connector Cables, 9-pin, Version

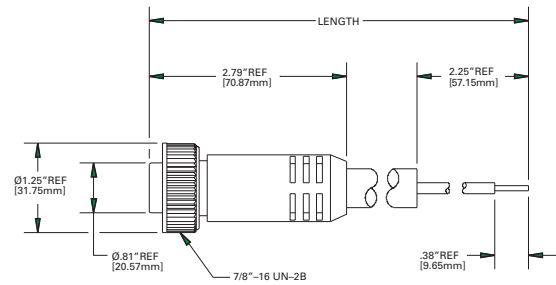

Nano-Style Single Connector Cables, Straight Female

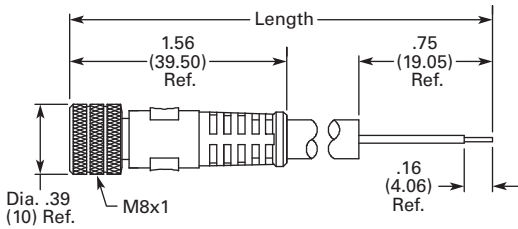

Nano-Style Single Connector Cables, Right Angle Female (Standard and LED)

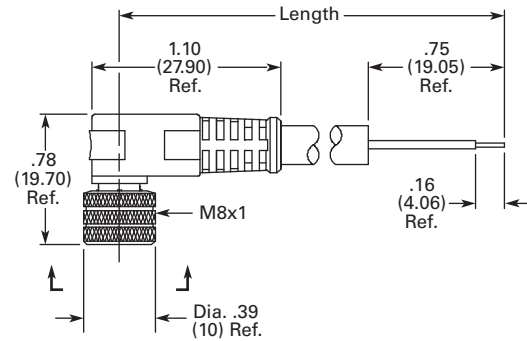

10.1

Sensor Connectivity

Global Plus Connector Cables

Approximate Dimensions in Inches (mm)

Double Connector Cable Dimensions

Micro-Style Double Connector Cables, Straight Female/Male

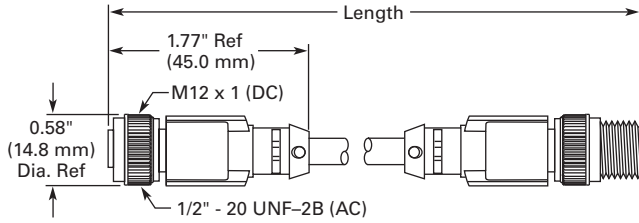

Micro-Style Double Connector Cables, Straight Female/Right Angle Male

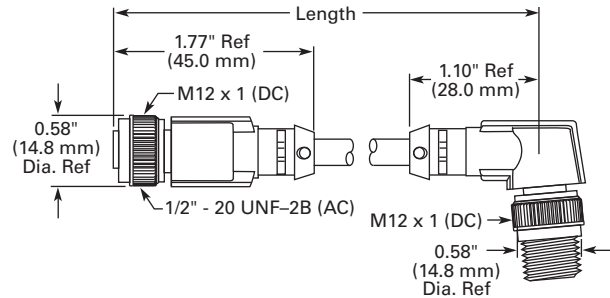

10

Receptacle Dimensions

Micro-Style Receptacles, Straight Male (1/2 in NPT Mounting)

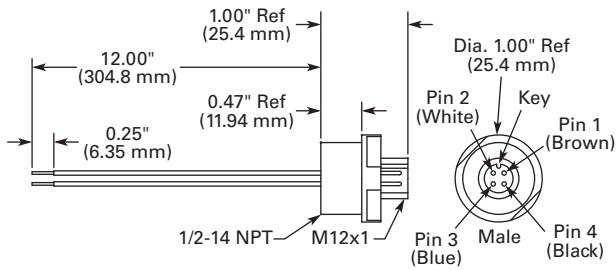

Micro-Style Receptacles, Straight Male (PG9 Mounting)

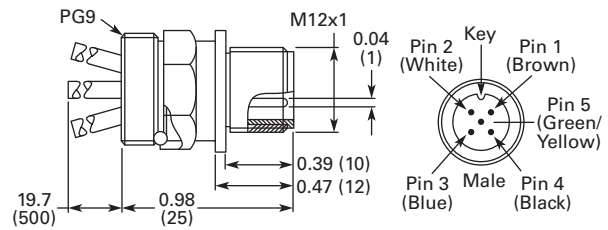

Mini-Style Receptacles, Straight Male

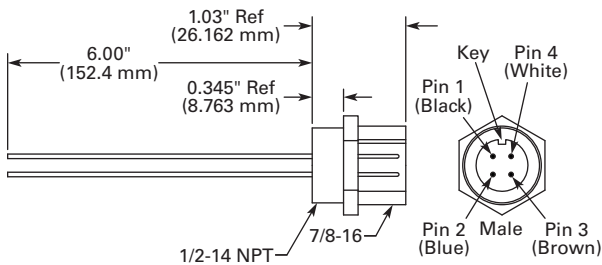

Multi-Connector Blocks



Multi-Connector Blocks

Product Description

The Multi-Connector Block from Eaton's Electrical Sector is an easy way to quickly connect sensors to a control system. Using a variety of double-ended, industry-standard M12 micro-connector cables, a system can be wired up in minutes, therefore saving installation time and money.

For further convenience and installation troubleshooting, LEDs provide both power and output status on the block.

Global Plus Multi-Connector Blocks were designed with the most heavy-duty applications in mind—such as automotive manufacturing, metalworking and machinery OEMs. Put Eaton's Global Plus Multi-Connector Blocks to the test for your next machine design.

Application Description

Typical Applications

- Automotive manufacturing
- Metalworking
- Many types of Machinery OEMs
- Power Control and Panel Shops

Contents

Description

Description	Page
Multi-Connector Blocks	
Product Selection	V8-T10-14
Accessories	V8-T10-14
Technical Data and Specifications	V8-T10-14
Wiring Diagrams	V8-T10-15
Dimensions	V8-T10-15

Features

- Model options with four, six or eight sensor ports in one block
- Block capacity can be doubled with Micro Splitter Accessory (CSDY5)
- Capacity of up to 4A per port and 12A per block
- Robust design to resist vibration and moisture penetration
- Ideal for extreme temperature environments from -13° to 167°F (-25° to 75°C)

Standards and Certifications

- UL Recognized
- CSA Certified



⚠ DANGER

THIS SENSOR IS NOT A SAFETY DEVICE AND IS NOT INTENDED TO BE USED AS A SAFETY DEVICE. This sensor is designed only to detect and read certain data in an electronic manner and perform no use apart from that, specifically no safety-related use. This sensor product does not include self-checking redundant circuitry, and the failure of this sensor product could cause either an energized or de-energized output condition, which could result in death, serious bodily injury, or property damage.

For the most current information on this product, visit our Web site: www.eaton.com

For Customer Service in the U.S. call 1-877-ETN CARE (386-2273), in Canada call 1-800-268-3578. For Application Assistance in the U.S. and Canada call 1-800-426-9184.

Product Selection

Multi-Connector Block

Micro-Style Molded Cable



Micro-Style Molded Cable

Voltage Style	Number of Ports	Connection	Pin Configuration/Wire Colors	Catalog Number
DC PNP	4-port	5m cable	See Wiring Diagrams on Page V8-T10-15	CBDR4P05
		10m cable		CBDR4P10
	6-port	5m cable		CBDR6P05
		10m cable		CBDR6P10
	8-port	5m cable		CBDR8P05
		10m cable		CBDR8P10

Accessories

10

Closure Cap



Closure Cap

Description	Catalog Number
Seals off unused connector ports on multi-connector blocks, micro female type	CBCAP

Technical Data and Specifications

Multi-Connector Blocks

Description	Specification
General	
Nominal voltage (Vdc)	24
Maximum operating voltage (Vdc)	30
Current capacity per port (A)	4
Residual current (A)	12
Operating current of each LED (mA)	≤5
Protection type (IEC 60 529 / EN 60 529 / DIN VDE 0470-1)	IP65
Ambient temperature	-13° to 167°F (-25° to 75°C)
Jacket material	Nylon with brass receptacles
Contact material	Gold-plated copper alloy
O-ring	Nitrile rubber
Voltage rating	10–30 Vdc
Current rating	4A per port; 12A max. per unit
Contact resistance	5M ohms max.
Isolation resistance	1000M ohms min.
Protection	NEMA 6P, IP67
Temperature range	-13° to 194°F (-25° to 90°C)
LED Status Indication	
Supply voltage	Green
Status display of I/O	Yellow

Master Cable—Pre-Wired Cable Connection

Description	Specification
Signal line, stranded in mm ² (AWG)	0.34 (22)
Voltage supply, stranded in mm ² (AWG)	3 x 1.0 (17)
Cable diameter in mm [in]	
4- and 6-port	8.7 [0.3425]
8-port	9.2 [0.3622]
Material	PUR
Cable strain relief	30 lbs. min.

Wiring Diagrams

Micro-Style Connector Blocks

PNP Block

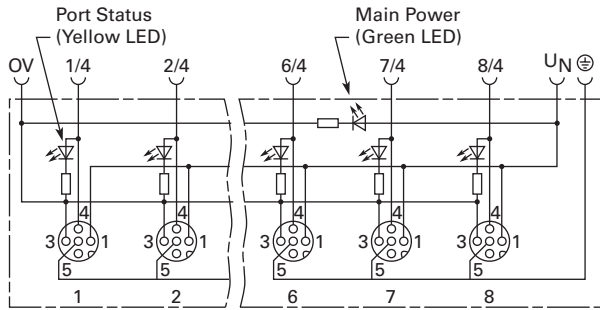

Wiring Diagram for Molded Cable Blocks

Micro DC Port/pin,	4-Port Wire Color	6-Port Wire Color	8-Port Wire Color
1/4	WH	WH	WH
2/4	GN	GN	GN
3/4	YE	YE	YE
4/4	GY	GY	GY
5/4	—	PK	PK
6/4	—	RD	RD
7/4	—	—	BK
8/4	—	—	VT
1-8/1; U_N (+V)	BN	BN	BN
1-8/3; 0V (-)	BU	BU	BU
1-8/5; PE (GND)	GN/YE	GN/YE	GN/YE

Dimensions

Approximate Dimensions in Inches (mm)

Micro-Style Connector Blocks

Four Sensor Ports

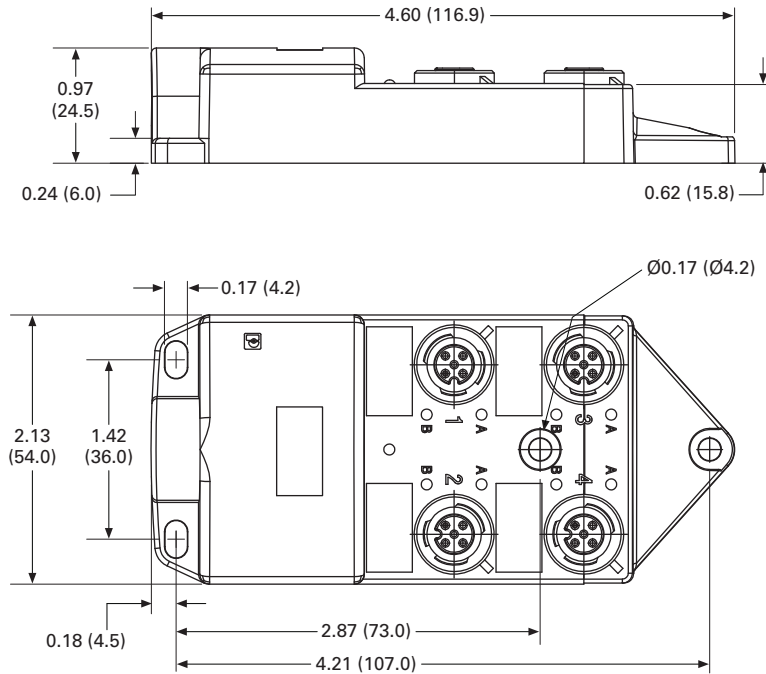

10.2

Sensor Connectivity

Multi-Connector Blocks

Approximate Dimensions in Inches (mm)

Six Sensor Ports

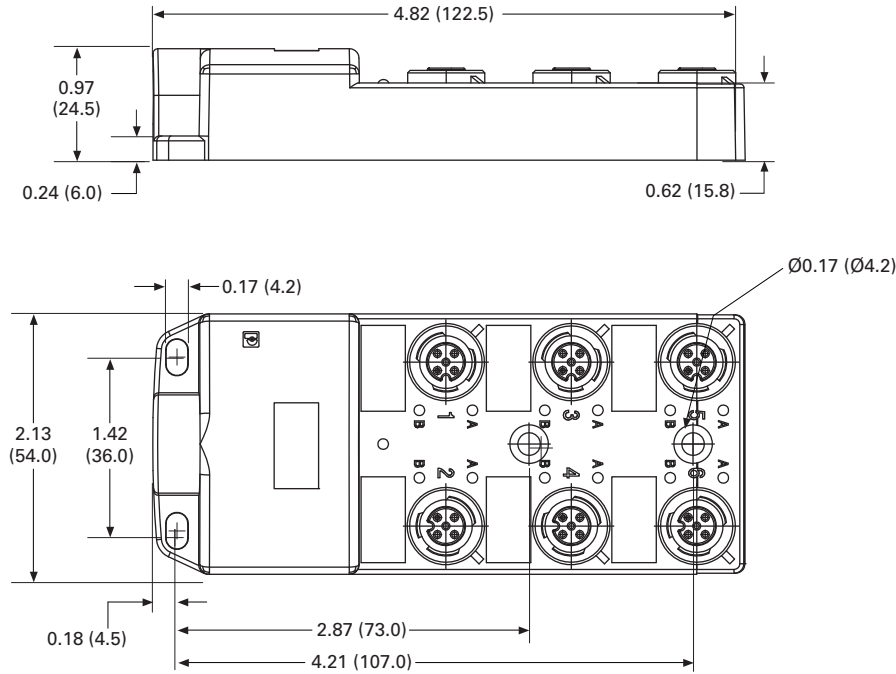

Eight Sensor Ports

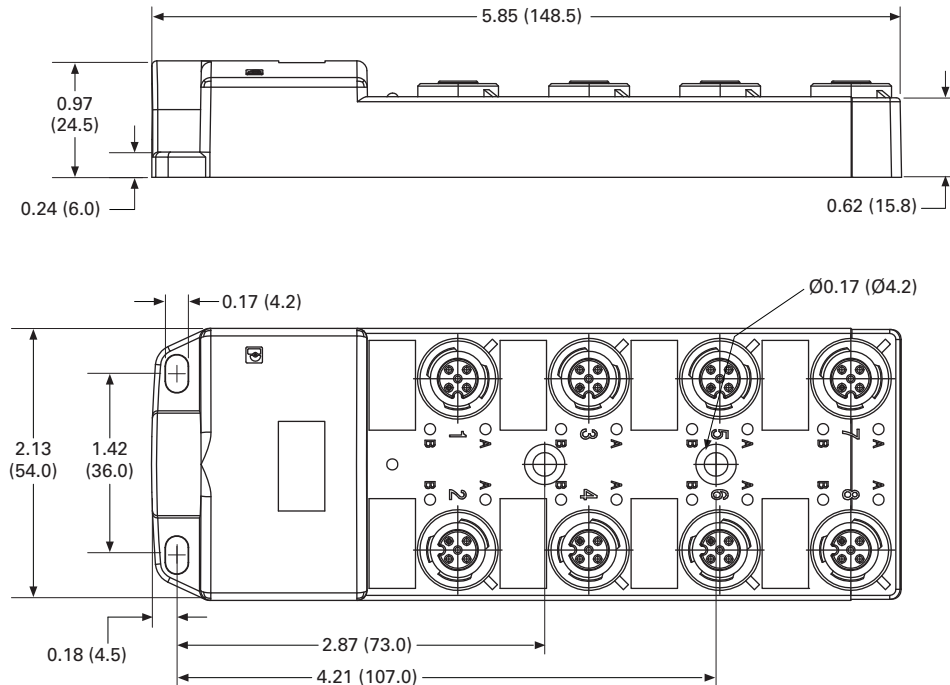

20 Series



11.1 Photoelectric Sensors—Legacy

Product Overview	V8-T11-2
How to Order	V8-T11-2
Product Selection Guide	V8-T11-3
Technical Data and Specifications	V8-T11-6



Unless otherwise noted, the products contained in this section should not be used for functional safety applications. These products were not designed or tested to IEC 60947-5-3 or recommended for functional safety.

E65 Miniature Series



E65 Miniature Series



For Customer Service in the U.S. call 1-877-ETN CARE (386-2273),
in Canada call 1-800-268-3578.
For Application Assistance in the U.S. and Canada
call 1-800-426-9184.

Photoelectric Sensors—Legacy



Contents

Description

	<i>Page</i>
Photoelectric Sensors—Legacy	
Product Selection Guide	V8-T11-3
Technical Data and Specifications	V8-T11-6

Photoelectric Sensors—Legacy

Product Overview

The products shown in this section are still offered for sale by Eaton, however, the catalog pages have been moved online. Visit www.eaton.com/legacysensors for electronic product and ordering information.

How to Order

For the most current information on this product, visit our Web site: www.eaton.com

For Customer Service in the U.S. call 1-877-ETN CARE (386-2273), in Canada call 1-800-268-3578. For Application Assistance in the U.S. and Canada call 1-800-426-9184.

Product Selection Guide

E58 18 mm Tubular Series

**Overview**

Industry standard 18 mm tubular sensors offer wide voltage ranges and reliable performance

Sensing Types and Ranges

Thru-beam: 80 ft
 Reflex: 25 ft
 Diffuse reflective: 8 in

Product Features

Industry standard 18 mm tubular housing has flat sides allowing it to be mounted against a flat surface

Solid polyurethane housing for high resistance to shock and vibration

AC/DC models operate up to 264 Vac

Select models have visible beams for quick setup and alignment

Gain adjustment ensures peak optical performance

LED output status indicator

Extra long 3m cable

Approvals

—

Notes

For additional product detail, see Technical Data and Specifications on **Page V8-T11-6**.

① Range varies with fiber.

E64 Terminal Base Series

**Overview**

This flexible sensor family provides stability indication, high current relay output and easy terminal wiring

Sensing Types and Ranges

Thru-beam: 33 ft
 Reflex: 16.4 ft
 Polarized reflex: 11.5 ft
 Diffuse reflective: 35 in

Product Features

High performance optics

Built-in multi-voltage power supply for use in AC or DC applications

Terminal connections with 1/2 in NPT conduit entrance

Available with optional delay timer, adjustable from 0.6 to 16 seconds and field settable for Normal, ON Delay, OFF Delay, ON-OFF Delay or One Shot Delay

Approvals

CE



E65 Miniature Series

**Overview**

These compact sensors are ideal for a wide variety of applications including reliable detection of clear objects

Sensing Types and Ranges

Thru-beam: 16.5 ft
 Polarized reflex: 5.8 ft
 Diffuse reflective: 4 and 20 in
 Fixed focus diffuse: 0.5 in
 Plastic fiber optic: ①
 Clear object sensor: 24 in

Product Features

Complete line of miniature sensors including clear object detection models

Forward or right-angle viewing with identical optical performance

Stability indicator

Fiber optic models include built-in DIN rail mounting clip

Approvals

UL® Recognized
 CE



11 Series



Overview

The 11 Series is a highly configurable photoelectric sensor with multiple output options including a high current DPDT relay

Sensing Type and Range

Reflex: 20 and 30 ft

Product Features

Quick disconnect base for easy installation and maintenance

Optional logic module provides time delay functions for ON, OFF or both ON/OFF

Approvals

UL



Notes

For additional product detail, see Technical Data and Specifications on **Page V8-T11-6**.

① Range varies with fiber.

20 Series



Overview

These heavy-duty sensors are designed for use in harsh environments with constant exposure to weather and physical abuse

Sensing Types and Ranges

Thru-beam: 700 ft
 Reflex: 35 and 75 ft
 Diffuse reflective: 8 ft
 Defined range diffuse reflective: 15 in

Product Features

Sets the industry standard for rugged construction and long range performance
 Interchangeable logic modules and output devices are contained inside the sealed housing
 Ideal for outdoor use

Approvals

UL Listed
 CSA® Certified



Listed

50 Series



Overview

These high performance sensors feature interchangeable outputs and logic functions in a fully sealed, self-contained package

Sensing Types and Ranges

Thru-beam: 100 ft
 Reflex: 30 ft
 Polarized reflex: 15 ft
 Diffuse reflective: 10, 24 and 72 in
 Glass fiber optic: ①

Product Features

Interchangeable, plug-in output devices and logic modules
 Built-in 360° rotation. 10° tilt ball-swivel base
 Fully potted construction for use in areas subject to wash-down, high shock and/or vibration
 Four output options including a 2A SPDT relay

Approvals

UL Listed
 CSA Certified



Listed

55 Series



Overview

These durable sensors offer high optical performance and a built-in swivel bracket for easy and precise alignment

Sensing Types and Ranges

Thru-Beam: 100 ft
 Reflex: 30 ft
 Polarized Reflex: 15 ft
 Diffuse Reflective: 10, 24 and 72 in
 Glass fiber optic: ①

Product Features

Identical to 50 Series except without provision for interchangeable output or logic functions.
 Ideal for direct connection to programmable controllers
 Available in universal voltage AC/DC versions as well as DC only models
 Built-in, 360° rotation. 10° tilt ball-swivel base
 Fully potted construction for use in areas subject to wash-down, high shock and/or vibration

Approvals

UL Listed
 CSA Certified



Listed

60 Series

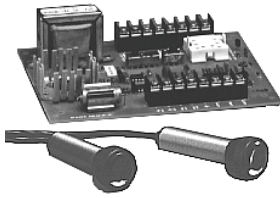

Overview

Separate control units and sensor heads. Control units available in modular plastic units or self-contained with metal case

Sensing Type and Range

Thru-beam: 206 ft

Product Features

High performance thru-beam optics
Control unit can be mounted up to 1000 ft from sensor heads
High temperature sensor heads operate to 212°F (100°C)

Approvals

CSA



Notes

For additional product detail, see Technical Data and Specifications on **Page V8-T11-6**.

① Range varies with fiber.

70 Series



Overview

This high performance family offers a wide choice of sensor heads, control units, output devices, logic modules and accessories to solve virtually any sensing problem

Sensing Types and Ranges

Thru-beam: 15, 32, 369 and 743 ft
Reflex: 23 ft
Curtain-of-light reflex: 6 ft
Diffuse reflective: 36 in
Focused diffuse reflective: 2.5 in
Glass fiber optic: ①

Product Features

Ultra-versatile photoelectric control family
Wide choice of sensor heads, control units, output devices, logic modules, and accessories to solve virtually any sensing problem
Sensor heads may be mounted up to 1000 ft from the control unit
Multiple sensor heads can be connected to a single control unit for special sensing applications
Analog control unit provides a voltage level output proportional to the amount of light received by the sensor detector

Approvals

CSA



80 Series



Overview

These sensors provide extremely long sensing ranges and the flexibility of interchangeable sensor heads and logic modules

Sensing Types and Ranges

Reflex: 50 ft
Diffuse reflective: 12 ft
Focused diffuse reflective: 6 in
Glass fiber optic: ①

Product Features

Combines the advantages of self-contained packaging with the flexibility of interchangeable sensor heads
Nine sensor heads, seven control base units, and three logic modules are available to customize the sensor for your application

Approvals

UL



Technical Data and Specifications

Photoelectric Sensors—Legacy

Description	E58 18 mm Tubular Series	E64 Terminal Base Series	E65 Miniature Series	11 Series	20 Series
Operating voltage	20–264 Vac 10–30 Vdc	16–240 Vac/dc	10–30 Vdc	115–125 Vac 230 Vac	95–130 Vac 100–125 Vac 200–250 Vac
Output function	Light and dark operate models available	Selectable light or dark operate	Selectable light or dark operate	Selectable light or dark operate	Selectable light or dark operate
Maximum load current	AC: 300 mA DC: 250 mA (NPN) 100 mA (PNP)	1A at 250 Vac 2A at 30 Vdc	100 mA NPN or PNP	Varies by output device from 5 mA to 10A	Varies by output device from 5 mA to 10A
Enclosure ratings	NEMA 1, 2, 3, 4, 4X, 6, 12 and 13	NEMA 1, 3, 4, 12 and 13 IP66	NEMA 1, 3, 4, 12 and 13 IP66	NEMA 4 and 13	NEMA 3, 4, 6 and 13
Response time range	1 ms to 10 ms	20 ms	330 microseconds to 2 ms	7 ms	1 ms to 30 ms
Description	50 Series	55 Series	60 Series	70 Series	80 Series
Operating voltage	90–132 Vac at 60 Hz 100–132 Vac at 50 Hz 180–264 Vac at 60 Hz 200–264 Vac at 50 Hz 10–30 Vdc	20–264 Vac and 15–30 Vdc 10–30 Vdc	115 Vac 230 Vac 11–15.5 Vdc	Self-contained control units: 115 Vac or 230 Vac versions Modular control units: 9–18 Vdc	97–130 Vac 204–255 Vac 22–26 Vac 10–30 Vdc
Output function	Selectable light or dark operate	Light and dark operate models available	Selectable light or dark operate	Selectable light or dark operate	Light or dark operate (switch-selected on control unit)
maximum load current	Varies from 50 mA to 2A	AC/DC units: 300 mA DC units: 250 mA (NPN), 100 mA (PNP) Optional three amp SPDT relay (AC/DC models)	Varies by output device from 5 mA to 10A	Varies by output device from 5 mA to 10A	Varies by model from 50 mA to 1A
Enclosure ratings	NEMA 1, 3, 4, 12 and 13	NEMA 1, 3, 4, 6, 12 and 13	Heads: NEMA 3, 4, 6, 12 and 13 Control Units: NEMA 12 (enclosed) NEMA 1 (module)	Varies with control unit or sensor head selected	NEMA 1, 3, 4, 12 and 13
Response time range	2 ms to 18 ms	1 ms to 11 ms	1.6 ms to 16 ms	0.5 ms to 14 ms	5 ms to 18 ms

Limit Switches



Proximity Sensors



Photoelectric Sensors



12.1 Sensor Learning Course—Learning Module 23: Limit Switches, Proximity Sensors and Photoelectric Sensors

Overview—Eaton University Training	V8-T12-2
Welcome	V8-T12-4
Sensor Basics	V8-T12-4
Review 1	V8-T12-6
Limit Switches	V8-T12-7
Actuators and Operating Heads	V8-T12-9
Limit Switch Types	V8-T12-12
Review 2	V8-T12-14
Inductive Proximity Sensors	V8-T12-15
Review 3	V8-T12-17
Inductive Proximity Sensor Influences	V8-T12-18
Review 4	V8-T12-20
Capacitive Proximity Sensors	V8-T12-21
Capacitive Proximity Sensor Influences	V8-T12-22
Review 5	V8-T12-23
Photoelectric Sensors	V8-T12-24
Photoelectric Sensor Styles and Uses	V8-T12-26
Modes of Detection	V8-T12-27
Review 6	V8-T12-29
Excess Gain	V8-T12-30
Environment	V8-T12-32
Review 7	V8-T12-32
Sensor Output Circuits	V8-T12-33
Switching Logic	V8-T12-36
Output Timing Modes	V8-T12-37
Review 8	V8-T12-38
Enclosure Ratings	V8-T12-39
IEC Ratings	V8-T12-40
Review Answers	V8-T12-41

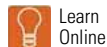

For Customer Service in the U.S. call 1-877-ETN CARE (386-2273),
in Canada call 1-800-268-3578.
For Application Assistance in the U.S. and Canada
call 1-800-426-9184.

Limit Switches, Proximity Sensors and Photoelectric Sensors



Contents

<i>Description</i>	<i>Page</i>
Learning Module 23: Limit Switches, Proximity Sensors and Photoelectric Sensors	
Welcome	V8-T12-4
Sensor Basics	V8-T12-4
Limit Switches	V8-T12-7
Actuators and Operating Heads	V8-T12-9
Limit Switch Types	V8-T12-12
Inductive Proximity Sensors	V8-T12-15
Inductive Proximity Sensor Influences	V8-T12-18
Capacitive Proximity Sensors	V8-T12-21
Capacitive Proximity Sensor Influences	V8-T12-22
Photoelectric Sensors	V8-T12-24
Photoelectric Sensor Styles and Uses	V8-T12-26
Modes of Detection	V8-T12-27
Excess Gain	V8-T12-30
Environment	V8-T12-32
Sensor Output Circuits	V8-T12-33
Switching Logic	V8-T12-36
Output Timing Modes	V8-T12-37
Enclosure Ratings	V8-T12-39
IEC Ratings	V8-T12-40
Review Answers	V8-T12-41

Overview—Eaton University Training

Limit Switches, Proximity Sensors and Photoelectric Sensors

Knowledge Powers Success.

It takes knowledge to succeed. But, knowledge doesn't just happen. It's a continuous process of learning. Only lifelong learning allows you to keep in step with a world that is constantly changing.

So, you need to get smarter about learning and explore new ways of thinking. You need to take advantage of new experiences and employ cutting edge technologies.

Assess and develop your talents. Empower yourself to find the answers and solutions of tomorrow.

Learn. Succeed.

Training at Eaton Corporation

Sensor Learning Course

The following pages contain a complete learning course that will take you through the basic operation and application of limit switches, inductive and capacitive proximity sensors, and photoelectric sensors. Whether you're a novice looking to get up to speed fast, or are already experienced in this area and just want to sharpen your skills, this course will be time well spent.

This course is part of the 101 Basics Series from Eaton University Training, a comprehensive series of learning modules covering a wide variety of power and control subjects.

About Eaton University Training

Eaton University Training exists to keep you, our partners, at the cutting edge of technical and professional development. We provide education solutions, promote a learning culture and foster talent development for our employees, channel partners, industry and academia.

We share our knowledge resources in a number of ways: from traditional classroom to paper-based distance learning programs to a complete web-based virtual learning environment at our electronic campus.

Eaton University Training educational programs put you directly on the path to career success. We partner with you to determine your knowledge needs and help you apply what you learned. And we're committed to ensuring that you gain maximum return from your time and investment.

To browse the latest course offerings and register on-line, visit us at EatonUniversity@eaton.com.

Learning Module 23: Limit Switches, Proximity Sensors and Photoelectric Sensors

**Classroom Interactions**

Eaton University Training classroom activities encourage interaction, collaboration and participation. You play an integral role in what happens. Experienced instructors facilitate a learning environment where you can feel comfortable making mistakes and asking questions. The result is a seamless classroom to on-the-job transition that allows you to directly apply your newfound knowledge, making you and your company more productive and competitive.

- Discover product features, benefits and applications in a product technology solutions seminar
- Gain hands-on experience maintaining electrical equipment or solving simulated power quality problems in one of our state-of-the-art laboratories
- Become qualified in Information Technology solutions by Eaton, such as Bid Manager or Vista, in a computer training class
- Collaborate with your peers in one of our talent development workshops

And it doesn't end there. Eaton University Training offers a full spectrum of personal and professional development options. As new learning needs are identified, our course offerings change to help you meet new challenges.

12

**Virtual Campus**

Our virtual campus offers knowledge resources accessible from anywhere in the world, 24 hours a day, and 7 days a week. It's where you go to register for classroom opportunities, participate in on-line learning courses, or search our library for learning tools including educational videos and technical documentation. You control the content, timing and pace of your learning program.

As technology evolves, Eaton University Training commits to giving you access to the most effective learning tools—right from your desktop.

As an Eaton distributor, you can access Eaton University via the Distributor Resource Center on www.eaton.com. Employees can access us on the Eaton University Intranet.

Customized Learning

Can't find what you're looking for? Please contact us. Eaton University Training has course consultants that work with you to customize a class or make recommendations based on your personal needs.

For example:

- Bring a class to your location, saving you time away from the plant or office
- Customize an existing class, placing emphasis on the subjects your group needs most
- Receive Eaton University product training outside of the regularly scheduled courses
- Connect with technical experts who will answer your specific questions

Start planning your customized learning. E-mail us at EatonUniversity@eaton.com.

We look forward to helping power your success.

Eaton University Training at Eaton Corporation ...

Knowledge Powers Success.

Welcome

Typical Sensors



Welcome to Module 23, which is about **sensors**. As the name implies, **sensors are devices that sense the presence or absence of objects**. Sensors perform a number of functions in automated manufacturing and material handling systems. For example, sensors can determine if an object is present, if tooling is broken, or if product is running down a conveyor line.

This module will take you through the basic operation and application of three major sensor categories: **Limit Switches, Proximity Sensors and Photoelectric Sensors**.

Like the other modules in this series, this one presents small, manageable sections of new material followed by a series of questions about that material. Study the material carefully then answer the questions without referring back to what you've just read. You are the best judge of how well you grasp the material. Review the material as often as you think necessary. The most important thing is establishing a solid foundation to build on as you move from topic to topic and module to module.

A Note on Font Styles

Key points are in **bold**.

12

Sensor Basics

A manual switch enables an operator to interact with a machine. If, for example, an operator sees a problem on a manufacturing line, he could move a switch to stop the line. Or, think of a light switch in your home. If you (the operator) want the light turned on, you have to move the switch.

A sensor can be thought of as an automatic switch. In a factory, a sensor can be used to detect a problem on the line and stop the line automatically. Or, in your home, a sensor could be used as a security device to detect an open window or door.

Sensors have contributed significantly to recent advances in manufacturing technology. Using a sensor makes a process or system more automated and removes the need for human operators to monitor and control the situation.

The three main categories of sensors are limit switches, proximity sensors and photoelectric sensors. Let's take a moment to look at each type of sensor.

Limit Switch

Limit Switch with Standard Roller Lever



A limit switch is an electromechanical device.

A part of the limit switch, called an Actuator, is placed in the path of an oncoming object, such as a box on a conveyor. When the object contacts the actuator, the contacts in the limit switch are opened (or closed, depending on the limit switch's design) to stop (or start) the flow of current in the electrical circuit.

Proximity Sensor

Proximity Sensor Types



This type of sensor uses an electromagnetic field to detect when an object is near.

There is no physical contact between the object and the sensor. Inductive proximity sensors detect only metal objects. Capacitive proximity sensors can sense both metallic and non-metallic objects.

Think of a manufacturing process where the alignment of a part is critical. A proximity sensor can be used to make sure the part is aligned within a certain tolerance. If the part is not properly aligned, the proximity sensor will be triggered.

This type of sensor is generally used to sense at distances less than one inch.

Photoelectric Sensor



This type of sensor uses light to detect the presence or absence of an object.

A **Thru-Beam** photoelectric sensor uses two devices (a light source and a detector) facing each other. Detection occurs when an object blocks or breaks the beam of light passing between them.

Thru-Beam – Beam Complete

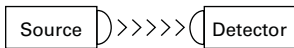

Thru-Beam – Object Detected

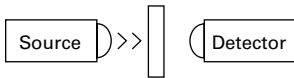

A **Diffuse Reflective** sensor emits a light beam that must be reflected back to it by the target object itself for detection to occur.

Diffuse Reflective – Beam Not Complete

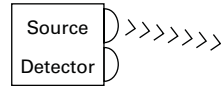

Diffuse Reflective – Object Detected

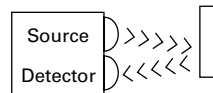

A **Retroreflective Sensing** sensor emits a light beam that is reflected back to the sensor from a retroreflector. When an object blocks the beam between the sensor and the retroreflector, detection occurs. We'll cover more on these types of photoelectric sensors later in this module.

Retro-Reflective/Reflex Mode – Beam Complete

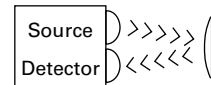

Retro-Reflective/Reflex Mode – Object Detected

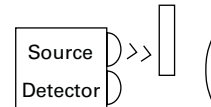

Most electric garage door openers include a photoelectric sensor for safety reasons. If the photoelectric sensor's beam is broken (by a child for example) as the door is going down, the sensor signals the door opener to reverse the direction of the door.

Although environmental factors can affect photoelectric sensors, these devices have a long sensing range. The objects they detect can be of any material.

Sensor Comparison

Each of the three sensor categories has its strengths and weaknesses.

The table below provides you with a comparison.

Sensor Category Comparison

	Limit Switches	Proximity Sensors	Photoelectric Sensors
Method of Detection	Physical contact	Electromagnetic field	Light beam
Sensing Range	Physical contact	Close: within 1 in (25.44 mm)	Far: can be 800 ft (243.8m)
Target Material	Target must be able to withstand physical contact	Inductive: metallic only Capacitive: metallic and non-metallic	Can be affected by target surface, for example, if the target is shiny or transparent
Object Markings	Not able to detect	Not able to detect	Able to detect
Cost	Low	Low	Low to high depending upon sensing method
Sensor Size	Tend to be large	Small to large	Very small (fiber optic) to large
Environmental Sensitivity	Affected by debris	Inductive: electrical interference Capacitive: humidity	Light interference
Response Time	Milliseconds	Milliseconds	Microseconds

In the Workplace

As a conveyor moves the stacked boxes onto a turntable, a sensor detects the boxes in position and tells the machine to start the turntable and index the wrapping material. Another sensor monitors the play out of wrapping material to detect an empty spool and alert set-up personnel. Once the operation ends, the wrapped boxes move on to their shipping destination.

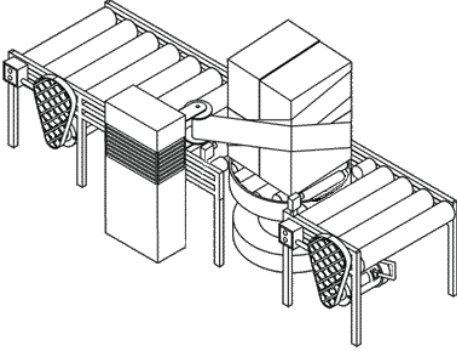

The Sensor “Sees” the Box and Tells the Wrapping Machine to Begin Operating

Thanks to sensors, the repetitive and tedious work done in this factory is handled precisely and reliably by machinery and control systems working together.

Review 1

Answer the following questions without referring to the material just presented. Begin the next section when you are confident that you understand what you’ve already read.

1. Sensors can detect the _____ or _____ of objects.
2. The three main sensor categories are:

3. A limit switch is an _____ device that relies on physical contact with the target.
4. The sensor type that can only detect metallic objects is the _____ sensor.
5. The sensor type that uses a broken beam of light to detect objects is commonly referred to as a _____ sensor.

Answers to Review 1 are on **Page V8-T12-41**.

Limit Switches

Let's now take an in-depth look at the limit switch. It is a commonly used device. If you look around your kitchen, you can find a number of limit switches. For example, limit switches stop your microwave oven from operating unless the door is closed, and they ensure the light in your refrigerator is only on when the door is opened.

Remember, a **limit switch is a mechanical device that requires the physical contact of an object with the switch's actuator to make the contacts change state.** The term limit switch is derived from this operation of the switch. As the object (or target) makes contact with the operator of the switch, it eventually moves the actuator to the "limit" where the contacts change state.

Limit Switch with Adjustable Roller Arm



This mechanical action either opens (in a **Normally Closed [NC]** circuit) or closes (in a **Normally Open [NO]** circuit) the electrical contacts. The contacts then start or stop the flow of current in the electrical circuit.

The switching function can be used to control loads from simple relays to high-current solenoids, from logic devices to PLCs.

Strengths and Weaknesses

As with all devices, the limit switch has its strengths and weaknesses:

Limit Switch Attributes

Attributes

Strengths

Can be used in almost any industrial environment because of its rugged design

Can switch high inductance loads up to 10 amps

Very precise in terms of accuracy and repeatability

Low cost

Weaknesses

Moving mechanical parts wear out

Must touch target to sense

Relatively slow (five times/sec.) compared to electronic devices

Applications

Limit switches are used in a variety of applications. Consider these:

Limit switches can be used to turn off a washing machine if the load becomes unbalanced. In automobiles, they turn on lights when the door is opened.

In industry, limit switches are used to limit the travel of machine parts, sequence operations or to detect moving items on a conveyor system.

Limit Switch Components

A limit switch consists of three main components.

Limit Switch Components

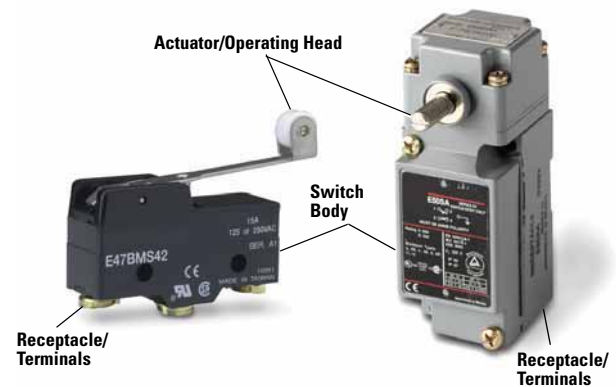

The **actuator** is the part of the limit switch that physically comes in contact with the target. In some limit switches, the actuator is attached to an **operating head**. The operating head translates a rotary, linear or perpendicular "triggering" motion into the motion type needed to open or close the electrical contacts of the switch.

The **switch body** is the component that contains the electrical contact mechanism.

The terminal screw or screw/clamp assembly necessary for wiring is referred to as the **receptacle**.

In the Workplace

At the Marathon T-Shirt Company, boxes of apparel approach the end of the packaging line, ready to be stacked onto pallets. A palletizer with suction-cup grippers picks up a box and swings it around to a waiting pallet.



A Limit Switch in Action

How does the unit know it has reached its sixth layer of boxes? When the pivot arm reaches the top of its vertical travel rod, the arm hits a limit switch. The switch signals the system to send the full pallet down line and sets up an empty pallet to restart the process.

Limit Switch Movement

Let's take a closer look at what actually happens as a limit switch is activated. Imagine a target object moving toward a limit switch actuator.

Limit Switch Movement

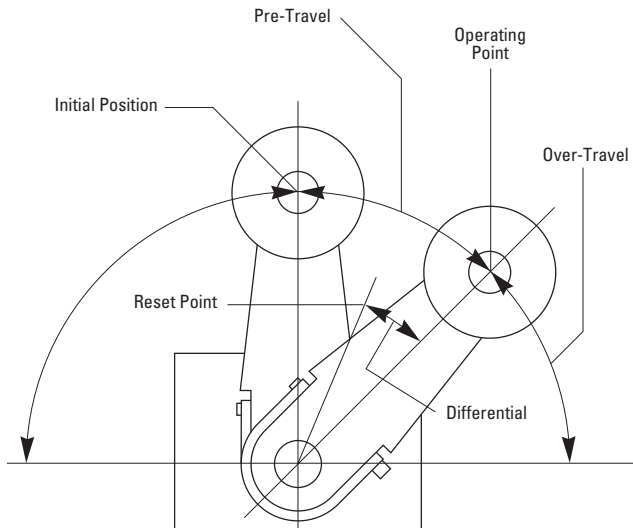

1. The actuator is at its **initial position**. The limit switch contacts are in their normal "untriggered" position.
2. Contact is made with the target object and the actuator moves its **pre-travel** distance. Contacts are still in their normal "untriggered" position.
3. The actuator reaches its **operating point** where the contacts change from their normal "untriggered" position to their "triggered" position.
4. The **differential** is the difference between the operating and release point. Differential is engineered into the switch to guard against the effects of vibration and rapid ON/OFF oscillations of the switch right at the operating point.

Notes

In the case of a lever actuator, there is some **over-travel** allowing the lever to move beyond the operating point.

On plunger actuators, the overtravel distance is a safety margin for the sensor to avoid breakage.

The actuator begins the return to its initial position. The contacts return to their normal "untriggered" position as the actuator reaches its **release point** and resets the contacts.

Limit Switch Movement Definitions

Here are a few other terms that are used in describing the movement of the limit switch actuator:

The **operating force** is the force required to move the actuating element.

The **minimum return force** is the minimum force required to return the actuator to its initial position.

The **total travel** is the maximum allowable distance the actuating element can travel.

The ability of a switch to repeat its characteristics precisely from one operation to the next is called the switch's **repeat accuracy**.

In the Workplace

Inside this sawmill, a high-speed saw quickly reduces logs to construction beams.



Limit Switches Working Where People Cannot

In the process, chips and dust hang in the air. Breathing is impossible in the area without a mask. Even with goggles, it would be impossible to inspect the cutting.

The production department devised a system of limit switches to do the inspecting automatically. A remote operator can configure a set of limit switches to allow the log to be cut to the desired dimensions.

Actuators and Operating Heads

Choosing the proper actuator (also called an **operating head**) for a limit switch depends on a number of application-specific factors. **To select an actuator, you need to know shape, speed, direction and total travel specifications.**

Operating heads fall into two broad types: **Maintained Contact** and **Momentary Contact**. Momentary contacts return to their normal state as soon as the actuator passes its release point. This type of operating head is also called “spring-return.”

With a maintained contact operating head, the contacts remain in the “triggered” position even after the actuator has been released. They are reset only by further mechanical action of the operating head. For example, on rotary operating heads, the contacts are reset by rotation in the opposite direction.

Actuators can take the form of rotary levers or plungers. We will look at specific actuator types on the next few pages.

Rotary Lever Actuators





A typical lever actuator functions something like this: **a cam or plate hits the end of the lever arm, which rotates a shaft and operates the contacts in the switch.**

The rotation may be momentary (spring-returned) or maintained. A lever arm can be a rod or a roller of a fixed or adjustable size. It may be made from any number of materials.



A rotary lever actuator is usually the best choice for the majority of applications. It can be used in any application where the cam moves perpendicular to the lever’s rotational shaft. This type of actuator also offers the benefit of a long life.

Let’s take a look at the different rotary lever actuator types available.

Rotary Lever Actuators and Limit Switches

	Lever Type	Application
	Standard roller	Used for most rotary lever applications. Available in various lengths. Roller typically made of Nylatron® for smooth operation and long wear.
	Ball bearing roller	Used where abrasive dust would cause undue wear of standard nylatron rollers. Also used with high-speed cams.
	Adjustable length	Used where the length of arm required is not known when devices are ordered or where the target size or location may change from day to day. An operator can adjust the arm length before beginning production.
	Forked	Used with maintained contact style switches. When rollers are on opposite sides, one cam will trip the switch and the second will reset the switch. When rollers are on the same side, one cam trips and resets the switch. Applied where the target approaches from two sides, such as a grinder that works back and forth.
	Offset	Used to obtain different cam track dimensions.

Rotary Lever Actuators, continued

	Lever Type	Application
One-Way Roller 	One-way roller	Used with reversible cams where operation in one direction only is required.
Rod or Loop 	Rod or loop	Used where unusual shape is required. Rod is typically made of steel or nylon. The loop is made of Nylatron.
Spring Rod 	Spring rod	Used on conveyors where jam-ups may occur. Flexible rod moves in any direction and eliminates damage to arm or switch.

12





Plunger Actuators

A typical plunger actuator functions something like this: **a cam or plate hits the end of the plunger, which is pressed in and operates the contacts in the switch.**





A plunger actuator is the best choice to monitor short, controlled machine movements, or where space or mounting restrictions will not permit the use of a lever actuator.

Lets take a look at the different plunger actuator types available.

Plunger Actuators of Various Limit Switches

	Lever Type	Application
Top Push Rod 	Top push rod	Actuation must be done in line with plunger axis. Care should be taken to avoid exceeding the overtravel stated by the manufacturer. A mechanical stop should be used where the possibility of overtravel exists.
Side Push Rod 	Side push rod	Should be used where the mounting permits operating from the side only and not the top. As with the top push rod, avoid exceeding recommended overtravel. Available in both momentary and maintained styles.
Top and Side Push Roller 	Top and side push roller	The function is similar to push rod styles, except there is a roller attached to the end of the rod. Typically used where a lever arm will not fit for lateral actuation. Roller can be positioned either vertically or horizontally.
Pin 	Pin	Most often used where extremely small differentials and operating forces are required.

Plunger Actuators, continued

	Lever Type	Application
<p>Straight</p> 	Straight	Used where the actuating element travels in same axis as plunger. Available in standard and extended lengths.
<p>Lever</p> 	Lever	Used in applications where the cam actuates in line with the plunger but may require a larger differential or where an appreciable side thrust is present.
<p>Roller Level</p> 	Roller level	Used in applications where the cam will pass by the switch laterally.
<p>Roller Plunger</p> 	Roller plunger	Used in applications where the cam may present some degree of side thrust. Roller helps deflect this.
<p>Cat Whisker and Wobble Stick</p> 	Cat whisker and wobble stick	Typically used in conveyor applications to count objects as they pass by. Can be actuated in any direction.

Mounting Considerations

When applying mechanical limit switches, consideration of the type of actuation needed, the mounting locale of the device and the speed of actuation are very important.

Cam Design

The cam angle should equal the lever arm angle for applications where the cam will not overtravel the actuator. Where relatively fast motions are involved, the cam should be of a shape that does not allow the actuator to receive a severe impact, or that releases the actuator suddenly allowing it to snap back freely.

Cam Design

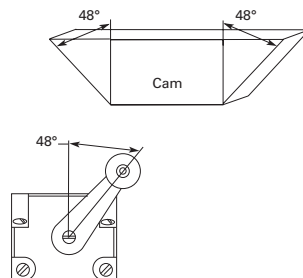

When using side-push or top-push plunger actuators, be sure the cam operates in line with the push rod axis. **Do not use the limit switch body to act as a mechanical stop for the cam in overtravel applications.** Some other type of barrier must be provided as the stop.

Mounting Location

Limit switches should never be mounted in locations that could allow false operations by normal movements of operator or machine components. They should be mounted rigidly, be maintenance accessible and have the cover plate facing that access point.

If liquid intrusion is a possibility, the switch should be mounted face down to allow gravity to prevent seepage through the seals on the operating head. All conduit connections should be tightly sealed.

In applications where machining chips or other debris accumulates, the limit switch should be mounted in a location, or at such an angle, that minimizes buildup on the operating head.

In the Workplace

At this leading frozen food processor, an automatic pallet stacking system is used. This system uses a wobble stick limit switch to detect when the pallets have been loaded to their desired level.

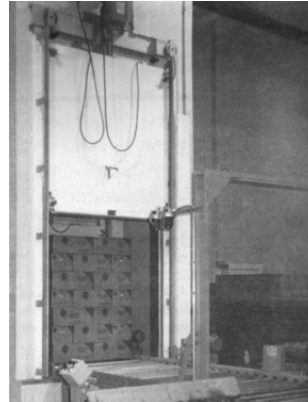

Into the Freezer

The switch then signals the conveyor to send the load through an automatic vertical rise door into the freezer for quick freezing.

Limit Switch Types

There are three basic classifications of limit switches available.

- Standard industrial
- Hazardous location
- Precision

Let's spend some time looking at each.

Standard Industrial Switch

Often the first choice for industrial applications, this switch functions in a variety of rugged industrial environments. **This type of switch can be subjected to oil, grease, dirt, high-pressure wash-down, shock, vibration, and so on.** Typically, these devices meet NEMA® enclosure ratings of 1, 3, 3S, 4, 6, 12 and 13. An explanation of these ratings can be found in "Enclosure Ratings" on **Page V8-T12-39**.

Standard Industrial Switch



- ① Actuator/Operating Head
- ② Switch Body
- ③ Receptacle/Terminals

Most limit switches on the market today are a plug-in type design, which means that the operating head, switch body and receptacle are separate components. **If the switch becomes damaged or fails, it can be replaced in the field in less than a minute, without rewiring the switch.** Simply remove the switch body, and the wiring remains intact in the receptacle. The majority of new industrial applications use the plug-in type due to its flexibility and ruggedness.

Non plug-in types are a popular design for **DIN rail mounted limit switches**. These switches are built to meet dimensional and operational standards set in Europe. They have **typically the same electrical contact and enclosure ratings as the regular heavy-duty switches, but often their electrical and mechanical life is not as long.** They are an economical alternative for applications where the switch is not subjected to physical abuse.

Hazardous Location Switch

The hazardous location switch is ideal for use in harsh or dangerous environments. This switch is tough enough to contain an explosion within itself.

The one-piece switch body/receptacle is much heavier and thicker in construction than standard oil-tight switches. Like standard oil-tight switches, hazardous location switches have removable actuating heads attached to the switch body with four screws.

Hazardous Location Switch



This switch type generally meets NEMA 1 requirements, and the hazardous location requirements of NEMA 7, Class I, Groups B, C and D; and NEMA 9, Class II, Groups E, F and G. Some manufacturers offer models rated NEMA 4X and 13 as well (see “Enclosure Ratings” on **Page V8-T12-39** for more information).

Precision Limit Switch

The precision limit switch is widely used in both commercial and industrial applications, ranging from appliances to farm equipment. It is **often chosen for its precise operating characteristics, small size and low cost.**

Precision Limit Switches



Precision switches are typically available in two types: basic precision and enclosed precision. The basic precision switch is of one-piece construction. The enclosed precision switch is simply a basic switch inside a die cast housing. Basic precision switches are generally not given a NEMA enclosure rating, while some enclosed precision switches can be rated NEMA 4 or 13.

Special Purpose Limit Switch

Some applications require a limit switch to perform a special detection function. Let's take a look at some of the special purpose limit switches.

Special Purpose—Safety Guard



This type of switch is used to ensure safety for the operator of a dangerous machine. A standard limit switch could be false tripped or false actuated, posing a danger to the person operating the machine.

Actuation of this switch occurs only when a keyed interlock is inserted into the key slot. The key is usually mounted on a safety door or machine guard so that when it is closed, the key slides into the slot, actuating the switch.

Special Purpose—Gravity Return

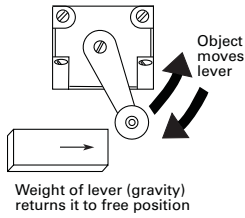

Unlike other rotary limit switches, this switch has no spring return mechanism. **The weight of the operating lever must provide the force to return it to its free position.** This switch is usually mounted with the operating head facing down.

It is often used in applications where very low operating forces from the target are required.

Special Purpose—Neutral Position

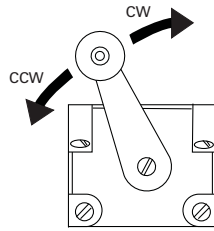

With this limit switch, the **direction of operation can be detected.**

One set of contacts is actuated when the lever is moved in one direction, and a second set of contacts is actuated when the lever is moved in the other direction.

Special Purpose—Two Step

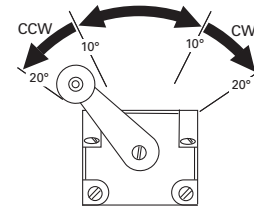

This switch **operates to perform two functions with one switch.** One set of contacts is activated after the lever is rotated 10°, and another set is activated at a 20° rotation (in the same direction).

This switch can monitor an object's height, orientation, position, completeness of assembly, and so on.

In the Workplace

In some manufacturing plants, rooms need to be closed off quickly because of contamination or fire. To help facilitate this process, high-speed doors have been developed. These doors may move as quickly as six feet per second.

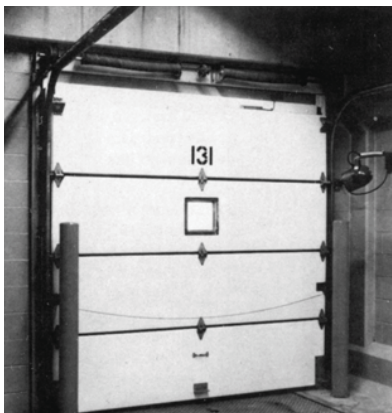

Limit Switches Help Operate This High-Speed Door

At such speeds, the door would destroy itself quickly, if not for the use of limit switches. The limit switches are used to slow the door just before it is fully opened or fully closed.

Review 2

Answer the following questions without referring to the material just presented. Begin the next section when you are confident that you understand what you've already read.

- The three main components of a limit switch are:

Match the terminology to the proper description:

- | | | |
|---|------------|---|
| 2. Initial position | _____ | A. Distance the actuator can travel safely beyond the operating point |
| 3. Pre-travel distance | _____ | B. Maximum allowable distance the actuator can travel |
| 4. Operating point | _____ | C. Actuator and contacts are in the normal, or untriggered position |
| 5. Overtravel | _____ | D. Actuator's position at which the contacts change state |
| 6. Release point | _____ | E. Actuator position where the contacts are reset to their normal "untriggered" state |
| 7. Total travel | _____ | F. Actuator travel from contact with the target until the operating point |
| 8. The ability of a switch to repeat its characteristics from one operation to the next is called the switch's repeat accuracy. | TRUE FALSE | |

Answers to Review 2 are on **Page V8-T12-41.**

Inductive Proximity Sensors

The inductive proximity sensor can be used to detect metal objects. It does this by creating an electromagnetic field.

With the ability to detect at close range, inductive proximity sensors are very useful for precision measurement and inspection applications.

Strengths and Weaknesses

Inductive Proximity Sensor Attributes

Attributes

Strengths

Immune to adverse environmental conditions

High switching rate for rapid response applications

Can detect metallic targets through non-metallic barriers

Long operational life with virtually unlimited operating cycles

Solid-state to provide a "bounce free" input signal to PLCs and other solid-state logic devices

Weaknesses

Limited sensing range (4 in or 100 mm maximum)

Detects only metal objects

May be affected by metal chips accumulating on sensor face

Applications

Proximity sensors are used in a variety of applications. Consider these:

Proximity sensors can be used to detect the end of travel on a positioning table, to determine speed by counting a gear's teeth, or be used to check if a valve is fully opened or closed.

Proximity sensors can be used to detect the presence or absence of a metallic workpiece or metallic pallets on conveyor lines.

When a robot arm swings around for a pick and place operation, a proximity sensor makes sure the arm actually has a part in its grippers.

In metal machining, proximity sensors can make sure the workpiece is mounted in the fixture, and that the drill bit has not broken off.

How an Inductive Proximity Sensor Works

Inductive proximity sensors produce an oscillating and invisible radio frequency (RF) field at the sensor face. When metal objects are brought into this field, this oscillating field is affected. Each type and size of sensor has a specific sensing range switch point so that metal target detection is very accurate and repeatable.

The presence of a metallic target interrupts the field and alters (by **damping**) the current in the sensor coil (**eddy current** kill) causing the detector circuit to sense the change. The sensor then triggers an output to a connected device.

Components

Let's look at the components and the process step-by-step:

Components

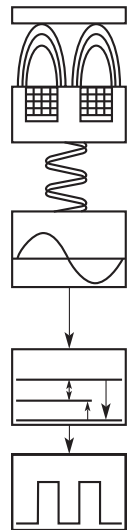

A metal object, or target, enters the sensing field.

The **sensor coil** is a coil of wire typically wound around a ferrite core. If you could see the electromagnetic field created by it, it would be cone shaped. The target will pass through this field.

The ferrite core shapes the field and the size of the coil determines the sensing range.

The **oscillator circuit** causes the field to cycle at a specific set radio frequency (100 kHz to 1 MHz). The presence of metal causes a change in the oscillation, and an eddy current forms on the target. The metallic object **induces** a change in the magnetic field. This change creates a damping effect on the amount of signal that cycles back to the sensor coil.

The **detector circuit** senses the change and switches ON at a particular set point (amplitude). This ON signal generates a signal to the solid-state output.

The **output circuit** remains active until the target leaves the sensing field. The oscillator responds with an increase in amplitude, and when it reaches the set point, the detector circuit switches OFF. The output returns to its normal state.

Hysteresis

Hysteresis is an engineered-in difference between the ON and OFF points.

If they were exactly the same point, there would be a chattering—a very rapid on-off-on-off cycle. That would cause a lot of needless stress on components activated by the circuit.

Hysteresis

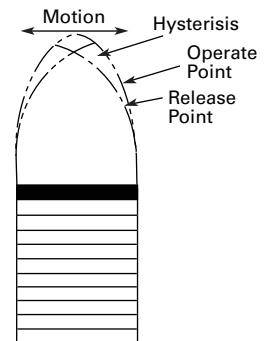







With hysteresis, the **operate point** and the **release point** are slightly different distances from the sensor face.

Proximity Sensor Types

Proximity sensors come in a wide variety of designs to meet the requirements of almost any industrial application. Let's take a brief look at the types that are available.

Proximity Sensors

	Type	Application
Modular Limit Switch Type 	Modular limit switch type	The modular design can be tailored for many application types. Components can be easily switched out for short-run manufacturing changes.
Unitized Limit Switch Type 	Unitized limit switch type	The sealed body protects the components in corrosive environments.
Tubular 	Tubular	This is the design of choice for a growing number of applications. The small size allows for easy mounting in a fixture or for use in tight spaces found on many assembly lines.
Right Angle Tubular 	Right angle tubular	This style enables mounting in tight locations.
High Current Tubular 	High current tubular	Enables the smaller tubular design to carry extremely large inrush and continuous currents. Excellent for heavy equipment such as lift trucks.
Composite Housing 	Composite housing	This corrosion-resistant unit performs well in high wash-down areas such as food processing, or places where caustic chemicals abound.
Pancake 	Pancake	The extra wide coil on this unit achieves the widest and farthest range available: 3.94 in. Ideal for oil rig applications and assembly of large parts.

In the Workplace

Without proximity sensors, the tips of the digits on the grippers of a robotic arm would be numb.



Proximity Sensors Allow a Robotic Arm to Safely Handle Fragile Components

Coupled with the robot's software control program and the responsive sensing ability of proximity sensors, a robot can grasp an object and not crush it.

Review 3

Answer the following questions without referring to the material just presented. Begin the next section when you are confident that you understand what you've already read.

1. Match the sensor component name to the correct picture.

1 a. Oscillator _____
 b. Output _____
 c. Detector _____
 d. Sensor coil _____

2

3

4

Match the proximity sensor component with its function.

- | | | |
|----------------|-------|---|
| 2. Sensor coil | _____ | A. Sets up an electromagnetic field to create a wave pattern |
| 3. Oscillator | _____ | B. Alerts the electrical circuit that an object has been detected |
| 4. Detector | _____ | C. Shapes the electromagnetic field |
| 5. Output | _____ | D. Looks for a change in frequency |
6. Hysteresis is the gap between the operate point and the release point to smooth the operation of the sensor. TRUE FALSE

Answers to Review 3 are on **Page V8-T12-41**.

Inductive Proximity Sensor Influences

When applying inductive proximity sensors, it is important to understand the sensing range and the factors that influence that range. **The sensing range refers to the distance between the sensor face and the target.** It also includes the shape of the sensing field generated through the coil/core.

There are four main concerns when selecting and applying proximity sensors:

- Target considerations (material, size, shape and approach)
- Coil size and shielding
- Sensor mounting requirements
- Environment

12

Target Material

You need to know the target's material. This information will help you determine the maximum sensing distance. Exceed this distance, and the damping effect necessary to trip the sensor's output will not be created—and the sensor will fail to sense the target.

Proximity sensors work best with ferrous metals.

Though these sensors detect other metals, the range will not be as great. Generally, the less iron in the target, the closer the target has to be to the sensor to be detected.

Manufacturers generally provide charts showing the necessary correction factors for various types of metals when applying their sensors. Each sensor style will have a correction factor to enable calculation for a particular target material.

Target Size

The size of the target also matters. If you run a target smaller than the sensor's "standard size," sensing range will decrease. This is because a smaller target creates a weaker eddy current. However, a bigger target does not mean a longer sensing range.

The thickness of the target does not impact sensing range much. However, a very thin non-ferrous target can actually achieve a greater sensing range because it generates an eddy current on both sides (known as the foil effect).

So, how big should the target be? **The rule of thumb is: the size of the sensor's diameter, or three times the sensor's sensing range, whichever is greater.**

Target Shape

The shape of the target can have an impact on the sensing range. A round object, or an object with a rough surface can affect the damping effect of the sensor, and may require a closer sensing distance. Using a larger sensor size or an extended range sensor will also minimize this effect.

Target Approach

How the target approaches the sensor matters as well.

When an object comes at the sensor straight on, that's an **axial approach**. With this type of approach, you will need to protect the sensor physically. Allow for 25% overtravel.

Axial Approach

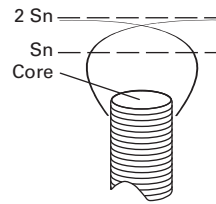

Hysteresis tends to be greater for an axial approach than a lateral approach.

Lateral Approach

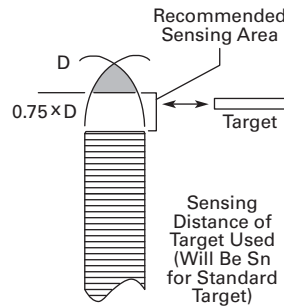

On a slide-by, or **lateral approach**, the target approaches the center axis of the sensing field from the side.

The target should not pass closer than the basic tolerance built into the machine design. Targets bumping into your sensor are a sure guarantee of eventual poor sensor performance.

For both approach types, make sure the target passes not more than 75% of the sensing distance from the sensor face. It is in this "tip" area that variations in the sensing range occur.

Coil/Core Size

An important factor in the range of the sensor is the construction of the coil/core. An open coil with no core will produce a field that could be actuated by a target from any direction. That wouldn't be very practical for industrial applications.

For an inductive proximity sensor, the sensor **coil** that generates the field fits inside of a ferrite core. This cup-shaped piece of ferrite material is called a **cup core**. This core directs the field and shapes it.

Coil/Core Construction

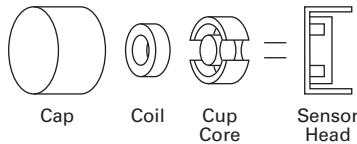

A protective **cap** prevents dust or other environmental hazards from entering the sensor.

Mounting Considerations

A shielded sensor can be fully **embedded** in a metal mounting block without affecting the range. It is sometimes referred to as a flush mount sensor.

A non-shielded sensor needs clearance around it (called the metal-free zone) which is determined by its sensing range. Otherwise, the sensor will sense the metal mounting and be continuously operating.

The design of a sensor can affect how it is mounted.

Mounting two sensors closely together can also be a problem. If you position two proximity sensors too close together—either side by side or facing each other head to head—the two fields will clash with one another. **Each sensor needs to be mounted at least three times its own sensing range away from the other.** The use of an alternative frequency head on one of the sensors will prevent adjacent sensors' sensing fields from interacting.

Clear Zone

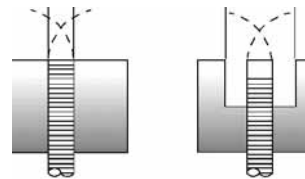

Shielding

To focus the intensity of the field, the coil can be **shielded**. In a standard range sensor, the ferrite cup core shapes the field to emanate straight from the sensing face of the sensor. In a sense, shielding it.

An extended range coil/core assembly does not use the standard cup core, just a core of ferrite. This **unshielded** device allows the extension of the sensing range. There is less ferrite to absorb the electromagnetic field, so its range is wider and a little longer.

The decision to use a non-shielded sensor will impact the mounting of the sensor, as we will discuss that next.

Shielding

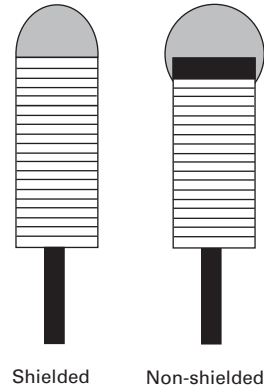

In the Workplace

At an auto manufacturing plant, a drilling operation is performed on the valve blocks to allow for mounting the cover plates. The operation is totally unmanned.



An Inductive Proximity Sensor Monitors Drilling Operation

The drill bit must form holes in an extremely hard material. Breaking drill bits is a fairly common occurrence. For this reason, a proximity sensor is in place. If a break occurs, the sensor signals the system to stop the operation so the drill bit may be replaced.

Environment

The sensor's environment can affect its performance dramatically. Let's take a look at some of these environmental factors.

Debris can accumulate on the sensing cap, changing the range of the sensing field. In an application where metal chips are created, the sensor should be mounted to prevent those chips from building up on the sensor face. If this is not possible, then coolant fluid should be used to wash the chips off the face. An individual chip generally doesn't have enough surface area to cause the sensor to turn on, but several of them could extend the sensing range and interfere with the accuracy of the sensor.

Magnetic fields caused by electrical wiring located in the vicinity may affect sensor operation. If the field around the wires reaches an intensity that would saturate the ferrite or the coil, the sensor will not operate. Sensors used in areas with high frequency welders can also be affected. To compensate for a welder, weld field immune sensors can be installed. Or, if the sensor is used with a PLC, a time delay can be programmed to ignore the signal from the sensor for the time period that the welder is operating.

Radio transceivers (such as a walkie-talkie) can produce a signal with the same frequency as the oscillator circuit of the sensor. This is called radio frequency interference (RFI). Most manufacturers have taken steps to provide the maximum protection against RFI and false operation of the sensor.

Electrical interference from nearby motors, solenoids, relays and the like could have an affect on sensor operation as well. **An induced line or current spike** (called a showering arc or EFT) **can cause a false operation of the sensor.** This spike can be produced by the electrical arc created when an electrical/mechanical switch or a contactor closes. If the lines connecting the sensor and these devices are adjacent and parallel to one another, the spike will affect the sensor. Most codes and specifications call for a separation of control and power leads so this is not often a problem.

The ambient temperature can affect sensing range. The effect is referred to as temperature drift. The sensing range can change by as much as $\pm 10\%$.

Because sensing ranges can vary due to component, circuit and temperature variations, along with the effects of normal machine wear, **sensors should be selected based on sensing the target at 75%, and releasing at 125% of the rated sensing distance.**

Sensing Distance Tolerances

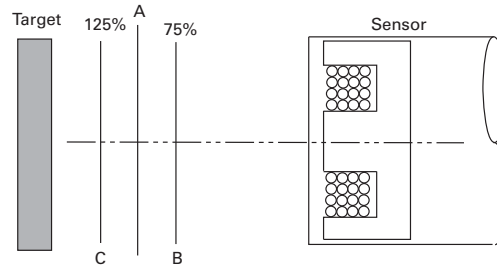

A = Rated Sensing Range
B = Maximum Usable Sensing Range
C = Maximum Reset / Release Range

In the Workplace

On the automated processing line at Harris House Paints, a can would occasionally come through the packaging process without a lid. Lids entered the line through a gravity feed and occasionally a lid would get momentarily hung up.



An Inductive Proximity Sensor Keeps a Lid on Things

By mounting an inductive proximity sensor over the passing cans, the line could reject a can with a missing lid.

Review 4

Answer the following questions without referring to the material just presented. Begin the next section when you are confident that you understand what you've already read.

- Inductive proximity sensors work best with _____ metals.
- The target size rule of thumb is: the size of the sensor's diameter, or three times the sensor's sensing range, whichever is greater. TRUE FALSE
- A target with a rough surface has no impact on the sensing range. TRUE FALSE
- A slide-by approach to the sensor is called a lateral approach. TRUE FALSE
- A straight on approach is called an axial approach. TRUE FALSE
- When two sensors are to be mounted side-by-side, the use of an alternate frequency head on one of the sensors will not prevent the sensors' sensing fields from interacting. TRUE FALSE

Answers to Review 4 are on **Page V8-T12-41**.

Capacitive Proximity Sensors

Let us now turn our attention to another proximity sensor, the capacitive proximity sensor. This sensor operates much like an inductive proximity sensor, but its means of sensing is much different.

Capacitive Proximity Sensors



Capacitive proximity sensors are designed to detect both metallic and nonmetallic targets. They are ideally suited for liquid level control and for sensing powdered or granulated material.

Strengths and Weaknesses

Consider these strengths and weaknesses of the capacitive proximity sensor:

Capacitive Proximity Sensor Attributes

Attributes

Strengths

Can detect both metallic and nonmetallic objects at greater ranges than inductive sensors

High switching rate for rapid response applications (counting)

Can detect liquid targets through non-metallic barriers (glass, plastic)

Long operation life, solid-state output for "bounce free" signals

Weaknesses

Affected by varying temperature, humidity and moisture conditions

Not as accurate as inductive proximity sensors

Applications

Here are some examples showing how the detection power of capacitive proximity sensors is used:

- **Liquid level detection applications**, such as preventing overfilling or underfilling, are common in the packaging industry
- **Material level control applications**, such as assuring that a sleeve of labels on a labeling line is not empty
- **Counting applications**, such as tracking units passing a point on a conveyor
- **Induction molding process**, detection of level of plastic pellets in feed hopper

Operation of the Capacitive Proximity Sensor

A capacitor consists of two metal plates separated by an insulator (called a **dielectric**). **The operation of this type of sensor is based on dielectric capacitance**, which is the ability of a dielectric to store an electrical charge.

The distance between the plates determines the ability of the capacitor to store a charge.

Measuring the change in capacitance as an object enters the electrical field can be used as an ON/OFF switching function.

Capacitor Operation

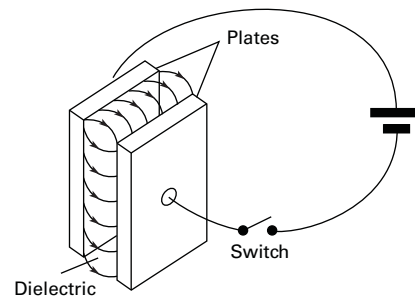

When this principle is applied to the capacitive proximity sensor, **one capacitive plate is part of the switch, the enclosure (the sensor face) is the insulator. The target is the other "plate."** Ground is the common path.

Capacitive proximity sensors can detect any target that has a dielectric constant greater than air. Liquids have high dielectric constants. Metal also makes a good target.

Capacitive Proximity Sensor Operation

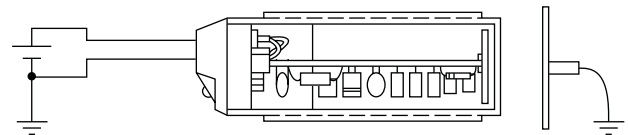

The capacitive proximity sensor has four basic elements: a sensor (which is a dielectric), an oscillator circuit, a detector circuit and an output circuit.

As an object approaches the sensor, the **dielectric constant of the capacitor changes**. The oscillator circuit's **oscillation begins when feedback capacitance is detected**. This is just the opposite in the inductive proximity sensor, where the oscillation is damped when the target is present.

Oscillator Damping

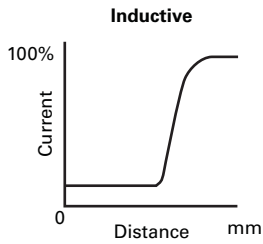

The **detector circuit** monitors the oscillator's output. When it detects sufficient change in the field, it switches on the output circuit.

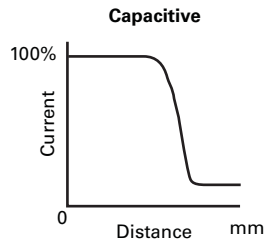

The **output circuit** remains active until the target leaves the sensing field. The oscillator responds with a decrease in amplitude, and when it is no longer receiving sufficient capacitance feedback, the detector circuit switches OFF.

There is a built-in **difference between the operate and release amplitudes to provide hysteresis.**

In the Workplace

As oil pours into this storage tank, a capacitive proximity sensor near the top signals the fill valve to close once the tank reaches capacity.



Capacitive Proximity Sensors in a Liquid Level Detection Application

Another sensor near the bottom alerts the filling system if the level of the tank becomes too low.

Capacitive Proximity Sensor Influences

Many of the same factors that influence the sensing range of inductive proximity sensors, also influence the sensing range of capacitive proximity sensors.

Typically, capacitive sensors have a greater sensing range than inductive sensors.

Sensing distance for capacitive proximity sensors is dependent on plate diameter. With inductive proximity sensors, the size of the coil is the determining factor.

Sensitivity Adjustment

Most capacitive proximity sensors are equipped with sensitivity adjustment potentiometers. Because the sensor measures a dielectric gap, it is important to be able to compensate for target and application conditions and adjust the sensing range.

Target Material and Size

A capacitive sensor should not be hand-held during set up. Because your hand has a dielectric constant greater than air, the sensor may detect your hand rather than the intended target.

Capacitive sensors can detect both ferrous and non-ferrous materials equally well. **There is no derating factor to be applied when sensing metal targets.** But, other materials do affect the sensing range.

Because they can be used to detect liquid through a nonmetallic material such as glass or plastic, you need to ensure that the sensor detects just the liquid, not the container. **The transparency of the container has no effect on the sensing.**

For all practical purposes, the target size can be determined in the same manner as was discussed in "Target Size" on **Page V8-T12-18** for inductive proximity sensors.

Typical Proximity Sensing Ranges

Sensor with a Tubular Diameter of:	Inductive Unshielded Sensor	Capacitive Unshielded Sensor
18 mm	8 mm	15 mm
30 mm	15 mm	25 mm
34 mm	—	35 mm

Environment

Many of the same factors that affect inductive proximity sensors, also affect capacitive sensors, only more so.

- Embeddable mounting—capacitive sensors are generally treated as **non-shielded devices**, and therefore, **are not embeddable**
- Flying chips—they are **more sensitive to both metallic and nonmetallic chips** and residue
- Adjacent sensors—**more space between devices is required** due to the greater, non-shielded sensing range
- Target background—because of both the greater sensing range, and its ability to sense metallic and nonmetallic materials, **greater care in applying these sensors is needed when background conditions are present**

- Ambient atmosphere—the **amount of humidity in the air may cause a capacitive sensor to operate** even when no target is present
- Welding magnetic fields—capacitive sensors **are generally not applied in a welding environment**
- Radio Frequency Interference (RFI)—in the same way that inductive proximity sensors are affected, **RFI interferes with capacitive sensor circuitry**
- Showering arc (EFT)—**induced electrical noise affects these sensors** in the same way it does for an inductive sensor

In the Workplace

On the fill line at Bud Springs Natural Water, two liter plastic bottles pass along beneath a fill nozzle.



A Capacitive Proximity Sensor “Sees Through” a Wall to Find the Target

As water fills each bottle, a capacitive proximity sensor detects when the water reaches the specified level. As the sensor is more sensitive to water than it is to plastic, the sensor can “see through” the bottle wall.

Review 5

Answer the following questions without referring to the material just presented. Begin the next section when you are confident that you understand what you’ve already read.

1. The operation of a capacitive proximity sensor is based on dielectric capacitance. TRUE FALSE
2. The four main parts of a capacitive proximity sensor are:

3. By measuring the change in capacitance as an object enters the field generated by the oscillator, it can be used for an on/off switching function. TRUE FALSE
4. When feedback capacitance is detected, the oscillation ends. TRUE FALSE
5. When sensing metal targets, a derating factor must be applied. TRUE FALSE
6. The transparency of the container has no effect on the sensing. TRUE FALSE

Answers to Review 5 are on **Page V8-T12-41**.

Photoelectric Sensors

The photoelectric sensor is a device with tremendous versatility and relatively low cost. Photoelectric sensors can detect objects more quickly and at further distances than many competitive technologies. For these reasons, photoelectric sensors are quickly becoming one of the most popular forms of automatic sensing used in manufacturing.

Photoelectric Sensors



Applications

Photoelectric sensors can provide solutions to a number of sensing situations. Some of the common uses for photoelectric sensors include:

Material Handling. A sensor can ensure that products move along a conveyor line in an orderly manner. The sensor will stop the operation if a jam occurs. And items can be counted as they move down the line.

Packaging. Sensors can verify that containers are filled properly, labeled properly and have tamper-proof seals in place.

Machine Operation. Sensors can watch to verify that a machine is operating properly, materials are present and tooling is not broken.

Paper Industry. Sensors can detect web flaws, web splice, clear web and paper presence, while maintaining high web speeds.

Design Flexibility

Photoelectric sensors offer design flexibility to handle many types of situations. There are a variety of ways the transmitter and receiver can be arranged to meet the needs of the application.

Modes of Operation

We will briefly introduce you to these modes, and fully explain them later.

Photoelectric Sensor Operation Modes

Mode	Description
<p>Thru-Beam</p>	<p>Thru-beam</p> <p>A source unit in one location sends a light beam to a detector unit in another location. An object is detected when it passes between the source unit and the detector unit, interrupting the light beam.</p>
<p>Reflex</p>	<p>Reflex (retro-reflective)</p> <p>The source and detector are housed in one package and placed on the same side of the target object's path. When the object passes by, the source signal is reflected back to the detector by a retroreflector.</p>
<p>Diffuse Reflective</p>	<p>Diffuse reflective</p> <p>The source and detector are housed in one package and placed on the same side of the target object's path. When the object passes by, the source signal is reflected back to the detector off the target object itself.</p>
<p>Background Rejection</p>	<p>Background rejection (Perfect Prox[®])</p> <p>This is a special type of diffuse reflective sensor that includes two detectors. This arrangement allows the sensor to detect targets reliably within a defined range, and to ignore objects just outside of this range. Unlike a standard diffuse reflective sensor, color or reflectivity has minimal effect on the sensing range of a Perfect Prox sensor.</p>

In the Workplace

At the tollbooth, the gate raises only when you have tossed in your coins. But how does the gate know when to drop back into place?



A Photoelectric Sensor Prevents Commuters from Following You Through the Toll Booth for Free

The gate is controlled by a photoelectric sensor that detects your car as it passes through the beam.

Basic Operation of Photoelectric Sensors

The operation of the photoelectric sensor is quite simple. **A source LED sends a beam of light, which is picked up by a photodetector.**

When an object moves into the path of the light beam, the object is detected.

Let's look at how a photoelectric sensor works.

Photoelectric Sensor Operation

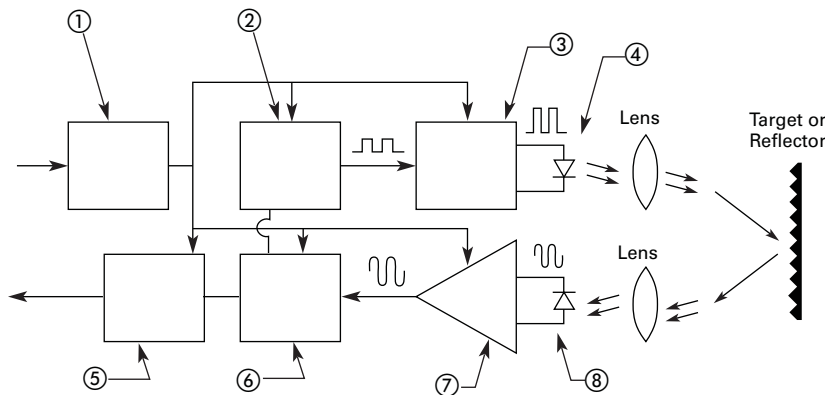

Notes

- ① **Power Supply:** Provides regulated DC voltage and current to the sensor circuitry.
- ② **Modulator:** Generates pulses to cycle amplifier and LED at desired frequency.
- ③ **Source Current Amplifier**
- ④ **Source LED**
- ⑤ **Output:** Performs switching routine when directed to do so by the demodulator.
- ⑥ **Demodulator:** Sorts out the light thrown out by the sensor from all other light in the area. If the demodulator decides the signals it receives are okay, it signals the output.
- ⑦ **Detector Amplifier:** Blocks current generated by the background light. It also provides amplification of the detected signal to a usable level, and sends it through to the demodulator.
- ⑧ **Photodetector:** Either a photodiode or a phototransistor device, selected for a maximum sensitivity at the source LEDs emitted light wave-length. Both the source LED and the detector have protective lenses. When the detector picks up the light, it sends a small amount of current to the detector amplifier.

The Light Source







The light generated today by a photoelectric sensor comes from light emitting diodes, called LED. Using LEDs offers many significant advantages:

- Can be rapidly switched and instantly turned ON and OFF
- Extremely small
- Consume very little power
- Generate a negligible amount of heat
- Life exceeds 100,000 hours (11 years) continuous use
- Easily modulated to block false sensor triggering from ambient light

Photoelectric Sensor Styles and Uses

General Purpose

General Purpose Photoelectric Sensors

	Style	Application
Limit Switch Type 	Limit switch type	A modular head, sensor body and receptacle enable use in a variety of situations. Wide detection range. Popular replacement for standard limit switch applications.
Tubular 	Tubular	Small, easy to mount body enables mounting within machinery and other tight places. This sensor comes end sensing and right angle view packages, depending upon the type of mounting required.
Harsh Duty 	Harsh duty	Heavy-duty construction makes this sensor ideal for rugged environments.
Compact 	Compact	A family of high performance AC/DC and DC photoelectric sensors in a familiar package.
Fiber Optics 	Fiber optics	Made for fast response and for sensing in very tight areas. The cables are made of individual glass or plastic fibers and contain no electronics.
Terminal Base 	Terminal base	Self-contained in an impact-resistant, resin-molded case, these devices have pre-wired cables or terminal connections.
Miniature 	Miniature	A complete line of miniature photoelectric sensors for optimum placement and protection with no compromise in performance.

Fiber Optics

Applying **fiber optic** technology to photoelectric sensors means applications with space restrictions are not a problem. A fiber optic cable can detect objects in locations too jammed for a standard sensor. **Fiber optic cable is available in sizes as small as 0.002 inches in diameter.**

Glass Fiber Optic Cable

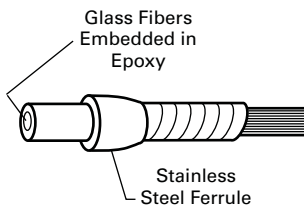

A glass fiber optic cable is made up of a large number of individual glass fibers, sheathed for protection against damage and excess flexing. Plastic fiber optic cables include a single plastic fiber in a protective coating. Neither type of cable contains electronics.

Because light—rather than

current—travels down these cables, **the signal is unaffected by electromagnetic interference (EMI) and vibration.** The design also has built-in immunity to electrical noise and the inaccurate readings regular sensors can get.

Fiber optics can withstand high temperatures; plastic up to 158°F (70°C), standard glass up to 480°F (249°C), and specialized high temperature versions up to 900°F (482°C). Glass fibers can stand up to the harsh wash-down chemicals used in many food, beverage and pharmaceutical applications.

However, fiber optics have their disadvantages. They have a limited sensing distance, so they can be used only in tight areas. The maximum distance for the thru-beam design is just 15 inches. Also, these sensors have a small sensing area. A small drop of water or piece of dirt can easily fool fiber optics.

In the Workplace

In this cookie kitchen, fiber optic photoelectric sensors are placed in a hot oven. As long as the sensors detect motion as the trays of cookies move by, the oven stays on.



A Photoelectric Sensor Prevents Cookies from Being Burned

If the conveyor stops, the sensors will detect light or dark for too long, and the output device will shut the oven down.

Modes of Detection

In most applications, photoelectric sensors **generate an output** any time an object is detected.

Light Operate vs. Dark Operate

If this occurs **when the photodetector sees light**, the sensor is said to be working in the **light operate** mode.

Light Operate and Dark Operate—Reflex Mode Example

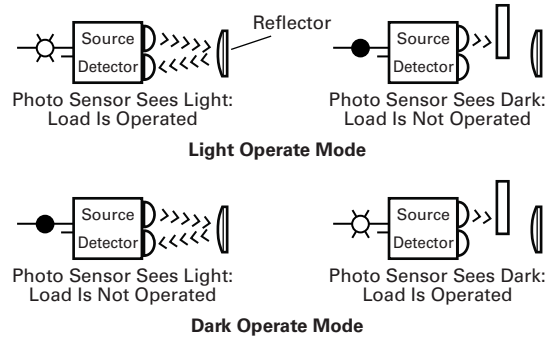

If the control **generates an output when the photodetector does not see light**, the control is said to be working in the **dark operate** mode.

Earlier, we briefly described the four basic operating modes that photoelectric sensors offer. These are:

- Thru-beam
- Reflex (retro-reflective)
- Diffuse reflective
- Background rejection (Perfect Prox)

Let's now take some time to understand how each method works.

Thru-Beam

Separate light source and detector units face one another across an area. The column of light traveling in a straight line between the two lenses is the effective sensing beam. An object crossing the path has to completely block the beam to be detected.

Thru-Beam Attributes

Attributes
Strengths
Long sensing distance (up to 800 ft)
Highly reliable
Can see through opaque objects
Weaknesses
Two components to mount and wire
Alignment could be difficult with a longer distance detection zone

Thru-Beam Operation

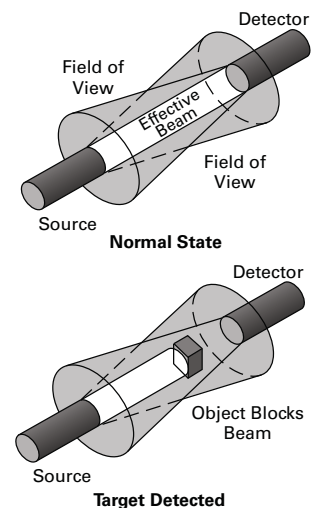

Reflex or Retro-Reflective

The source and detector are positioned parallel to each other on the same side of the object to be detected. Another element, called a retroreflector, is placed across from the source and detector. The retroreflector is similar to a reflector on the back of a bicycle. The retroreflector bounces the light from the source back to the detector.

When a target object passes between the source/detector unit and the retroreflector, the beam is no longer reflected, and the target is sensed. The target has to block the entire beam.

In some cases, a reflex sensor can be falsely triggered by reflections from a shiny target's surface. To avoid this, a **polarized reflex sensor** can be used. The polarizing filter on the sensor ensures that only the light reflected by a retroreflector is recognized by the sensor.

Reflex Attributes

Attributes
Strengths
Medium range sensing distance
Low cost
Ease of installation
Alignment does not need to be exact
Polarizing filter allows detecting shiny surfaced objects without false tripping
Weaknesses
Reflector must be mounted
Problems detecting clear objects
Dirt on retroreflector can hamper operation
Not suitable for detecting small objects

Reflex Operation

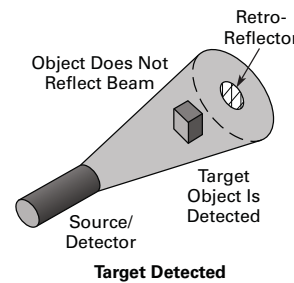
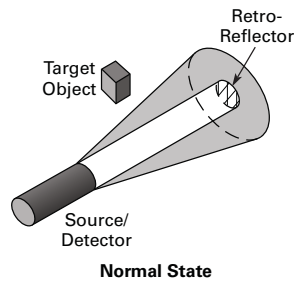

Diffuse Reflection

The source and detector are positioned on the same side of the target. The two components are aligned so that their fields of view cross.

When the target moves into the area, light from the source is reflected off the target surface back to the detector.

Diffuse Reflection Operation

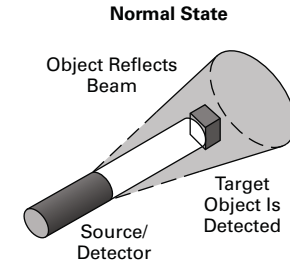
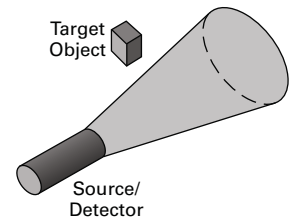

Diffuse Reflective Attributes

Attributes
Strengths
Application flexibility
Low cost
Easy installation
Easy alignment
Many varieties available for many application types
Weaknesses
Short sensing distance (under 10 ft)
Sensing distance depends on target size, surface and shape

Background Rejection (Perfect Prox)

This detection scheme is really a **special type of diffuse reflective sensor**. It combines **extremely high sensing power with a sharp optical cut-off**. This allows the sensor to reliably detect targets regardless of color, reflectance, contrast or surface shape, while ignoring objects just outside of the target range.

This method **uses two different photo-detectors**. For the Perfect Prox unit with a six-inch range, the near detector has a range of 0 to

24 inches. Its far detector has a range of 6 to 24 inches.

Objects closer than six inches are detected only by the near detector. Objects between 6 and 24 inches are detected by both detectors.

If the near signal is stronger than the far signal, the sensor output is ON. If the far signal is stronger or equal to the near signal, the output is OFF. The result is a sensor with high **excess gain** for six inches, followed by a sharp cut-off.

Perfect Prox Sensor

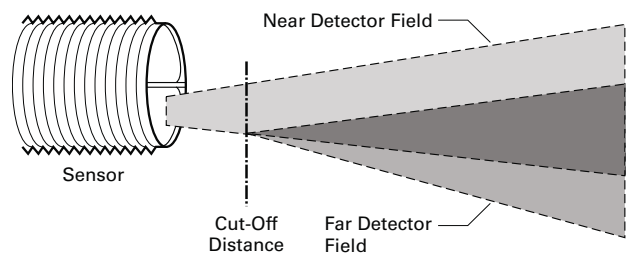

In the Workplace

Hobbes Gear wanted to reduce the number of gears rejected on their line. One critical process is the automatic drilling of the gear's mounting hole. To increase the reliability of the inspection process, Hobbes installed a Perfect Prox sensor.

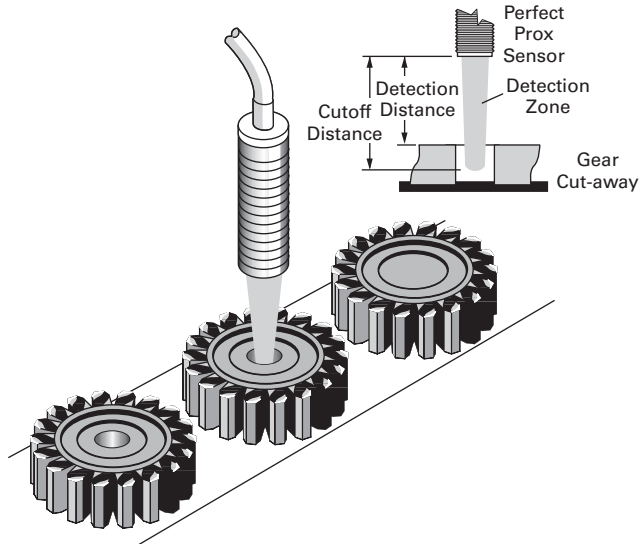

A Perfect Prox is "Inspector #12"

The sensor is set to check for the presence of the machined hole in the gear. If the hole is present, the sensor's light shines through it, to the conveyor belt. The belt is just beyond the sensor's sensing distance. If a missing hole is detected, the sensor signals an air-operated cylinder plunger to reject the gear.

Review 6

Answer the following questions without referring to the material just presented. Begin the next section when you are confident that you understand what you've already read.

1. The four modes of detection are:

2. If the photoelectric sensor control generates an output when the photodetector does not see light, the control is working in the dark operate mode. TRUE FALSE

Match the mode of detection with its definition.

3. Mode of detection that senses by reflecting light off the objects _____ A. Reflex
4. Sensing mode that has the longest range _____ B. Perfect Prox
5. Sensing mode that combines extremely high sensing power with a sharp optical cut-off _____ C. Thru-beam
6. A polarizing filter used with this sensing mode ensures that only the light reflected by a retro-reflector is recognized by the sensor _____ D. Diffuse reflective

Answers to Review 6 are on **Page V8-T12-41**.

Excess Gain

Definition

Excess gain is a measurement of how much sensing power a photoelectric sensor has available beyond the power required to detect an object.

An excess gain of 1.00 at a given range means there is exactly enough power to detect an object **under perfect conditions at that range**. In other words, **the range at which the excess gain equals 1.00 is the maximum range of the sensor**.

Every model of sensor comes with an excess gain chart to help you determine the excess gain for an application's sensing distance.

However, we have to take into consideration the following real-world variables:

- Target size
- Target color
- Target surface texture
- Ability to block the beam
- Background
- Application environment

In the real world, there is contamination—dust, humidity and debris—that can settle on the lenses and reduce light transmission. Furthermore, each individual target may vary slightly from the next in color, reflectivity or distance from the sensor.

If you use a sensor with an excess gain of exactly 1.00, you stand an excellent chance of not sensing the target reliably. To cover yourself, **you need a sensor with the highest excess gain possible at the intended range**. This ensures the sensor will continue to operate reliably when you need it. As the level of contamination gets worse, more excess gain will be needed to get past the poor visibility.

Thru-Beam

This type of sensor's excess gain is the simplest to measure. **Excess gain is almost exclusively a function of the separation between the source unit and the detector unit.**

When implementing the excess gain for an application, start with the excess gain chart for the thru-beam sensor. Then consider:

- Misalignment of the two units
- Dirt in the environment reduces gain

Typical Gain Curve for a Thru-Beam

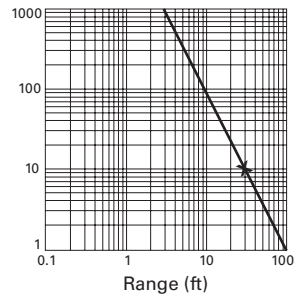

How to read the gain graph. If these sensors are spaced 30 ft apart, the excess gain at that distance would be an excess gain of "10".

Diffuse Reflection

Nearly every diffuse reflective sensor has a unique combination of lenses and beam angles.

As a result, nearly every sensor has a unique excess gain curve.

Diffuse Reflection Ranges

Long Range Perfect Prox Example

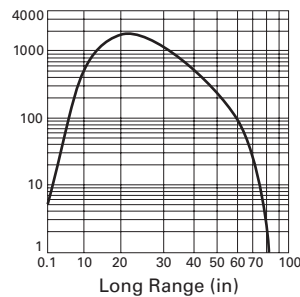

Short Range

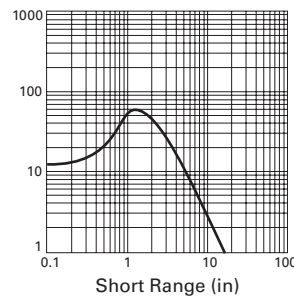

Focused Diffused Reflective

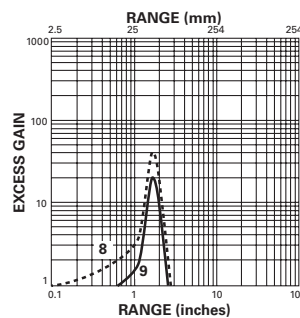

8. 13102A Typical
9. 13102A Minimum

Sensing range of diffuse mode sensors referenced to 90% reflective white target.

A short-range sensor delivers high excess gain over a short sensing distance and drops off quickly. The source's beam and the detector's field of view converge a short distance from the lenses. The energy present in that area is very high, allowing the detection of small targets. The sensor also ignores objects in the near background.

Short-Range and Long-Range

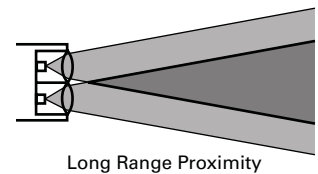
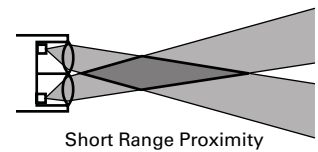

A long-range sensor's source beam and detector's field of view are positioned close together on the same axis. The ability to sense extends quite a distance. **Excess gain peaks out several inches from the sensor, then drops off slowly over distance.**

To sense into holes or cavities, or to pick up very small objects, use a focused diffuse reflective sensor. Or, a sensor with a very small light spot size. The source and detector are positioned behind the lens in order to focus the energy to a point. The excess gain is extremely high at this point and then drops off on either side of the sensing zone.

Reflex

Calculating the excess gain for a reflex (retro-reflective) sensor is similar to the method used for diffuse reflective sensors.

With this type of sensor, **excess gain and range are related to the light bouncing back from the reflector.** Maximum

operating range also depends upon lens geometry and detector amplifier gain.

The effective beam is defined as the actual size of the reflector surface. The target must be larger than the reflector before the sensor will recognize the target and switch its output.

Effective Reflex Sensor Beam

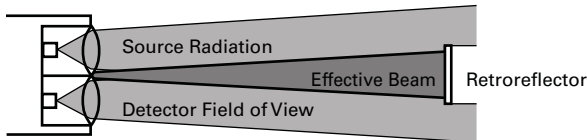

Light Curtain

A light curtain is a specialized reflex sensor head. It has four transmitters and four detectors side by side behind a cylindrical lens. The light curtain emits a fan-shaped beam, which provides a wide viewing area.

The distance from the lens to the reflector strip, together with the length of the reflector, serve to define the effective detection area.

Effective Light Curtain Sensor Beam

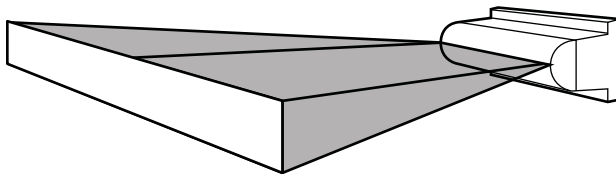

Effective Detection Area Graph

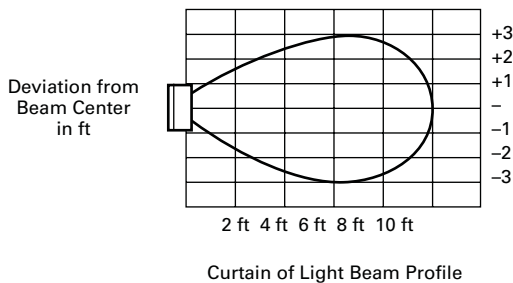

Corner Cube Retroreflector and Reflex

In the case of the corner cube reflector, range and excess gain depend upon on reflector quality.

Corner cube reflectors provide the highest signal return to the sensor. Cube style reflectors have 2000-3000 times the reflectivity of white paper.

Corner cube reflectors consist of three adjoining sides arranged at right angles to one another.

Corner Cube Reflector

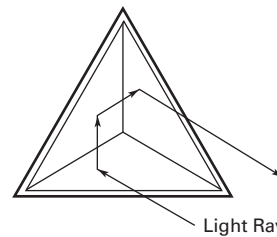

When a ray of light strikes one of the three adjoining sides, the ray is reflected to the second side, then to the third, and then back to its source in a direction parallel to its original course. Thousands of these cube shapes are molded into a rugged plastic reflector or vinyl material.

Glass Bead

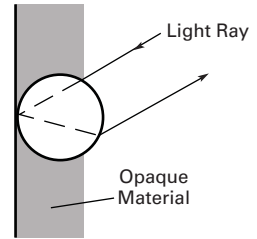

Glass bead retroreflectors are available in tape form for use in dispensers for package coding on conveyors. They are also available in sheet form that can be cut to size. The bead surface is typically rated at 200 to 900 times the reflectivity of white paper.

Only corner cube reflectors can be used with polarized reflex sensors. The light returned from the cube's surface is depolarized with respect to the light it received. Glass bead reflectors cannot be used with polarized retro-reflective sensors.

Contrast

Contrast measures the ability of a photoelectric sensor to detect an object.

The contrast of a sensor is a ratio of the excess gain under light conditions to the excess gain under dark conditions. A ratio of 10:1 is desired.

Contrast is important when a sensor has to detect semi-transparent objects or extremely small objects.

Each mode handles contrast differently.

Thru-Beam and Reflex

These modes are affected by:

- Light transmissivity of an object or surface
- Size of an object in relation to the beam size

Diffuse

This mode is affected by:

- Distance of the object or surface from the sensor
- Color or material of the object or surface
- Size of the object or surface

The ideal application provides infinite contrast ratio of the detection event. This is the case when 100% of the beam is blocked in reflex or thru-beam modes. For diffuse sensing, this occurs when nothing is present. Understanding the contrast ratio is critical when this situation does not exist, such as when detecting semitransparent objects. In some cases, it might be necessary to use a special low-contrast sensor designed for these applications, like a clear object detector version.

Environment

The list below ranks the level of contamination in a range of typical application environments.

As you work your way down the list, the excess gain needed to overcome what's hanging in the air gets higher.

To further complicate matters, with the reflex and thru-beam modes, the source and reflector can be in different locations with different levels of contamination.

For outdoor use, the environment can range from lightly dirty to extremely dirty.

Level of Contamination Ranking

Ranking	Description	Minimum Excess Gain Required
Relatively clean	No dirt buildup on lenses or reflectors	1.5 X
Slightly dirty	Slight buildup of dust, dirt, oil, moisture, and so on, on lenses or reflectors. Lenses should be cleaned on a regular schedule.	5 X
Moderately dirty	Obvious contamination of lenses or reflectors. Lenses are cleared occasionally or when necessary.	10 X
Very dirty	Heavy contamination of lenses. Heavy fog, mist, dust, smoke or oil film. Minimal cleaning of lenses takes place.	50 X

In the Workplace

A thru-beam pair is positioned ten inches apart to detect a semi-transparent plastic bottle moving through the sensing zone. But the sensor is not picking up the bottle.

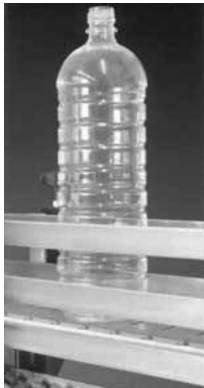

The Right Sensor Type Makes the Difference Between Reliable Sensing and No Sensing at All

Given that the excess gain at that range is 100, and the bottle blocks only 5% of the light energy, the contrast ratio is close to 1 (100/95). This does not meet the advised 10:1 ratio. The thru-beam pair is just too powerful.

Using a focused sensor positioned three to four inches from the bottle changes things. In this detection zone, the excess gain is between 20 and 100. (See Effective Detection Area Graph on **Page V8-T12-31**.)

Review 7

Answer the following questions without referring to the material just presented. Begin the next section when you are confident that you understand what you've already read.

1. Excess gain is a measurement of how much sensing power a photoelectric sensor has available beyond the _____

2. Name the three factors that can affect excess gain.

3. Nearly every diffuse reflective sensor has a unique excess gain curve because nearly every sensor has a unique combination of lenses and beam angles. TRUE FALSE
4. Only corner cube style reflectors should be used with polarized reflex sensors. TRUE FALSE
5. Contrast is not important when sensing semi-transparent targets. TRUE FALSE

Answers to Review 7 are on **Page V8-T12-41**.

Sensor Output Circuits

As we learned earlier, sensors interface to other control circuits through the output circuit. The control voltage type is a determining factor when considering output type. Control voltage types, whether AC, DC or AC/DC, can be categorized as either **load-powered sensor** or **line-powered sensor**.

Load-Powered—Two-Wire Sensors

Load-powered devices are similar to limit switches. They are connected in series with the controlled load. **These devices have two connection points to the circuit and are often referred to as two-wire switches.** The operating current is drawn through the load.

Load Powered/Two-Wire Circuit

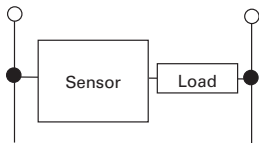

When the switch is not operated, it must draw a minimum operating current referred to as off-state leakage current. Off-state leakage current is also sometimes referred to as residual current. This current is used to keep the sensor electronics active while it “looks” for a target. Residual current is not a problem for loads such as relays, motor starters, and so on (with low impedance). However, loads such as programmable logic controllers (with high impedance) require a leakage current of lower than 2 mA.

Otherwise, an input like a PLC (Programmable Logic Controller) might see the voltage as being an ON signal. Most sensors are 1.7 mA. If a particular PLC requires less than 1.7 mA, a loading resistor is added in parallel to the input to the PLC load. The resistor lowers the current seen by the PLC so it doesn't false trigger.

The current required to **maintain the sensor when the target is present, is called the minimum load or holding current.** This current is about 5 mA depending on the sensor specification. If the current drawn by the load is not high enough, then the sensor cannot operate. Sensors with a 5 mA or less minimum holding current can be used with PLCs without concern.

Line-Powered—Three-Wire Sensors

Line-powered switches derive their power from the line and not through the load. **They have three connection points to the circuit, and are often referred to as three-wire switches.**

Load Powered/Three-Wire Circuit

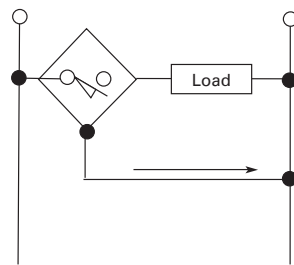

The operating current the switch pulls from the line, is called the burden current. This is typically 20 mA. Because the operating current doesn't pass through the load, it is not a major concern for circuit design.

Two-Wire Sensors

Most sensors are three-wire devices, but some manufacturers offer two-wire devices. They are designed to be easy replacements for limit switches without the need to change wiring and logic.

Because **two-wire switches “steal” their operating power from the load circuit,** there is a voltage drop across the switch when it is on (about 7–9 volts in AC powered devices).

Output Types

There are three output types available—Relay, Triac and Transistor.

A relay is a mechanical device that can handle load currents at higher voltages. This allows the sensor to directly interface with motors, solenoids and other inductive loads. **They can switch either AC or DC loads.**

Relays are subject to contact wear and resistance build up, but contact life depends on the load current and the frequency of operations. Due to contact bounce, they can produce erratic results with counters, programmable logic controllers and other such devices, unless the input to those devices are filtered. Because relays are mechanical, they can add 10 to 25 milliseconds to a sensor's **response time.**

Triac Output Circuit

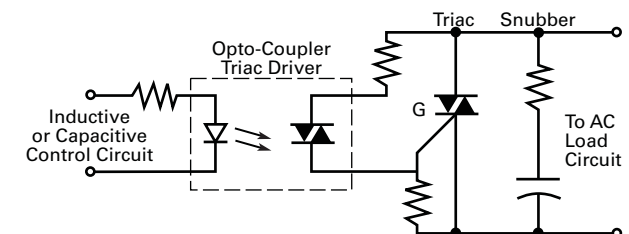

If more than one two-wire switch is wired in series with the load, there is a cumulative voltage drop across the switch. When more than one two-wire switch is connected in parallel with a load, there is a cumulative effect on the leakage current. This increased off-state leakage current could cause a PLC to receive a false ON signal.

For the majority of applications, these limitations cause no problems, or can easily be minimized. **Relay outputs are very commonly used in sensors.**

A triac is a solid-state device designed to control AC current. A triac switch turns on in less than a microsecond when its gate (control leg) is energized, and shuts off at the **zero crossing** of the AC power cycle.

Because a triac is a solid-state device, it is not subject to the mechanical limitations of a relay. Switching response time is limited only to the time it takes the 60 Hz AC power to go through one-half cycle.

AC Power Cycle

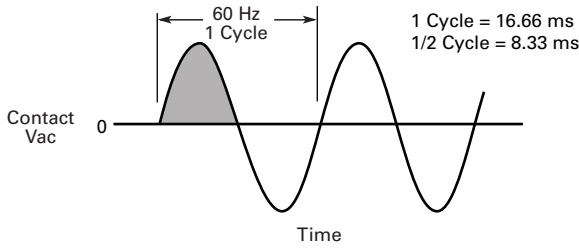

As long as a triac is used within its rated maximum current and voltage specification, life expectancy is virtually infinite. Triac devices used with sensors are generally rated at 2A loads or less, and can be directly interfaced with PLCs and other electronic devices. Triacs do have some limitations in that an inductive load directly connected can false trigger it. A **snubber circuit** can be used to minimize the problem. Shorting the load will destroy a triac, so the device should be short circuit protected to avoid this.

A transistor is a solid-state device designed to control DC current. They are most commonly used in low voltage DC powered sensors

Transistor Output Circuit (Sinking)

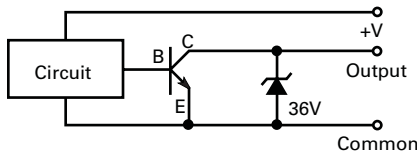

Transistor Output Circuit (Sourcing)

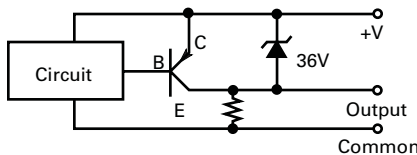

as the output switch. There are two types used, depending on the switching function. One is called **NPN (current sink) open collector**. The output transistor is connected to the negative DC. Current flows from the positive terminal through the load, to the sensor, to the negative terminal. **The sensor "sinks" the current from the load.**

The second type used is called **PNP (Current Source)**. The sensor is connected to the positive DC. Current flows from the positive terminal through the sensor, to the load, to the negative terminal. **The sensor "sources" the current to the load.**

Bilateral FET Device

Photosensors have another output type called a bilateral FET output. This output has many advantages over the other types of outputs:

- Switching of either AC or DC voltages
- Low "OFF-state" leakage
- Extremely fast response time
- Interface direct to TTL and CMOS circuits (for PLCs and industrial computers)
- Does not self-generate line noise

FET is for Field Effect Transistor, and may become the most popular output in the future because of its near ideal operating characteristics.

The voltage applied to the gate (G) controls the conduction resistance between the source (S) and drain (D). Because an FET is a resistive device, it doesn't

develop the fixed voltage drop across its terminals like other solid-state switches. It also does not require any residual or leakage current to keep the electronics powered in the OFF-state.

FET switches are independent of voltage or current phase and can be configured in circuits that will control either AC or DC voltages. For circuits using PLCs, computers or other sensitive devices, FETs are good because they do not generate any switch induced line noise like relay and triac switches.

Like the other solid-state outputs, they cannot tolerate line spikes or large inrush currents. In the illustration above, a transistor is used to protect the FET from voltage spikes and dissipate the energy as heat.

Bilateral FET Device (AC/DC Switch)

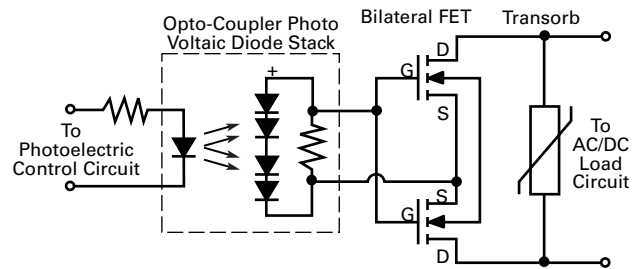

Output Configurations

Single Output

As in other control devices, several output configurations are available for sensors. Fixed single outputs, either 1NO or 1NC, are very

common and NO is the most common. Fixed single output sensors cannot change configuration to the other circuit.

Single Output

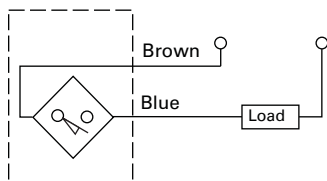

Programmable Output

A **programmable output** sensor has one output, NO or NC, depending on how the output is wired when it's installed. Sometimes the output configuration is

selected using a switch. On photoelectric sensors this is called a light/dark switch. This allows you to program the sensors output normally open (NO) or normally closed (NC).

Programmable Output

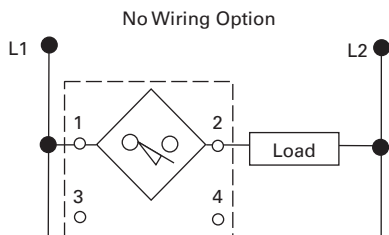

Complementary Output

A **complementary output** sensor has two outputs, 1NO and 1NC. Both outputs change state simultaneously when the target enters or leaves the sensing field.

The output logic for the normally open and normally closed contact configurations for an inductive proximity sensor is shown in the table below.

Complementary Output

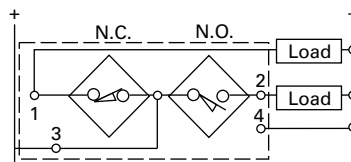

Output Logic

Output Configuration	Target	Output State
NO	Absent	Non-conducting (OFF)
	Present	Conducting (ON)
NC	Absent	Conducting (ON)
	Present	Non-conducting (OFF)

Accessory Considerations

The choice of control circuit, of using single, programmable or complementary outputs are dependent upon:

- Voltage available—Does the control circuit have provisions for supplying DC? Some control circuits have interfacing circuitry for DC sensors even if the main control voltage source is AC
- Control circuit current requirements—If the circuit requires a current greater than the rating on the sensor, an interposing relay can be used
- Application output requirements—While NO is the most commonly used, certain applications may require the circuit logic provided by NC, or even the complementary configured sensors
- Switching speed requirements—For applications requiring high speed, such as counting, DC sensors may be required. AC circuits are limited by operations per second (because of the AC sine wave), and are typically slower than DC
- Connected logic device—Probably the most important factor for sensor circuit and output configuration is the device to which the sensor is to be connected. What type of input the PLC, counter, relay, and so on, can accept is the determining factor for which sensor output is chosen

Other considerations are whether the sensor will need LED indication of its status and whether there is short circuit protection, reverse polarity protection or wire termination needed

Switching Logic

Output Logic Functions

The outputs of two or more sensors can be wired together in series (and) and parallel (or) to perform logic functions. Factors that need to be taken into consideration, however, are excessive leakage current or voltage drop and inductive feedback with line powered

sensors. For these reasons, series and parallel connections for logic functions is not commonly done. It is usually easier to connect direct to a PLC's inputs and perform the logic functions through the PLC program.

Output Response Time and Speed of Operation

Photoelectric, inductive and capacitive sensors can operate considerably faster than a limit switch, making them better choices for high-speed operations such as counting or sorting. The time it takes to respond, its speed of operation, is based on several factors. Let's take a moment to consider them.

When a system is first powered up, the sensor cannot operate until the electronics are "powered up." This is referred to as **time before availability**.

For AC sensors, this delay is typically from 35 milliseconds up to as high as 100 milliseconds. For a DC sensor, the delay is typically 10 milliseconds.

Response Time and Release Time for an Inductive Proximity Sensor

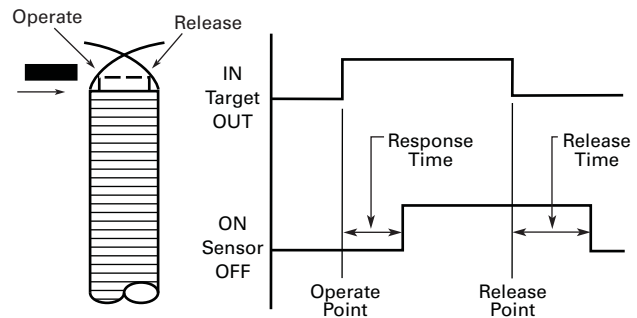

Time Delay Before Availability

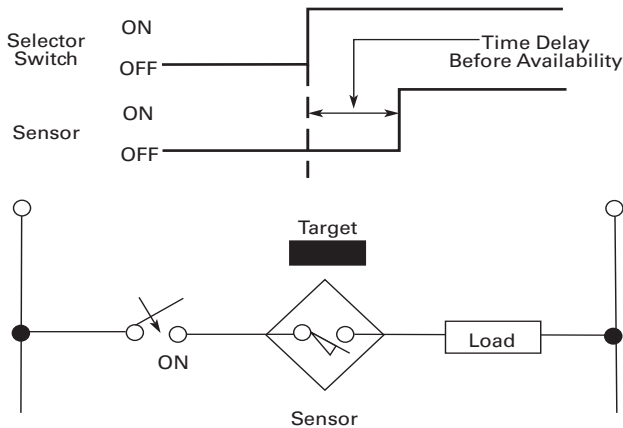

Once the target enters the sensing range and the detector causes the output to change state, a certain amount of time elapses. This

is called **response time**. For an AC sensor this is usually less than 10 milliseconds. DC devices respond in 1 millisecond or less.

Similarly, when the target leaves the sensing field there is a slight delay before the switch is restored to the OFF state. This is referred to as the **release time**. An AC sensor typically releases in one cycle (16.66 milliseconds) and DC devices usually in 1 millisecond, or less.

In order to properly achieve high-speed operations, there are some basic principles that need to be applied. In addition to the sensor's response and release times,

there is a similar delay for the load to operate. This is called the **load response time**. The total times combined are referred to as **system response time**. Similarly, there are **load release time** and **system release time** for when the target exits the sensing field. In order to ensure reliability and repeatability, the target must stay in the sensing field long enough to allow the load to respond. This is referred to as **dwelt time**.

Output Timing Modes

When a sensor is operated without a logic module, the output is generated for the length of time the object is detected.

Some sensors are available with a logic module to allow setting timing functions.

Let's look at each logic function, as shown in the following illustrations.

Logic Functions

ON Delay Logic

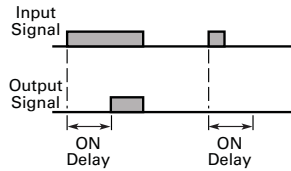

This allows the output signal to turn on only after the target has been detected for a predetermined period of time. The output turns off as soon as the target passes out of range.

ON delay is useful in bin fill or jam detection because the sensor will not false trigger on the normal flow of objects going past.

ON/OFF Delay Logic

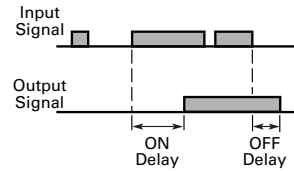

This logic function combines the ON delay logic and OFF delay logic—the output is only generated after the target has been detected for a set period of time, and will remain on after the target is no longer detected for a set period of time.

The mode smooths the output of the sensor for applications such as jam detection, fill level detection and edge guide.

Retriggerable One-Shot Logic

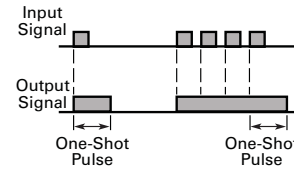

This mode generates an output of predetermined length whenever an object is detected. The sequence restarts each time an object is detected, and will remain triggered as long as a stream of objects are detected before the one-shot times out. A retriggerable one-shot is useful in detecting underspeed conditions on conveyor lines.

Underspeed Detection Logic

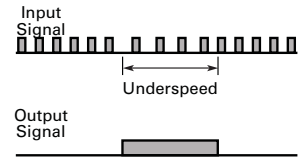

Operates identically to a retriggerable one-shot. It detects speeds that fall below a certain predetermined level.

In addition, the underspeed detector has a built-in latch feature that shuts the system down completely when the speed slows to a preset level. This prevents the one-shot from retriggering once it times out, eliminating erratic switching while the motor is winding down.

OFF Delay Logic

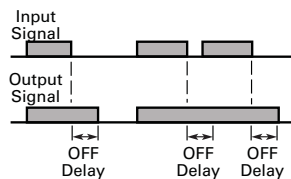

For applications where there is a problem with signal loss in the system, this function turns the output on when the object is detected, and then holds the ON signal for a set period of time after the object is no longer detected.

One-Shot Logic

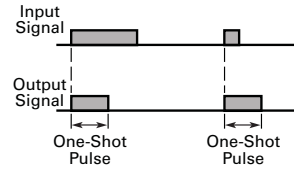

This type of logic generates an output of a set length no matter how long an object is detected. A one-shot can be programmed to trigger on the leading or trailing edge of a target. A one-shot ON signal must time out before it can detect another input.

This logic is useful in applications that require an output of specified length.

Delayed One-Shot Logic

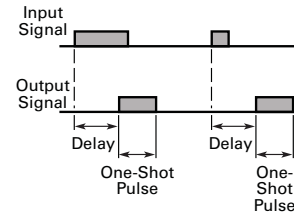

Combines on delay and one-shot logic. The one-shot feature is delayed for a predetermined period of time after an object is detected. A delayed one-shot is useful where the photoelectric control cannot be mounted exactly where the action is taking place. This includes applications like paint booths, high temperature ovens or drying bins.

Underspeed/Overspeed Detection Logic

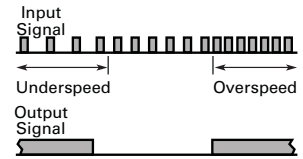

Detects both overspeed and underspeed conditions. The detector is set to count a certain number of objects in a specified amount of time. If the system operates either at a higher or lower rate, an output is generated.

In the Workplace

Paper breaks in a web printing press can result in time-consuming manual re-threading of the paper if the break is not immediately detected. A photoelectric sensor can detect this condition instantly, and do it in this tight space

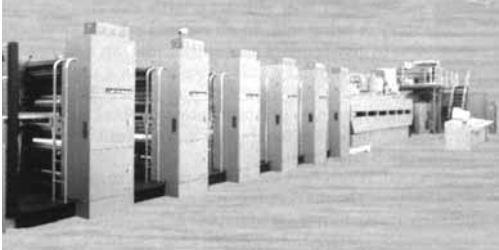

A Photoelectric Sensor Minimizes Downtime for this Printing Press

High excess gain and sharp optical cut-off of a diffuse mode Perfect Prox ensure that background machinery is ignored. Meanwhile, paper is detected, regardless of texture, color or printing on it.

Review 8

Answer the following questions without referring to the material just presented.

Match the output circuit reference to its definition.

- | | |
|--|-------------------------------|
| 1. The current required to maintain the sensor when a target is present _____ | A. Residual current (leakage) |
| 2. Having three connections (three-wire) to the circuit _____ | B. Burden current |
| 3. The operating current the switch pulls from the line _____ | C. Load-powered |
| 4. Having two connections (two-wire) to the circuit _____ | D. Line-powered |
| 5. The initials designating a transistor output that sinks current from the load are _____ | |
| 6. The initials designating a transistor output that sources current to the load are _____ | |

In questions 7 through 13, match the term used to describe the following:

- | | |
|---|-----------------------------|
| 7. The delay of a sensor when the system is first powered up _____ | A. Release time |
| 8. The period during target sensing and the detector causing output to change to ON state _____ | B. Dwell time |
| 9. The period during target exiting the sensing range and the output changing to OFF state _____ | C. ON delay logic |
| 10. The period during which the target must stay in range to allow the load to respond _____ | D. One-shot logic |
| 11. Logic module that allows output signal only after target detection for a set period of time _____ | E. Time before availability |
| 12. Logic module that allows output signal to be held ON for a set period of time _____ | F. OFF delay logic |
| 13. Logic module that allows output signal to be a specific length regardless of target physical size or detection timing _____ | G. Response time |

Answers to Review 8 are on **Page V8-T12-41**.

Enclosure Ratings

NEMA Non-Hazardous Locations

Type	Description
1	For indoor use, primarily to provide a degree of protection against contact with the enclosed equipment.
3	Intended for outdoor use, primarily for a degree of protection against windblown dust, rain, sleet and external ice formation.
3R	For outdoor use, primarily to provide a degree of protection against falling rain, sleet and external ice formation.
4	For indoor and outdoor use, primarily to provide a degree of protection against wind blown dust and rain, splashing water and hose directed water.
4X	Intended for indoor or outdoor use, primarily to provide a degree of protection against corrosion, windblown dust and rain, splashing water and hose directed water.
6	Intended for indoor or outdoor use, primarily to provide a degree of protection against the entry of water during occasional temporary submersion at a limited depth.
6P	Intended for indoor or outdoor use, primarily to provide a degree of protection against the entry of water during prolonged submersion at a limited depth.
12	Intended for indoor use, primarily to provide a degree of protection against dust, falling dirt and dripping non-corrosive liquids.
13	Intended for indoor use, primarily to provide a degree of protection against dust, spraying of water, oil and non-corrosive coolant.

NEMA Hazardous Locations

Type	Description
Type 7	For indoor use, within conditions of Class I and Groups shown, to withstand and contain an internal explosion of specified gases, or to contain an explosion sufficiently so as not to ignite an explosive gas-air mixture in the surrounding atmosphere.
Class I	
Group A	Acetylene
Group B	Hydrogen, butadiene, ethylene oxide, propylene oxide
Group C	Carbon monoxide, ether, ethylene, hydrogen sulfide, morpholine, cyclopropane
Group D	Gasoline, benzene, butane, propane, alcohol, acetone, ammonia, vinyl chloride
Type 9	For indoor use, within Class II and Groups shown below conditions, to withstand and contain an internal explosion of specified dusts, or to contain an explosion sufficiently so as not to ignite an explosive dust-air mixture in the surrounding atmosphere.
Class II	
Group E	Metal dusts
Group F	Carbon black, coke dust, coal
Group G	Grain dust, flour, starch, sugar, plastics

IEC Ratings

IEC Environmental Enclosure Ratings

Examples of Designations

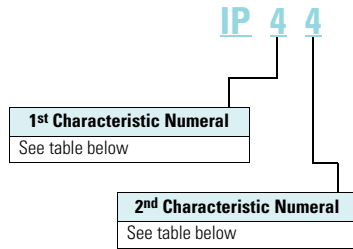

An enclosure with this designation is protected against the penetration of solid objects greater than 1.0 mm and against splashing water.

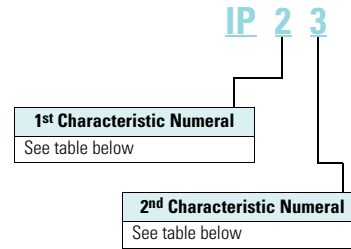

An enclosure with this designation is protected against the penetration of solid objects greater than 1.2 mm and against rain.

Index of Enclosure Ratings—IEC

1st Characteristic Numeral

Numeral	Description
Protection against contact and the penetration of solid bodies	
0	Not protected
1	Protection against solid objects greater than 50 mm.
2	Protection against solid objects greater than 12 mm.
3	Protection against solid objects greater than 2.5 mm.
4	Protection against solid objects greater than 1.0 mm.
5	Dust protected
6	Dust-tight

2nd Characteristic Numeral

Numeral	Description
0	Not protected
1	Protection against dripping water
2	Protection against dripping water when tilted up 15 degrees
3	Protection against rain
4	Protection against splashing water
5	Protection against water jets
6	Protection against heavy seas
7	Protection against the effects of immersion
8	Protection against immersion

Review Answers**Review 1 Answers**

1. Presence, absence
2. Limit Switch, Proximity Sensor, Photoelectric Sensor
3. Electromechanical
4. Inductive proximity
5. Photoelectric

Review 2 Answers

1. Operating Head, Switch Body, Receptacle
2. C
3. F
4. D
5. A
6. E
7. B
8. True

Review 3 Answers

9. a. 2 b. 4 c. 3 d. 1
10. C
11. A
12. D
13. B
14. True

Review 4 Answers

1. Ferrous
2. True
3. False
4. True
5. True
6. False

Review 5 Answers

1. True
2. Sensor (or Dielectric), Oscillator Circuit, Detector Circuit, Output Circuit
3. True
4. False
5. False
6. True

Review 6 Answers

1. Thru-Beam. Reflex (or Retro-Reflective), Diffuse Reflective, Background Rejection (or Perfect Prox)
2. D
3. C
4. B
5. A

Review 7 Answers

1. Power required
2. Target size, color, texture; Contamination (dust, humidity, debris); Application (distance, background, reflectivity)
3. True
4. True
5. False

Review 8 Answers

1. A
2. D
3. B
4. C
5. NPN
6. PNP
7. E
8. G
9. A
10. B
11. C
12. F
13. D

Overview

The sensor applications on the following pages range from basic problems to complex problems that can be solved only with specific sensors from Eaton's electrical sector.

The solution is summarized along with the catalog numbers of suggested models to be used. Note that many sensors are interchangeable; slight differences in the application

may dictate the choice of one sensor over another. When full catalog numbers are listed, that specific model is suggested. Where no suffix is given (for example, **1451E**) or only one family is listed,

the choice of a specific model within the suggested type would be determined by operating voltage, sensing range, choice of cable or connector base, and so on.

Sensor Applications

Broken Tool Detection

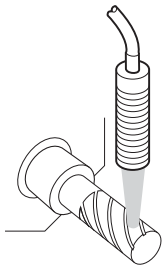

Description	Catalog Number
E58 Perfect Prox [®] sensor	E58-30DP or E58-18DP Sensor

An E58 Harsh Duty Perfect Prox sensor is used to sense for the presence of the bit on a mill. The high sensing power and background rejection of the Perfect Prox allows reliable detection through high levels of cutting fluids, while ignoring objects just beyond the bit. The rugged harsh duty sensor survives constant exposure to lubricants, cutting fluids and flying metal chips.

Broken Bit Detection

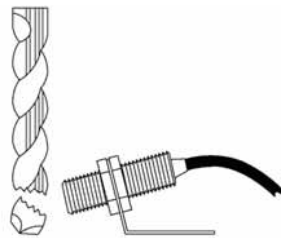

Description	Catalog Number
Tubular inductive proximity sensor	E57 product family or iProx

A tubular E57 proximity sensor is used to detect the presence of a drill bit—should the drill bit be broken the sensor would signal a controller.

Machining Processes

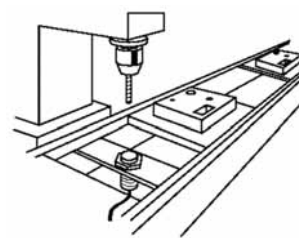

Description	Catalog Number
Tubular inductive proximity sensor	E57 product family or iProx

A ferrous only sensor is used in a process where aluminum is being machined. The ferrous only sensor ignores the aluminum (non-ferrous) chips from the machining process and only detects the ferrous target.

Tool Position

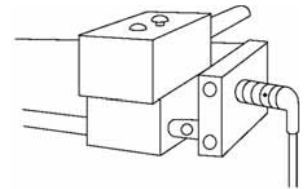

Description	Catalog Number
Tubular inductive proximity sensor	E57 product family or iProx

A tubular E57 proximity sensor is used to detect the position of a tool chuck.

For assistance with these or other applications, call us at 1-800-426-9184.

Bottle Filling Detection

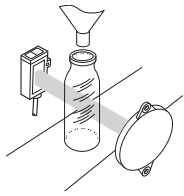

Description	Catalog Number
E65 clear object sensor	E71-CON-XX E71-COP-XX

A clear object sensor is used to sense the presence of bottles at a filling operation. The sensor offers high reliability in sensing clear bottles of different colors and thicknesses.

Jam Detection

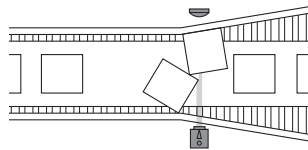

Description	Catalog Number
Enhanced 50 series reflex sensor with timer	1451E-XXXX
3 in dia. retroreflector	6200A-6501

A reflex control with a time delay module set for "delay dark" ignores momentary beam breaks. If the beam is blocked longer than the delay period, the output energizes to sound an alarm or stop the conveyor.

Stack Height Control

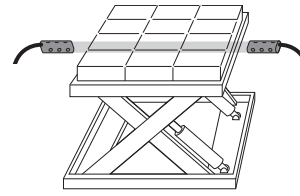

Description	Catalog Number
Comet® series thru-beam source	11100A
Comet series thru-beam detector	12100A

A set of thru-beam sensors determines the height of a scissor lift. For example, when the control is set for "dark-to-light" energize, the lift rises after a layer has been removed and stops when the next layer breaks the beam again.

Box Counting

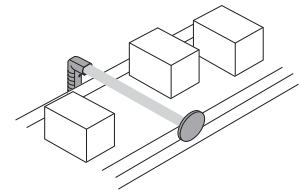

Description	Catalog Number
Prism™ polarized reflex sensor	14151R
3 in dia. retroreflector	6200A-6501

A Prism right-angle reflex sensor detects boxes anywhere on a four foot wide conveyor. Interfacing the control with a programmable controller provides totals at specific time intervals. Polarized reflex optics prevent false triggering on shiny objects, while the high optical power burns through box dust and contamination.

Process Control

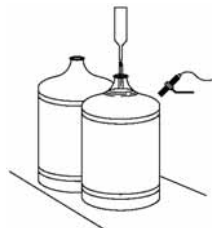

Description	Catalog Number
Tubular capacitive proximity sensor	E53 Product Family

A capacitive proximity sensor used to verify fill level of bottled water on a filling process line.

Conveyor System Control

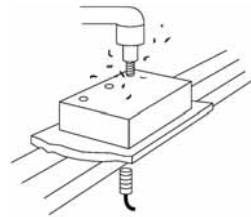

Description	Catalog Number
Tubular inductive proximity sensor	E57 product family or iProx

A tubular inductive proximity sensor is used to detect the presence of metal carriers holding parts to be machined.

Carton Fill-Level Detection

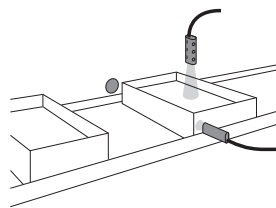

Description	Catalog Number
Comet visible-beam reflex sensor	14102A
Comet 9 in Perfect Prox sensor	13103A
3 in dia. retroreflector	6200A-6501
Adjustable background suppression	E75

Two sensors work together to inspect the fill level in cartons on a conveyor. A reflex sensor senses the position of the carton and energizes the Perfect Prox or background suppression sensor located over the contents. If the Perfect Prox sensor does not "see" the fill level, the carton does not pass inspection.

Cookie Motion Detection

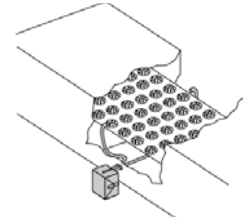

Description	Catalog Number
Fiber optic sensor	1550E-85XX
Fiber optic thru-beam cable (two required)	E51KE823

High temperature environments are accommodated by the use of fiber optics. Here conveyor motion in a 450°F (232°C) cookie oven is detected. If the motion stops, the one-shot logic module detects light or dark for too long, and the output device shuts the oven down.

For assistance with these or other applications, call us at 1-800-426-9184.

Lid Detection

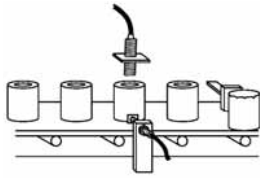

Description	Catalog Number
Tubular inductive proximity sensor	E57 product family or iProx

A pair of tubular proximity sensors used to, a) detect the presence of a can on a conveying line, and b) check for presence of a lid.

Garage Door Control

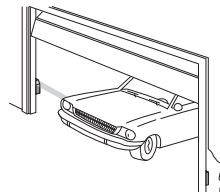

Description	Catalog Number
Enhanced 50 series thru-beam	1150E/SRC 1250E/RCVR

A safe and secure garage is achieved through the use of thru-beam controls interfaced to the door controller. The door shuts automatically after a car leaves, and if the beam is broken while the door is lowering, the motor reverses direction and raises the door again.

Liquid Level Detection

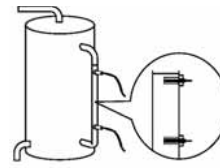

Description	Catalog Number
Tubular capacitive proximity sensor	E53 Product Family

A pair of E53 capacitive proximity sensors are used to sense high and low liquid levels in a tank through a sight glass. This arrangement starts a pump to fill the tank when the lower sensor is energized and shuts the pump off when the top sensor is energized.

Bulk Material Detection

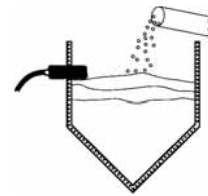

Description	Catalog Number
Tubular capacitive proximity sensor	E53 Product Family

A capacitive proximity is used to control fill level of solids such as plastic pellets in a hopper or bin.

Tollbooth Control



Description	Catalog Number
20 series Thru-beam source	1141D-6501
20 series thru-beam detector	1241D-6501
DPDT relay output device	8526A-6501
E67 long range Perfect Prox	E67-LRDP

Thru-beam source/detector or the long range Perfect Prox diffuse sensor controls are used to time the toll gate. To eliminate toll cheating, the gate lowers the instant the rear of the paid car passes the control. The E67 Long Range Perfect Prox allows you to mount the sensor on one side, instead of both. Plus with Perfect Prox, the E67 will detect cars with different colors and finishes while ignoring all other background objects. The rugged control handles harsh weather, abuse and 24-hour operation.

Cut-Off Saw Control

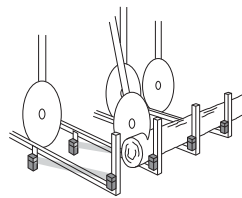

Description	Catalog Number
E51 thru-beam source	E51ELA
E51 thru-beam detector	E51CLC1

Note: All products listed are required for each two-foot increment.

An array of thru-beam controls detect the length of the log in standard two-foot increments. The correct saw is then activated to cut the log at its longest standard length. High optical performance is a must in this dusty and dirty environment.

Web Loop Control

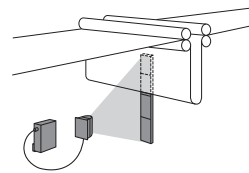

Description	Catalog Number
70 series analog control unit	8172A
70 series reflex curtain-of-light sensor	1471A
Analog isolation module	8272A
Strip retroreflector	6210A

A sensor that generates a "curtain-of-light" detects the length of a loop on a web drive system by measuring the amount of light returned from an array of retro-reflectors. With this information, the analog control unit instructs a motor controller to speed up or slow down the web drive.

Parts Presence

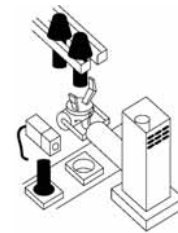

Description	Catalog Number
Limit switch inductive proximity sensor	E51 Product Family
Comet Perfect Prox	1310
iProx™ inductive proximity sensor	E59-M

A limit switch style proximity sensor, a Comet Perfect Prox or the iProx Sensor may be used to detect the presence of a part in a pick-and-place application for inspection. The Comet will detect any target material, color or finish while rejecting the background. The iProx can be programmed to sense a specific metal target while rejecting all other metal.

For assistance with these or other applications, call us at 1-800-426-9184.

Small Parts Detection

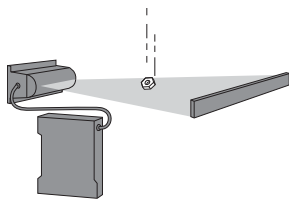

Description	Catalog Number
70 series high power control unit	8171B
Low contrast logic module	8215A
70 series reflex curtain-of-light sensor	1471A
Strip retroreflector	6210A
Triac output relay or other selection	8572A

Small objects moving through a "curtain-of-light" are counted by detecting a change in reflected light. A low contrast logic module inside the control unit responds to slight but abrupt signal variations while ignoring slow changes such as dust build-up.

Parts Detection

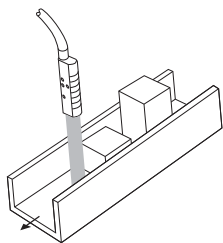

Description	Catalog Number
Comet series 4 in Perfect Prox sensor	13101A

A four inch Perfect Prox sensor detects parts of various heights from 0.5 to 3 inches passing through a channel, while ignoring the channel bottom.

Filter Paper Length Control

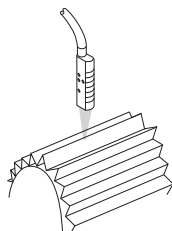

Description	Catalog Number
Comet focused diffuse reflective sensor	13102A

A focused diffuse reflective sensor interfaces with a programmable controller to measure a specific length of corrugated automotive filter paper. The control detects the presence or absence of a corrugation. When a predetermined number of corrugations has been detected, the programmable controller directs a shear to cut the paper.

Over/Underspeed Control

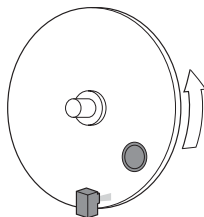

Description	Catalog Number
50 series reflex sensor	1450B
Motion detection logic module	8253A
Solid-state switch output device	8562B
3 in diameter retroreflector	6200A-6501

A reflex sensor with a motion detection module counts the revolutions of the wheel. Speed is controlled by a programmable controller. Provides timing ranges from 2.4 to 12,000 counts per minute.

Multi-Hole Casting Inspection

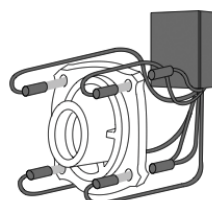

Description	Catalog Number
70 series modular control unit (four required)	8771A
70 series 35 ft thru-beam source (four required)	1173A-300
70 series 35 ft thru-beam detector (four required)	1273A-300
Panel mount socket for control unit (four required)	8905A

Remote sensors inspect for the presence of holes in a metal casting. Because each hole has its own inspection system, accurate defect information is recorded. Rugged sensor housing and extremely high signal strength handle dirt and grease with minimum maintenance. Using the modular control unit allows for dense packaging in small enclosures.

Broken Thread Detection

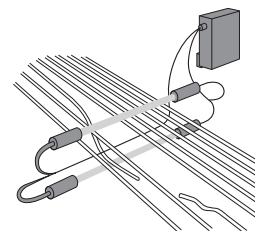

Description	Catalog Number
70 series high power control unit	8171B
Low contrast logic module	8215A
70 series 375 ft thru-beam source (two required)	1173A-100
70 series 375 ft thru-beam detector (two required)	1273A-100
DPDT relay	8530A
Mounting brackets	6142A

A pair of remote thru-beam sensors scan over and under multiple strands of thread. If a thread breaks and passes through one of the beams, the low-contrast logic module detects the sudden change in signal strength and energizes the output. Because this logic module does not react to slow changes in signal strength, it can operate in a dusty environment with little maintenance.

For assistance with these or other applications, call us at 1-800-426-9184.

Hypodermic Needle Quality Control

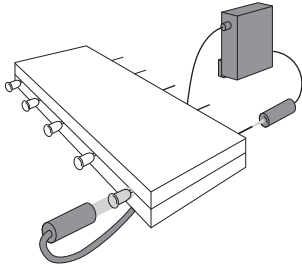

Description	Catalog Number
70 series high power control unit	8171B
70 series 300 ft thru-beam source	1173A-300
70 series 300 ft thru-beam detector	1273A-300
Triac output relay	8573A

A remote source and detector pair inspects for passage of light through a hypodermic needle. Their small design and waterproof stainless steel housing are appropriate for crowded machinery spaces and frequent washdowns. High signal strength allows quality inspection with hole sizes down to 0.007 in.

Web Flaw Detection

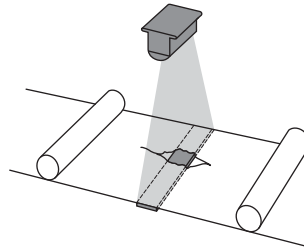

Description	Catalog Number
70 series high power control unit	8171B
Low contrast logic module	8215A
DPDT relay	8530A
70 series reflex curtain-of-light sensor	1471A
Strip retroreflector	6210A

A web passes over an array of retroreflectors. When light is returned to the sensor head, the output is energized and the web shuts down. Because of the superior response time of the control unit, high web speeds can be maintained.

Clear Plastic Web Break Detection

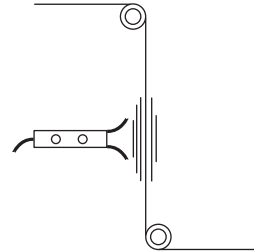

Description	Catalog Number
Comet wide beam diffuse	13107A

The clear web is detected by a wide beam diffuse reflective sensor. The wide beam helps it ignore reflection caused by fluttering of the web.

Web Splice Detection

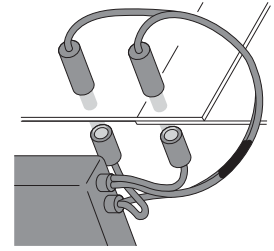

Description	Catalog Number
70 series differential control unit	9072A
One-shot logic module	8213A
DPDT relay	8526A
70 series 30 ft thru-beam source (two required)	1173A-300
70 series 30 ft thru-beam detector (two required)	1273A-300

When the two thru-beam detectors see the same signal strength, the output is zero. When the opacity of the web changes, as in a splice, the signal strengths are thrown out of balance and the output is energized. This system can be used on webs of different colors and opacities with no system reconfiguration.

Motion Position Detection

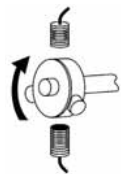

Description	Catalog Number
Tubular inductive proximity sensor	E57 product family or iProx

A tubular E57 proximity sensor is used to detect the presence of set screws on a shaft hub providing a control device with signals for speed regulation or detection of rotation.

Motion Control

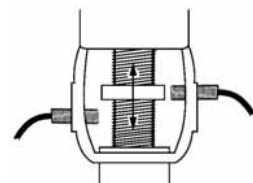

Description	Catalog Number
Tubular inductive proximity sensor	E57 product family or iProx

A pair of tubular proximity sensors is used to determine full open and fully closed valve position.

Web Guiding

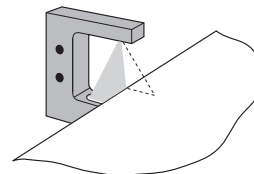

Description	Catalog Number
70 series slot sensor	1372A-6501
70 series analog control unit	8172A

The 1372A-6501 slot sensor head is mounted so that the edge of the web extends into the slot and blocks half of the source beam. As the web moves into or out of position, a proportional signal is provided by the analog control unit to alert your control system.

For assistance with these or other applications, call us at 1-800-426-9184.

Paper Presence Detection

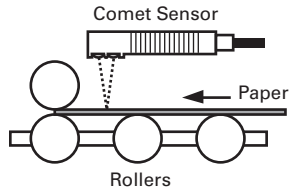

Description	Catalog Number
Comet Series 2 in right angle Perfect Prox sensor	13104R

Right angle viewing and compact size allow the sensor to be mounted in the tight confines of paper handling systems. High gain and sharp optical cut-off ensure that background machinery will be ignored while paper will be detected regardless of color and texture.

Damage Warning

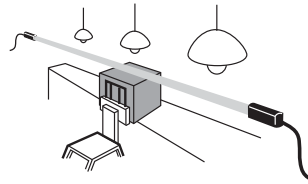

Description	Catalog Number
E58 Harsh Duty 800 ft thru-beam source	E58-30TS

E58 Harsh Duty 800 ft thru-beam detector	E58-30TD
--	-----------------

Source and detector are mounted at opposite ends of a long warehouse storage shelf with the beam situated a safe distance below overhead obstacles (lighting, conduit, gas lines, ducts, pipes, and so on). If a forklift operator interrupts the beam while moving a load, a siren or flashing light will warn him to stop before any damage occurs.

Zero Pressure Accumulation Conveyor

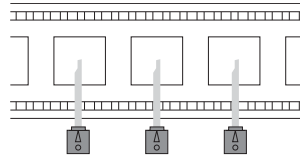

Description	Catalog Number
E68 Integral sensor valve	E68-SVS

200 Series zero pressure accumulation	14286/14266
---------------------------------------	--------------------

E68 Series or 200 Series sensors detect and control the movement of boxes on the conveyor, to maximize throughput and eliminate line pressure between boxes. The sensor contains all required logic with no need for a PLC.

Eaton Terms & Conditions



Terms & Conditions



Contents

<i>Description</i>	<i>Page</i>
Terms and Conditions of Sale	V8-A1-1
Terms of Payment	V8-A1-2
Freight	V8-A1-3
Warranty	V8-A1-3

Selling Policy (Supersedes Selling Policy 25-000, dated February 20, 2006)

Terms and Conditions of Sale

The Terms and Conditions of Sale set forth herein, and any supplements which may be attached hereto, constitute the full and final expression of the contract for the sale of products or services (hereinafter referred to as Product(s) or Services by Eaton Corporation (hereinafter referred to as Seller) to the Buyer, and supersedes all prior quotations, purchase orders, correspondence or communications whether written or oral between the Seller and the Buyer. Notwithstanding any contrary language in the Buyer's purchase order, correspondence or other form of acknowledgment, Buyer shall be bound by these Terms and Conditions of Sale when it sends a purchase order or otherwise indicates acceptance of this contract, or when it accepts delivery from Seller of the Products or Services.

THE CONTRACT FOR SALE OF THE PRODUCTS OR SERVICES IS EXPRESSLY LIMITED TO THE TERMS AND CONDITIONS OF SALE STATED HEREIN. ANY ADDITIONAL OR DIFFERENT TERMS PROPOSED BY BUYER ARE REJECTED UNLESS EXPRESSLY AGREED TO IN WRITING BY SELLER. No contract shall exist except as herein provided.

Complete Agreement

No amendment or modification hereto nor any statement, representation or warranty not contained herein shall be binding on the Seller unless made in writing by an authorized representative of the Seller. Prior dealings, usage of the trade or a course of performance shall not be relevant to determine the meaning of this contract even though the accepting or acquiescing party had knowledge of the nature of the performance and opportunity for objection.

Quotations

Written quotations are valid for 30 days from its date unless otherwise stated in the quotation or terminated sooner by notice.

Verbal quotations, unless accepted, expire the same day they are made.

A complete signed order must be received by Seller within 20 calendar days of notification of award, otherwise the price and shipment will be subject to re-negotiation.

Termination and Cancellation

Any order may be terminated by the Buyer only by written notice and upon payment of reasonable termination charges, including all costs plus profit.

Seller shall have the right to cancel any order at any time by written notice if Buyer breaches any of the terms hereof, becomes the subject of any proceeding under state or federal law for the relief of debtors, or otherwise becomes insolvent or bankrupt, generally does not pay its debts as they become due or makes an assignment for the benefit of creditors.

Appendix 1—Eaton Terms & Conditions

Effective Date: November 1, 2008

Prices

All prices are subject to change without notice. In the event of a price change, the effective date of the change will be the date of the new price or discount sheet, letter or telegram. All quotations made or orders accepted after the effective date will be on the new basis. For existing orders, the price of the unshipped portion of an order will be the price in effect at time of shipment.

Price Policy—Products and Services

When prices are quoted as firm for quoted shipment, they are firm provided the following conditions are met:

1. The order is released with complete engineering details.
2. Shipment of Products are made, and Services purchased are provided within the quoted lead time.
3. When drawings for approval are required for any Products, the drawings applicable to those Products must be returned within 30* calendar days from the date of the original mailing of the drawings by Seller. The return drawings must be released for manufacture and shipment and must be marked "APPROVED" or "APPROVED AS NOTED." Drawing re-submittals which are required for any other reason than to correct Seller errors will not extend the 30-day period.

* 60 days for orders through contractors to allow time for their review and approval before and after transmitting them to their customers.

If the Buyer initiates or in any way causes delays in shipment, provision of Services or return of approval drawings beyond the periods stated above, the price of the Products or Services will be increased 1% per month or fraction thereof up to a maximum of 18 months from the date of the Buyer's order. For delays resulting in shipment or provision of Services beyond 18 months from the date of the Buyer's order, the price must be renegotiated.

Price Policy—BLS

Refer to Price Policy 25-050.

Minimum Billing

Orders less than \$1,000 will be assessed a shipping and handling charge of 5% of the price of the order, with a minimum charge of \$25.00 unless noted differently on Product discount sheets.

Taxes

The price does not include any taxes. Buyer shall be responsible for the payment of all taxes applicable to, or arising from the transaction, the Products, its sale, value, or use, or any Services performed in connection therewith regardless of the person or entity actually taxed.

Terms of Payment

Products

Acceptance of all orders is subject to the Buyer meeting Seller's credit requirements. Terms of payment are subject to change for failure to meet such requirements. Seller reserves the right at any time to demand full or partial payment before proceeding with a contract of sale as a result of changes in the financial condition of the Buyer. Terms of Payment are either Net 30 days from the date of invoice of each shipment or carry a cash discount based on Product type. Specific payment terms for Products are outlined in the applicable Product discount schedules.

Services

Terms of payment are net within 30 days from date of invoice for orders amounting to less than \$50,000.00.

Terms of payment for orders exceeding \$50,000.00 shall be made according to the following:

1. Twenty percent (20%) of order value with the purchase order payable 30 days from date of invoice.
2. Eighty percent (80%) of order value in equal monthly payments over the performance period payable 30 days from date of invoice.

Except for work performed (i) under a firm fixed price basis or (ii) pursuant to terms of a previously priced existing contract between Seller and Buyer, invoices for work performed by Seller shall have added and noted on each invoice a charge of 3% (over and above the price of the work) which is related to Seller compliance with present and proposed environmental, health, and safety regulations associated with prescribed requirements covering hazardous materials management and employee training, communications, personal protective equipment, documentation and record keeping associated therewith.

Adequate Assurances

If, in the judgment of Seller, the financial condition of the Buyer, at any time during the period of the contract, does not justify the terms of payment specified, Seller may require full or partial payment in advance.

Delayed Payment

If payments are not made in accordance with these terms, a service charge will, without prejudice to the right of Seller to immediate payment, be added in an amount equal to the lower of 1.5% per month or fraction thereof or the highest legal rate on the unpaid balance.

Freight

Freight policy will be listed on the Product discount sheets, or at option of Seller one of the following freight terms will be quoted.

F.O.B.—P/S—Frt./Ppd. and Invoiced

Products are sold F.O.B. point of shipment freight prepaid and invoiced to the Buyer.

F.O.B.—P/S—Frt./Ppd. and Allowed

Products sold are delivered F.O.B. point of shipment, freight prepaid and included in the price.

F.O.B. Destination—Frt./Ppd. and Allowed

At Buyer's option, Seller will deliver the Products F.O.B. destination freight prepaid and 2% will be added to the net price.

The term "freight prepaid" means that freight charges will be prepaid to the accessible common carrier delivery point nearest the destination for shipments within the United States and Puerto Rico unless noted differently on the Product discount sheets. For any other destination contact Seller's representative.

Shipment and Routing

Seller shall select the point of origin of shipment, the method of transportation, the type of carrier equipment and the routing of the shipment.

If the Buyer specifies a special method of transportation, type of carrier equipment, routing, or delivery requirement, Buyer shall pay all special freight and handling charges.

When freight is included in the price, no allowance will be made in lieu of transportation if the Buyer accepts shipment at factory, warehouse, or freight station or otherwise supplies its own transportation.

Risk of Loss

Risk of loss or damage to the Products shall pass to Buyer at the F.O.B. point.

Concealed Damage

Except in the event of F.O.B. destination shipments, Seller will not participate in any settlement of claims for concealed damage.

When shipment has been made on an F.O.B. destination basis, the Buyer must unpack immediately and, if damage is discovered must:

1. Not move the Products from the point of examination.
2. Retain shipping container and packing material.
3. Notify the carrier in writing of any apparent damage.
4. Notify Seller representative within 72 hours of delivery.
5. Send Seller a copy of the carrier's inspection report.

Witness Tests/Customer Inspection

Standard factory tests may be witnessed by the Buyer at Seller's factory for an additional charge calculated at the rate of \$2,500 per day (not to exceed eight (8) hours) per Product type. Buyer may final inspect Products at the Seller's factory for \$500 per day per Product type.

Witness tests will add one (1) week to the scheduled shipping date. Seller will notify Buyer fourteen (14) calendar days prior to scheduled witness testing or inspection. In the event Buyer is unable to attend, the Parties shall mutually agree on a rescheduled date. However, Seller reserves the right to deem the witness tests waived with the right to ship and invoice Products.

Held Orders

For any order held, delayed or rescheduled at the request of the Buyer, Seller may, at its sole option (1) require payment to be based on any reasonable basis, including but not limited to the contract price, and any additional expenses, or cost resulting from such a delay; (2) store Products at the sole cost and risk of loss of the Buyer; and/or (3) charge to the Buyer those prices under the applicable price policy. Payment for such price, expenses and costs, in any such event, shall be due by Buyer within thirty (30) days from date of Seller's invoice. Any order so held delayed or rescheduled beyond six (6) months will be treated as a Buyer termination.

Drawing Approval

Seller will design the Products in line with, in Seller's judgment, good commercial practice. If at drawing approval Buyer makes changes outside of the design as covered in their specifications, Seller will then be paid reasonable charges and allowed a commensurate delay in shipping date based on the changes made.

Drawing Re-Submittal

When Seller agrees to do so in its quotation, Seller shall provide Buyer with the first set of factory customer approval drawing(s) at Seller's expense. The customer approval drawing(s) will be delivered at the quoted delivery date. If Buyer requests drawing changes or additions after the initial factory customer approval drawing(s) have been submitted by Seller, the Seller, at its option, may assess Buyer drawing charges. Factory customer approval drawing changes required due to misinterpretation by Seller will be at Seller's expense. Approval drawings generated by Bid Manager are excluded from this provision.

Warranty**Warranty for Products**

Seller warrants that the Products manufactured by it will conform to Seller's applicable specifications and be free from failure due to defects in workmanship and material for one (1) year from the date of installation of the Product or eighteen (18) months from the date of shipment of the Product, whichever occurs first.

In the event any Product fails to comply with the foregoing warranty Seller will, at its option, either (a) repair or replace the defective Product, or defective part or component thereof, F.O.B. Seller's facility freight prepaid, or (b) credit Buyer for the purchase price of the Product. All warranty claims shall be made in writing.

Seller requires all non-conforming Products be returned at Seller's expense for evaluation unless specifically stated otherwise in writing by Seller.

This warranty does not cover failure or damage due to storage, installation, operation or maintenance not in conformance with Seller's recommendations and industry standard practice or due to accident, misuse, abuse or negligence. This warranty does not cover reimbursement for labor, gaining access, removal, installation, temporary power or any other expenses, which may be incurred in connection with repair or replacement.

This warranty does not apply to equipment not manufactured by Seller. Seller limits itself to extending the same warranty it receives from the supplier.

Appendix 1—Eaton Terms & Conditions

Effective Date: November 1, 2008

Extended Warranty for Products

If requested by the Buyer and specifically accepted in writing by Seller, the foregoing standard warranty for Products will be extended from the date of shipment for the period and price indicated below:

- 24 months—2% of Contract Price
- 30 months—3% of Contract Price
- 36 months—4% of Contract Price

Special Warranty (In and Out) for Products

If requested by the Buyer and specifically accepted in writing by Seller, Seller will, during the warranty period for Products, at an additional cost of 2% of the contract price, be responsible for the direct cost of:

1. Removing the Product from the installed location.
2. Transportation to the repair facility and return to the site.
3. Reinstallation on site.

The total liability of Seller for this Special Warranty for Products is limited to 50% of the contract price of the particular Product being repaired and excludes expenses for removing adjacent apparatus, walls, piping, structures, temporary service, etc.

Warranty for Services

Seller warrants that the Services performed by it hereunder will be performed in accordance with generally accepted professional standards.

The Services, which do not so conform, shall be corrected by Seller upon notification in writing by the Buyer within one (1) year after completion of the Services.

Unless otherwise agreed to in writing by Seller, Seller assumes no responsibility with respect to the suitability of the Buyer's, or its customer's, equipment or with respect to any latent defects in equipment not supplied by Seller. This warranty does not cover damage to Buyer's, or its customer's, equipment, components or parts resulting in whole or in part from improper maintenance or operation or from their deteriorated condition. Buyer will, at its cost, provide Seller with unobstructed access to the defective Services, as well as adequate free working space in the immediate vicinity of the defective Services and such facilities and systems, including, without limitation, docks, cranes and utility disconnects and connects, as may be necessary in order that Seller may perform its warranty obligations. The conducting of any tests shall be mutually agreed upon and Seller shall be notified of, and may be present at, all tests that may be made.

Warranty for Power Systems Studies

Seller warrants that any power systems studies performed by it will conform to generally accepted professional standards. Any portion of the study, which does not so conform, shall be corrected by Seller upon notification in writing by the Buyer within six (6) months after completion of the study. All warranty work shall be performed in a single shift straight time basis Monday through Friday. In the event that the study requires correction of warranty items on an overtime schedule, the premium portion of such overtime shall be for the Buyer's account.

Limitation on Warranties for Products, Services and Power Systems Studies

THE FOREGOING WARRANTIES ARE EXCLUSIVE EXCEPT FOR WARRANTY OF TITLE. SELLER DISCLAIMS ALL OTHER WARRANTIES INCLUDING ANY IMPLIED WARRANTIES OF MERCHANTABILITY AND FITNESS FOR A PARTICULAR PURPOSE. CORRECTION OF NON-CONFORMITIES IN THE MANNER AND FOR THE PERIOD OF TIME PROVIDED ABOVE SHALL CONSTITUTE SELLER'S SOLE LIABILITY AND BUYER'S EXCLUSIVE REMEDY FOR FAILURE OF SELLER TO MEET ITS WARRANTY OBLIGATIONS, WHETHER CLAIMS OF THE BUYER ARE BASED IN CONTRACT, IN TORT (INCLUDING NEGLIGENCE OR STRICT LIABILITY), OR OTHERWISE.

Asbestos

Federal Law requires that building or facility owners identify the presence, location and quantity of asbestos containing material (hereinafter "ACM") at work sites. Seller is not licensed to abate ACM. Accordingly, for any contract which includes the provision of Services, prior to (i) commencement of work at any site under a specific Purchase Order, (ii) a change in the work scope of any Purchase Order, the Buyer will certify that the work area associated with the Seller's scope of work includes the handling of Class II ACM, including but not limited to generator wedges and high temperature gaskets which include asbestos materials. The Buyer shall, at its expense, conduct abatement should the removal, handling, modification or reinstallation, or some or all of them, of said Class II ACM be likely to generate airborne asbestos fibers; and should such abatement affect the cost of or time of performance of the work then Seller shall be entitled to an equitable adjustment in the schedule, price and other pertinent affected provisions of the contract.

Compliance with Nuclear Regulation

Seller's Products are sold as commercial grade Products not intended for application in facilities or activities licensed by the United States Nuclear Regulatory Commission for atomic purposes. Further certification will be required for use of the Products in any safety-related application in any nuclear facility licensed by the U.S. Nuclear Regulatory Commission.

Returning Products

Authorization and shipping instructions for the return of any Products must be obtained from Seller before returning the Products.

When return is occasioned due to Seller error, full credit including all transportation charges will be allowed.

Product Notices

Buyer shall provide the user (including its employees) of the Products with all Seller supplied Product notices, warnings, instructions, recommendations, and similar materials.

Force Majeure

Seller shall not be liable for failure to perform or delay in performance due to fire, flood, strike or other labor difficulty, act of God, act of any governmental authority or of the Buyer, riot, embargo, fuel or energy shortage, car shortage, wrecks or delays in transportation, or due to any other cause beyond Seller's reasonable control. In the event of delay in performance due to any such cause, the date of delivery or time for completion will be extended by a period of time reasonably necessary to overcome the effect of such delay.

Liquidated Damages

Contracts which include liquidated damage clauses for failure to meet shipping or job completion promises are not acceptable or binding on Seller, unless such clauses are specifically accepted in writing by an authorized representative of the Seller at its headquarters office.

Patent Infringement

Seller will defend or, at its option, settle any suit or proceeding brought against Buyer, or Buyer's customers, to the extent it is based upon a claim that any Product or part thereof, manufactured by Seller or its subsidiaries and furnished hereunder, infringes any United States patent, other than a claim of infringement based upon use of a Product or part thereof in a process, provided Seller is notified in reasonable time and given authority, information and assistance (at Seller's expense) for the defense of same. Seller shall pay all legal and court costs and expenses and court-assessed damages awarded therein against Buyer resulting from or incident to such suit or proceeding. In addition to the foregoing, if at any time Seller determines there is a substantial question of infringement of any United States patent, and the use of such Product is or may be enjoined, Seller may, at its option and expense: either (a) procure for Buyer the right to continue using and selling the Product; (b) replace the Product with non-infringing apparatus; (c) modify the Product so it becomes non-infringing; or (d) as a last resort, remove the Product and refund the purchase price, equitably adjusted for use and obsolescence. In no case does Seller agree to pay any recovery based upon its Buyer's savings or profit through use of Seller's Products whether the use be special or ordinary. The foregoing states the entire liability of Seller for patent infringement.

The preceding paragraph does not apply to any claim of infringement based upon: (a) any modification made to a Product other than by Seller; (b) any design and/or specifications of Buyer to which a Product was manufactured; or (c) the use or combination of Product with other products where the Product does not itself infringe. As to the above-identified claim situations where the preceding paragraph does not apply, Buyer shall defend and hold Seller harmless in the same manner and to the extent as Seller's obligations described in the preceding paragraph. Buyer shall be responsible for obtaining (at Buyer's expense) all license rights required for Seller to be able to use software products in the possession of Buyer where such use is required in order to perform any Service for Buyer.

With respect to a Product or part thereof not manufactured by Seller or its subsidiaries, Seller will attempt to obtain for Buyer, from the supplier(s), the patent indemnification protection normally provided by the supplier(s) to customers.

Compliance with OSHA

Seller offers no warranty and makes no representation that its Products comply with the provisions or standards of the Occupational Safety and Health Act of 1970, or any regulation issued thereunder. In no event shall Seller be liable for any loss, damage, fines, penalty or expenses arising under said Act.

Limitation of Liability

THE REMEDIES OF THE BUYER SET FORTH IN THIS CONTRACT ARE EXCLUSIVE AND ARE ITS SOLE REMEDIES FOR ANY FAILURE OF SELLER TO COMPLY WITH ITS OBLIGATIONS HEREUNDER.

NOTWITHSTANDING ANY PROVISION IN THIS CONTRACT TO THE CONTRARY, IN NO EVENT SHALL SELLER BE LIABLE IN CONTRACT, IN TORT (INCLUDING NEGLIGENCE OR STRICT LIABILITY) OR OTHERWISE FOR DAMAGE TO PROPERTY OR EQUIPMENT OTHER THAN PRODUCTS SOLD HEREUNDER, LOSS OF PROFITS OR REVENUE, LOSS OF USE OF PRODUCTS, COST OF

CAPITAL, CLAIMS OF CUSTOMERS OF THE BUYER OR ANY SPECIAL, INDIRECT, INCIDENTAL OR CONSEQUENTIAL DAMAGES WHATSOEVER, REGARDLESS OF WHETHER SUCH POTENTIAL DAMAGES ARE FORESEEABLE OR IF SELLER HAS BEEN ADVISED OF THE POSSIBILITY OF SUCH DAMAGES.

THE TOTAL CUMULATIVE LIABILITY OF SELLER ARISING FROM OR RELATED TO THIS CONTRACT WHETHER THE CLAIMS ARE BASED IN CONTRACT, IN TORT (INCLUDING NEGLIGENCE OR STRICT LIABILITY) OR OTHERWISE, SHALL NOT EXCEED THE PRICE OF THE PRODUCT OR SERVICES ON WHICH SUCH LIABILITY IS BASED.

Enclosure Ratings

Index of Enclosure Protection—General

The UL®, NEMA® and IEC organizations (and other international groups) define degrees of protection provided by electrical enclosures with respect to personnel, equipment within the housing and the ingress of water.

Subtle differences do exist between the test procedures and specifications of these organizations.

To claim ratings to NEMA specifications, the testing is performed and certified by the manufacturers themselves.

To comply to UL and IEC specifications, the manufacturers must submit product samples, materials used and other data to an independent testing laboratory before ratings can be claimed.

In addition, IEC “IP” ratings differ from NEMA in that they do not apply to protection against the risk of explosion or conditions such as humidity, corrosive gases, fungi or vermin. In addition, different parts of the equipment can have different degrees of protection and still comply.

The table shown below is a comparison of the NEMA/UL/IEC enclosure specifications to be used as an approximate reference only. Do not use the table to convert from IEC to NEMA designations. For a definition of the ratings listed, see examples below and tables on **Page V8-A2-2**.

NEMA/UL/IEC Enclosure Type Cross-Reference

Enclosure Type Cross-Reference—Approximate

IEC 529 does not specify equivalents to NEMA Enclosure Types 7, 8, 9 or 10.

NEMA Enclosure Rating	IP10	IP20	IP21	IP22	IP23	IP30	IP31	IP32	IP33	IP40	IP41	IP42	IP43	IP50	IP51	IP52	IP53	IP54	IP55	IP56	IP60	IP61	IP62	IP63	IP64	IP65	IP66	IP67	IP68
1	X	X	X	X	X	—	—	—	—	—	—	—	—	—	—	—	—	—	—	—	—	—	—	—	—	—	—	—	—
2	X	X	X	X	X	—	—	—	—	—	—	—	—	—	—	—	—	—	—	—	—	—	—	—	—	—	—	—	—
3	X	X	X	X	X	X	X	X	X	X	X	X	X	X	X	X	X	X	X	X	X	X	X	X	X	X	—	—	—
3R	X	X	X	X	X	X	X	X	—	—	—	—	—	—	—	—	—	—	—	—	—	—	—	—	—	—	—	—	—
3S	X	X	X	X	X	X	X	X	X	X	X	X	X	X	X	X	X	X	X	X	X	X	X	X	X	X	—	—	—
4	X	X	X	X	X	X	X	X	X	X	X	X	X	X	X	X	X	X	X	X	X	X	X	X	X	X	X	X	—
4X	X	X	X	X	X	X	X	X	X	X	X	X	X	X	X	X	X	X	X	X	X	X	X	X	X	X	X	X	—
6	X	X	X	X	X	X	X	X	X	X	X	X	X	X	X	X	X	X	X	X	X	X	X	X	X	X	X	X	—
6P	X	X	X	X	X	X	X	X	X	X	X	X	X	X	X	X	X	X	X	X	X	X	X	X	X	X	X	X	X
12	X	X	X	X	X	X	X	X	X	X	X	X	X	X	X	X	X	X	X	X	X	X	X	X	X	X	—	—	—
13	X	X	X	X	X	X	X	X	X	X	X	X	X	X	X	X	X	X	X	X	X	X	X	X	X	X	—	—	—

Appendix 2

Enclosure Ratings

IEC Environmental Enclosure Ratings

Examples of Designations

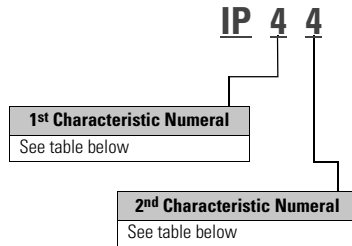

An enclosure with this designation is protected against the penetration of solid objects greater than 1.0 mm and against splashing water.

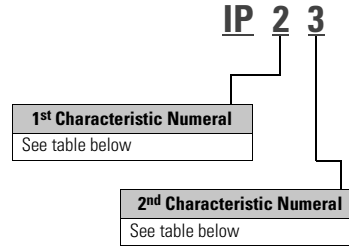

An enclosure with this designation is protected against the penetration of solid objects greater than 12 mm and against rain.

Index of Enclosure Ratings—IEC

1st Characteristic Numeral

Numeral	Description
Protection Against Contact and the Penetration of Solid Bodies	
0	Not protected
1	Protection against solid objects greater than 50 mm
2	Protection against solid objects greater than 12 mm
3	Protection against solid objects greater than 2.5 mm
4	Protection against solid objects greater than 1.0 mm
5	Dust protected
6	Dust-tight

2nd Characteristic Numeral

Numeral	Description
0	Not protected
1	Protection against dripping water
2	Protection against dripping water when tilted up 15 degrees
3	Protection against rain
4	Protection against splashing water
5	Protection against water jets
6	Protection against heavy seas
7	Protection against the effects of immersion
8	Protection against immersion

NEMA Definitions Pertaining to Non-hazardous Locations—NEMA Standard 250

Type 1

Enclosures are intended for indoor use, primarily to provide a degree of protection against contact with the enclosed equipment.

Type 3

Enclosures are intended for outdoor use, primarily to provide a degree of protection against windblown dust, rain, sleet and external ice formation.

Type 3R

Enclosures are intended for outdoor use, primarily to provide a degree of protection against falling rain, sleet and external ice formation.

Type 4

Enclosures are intended for indoor or outdoor use, primarily to provide a degree of protection against windblown dust and rain, splashing water and hose-directed water.

Type 4X

Enclosures are intended for indoor or outdoor use, primarily to provide a degree of protection against corrosion, windblown dust and rain, splashing water and hose-directed water.

Type 6

Enclosures are intended for indoor or outdoor use, primarily to provide a degree of protection against the entry of water during occasional temporary submersion at a limited depth.

Type 6P

Enclosures are intended for indoor or outdoor use, primarily to provide a degree of protection against the entry of water during prolonged submersion at a limited depth.

Type 12

Enclosures are intended for indoor use, primarily to provide a degree of protection against dust, falling dirt, and dripping non-corrosive liquids.

Type 13

Enclosures are intended for indoor use, primarily to provide a degree of protection against dust, spraying of water, oil and non-corrosive coolant.

NEC Definitions Pertaining to Hazardous Locations—Article 50

E51 Limit Switch Type Proximity Switches are rated for use in the following locations:

Class I Division 2, Groups A, B, C or D—Indoor Use

For the definition of a Class I Division 2 location, see National Electrical Code Article 500-5, paragraph (b).

For the definitions of Class I Group A, B, C, D Classifications, see the National Electrical Code Article 500-3, paragraph (a).

Class II Division 2, Groups For G—Indoor Use

For the definition of a Class II Division 2 location, see National Electrical Code Article 500-6, paragraph (b).

For the definitions of Class II Group F and G Classifications, see the National Electrical Code Article 500-3, paragraph (b).

Class III Division 2—Indoor Use

For the definition of a Class III Division 2 location, see National Electrical Code Article 500-7, paragraph (b).

For the definitions of Class III Classifications, see the National Electrical Code Article 500-7.

Glossary of Terms

Acid-Resistant Enclosure—So constructed that it will not be injured readily by exposure to acid fumes.

Actuator—Mechanism of the limit switch that operates the contacts.

Alignment—Positioning of light source and detector, reflector or target in order to obtain maximum signal strength (see also *Excess Gain*).

Ambient Light—Light reaching a sensor detector that is not generated by its light source.

Amp or Ampere—A unit of measurement of electric current produced by one volt acting through the resistance of one ohm.

Axial Approach—(Head-On) The target approaches the sensing face of the sensor with its center moving along the reference axis of the coil/core. The target surface is parallel to the sensor face.

Bend Radius—The minimum radius that a fiber optic cable can withstand without breaking the fibers.

Break—To open an electrical circuit.

Break Distance—The effective open gap distance between the stationary and movable objects.

Burden Current—The operating current of a line powered, three-wire, solid-state sensor. This current does not pass through the load.

Cam—Machine part or component that applies force to the switch actuator, causing it to move as intended.

Capacitance—The ability of insulators to store an electrical charge.

Capacitive Proximity Sensor—A sensor that operates on the principle of dielectric capacitance with a target. It detects the presence or absence of metallic or nonmetallic objects without physical contact. It is a self-contained, solid-state device with no moving parts. Sensitivity adjustment provided.

Celsius—See *Fahrenheit/Celsius*.

CENELEC—European Committee for Electro-Technical Standardization.

Complementary Output—Sensors with normally open (NO) and normally closed (NC) outputs, both of which change state simultaneously.

Contrast—The ratio between excess gain under light conditions and excess gain under dark conditions. The higher the contrast ratio, the higher the reliability of the sensing application.

CSA®—Canadian Standards Association, Canada.

Current—The rate of flow of electric charge in an electrical circuit.

Current Sinking Sensor (NPN) or N Type—The negative terminal of a DC system is called the sink, because conventional current normally flows into it. A current sinking sensor “sinks” the current from the load.

Current Sourcing Sensor (PNP) or P Type—The positive terminal of a DC system is called the source, because conventional current normally flows from it. A current sourcing sensor “sources” the current to the load.

Damping—A loading effect due to eddy currents being induced into the surface of a sensed metallic target, causing a reduction in amplitude of the inductive proximity sensor’s oscillator signal.

Dark Operate—A dark operate sensor generates an output when the source light intensity is sufficiently reduced at the detector (the sensor sees “dark”).

Detector—See *Thru-Beam Detector*.

Dielectric—The insulator separating the plates in a capacitor.

Differential or Differential Travel (D.T.)—Plunger or actuator travel from point where contacts “snap over” to point where they “snap back.”

Diffuse Reflective Sensing—A photoelectric sensing method in which the light from the source hits the target surface and is then diffused from the surface in all directions. Part of this light returns to the detector. If the intensity is high enough, the sensor generates an output. This is sometimes referred to as photoelectric “proximity” sensing.

DIN—Deutsch Industrie Norm, Federal Republic of Germany (dimensions).

Double Break Contacts—Circuit “breaks” in two places.

Double Insulated Enclosure—An insulation system with the two insulations physically separated and so arranged that they are not simultaneously subjected to the same deteriorating influences (temperature, contaminants, and so on) to the same degree.

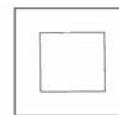

Symbol Representing Double Insulated Enclosures

Double Pole, Double Throw (DPDT)—A switch that makes and breaks two different circuits. Example, (2) NO and (2) NC contacts.

Drip-Proof Enclosure—So constructed or protected that falling dirt or drops of liquid will not interfere with the successful operation of the apparatus under specified test conditions.

Dust-Tight Enclosure—So constructed as to meet the requirements of a specified dust-tightness test.

Dwell Time—The time that the target is present in the sensing field and is detected by the sensor.

Eddy Current—Current induced into the body of a metallic object by an oscillating electromagnetic field.

Effective Beam—The light beam travelling directly between a thru-beam source and detector that must be completely blocked for detection to occur.

Electromechanical Limit

Switch—A pilot control device that converts a mechanical motion via physical contact with a target into an electrical control signal. The rotary arm or push rod on the switch body housing is mechanically connected to the switching element inside. The cam, machine component or moving object comes into contact with the limit switch at a pre-determined position.

Embedded—A shielded core/coil sensor “embedded” in the surrounding metal mounting. The sensor operation is not affected by surrounding metal. Also referred to as “Flush Mounting.”

Emitter—See *Thru-Beam Source*.

Enclosed Switch—A basic switch unit enclosed in a metal housing to provide increased durability and conduit connection.

Excess Gain—Measurement of the sensing power of a photoelectric sensor to detect an object in a given environment.

External Mounting Enclosure—Enclosure mounting provisions external to the apparatus cavity.

Fahrenheit/Celsius—Temperature scale conversion.

$$F^{\circ} = 9/5 (C^{\circ}) + 32$$

$$C^{\circ} = 5/9 (F^{\circ}) - 32$$

Ferrous—Metallic material which contains steel, nickel or cobalt.

Fiber Optic—Sensor with remote optics comprised of thin plastic or glass fibers, for detection in very tight places or extremely harsh environments.

Field of View—The region illuminated by the light source and seen by the detector. Field of View is sometimes referred to as “spot size” and may be expressed as a circle diameter at a given range, or in degrees emanating from the sensor. In both cases, Field of View is a three-dimensional area roughly the shape of a cone.

Fixed Focus—A sensing mode where the light source and the detector are angled towards one another, forming a focal point. The target will only be detected in this area where the source and detector fields of view cross.

Flush Mounting Enclosure—So designed as to have a minimal front projection when set into and secured to a flat surface.

Free Position (F.P.)—Position of switch plunger or actuator when no external force is applied other than gravity.

Hysteresis—The difference between the sensor operate point, where the target is detected, and release point, where the target is no longer detected.

IEC—International Electrotechnical Commission. Writes recommended performance and safety standards for electrical products.

Inductive Proximity Sensor—A non-contact proximity sensor that operates on the principle of induced electromagnetic field (for example, eddy currents) in the surface of a metallic target. It detects the presence or absence of a metal object without physical contact. It is a self-contained, solid-state device with no moving parts.

Infrared—Invisible light radiation at wavelengths of 690 nanometers and longer.

Lateral Approach—(Side-By) Approach path of a target perpendicular to the reference axis, target approaches the sensor from the side.

Leakage Current—Small current flowing through a solid-state output when in the OFF state.

LED (Light Emitting Diode)—Semi-conductor that generates monochromatic light when current flows in the conductive direction. Shock/vibration resistant, long life, low current draw alternative to incandescent lamps. As a low power, no heat source of light, the LED is the standard light source for photoelectric sensors.

LED Indicators—Light emitting diodes (LEDs) provide diagnostic information as to the status of the sensor (operated or not operated). Diagnostic indications are switch status, power ON/OFF status and/or short circuit conditions.

Light Curtain—Specialized reflex sensor head that emits a fan-shaped beam of light.

Light Operate—A light operate sensor generates an output when the source light intensity is sufficiently increased at the detector (the sensor sees “light”).

Line-Powered Sensor—(Three-wire) A sensor that draws its operating current (burden current) directly from the line. Its operating current does not flow through the load. Three connections are required.

Load-Powered Sensor—(Two-wire) A sensor that draws its operating current (residual current) through the load. Load Powered Sensors require only two connections (exclusive of ground) and are always in series with the load.

Load Release Time—The time delay which occurs between the point at which the sensor output restores to the not operated state and the load restores to OFF-state condition.

Maintained Contact—Sustained contact after plunger has been released, but can be reset.

Make—To close or establish a path for electrical current.

Minimum Holding Current—Current required to sustain a solid-state sensor in an operating condition.

Modulated Light Sensors—A photoelectric sensor that operates on light pulses rather than on constant light intensity.

Momentary Contact—Contacts return from operated position to normal condition when actuating force is removed.

Nanometer (nm)—This is the typical unit of measure for the wavelength of source light in a photoelectric sensor.
1 Nano-meter is equal to 10^{-9} meter.

NEMA—National Electrical Manufacturers Association, United States.

Non-embeddable—An inductive style that requires a generous metal-free area surrounding the sensor face to allow for the longest sensing distances, often four times the shielded range.

Non-ferrous—Metallic material which does not contain steel, nickel or cobalt. Example: Aluminum

Appendix 2

Glossary of Terms

Normally Closed (NC)

Output—Solid-state output configuration which emulates a normally closed relay contact condition.



Normally closed

Normally Open (NO)

Output—Solid-state output configuration which emulates a normally open relay contact condition.



Normally open

NPN (Current Sink)—The sensor derives (“sinks”) its current from the load.

Opaque—An opaque object is impervious to the passage of light through it. Opaque objects offer high reliability in sensing because they provide the highest contrast between light beam blocked and unblocked conditions. See also *Contrast* and *Translucent*.

Operate Point—The point, at a distance from the sensor face, at which a target is detected.

Operating Force—That straight line force in the designated direction applied to the actuator to cause the switch contacts to snap to the operated contact position.

Operating Mode—See *Light Operate* and *Dark Operate*.

Operating Position (O.P.)—The position of the actuator at which the contacts snap to the operated contact position.

Outdoor Enclosure—Suitable for installation where exposed to the weather.

Over-Travel (O.T.)—The movement of the actuator beyond the contact trip position without damage occurring to the switch.

Perfect Prox®—A sensor used to detect an object at or inside a given range while ignoring a nearby background.

Photoelectric Sensor—An electronic device capable of recognizing changes in light intensity and converting these changes into a change in output state. It is also referred to as a “Photoeye.”

PNP (Current Source)—The sensor provides (“sources”) the current to the load.

Polarized Reflex Sensor—A reflex photoelectric sensor that uses a visible light source, polarizing filters and a prismatic retroreflector to help the sensor distinguish light returning from the retroreflector from that returning from a shiny target surface, thus increasing the reliability of the sensing application.

Positive Opening Operation (on NC contacts)—The achievement of contact separation as the direct result of a specified movement of the switch actuator through non-resilient members (for example not dependent upon strings). Also called Direct Opening and Positive Break.

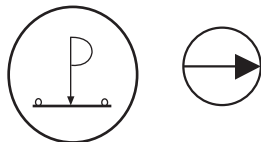

Symbol representing positive opening NC contacts

Precision Snap-Action Switch—A mechanically operated electric switch having predetermined and accurately controlled characteristics.

Pre-Travel (P.T.)—The distance or angle through which the actuator moves before reaching the point at which the contacts are tripped.

Programmable Output—Sensor output functions that can be wired to output normally open or normally closed, but not simultaneously.

Proximity Sensor—See *Inductive Proximity Sensor*.

Radio Frequency Interference (RFI)—Interference caused by radio transceiver signals (for example, walkie talkie devices).

Rainproof Enclosure—So constructed, protected or treated as to prevent rain under specified conditions from interfering with successful operation of the apparatus.

Receiver—See *Thru-Beam Detector*.

Reference Axis—The axis that is perpendicular to and passes through the center of the sensor face.

Reflex Sensing—A sensing mode where source light emitted from the sensor is reflected directly back to the detector by a prismatic retroreflector. When this light beam is blocked by a target, the sensor changes output state.

Release Force (R.F.)—Amount of force still applied to switch plunger or actuator at the moment contacts snap from the operated position to the unoperated position.

Release Point—The point, at a distance from the sensor face, at which the target is no longer detected by the sensor.

Release Time—The time delay from when a target reaches the release point to when the output restores to the not operated state.

Repeat Accuracy—Variations in sensing distance between successive sensor operations due to component tolerances when all operating conditions are kept constant.

Resistance—The opposition to the flow of electricity in an electric circuit measured in ohms.

Response Time—Time interval from when the target reaches the operate point to when the output goes into the operated state.

Retroreflective Sensing—See *Reflex Sensing*.

Retroreflector—A highly reflective material that returns light that strikes it back in a direction parallel to its original course.

Return Force—Amount of force still applied to a switch plunger or actuator at the moment the contacts snap from the operated position to the unoperated position.

Reverse Polarity Protection—Internal circuitry that prevents damage to the sensor in case of accidental reverse polarity connection (plus-to-minus, minus-to-plus).

Rust-Resistant Enclosure—So constructed, protected or treated that rust will not exceed a specified limit when subjected to a specified rust-resistance test.

Semi-Shielded—An inductive style that still requires a metal-free zone around the sensor face, but the required area is greatly reduced. Range for this type is typically two to three times the range of a similar shielded sensor.

Sensing Face—The surface from which the sensing field is projected from a sensor.

Sensing Distance—The physically measured distance from a particular sensor to a particular target. The three specific definitions of sensing distance are:

Effective Sensing Distance (Sr)—The operating range of a sensor measured at nominal voltage and temperature.

Nominal Sensing Distance (Sn)—The distance at which a sensor is designed to detect a standard target at rated voltage and temperature.

Usable Sensing Distance (Su)—The distance at which a particular sensor should sense a standard target over the operating temperature and voltage limits recommended by the manufacturer.

Sensing Range—See *Sensing Distance*.

Shielded—An inductive style that allows the user to mount the sensor flush in metal up to the sensor face without the sensor detecting the presence of that metal.

Short Circuit Protection—Internal circuitry that protects the sensor from electrical damage due to excessive current from a wiring short circuit.

Sleet-Proof Enclosure—So constructed or protected that the accumulation of sleet (ice) under specified test conditions will not interfere with the successful operation of the apparatus including external operation mechanism(s).

Slow Break Contacts—Contacts for which the speed of the contact make/break is dependent upon the speed of the operator.

Snap Action Contacts—Contacts for which the speed of the contact make/break is independent of the operator speed. Different tripping and reset points occur in each direction (differential travel).

Snubber Circuit—Circuit composed of a resistor and a capacitor in series, and connected across the device. This circuit serves to protect a sensor against electrical transients.

Source—See *Thru-Beam Source*.

Standard Target—A metallic object used for sensing distance measurement with inductive proximity sensors. For similar sensor models the standard target is a square mild steel plate 1 mm thick. The length of each side is equal to the diameter of the sensing face.

Submersible Enclosure—So constructed as to prevent water ingress when submerged in water under specified test conditions of pressure and time.

Thru-Beam Detector—The component of a thru-beam sensing system that receives the light being emitted by the source.

Thru-Beam Sensing—A sensing mode where the light source and detector are directed at each other across an area in which a target passes. Detection occurs when the target blocks the light beam travelling directly between the source and detector (called the “effective beam”).

Thru-Beam Source—The component of a thru-beam sensing system that emits light.

Time Delay Before Availability—Time delay from when power is initially supplied to a solid-state sensor device and the time when it will be ready to detect a target.

Total Travel (T.T.)—The sum of the pretravel and total overtravel expressed by distance or angle.

Translucent—A translucent object allows some reduced level of light to pass through it. Translucent objects can result in reliability problems in sensing if the contrast between light beam blocked and unblocked conditions is too low. See also *Contrast* and *Opaque*.

UL®—Underwriters Laboratories, Inc., United States. Independent facility which tests and certifies electrical equipment.

Unshielded—An inductive style that requires a metal-free zone surrounding the sensor face when mounting. Range for this type is typically 1.5–2 times the shielded range.

VDE—Verband Deutscher Electro-techniker, Federal Republic of Germany.

Watertight Enclosure—So constructed as to prevent water ingress applied in the form of a hose stream under specified test conditions.

Wavelength—Distance traveled by light while completing one complete sine-wave expressed in nanometers (nm). Each color has a specific wavelength.

Zero Crossing—The point in an AC cycle when the sine wave is at zero.

B

BUS256A18-33	V8-T6-18
BUS256A18-66	V8-T6-18
BUS256A24-25	V8-T6-18
BUS256A24-50	V8-T6-18
BUS256A30-20	V8-T6-18
BUS256A30-40	V8-T6-18
BUS256A36-16	V8-T6-18
BUS256A36-33	V8-T6-18
BUS256A40-15	V8-T6-18
BUS256A40-30	V8-T6-18
BUS256A42-14	V8-T6-18
BUS256A42-28	V8-T6-18
BUS256A48-12	V8-T6-18
BUS256A48-25	V8-T6-18
BUS256A54-11	V8-T6-18
BUS256A54-22	V8-T6-18
BUS256A60-10	V8-T6-18
BUS256A60-20	V8-T6-18
BUS256ISO-01B1	V8-T6-20
BUS256LINK-01B1	V8-T6-20
BUS256PWR-01B1	V8-T6-20
BUS256PWR120	V8-T6-20
BUS256PWR20-02B1	V8-T6-20
BUS266A18-33	V8-T6-17
BUS266A18-6	V8-T6-17
BUS266A18-66	V8-T6-17
BUS266A24-25	V8-T6-17
BUS266A24-5	V8-T6-17
BUS266A24-50	V8-T6-17
BUS266A30-20	V8-T6-17
BUS266A30-4	V8-T6-17
BUS266A30-40	V8-T6-17
BUS266A36-16	V8-T6-17
BUS266A36-3	V8-T6-17
BUS266A36-33	V8-T6-17
BUS266A40-15	V8-T6-17
BUS266A40-3	V8-T6-17
BUS266A40-30	V8-T6-17
BUS266A42-14	V8-T6-17
BUS266A42-2	V8-T6-17
BUS266A42-28	V8-T6-17
BUS266A48-12	V8-T6-17
BUS266A48-2	V8-T6-17
BUS266A48-25	V8-T6-17
BUS266A54-11	V8-T6-17
BUS266A54-2	V8-T6-17
BUS266A54-22	V8-T6-17
BUS266A60-10	V8-T6-17
BUS266A60-2	V8-T6-17
BUS266A60-20	V8-T6-17
BUS266ISO-01B1	V8-T6-9, V8-T6-19
BUS266JUMP15-01B1	V8-T6-9, V8-T6-19
BUS266JUMP15-02B1	V8-T6-9, V8-T6-19
BUS266LINK-01B1	V8-T6-9, V8-T6-19
BUS266PWR-01B1	V8-T6-7, V8-T6-19
BUS266PWR-5001B1	V8-T6-7, V8-T6-19
BUS266REL-01B1	V8-T6-7, V8-T6-19
BUS266REL-02B1	V8-T6-7, V8-T6-19
BUSJUMP36	V8-T6-20

C

CBCAP	V8-T10-9, V8-T10-14
CBDR4NSC	V8-T10-14
CBDR4P05	V8-T10-14
CBDR4P10	V8-T10-14
CBDR4PSC	V8-T10-14
CBDR6NSC	V8-T10-14
CBDR6P05	V8-T10-14
CBDR6P10	V8-T10-14
CBDR6PSC	V8-T10-14
CBDR8NSC	V8-T10-14
CBDR8P05	V8-T10-14
CBDR8P10	V8-T10-14
CBDR8PSC	V8-T10-14
CBMCAP	V8-T10-9
CS3ACY24XX	V8-T10-9
CS4ACY22XX	V8-T10-9
CSAR3F3CY1802	V8-T10-6
CSAR3F3CY1805	V8-T10-6
CSAR3F3CY1810	V8-T10-6
CSAR3F3CY2202	V8-T10-6
CSAR3F3CY2205	V8-T10-6
CSAR3F3CY2210	V8-T10-6
CSAR3F3RY2202	V8-T10-6
CSAR3F3RY2205	V8-T10-6
CSAR3F3RY2210	V8-T10-6
CSAR4F4CY1802	V8-T10-6
CSAR4F4CY1805	V8-T10-6
CSAR4F4CY1810	V8-T10-6
CSAR4F4CY2202	V8-T10-6
CSAR4F4CY2205	V8-T10-6
CSAR4F4CY2210	V8-T10-6
CSAR4F4RY2202	V8-T10-6
CSAR4F4RY2205	V8-T10-6
CSAR4F4RY2210	V8-T10-6
CSAS3F3CY1802	V8-T10-5
CSAS3F3CY1805	V8-T10-5
CSAS3F3CY1810	V8-T10-5
CSAS3F3CY2202	V8-T3-14, V8-T3-23, V8-T3-31, V8-T3-40, V8-T3-52, V8-T3-55, V8-T3-68, V8-T4-8, V8-T4-11, V8-T5-62, V8-T5-88, V8-T10-5
CSAS3F3CY2205	V8-T3-68, V8-T10-5
CSAS3F3CY2210	V8-T3-68, V8-T10-5
CSAS3F3RY2202	V8-T3-14, V8-T3-23, V8-T3-31, V8-T3-40, V8-T3-52, V8-T3-55, V8-T3-68, V8-T5-62, V8-T5-88, V8-T10-5
CSAS3F3RY2205	V8-T3-68, V8-T10-5
CSAS3F3RY2210	V8-T3-68, V8-T10-5
CSAS4A4CY2202	V8-T10-5
CSAS4A4CY2205	V8-T10-5
CSAS4A4CY2210	V8-T10-5
CSAS4F4CY1802	V8-T10-5
CSAS4F4CY1805	V8-T10-5
CSAS4F4CY1810	V8-T10-5
CSAS4F4CY2202	V8-T5-19, V8-T5-51, V8-T5-62, V8-T5-72, V8-T5-88, V8-T5-94, V8-T10-5
CSAS4F4CY2205	V8-T10-5
CSAS4F4CY2210	V8-T10-5

Appendix 3

Catalog Number Index

CSAS4F4IO2202	V8-T5-19, V8-T5-51, V8-T5-62, V8-T5-72, V8-T5-88, V8-T5-94	CSDS4A4RY2202	V8-T3-14, V8-T3-23, V8-T3-31, V8-T3-47, V8-T3-55, V8-T3-63, V8-T3-68, V8-T3-75, V8-T5-19, V8-T5-38, V8-T5-51, V8-T5-62, V8-T5-72, V8-T5-80, V8-T5-88, V8-T5-94, V8-T10-5
CSAS4F4RY2202	V8-T5-19, V8-T5-51, V8-T5-62, V8-T5-72, V8-T5-88, V8-T5-94, V8-T10-5	CSDS4A4RY2205	V8-T3-68, V8-T5-38, V8-T10-5
CSAS4F4RY2205	V8-T10-5	CSDS4A4RY2210	V8-T3-68, V8-T3-75, V8-T5-38, V8-T10-5
CSAS4F4RY2210	V8-T10-5	CSDS5A5CMR.5	V8-T10-9
CSAS5A5CY2202	V8-T5-19, V8-T10-5	CSDS5A5CY2201-D	V8-T10-8
CSAS5A5CY2205	V8-T10-5	CSDS5A5CY2202	V8-T2-62, V8-T5-38, V8-T10-5
CSAS5A5CY2210	V8-T10-5	CSDS5A5CY2203-D	V8-T10-8
CSDR4	V8-T10-9	CSDS5A5CY2205	V8-T5-38, V8-T10-5
CSDR4A3CY2202	V8-T10-6	CSDS5A5CY2205-D	V8-T10-8
CSDR4A3CY2205	V8-T10-6	CSDS5A5CY2210	V8-T5-38, V8-T10-5
CSDR4A3CY2210	V8-T10-6	CSDS8A8CB2402	V8-T5-38
CSDR4A3RY2202	V8-T10-6	CSDS8A8CB2405	V8-T5-38, V8-T10-5
CSDR4A3RY2205	V8-T10-6	CSDS8A8CB2410	V8-T5-38, V8-T10-5
CSDR4A3RY2210	V8-T10-6	CSDSM4	V8-T10-9
CSDR4A4CY2201.5-D	V8-T10-8	CSDY3	V8-T10-9
CSDR4A4CY2201-D	V8-T10-8	CSDY5	V8-T10-9
CSDR4A4CY2202	V8-T10-6	CSMS2D2CY1602	V8-T10-6
CSDR4A4CY2202-D	V8-T10-8	CSMS2D2CY1604	V8-T10-6
CSDR4A4CY2203-D	V8-T10-8	CSMS3F3CY1602	V8-T3-14, V8-T3-52, V8-T3-68, V8-T3-88, V8-T3-93, V8-T5-62, V8-T5-88, V8-T5-103, V8-T10-6
CSDR4A4CY2205	V8-T10-6	CSMS3F3CY1602-DP	V8-T10-8
CSDR4A4CY2205-D	V8-T10-8	CSMS3F3CY1604	V8-T3-68, V8-T10-6
CSDR4A4CY2210	V8-T10-6	CSMS3F3CY1604-DP	V8-T10-8
CSDR4A4RY2202	V8-T10-6	CSMS3F3CY1607-DP	V8-T10-8
CSDR4A4RY2205	V8-T10-6	CSMS4A4CMR16.5	V8-T10-9
CSDR4A4RY2210	V8-T10-6	CSMS4A4CY1602	V8-T3-68, V8-T3-75, V8-T3-88, V8-T3-93, V8-T5-19, V8-T10-7
CSDR5A5CY2202	V8-T10-6	CSMS4A4CY1604	V8-T3-68, V8-T3-75, V8-T10-7
CSDR5A5CY2205	V8-T10-6	CSMS4A4CY1606	V8-T3-68, V8-T3-75, V8-T10-7
CSDR5A5CY2210	V8-T10-6	CSMS4F4CY1602	V8-T10-6
CSDRM4	V8-T10-9	CSMS4F4CY1604	V8-T10-6
CSDS4	V8-T10-9	CSMS5A5CY1602	V8-T3-93, V8-T5-19, V8-T10-7
CSDS4A3CY2202	V8-T3-40, V8-T3-47, V8-T3-52, V8-T3-63, V8-T4-8, V8-T4-11, V8-T10-5	CSMS5A5CY1604	V8-T10-7
CSDS4A3CY2205	V8-T10-5	CSMS5A5CY1606	V8-T10-7
CSDS4A3CY2210	V8-T10-5	CSMS5D5CY1602	V8-T2-62, V8-T2-74, V8-T3-88, V8-T5-103, V8-T10-7
CSDS4A3RY2202	V8-T3-40, V8-T3-47, V8-T3-52, V8-T3-63, V8-T10-5	CSMS5D5CY1604	V8-T10-7
CSDS4A3RY2205	V8-T10-5	CSMS9D9CY1602	V8-T2-62, V8-T2-74, V8-T10-7
CSDS4A3RY2210	V8-T10-5	CSNR3A3CY2402	V8-T10-7
CSDS4A4CMR22.3	V8-T10-9	CSNR3A3CY2405	V8-T10-7
CSDS4A4CY2201.5-D	V8-T10-8	CSNR3A3CY2410	V8-T10-7
CSDS4A4CY2201-D	V8-T10-8	CSNR3A3RY2402	V8-T10-7
CSDS4A4CY2202	V8-T3-31, V8-T3-47, V8-T3-55, V8-T3-63, V8-T3-68, V8-T3-75, V8-T4-8, V8-T4-11, V8-T5-19, V8-T5-38, V8-T5-51, V8-T5-62, V8-T5-72, V8-T5-80, V8-T5-88, V8-T5-94, V8-T10-5	CSNR3A3RY2405	V8-T10-7
CSDS4A4CY2202-D	V8-T10-8	CSNR3A3RY2410	V8-T10-7
CSDS4A4CY2203-D	V8-T10-8	CSNR4	V8-T10-9
CSDS4A4CY2205	V8-T3-68, V8-T3-75, V8-T5-38, V8-T10-5	CSNR4A4CY2402	V8-T5-29
CSDS4A4CY2205-D	V8-T10-8	CSNR4A4CY2410	V8-T5-29
CSDS4A4CY2210	V8-T3-68, V8-T3-75, V8-T5-38, V8-T10-5	CSNRM4	V8-T10-9
CSDS4A4CY2220	V8-T10-5	CSNS3	V8-T10-9
CSDS4A4IO2202	V8-T5-19, V8-T5-38, V8-T5-51, V8-T5-62, V8-T5-72, V8-T5-80, V8-T5-88, V8-T5-94	CSNS3A3CY2402	V8-T3-40, V8-T3-63, V8-T3-79, V8-T10-7
CSDS4A4IO2205	V8-T5-38	CSNS3A3CY2405	V8-T10-7
CSDS4A4IO2210	V8-T5-38	CSNS3A3CY2410	V8-T10-7
		CSNS3A3RY2402	V8-T3-40, V8-T3-63, V8-T3-79, V8-T10-7
		CSNS3A3RY2405	V8-T10-7

CSNS3A3RY2410	V8-T10-7	E47BMS04	V8-T2-7
CSNS4	V8-T10-9	E47BMS10	V8-T2-8
CSNS4A4CY2402	V8-T5-29, V8-T10-7	E47BMS11	V8-T2-8
CSNS4A4CY2405	V8-T5-29, V8-T10-7	E47BMS20	V8-T2-7
CSNS4A4CY2410	V8-T5-29, V8-T10-7	E47BMS21	V8-T2-7
CSNSM3	V8-T10-9	E47BMS22	V8-T2-7
CSNSM4	V8-T10-9	E47BMS23	V8-T2-8
		E47BMS30	V8-T2-8
E		E47BMS31	V8-T2-8
E47BCC05	V8-T2-16	E47BMS40	V8-T2-9
E47BCC05P4	V8-T2-16	E47BMS41	V8-T2-8
E47BCC06	V8-T2-16	E47BMS42	V8-T2-8
E47BCC06P4	V8-T2-16	E47BMS43	V8-T2-9
E47BCC07	V8-T2-16	E47BMT04	V8-T2-7
E47BCC07P4	V8-T2-16	E47BMT21	V8-T2-7
E47BCC08	V8-T2-16	E47BMT30	V8-T2-8
E47BCC08P4	V8-T2-16	E47CLS05	V8-T2-9
E47BCC11	V8-T2-16	E47CLS06	V8-T2-9
E47BCC11P4	V8-T2-16	E47CLS32	V8-T2-9
E47BCC12	V8-T2-16	E47CML01	V8-T2-7
E47BCC12P4	V8-T2-16	E47CML02	V8-T2-7
E47BCC13	V8-T2-16	E47CML04	V8-T2-7
E47BCC13P4	V8-T2-16	E47CMS01	V8-T2-7
E47BCC15	V8-T2-17	E47CMS02	V8-T2-7
E47BCC15P4	V8-T2-17	E47CMS04	V8-T2-7
E47BCC20	V8-T2-17	E47CMS10	V8-T2-8
E47BCC20P4	V8-T2-17	E47CMS11	V8-T2-8
E47BCC21P4	V8-T2-17	E47CMS22	V8-T2-7
E47BCC22	V8-T2-17	E47CMS23	V8-T2-8
E47BCC22P4	V8-T2-17	E47CMS30	V8-T2-8
E47BLS05	V8-T2-9	E47CMS42	V8-T2-8
E47BLS06	V8-T2-9	E47CMT30	V8-T2-8
E47BLS07	V8-T2-9	E47PA1	V8-T2-10
E47BLS08	V8-T2-9	E47PA2	V8-T2-10
E47BLS11	V8-T2-9	E49G31AP3	V8-T2-44
E47BLS12	V8-T2-9	E49G31BP3	V8-T2-44
E47BLS14	V8-T2-10	E49G31C1P3	V8-T2-44
E47BLS32	V8-T2-9	E49G31CP3	V8-T2-44
E47BLS33	V8-T2-9	E49G31DP3	V8-T2-44
E47BLS34	V8-T2-10	E49G31MP3	V8-T2-45
E47BLS35	V8-T2-10	E49G31NP3	V8-T2-45
E47BML01	V8-T2-7	E49G31UP3	V8-T2-44
E47BML02	V8-T2-7	E49G31VP3	V8-T2-45
E47BML03	V8-T2-7	E49G31XM3	V8-T2-45
E47BML04	V8-T2-7	E49M11AP1	V8-T2-50
E47BML10	V8-T2-8	E49M11BP1	V8-T2-50
E47BML11	V8-T2-8	E49M11BP2	V8-T2-50
E47BML20	V8-T2-7	E49M11CP2	V8-T2-50
E47BML21	V8-T2-7	E49M11DP1	V8-T2-50
E47BML22	V8-T2-7	E49M11UP1	V8-T2-51
E47BML23	V8-T2-8	E49M11VP1	V8-T2-51
E47BML30	V8-T2-8	E49M11XM1	V8-T2-51
E47BML31	V8-T2-8	E50AH1	V8-T2-56
E47BML40	V8-T2-9	E50AH16P	V8-T2-70
E47BML41	V8-T2-8	E50AL1	V8-T2-55
E47BML42	V8-T2-8	E50AL16P	V8-T2-69
E47BML43	V8-T2-9	E50ALH1	V8-T2-56
E47BMS01	V8-T2-7	E50ALH16P	V8-T2-70
E47BMS02	V8-T2-7	E50ALL1	V8-T2-55
E47BMS03	V8-T2-7	E50ALL16P	V8-T2-69

Appendix 3

Catalog Number Index

E50ALM1	V8-T2-55	E50AW16P	V8-T2-71
E50ALM16P	V8-T2-69	E50AW2	V8-T2-57
E50ALR1	V8-T2-55	E50AW26P	V8-T2-71
E50ALR16P	V8-T2-69	E50BH1	V8-T2-56
E50ALS1	V8-T2-55	E50BH16P	V8-T2-70
E50ALS16P	V8-T2-69	E50BL1	V8-T2-55
E50ALS2	V8-T2-55	E50BL16P	V8-T2-69
E50ALS26P	V8-T2-69	E50BLH1	V8-T2-56
E50ALS3	V8-T2-56	E50BLH16P	V8-T2-70
E50ALS36P	V8-T2-70	E50BLL1	V8-T2-55
E50ALT1	V8-T2-56	E50BLL16P	V8-T2-69
E50ALT16P	V8-T2-70	E50BLM1	V8-T2-55
E50ALT26P	V8-T2-70	E50BLM16P	V8-T2-69
E50ALT3	V8-T2-57	E50BLR1	V8-T2-55
E50ALT36P	V8-T2-71	E50BLR16P	V8-T2-69
E50ALW1	V8-T2-57	E50BLS1	V8-T2-55
E50ALW16P	V8-T2-71	E50BLS16P	V8-T2-69
E50ALW2	V8-T2-57	E50BLS2	V8-T2-55
E50ALW26P	V8-T2-71	E50BLS26P	V8-T2-69
E50AM1	V8-T2-55	E50BLS3	V8-T2-56
E50AM16P	V8-T2-69	E50BLS36P	V8-T2-70
E50ANH1	V8-T2-56	E50BLT1	V8-T2-56
E50ANH16P	V8-T2-70	E50BLT16P	V8-T2-70
E50ANL1	V8-T2-55	E50BLT2	V8-T2-56
E50ANL16P	V8-T2-69	E50BLT26P	V8-T2-70
E50ANM1	V8-T2-55	E50BLT3	V8-T2-57
E50ANM16P	V8-T2-69	E50BLT36P	V8-T2-71
E50ANR1	V8-T2-55	E50BLW1	V8-T2-57
E50ANR16P	V8-T2-69	E50BLW16P	V8-T2-71
E50ANS1	V8-T2-55	E50BLW2	V8-T2-57
E50ANS16P	V8-T2-69	E50BLW26P	V8-T2-71
E50ANS2	V8-T2-55	E50BM1	V8-T2-55
E50ANS26P	V8-T2-69	E50BM16P	V8-T2-69
E50ANS3	V8-T2-56	E50BNH1	V8-T2-56
E50ANS36P	V8-T2-70	E50BNH16P	V8-T2-70
E50ANT1	V8-T2-56	E50BNL1	V8-T2-55
E50ANT16P	V8-T2-70	E50BNL16P	V8-T2-69
E50ANT2	V8-T2-56	E50BNM1	V8-T2-55
E50ANT26P	V8-T2-70	E50BNM16P	V8-T2-69
E50ANT3	V8-T2-57	E50BNR1	V8-T2-55
E50ANT36P	V8-T2-71	E50BNR16P	V8-T2-69
E50ANW1	V8-T2-57	E50BNS1	V8-T2-55
E50ANW16P	V8-T2-71	E50BNS16P	V8-T2-69
E50ANW2	V8-T2-57	E50BNS2	V8-T2-55
E50ANW26P	V8-T2-71	E50BNS26P	V8-T2-69
E50AR1	V8-T2-55	E50BNS3	V8-T2-56
E50AR16P	V8-T2-69	E50BNS36P	V8-T2-70
E50AS1	V8-T2-55	E50BNT1	V8-T2-56
E50AS16P	V8-T2-69	E50BNT16P	V8-T2-70
E50AS2	V8-T2-55	E50BNT2	V8-T2-56
E50AS26P	V8-T2-69	E50BNT26P	V8-T2-70
E50AS3	V8-T2-56	E50BNT3	V8-T2-57
E50AS36P	V8-T2-70	E50BNT36P	V8-T2-71
E50AT1	V8-T2-56	E50BNW1	V8-T2-57
E50AT16P	V8-T2-70	E50BNW16P	V8-T2-71
E50AT2	V8-T2-56	E50BNW2	V8-T2-57
E50AT26P	V8-T2-70	E50BNW26P	V8-T2-71
E50AT3	V8-T2-57	E50BR1	V8-T2-55
E50AT36P	V8-T2-71	E50BR16P	V8-T2-69
E50AW1	V8-T2-57	E50BS1	V8-T2-55

E50BS16P	V8-T2-69	E50KL28	V8-T2-81
E50BS2	V8-T2-55	E50KL29	V8-T2-81
E50BS26P	V8-T2-69	E50KL30	V8-T2-81
E50BS3	V8-T2-56	E50KL31	V8-T2-82, V8-T2-86
E50BS36P	V8-T2-70	E50KL310	V8-T2-81
E50BT1	V8-T2-56	E50KL32	V8-T2-81
E50BT16P	V8-T2-70	E50KL33	V8-T2-83
E50BT26P	V8-T2-70	E50KL340	V8-T2-82
E50BT3	V8-T2-57	E50KL35	V8-T2-83
E50BT36P	V8-T2-71	E50KL355	V8-T2-81
E50BW1	V8-T2-57	E50KL36	V8-T2-83
E50BW16P	V8-T2-71	E50KL37	V8-T2-83
E50BW2	V8-T2-57	E50KL377	V8-T2-81
E50BW26P	V8-T2-71	E50KL39	V8-T2-81
E50CLS1	V8-T2-55	E50KL399	V8-T2-83, V8-T2-87
E50CLT1	V8-T2-56	E50KL40	V8-T2-81
E50CLW2	V8-T2-57	E50KL41	V8-T2-83
E50CNS2	V8-T2-55	E50KL421	V8-T2-83
E50DD1	V8-T2-58	E50KL443	V8-T2-82, V8-T2-86
E50DG1	V8-T2-58	E50KL465	V8-T2-82
E50DH1	V8-T2-59, V8-T2-72	E50KL531	V8-T2-81
E50DL1	V8-T2-59, V8-T2-72	E50KL532	V8-T2-82
E50DM1	V8-T2-59, V8-T2-72	E50KL533	V8-T2-83
E50DN1	V8-T2-58	E50KL535	V8-T2-82
E50DN2	V8-T2-58	E50KL536	V8-T2-81
E50DR1	V8-T2-59, V8-T2-72	E50KL537	V8-T2-82, V8-T2-86
E50DR19	V8-T2-59, V8-T2-72	E50KL538	V8-T2-82, V8-T2-86
E50DS1	V8-T2-59, V8-T2-72	E50KL539	V8-T2-82, V8-T2-86
E50DS2	V8-T2-59, V8-T2-72	E50KL541	V8-T2-82
E50DS3	V8-T2-59, V8-T2-72	E50KL542	V8-T2-82
E50DS4	V8-T2-59, V8-T2-72	E50KL543	V8-T2-82
E50DT1	V8-T2-59, V8-T2-72	E50KL544	V8-T2-82
E50DT2	V8-T2-59, V8-T2-72	E50KL545	V8-T2-82
E50DT3	V8-T2-60, V8-T2-73	E50KL546	V8-T2-81
E50DW1	V8-T2-60, V8-T2-73	E50KL547	V8-T2-81
E50DW2	V8-T2-60, V8-T2-73	E50KL548	V8-T2-81
E50GG1	V8-T2-58	E50KL549	V8-T2-81
E50GLG1	V8-T2-58	E50KL550	V8-T2-81
E50GNG1	V8-T2-58	E50KL551	V8-T2-81
E50KH10	V8-T2-63, V8-T2-75	E50KL552	V8-T2-81
E50KH1M	V8-T2-62, V8-T2-74	E50KL553	V8-T2-81
E50KH2	V8-T2-63, V8-T2-75	E50KL554	V8-T2-81
E50KH3	V8-T2-63, V8-T2-75, V8-T3-88, V8-T3-94, V8-T5-103	E50KL556	V8-T2-83
E50KH4	V8-T2-63, V8-T2-75	E50KL572	V8-T2-81
E50KH5	V8-T2-63, V8-T2-75	E50KL573	V8-T2-81
E50KH6	V8-T2-63, V8-T2-75	E50KL574	V8-T2-81
E50KH7	V8-T2-62, V8-T2-74	E50KL575	V8-T2-81
E50KL142	V8-T2-83	E50KL576	V8-T2-81
E50KL200	V8-T2-81	E50KL579	V8-T2-81
E50KL201	V8-T2-82, V8-T2-86	E50KL580	V8-T2-81
E50KL201SPL	V8-T2-82, V8-T2-86	E50KL581	V8-T2-83, V8-T2-87
E50KL202	V8-T2-83, V8-T2-87	E50KL598	V8-T2-82, V8-T2-86
E50KL203	V8-T2-82	E50KL599	V8-T2-82, V8-T2-86
E50KL204	V8-T2-82	E50KW2	V8-T2-84
E50KL226	V8-T2-83, V8-T2-87	E50KW3	V8-T2-84
E50KL24	V8-T2-81	E50KW4	V8-T2-84
E50KL25	V8-T2-81	E50NN1	V8-T2-58
E50KL26	V8-T2-81	E50NN1SPL	V8-T2-58
E50KL27	V8-T2-81	E50NN2	V8-T2-58
		E50RA	V8-T2-58, V8-T2-61

Appendix 3

Catalog Number Index

E50RA20	V8-T2-61	E51ALP1	V8-T5-98
E50RA20S	V8-T2-61	E51ALP2	V8-T5-98
E50RA20S12	V8-T2-61	E51ALS1	V8-T3-84
E50RA20S20	V8-T2-61	E51ALS16PU	V8-T3-93
E50RAA5	V8-T2-61	E51ALS26P	V8-T3-85
E50RAM	V8-T2-61	E51ALS26PU	V8-T3-93
E50RAP5	V8-T2-61	E51ALS5	V8-T3-84
E50RAP5-W	V8-T2-61	E51ALS56P	V8-T3-85
E50RAS	V8-T2-61	E51ALS56PU	V8-T3-93
E50RAS12	V8-T2-61	E51ALS6	V8-T3-84
E50RAS20	V8-T2-61	E51ALS66P	V8-T3-85
E50RB	V8-T2-58, V8-T2-61	E51ALS66PU	V8-T3-93
E50RB20	V8-T2-61	E51ALT1	V8-T3-84
E50RB20S	V8-T2-61	E51ALT16PU	V8-T3-93
E50RB20S12	V8-T2-61	E51ALT2	V8-T3-84
E50RB20S20	V8-T2-61	E51ALT26P	V8-T3-85
E50RB34	V8-T2-61	E51ALT26PU	V8-T3-93
E50RBM	V8-T2-61	E51ALT5	V8-T3-84
E50RBP9	V8-T2-61	E51ALT56P	V8-T3-85
E50RBS	V8-T2-61	E51ALT56PU	V8-T3-93
E50RBS12	V8-T2-61	E51ALT6	V8-T3-84
E50RBS20	V8-T2-61	E51ALT66P	V8-T3-85
E50SA	V8-T2-60	E51ALT66PU	V8-T3-93
E50SA6P	V8-T2-73	E51BLS16PU	V8-T3-93
E50SA6P12	V8-T2-73	E51BLS26PU	V8-T3-93
E50SA6P20	V8-T2-73	E51BLS56PU	V8-T3-93
E50SA6PC	V8-T2-73	E51BLS66PU	V8-T3-93
E50SA6PC-W	V8-T2-73	E51BLT16PU	V8-T3-93
E50SAL	V8-T2-60	E51BLT26PU	V8-T3-93
E50SAL6P	V8-T2-73	E51BLT56PU	V8-T3-93
E50SAL6P12	V8-T2-73	E51BLT66PU	V8-T3-93
E50SAL6P20	V8-T2-73	E51CLC1	V8-T5-98
E50SAL6PC	V8-T2-73	E51CLF1	V8-T5-99
E50SAN	V8-T2-60	E51CLF11	V8-T5-99
E50SAN6P	V8-T2-73	E51CLF3	V8-T5-99
E50SAN6P12	V8-T2-73	E51CLF33	V8-T5-99
E50SAN6P20	V8-T2-73	E51CLP1	V8-T5-98
E50SAN6PC	V8-T2-73	E51CLP2	V8-T5-98
E50SB	V8-T2-60	E51CLP22	V8-T5-98
E50SB6P	V8-T2-73	E51CLP3	V8-T5-98
E50SB6P12	V8-T2-73	E51CLP4	V8-T5-98
E50SB6P20	V8-T2-73	E51CLP5	V8-T5-98
E50SB6PC	V8-T2-73	E51CLP6	V8-T5-98
E50SBL	V8-T2-60	E51CLS1	V8-T3-84
E50SBL6P	V8-T2-73	E51CLS16P	V8-T3-85
E50SBL6P12	V8-T2-73	E51CLS16PU	V8-T3-93
E50SBL6PC	V8-T2-73	E51CLS2	V8-T3-84
E50SBN	V8-T2-60	E51CLS26P	V8-T3-85
E50SBN6P	V8-T2-73	E51CLS26PU	V8-T3-93
E50SBN6P12	V8-T2-73	E51CLS56P	V8-T3-85
E50SBN6P20	V8-T2-73	E51CLS56PU	V8-T3-93
E50SBN6PC	V8-T2-73	E51CLS6	V8-T3-84
E50SCL	V8-T2-60	E51CLS66P	V8-T3-85
E50SG	V8-T2-58	E51CLS66PU	V8-T3-93
E50SGL	V8-T2-58	E51CLT1	V8-T3-84
E50SGN	V8-T2-58	E51CLT16P	V8-T3-85
E50SN	V8-T2-58	E51CLT16PU	V8-T3-93
E50ST	V8-T2-58	E51CLT2	V8-T3-84
E50TD1	V8-T2-58	E51CLT26P	V8-T3-85
E51ALC1	V8-T5-98	E51CLT26PU	V8-T3-93

E51CLT5	V8-T3-84	E51KE713	V8-T5-20
E51CLT56P	V8-T3-85	E51KE723	V8-T5-20
E51CLT56PU	V8-T3-93	E51KE733	V8-T5-20
E51CLT6	V8-T3-84	E51KE7A3	V8-T5-20
E51CLT66PU	V8-T3-93	E51KE7B3	V8-T5-20
E51CNC1	V8-T5-98	E51KE813	V8-T5-20
E51CNF1	V8-T5-99	E51KE823	V8-T5-20
E51CNF11	V8-T5-99	E51KE833	V8-T5-20
E51CNF3	V8-T5-99	E51KE8A3	V8-T5-20
E51CNF33	V8-T5-99	E51KE8B3	V8-T5-20
E51CNP1	V8-T5-98	E51KF143	V8-T9-9
E51CNP2	V8-T5-98	E51KF153	V8-T9-9
E51CNP22	V8-T5-98	E51KF163	V8-T9-9
E51CNP3	V8-T5-98	E51KF173	V8-T9-9
E51CNP4	V8-T5-98	E51KF183	V8-T9-9
E51CNP5	V8-T5-98	E51KF193	V8-T9-9
E51CNP6	V8-T5-98	E51KF243	V8-T9-10
E51CNS1	V8-T3-84	E51KF253	V8-T9-10
E51CNS2	V8-T3-84	E51KF263	V8-T9-10
E51CNS5	V8-T3-84	E51KF273	V8-T9-10
E51CNS6	V8-T3-84	E51KF283	V8-T9-10
E51CNT1	V8-T3-84	E51KF293	V8-T9-10
E51CNT6	V8-T3-84	E51KF313	V8-T9-9
E51DC1	V8-T5-98, V8-T5-100	E51KF323	V8-T9-9
E51DED	V8-T5-98, V8-T5-100	E51KF333	V8-T9-9
E51DEL	V8-T5-98, V8-T5-100	E51KF343	V8-T9-9
E51DF1	V8-T5-99, V8-T5-101	E51KF3A3	V8-T9-9
E51DF11	V8-T5-99, V8-T5-101	E51KF3B3	V8-T9-9
E51DF3	V8-T5-99, V8-T5-101	E51KF413	V8-T9-10
E51DF33	V8-T5-99, V8-T5-101	E51KF423	V8-T9-10
E51DF4	V8-T5-101	E51KF433	V8-T9-10
E51DP1	V8-T5-98, V8-T5-100	E51KF443	V8-T9-10
E51DP2	V8-T5-98, V8-T5-100	E51KF4A3	V8-T9-10
E51DP22	V8-T5-98, V8-T5-100	E51KF4B3	V8-T9-10
E51DP3	V8-T5-98, V8-T5-100	E51KF543	V8-T9-9
E51DP4	V8-T5-98, V8-T5-100	E51KF553	V8-T9-9
E51DP5	V8-T5-98, V8-T5-100	E51KF563	V8-T9-9
E51DP6	V8-T5-98, V8-T5-100	E51KF573	V8-T9-9
E51DS1	V8-T3-84, V8-T3-85	E51KF583	V8-T9-9
E51DS2	V8-T3-84, V8-T3-85	E51KF593	V8-T9-9
E51DS5	V8-T3-84, V8-T3-85	E51KF643	V8-T9-10
E51DS6	V8-T3-84, V8-T3-85	E51KF653	V8-T9-10
E51DT1	V8-T3-84, V8-T3-85	E51KF663	V8-T9-10
E51DT2	V8-T3-84, V8-T3-85	E51KF673	V8-T9-10
E51DT5	V8-T3-84, V8-T3-85	E51KF683	V8-T9-10
E51DT6	V8-T3-84, V8-T3-85	E51KF693	V8-T9-10
E51EDN	V8-T5-98	E51KF713	V8-T9-9
E51EDN 6	V8-T5-98	E51KF723	V8-T9-9
E51ELA	V8-T5-98	E51KF733	V8-T9-9
E51ELA 5	V8-T5-98	E51KF743	V8-T9-9
E51KE313	V8-T5-20	E51KF7A3	V8-T9-9
E51KE323	V8-T5-20	E51KF7B3	V8-T9-9
E51KE333	V8-T5-20	E51KF813	V8-T9-10
E51KE3A3	V8-T5-20	E51KF823	V8-T9-10
E51KE3B3	V8-T5-20	E51KF833	V8-T9-10
E51KE413	V8-T5-20	E51KF843	V8-T9-10
E51KE423	V8-T5-20	E51KF8A3	V8-T9-10
E51KE433	V8-T5-20	E51KF8B3	V8-T9-10
E51KE4A3	V8-T5-20	E51KFH1	V8-T9-11
E51KE4B3	V8-T5-20	E51KFH2	V8-T9-11

Appendix 3

Catalog Number Index

E51KFH3	V8-T9-11	E51NLS56P	V8-T3-85
E51KH2	V8-T3-88, V8-T3-94, V8-T5-103	E51NLS56PU	V8-T3-93
E51KH3	V8-T3-88, V8-T3-94, V8-T5-103	E51NLS6	V8-T3-84
E51KH4	V8-T3-88, V8-T3-94, V8-T5-103	E51NLS66P	V8-T3-85
E51KR32	V8-T8-3	E51NLS66PU	V8-T3-93
E51KR84	V8-T8-3	E51NLT16P	V8-T3-85
E51KRM	V8-T3-88, V8-T5-103	E51NLT16PU	V8-T3-93
E51KT153	V8-T9-9	E51NLT2	V8-T3-84
E51KT163	V8-T9-9	E51NLT26PU	V8-T3-93
E51KT173	V8-T9-9	E51NLT5	V8-T3-84
E51KT183	V8-T9-9	E51NLT56P	V8-T3-85
E51KT193	V8-T9-9	E51NLT56PU	V8-T3-93
E51KT253	V8-T9-10	E51NLT6	V8-T3-84
E51KT263	V8-T9-10	E51NLT66P	V8-T3-85
E51KT273	V8-T9-10	E51NLT66PU	V8-T3-93
E51KT283	V8-T9-10	E51PLC1	V8-T5-98
E51KT293	V8-T9-10	E51PLF1	V8-T5-99
E51KT313	V8-T9-9	E51PLF11	V8-T5-99
E51KT323	V8-T9-9	E51PLF3	V8-T5-99
E51KT333	V8-T9-9	E51PLF33	V8-T5-99
E51KT343	V8-T9-9	E51PLP1	V8-T5-98
E51KT413	V8-T9-10	E51PLP2	V8-T5-98
E51KT423	V8-T9-10	E51PLP22	V8-T5-98
E51KT433	V8-T9-10	E51PLP3	V8-T5-98
E51KT443	V8-T9-10	E51PLP4	V8-T5-98
E51KT563	V8-T9-9	E51PLP5	V8-T5-98
E51KT573	V8-T9-9	E51PLP6	V8-T5-98
E51KT583	V8-T9-9	E51PLS1	V8-T3-84
E51KT593	V8-T9-9	E51PLS16PU	V8-T3-93
E51KT663	V8-T9-10	E51PLS2	V8-T3-84
E51KT673	V8-T9-10	E51PLS26P	V8-T3-85
E51KT683	V8-T9-10	E51PLS26PU	V8-T3-93
E51KT693	V8-T9-10	E51PLS5	V8-T3-84
E51KT713	V8-T9-9	E51PLS56P	V8-T3-85
E51KT723	V8-T9-9	E51PLS6	V8-T3-84
E51KT733	V8-T9-9	E51PLS66P	V8-T3-85
E51KT813	V8-T9-10	E51PLS66PU	V8-T3-93
E51KT823	V8-T9-10	E51PLT1	V8-T3-84
E51KT833	V8-T9-10	E51PLT16P	V8-T3-85
E51KT8A3	V8-T9-10	E51PLT16PU	V8-T3-93
E51KT8B3	V8-T9-10	E51PLT2	V8-T3-84
E51MTB	V8-T3-86, V8-T5-102	E51PLT26P	V8-T3-85
E51NLC1	V8-T5-98	E51PLT26PU	V8-T3-93
E51NLF1	V8-T5-99	E51PLT5	V8-T3-84
E51NLF11	V8-T5-99	E51PLT56P	V8-T3-85
E51NLF3	V8-T5-99	E51PLT56PU	V8-T3-93
E51NLF33	V8-T5-99	E51PLT66P	V8-T3-85
E51NLP1	V8-T5-98	E51RA	V8-T3-87, V8-T5-102
E51NLP2	V8-T5-98	E51RA20	V8-T3-87, V8-T5-102
E51NLP22	V8-T5-98	E51RA20S	V8-T3-87, V8-T5-102
E51NLP3	V8-T5-98	E51RAP3	V8-T3-87, V8-T5-102
E51NLP4	V8-T5-98	E51RAPT3	V8-T3-87, V8-T5-102
E51NLP5	V8-T5-98	E51RAS	V8-T3-87, V8-T5-102
E51NLP6	V8-T5-98	E51RAS12	V8-T3-87, V8-T5-102
E51NLS1	V8-T3-84	E51RAS20	V8-T3-87, V8-T5-102
E51NLS16P	V8-T3-85	E51RC	V8-T3-87, V8-T5-102
E51NLS16PU	V8-T3-93	E51RC20	V8-T3-87, V8-T5-102
E51NLS26P	V8-T3-85	E51RC20S	V8-T3-87, V8-T5-102
E51NLS26PU	V8-T3-93	E51RCB	V8-T3-87, V8-T5-102
E51NLS5	V8-T3-84	E51RCB20	V8-T3-87, V8-T5-102

E51RCP5	V8-T3-87, V8-T5-102	E53KAL18T111	V8-T4-7
E51RCPT5	V8-T3-87, V8-T5-102	E53KAL18T111ED	V8-T4-7
E51RCS	V8-T3-87, V8-T5-102	E53KAL18T111SD	V8-T4-7
E51RCS12	V8-T3-87, V8-T5-102	E53KAL30A2	V8-T4-7
E51RCS20	V8-T3-87, V8-T5-102	E53KAL30A2E	V8-T4-7
E51RN	V8-T3-87, V8-T5-102	E53KAL30A2EA	V8-T4-7
E51RN20	V8-T3-87, V8-T5-102	E53KAL30A2SA	V8-T4-7
E51RN20S	V8-T3-87, V8-T5-102	E53KAL30T110	V8-T4-7
E51RNP5	V8-T3-87, V8-T5-102	E53KAL30T111	V8-T4-7
E51RNPT5	V8-T3-87, V8-T5-102	E53KAL30T111ED	V8-T4-7
E51RNS	V8-T3-87, V8-T5-102	E53KAL30T111SD	V8-T4-7
E51RNS12	V8-T3-87, V8-T5-102	E53KAL34A2E	V8-T4-11
E51RNS20	V8-T3-87, V8-T5-102	E53KAL34A2EA	V8-T4-11
E51SAL	V8-T3-86, V8-T5-101	E53KAL34T110	V8-T4-11
E51SCL	V8-T3-86, V8-T5-101	E53KAL34T110E	V8-T4-11
E51SCN	V8-T3-86, V8-T5-101	E53KAL34T110ED	V8-T4-11
E51SNL	V8-T3-86, V8-T5-101	E53KAL34T110SD	V8-T4-11
E51SPL	V8-T3-86, V8-T5-101	E53KAL34T111	V8-T4-11
E52-16QS04-B	V8-T3-79	E53KAL34T111ED	V8-T4-11
E52-16QS04-B1	V8-T3-79	E53KAL34T111SD	V8-T4-11
E52-16QS04-C	V8-T3-79	E53KBL18A2	V8-T4-7
E52-16QS04-C1	V8-T3-79	E53KBL18A2E	V8-T4-7
E52-18RU04-B	V8-T3-79	E53KBL18A2EA	V8-T4-7
E52-18RU04-B1	V8-T3-79	E53KBL18A2SA	V8-T4-7
E52-18RU04-B1N	V8-T3-79	E53KBL18T110	V8-T4-7
E52-18RU04-BN	V8-T3-79	E53KBL18T110E	V8-T4-7
E52-18RU04-C	V8-T3-79	E53KBL18T110ED	V8-T4-7
E52-18RU04-C1	V8-T3-79	E53KBL18T110SD	V8-T4-7
E52-18RU04-CN	V8-T3-79	E53KBL18T111	V8-T4-7
E52-25QS10-B	V8-T3-79	E53KBL18T111E	V8-T4-7
E52-25QS10-B1	V8-T3-79	E53KBL18T111ED	V8-T4-7
E52-25QS10-C	V8-T3-79	E53KBL18T111SD	V8-T4-7
E52-25QS10-C1	V8-T3-79	E53KBL30A2	V8-T4-7
E52Q-DL15SAD01	V8-T3-75	E53KBL30A2E	V8-T4-7
E52Q-DL15SAE01	V8-T3-75	E53KBL30A2EA	V8-T4-7
E52Q-DL15UAD01	V8-T3-75	E53KBL30A2SA	V8-T4-7
E52Q-DL15UAE01	V8-T3-75	E53KBL30T110	V8-T4-7
E52Q-DL20SAD01	V8-T3-75	E53KBL30T110E	V8-T4-7
E52Q-DL20SAE01	V8-T3-75	E53KBL30T110ED	V8-T4-7
E52Q-DL20UAD01	V8-T3-75	E53KBL30T110SD	V8-T4-7
E52Q-DL20UAE01	V8-T3-75	E53KBL30T111	V8-T4-7
E52Q-DL25UAD01	V8-T3-75	E53KBL30T111E	V8-T4-7
E52Q-DL25UAE01	V8-T3-75	E53KBL30T111ED	V8-T4-7
E52Q-DL30UAD01	V8-T3-75	E53KBL30T111SD	V8-T4-7
E52Q-DL30UAE01	V8-T3-75	E53KBL34A2E	V8-T4-11
E52Q-DL35UAD01	V8-T3-75	E53KBL34A2EA	V8-T4-11
E52Q-DL35UAE01	V8-T3-75	E53KBL34T110	V8-T4-11
E52Q-DL40UAD01	V8-T3-75	E53KBL34T110E	V8-T4-11
E52Q-DL40UAE01	V8-T3-75	E53KBL34T110ED	V8-T4-11
E52RAL12T110	V8-T3-79	E53KBL34T110SD	V8-T4-11
E52RAL12T110AF	V8-T3-79	E53KBL34T111	V8-T4-11
E52RAL12T111	V8-T3-79	E53KBL34T111E	V8-T4-11
E52RAL12T111AF	V8-T3-79	E53KBL34T111ED	V8-T4-11
E53KAL18A2	V8-T4-7	E55BLT1C	V8-T3-81
E53KAL18A2E	V8-T4-7	E55BLT1D	V8-T3-81
E53KAL18A2EA	V8-T4-7	E55BLT1E	V8-T3-81
E53KAL18A2SA	V8-T4-7	E55BLT1F	V8-T3-81
E53KAL18T110	V8-T4-7	E55CAL12A2	V8-T3-72
E53KAL18T110ED	V8-T4-7	E55CAL12A2E	V8-T3-72
E53KAL18T110SD	V8-T4-7	E55CAL12T110	V8-T3-72

Appendix 3

Catalog Number Index

E55CAL12T110E	V8-T3-72	E57-08GE03-GNB	V8-T3-38
E55CAL12T111	V8-T3-72	E57-08GE06-C1	V8-T3-38
E55CAL12T111E	V8-T3-72	E57-08GE06-C1DB	V8-T3-38
E55CAL18A2	V8-T3-72	E57-08GE06-CDB	V8-T3-38
E55CAL18A2E	V8-T3-72	E57-08GE06-G	V8-T3-38
E55CAL18T110	V8-T3-72	E57-08GE06-G1	V8-T3-38
E55CAL18T110E	V8-T3-72	E57-08GE06-G1DB	V8-T3-38
E55CAL18T111	V8-T3-72	E57-08GE06-GDB	V8-T3-38
E55CAL18T111E	V8-T3-72	E57-08GS01-C	V8-T3-38
E55CAL30A2	V8-T3-72	E57-08GS01-C1	V8-T3-38
E55CAL30A2E	V8-T3-72	E57-08GS01-C1DB	V8-T3-38
E55CAL30T110	V8-T3-72	E57-08GS01-CDB	V8-T3-38
E55CAL30T110E	V8-T3-72	E57-08GS01-CNB	V8-T3-38
E55CAL30T111	V8-T3-72	E57-08GS01-G	V8-T3-38
E55CAL30T111E	V8-T3-72	E57-08GS01-G1	V8-T3-38
E55CBL12A2	V8-T3-72	E57-08GS01-G1DB	V8-T3-38
E55CBL12A2E	V8-T3-72	E57-08GS01-G1NB	V8-T3-38
E55CBL12T110E	V8-T3-72	E57-08GS01-GDB	V8-T3-38
E55CBL12T111	V8-T3-72	E57-08GS01-GNB	V8-T3-38
E55CBL12T111E	V8-T3-72	E57-08GU02-C	V8-T3-38
E55CBL18A2	V8-T3-72	E57-08GU02-C1	V8-T3-38
E55CBL18A2E	V8-T3-72	E57-08GU02-C1DB	V8-T3-38
E55CBL18T110	V8-T3-72	E57-08GU02-C1NB	V8-T3-38
E55CBL18T110E	V8-T3-72	E57-08GU02-CDB	V8-T3-38
E55CBL18T111	V8-T3-72	E57-08GU02-CNB	V8-T3-38
E55CBL18T111E	V8-T3-72	E57-08GU02-G	V8-T3-38
E55CBL30A2	V8-T3-72	E57-08GU02-G1	V8-T3-38
E55CBL30A2E	V8-T3-72	E57-08GU02-G1DB	V8-T3-38
E55CBL30T110	V8-T3-72	E57-08GU02-G1NB	V8-T3-38
E55CBL30T110E	V8-T3-72	E57-08GU02-GNB	V8-T3-38
E55CBL30T111	V8-T3-72	E57-12GE05-C	V8-T3-38
E55CBL30T111E	V8-T3-72	E57-12GE05-C1	V8-T3-38
E56ADL40SA	V8-T3-67	E57-12GE05-C1DB	V8-T3-38
E56ADL40SAD01	V8-T3-67	E57-12GE05-CDB	V8-T3-38
E56ADL40SAE01	V8-T3-67	E57-12GE05-G	V8-T3-38
E56ADL40UA	V8-T3-67	E57-12GE05-G1	V8-T3-38
E56ADL40UAD01	V8-T3-67	E57-12GE05-G1DB	V8-T3-38
E56ADL50UA	V8-T3-67	E57-12GE05-GDB	V8-T3-38
E56ADL50UAD01	V8-T3-67	E57-12GE08-D	V8-T3-37
E56ADL50UAE01	V8-T3-67	E57-12GE08-D1	V8-T3-37
E56BDL70UAD01	V8-T3-67	E57-12GE08-D1DB	V8-T3-37
E56BDL70UAE01	V8-T3-67	E57-12GE08-DDB	V8-T3-37
E56CAL100B1S1	V8-T3-67	E57-12GE10-C1	V8-T3-38
E56CAL70B1S1	V8-T3-67	E57-12GE10-C1DB	V8-T3-38
E56CDL100UAD01	V8-T3-67	E57-12GE10-CDB	V8-T3-38
E56CDL100UAE01	V8-T3-67	E57-12GE10-G	V8-T3-38
E56CDL40A2	V8-T3-67	E57-12GE10-G1	V8-T3-38
E56CDL40A2B1	V8-T3-67	E57-12GE10-G1DB	V8-T3-38
E56CDL50A2E	V8-T3-67	E57-12GE10-GDB	V8-T3-38
E56CDL50A2EB1	V8-T3-67	E57-12GS02-A	V8-T3-37
E57-08GE03-C	V8-T3-38	E57-12GS02-A1	V8-T3-37
E57-08GE03-C1	V8-T3-38	E57-12GS02-A1AB	V8-T3-37
E57-08GE03-C1DB	V8-T3-38	E57-12GS02-AAB	V8-T3-37
E57-08GE03-C1NB	V8-T3-38	E57-12GS02-C1	V8-T3-38
E57-08GE03-CDB	V8-T3-38	E57-12GS02-C1DB	V8-T3-38
E57-08GE03-CNB	V8-T3-38	E57-12GS02-CDB	V8-T3-38
E57-08GE03-G	V8-T3-38	E57-12GS02-D	V8-T3-37
E57-08GE03-G1	V8-T3-38	E57-12GS02-DDB	V8-T3-37
E57-08GE03-G1DB	V8-T3-38	E57-12GS02-G	V8-T3-38
E57-08GE03-GDB	V8-T3-38	E57-12GS02-G1	V8-T3-38

E57-12GS02-G1DB	V8-T3-38	E57-18GE16-AAB	V8-T3-37
E57-12GS02-GDB	V8-T3-38	E57-18GE16-D	V8-T3-37
E57-12GU04-A	V8-T3-37	E57-18GE16-D1	V8-T3-37
E57-12GU04-A1	V8-T3-37	E57-18GE16-D1DB	V8-T3-37
E57-12GU04-A1AB	V8-T3-37	E57-18GE16-DDB	V8-T3-37
E57-12GU04-AAB	V8-T3-37	E57-18GE18-C	V8-T3-39
E57-12GU04-C	V8-T3-38	E57-18GE18-C1	V8-T3-39
E57-12GU04-C1	V8-T3-38	E57-18GE18-C1DB	V8-T3-39
E57-12GU04-C1DB	V8-T3-38	E57-18GE18-CDB	V8-T3-39
E57-12GU04-CDB	V8-T3-38	E57-18GE18-G	V8-T3-39
E57-12GU04-D	V8-T3-37	E57-18GE18-G1	V8-T3-39
E57-12GU04-D1	V8-T3-37	E57-18GE18-G1DB	V8-T3-39
E57-12GU04-D1DB	V8-T3-37	E57-18GE18-GDB	V8-T3-39
E57-12GU04-DDB	V8-T3-37	E57-18GS05-A	V8-T3-37
E57-12GU04-G	V8-T3-38	E57-18GS05-A1	V8-T3-37
E57-12GU04-G1	V8-T3-38	E57-18GS05-A1AB	V8-T3-37
E57-12GU04-G1DB	V8-T3-38	E57-18GS05-AAB	V8-T3-37
E57-12GU04-GDB	V8-T3-38	E57-18GS05-C	V8-T3-39
E57-12LE06-A	V8-T3-18	E57-18GS05-C1DB	V8-T3-39
E57-12LE06-A1	V8-T3-18	E57-18GS05-CDB	V8-T3-39
E57-12LE06-A1A	V8-T3-18	E57-18GS05-D	V8-T3-37
E57-12LE06-AA	V8-T3-18	E57-18GS05-D1	V8-T3-37
E57-12LE06-AP	V8-T3-18	E57-18GS05-D1DB	V8-T3-37
E57-12LE06-B	V8-T3-20	E57-18GS05-DDB	V8-T3-37
E57-12LE06-B1	V8-T3-20	E57-18GS05-G	V8-T3-39
E57-12LE06-B1D	V8-T3-20	E57-18GS05-G1	V8-T3-39
E57-12LE06-B1P	V8-T3-20	E57-18GS05-GDB	V8-T3-39
E57-12LE06-BD	V8-T3-20	E57-18GU08-A1	V8-T3-37
E57-12LE06-BP	V8-T3-20	E57-18GU08-A1AB	V8-T3-37
E57-12LE06-C	V8-T3-20	E57-18GU08-AAB	V8-T3-37
E57-12LE06-C1	V8-T3-20	E57-18GU08-C	V8-T3-39
E57-12LE06-C1D	V8-T3-20	E57-18GU08-C1	V8-T3-39
E57-12LE06-C1P	V8-T3-20	E57-18GU08-C1DB	V8-T3-39
E57-12LE06-CD	V8-T3-20	E57-18GU08-CDB	V8-T3-39
E57-12LE06-CP	V8-T3-20	E57-18GU08-D	V8-T3-37
E57-12LE10-A	V8-T3-18	E57-18GU08-D1	V8-T3-37
E57-12LE10-A1	V8-T3-18	E57-18GU08-D1DB	V8-T3-37
E57-12LE10-A1A	V8-T3-18	E57-18GU08-DDB	V8-T3-37
E57-12LE10-A1P	V8-T3-18	E57-18GU08-G	V8-T3-39
E57-12LE10-AA	V8-T3-18	E57-18GU08-G1	V8-T3-39
E57-12LE10-AP	V8-T3-18	E57-18GU08-G1DB	V8-T3-39
E57-12LE10-B	V8-T3-20	E57-18GU08-GDB	V8-T3-39
E57-12LE10-B1	V8-T3-20	E57-18LE12-A	V8-T3-18
E57-12LE10-B1D	V8-T3-20	E57-18LE12-A1	V8-T3-18
E57-12LE10-BD	V8-T3-20	E57-18LE12-A1A	V8-T3-18
E57-12LE10-BP	V8-T3-20	E57-18LE12-A1B	V8-T3-18
E57-12LE10-C	V8-T3-20	E57-18LE12-A1P	V8-T3-18
E57-12LE10-C1	V8-T3-20	E57-18LE12-AA	V8-T3-18
E57-12LE10-C1D	V8-T3-20	E57-18LE12-AB	V8-T3-18
E57-12LE10-CD	V8-T3-20	E57-18LE12-AP	V8-T3-18
E57-12LE10-CP	V8-T3-20	E57-18LE12-B	V8-T3-21
E57-18GE08-C	V8-T3-39	E57-18LE12-B1	V8-T3-21
E57-18GE08-C1	V8-T3-39	E57-18LE12-B1B	V8-T3-21
E57-18GE08-C1DB	V8-T3-39	E57-18LE12-B1D	V8-T3-21
E57-18GE08-CDB	V8-T3-39	E57-18LE12-B1P	V8-T3-21
E57-18GE08-G	V8-T3-39	E57-18LE12-BB	V8-T3-21
E57-18GE08-G1	V8-T3-39	E57-18LE12-BD	V8-T3-21
E57-18GE08-G1DB	V8-T3-39	E57-18LE12-BP	V8-T3-21
E57-18GE08-GDB	V8-T3-39	E57-18LE12-C	V8-T3-21
E57-18GE16-A1AB	V8-T3-37	E57-18LE12-C1	V8-T3-21

Appendix 3

Catalog Number Index

E57-18LE12-C1B	V8-T3-21	E57-30GS10-DDB	V8-T3-37
E57-18LE12-C1D	V8-T3-21	E57-30GS10-G	V8-T3-39
E57-18LE12-C1P	V8-T3-21	E57-30GS10-G1	V8-T3-39
E57-18LE12-CB	V8-T3-21	E57-30GS10-G1DB	V8-T3-39
E57-18LE12-CD	V8-T3-21	E57-30GS10-G5	V8-T3-39
E57-18LE12-CP	V8-T3-21	E57-30GS10-GDB	V8-T3-39
E57-18LE20-A	V8-T3-18	E57-30GU15-A	V8-T3-37
E57-18LE20-A1	V8-T3-18	E57-30GU15-A1	V8-T3-37
E57-18LE20-A1A	V8-T3-18	E57-30GU15-A1AB	V8-T3-37
E57-18LE20-A1B	V8-T3-18	E57-30GU15-AAB	V8-T3-37
E57-18LE20-A1P	V8-T3-18	E57-30GU15-C	V8-T3-39
E57-18LE20-AA	V8-T3-18	E57-30GU15-C1	V8-T3-39
E57-18LE20-AB	V8-T3-18	E57-30GU15-C1DB	V8-T3-39
E57-18LE20-AP	V8-T3-18	E57-30GU15-CDB	V8-T3-39
E57-18LE20-B	V8-T3-21	E57-30GU15-D	V8-T3-37
E57-18LE20-B1	V8-T3-21	E57-30GU15-D1	V8-T3-37
E57-18LE20-B1D	V8-T3-21	E57-30GU15-D1DB	V8-T3-37
E57-18LE20-B1P	V8-T3-21	E57-30GU15-DDB	V8-T3-37
E57-18LE20-BB	V8-T3-21	E57-30GU15-G	V8-T3-39
E57-18LE20-BD	V8-T3-21	E57-30GU15-G1	V8-T3-39
E57-18LE20-BP	V8-T3-21	E57-30GU15-G1DB	V8-T3-39
E57-18LE20-C	V8-T3-21	E57-30GU15-GDB	V8-T3-39
E57-18LE20-C1	V8-T3-21	E57-30HS10-K	V8-T3-59
E57-18LE20-C1B	V8-T3-21	E57-30JS10-H	V8-T3-59
E57-18LE20-C1D	V8-T3-21	E57-30LE22-A	V8-T3-19
E57-18LE20-C1P	V8-T3-21	E57-30LE22-A1	V8-T3-19
E57-18LE20-CB	V8-T3-21	E57-30LE22-A1A	V8-T3-19
E57-18LE20-CD	V8-T3-21	E57-30LE22-A1B	V8-T3-19
E57-18LE20-CP	V8-T3-21	E57-30LE22-A1P	V8-T3-19
E57-30GE15-C	V8-T3-39	E57-30LE22-AA	V8-T3-19
E57-30GE15-C1	V8-T3-39	E57-30LE22-AB	V8-T3-19
E57-30GE15-C1DB	V8-T3-39	E57-30LE22-AP	V8-T3-19
E57-30GE15-CDB	V8-T3-39	E57-30LE22-B	V8-T3-22
E57-30GE15-G	V8-T3-39	E57-30LE22-B1	V8-T3-22
E57-30GE15-G1	V8-T3-39	E57-30LE22-B1B	V8-T3-22
E57-30GE15-G1DB	V8-T3-39	E57-30LE22-B1D	V8-T3-22
E57-30GE15-GDB	V8-T3-39	E57-30LE22-B1P	V8-T3-22
E57-30GE25-D	V8-T3-37	E57-30LE22-BB	V8-T3-22
E57-30GE25-D1	V8-T3-37	E57-30LE22-BD	V8-T3-22
E57-30GE25-D1DB	V8-T3-37	E57-30LE22-C	V8-T3-22
E57-30GE25-DDB	V8-T3-37	E57-30LE22-C1	V8-T3-22
E57-30GE29-C	V8-T3-39	E57-30LE22-C1B	V8-T3-22
E57-30GE29-C1	V8-T3-39	E57-30LE22-C1D	V8-T3-22
E57-30GE29-C1DB	V8-T3-39	E57-30LE22-C1P	V8-T3-22
E57-30GE29-CDB	V8-T3-39	E57-30LE22-CB	V8-T3-22
E57-30GE29-G	V8-T3-39	E57-30LE22-CD	V8-T3-22
E57-30GE29-G1	V8-T3-39	E57-30LE22-CP	V8-T3-22
E57-30GE29-G1DB	V8-T3-39	E57EAL4T110SN	V8-T3-62
E57-30GE29-GDB	V8-T3-39	E57EAL4T110SP	V8-T3-62
E57-30GS10-A	V8-T3-37	E57EAL4T111SN	V8-T3-62
E57-30GS10-A1	V8-T3-37	E57EAL4T111SP	V8-T3-62
E57-30GS10-A1AB	V8-T3-37	E57EAL5T110SN	V8-T3-62
E57-30GS10-AAB	V8-T3-37	E57EAL5T110SP	V8-T3-62
E57-30GS10-C	V8-T3-39	E57EAL5T111SN	V8-T3-62
E57-30GS10-C1	V8-T3-39	E57EAL5T111SP	V8-T3-62
E57-30GS10-C1DB	V8-T3-39	E57EAL6T110EN	V8-T3-62
E57-30GS10-CDB	V8-T3-39	E57EAL6T110EP	V8-T3-62
E57-30GS10-D	V8-T3-37	E57EAL6T110SD	V8-T3-62
E57-30GS10-D1	V8-T3-37	E57EAL6T110SN	V8-T3-62
E57-30GS10-D1DB	V8-T3-37	E57EAL6T110SP	V8-T3-62

E57EAL6T111EN	V8-T3-62	E57LAL12T110E	V8-T3-20
E57EAL6T111EP	V8-T3-62	E57LAL12T110ED	V8-T3-20
E57EAL6T111SD	V8-T3-62	E57LAL12T110EP	V8-T3-20
E57EAL6T111SN	V8-T3-62	E57LAL12T110SD	V8-T3-20
E57EAL6T111SP	V8-T3-62	E57LAL12T110SP	V8-T3-20
E57EAL8T110ED	V8-T3-62	E57LAL12T111	V8-T3-20
E57EAL8T110EN	V8-T3-62	E57LAL12T111E	V8-T3-20
E57EAL8T110EP	V8-T3-62	E57LAL12T111ED	V8-T3-20
E57EAL8T110SD	V8-T3-62	E57LAL12T111EP	V8-T3-20
E57EAL8T110SN	V8-T3-62	E57LAL12T111SD	V8-T3-20
E57EAL8T110SP	V8-T3-62	E57LAL12T111SP	V8-T3-20
E57EAL8T111ED	V8-T3-62	E57LAL18A2	V8-T3-18
E57EAL8T111EN	V8-T3-62	E57LAL18A2E	V8-T3-18
E57EAL8T111EP	V8-T3-62	E57LAL18A2EA	V8-T3-18
E57EAL8T111SD	V8-T3-62	E57LAL18A2EP	V8-T3-18
E57EAL8T111SN	V8-T3-62	E57LAL18A2SA	V8-T3-18
E57EAL8T111SP	V8-T3-62	E57LAL18A2SP	V8-T3-18
E57EBL8T110ED	V8-T3-62	E57LAL18T110	V8-T3-20
E57EBL8T110EN	V8-T3-62	E57LAL18T110E	V8-T3-20
E57EBL8T110EP	V8-T3-62	E57LAL18T110ED	V8-T3-20
E57EBL8T110SD	V8-T3-62	E57LAL18T110EP	V8-T3-20
E57EBL8T110SN	V8-T3-62	E57LAL18T110SD	V8-T3-20
E57EBL8T110SP	V8-T3-62	E57LAL18T110SP	V8-T3-20
E57EBL8T111ED	V8-T3-62	E57LAL18T111	V8-T3-20
E57EBL8T111EP	V8-T3-62	E57LAL18T111E	V8-T3-20
E57EBL8T111SP	V8-T3-62	E57LAL18T111ED	V8-T3-20
E57FAL12A2SA-M	V8-T3-55	E57LAL18T111EP	V8-T3-20
E57FAL12T111SD-M	V8-T3-55	E57LAL18T111SD	V8-T3-20
E57FAL18A2B1	V8-T3-52	E57LAL18T111SP	V8-T3-20
E57FAL18A2SA	V8-T3-52	E57LAL30A2	V8-T3-19
E57FAL18T111SD	V8-T3-52	E57LAL30A2E	V8-T3-19
E57FAL18T111SD-M	V8-T3-55	E57LAL30A2EA	V8-T3-19
E57FAL30A2SA-M	V8-T3-55	E57LAL30A2EP	V8-T3-19
E57KC12	V8-T8-11	E57LAL30A2SA	V8-T3-19
E57KC18	V8-T8-11	E57LAL30A2SP	V8-T3-19
E57KC30	V8-T8-11	E57LAL30T110	V8-T3-22
E57KC8	V8-T8-11	E57LAL30T110E	V8-T3-22
E57KM12	V8-T8-6	E57LAL30T110ED	V8-T3-22
E57KM18	V8-T8-6	E57LAL30T110EP	V8-T3-22
E57KM30	V8-T8-6	E57LAL30T110SD	V8-T3-22
E57KM8	V8-T8-6	E57LAL30T110SP	V8-T3-22
E57KNC18	V8-T8-11	E57LAL30T111	V8-T3-22
E57KNM8	V8-T8-11	E57LAL30T111E	V8-T3-22
E57KNS12	V8-T8-11	E57LAL30T111ED	V8-T3-22
E57KNS18	V8-T8-11	E57LAL30T111EP	V8-T3-22
E57KNS30	V8-T8-11	E57LAL30T111SD	V8-T3-22
E57KNZ12	V8-T8-7	E57LAL30T111SP	V8-T3-22
E57KNZ18	V8-T8-7	E57LBL12A2	V8-T3-18
E57KNZ30	V8-T8-7	E57LBL12A2E	V8-T3-18
E57KNZ8	V8-T8-7	E57LBL12A2EA	V8-T3-18
E57KP12	V8-T8-11	E57LBL12A2EP	V8-T3-18
E57KP18	V8-T8-11	E57LBL12A2SA	V8-T3-18
E57KP30	V8-T8-11	E57LBL12A2SP	V8-T3-18
E57LAL12A2	V8-T3-18	E57LBL12T110	V8-T3-20
E57LAL12A2E	V8-T3-18	E57LBL12T110E	V8-T3-20
E57LAL12A2EA	V8-T3-18	E57LBL12T110ED	V8-T3-20
E57LAL12A2EP	V8-T3-18	E57LBL12T110EP	V8-T3-20
E57LAL12A2SA	V8-T3-18	E57LBL12T110SD	V8-T3-20
E57LAL12A2SP	V8-T3-18	E57LBL12T110SP	V8-T3-20
E57LAL12T110	V8-T3-20	E57LBL12T111	V8-T3-20

Appendix 3

Catalog Number Index

E57LBL12T111E	V8-T3-20	E57MBL30A2EB1	V8-T3-19
E57LBL12T111ED	V8-T3-20	E57MBL30T110B1	V8-T3-22
E57LBL12T111EP	V8-T3-20	E57MBL30T110EB1	V8-T3-22
E57LBL12T111SD	V8-T3-20	E57MBL30T111B1	V8-T3-22
E57LBL12T111SP	V8-T3-20	E57MBL30T111EB1	V8-T3-22
E57LBL18A2	V8-T3-18	E57RAL18A2	V8-T3-19
E57LBL18A2E	V8-T3-18	E57RAL18A2B1	V8-T3-19
E57LBL18A2EA	V8-T3-18	E57RAL18A2E	V8-T3-19
E57LBL18A2EP	V8-T3-18	E57RAL18A2EA	V8-T3-19
E57LBL18A2SA	V8-T3-18	E57RAL18A2EB1	V8-T3-19
E57LBL18A2SP	V8-T3-18	E57RAL18A2EP	V8-T3-19
E57LBL18T110	V8-T3-20	E57RAL18A2SA	V8-T3-19
E57LBL18T110E	V8-T3-20	E57RAL18A2SP	V8-T3-19
E57LBL18T110ED	V8-T3-20	E57RAL18T110	V8-T3-21
E57LBL18T110EP	V8-T3-20	E57RAL18T110B1	V8-T3-21
E57LBL18T110SD	V8-T3-20	E57RAL18T110E	V8-T3-21
E57LBL18T110SP	V8-T3-20	E57RAL18T110EB1	V8-T3-21
E57LBL18T111	V8-T3-20	E57RAL18T110ED	V8-T3-21
E57LBL18T111E	V8-T3-20	E57RAL18T110EP	V8-T3-21
E57LBL18T111ED	V8-T3-20	E57RAL18T110SD	V8-T3-21
E57LBL18T111EP	V8-T3-20	E57RAL18T110SP	V8-T3-21
E57LBL18T111SD	V8-T3-20	E57RAL18T111	V8-T3-21
E57LBL18T111SP	V8-T3-20	E57RAL18T111B1	V8-T3-21
E57LBL30A2	V8-T3-19	E57RAL18T111E	V8-T3-21
E57LBL30A2E	V8-T3-19	E57RAL18T111EB1	V8-T3-21
E57LBL30A2EA	V8-T3-19	E57RAL18T111ED	V8-T3-21
E57LBL30A2EP	V8-T3-19	E57RAL18T111EP	V8-T3-21
E57LBL30A2SA	V8-T3-19	E57RAL18T111SD	V8-T3-21
E57LBL30A2SP	V8-T3-19	E57RAL18T111SP	V8-T3-21
E57LBL30T110	V8-T3-22	E57RBL18A2	V8-T3-19
E57LBL30T110E	V8-T3-22	E57RBL18A2B1	V8-T3-19
E57LBL30T110ED	V8-T3-22	E57RBL18A2E	V8-T3-19
E57LBL30T110EP	V8-T3-22	E57RBL18A2EA	V8-T3-19
E57LBL30T110SD	V8-T3-22	E57RBL18A2EB1	V8-T3-19
E57LBL30T110SP	V8-T3-22	E57RBL18A2EP	V8-T3-19
E57LBL30T111	V8-T3-22	E57RBL18A2SA	V8-T3-19
E57LBL30T111E	V8-T3-22	E57RBL18A2SP	V8-T3-19
E57LBL30T111ED	V8-T3-22	E57RBL18T110	V8-T3-21
E57LBL30T111EP	V8-T3-22	E57RBL18T110B1	V8-T3-21
E57LBL30T111SD	V8-T3-22	E57RBL18T110E	V8-T3-21
E57LBL30T111SP	V8-T3-22	E57RBL18T110EB1	V8-T3-21
E57MAL12A2B1	V8-T3-18	E57RBL18T110ED	V8-T3-21
E57MAL18A2B1	V8-T3-18	E57RBL18T110EP	V8-T3-21
E57MAL18A2EB1	V8-T3-18	E57RBL18T110SD	V8-T3-21
E57MAL18T110B1	V8-T3-20	E57RBL18T110SP	V8-T3-21
E57MAL18T110EB1	V8-T3-20	E57RBL18T111	V8-T3-21
E57MAL18T111B1	V8-T3-20	E57RBL18T111B1	V8-T3-21
E57MAL18T111EB1	V8-T3-20	E57RBL18T111E	V8-T3-21
E57MAL30A2B1	V8-T3-19	E57RBL18T111EB1	V8-T3-21
E57MAL30A2EB1	V8-T3-19	E57RBL18T111ED	V8-T3-21
E57MAL30T110B1	V8-T3-22	E57RBL18T111EP	V8-T3-21
E57MAL30T110EB1	V8-T3-22	E57RBL18T111SD	V8-T3-21
E57MAL30T111B1	V8-T3-22	E57RBL18T111SP	V8-T3-21
E57MAL30T111EB1	V8-T3-22	E57SAL12A2	V8-T3-18, V8-T3-30
E57MBL18A2B1	V8-T3-18	E57SAL12A2E	V8-T3-18, V8-T3-30
E57MBL18A2EB1	V8-T3-18	E57SAL12A2EA	V8-T3-18, V8-T3-30
E57MBL18T110B1	V8-T3-20	E57SAL12A2SA	V8-T3-18, V8-T3-30
E57MBL18T110EB1	V8-T3-20	E57SAL12A4	V8-T3-30
E57MBL18T111B1	V8-T3-20	E57SAL12A4E	V8-T3-30
E57MBL18T111EB1	V8-T3-20	E57SAL12A4EA	V8-T3-30

E57SAL12A4SA	V8-T3-30	E57SBL18A4E	V8-T3-30
E57SAL12T110	V8-T3-31	E57SBL18A4EA	V8-T3-30
E57SAL12T110E	V8-T3-31	E57SBL18A4SA	V8-T3-30
E57SAL12T110ED	V8-T3-31	E57SBL18T110	V8-T3-31
E57SAL12T110SD	V8-T3-31	E57SBL18T110E	V8-T3-31
E57SAL12T111	V8-T3-31	E57SBL18T110ED	V8-T3-31
E57SAL12T111E	V8-T3-31	E57SBL18T110SD	V8-T3-31
E57SAL12T111ED	V8-T3-31	E57SBL18T111	V8-T3-31
E57SAL12T111SD	V8-T3-31	E57SBL18T111E	V8-T3-31
E57SAL18A2	V8-T3-18, V8-T3-30	E57SBL18T111ED	V8-T3-31
E57SAL18A2E	V8-T3-18, V8-T3-30	E57SBL18T111SD	V8-T3-31
E57SAL18A2EA	V8-T3-18, V8-T3-30	E57SBL30A2	V8-T3-19, V8-T3-30
E57SAL18A2SA	V8-T3-18, V8-T3-30	E57SBL30A2E	V8-T3-19, V8-T3-30
E57SAL18A4	V8-T3-30	E57SBL30A2EA	V8-T3-19, V8-T3-30
E57SAL18A4E	V8-T3-30	E57SBL30A2SA	V8-T3-19, V8-T3-30
E57SAL18A4EA	V8-T3-30	E57SBL30A4	V8-T3-30
E57SAL18A4SA	V8-T3-30	E57SBL30A4E	V8-T3-30
E57SAL18T110	V8-T3-31	E57SBL30A4EA	V8-T3-30
E57SAL18T110E	V8-T3-31	E57SBL30A4SA	V8-T3-30
E57SAL18T110ED	V8-T3-31	E57SBL30T110	V8-T3-31
E57SAL18T110SD	V8-T3-31	E57SBL30T110ED	V8-T3-31
E57SAL18T111	V8-T3-31	E57SBL30T110SD	V8-T3-31
E57SAL18T111E	V8-T3-31	E57SBL30T111	V8-T3-31
E57SAL18T111ED	V8-T3-31	E57SBL30T111E	V8-T3-31
E57SAL18T111SD	V8-T3-31	E57SBL30T111ED	V8-T3-31
E57SAL30A2	V8-T3-19, V8-T3-30	E58-18DP100-DDP	V8-T5-87
E57SAL30A2E	V8-T3-19, V8-T3-30	E58-18DP100-DLP	V8-T5-87
E57SAL30A2EA	V8-T3-19, V8-T3-30	E58-18DP100-ED	V8-T5-87
E57SAL30A2SA	V8-T3-19, V8-T3-30	E58-18DP100-EDP	V8-T5-87
E57SAL30A4	V8-T3-30	E58-18DP100-EDPB	V8-T5-87
E57SAL30A4E	V8-T3-30	E58-18DP100-EL	V8-T5-87
E57SAL30A4EA	V8-T3-30	E58-18DP100-ELP	V8-T5-87
E57SAL30A4SA	V8-T3-30	E58-18DP100-ELPB	V8-T5-87
E57SAL30T110	V8-T3-31	E58-18DP100-HD	V8-T5-87
E57SAL30T110E	V8-T3-31	E58-18DP100-HDP	V8-T5-87
E57SAL30T110ED	V8-T3-31	E58-18DP100-HL	V8-T5-87
E57SAL30T110SD	V8-T3-31	E58-18DP100-HLP	V8-T5-87
E57SAL30T111	V8-T3-31	E58-18DP50-DDP	V8-T5-87
E57SAL30T111E	V8-T3-31	E58-18DP50-DLP	V8-T5-87
E57SAL30T111ED	V8-T3-31	E58-18DP50-ED	V8-T5-87
E57SAL30T111SD	V8-T3-31	E58-18DP50-EDP	V8-T5-87
E57SBL12A2	V8-T3-18, V8-T3-30	E58-18DP50-EDPB	V8-T5-87
E57SBL12A2E	V8-T3-18, V8-T3-30	E58-18DP50-EL	V8-T5-87
E57SBL12A2EA	V8-T3-18, V8-T3-30	E58-18DP50-ELP	V8-T5-87
E57SBL12A2SA	V8-T3-18, V8-T3-30	E58-18DP50-ELPB	V8-T5-87
E57SBL12A4	V8-T3-30	E58-18DP50-HD	V8-T5-87
E57SBL12A4E	V8-T3-30	E58-18DP50-HDP	V8-T5-87
E57SBL12A4EA	V8-T3-30	E58-18DP50-HL	V8-T5-87
E57SBL12A4SA	V8-T3-30	E58-18DP50-HLP	V8-T5-87
E57SBL12T110E	V8-T3-31	E58-30DP150-DDP	V8-T5-87
E57SBL12T110ED	V8-T3-31	E58-30DP150-DLP	V8-T5-87
E57SBL12T111	V8-T3-31	E58-30DP150-ED	V8-T5-87
E57SBL12T111E	V8-T3-31	E58-30DP150-EDP	V8-T5-87
E57SBL12T111ED	V8-T3-31	E58-30DP150-EDPB	V8-T5-87
E57SBL12T111SD	V8-T3-31	E58-30DP150-EL	V8-T5-87
E57SBL18A2	V8-T3-18, V8-T3-30	E58-30DP150-ELP	V8-T5-87
E57SBL18A2E	V8-T3-18, V8-T3-30	E58-30DP150-ELPB	V8-T5-87
E57SBL18A2EA	V8-T3-18, V8-T3-30	E58-30DP150-GD	V8-T5-87
E57SBL18A2SA	V8-T3-18, V8-T3-30	E58-30DP150-GDP	V8-T5-87
E57SBL18A4	V8-T3-30	E58-30DP150-GL	V8-T5-87

Appendix 3

Catalog Number Index

E58-30DP150-GLP	V8-T5-87	E58CBL18T110C2	See Tab 11
E58-30DP150-HD	V8-T5-87	E58CBL18T110D2	See Tab 11
E58-30DP150-HDP	V8-T5-87	E58CBL18T110R2	See Tab 11
E58-30DP150-HLP	V8-T5-87	E58CBL18T111C2	See Tab 11
E58-30DPS280-ED	V8-T5-87	E58CBL18T111D2	See Tab 11
E58-30DPS280-EDP	V8-T5-87	E58CBL18T111R2	See Tab 11
E58-30DPS280-EDPB	V8-T5-87	E58KAM18	V8-T8-6
E58-30DPS280-EL	V8-T5-87	E58KAM18B	V8-T8-7
E58-30DPS280-ELP	V8-T5-87	E58KAM18U	V8-T8-6
E58-30DPS280-ELPB	V8-T5-87	E58KAM30	V8-T8-7
E58-30DPS280-GD	V8-T5-87	E58KAM30U	V8-T8-7
E58-30DPS280-GDP	V8-T5-87	E58KC30	V8-T8-11
E58-30DPS280-GL	V8-T5-87	E58KNS18	V8-T8-11
E58-30DPS280-GLP	V8-T5-87	E58KNS30	V8-T8-11
E58-30DPS280-HD	V8-T5-87	E58KS5200	V8-T5-63, V8-T5-72, V8-T5-80
E58-30DPS280-HDP	V8-T5-87	E59	V8-T3-12
E58-30DPS280-HL	V8-T5-87	E5912ACKIT	V8-T3-15
E58-30DPS280-HLP	V8-T5-87	E5912DCKIT	V8-T3-15
E58-30RP10-GD	V8-T5-86	E5918ACKIT	V8-T3-15
E58-30RP10-GDP	V8-T5-86	E5918DCKIT	V8-T3-15
E58-30RP10-GL	V8-T5-86	E5930ACKIT	V8-T3-15
E58-30RP10-GLP	V8-T5-86	E5930DCKIT	V8-T3-15
E58-30RP10-HD	V8-T5-86	E59-A12A104C02-C1	V8-T3-47
E58-30RP10-HDP	V8-T5-86	E59-A12A104C02-CV	V8-T3-47
E58-30RP10-HL	V8-T5-86	E59-A12A104D01-C1	V8-T3-47
E58-30RP10-HLP	V8-T5-86	E59-A12A104D01-CV	V8-T3-47
E58-30RS18-GD	V8-T5-86	E59-A12A104D01P-C1	V8-T3-47
E58-30RS18-GDP	V8-T5-86	E59-A12A104D01P-CV	V8-T3-47
E58-30RS18-GL	V8-T5-86	E59-A12C108C02-C1	V8-T3-47
E58-30RS18-GLP	V8-T5-86	E59-A12C108C02-CV	V8-T3-47
E58-30RS18-HD	V8-T5-86	E59-A12C108D01-C1	V8-T3-47
E58-30RS18-HDP	V8-T5-86	E59-A12C108D01-CV	V8-T3-47
E58-30RS18-HL	V8-T5-86	E59-A12C108D01P-C1	V8-T3-47
E58-30RS18-HLP	V8-T5-86	E59-A12C108D01P-CV	V8-T3-47
E58-30TD250-GD	V8-T5-86	E59-A18A107C02-C1	V8-T3-47
E58-30TD250-GDP	V8-T5-86	E59-A18A107C02-CV	V8-T3-47
E58-30TD250-GL	V8-T5-86	E59-A18A107D01-CV	V8-T3-47
E58-30TD250-GLP	V8-T5-86	E59-A18A107D01P-C1	V8-T3-47
E58-30TD250-HD	V8-T5-86	E59-A18A107D01P-CV	V8-T3-47
E58-30TD250-HDP	V8-T5-86	E59-A18C115C02-CV	V8-T3-47
E58-30TD250-HL	V8-T5-86	E59-A18C115D01-C1	V8-T3-47
E58-30TD250-HLP	V8-T5-86	E59-A18C115D01P-C1	V8-T3-47
E58-30TS250-GA	V8-T5-86	E59-A18C115D01P-CV	V8-T3-47
E58-30TS250-GAP	V8-T5-86	E59-A30A112C02-C1	V8-T3-47
E58-30TS250-HA	V8-T5-86	E59-A30A112C02-CV	V8-T3-47
E58-30TS250-HAP	V8-T5-86	E59-A30A112D01-C1	V8-T3-47
E58CAL18A2C2	See Tab 11	E59-A30A112D01-CV	V8-T3-47
E58CAL18A2D2	See Tab 11	E59-A30A112D01P-C1	V8-T3-47
E58CAL18A2E2	See Tab 11	E59-A30A112D01P-CV	V8-T3-47
E58CAL18A2R2	See Tab 11	E59-A30C125C02-C1	V8-T3-47
E58CAL18T110C2	See Tab 11	E59-A30C125C02-CV	V8-T3-47
E58CAL18T110D2	See Tab 11	E59-A30C125D01-C1	V8-T3-47
E58CAL18T110E2	See Tab 11	E59-A30C125D01-CV	V8-T3-47
E58CAL18T110R2	See Tab 11	E59-A30C125D01P-C1	V8-T3-47
E58CAL18T111C2	See Tab 11	E59-A30C125D01P-CV	V8-T3-47
E58CAL18T111D2	See Tab 11	E59DEMO1	V8-T3-15
E58CAL18T111R2	See Tab 11	E59LABEL	V8-T3-14
E58CBL18A2C2	See Tab 11	E59-M12A105A01-A1	V8-T3-11
E58CBL18A2D2	See Tab 11	E59-M12A105A01-A2	V8-T3-11
E58CBL18A2R2	See Tab 11	E59-M12A105A01P-A1	V8-T3-11

E59-M12A105A01P-A2	V8-T3-11	E59-M18A109C02-A1	V8-T3-11
E59-M12A105A01PB-A1	V8-T3-11	E59-M18A109C02-A2	V8-T3-11
E59-M12A105A01PB-A2	V8-T3-11	E59-M18C116C02-D1	V8-T3-12
E59-M12A105C02-A1	V8-T3-11	E59-M18C116C02-D1NN	V8-T3-13
E59-M12A105C02-A2	V8-T3-11	E59-M18C116C02-D1PP	V8-T3-13
E59-M12A105C02-D1	V8-T3-12	E59-M18C116C02-D2	V8-T3-12
E59-M12A105C02-D1NN	V8-T3-13	E59-M18C116C02-D3NN	V8-T3-13
E59-M12A105C02-D1PP	V8-T3-13	E59-M18C116C02-D3PP	V8-T3-13
E59-M12A105C02-D2	V8-T3-12	E59-M18C116D01-D1	V8-T3-12
E59-M12A105C02-D3NN	V8-T3-13	E59-M18C116D01-D1NN	V8-T3-13
E59-M12A105C02-D3PP	V8-T3-13	E59-M18C116D01-D1PP	V8-T3-13
E59-M12A105D01-D1	V8-T3-12	E59-M18C116D01-D2	V8-T3-12
E59-M12A105D01-D1NN	V8-T3-13	E59-M18C116D01-D3NN	V8-T3-13
E59-M12A105D01-D1PP	V8-T3-13	E59-M18C116D01-D3PP	V8-T3-13
E59-M12A105D01-D2	V8-T3-12	E59-M18C116D01P-D1	V8-T3-12
E59-M12A105D01-D3NN	V8-T3-13	E59-M18C116D01P-D2	V8-T3-12
E59-M12A105D01-D3PP	V8-T3-13	E59-M18C118A01-A1	V8-T3-11
E59-M12A105D01P-D1	V8-T3-12	E59-M18C118A01-A2	V8-T3-11
E59-M12A105D01P-D2	V8-T3-12	E59-M18C118A01P-A1	V8-T3-11
E59-M12C110A01-A1	V8-T3-11	E59-M18C118A01P-A2	V8-T3-11
E59-M12C110A01-A2	V8-T3-11	E59-M18C118A01PB-A1	V8-T3-11
E59-M12C110A01P-A1	V8-T3-11	E59-M18C118A01PB-A2	V8-T3-11
E59-M12C110A01P-A2	V8-T3-11	E59-M18C118C02-A1	V8-T3-11
E59-M12C110A01PB-A1	V8-T3-11	E59-M18C118C02-A2	V8-T3-11
E59-M12C110A01PB-A2	V8-T3-11	E59-M30A115A01-A1	V8-T3-11
E59-M12C110C02-A1	V8-T3-11	E59-M30A115A01-A2	V8-T3-11
E59-M12C110C02-A2	V8-T3-11	E59-M30A115A01P-A1	V8-T3-11
E59-M12C110C02-D1	V8-T3-12	E59-M30A115A01P-A2	V8-T3-11
E59-M12C110C02-D1NN	V8-T3-13	E59-M30A115A01PB-A1	V8-T3-11
E59-M12C110C02-D1PP	V8-T3-13	E59-M30A115A01PB-A2	V8-T3-11
E59-M12C110C02-D2	V8-T3-12	E59-M30A115C02-A1	V8-T3-11
E59-M12C110C02-D3NN	V8-T3-13	E59-M30A115C02-A2	V8-T3-11
E59-M12C110C02-D3PP	V8-T3-13	E59-M30A115C02-D1PP	V8-T3-13
E59-M12C110D01-D1	V8-T3-12	E59-M30A115C02-D3NN	V8-T3-13
E59-M12C110D01-D1NN	V8-T3-13	E59-M30A115C02-D3PP	V8-T3-13
E59-M12C110D01-D1PP	V8-T3-13	E59-M30A115D01-D1NN	V8-T3-13
E59-M12C110D01-D2	V8-T3-12	E59-M30A115D01-D1PP	V8-T3-13
E59-M12C110D01-D3NN	V8-T3-13	E59-M30A115D01-D3NN	V8-T3-13
E59-M12C110D01-D3PP	V8-T3-13	E59-M30A115D01-D3PP	V8-T3-13
E59-M12C110D01P-D1	V8-T3-12	E59-M30C129A01-A1	V8-T3-11
E59-M12C110D01P-D2	V8-T3-12	E59-M30C129A01-A2	V8-T3-11
E59-M18A108C02-D1	V8-T3-12	E59-M30C129A01P-A1	V8-T3-11
E59-M18A108C02-D1NN	V8-T3-13	E59-M30C129A01P-A2	V8-T3-11
E59-M18A108C02-D1PP	V8-T3-13	E59-M30C129A01PB-A1	V8-T3-11
E59-M18A108C02-D2	V8-T3-12	E59-M30C129A01PB-A2	V8-T3-11
E59-M18A108C02-D3PP	V8-T3-13	E59-M30C129C02-A1	V8-T3-11
E59-M18A108D01-D1	V8-T3-12	E59-M30C129C02-A2	V8-T3-11
E59-M18A108D01-D1NN	V8-T3-13	E59-M30C129C02-D1NN	V8-T3-13
E59-M18A108D01-D1PP	V8-T3-13	E59-M30C129C02-D1PP	V8-T3-13
E59-M18A108D01-D2	V8-T3-12	E59-M30C129C02-D3NN	V8-T3-13
E59-M18A108D01-D3NN	V8-T3-13	E59-M30C129C02-D3PP	V8-T3-13
E59-M18A108D01-D3PP	V8-T3-13	E59-M30C129D01-D1NN	V8-T3-13
E59-M18A108D01P-D1	V8-T3-12	E59-M30C129D01-D1PP	V8-T3-13
E59-M18A108D01P-D2	V8-T3-12	E59-M30C129D01-D3NN	V8-T3-13
E59-M18A109A01-A1	V8-T3-11	E59-M30C129D01-D3PP	V8-T3-13
E59-M18A109A01-A2	V8-T3-11	E59RP1	V8-T3-14
E59-M18A109A01P-A1	V8-T3-11	E59SW1	V8-T3-14
E59-M18A109A01P-A2	V8-T3-11	E60KNS18	V8-T8-11
E59-M18A109A01PB-A1	V8-T3-11	E64CAL4T	See Tab 11
E59-M18A109A01PB-A2	V8-T3-11	E64CAT2T	See Tab 11

Appendix 3

Catalog Number Index

E64CAT3T	See Tab 11	E67-LRDPXXX-HDD	V8-T5-94
E64CAT5T	See Tab 11	E67-LRDPXXX-HLD	V8-T5-94
E65CBL2	See Tab 11	E67-LRDPXXX-KDD	V8-T5-94
E65CBL2N	See Tab 11	E67-LRDPXXX-KLD	V8-T5-94
E65CBL3	See Tab 11	E68-SVABEAM-1	V8-T6-7
E65CBL4	See Tab 11	E68-SVADSC-P	V8-T6-9
E65CBL5	See Tab 11	E68-SVAEXT-C1	V8-T6-8
E65CBL6	See Tab 11	E68-SVAEXT-P1	V8-T6-8
E65CBL7R	See Tab 11	E68-SVAISO-C	V8-T6-8
E65PS	V8-T8-13	E68-SVAISO-P	V8-T6-8
E65PST	V8-T8-13	E68-SVAJMP1-C5	V8-T6-8
E65-SMPP050-GD	V8-T5-50	E68-SVAJMP1-P5	V8-T6-8
E65-SMPP050-GDD	V8-T5-50	E68-SVAPWR-C2	V8-T6-7
E65-SMPP050-GL	V8-T5-50	E68-SVAPWR-P02	V8-T6-7
E65-SMPP050-GLD	V8-T5-50	E68-SVAPWR-P2	V8-T6-7
E65-SMPP050-HD	V8-T5-50	E68-SVAREL2-C2	V8-T6-7
E65-SMPP050-HDD	V8-T5-50	E68-SVAREL2-P2	V8-T6-7
E65-SMPP050-HL	V8-T5-50	E68-SVASLUG-C	V8-T6-8
E65-SMPP050-HLD	V8-T5-50	E68-SVASLUG-P	V8-T6-8
E65-SMPP100-GD	V8-T5-50	E68-SVAUSC-P	V8-T6-9
E65-SMPP100-GDD	V8-T5-50	E68-SVSPR3-BDC	V8-T6-5
E65-SMPP100-GL	V8-T5-50	E68-SVSPR3-BDC-B	V8-T6-5
E65-SMPP100-GLD	V8-T5-50	E68-SVSPR3-BDP	V8-T6-5
E65-SMPP100-HD	V8-T5-50	E68-SVSPR3-BDP-B	V8-T6-5
E65-SMPP100-HDD	V8-T5-50	E68-SVSPR3-BLC	V8-T6-5
E65-SMPP100-HL	V8-T5-50	E68-SVSPR3-BLC-B	V8-T6-5
E65-SMPP100-HLD	V8-T5-50	E68-SVSPR3-BLP	V8-T6-5
E65-SMPR3-GD	V8-T5-50	E68-SVSPR3-BLP-B	V8-T6-5
E65-SMPR3-GDD	V8-T5-50	E68-SVSPR3-PDC	V8-T6-6
E65-SMPR3-GL	V8-T5-50	E68-SVSPR3-PDC-B	V8-T6-6
E65-SMPR3-GLD	V8-T5-50	E68-SVSPR3-PDP	V8-T6-6
E65-SMPR3-HD	V8-T5-50	E68-SVSPR3-PDP-B	V8-T6-6
E65-SMPR3-HDD	V8-T5-50	E68-SVSPR3-PLC	V8-T6-6
E65-SMPR3-HL	V8-T5-50	E68-SVSPR3-PLC-B	V8-T6-6
E65-SMPR3-HLD	V8-T5-50	E68-SVSPR3-PLP	V8-T6-6
E65-SMSD200-GD	V8-T5-50	E68-SVSPR3-PLP-B	V8-T6-6
E65-SMSD200-GDD	V8-T5-50	E68-SVSSD1-BDC	V8-T6-5
E65-SMSD200-GL	V8-T5-50	E68-SVSSD1-BDC-B	V8-T6-5
E65-SMSD200-GLD	V8-T5-50	E68-SVSSD1-BDP	V8-T6-5
E65-SMSD200-HD	V8-T5-50	E68-SVSSD1-BDP-B	V8-T6-5
E65-SMSD200-HDD	V8-T5-50	E68-SVSSD1-BLC	V8-T6-5
E65-SMSD200-HL	V8-T5-50	E68-SVSSD1-BLC-B	V8-T6-5
E65-SMSD200-HLD	V8-T5-50	E68-SVSSD1-BLP	V8-T6-5
E65-SMTD15-HD	V8-T5-50	E68-SVSSD1-BLP-B	V8-T6-5
E65-SMTD15-HDD	V8-T5-50	E68-SVSSD1-PD	V8-T6-6
E65-SMTD15-HL	V8-T5-50	E68-SVSSD1-PDC	V8-T6-6
E65-SMTD15-HLD	V8-T5-50	E68-SVSSD1-PDC-B	V8-T6-6
E65-SMTS15-HA	V8-T5-50	E68-SVSSD1-PDP	V8-T6-6
E65-SMTS15-HAD	V8-T5-50	E68-SVSSD1-PLC	V8-T6-6
E65VBL1C	See Tab 11	E68-SVSSD1-PLC-B	V8-T6-6
E65VBL2	See Tab 11	E68-SVSSD1-PLP	V8-T6-6
E65VBL2N	See Tab 11	E68-SVSSD1-PLP-B	V8-T6-6
E65VBL3	See Tab 11	E71-CON-M8	V8-T5-28
E65VBL4	See Tab 11	E71-COP-CA	V8-T5-28
E65VBL5	See Tab 11	E71-COP-M8	V8-T5-28
E65VBL6	See Tab 11	E71-FFDN-CA	V8-T5-28
E67-LRDP200-HDD	V8-T5-94	E71-FFDP-CA	V8-T5-28
E67-LRDP200-HLD	V8-T5-94	E71-FFDP-M8	V8-T5-28
E67-LRDP200-KDD	V8-T5-94	E71-MTB1	V8-T5-29
E67-LRDP200-KLD	V8-T5-94		

Appendix 3

Catalog Number Index

EGF1NCDCNE100	V8-T7-38	LSE-02-OR	V8-T2-29
EGF1NCLA050	V8-T7-39	LSE-02-P	V8-T2-26
EGF1NCLA100	V8-T7-39	LSE-02-RL	V8-T2-27
EGF1NCLAT3	V8-T7-39	LSE-02-RLA	V8-T2-27
EGF1NOACDE050	V8-T7-38	LSE-02-RLA30	V8-T2-27
EGF1NOACDE100	V8-T7-38	LSE-02-RLA40	V8-T2-28
EGF1NOACNE050	V8-T7-38	LSE-02-RLA40R	V8-T2-28
EGF1NOACNE100	V8-T7-38	LSE-02-RR	V8-T2-28
EGF1NODCDE050	V8-T7-38	LSE-02-RRM	V8-T2-29
EGF1NODCDE100	V8-T7-38	LSE-02-S	V8-T2-29
EGF1NODCNE050	V8-T7-38	LSE-11-L	V8-T2-26
EGF1NODCNE100	V8-T7-38	LSE-11-LA	V8-T2-26
EGF1NOLA050	V8-T7-39	LSE-11-LB	V8-T2-26
EGF1NOLA100	V8-T7-39	LSE-11-LS	V8-T2-26
EGF1NOLAT3	V8-T7-39	LSE-11-OR	V8-T2-29
EGF1SPDTDE050	V8-T7-39	LSE-11-P	V8-T2-26
EGF1SPDTDE100	V8-T7-39	LSE-11-RL	V8-T2-27
EGF1SPDTDET3	V8-T7-39	LSE-11-RLA	V8-T2-27
EGF1SPDTNE050	V8-T7-39	LSE-11-RLA30	V8-T2-27
EGF1SPDTNE100	V8-T7-39	LSE-11-RLA40	V8-T2-28
EGF1SPDTNET3	V8-T7-39	LSE-11-RLA40R	V8-T2-28
EGF2NCLA050	V8-T7-39	LSE-11-RR	V8-T2-28
EGF2NCLA100	V8-T7-39	LSE-11-RRM	V8-T2-29
EGF2NCLAT3	V8-T7-39	LSE-11-S	V8-T2-29
EGF2NOLA050	V8-T7-39	LSE-AI-L	V8-T2-26
EGF2NOLA100	V8-T7-39	LSE-AI-LA	V8-T2-26
EGF2NOLAT3	V8-T7-39	LSE-AI-LB	V8-T2-26
EGF2SPDTDE050	V8-T7-39	LSE-AI-LS	V8-T2-26
EGF2SPDTDE100	V8-T7-39	LSE-AI-OR	V8-T2-29
EGF2SPDTDET3	V8-T7-39	LSE-AI-P	V8-T2-26
EGF2SPDTNE050	V8-T7-39	LSE-AI-RL	V8-T2-27
EGF2SPDTNE100	V8-T7-39	LSE-AI-RLA	V8-T2-27
EGF2SPDTNET3	V8-T7-39	LSE-AI-RLA30	V8-T2-27
EGF3NCACDET3	V8-T7-38	LSE-AI-RLA40	V8-T2-28
EGF3NCACNET3	V8-T7-38	LSE-AI-RLA40R	V8-T2-28
EGF3NCDCDET3	V8-T7-38	LSE-AI-RR	V8-T2-28
EGF3NCDCNET3	V8-T7-38	LSE-AI-RRM	V8-T2-29
EGF3NOACDET3	V8-T7-38	LSE-AI-S	V8-T2-29
EGF3NOACNET3	V8-T7-38	LSE-AU-LA	V8-T2-26
EGF3NODCDET3	V8-T7-38	LSE-AU-LB	V8-T2-26
EGF3NODCNET3	V8-T7-38	LSE-AU-LS	V8-T2-26
EGFL1NCLAT3	V8-T7-43	LSE-AU-OR	V8-T2-29
EGFL1NOLAT3	V8-T7-43	LSE-AU-P	V8-T2-26
EGFL1SPDTDET3	V8-T7-43	LSE-AU-RL	V8-T2-27
EGFL1SPDTNET3	V8-T7-43	LSE-AU-RLA	V8-T2-27
EGFL2NCLAT3	V8-T7-43	LSE-AU-RLA30	V8-T2-27
EGFL2NOLAT3	V8-T7-43	LSE-AU-RLA40	V8-T2-28
EGFL2SPDTDET3	V8-T7-43	LSE-AU-RLA40R	V8-T2-28
EGFL2SPDTNET3	V8-T7-43	LSE-AU-RR	V8-T2-28
EMS20	V8-T2-33	LSE-AU-RRM	V8-T2-29
EVT1-420-24L	V8-T7-6	LSE-AU-S	V8-T2-29
EVT3-420-24L	V8-T7-6	LSM-02-L	V8-T2-30
EVT4-420-24L	V8-T7-6	LSM-02-LA	V8-T2-30
		LSM-02-P	V8-T2-30
		LSM-02-RL	V8-T2-30
		LSM-02-RLA	V8-T2-30
		LSM-02-RR	V8-T2-31
		LSM-02-RRM	V8-T2-31
		LSM-02-S	V8-T2-31
		LSM-11S-L	V8-T2-30
L			
LS4-S11-1-I-ZB	V8-T1-6		
LSE-02-L	V8-T2-26		
LSE-02-LA	V8-T2-26		
LSE-02-LB	V8-T2-26		
LSE-02-LS	V8-T2-26		

LSM-11S-LA	V8-T2-30	LS-S11S-RLA40R	V8-T2-24
LSM-11S-P	V8-T2-30	LS-S11S-RR	V8-T2-25
LSM-11S-RL	V8-T2-30	LS-S11S-RRM	V8-T2-25
LSM-11S-RLA	V8-T2-30	LS-S11S-S	V8-T2-25
LSM-11S-RR	V8-T2-31	LS-S11S-ZB	V8-T1-5
LSM-11S-RRM	V8-T2-31	LS-S11-ZB	V8-T1-5
LSM-11S-S	V8-T2-31	LS-S20A-L	V8-T2-23
LSM-20A-L	V8-T2-30	LS-S20A-LA	V8-T2-23
LSM-20A-LA	V8-T2-30	LS-S20A-LB	V8-T2-23
LSM-20A-P	V8-T2-30	LS-S20A-LS	V8-T2-23
LSM-20A-RL	V8-T2-30	LS-S20A-OR	V8-T2-25
LSM-20A-RLA	V8-T2-30	LS-S20A-P	V8-T2-23
LSM-20A-RR	V8-T2-31	LS-S20A-RL	V8-T2-23
LSM-20A-RRM	V8-T2-31	LS-S20A-RLA	V8-T2-24
LSM-20A-S	V8-T2-31	LS-S20A-RLA30	V8-T2-24
LSM-XL	V8-T2-30	LS-S20A-RLA40	V8-T2-24
LSM-XLA	V8-T2-30	LS-S20A-RLA40R	V8-T2-24
LSM-XP	V8-T2-30	LS-S20A-RR	V8-T2-25
LSM-XRL	V8-T2-30	LS-S20A-RRM	V8-T2-25
LSM-XRLA	V8-T2-30	LS-S20A-S	V8-T2-25
LSM-XRR	V8-T2-31	LS-XB-ZB	V8-T1-5
LSM-XRRM	V8-T2-31	LS-XFG-ZBZ	V8-T1-7
LSM-XS	V8-T2-31	LS-XF-ZBZ	V8-T1-7
LSR-S02-1-I-TKG	V8-T1-5	LS-XG-ZBZ	V8-T1-7
LSR-S02-1-I-TS	V8-T1-5	LS-XL	V8-T2-23, V8-T2-26
LSR-S11-1-I-TKG	V8-T1-5	LS-XLA	V8-T2-23, V8-T2-26
LSR-S11-1-I-TS	V8-T1-5	LS-XLB	V8-T2-23, V8-T2-26
LS-S02-120AFT-ZBZ-X	V8-T1-6	LS-XLS	V8-T2-23, V8-T2-26
LS-S02-120AMT-ZBZ-X	V8-T1-6	LS-XNG-ZBZ	V8-T1-7
LS-S02-24DFT-ZBZ-X	V8-T1-6	LS-XNW-ZBZ	V8-T1-7
LS-S02-24DMT-ZBZ-X	V8-T1-6	LS-XOR	V8-T2-25, V8-T2-29
LS-S02-L	V8-T2-23	LS-XP	V8-T2-23, V8-T2-26
LS-S02-LA	V8-T2-23	LS-XRL	V8-T2-23, V8-T2-27
LS-S02-LB	V8-T2-23	LS-XRLA	V8-T2-24, V8-T2-27
LS-S02-LS	V8-T2-23	LS-XRLA30	V8-T2-24, V8-T2-27
LS-S02-OR	V8-T2-25	LS-XRLA40	V8-T2-24, V8-T2-28
LS-S02-P	V8-T2-23	LS-XRLA40R	V8-T2-24, V8-T2-28
LS-S02-RL	V8-T2-23	LS-XRR	V8-T2-25, V8-T2-28
LS-S02-RLA	V8-T2-24	LS-XRRM	V8-T2-25, V8-T2-29
LS-S02-RLA30	V8-T2-24	LS-XS	V8-T2-25, V8-T2-29
LS-S02-RLA40	V8-T2-24	LS-XTW	V8-T2-33
LS-S02-RLA40R	V8-T2-24	LS-XWA-ZBZ	V8-T1-7
LS-S02-RR	V8-T2-25	LS-XW-ZBZ	V8-T1-7
LS-S02-RRM	V8-T2-25		
LS-S02-S	V8-T2-25	M	
LS-S02-ZB	V8-T1-5	M22-LS	V8-T2-33
LS-S11-120AFT-ZBZ-X	V8-T1-6	MS12A	V8-T2-33
LS-S11-120AMT-ZBZ-X	V8-T1-6	MS12A5	V8-T2-33
LS-S11-24DFT-ZBZ-X	V8-T1-6		
LS-S11-24DMT-ZBZ-X	V8-T1-6	P	
LS-S11S-L	V8-T2-23	PS256A-01B1	V8-T6-7, V8-T6-19, V8-T6-29
LS-S11S-LA	V8-T2-23	PS256A-04B1	V8-T6-19, V8-T6-29
LS-S11S-LB	V8-T2-23	PS256B-01B1	V8-T6-26
LS-S11S-LS	V8-T2-23	PS256B-05B1	V8-T6-26
LS-S11S-OR	V8-T2-25		
LS-S11S-P	V8-T2-23	Q	
LS-S11S-RL	V8-T2-23	QD256A12-1201B1	V8-T6-18
LS-S11S-RLA	V8-T2-24	QD256A12-1204B1	V8-T6-18
LS-S11S-RLA30	V8-T2-24	QD266A12-1201B1	V8-T6-16
LS-S11S-RLA40	V8-T2-24	QD266A12-1204B1	V8-T6-16

Appendix 3

Catalog Number Index

QD266A24-2404B1 V8-T6-16
QD266A36-3604B1 V8-T6-16
QDJU266A-01B1 V8-T6-8, V8-T6-19

R

RS2-02-C3 V8-T1-16
RS2-02-C10 V8-T1-16
RS2-02-Q4 V8-T1-16
RS2-02-Q4-SWD V8-T1-16
RS2-11-C3 V8-T1-16
RS2-11-C10 V8-T1-16
RS2-11-Q4 V8-T1-16
RS2-11-Q4-SWD V8-T1-16
RS2-12-C3 V8-T1-16
RS2-12-C10 V8-T1-16
RS2-12-Q6 V8-T1-16
RS2R-02-C3 V8-T1-17
RS2R-02-Q4 V8-T1-17
RS2R-02-Q4-SWD V8-T1-17
RS2R-11-C3 V8-T1-17
RS2R-11-Q4 V8-T1-17
RS2R-11-Q4-SWD V8-T1-17
RS2R-12-C3 V8-T1-17
RS2R-12-Q6 V8-T1-17
RS4-02-Q4 V8-T1-17
RS4-02-Q4-SWD V8-T1-17
RS4-12-Q6 V8-T1-17

V

V1-2-M20 V8-T2-33
V1-2-M20-NA V8-T2-33

Numerics

10316H1002 V8-T2-93
10316H1004 V8-T2-94
10316H1006 V8-T2-94
10316H1007 V8-T2-93
10316H1009 V8-T2-94
10316H1028 V8-T2-98
10316H1029 V8-T2-98
10316H1039 V8-T2-93
10316H1049 V8-T2-93
10316H1059 V8-T2-93
10316H1071 V8-T2-93
10316H1072 V8-T2-93
10316H110 V8-T2-98
10316H113 V8-T2-98
10316H1146 V8-T2-93
10316H119 V8-T2-98
10316H1191 V8-T2-94
10316H1192 V8-T2-93
10316H1193 V8-T2-94
10316H1194 V8-T2-93
10316H1212 V8-T2-94
10316H1213 V8-T2-93
10316H122 V8-T2-98
10316H1237 V8-T2-94
10316H143 V8-T2-98
10316H144 V8-T2-98

10316H145 V8-T2-98
10316H146 V8-T2-98
10316H147 V8-T2-98
10316H148 V8-T2-98
10316H150 V8-T2-98
10316H1580 V8-T2-98
10316H1600 V8-T2-98
10316H1610 V8-T2-98
10316H1630 V8-T2-98
10316H18 V8-T2-97
10316H187 V8-T2-90
10316H2000 V8-T2-98
10316H2006 V8-T2-98
10316H2012 V8-T2-98
10316H2042 V8-T2-98
10316H2140 V8-T2-93
10316H2149 V8-T2-93
10316H2159 V8-T2-93
10316H2160 V8-T2-93
10316H2168 V8-T2-93
10316H2170 V8-T2-94
10316H2176 V8-T2-93
10316H2178 V8-T2-93
10316H2179 V8-T2-93
10316H2188 V8-T2-94
10316H2197 V8-T2-93
10316H2200 V8-T2-93
10316H281 V8-T2-90
10316H283 V8-T2-90
10316H284 V8-T2-90
10316H285 V8-T2-90
10316H296 V8-T2-90
10316H299 V8-T2-90
10316H320 V8-T2-97
10316H341 V8-T2-90
10316H484 V8-T2-90
10316H50 V8-T2-97
10316H54 V8-T2-97
10316H577 V8-T2-90
10316H621 V8-T2-90
10316H700 V8-T2-90
10316H701 V8-T2-90
10316H828 V8-T2-98
10316H829A V8-T2-98
10316H89 V8-T2-98
11100A6513 V8-T5-56
11100A6517 V8-T5-56
11100AQD03 V8-T5-56
11100AQD07 V8-T5-56
11100R6513 V8-T5-56
11100R6517 V8-T5-56
11100RQD03 V8-T5-56
11100RQD07 V8-T5-56
11102A6513 V8-T5-56
11102A6517 V8-T5-56
11102AQD03 V8-T5-56
11102AQD07 V8-T5-56
11155AA04 V8-T5-70
11155AA07 V8-T5-70

11155AA14	V8-T5-70	1250B-6502	See Tab 11
11155AA17	V8-T5-70	1250B-6507	See Tab 11
11155RA04	V8-T5-70	1250B-6511	See Tab 11
11155RA07	V8-T5-70	1250B-6512	See Tab 11
11155RA14	V8-T5-70	1250B-6517	See Tab 11
11155RA17	V8-T5-70	1250E-6503	V8-T5-10
1141D-6501	See Tab 11	1250E-6504	V8-T5-10
1150E-6504	V8-T5-10	1250E-6507	V8-T5-10
1150E-6507	V8-T5-10	1250E-6513	V8-T5-10
1150E-6513	V8-T5-10	1250E-6514	V8-T5-10
1150E-6517	V8-T5-10	1250E-6517	V8-T5-10
1150E-6534	V8-T5-10	1250E-6533	V8-T5-10
1150E-6537	V8-T5-10	1250E-6534	V8-T5-10
1150E-6543	V8-T5-10	1250E-6537	V8-T5-10
1150E-6547	V8-T5-10	1250E-6547	V8-T5-10
1151E-6504	V8-T5-11	1250E-8503	V8-T5-10
1151E-6507	V8-T5-11	1250E-8504	V8-T5-10
1151E-6513	V8-T5-11	1250E-8507	V8-T5-10
1151E-6517	V8-T5-11	1250E-8514	V8-T5-10
1151E-6534	V8-T5-11	1250E-8517	V8-T5-10
1151E-6537	V8-T5-11	1250E-8533	V8-T5-10
1151E-6543	V8-T5-11	1250E-8534	V8-T5-10
1151E-6547	V8-T5-11	1250E-8537	V8-T5-10
1155A-6501	See Tab 11	1250E-8543	V8-T5-10
1155A-6502	See Tab 11	1250E-8547	V8-T5-10
1155A-6507	See Tab 11	1251B-6501	See Tab 11
1155A-6511	See Tab 11	1251B-6502	See Tab 11
1155A-6512	See Tab 11	1251B-6507	See Tab 11
1155A-6517	See Tab 11	1251B-6511	See Tab 11
1170A-300	See Tab 11	1251B-6512	See Tab 11
1173A-100	See Tab 11	1251B-6517	See Tab 11
1173A-200	See Tab 11	1251E-6503	V8-T5-11
1173A-300	See Tab 11	1251E-6504	V8-T5-11
1179A-6501	See Tab 11	1251E-6507	V8-T5-11
12100A6513	V8-T5-56	1251E-6513	V8-T5-11
12100A6517	V8-T5-56	1251E-6514	V8-T5-11
12100AQD03	V8-T5-56	1251E-6517	V8-T5-11
12100AQD07	V8-T5-56	1251E-6533	V8-T5-11
12100R6513	V8-T5-56	1251E-6534	V8-T5-11
12100R6517	V8-T5-56	1251E-6537	V8-T5-11
12100RQD03	V8-T5-56	1251E-6543	V8-T5-11
12100RQD07	V8-T5-56	1251E-6547	V8-T5-11
12102A6513	V8-T5-56	1251E-8503	V8-T5-11
12102A6517	V8-T5-56	1251E-8504	V8-T5-11
12102AQD03	V8-T5-56	1251E-8507	V8-T5-11
12102AQD07	V8-T5-56	1251E-8513	V8-T5-11
12155AD04	V8-T5-70	1251E-8514	V8-T5-11
12155AD07	V8-T5-70	1251E-8517	V8-T5-11
12155AD10	V8-T5-70	1251E-8533	V8-T5-11
12155AL04	V8-T5-70	1251E-8534	V8-T5-11
12155AL07	V8-T5-70	1251E-8537	V8-T5-11
12155AL10	V8-T5-70	1251E-8543	V8-T5-11
12155RD04	V8-T5-70	1251E-8547	V8-T5-11
12155RD07	V8-T5-70	1270A-300	See Tab 11
12155RD10	V8-T5-70	1273A-100	See Tab 11
12155RL04	V8-T5-70	1273A-200	See Tab 11
12155RL07	V8-T5-70	1273A-300	See Tab 11
12155RL10	V8-T5-70	1279A-6501	See Tab 11
1241D-6501	See Tab 11	13100A6513	V8-T5-58
1250B-6501	See Tab 11	13100A6517	V8-T5-58

Appendix 3

Catalog Number Index

13100AQD03	V8-T5-58	13107ASQD07	V8-T5-58
13100AQD07	V8-T5-58	13107RS6513	V8-T5-58
13100R6513	V8-T5-58	13107RS6517	V8-T5-58
13100R6517	V8-T5-58	13107RSQD03	V8-T5-58
13100RQD03	V8-T5-58	13107RSQD07	V8-T5-58
13100RQD07	V8-T5-58	13108A6513	V8-T5-59
13101A6513	V8-T5-59	13108A6517	V8-T5-59
13101A6517	V8-T5-59	13108AQD03	V8-T5-59
13101AQD03	V8-T5-59	13108AQD07	V8-T5-59
13101AQD07	V8-T5-59	13108R6513	V8-T5-60
13101AS6515	V8-T5-59	13108R6517	V8-T5-60
13101ASQD05	V8-T5-59	13108RQD03	V8-T5-60
13101ASQD25	V8-T5-59	13108RQD07	V8-T5-60
13101RS6515	V8-T5-59	13150AD04	V8-T5-71
13101RSQD05	V8-T5-59	13150AD07	V8-T5-71
13102A6513	V8-T5-58	13150AD14	V8-T5-71
13102A6517	V8-T5-58	13150AD17	V8-T5-71
13102AQD03	V8-T5-58	13150AL04	V8-T5-71
13102AQD07	V8-T5-58	13150AL07	V8-T5-71
13103A6513	V8-T5-59	13150AL14	V8-T5-71
13103A6517	V8-T5-59	13150AL17	V8-T5-71
13103AQD03	V8-T5-59	13150RD04	V8-T5-71
13103AQD07	V8-T5-59	13150RD07	V8-T5-71
13103R6513	V8-T5-60	13150RD14	V8-T5-71
13103R6517	V8-T5-60	13150RD17	V8-T5-71
13103RQD03	V8-T5-60	13150RL04	V8-T5-71
13103RQD07	V8-T5-60	13150RL07	V8-T5-71
13104A6513	V8-T5-59	13150RL14	V8-T5-71
13104A6515	V8-T5-59	13150RL17	V8-T5-71
13104A6517	V8-T5-59	13156RD07B1	V8-T5-79
13104AQD03	V8-T5-59	13156RD17B1	V8-T5-79
13104AQD05	V8-T5-59	13156RL07B1	V8-T5-79
13104AQD07	V8-T5-59	13156RL17B1	V8-T5-79
13104AQD25	V8-T5-59	13157RD07B1	V8-T5-79
13104R6513	V8-T5-60	13157RD17B1	V8-T5-79
13104R6515	V8-T5-59	13157RL07B1	V8-T5-79
13104R6517	V8-T5-60	13157RL17B1	V8-T5-79
13104RQD03	V8-T5-60	1320B-6501	See Tab 11
13104RQD05	V8-T5-59	1321B-6501	See Tab 11
13104RQD07	V8-T5-60	1350B-6501	See Tab 11
13104RQD25	V8-T5-59	1350B-6502	See Tab 11
13104RS5003	V8-T5-60	1350B-6507	See Tab 11
13104RS5007	V8-T5-60	1350B-6511	See Tab 11
13104RS5013	V8-T5-60	1350B-6512	See Tab 11
13104RS5020	V8-T5-60	1350B-6517	See Tab 11
13105A6513	V8-T5-60	1350E-6503	V8-T5-14
13105A6517	V8-T5-60	1350E-6504	V8-T5-14
13105AQD03	V8-T5-60	1350E-6507	V8-T5-14
13105AQD07	V8-T5-60	1350E-6513	V8-T5-14
13106A6513	V8-T5-58	1350E-6514	V8-T5-14
13106A6517	V8-T5-58	1350E-6517	V8-T5-14
13106AQD03	V8-T5-58	1350E-6533	V8-T5-14
13106AQD07	V8-T5-58	1350E-6534	V8-T5-14
13106R6513	V8-T5-58	1350E-6537	V8-T5-14
13106R6517	V8-T5-58	1350E-6543	V8-T5-14
13106RQD03	V8-T5-58	1350E-6547	V8-T5-14
13106RQD07	V8-T5-58	1350E-8503	V8-T5-14
13107AS6513	V8-T5-58	1350E-8504	V8-T5-14
13107AS6517	V8-T5-58	1350E-8507	V8-T5-14
13107ASQD03	V8-T5-58	1350E-8513	V8-T5-14

1350E-8514	V8-T5-14	1357RD6513	See Tab 11
1350E-8517	V8-T5-14	1370A-6501	See Tab 11
1350E-8533	V8-T5-14	1372A-6501	See Tab 11
1350E-8534	V8-T5-14	1380B-6501	See Tab 11
1350E-8537	V8-T5-14	1381B-6501	See Tab 11
1350E-8543	V8-T5-14	1382B-6501	See Tab 11
1350E-8547	V8-T5-14	1383B-6501	See Tab 11
1351B-6501	See Tab 11	1383R-6501	See Tab 11
1351B-6502	See Tab 11	1384B-6501	See Tab 11
1351B-6507	See Tab 11	14100A6513	V8-T5-57
1351B-6511	See Tab 11	14100A6517	V8-T5-57
1351B-6512	See Tab 11	14100AQD03	V8-T5-57
1351B-6517	See Tab 11	14100AQD07	V8-T5-57
1351E-6503	V8-T5-15	14101A6513	V8-T5-57
1351E-6504	V8-T5-15	14101A6517	V8-T5-57
1351E-6507	V8-T5-15	14101AQD03	V8-T5-57
1351E-6513	V8-T5-15	14101AQD07	V8-T5-57
1351E-6514	V8-T5-15	14101AS6515	V8-T5-57
1351E-6517	V8-T5-15	14101ASQD05	V8-T5-57
1351E-6533	V8-T5-15	14101R6513	V8-T5-57
1351E-6534	V8-T5-15	14101R6517	V8-T5-57
1351E-6537	V8-T5-15	14101RQD03	V8-T5-57
1351E-6543	V8-T5-15	14101RQD07	V8-T5-57
1351E-6547	V8-T5-15	14102A6513	V8-T5-57
1351E-8503	V8-T5-15	14102A6517	V8-T5-57
1351E-8504	V8-T5-15	14102AQD03	V8-T5-57
1351E-8507	V8-T5-15	14102AQD07	V8-T5-57
1351E-8513	V8-T5-15	14102AS6515	V8-T5-57
1351E-8514	V8-T5-15	14102ASQD05	V8-T5-57
1351E-8517	V8-T5-15	14102R6513	V8-T5-57
1351E-8533	V8-T5-15	14102R6517	V8-T5-57
1351E-8534	V8-T5-15	14102RQD03	V8-T5-57
1351E-8537	V8-T5-15	14102RQD07	V8-T5-57
1351E-8543	V8-T5-15	1410B-6501	See Tab 11
1351E-8547	V8-T5-15	1410B-6502	See Tab 11
1352B-6501	See Tab 11	1411D-6501	See Tab 11
1352B-6507	See Tab 11	1411D-6502	See Tab 11
1352B-6511	See Tab 11	1411R-6501	See Tab 11
1352B-6517	See Tab 11	1411R-6502	See Tab 11
1355A-6507	See Tab 11	14150AD04	V8-T5-71
1355A-6517	See Tab 11	14150AD07	V8-T5-71
1355AD6507	See Tab 11	14150AD14	V8-T5-71
1355AD6517	See Tab 11	14150AD17	V8-T5-71
1356A-6507	See Tab 11	14150AL04	V8-T5-71
1356A-6517	See Tab 11	14150AL07	V8-T5-71
1356AD6507	See Tab 11	14150AL14	V8-T5-71
1356AD6517	See Tab 11	14150AL17	V8-T5-71
1356R-6503	See Tab 11	14150RD04	V8-T5-71
1356RD6503	See Tab 11	14150RD07	V8-T5-71
1357A-6503	See Tab 11	14150RD14	V8-T5-71
1357A-6507	See Tab 11	14150RD17	V8-T5-71
1357A-6513	See Tab 11	14150RL04	V8-T5-71
1357A-6517	See Tab 11	14150RL07	V8-T5-71
1357AD6503	See Tab 11	14150RL14	V8-T5-71
1357AD6507	See Tab 11	14150RL17	V8-T5-71
1357AD6513	See Tab 11	14151AD04	V8-T5-71
1357AD6517	See Tab 11	14151AD07	V8-T5-71
1357R-6503	See Tab 11	14151AD14	V8-T5-71
1357R-6513	See Tab 11	14151AD17	V8-T5-71
1357RD6503	See Tab 11	14151AL04	V8-T5-71

Appendix 3

Catalog Number Index

14151AL07	V8-T5-71	1450E-8503	V8-T5-12
14151AL14	V8-T5-71	1450E-8504	V8-T5-12
14151AL17	V8-T5-71	1450E-8507	V8-T5-12
14151RD04	V8-T5-71	1450E-8513	V8-T5-12
14151RD07	V8-T5-71	1450E-8514	V8-T5-12
14151RD14	V8-T5-71	1450E-8517	V8-T5-12
14151RD17	V8-T5-71	1450E-8533	V8-T5-12
14151RL04	V8-T5-71	1450E-8534	V8-T5-12
14151RL07	V8-T5-71	1450E-8537	V8-T5-12
14151RL14	V8-T5-71	1450E-8543	V8-T5-12
14151RL17	V8-T5-71	1450E-8547	V8-T5-12
14156AD07B1	V8-T5-79	1451B-6501	See Tab 11
14156AD17B1	V8-T5-79	1451B-6502	See Tab 11
14156AL07B1	V8-T5-79	1451B-6507	See Tab 11
14156AL17B1	V8-T5-79	1451B-6511	See Tab 11
14156RD07B1	V8-T5-79	1451B-6512	See Tab 11
14156RD17B1	V8-T5-79	1451B-6517	See Tab 11
14156RL07B1	V8-T5-79	1451BSC1216	V8-T6-9
14156RL17B1	V8-T5-79	1451BSP1216	V8-T6-9
1420B-6501	See Tab 11	1451BSR1216	V8-T6-9, V8-T6-19
14256RD17B1	V8-T6-18	1451E-6503	V8-T5-13
14256RDN17B1	V8-T6-18	1451E-6504	V8-T5-13
14256RDP17B1	V8-T6-18	1451E-6507	V8-T5-13
14256RL17B1	V8-T6-18	1451E-6513	V8-T5-13
14256RLN17B1	V8-T6-18	1451E-6514	V8-T5-13
14256RLP17B1	V8-T6-18	1451E-6517	V8-T5-13
14266RDN17B1	V8-T6-16	1451E-6533	V8-T5-13
14266RDNT17B1	V8-T6-16	1451E-6534	V8-T5-13
14266RDP17B1	V8-T6-16	1451E-6543	V8-T5-13
14266RDPC17B1	V8-T6-16	1451E-6547	V8-T5-13
14266RLN17B1	V8-T6-16	1451E-8503	V8-T5-13
14266RLNT17B1	V8-T6-16	1451E-8504	V8-T5-13
14266RLP17B1	V8-T6-16	1451E-8507	V8-T5-13
14266RLPC17B1	V8-T6-16	1451E-8513	V8-T5-13
14266RLPT17B1	V8-T6-16	1451E-8514	V8-T5-13
14286RDN17B1	V8-T6-16	1451E-8517	V8-T5-13
14286RDP17B1	V8-T6-16	1451E-8533	V8-T5-13
14286RDPC17B1	V8-T6-16	1451E-8534	V8-T5-13
14286RDPT17B1	V8-T6-16	1451E-8537	V8-T5-13
14286RLN17B1	V8-T6-16	1451E-8543	V8-T5-13
14286RLNT17B1	V8-T6-16	1451E-8547	V8-T5-13
14286RLP17B1	V8-T6-16	1452E-6503	V8-T5-16
14286RLPC17B1	V8-T6-16	1452E-6504	V8-T5-16
14286RLPT17B1	V8-T6-16	1452E-6507	V8-T5-16
1450B-6501	See Tab 11	1452E-6513	V8-T5-16
1450B-6502	See Tab 11	1452E-6514	V8-T5-16
1450B-6507	See Tab 11	1452E-6517	V8-T5-16
1450B-6511	See Tab 11	1452E-6533	V8-T5-16
1450B-6512	See Tab 11	1452E-6534	V8-T5-16
1450B-6517	See Tab 11	1452E-6537	V8-T5-16
1450E-6503	V8-T5-12	1452E-6543	V8-T5-16
1450E-6504	V8-T5-12	1452E-6547	V8-T5-16
1450E-6507	V8-T5-12	1452E-8503	V8-T5-16
1450E-6513	V8-T5-12	1452E-8504	V8-T5-16
1450E-6517	V8-T5-12	1452E-8507	V8-T5-16
1450E-6533	V8-T5-12	1452E-8513	V8-T5-16
1450E-6534	V8-T5-12	1452E-8514	V8-T5-16
1450E-6537	V8-T5-12	1452E-8517	V8-T5-16
1450E-6543	V8-T5-12	1452E-8533	V8-T5-16
1450E-6547	V8-T5-12	1452E-8534	V8-T5-16

1452E-8537	V8-T5-16	1555AD6517	See Tab 11
1452E-8543	V8-T5-16	1555R-6503	See Tab 11
1452E-8547	V8-T5-16	1555R-6513	See Tab 11
1470A-6501	See Tab 11	1555RD6503	See Tab 11
1471A-6501	See Tab 11	1555RD6513	See Tab 11
1480B-6501	See Tab 11	1571A-6501	See Tab 11
1480R-6501	See Tab 11	1580B-6501	See Tab 11
15100A6513	V8-T5-61	6142A-6501	V8-T8-7
15100A6517	V8-T5-61	6143A-6501	V8-T8-7
15100AQD03	V8-T5-61	6150E-6501	V8-T5-21
15100AQD07	V8-T5-61	6150E-6502	V8-T5-21
1550E	V8-T5-17	6150E-6503	V8-T5-21
1550E-6503	V8-T5-17	6161A-6501	V8-T8-6
1550E-6504	V8-T5-17	6161AS0285	V8-T6-9
1550E-6507	V8-T5-17	6161AS5295	V8-T8-6
1550E-6513	V8-T5-17	6161AS5296	V8-T5-62, V8-T5-72, V8-T5-80
1550E-6514	V8-T5-17	6161AS5297	V8-T5-62, V8-T5-72, V8-T5-80
1550E-6517	V8-T5-17	6161AS6501	V8-T5-38, V8-T8-6
1550E-6533	V8-T5-17	6161AS7050	V8-T8-6
1550E-6534	V8-T5-17	6167A-6501	V8-T8-6
1550E-6537	V8-T5-17	6168A-6501	V8-T8-7
1550E-6543	V8-T5-17	6181AS5200	V8-T5-38, V8-T5-63, V8-T5-72, V8-T5-80
1550E-6547	V8-T5-17	6200A-6501	V8-T8-3
1550E-8503	V8-T5-17	6200A-6502	V8-T8-3
1550E-8504	V8-T5-17	6200A-6504	V8-T8-3
1550E-8507	V8-T5-17	6200A-6505	V8-T8-3
1550E-8513	V8-T5-17	6200A-6506	V8-T8-3
1550E-8514	V8-T5-17	6200A-6507	V8-T8-3
1550E-8517	V8-T5-17	6200AS6501	V8-T8-3
1550E-8533	V8-T5-17	6200AS6504	V8-T8-3
1550E-8537	V8-T5-17	6204A-XXXX	V8-T8-3
1550E-8543	V8-T5-17	6210A-6501	See Tab 11
1550E-8547	V8-T5-17	6221A-7501	See Tab 11
1551E-6503	V8-T5-18	6230A-6501	V8-T9-11
1551E-6504	V8-T5-18	6230A-6502	V8-T9-11
1551E-6507	V8-T5-18	6230A-6503	V8-T9-4
1551E-6513	V8-T5-18	6230A-6505	V8-T9-4
1551E-6514	V8-T5-18	6230A-6508	V8-T9-4
1551E-6517	V8-T5-18	6230A-6509	V8-T9-4
1551E-6533	V8-T5-18	6235A-6501	V8-T5-61, V8-T5-71
1551E-6534	V8-T5-18	6276A-6501	See Tab 11
1551E-6537	V8-T5-18	6323A-6501	V8-T9-3
1551E-6543	V8-T5-18	6323A-6502	V8-T9-3
1551E-6547	V8-T5-18	6323A-6511	V8-T9-3
1551E-8503	V8-T5-18	6323A-6512	V8-T9-3
1551E-8504	V8-T5-18	6323A-XXX	V8-T9-3
1551E-8507	V8-T5-18	6323E-6501	V8-T5-20, V8-T9-3
1551E-8513	V8-T5-18	6323E-6502	V8-T5-20
1551E-8517	V8-T5-18	6324A-6501	V8-T9-3
1551E-8533	V8-T5-18	6324A-6502	V8-T9-3
1551E-8534	V8-T5-18	6324A-6511	V8-T9-3
1551E-8537	V8-T5-18	6324A-6512	V8-T9-3
1551E-8543	V8-T5-18	6324A-XXX	V8-T9-3
1555A-6503	See Tab 11	6324E-6501	V8-T5-20, V8-T9-3
1555A-6507	See Tab 11	6324E-6502	V8-T5-20
1555A-6513	See Tab 11	8170A-6501	See Tab 11
1555A-6517	See Tab 11	8170A-6502	See Tab 11
1555AD6503	See Tab 11	8170A-6504	See Tab 11
1555AD6507	See Tab 11	8170A-6505	See Tab 11
1555AD6513	See Tab 11	8171B-6501	See Tab 11

Appendix 3

Catalog Number Index

8171B-6502	See Tab 11	8580A-6501	See Tab 11
8172A-6501	See Tab 11	8582A-6501	See Tab 11
8172A-6502	See Tab 11	8586A-6501	See Tab 11
8173A-6507	See Tab 11	8771A-6501	See Tab 11
8211B-6501	See Tab 11	8772A-6501	See Tab 11
8212B-6501	See Tab 11	8880C-6501	See Tab 11
8213B-6501	See Tab 11	8880C-6502	See Tab 11
8216A-6501	See Tab 11	8881C-6501	See Tab 11
8280A-6501	See Tab 11	8881C-6502	See Tab 11
8281A-6501	See Tab 11	8882B-6501	See Tab 11
8282A-6501	See Tab 11	8884C-6501	See Tab 11
8526A-6501	See Tab 11	8884C-6502	See Tab 11
8530A-6501	See Tab 11	8909A-6501	V8- T9 -4
8570A-6501	See Tab 11	9072A-6501	See Tab 11
8572A-6501	See Tab 11	9082A-6501	See Tab 11
8573A-6501	See Tab 11	9902A-6501	V8- T8 -10
8574A-6501	See Tab 11	9902A-6502	V8- T8 -10

X-ON Electronics

Largest Supplier of Electrical and Electronic Components

Click to view similar products for [Proximity Sensors](#) category:

Click to view products by [Eaton](#) manufacturer:

Other Similar products are found below :

[01.001.5653.1](#) [70.340.1028.0](#) [70.360.2428.0](#) [70.364.4828.0](#) [70.810.1053.0](#) [72.360.1628.0](#) [73.363.6428.0](#) [8027AL20NL2CPXX](#) [FYCC8E1-2](#)
[9221350022](#) [922AA2W-A9P-L](#) [PLS2](#) [GL-12F-C2.5X10\(LOT3\)](#) [972AB2XM-A3N-L](#) [972AB3XM-A3P-L](#) [PS3251](#) [980659-1](#) [QT-12](#) [E2E2-](#)
[X5M41-M4](#) [E2E-X14MD1-G](#) [E2E-X2D1-G](#) [E2EX2ME2N](#) [E2EX3D1SM1N](#) [E2E-X4MD1-G](#) [E2E-X5E1-5M-N](#) [E2E-X5Y2-N](#) [E2E-X7D1-](#)
[M1J-T-0.3M-N](#) [E2K-F10MC1](#) [5M](#) [EH-302](#) [EI3010TBOP](#) [EI5515NPAP](#) [MS605AU](#) [EP175-32000](#) [IFRM04N35B1/L](#) [IFRM04P1513/S35L](#)
[IFRM06P1703/S35L](#) [IFRM08P1501/S35L](#) [IFRM12N17G3/L](#) [IFRM12P17G3/L](#) [IFRM12P3502/L](#) [IFRM12P37G1/S14L](#) [ILFK12E9189/I02](#)
[ILFK12E9193/I02](#) [IMM2582C](#) [OISN-013](#) [25.161.3253.0](#) [25.332.0653.1](#) [25.352.0653.0](#) [25.352.0753.0](#) [25.523.3253.0](#)