

# FP1505

## High frequency, high current power inductors

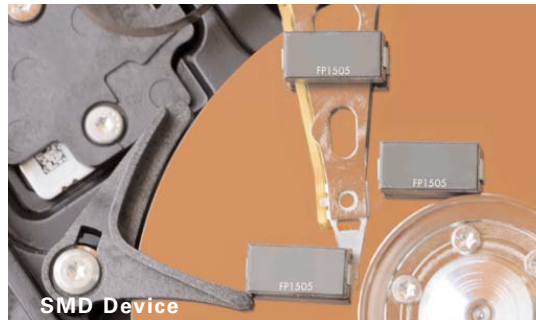

### Product features

- 7.0 x 15.0 x 5.0mm surface mount package
- Ferrite core material
- High current handling capability, low core loss
- Designed for high speed, high current switch mode applications
- Tight DCR tolerance for sensing circuits
- Inductance range from 100 nH to 400 nH
- Current range from 24 A to 105 A
- Frequency range up to 1 MHz

### Applications

- Multi-phase regulators
- Voltage Regulator Module (VRM)
- Desktop and server VRMs and EVRDs
- Data networking and storage systems
- Notebook regulators
- Graphics cards and battery power systems
- Point of load modules
- DCR current sensing

### Environmental data

- Storage temperature range (component):  
-40 °C to +125 °C
- Operating temperature range: -40 °C to +125 °C  
(ambient plus self-temperature rise)
- Solder reflow temperature:  
J-STD-020 (latest revision) compliant



**Product specifications**

Part Number <sup>7</sup>	OCL <sup>1</sup> ± 10% (nH)	FLL <sup>2</sup> Min. (nH)	I <sub>rms</sub> <sup>3</sup> (A)	I <sub>sat1</sub> <sup>4</sup> (A) @+25 °C	I <sub>sat2</sub> <sup>5</sup> (Amps) @+125 °C	DCR (mΩ) @+20 °C	K-factor <sup>6</sup>
FP1505R1-R10-R	100	72	53	105	90	0.47 ± 7%	356.3
FP1505R1-R12-R	120	86		87	75		356.3
FP1505R1-R15-R	150	108		72	60		356.3
FP1505R1-R25-R	250	180		42	32		356.3
FP1505R1-R30-R	300	217		35	26		356.3
FP1505R1-R40-R	400	288		24	19.5		356.3

- Open Circuit Inductance (OCL) Test Parameters: 100 kHz, 1.0 V<sub>rms</sub>, 0.0 Adc
- Full Load Inductance (FLL) Test Parameters: 100 kHz, 1.0 V<sub>rms</sub>, I<sub>sat1</sub>
- I<sub>rms</sub>: DC current for an approximate temperature rise of 40 °C without core loss. Derating is necessary for AC currents. PCB layout, trace thickness and width, air-flow, and proximity of other heat generating components will affect the temperature rise. It is recommended that the temperature of the part not exceed +125 °C under worst case operating conditions verified in the end application.
- I<sub>sat1</sub>: Peak current for approximately 20% rolloff at +25 °C.
- I<sub>sat2</sub>: Peak current for approximately 20% rolloff at +125 °C.
- K-factor: Used to determine B<sub>p-p</sub> for core loss (see graph). B<sub>p-p</sub> = K \* L \* ΔI \* 10<sup>-3</sup>. B<sub>p-p</sub>:(Gauss), K: (K-factor from table), L: (Inductance in nH), ΔI (Peak-to-peak ripple current in amps).
- Part Number Definition: FP1505Rx-Rxx-R
  - FP1505 = Product code and size
  - Rx= DCR indicator
  - Rxx= Inductance value in uH, R = decimal point
  - R suffix = RoHS compliant

**Dimensions- mm**

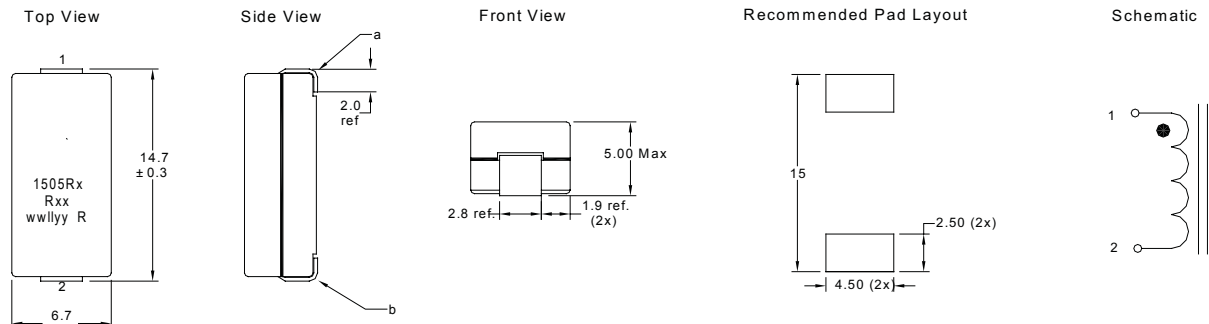

The nominal DCR is measured between points "a" and "b"

Part Marking: 1505Rx Rx = DCR indicator Rxx = Inductance value in μH. (R = Decimal point). wwllly = Date code R = Revision level

Do not route traces or vias underneath the inductor

**Packaging information - mm**

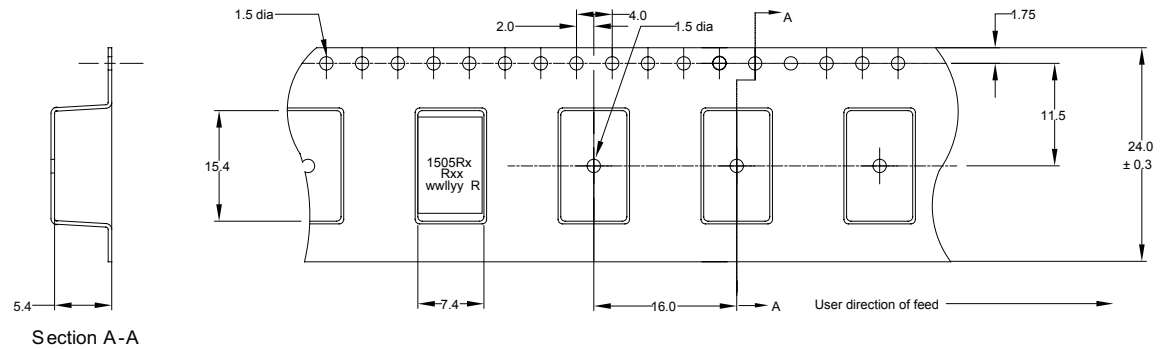

Supplied in tape-and-reel packaging, 744 parts per reel, 13" diameter reel.

**Temperature rise vs total loss**

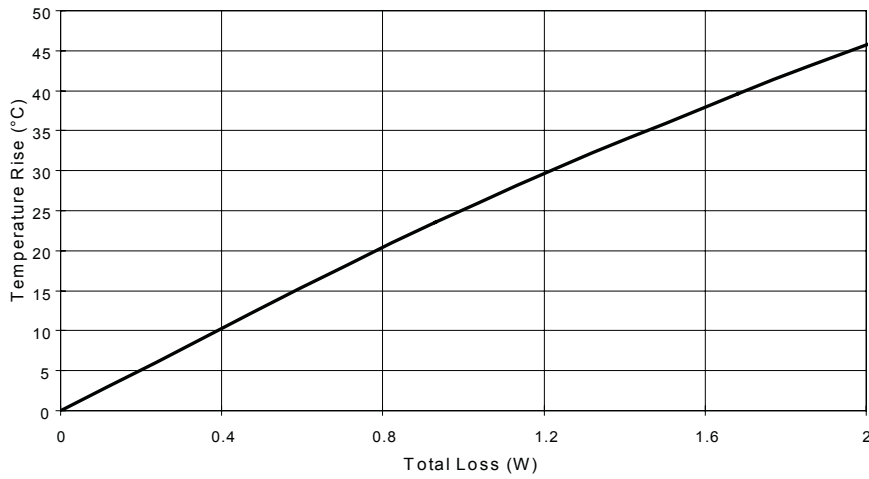

**Core loss vs Bp-p**

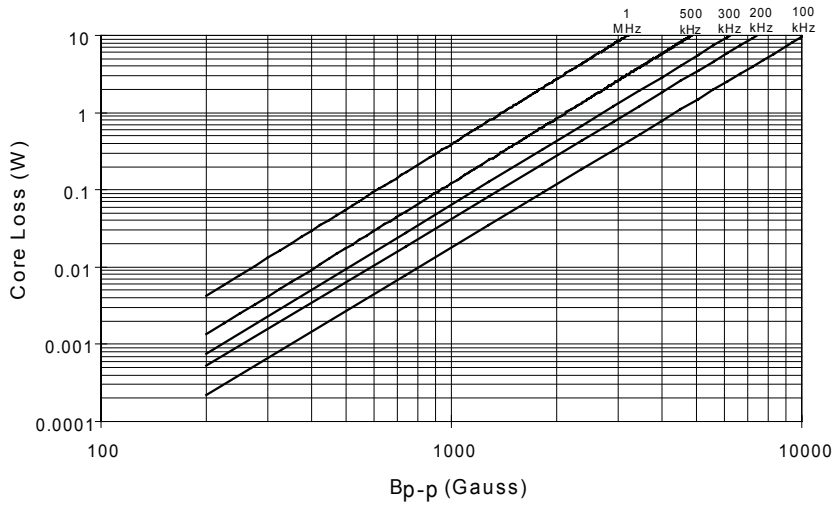

**Inductance characteristics**

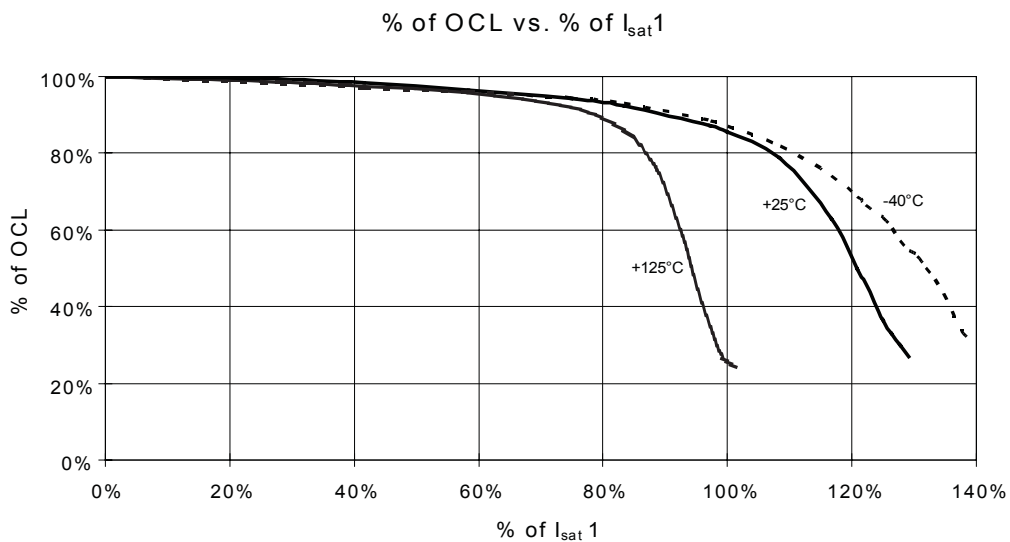

### Solder Reflow Profile

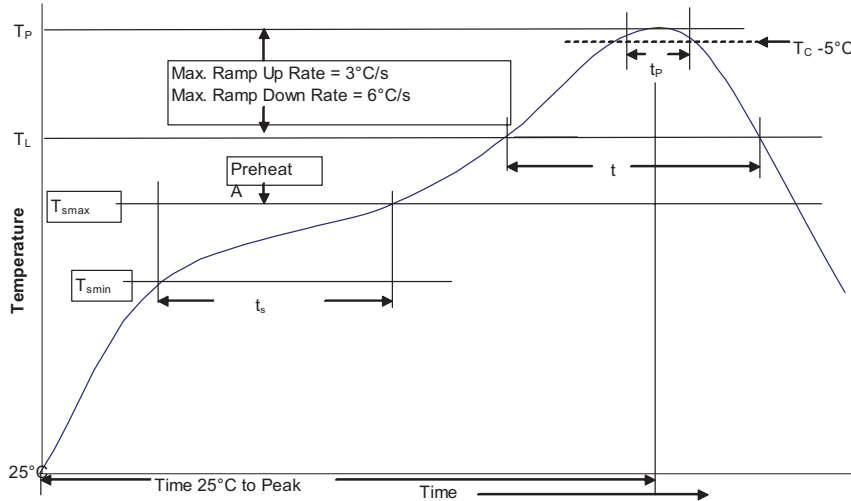

Table 1 - Standard SnPb Solder ( $T_C$ )

Package Thickness	Volume $\text{mm}^3$ <350	Volume $\text{mm}^3$ $\geq 350$
<2.5mm	235°C	220°C
$\geq 2.5\text{mm}$	220°C	220°C

Table 2 - Lead (Pb) Free Solder ( $T_C$ )

Package Thickness	Volume $\text{mm}^3$ <350	Volume $\text{mm}^3$ 350 - 2000	Volume $\text{mm}^3$ >2000
<1.6mm	260°C	260°C	260°C
1.6 - 2.5mm	260°C	250°C	245°C
>2.5mm	250°C	245°C	245°C

### Reference JDEC J-STD-020

Profile Feature	Standard SnPb Solder	Lead (Pb) Free Solder
Preheat and Soak	• Temperature min. ( $T_{smin}$ )	100°C
	• Temperature max. ( $T_{smax}$ )	150°C
	• Time ( $T_{smin}$ to $T_{smax}$ ) ( $t_s$ )	60-120 Seconds
Average ramp up rate $T_{smax}$ to $T_P$	3°C/ Second Max.	3°C/ Second Max.
Liquidous temperature ( $T_L$ )	183°C	217°C
Time at liquidous ( $t_L$ )	60-150 Seconds	60-150 Seconds
Peak package body temperature ( $T_P$ )*	Table 1	Table 2
Time ( $t_p$ )** within 5 °C of the specified classification temperature ( $T_C$ )	20 Seconds**	30 Seconds**
Average ramp-down rate ( $T_P$ to $T_{smax}$ )	6°C/ Second Max.	6°C/ Second Max.
Time 25°C to Peak Temperature	6 Minutes Max.	8 Minutes Max.

\* Tolerance for peak profile temperature ( $T_P$ ) is defined as a supplier minimum and a user maximum.

\*\* Tolerance for time at peak profile temperature ( $t_p$ ) is defined as a supplier minimum and a user maximum.

Life Support Policy: Eaton does not authorize the use of any of its products for use in life support devices or systems without the express written approval of an officer of the Company. Life support systems are devices which support or sustain life, and whose failure to perform, when properly used in accordance with instructions for use provided in the labeling, can be reasonably expected to result in significant injury to the user.

Eaton reserves the right, without notice, to change design or construction of any products and to discontinue or limit distribution of any products. Eaton also reserves the right to change or update, without notice, any technical information contained in this bulletin.

**Eaton**  
Electronics Division  
1000 Eaton Boulevard  
Cleveland, OH 44122  
United States  
www.eaton.com/electronics

© 2017 Eaton  
All Rights Reserved  
Printed in USA  
Publication No. 4365 BU-SB09350  
July 2017

## X-ON Electronics

Largest Supplier of Electrical and Electronic Components

*Click to view similar products for [Fixed Inductors](#) category:*

*Click to view products by [Eaton](#) manufacturer:*

Other Similar products are found below :

[CR43NP-680KC](#) [CR54NP-820KC](#) [CR54NP-8R5MC](#) [CTX32CT-100](#) [70F224AI](#) [MGDQ4-00004-P](#) [MHL1ECTTP18NJ](#) [MHL1JCTTD12NJ](#)  
[PE-51506NL](#) [PE-53601NL](#) [PE-53602NL](#) [PE-53630NL](#) [PE-53824SNLT](#) [PE-92100NL](#) [PG0434.801NLT](#) [PG0936.113NLT](#) [9310-16](#) [PM06-2N7](#) [PM06-39NJ](#) [A01TK](#) [1206CS-471XJ](#) [HC2-2R2TR](#) [HC2LP-R47-R](#) [HC3-2R2-R](#) [1206CS-151XG](#) [RCH664NP-140L](#) [RCH664NP-4R7M](#)  
[RCH8011NP-221L](#) [RCP1317NP-332L](#) [RCP1317NP-391L](#) [RCR1010NP-470M](#) [RCR110DNP-331L](#) [DH2280-4R7M](#) [DS1608C-106](#) [ASPI-4020HI-R10M-T](#) [B10TJ](#) [B82477P4333M](#) [B82498B3101J000](#) [B82498B3680J000](#) [ELJ-RE27NJF2](#) [1812CS-153XJ](#) [1812CS-183XJ](#) [1812CS-223XJ](#) [1812LS-104XJ](#) [1812LS-105XJ](#) [1812LS-124XJ](#) [1812LS-154XJ](#) [1812LS-223XJ](#) [1812LS-224XJ](#) [1812LS-563XJ](#)