

Molded-Case Circuit Breakers

Molded-Case Circuit Breakers Family



3

Molded-Case Circuit Breakers

Product Description, History, Major Product Introduction	V12-T3-2
General Information	V12-T3-3
Nameplate Data	V12-T3-3
Identifying Factory Original Circuit Breakers	V12-T3-4
Replacement and Upgrade Options	V12-T3-5
Replacement Guides	
Miniature Circuit Breakers	V12-T3-6
Molded-Case Circuit Breakers	V12-T3-10
Replacement Devices	
Circuit Breakers	V12-T3-15
Molded-Case Switches	V12-T3-61
Motor Circuit Protectors	V12-T3-63
Accessories	V12-T3-63
Panelboard Replacement Breakers	V12-T3-80
Replacement Guide	V12-T3-81
Motor Control Center Replacement Breakers	V12-T3-88
Technology Upgrades for Circuit Breakers	V12-T3-91
Handle Mechanisms	V12-T3-95
Replacement and Service Capabilities	V12-T3-112
Cross-Reference	
Westinghouse, Challenger and Bryant Replacements	V12-T3-113
Breaker Replacements	V12-T3-115
Mining Breaker Replacements	V12-T3-162
Pricing Information	V12-T3-168

Molded-Case Circuit Breakers



Molded-Case Circuit Breaker Family

Product Description

Eaton's molded-case circuit breakers are designed to provide circuit protection for low voltage distribution systems. They are described by NEMA® as "... a device for closing and interrupting a circuit between separable contacts under both normal and abnormal conditions," and furthermore as "... a breaker assembled as an integral unit in supporting an enclosed housing of insulating material." The NEC® describes them as "... a device designed to open and close a circuit by non-automatic means, and to open the circuit automatically on a predetermined overload of current, without injury to itself when properly applied within its rating."

Circuit breakers protect against overloads in conductors and protect against short circuits in connected apparatus such as motors and motor starters.

Circuit breakers are designed for use in panelboards, switchboards, motor control centers, control panels, combination starters, individual enclosures and bus duct plug-in units.

Product History

Originally a Westinghouse Product

The need for molded-case circuit breakers came about in 1918 when numerous applications for electrical motors resulted in a demand for a device that would ensure safe operation and, at the same time, protect electrical circuits.

During this period, individual motors were used for the first time in industrial plants to operate machine tools and in private homes to operate appliances. Plant electricians were constantly changing fuses blown during motor startups because of the lack of properly designed fuses for motor circuit protection. Homes experienced similar problems when electrical circuits were overloaded. Inspectors were concerned about fire hazards because of plug fuses being bridged with pennies and the installation of fuses with too high an ampere rating.

Inspection authorities became involved and

attempted to find a solution to the problem. Meetings with switch manufacturers were initiated in an effort to find a solution. Switch manufacturers were asked to develop a switching device that would interrupt a circuit under prolonged overload conditions. The device would have to be safe, reliable and tamperproof. It should also be resettable so as to be reusable after an interruption without replacing any parts. This search for better circuit protection resulted in many different but unacceptable approaches to the problem. These early meetings and subsequent efforts prepared the groundwork for the eventual development of the molded-case circuit breaker.

After intensive research and development, Westinghouse produced the DE-ION® arc extinguisher for use in large oil circuit breakers. Although too large in its initial form to be practical for small circuit breakers, the arc extinguisher was eventually modified into a usable size. The first compact, workable circuit breaker was developed in

1923 when the modified arc extinguisher was coupled with a thermal tripping mechanism. It was not until four years later, however, that Westinghouse research engineers found the ideal combination of materials and design that permitted circuit breakers to interrupt fault currents of 5000A at 120 Vac or Vdc. One year later, Westinghouse placed the first circuit breaker on the market. Its acceptance was instantaneous.

Since that initial introduction in 1927, Westinghouse continued to be at the forefront of circuit breaker technology with an unprecedented series of circuit protective enhancements and introductions as chronicled below. In 1994, Eaton, another world-class technology leader, acquired the Westinghouse Distribution and Control Business Unit (DCBU) and integrated it with their Cutler-Hammer business unit forming a powerful, new combination, poised to meet the challenges of the next 100 years.

Time Line—Major Product Introductions

Year	Product	1920	1930	1940	1950	1960	1970	1980	1990	1995	2000	2002	Present
1923	First compact, workable circuit breaker developed by Westinghouse												
1927	Westinghouse introduced the first complete circuit breaker line, rated 10–600A, 600V												
1939	Along with ordering information and style numbers, the various maximum current ratings came to be known by frame designations: 50A E-Frame 100A F-Frame (non-interchangeable trip) 100A G-Frame 225A K-Frame 600A L-Frame												
1970	Motor Circuit Protector (MCP) introduced—first sensitive, low level protection designed specifically for motor circuits												
1973	SELTRONIC™ introduced—first molded-case circuit breaker with an electronic trip unit												
1979	Current Limit-R circuit breaker introduced—first true current limiting trip unit												
1982	Series C® Family introduced—new world-class standard, meeting increasing interrupting requirements without sacrificing compact size												
1994	Westinghouse Distribution and Control Business Unit (DCBU) acquired by Eaton, integrated with Cutler-Hammer (the Cutler-Hammer line of molded case circuit breakers was sold when merged with Westinghouse)												
1995	OPTIM™ Family introduced—first truly programmable molded-case circuit breaker												
2002	Next Generation E125, J250												
2004	Series G® First Global Breaker Line												

Breaker Identification

Nameplate Data

A circuit breaker is identified by data found on the nameplate.

This includes:

- Catalog number
- Shop order number
- Style number
- Amperage
- Number of poles
- Voltage class
- Temperature rating

In most instances, the catalog number, style number or shop order number will supply enough information to identify the circuit breaker.

However, it is always advisable to obtain all data from the nameplate to facilitate identification.

A **Catalog Number** begins with a series of letters followed by numbers that identify:

- Circuit breaker type
- Number of poles
- Maximum amperage
- **Example:** Catalog number F3020 indicates a Type F circuit breaker, three poles, 20A

A **Shop Order Number** begins with one or two numbers followed by a single letter and four additional numbers.

A shop order number is listed in place of a catalog number and indicates that the circuit breaker was modified at the factory, i.e., addition of a shunt trip, special calibration, etc. **Every shop order number must be researched with the factory to properly identify modifications.** Call your Cutler-Hammer Field Sales office for this information.

- **Example:** 70E2121

Note: Eaton does not recommend replacing a circuit breaker identified by a **Shop Order Number** with a standard “off-the-shelf” circuit breaker without first identifying the modifications. **They may be critical to safe and reliable operation.**

Accessories

Most circuit breaker accessories are mounted internally and are not visible with a quick inspection.

However, because many accessories rely on or supply an external signal, there may be electrical leads exiting the circuit breaker case. Inspect for these leads when obtaining full descriptive information for circuit breaker replacement. Examples of common accessories:

Shunt Trip

Used to remotely trip the circuit breaker using an electrical signal. Typically two wires extend through the case.

Undervoltage Release (UVR)

Trips the circuit breaker when voltage drops below a specified percentage of coil voltage (typically 70%). Typically two wires extend through the case.

Auxiliary Switch

Provides remote indication of the circuit breaker status (open/closed). Typically three wires extend through the case in a single-pole 1A/1B application.

Alarm Lockout Switch

For remote indication of an automatic trip operation. Typically two or three wires extend through the case.

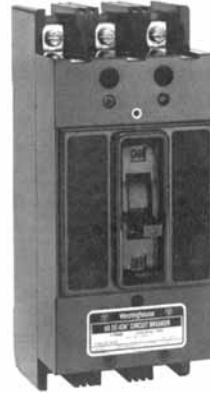

Pre-Series C Breaker with Original Label (Labels updated in 1997)

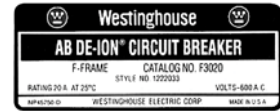

Series C Breaker with Original Label (Labels updated in 1997)



Vintage Label for Typical SELTRONIC Molded-Case Circuit Breaker

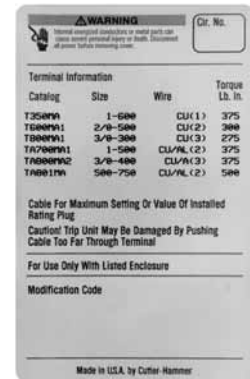

Factory Original Circuit Breakers

Why Insist on Only Genuine, New MCCBs Purchased Through Authorized Distributors?

Eaton defines “New” product as that which has not yet been installed in an electrical circuit, purchased through authorized channels in factory original condition and packaged in unopened Eaton cartons.

- The only way to ensure safe and reliable operation of your system is to use genuine, new, Eaton’s Cutler-Hammer products exclusively. Eaton does not resell the component parts for molded-case circuit breakers, the only way for third-party breaker refurbishers to get parts for the breakers that they are rebuilding is to cannibalize other used breakers or to use counterfeit components. Neither is a very good option for the end user
- In some cases, unauthorized resellers of molded-case circuit breakers have been found to misrepresent used, rebuilt or surplus products. Only products purchased as “new” through authorized channels are covered under the Eaton warranty policy
- There have been instances where third-party refurbishers have rebuilt breakers using the wrong parts, with parts missing or the factory lubrication removed in the cleaning process—any of which may result in devices that may not be depended upon to function properly to protect equipment and personnel

Identifying Genuine, Factory Original Westinghouse Circuit Breakers Manufactured by Eaton

The features on a molded-case circuit breaker that identify it as genuine or counterfeit may or may not be readily apparent. In fact, there may be differences not detectable by an external investigation.

A genuine Eaton brand molded-case circuit breaker manufactured by Eaton will have a serialized bar code unique to the breaker as well as an unbroken seal where the case comes together. This barcode and seal were placed at the factory and ensures the internal integrity of the breaker. If, for any reason the barcode is missing or the seal is broken, do not accept the breaker. (Seal does not appear on interchangeable trip breakers.)



Unbroken Seal

There is a manufacturing date code on the back of genuine molded-case circuit breakers stamped in silver and white. If this coding is missing, it may mean the breaker has been subjected to tampering. Frequently, this date code is wiped off in an attempt to represent the breaker as new.



Manufacturing Date Code

Another way to tell if a breaker has been tampered with is to examine the sealant used to cover the screws on the top rear of the breaker. If the sealant appears sloppy or is missing, it indicates that the unit may have been subjected to tampering.



Sealant Used to Cover Screws

A UL® label on a genuine Westinghouse breaker is either exactly as shown in the photo or is stamped in white ink onto the frame in older pre-Series C breakers. Anything other than this may indicate fraud.

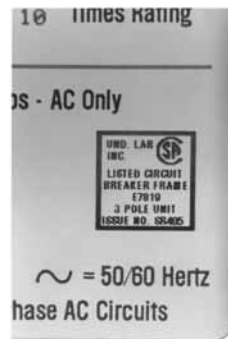

UL Label

If front cover screw shows marks from use, someone has attempted to open the breaker. The front covers are either black or gray on genuine Westinghouse molded-case circuit breakers.



Front Cover Screws

Westinghouse molded-case circuit breakers manufactured by Eaton are packed individually and shipped in Eaton labeled cartons. Anything other than this is not to be considered new and should be suspect.

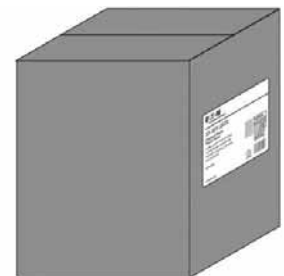

Eaton Labeled Cartons

Replacement Capabilities Series C and Series G Molded-Case Circuit Breakers

When and Where to Use

- Generally a first choice wherever physically and electrically practical
- Where communications, arc flash protection, energy and power quality monitoring are desired
- As a direct replacement or add-on to already installed Series C or Series G product, including Westinghouse breakers (see **Page V12-T3-114**)
- For special applications such as DC engine generator

Advantages

- The most current molded-case circuit breaker technology
- Higher interrupting capacities in each frame size
- Smaller and lighter for a given frame size than other options
- Generally less expensive than other replacement breaker options
- Readily available throughout range, high levels of stock
- Available from stock
- One-year warranty

Current Production Replacement Circuit Breakers

When and Where to Use

- As a direct, one-for-one replacement of current production pre-Series C product
- Where you know the catalog/style number but not the physical or electrical specifics about the application

Advantages

- Ease of selection and certainty of replacement
- Guaranteed to be both a physical and electrical duplicate of original
- Still in production
- Newly manufactured
- UL listed
- Available from stock
- One-year warranty

Replacement of Current Panelboard Molded-Case Circuit Breakers

When and Where to Use

- When replacing Series C circuit breakers in a current design panelboard

Advantages

- Newly manufactured and tested to the latest technology
- UL Listed
- Available from stock in most frame sizes
- One-year warranty. Refer to **Page V12-T3-91** for Series C connector kits

Replacement of Out-of-Production Panelboard Molded-Case Circuit Breakers (Including Westinghouse)

When and Where to Use

- When replacing out-of-production circuit breakers in an existing panelboard
- When replacing Westinghouse breakers. Refer to **Pages V12-T3-81–V12-T3-90** and **Page V12-T3-114**

Advantages

- Newly manufactured and tested to the latest applicable standards
- Both physically and electrically interchangeable with the circuit breakers that they are designed to replace
- UL Listed
- Available from stock in most frame sizes
- One-year warranty

Replacement of Out-of-Production Motor Control Center Molded-Case Circuit Breakers and Upgrades

When and Where to Use

- When replacing out-of-production circuit breakers in an existing motor control center: 5 Star, Type W and F10 designs
- When upgrading Westinghouse breakers with a Series C technology upgrade breaker

Advantages

- Newly manufactured and tested to the latest technology
- Series C retrofit kits are physically and electrically interchangeable with the circuit breakers that they are designed to replace
- UL Listed
- Available from stock in most frame sizes
- One-year warranty. Refer to **Page V12-T3-91**

Contact: 1-800-OLD-UNIT.

Service for Molded-Case Circuit Breakers

When and Where to Use

- Where circuit breaker has sustained minor physical damage to a handle, lug, etc., that otherwise would be fully functional
- Large frame circuit breaker (600A and above) that has experienced some normal wear, but is in generally good condition, as an economically driven alternative to new
- When replacing Westinghouse breakers. Refer to **Page V12-T3-114**





Advantages

- Prevents loss of circuit breakers due to minor damage
- Reduces overall breaker costs
- Prevents use of potentially unreliable third-party refurbishers
- Includes full one-year Eaton Electrical Inc. warranty
- Ensures reliability through dealing with the original manufacturer with a long and well-recognized tradition of product safety, integrity and quality
- Provides a simple and convenient solution





Contact Eaton's Breaker Service Center: 1-877-BRK-SRVC.

QUICKLAG and Eaton Miniature Circuit Breaker Replacement Guide







QUICKLAG and Eaton Plug-In Industrial Circuit Breakers—Dimensions in Inches

Description	Maximum Amperes			
	150A	125A	100A	30A
Current Design				
These circuit breakers replace the out-of-production circuit breakers listed below.	HQP  Width: 1.00 Height: 2.94 Depth: 2.38	QPHW  Width: 1.00 Height: 2.94 Depth: 2.38	QHPX  Width: 1.00 Height: 2.94 Depth: 2.38	QHPW  Width: 1.00 Height: 2.94 Depth: 2.38
Out-of-Production Westinghouse Circuit Breakers	HQNPL, HQNPAL, HQNP, HQNPA, QP, QPA, QPAH, QNPL, QNPAL, QNP, Type P, PL		No previous circuit breaker existed	QHPL QHP

QUICKLAG Bolt-On Industrial Circuit Breakers—Dimensions in Inches

Description	Maximum Amperes			
	150A	125A	100A	30A
Current Design				
These circuit breakers replace the out-of-production circuit breakers listed below.	BAB  Width: 1.00 Height: 2.94 Depth: 2.38	QBHW  Width: 1.00 Height: 2.94 Depth: 2.38	HBAX  Width: 1.00 Height: 2.94 Depth: 2.38	HBAW  Width: 1.00 Height: 2.94 Depth: 2.38
Out-of-Production Westinghouse Circuit Breakers	HQNB, HQNBA, QB, BA, QNBL, QNBAL		No previous circuit breaker existed	HBA

QUICKLAG and Eaton Cable-In/Cable-Out Industrial Circuit Breakers—Dimensions in Inches

Description	Maximum Amperes						
	60A	100A	100A	100A	30A	40A	
Current Design							
These circuit breakers replace the out-of-production circuit breakers listed below.	QCR  Width: 0.50 Height: 3.94 Depth: 2.44	QCF  Width: 1.00 Height: 3.75 Depth: 2.44	QC  Width: 1.00 Height: 3.75 Depth: 2.44	QCHW  Width: 1.00 Height: 3.75 Depth: 2.44	QHCX  Width: 1.00 Height: 3.75 Depth: 2.44	QHCW  Width: 1.00 Height: 3.75 Depth: 2.44	WMZ/FAZ Width: 0.70 Height: 4.10 Depth: 2.60
Out-of-Production Westinghouse Circuit Breakers	No previous circuit breaker existed	HQCL, HQCAL, HQC, HQCA, QCA		No previous circuit breaker existed	QHCL, QHC	WMT	

Note: For supplementary protectors, the Eaton WMZS and FAZ Series replace the WMS supplementary protectors that are no longer manufactured.

QUICKLAG Miniature Circuit Breakers

QUICKLAG is the largest and most complete family of industrial thermal-magnetic miniature circuit breakers. They provide the exclusive features of steel frame calibration and arc chutes in every pole.

QUICKLAG circuit breakers are provided in ranges from 5 to 125A continuous in single-, two- and three-pole configurations with interrupting capacities from 10,000 AIC to 65,000 AIC. QUICKLAG circuit breakers have been series rated up to 200,000 AIC in conjunction

with larger Westinghouse/Cutler-Hammer current limiting circuit breakers.

Each QUICKLAG rating is available for plug-in (Type P), bolt-on (Type B) and cable-to-cable connections (Type C) for line/load feed applications. They are also available with one of the industry's widest

selection of accessories, including shunt trip, and can be custom modified to meet special application requirements.

Circuit Breaker Selection Guide

Circuit Breaker Type	Circuit Breaker Type Code	Continuous Ampere Rating at 40°C	No. of Poles	Volts		Federal Spec. W-C-375b	UL Listed Interrupting Ratings rms Symmetrical Amperes					
				AC	DC		AC Ratings Volts			DC ①		
							120	120/240	240	24	48	80
HQP	P	5-70	1	120/240	24, 48, 80	10a, 11a, 12a	—	10,000	—	5000	5000	2000
HQP	P	10-125	2	120/240	24, 48, 80	10a, 12a	—	10,000	—	5000	5000	5000
HQP	P	10-100	2, 3	240	—	10b, 11b, 12b	—	—	10,000	—	—	—
QPHW	P	15-70	1	120/240	24, 48, 80	14a	—	22,000	—	5000	5000	2000
QPHW	P	15-125	2	120/240	24, 48, 80	14a	—	22,000	—	5000	5000	5000
QPHW	P	15-100	2, 3	240	—	14b	—	—	22,000	—	—	—
QHPX	P	15-70	1	120/240	24, 48, 80	—	—	42,000	—	5000	5000	2000
QHPX	P	15-100	2	120/240	24, 48, 80	—	—	42,000	—	5000	5000	5000
QHPX	P	15-100	3	240	—	—	—	—	42,000	—	—	—
QHPW	P	15-30	1	120/240	24, 48, 80	15a	—	65,000	—	5000	5000	2000
QHPW	P	15-30	2	120/240	24, 48, 80	15a	—	65,000	—	5000	5000	5000
QHPW	P	15-30	3	240	—	15b	—	—	65,000	—	—	—
QPGF	P, GF	15-30	1	120	—	10a, 11a, 12a	10,000	—	—	—	—	—
QPGF	P, GF	15-50	2	120/240	—	10a, 11a, 12a	—	10,000	—	—	—	—
QPHGF	P, GF	15-30	1	120	—	10a, 11a, 12a	22,000	—	—	—	—	—
QPHGF	P, GF	15-50	2	120/240	—	10a, 11a, 12a	—	22,000	—	—	—	—
QPGFEP	P, GFEP	15-30	1	120	—	—	10,000	—	—	—	—	—
QPGFEP	P, GFEP	15-50	2	120/240	—	—	—	10,000	—	—	—	—
QPHGFEP	P, GFEP	15-30	1	120	—	—	22,000	—	—	—	—	—
QPHGFEP	P, GFEP	15-30	2	120/240	—	—	22,000	—	—	—	—	—
BAB	B	5-70	1	120/240	24, 48, 80	10a, 11a, 12a	—	10,000	—	5000	5000	2000
BAB	B	10-125	2	120/240	24, 48, 80	10a, 12a	—	10,000	—	5000	5000	5000
BAB	B	10-100	2, 3	240	—	10b, 11b, 12b	—	—	10,000	—	—	—
QBHW	B	15-70	1	120/240	24, 48, 80	14a	—	22,000	—	5000	5000	2000
QBHW	B	15-125	2	120/240	24, 48, 80	14a	—	22,000	—	5000	5000	5000
QBHW	B	15-100	2, 3	240	—	14b	—	—	22,000	—	—	—
HBAX	B	15-70	1	120/240	24, 48, 80	—	—	42,000	—	5000	5000	2000
HBAX	B	15-100	2	120/240	24, 48, 80	—	—	42,000	—	5000	5000	5000
HBAX	B	15-100	3	240	—	—	—	—	42,000	—	—	—
HBAW	B	15-30	1	120/240	24, 48, 80	15a	—	65,000	—	5000	5000	2000
HBAW	B	15-30	2	120/240	24, 48, 80	15a	—	65,000	—	5000	5000	5000
HBAW	B	15-30	3	240	—	15b	—	—	65,000	—	—	—
QBGF	B, GF	15-30	1	120	—	10a, 11a, 12a	10,000	—	—	—	—	—
QBGF	B, GF	15-50	2	120/240	—	10a, 11a, 12a	—	10,000	—	—	—	—

Notes

① Two-pole DC interrupting rating based on two poles connected in series.
Circuit breaker type codes: **P** Plug-in; **B** Bolt-on; **C** Cable-in/Cable-out; **GF** Ground Fault, 5 mA; **GFEP** Ground Fault, 30 mA.

Circuit Breaker Selection Guide, continued

Circuit Breaker Type	Circuit Breaker Type Code	Continuous Ampere Rating at 40°C	No. of Poles	Volts		Federal Spec. W-C-375b	UL Listed Interrupting Ratings rms Symmetrical Amperes					
				AC	DC		AC Ratings Volts			DC ①		
							120	120/240	240	24	48	80
QBHGF	B, GF	15–30	1	120	—	10a, 11a, 12a	22,000	—	—	—	—	—
QBHGF	B, GF	15–30	2	120/240	—	10a, 11a, 12a	—	22,000	—	—	—	—
QBGFEP	B, GFEP	15–30	1	120	—	—	10,000	—	—	—	—	—
QBGFEP	B, GFEP	15–50	2	120/240	—	—	—	10,000	—	—	—	—
QBHGFEP	B, GFEP	15–30	1	120	—	—	22,000	—	—	—	—	—
QBHGFEP	B, GFEP	15–30	2	120/240	—	—	22,000	—	—	—	—	—
QC	C	5–70	1	120/240	24, 48, 80	10a, 11a, 12a	—	10,000	—	5000	5000	2000
QC	C	10–100	2	120/240	24, 48, 80	10a, 12a	—	10,000	—	5000	5000	5000
QC	C	10–100	2, 3	240	—	10b, 11b, 12b	—	—	10,000	—	—	—
QC	C	15–100	4	240	—	10b, 11b, 12b	—	—	10,000	—	—	—
QCF	C	10–60	1, 2	120/240	—	—	10,000	10,000	—	—	—	—
QCR	C	10–60	1, 2	120/240	—	—	10,000	10,000	—	—	—	—
QCHW	C	15–70	1	120/240	24, 48, 80	14a	—	22,000	—	5000	5000	2000
QCHW	C	15–100	2	120/240	24, 48, 80	14a	—	22,000	—	5000	5000	5000
QCHW	C	15–100	2, 3	240	—	14b	—	—	22,000	—	—	—
QHCX	C	15–70	1	120/240	24, 48, 80	—	—	42,000	—	5000	5000	2000
QHCX	C	15–100	2	120/240	24, 48, 80	—	—	42,000	—	5000	5000	5000
QHCX	C	15–100	3	240	—	—	—	—	42,000	—	—	—
QHCW	C	15–30	1	120/240	24, 48, 80	15a	—	65,000	—	5000	5000	2000
QHCW	C	15–30	2	120/240	24, 48, 80	15a	—	65,000	—	5000	5000	5000
QHCW	C	15–30	3	240	—	15b	—	—	65,000	—	—	—
QCGF	C, GF	15–30	1	120	—	—	10,000	—	—	—	—	—
QCGF	C, GF	15–50	2	120/240	—	—	10,000	10,000	—	—	—	—
QCHGF	C, GF	15–30	1	120	—	—	22,000	—	—	—	—	—
QCHGF	C, GF	15–30	2	120/240	—	—	22,000	22,000	—	—	—	—
QCGFEP	C, GFEP	15–30	1	120	—	—	10,000	—	—	—	—	—
QCGFEP	C, GFEP	15–30	2	120/240	—	—	10,000	10,000	—	—	—	—
QCHGFEP	C, GFEP	15–30	1	120	—	—	22,000	—	—	—	—	—
QCHGFEP	C, GFEP	15–30	2	120/240	—	—	22,000	22,000	—	—	—	—

Notes

① Two-pole DC interrupting rating based on two poles connected in series.

Circuit breaker type codes: **P** Plug-in; **B** Bolt-on; **C** Cable-in/Cable-out; **GF** Ground Fault, 5 mA; **GFEP** Ground Fault, 30 mA.

CHB Circuit Breaker

Originally a Cutler-Hammer Product

The CHB breaker continues to be available as a replacement breaker for use in Cutler-Hammer Type PB panelboards.

When combined with the mounting base, CHB breakers were also used for surface and DIN rail mount cable-in/cable-out applications. (See photo below.)

For “new” cable-in/cable-out applications, Eaton recommends the use of our most current product offering:

- QUICKLAG Type QC breakers (1.00-inch per pole)
- QCR breakers—rear mount (0.50-inch per pole)
- QCF breakers—front mount (0.50-inch per pole)

QCR and QCF breakers provide a 50% space savings over 1.00-inch per pole designs of the same rating.



CHB Breaker Mounting Base

CHB Mounting Bases

Description		Catalog Number
Low Ampere		
15-50A	Single-pole	CHB9L1
15-50A	Two-pole	CHB9L250
15-50A	Three-pole	CHB9L350
High Ampere		
25-50A	Single-pole	CHB9H1
25-125A	Two-pole	CHB9H2125
25-100A	Three-pole	CHB9H3100

CHB Circuit Breaker Catalog Numbering System

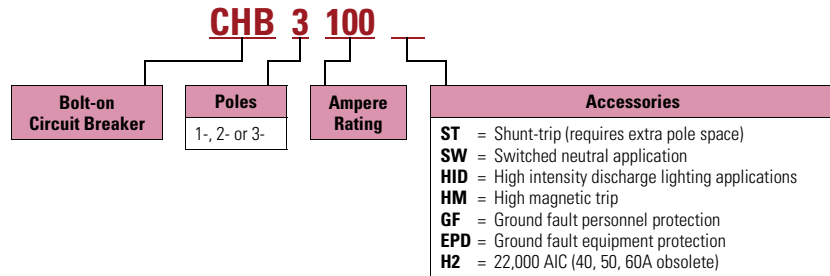



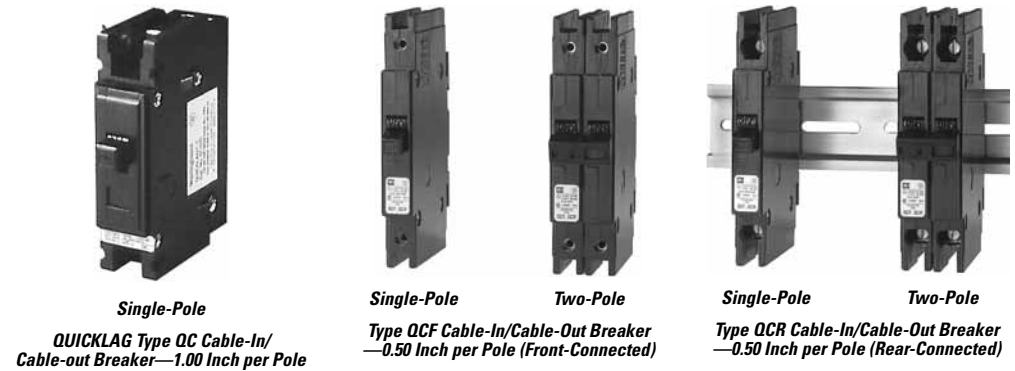















Replacement Capabilities



Series C Molded-Case Circuit Breaker Replacement Guide

Series C Industrial Circuit Breakers—Dimensions in Inches (Per Three-Pole Breaker)

Description	Maximum Amperes					
	100A	100A/125A	225A	100A	100A	
Current Design						
Series C circuit breakers are the current offering and, as such, are a logical first choice when upgrading or retrofitting equipment. All circuit breakers listed in a column are ELECTRICALLY INTERCHANGEABLE.	GHC	EG GD	ED, EDH, EDC	EHD	FDB, FD, HFD, FDC	
						
	Width: 3.00 Height: 4.88 Depth: 2.94	Width: 3.00 Height: 4.88 Depth: 2.81	Width: 4.13 Height: 6.00 Depth: 3.38	Width: 4.13 Height: 6.00 Depth: 3.38	Width: 4.13 Height: 6.00 Depth: 3.38	
	Replacement Circuit Breakers					
	These new UL labeled circuit breakers continue to be manufactured and are primarily applied to achieve exact physical and electrical replacement of previously installed Cutler-Hammer/Westinghouse circuit breakers of the same style number and rating.	EB ①	No previous circuit breaker existed	EHB ①	FB ①, HFB	
						
	Width: 4.13 Height: 6.00 Depth: 3.38		Width: 4.13 Height: 6.00 Depth: 3.38	Width: 4.13 Height: 6.00 Depth: 3.38		
Out-of-Production Westinghouse Circuit Breakers						
These circuit breakers are no longer manufactured. *Indicates the last date of manufacture. As an option, any of these circuit breakers can be reconditioned at the original factory. For details, see Page V12-T3-5 , or contact your local Eaton Field Sales office.	E, EA	QCC	EH	FA, HFA		
						
	*1974 Width: 4.13 Height: 6.00 Depth: 3.38	* 1968 Width: 4.50 Height: 7.00 Depth: 3.38	* 1974 Width: 4.13 Height: 6.50 Depth: 3.38	* 1974 Width: 4.13 Height: 6.50 Depth: 3.38		
		CA, CAH, HCA ①		F, HF	G	
						
	Width: 4.13 Height: 6.50 Depth: 2.69		Width: 4.13 Height: 9.38 Depth: 4.06	Width: 8.25 Height: 9.38 Depth: 4.06		
Out-of-Production Cutler-Hammer Circuit Breakers Last Manufactured by Eaton in 1994						
		FS EC, EHC	FS, FH, FC, HFC			
						
		Width: 4.13 Height: 6.13 Depth: 3.38	Width: 4.13 Height: 6.13 Depth: 3.19			
			FL			
						
			Width: 4.13 Height: 9.31 Depth: 3.19			

Note

① These frames are obsolete. For replacement solutions see the cross-reference on **Pages V12-T3-114–V12-T3-167**.

Series C Industrial Circuit Breakers—Dimensions in Inches (Per Three-Pole Breaker), Continued

Maximum Amperes

150A

225A, 250A

400A

600A

Current Design

FDB, FD, HFD, FDC



Width: 4.13
Height: 6.00
Depth: 3.38

JG
JD, HJD, JDC
250A



Width: 4.13
Height: 10.00
Depth: 4.06

JDB
250A



Width: 4.13
Height: 10.00
Depth: 4.06

DK^①



Width: 5.50
Height: 10.13
Depth: 4.06

KD, HKD, KDC^①



Width: 5.50
Height: 10.13
Depth: 4.06

KDB



Width: 5.50
Height: 10.13
Depth: 4.06

LG
LD, HLD, LDB



Width: 8.25
Height: 10.75
Depth: 4.06

Replacement Circuit Breakers

FB^②, HFB



Width: 4.13
Height: 6.00
Depth: 3.38

KB^②, HKB^②



Width: 4.13
Height: 10.00
Depth: 4.06

JB^②



Width: 4.13
Height: 10.00
Depth: 4.06

DA^②



Width: 5.50
Height: 10.13
Depth: 4.06

LB^②, HLB^①



Width: 5.50
Height: 10.13
Depth: 4.06

LBB^②



Width: 5.50
Height: 10.13
Depth: 4.06

LC^②, HLC



Width: 8.25
Height: 10.75
Depth: 4.06

KA^②, HKA^②



Width: 5.50
Height: 10.13
Depth: 4.06

JA^②



Width: 5.50
Height: 10.13
Depth: 4.06

LA^②, HLA



Width: 8.25
Height: 10.75
Depth: 4.06

LAB^②



Width: 8.25
Height: 10.75
Depth: 4.06

LA^②, HLA



Width: 8.25
Height: 10.75
Depth: 4.06

Out-of-Production Westinghouse Circuit Breakers

FA, HFA



*1974

Width: 4.13
Height: 6.50
Depth: 3.38

*Indicates the last date of manufacture.

JK



225A

*1967

Width: 8.25
Height: 10.75
Depth: 4.06

J



225A

*1967

Width: 8.25
Height: 10.13
Depth: 4.06

JKL



*1967

Width: 8.25
Height: 10.75
Depth: 4.06

L, LM, HLM



*1967

Width: 8.25
Height: 22.00
Depth: 5.50

K, HK



225A

*1967

Width: 8.25
Height: 15.50
Depth: 4.06

KL, HKL



*1967

Width: 8.25
Height: 5.75
Depth: 4.06

**SPCB 600A,
SCB 600A**
*1986 (Consult Eaton)

Width: 8.25
Height: 10.75
Depth: 4.06

Out-of-Production Cutler-Hammer Circuit Breakers Last Manufactured by Eaton in 1994

FS, FH, FC, HFC



Width: 4.25
Height: 6.13
Depth: 3.19

JS, JH, JL



Width: 4.25
Height: 12.00
Depth: 3.81

JS



Width: 4.25
Height: 12.00
Depth: 3.81

KS-D, KS



Width: 5.50
Height: 10.13
Depth: 3.81

KS-D, KH-D, KS, KH



Width: 5.50
Height: 10.13
Depth: 3.81

KS-D, KH-D, KS, KH



Width: 5.50
Height: 10.13
Depth: 3.81

LS(E), LH(E), LS(A), LH(A)









Width: 8.25
Height: 10.75
Depth: 3.81

Notes

① When upgrading a HLB, LBB to a Series C K-Frame in a panelboard application, also order TAD3 spacer kit.

② These frames are obsolete. For replacement solutions see the cross-reference on Pages V12-T3-114–V12-T3-167.

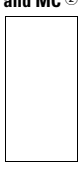
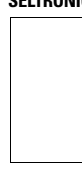
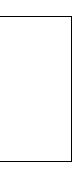
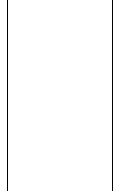
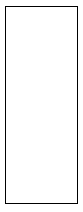
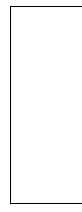
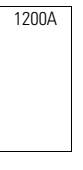
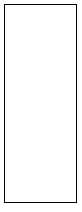
Series C Industrial Circuit Breakers—Dimensions in Inches (Per Three-Pole Breaker), Continued

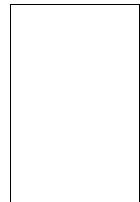



Description	Maximum Amperes			
	800A		1200A	1600A/2000A/2500A ①
Current Design				
<p>Series C circuit breakers are the current offering and, as such, are a logical first choice when upgrading or retrofitting equipment. All circuit breakers listed in a column are ELECTRICALLY INTERCHANGEABLE.</p>	MDL, HMDL 	NG ND, HND, NDC 	NG ND, HND, NDC 	RG RD 
	Width: 8.25 Height: 16.00 Depth: 4.06	Width: 8.25 Height: 16.00 Depth: 5.50	Width: 8.25 Height: 16.00 Depth: 5.50	Width: 15.50 Height: 16.00 Depth: 9.75
Replacement Circuit Breakers				
<p>These new UL labeled circuit breakers continue to be manufactured and are primarily applied to achieve exact physical and electrical replacement of previously installed Cutler-Hammer/Westinghouse circuit breakers of the same style number and rating. PB/PC breakers are not UL Listed.</p>	MA ②, HMA, MD ②, MDS ② and MC ② 	MA ②, HMA and MC ②, MCC ② SELTRONIC™ ② 	NC ②, HNC and NB ②, HNB 	PC, PCC 
	Width: 8.25 Height: 16.00 Depth: 4.06	Width: 8.25 Height: 16.00 Depth: 4.06	Width: 8.25 Height: 16.00 Depth: 5.50	Width: 12.06 Height: 22.06 Depth: 9.06
Out-of-Production Westinghouse Circuit Breakers				
<p>These circuit breakers are no longer manufactured. *Indicates the last date of manufacture. As an option, any of these circuit breakers can be reconditioned at the original factory. For details, see Page V12-T3-5, or contact your local Eaton Field Sales office.</p>	LM, HLM and M 	LM, HLM and M 	MA, HMA 1200A 	MA, HLM 
	*1967 Width: 8.25 Height: 22.00 Depth: 5.50	*1967 Width: 8.25 Height: 22.00 Depth: 5.50	*1968 Width: 8.25 Height: 16.00 Depth: 5.50	*1967 Width: 8.25 Height: 22.00 Depth: 5.50
			SPCB 1200A, SCB 1200A *1986 (Consult Eaton) Width: 8.25 Height: 16.00 Depth: 5.50	SPCB 2000–3000A, SCB 2000–3000A *1986 (Consult Eaton) Width: 12.06 Height: 22.06 Depth: 9.06
Out-of-Production Cutler-Hammer Circuit Breakers Last Manufactured by Eaton in 1994				
MS, MH 	NS, NH 	No equivalent Cutler-Hammer brand frame size existed	No equivalent Cutler-Hammer brand frame size existed	
Width: 8.25 Height: 16.00 Depth: 4.06	Width: 8.25 Height: 16.00 Depth: 5.50			

Notes

① RD breaker replaces PC, PCC and PB breakers for 2000 and 2500A only.

② These frames are obsolete. For replacement solutions, see the cross-reference on **Pages V12-T3-114–V12-T3-167**.

Current Limiting Circuit Breakers—Dimensions in Inches (Per Three-Pole Breaker)

Description	Maximum Amperes				
	100A	250A	400A	100A	225A
Current Design					
All circuit breakers listed in a column are ELECTRICALLY INTERCHANGEABLE.	FCL Current Limit-R (non-fused) 	LCL Current Limit-R (non-fused) 	LCL Current Limit-R (non-fused) 	FB TRI-PAC® (fused) 	LA TRI-PAC (fused) 
	Width: 4.13 Height: 8.75 Depth: 3.38	Width: 8.25 Height: 16.00 Depth: 4.06	Width: 8.25 Height: 16.00 Depth: 4.06	Width: 4.13 Height: 8.75 Depth: 3.50	Width: 8.25 Height: 16.00 Depth: 4.75

Replacement Circuit Breakers

These new UL labeled circuit breakers continue to be manufactured and are primarily applied to achieve exact physical and electrical replacement of previously installed Cutler-Hammer/Westinghouse circuit breakers of the same style number and rating.

Out-of-Production Westinghouse Circuit Breakers

These circuit breakers are no longer manufactured.

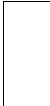
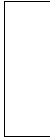
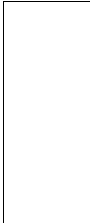

*Indicates the last date of manufacture. As an option, any of these circuit breakers can be reconditioned at the original factory. For details, see **Page V12-T3-5**, or contact your local Eaton Field Sales office.

FA TRI-PAC	F TRI-PAC	K TRI-PAC
		
*1968	*1968	*1968
Width: 4.13 Height: 9.38 Depth: 3.19	Width: 4.63 Height: 11.81 Depth: 3.81	Width: 8.25 Height: 19.63 Depth: 4.06

Out-of-Production Cutler-Hammer Circuit Breakers Last Manufactured by Eaton in 1994

No Equivalent Cutler-Hammer Brand Frame Sizes Existed

Current Limiting Circuit Breakers—Dimensions in Inches (Per Three-Pole Breaker)

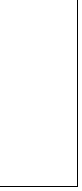
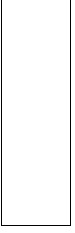
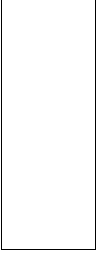
Description	Maximum Amperes		
	400A	800A	1600A
Current Design			
All circuit breakers listed in a column are ELECTRICALLY INTERCHANGEABLE.	LA TRI-PAC® (Fused) 	NB TRI-PAC (Fused) 	PB TRI-PAC (Fused) 
	Width: 8.25 Height: 16.00 Depth: 4.75	Width: 8.25 Height: 22.00 Depth: 5.50	Width: 12.06 Height: 22.13 Depth: 9.06
Replacement Circuit Breakers			
These new UL labeled circuit breakers continue to be manufactured and are primarily applied to achieve exact physical and electrical replacement of previously installed Cutler-Hammer/Westinghouse circuit breakers of the same style number and rating.			
Out-of-Production Westinghouse Circuit Breakers			
These circuit breakers are no longer manufactured. *Indicates the last date of manufacture. As an option, any of these circuit breakers can be reconditioned at the original factory. For details, see Page V12-T3-5 , or contact your local Eaton Field Sales office.	KL TRI-PAC 	L TRI-PAC 	MA TRI-PAC 
	*1968 Width: 8.25 Height: 19.63 Depth: 4.06	*1968 Width: 8.25 Height: 26.91 Depth: 5.50	*1968 Width: 8.25 Height: 22.00 Depth: 5.50
Out-of-Production Cutler-Hammer Circuit Breakers Last Manufactured by Eaton in 1994			
No equivalent Cutler-Hammer brand frame sizes existed			

Shaded area denotes obsolete or discontinued products and services. ^①

EB: 120, 240 Vac;
125/250 Vdc



Type EB Single-, Two-, Three-Pole; 240 Vac Maximum; Thermal-Magnetic and Saf-T-Vue^{®②}

Continuous Ampere Rating at 40°C	Single-Pole, 120 Vac, 125 Vdc ^③		Two-Pole, 240 Vac, 125/250 Vdc ^③		Three-Pole, 240 Vac, 125/250 Vdc ^③	
	Standard Catalog Number		Standard Catalog Number		Standard Catalog Number	Saf-T-Vue ^④ Catalog Number
15	EB1015 ^⑤		EB2015		EB3015	EB3015S
20	EB1020 ^⑤		EB2020		EB3020	EB3020S
25	EB1025		EB2025		EB3025	EB3025S
30	EB1030		EB2030		EB3030	EB3030S
35	EB1035		EB2035		EB3035	EB3035S
40	EB1040		EB2040		EB3040	EB3040S
45	EB1045		EB2045		EB3045	EB3045S
50	EB1050		EB2050		EB3050	EB3050S
60	EB1060		EB2060		EB3060	EB3060S
70	EB1070		EB2070		EB3070	EB3070S
80	EB1080		EB2080		EB3080	EB3080S
90	EB1090		EB2090		EB3090	EB3090S
100	EB1100		EB2100		EB3100	EB3100S
		Approximate shipping weight is 2 lbs		Approximate shipping weight is 3 lbs		Approximate shipping weight is 4.5 lbs

EHB: 277, 480 Vac;
250 Vdc



Type EHB Single-, Two-, Three-Pole; 480 Vac Maximum; Thermal-Magnetic and Saf-T-Vue^{®②}

Continuous Ampere Rating at 40°C	Single-Pole, 277 Vac, 125 Vdc ^③		Two-Pole, 480 Vac, 250 Vdc ^③		Three-Pole, 480 Vac	
	Standard Catalog Number		Standard Catalog Number		Standard Catalog Number	Saf-T-Vue ^④ Catalog Number
15	EHB1015 ^⑤		EHB2015		EHB3015	EHB3015S
20	EHB1020 ^⑤		EHB2020		EHB3020	EHB3020S
25	EHB1025		EHB2025		EHB3025	EHB3025S
30	EHB1030		EHB2030		EHB3030	EHB3030S
35	EHB1035		EHB2035		EHB3035	EHB3035S
40	EHB1040		EHB2040		EHB3040	EHB3040S
45	EHB1045		EHB2045		EHB3045	EHB3045S
50	EHB1050		EHB2050		EHB3050	EHB3050S
60	EHB1060		EHB2060		EHB3060	EHB3060S
70	EHB1070		EHB2070		EHB3070	EHB3070S
80	EHB1080		EHB2080		EHB3080	EHB3080S
90	EHB1090		EHB2090		EHB3090	EHB3090S
100	EHB1100		EHB2100		EHB3100	EHB3100S
		Approximate shipping weight is 2 lbs		Approximate shipping weight is 3 lbs		Approximate shipping weight is 4.5 lbs

UL Listed Interrupting Ratings^⑦

Maximum Volts	Amperes
EB Breakers	
120 and 240 AC	10,000 asymmetrical, symmetrical
125/250 DC	5000 ^③
EHB, FB Breakers	
240 AC	20,000 asymmetrical, 18,000 symmetrical
277 AC (EHB)	15,000 asymmetrical, 14,000 symmetrical
480 AC	15,000 asymmetrical, 14,000 symmetrical
600 AC (FB)	15,000 asymmetrical, 14,000 symmetrical
250 DC	10,000 ^③

Notes

- ① These frames are obsolete. For replacement solutions, see the cross-reference on **Pages V12-T3-114–V12-T3-167**.
- ② Includes load terminals only.
- ③ DC ratings apply to substantially non-inductive circuits.
- ④ Not UL Listed.
- ⑤ Switching duty rated for 120 Vac fluorescent light applications only.
- ⑥ Switching duty rated for 277 Vac fluorescent light applications only.
- ⑦ Interrupting capacities shown do not apply to molded-case switches.

Shaded area denotes obsolete or discontinued products and services. ①

FB, HFB: 600 Vac;
250 Vdc



3

Type FB, HFB Single-, Two-, Three-, Four-Pole; 480V Max.; Thermal-Magnetic MARK 75® Saf-T-Vue

Continuous Ampere Rating at 40°C	Single-Pole 277 Vac; 125 Vdc ②		Two-Pole 600 Vac; 250 Vdc ②		Three-Pole 600 Vac		Four-Pole ③④ 600 Vac
	MARK 75 ⑤ Catalog Number	Standard Catalog Number	MARK 75 ⑤ Catalog Number	Standard Catalog Number	Saf-T-Vue ⑥ Catalog Number	MARK 75 ⑦ Catalog Number	Standard Catalog Number
15	HFB1015 ⑧	FB2015	HFB2015	FB3015	FB3015S	HFB3015L	FB4015
20	HFB1020 ⑧	FB2020	HFB2020	FB3020	FB3020S	HFB3020L	FB4020
25	HFB1025	FB2025	HFB2025	FB3025	FB3025S	HFB3025L	FB4025
30	HFB1030	FB2030	HFB2030	FB3030	FB3030S	HFB3030L	FB4030
35	HFB1035	FB2035	HFB2035	FB3035	FB3035S	HFB3035L	FB4035
40	HFB1040	FB2040	HFB2040	FB3040	FB3040S	HFB3040L	FB4040
45	HFB1045	FB2045	HFB2045	FB3045	FB3045S	HFB3045L	FB4045
50	HFB1050	FB2050	HFB2050	FB3050	FB3050S	HFB3050L	FB4050
60	HFB1060	FB2060	HFB2060	FB3060	FB3060S	HFB3060L	FB4060
70	HFB1070	FB2070	HFB2070	FB3070	FB3070S	HFB3070L	FB4070
80	HFB1080	FB2080	HFB2080	FB3080	FB3080S	HFB3080L	FB4080
90	HFB1090	FB2090	HFB2090	FB3090	FB3090S	HFB3090L	FB4090
100	HFB1100	FB2100	HFB2100	FB3100	FB3100S	HFB3100L	FB4100
110	—	—	—	FB3110	FB3110S	HFB3110	—
125	—	—	—	FB3125	FB3125S	HFB3125	—
150	—	—	—	FB3150	FB3150S	HFB3150	—

UL Listed Interrupting Ratings ⑩

Maximum Volts	Amperes
MARK 75 Type HFB	
240 AC	75,000 asymmetrical, 65,000 symmetrical
277 AC ⑥	75,000 asymmetrical, 65,000 symmetrical
480 AC	30,000 asymmetrical, 25,000 symmetrical
250 DC (two-pole)	20,000 ②⑩

Special Breakers Type FB, Magnetic Only, Front Adjustable

Continuous Ampere Rating	Magnetic Trip Range Amperes	Two-Pole, 600 Vac		Three-Pole, 600 Vac		MARK 75 ⑦ Catalog/Style Number
		Standard Catalog/Style Number	MARK 75 Catalog/Style Number	Standard Catalog/Style Number	Saf-T-Vue Catalog/Style Number	
3	7–22	FB2022MRL	HFB2022ML	FB3022MRL	FB3022SMRL	HFB3022ML
5	15–45	FB2045MRL	HFB2045ML	FB3045MRL	FB3045SMRL	HFB3045ML
10	35–110	FB2110MRL	HFB2110ML	FB3110MRL	FB3110SMRL	HFB3110ML
25	32–80	2610D53G12	4994D96G12	2610D53G30	4998D89G30	2610D57G30
25	66–190	FB2190MRL	HFB2190ML	FB3190MRL	FB3190SMRL	HFB3190ML
30	50–150	1268C14G05	—	1268C14G06	—	—
30	90–270	FB2270MRL	HFB2270ML	FB3270MRL	FB3270SMRL	HFB3270ML
50	66–190	1268C14G01	—	1268C14G02	—	—
50	160–480	FB2480MRL	HFB2480ML	FB3480MRL	FB3480SMRL	HFB3480ML
70	100–270	2610D53G13	4994D96G13	2610D53G31	2610D58G31	4994D96G31
100	150–480	1268C14G03	—	1268C14G04	81E4647	65E4667
100	450–1550	FB21550MRL	HFB21550ML	FB31550MRL	FB31550SMRL	HFB31550ML

Notes

- ① These frames are obsolete. For replacement solutions, see the cross-reference on **Pages V12-T3-114–V12-T3-167**.
- ② DC ratings apply to substantially non-inductive circuits.
- ③ Not UL Listed.
- ④ All four poles have thermal-magnetic trip elements. Can be supplied with three protected poles and one unprotected, non-automatic pole if required. Order by description with no price or dimensional differences.
- ⑤ 15–30A rated 75,000 AIC. 40–100A rated 30,000A asymmetrical, 25,000A symmetrical.
- ⑥ Two-pole breakers are supplied in three-pole frames with current carrying parts omitted from center pole.
- ⑦ Includes line and load terminals. MARK 75 frame color changed from gray to black in mid-2002.
- ⑧ Switching duty rated for 277 Vac fluorescent light applications only.
- ⑨ Interrupting capacities shown do not apply to molded-case switches.
- ⑩ Ratings above 10,000A not UL Listed.

Accessories and Modifications

Terminals

Breakers include load terminals only.

Terminals are UL Listed as suitable for wire type and size. When used with aluminum conductors, use joint compound. When line terminals are required, order by style number from the table at no charge with the breaker.

Note: Magnetic only breakers include both line and load terminals.

Note: Suffix "L" on catalog number indicates line and load terminals included. If factory installation is required, specify on order.

Terminals

Maximum Amperes	Wire Type	Wire Range	Package of Three Line Terminals ^① Style Number
Standard Pressure Type Terminals			
20 (EB, EHB)	Al/Cu	#14-#10	624B100G14
100	Al/Cu	#14-1/0	624B100G02
150	Al/Cu	#4-4/0	624B100G17
Optional Al/Cu Pressure Terminals			
50	Al/Cu	#14-#4	624B100G10
100	Al/Cu	#4-4/0	624B100G17

Terminal Style 624B100G02

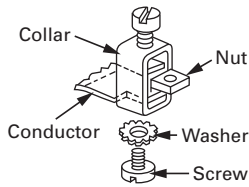

Insert collar enclosing conductor as shown. Locate nut on top of conductor and tighten securely with screw and washer. **Caution:** Collar must surround conductor.

Terminal Style 624B100G10

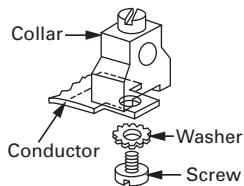

Assemble collar on top of conductor as shown. Tighten securely with screw and washer.

Terminal Style 624B100G17

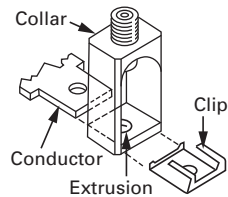

Insert collar enclosing conductor and center on extrusion on collar. Install clip with legs on top of conductor and snap end around bottom of collar.

Terminal Style 624B100G14

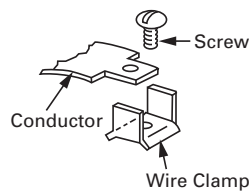

Assemble wire clamp to bottom of conductor as shown.

Shaded area denotes obsolete or discontinued products and services.

LFB Current Limiter Attachment

The LFB current limiter is an attachment that bolts to the load end of a standard FB thermal-magnetic or magnetic only breaker, providing 200,000A interrupting capacity (AIC) at up to 600 Vac. Limiters for thermal-magnetic breakers are UL Listed. Current limiters must be applied as indicated in the table on **Page V12-T3-16**.

Standard LFB terminals are suitable for Cu/Al cable. Ratings through 70A accept (1) #14-#2, and 100 and 150A accept (1) #1-4/0.

Note: Cannot be used with plug-in adapters. Ratings through 70A can be supplied with terminals for Cu cable only (#14-#2). Order by description.

LFB Current Limiter Attachment ^②

Breaker Rating, Amperes	Limiter Catalog Number
For Thermal-Magnetic Breakers ^③	
15-70	LFB3070R ^④
80-150	LFB3150R ^⑤
For Magnetic Only Breakers ^{③⑥}	
3	LFB3003MR
5	LFB3005MR
10	LFB3010MR
25	LFB3025MR
30	LFB3030MR
50	LFB3050MR
70	LFB3070MR
100	LFB3100MR
150	LFB3150MR

Notes

- ① Style listed is for package of three terminals.
- ② These frames are obsolete. For replacement solutions, see the cross-reference on **Pages V12-T3-114-V12-T3-167**.
- ③ Ratings through 70A can be supplied with terminals for Cu cable only (#14-#2). Order by description.
- ④ Superseded by LFD3070R.
- ⑤ Superseded by LFD3150R.
- ⑥ Replace with Series C HMCP and ELC current limiters or replace with MCP and EL current limiters

Special Calibrations

Special calibration price additions apply to ampere ratings not listed as standard or for ambients other than 40°C or 50°C. For frequencies other than 0-60 Hz AC, refer to Eaton. See Application Data 29-160 for information regarding special conditions. Maximum calibration for 400 Hz is 135A.

Note: Not UL Listed.

50°C Calibration

Add suffix "V" to catalog number for complete breaker, listed above, when ordering breakers to be used in 50°C ambients.

Note: Not UL Listed.

Ambient Compensating Breakers

To order, add suffix letter "A" to standard thermal-magnetic breaker catalog number.

Available in all standard ratings of EB, EHB, FB and HFB breakers up to ratings of 100A. Factory adder 20%.

Note: Not UL Listed.

Federal Specification Classifications

EB, EHB, FB and HFB breakers meet requirements of Federal Specification W-C-375b as follows:

- EB: single-pole, Class 11a; two-, three-pole, Classes 10b, 11b, 12b
- EHB: single-pole, Class 13a; two-, three-pole, Class 13b
- FB: two-, three-pole, Class 18a
- HFB: single-pole, Class 13a; two-, three-pole, Class 22a

For all three-phase delta, grounded B phase applications, contact Avery Creek, NC, Technical Resource Center at **1-800-356-1243**.

Type CCV 120/240V Tenant Main Circuit Breaker 10,000A and 25,000A Interrupting Capacity, 100–225A



Type CCV Two-Pole
120/240V Tenant
Main Circuit Breaker

Product Description

Ratings

- 120/240 Vac, two-pole, through 225 continuous amperes, calibrated at 40°C

Tripping Characteristics

- Thermal-magnetic trip, calibrated and sealed after assembly. Indirectly heated thermal tripping—bimetal elements

Product Selection

Ampere Rating	Two-Pole Breaker		10,000 AIC	25,000 AIC
	Wire Size Range, Al/Cu			
100	#2/0–300 kcmil		CCV2100	CCVH2100
125	#2/0–300 kcmil		CCV2125	CCVH2125
150	#2/0–300 kcmil		CCV2150	CCVH2150
175	#2/0–300 kcmil		CCV2175	CCVH2175
200	#2/0–300 kcmil		CCV2200	CCVH2200
225	#2/0–300 kcmil		CCV2225	CCVH2225

Interrupting Capacity at 120/240 Vac

- Type CCV—10,000A rms symmetrical
- Type CCVH—25,000A rms symmetrical

Handles

- Trip-free with “ON-TRIPPED-OFF” positions. Reset past “OFF” is required to latch breaker contacts after tripping

Terminals

- Standard lugs (wire connectors) suitable for either CU or AL wire

Standards

- Complies with UL Standard 489, breakers are listed under UL File #E781

Backward Compatibility

- CCV and CCVH retains same profile and footprint of the CC and CCH breaker allowing use in the same applications

Terminal Options

Terminal configurations available by adding the following designator on the suffix:

W = No terminals

X = Load side terminals only

Y = Line side terminals only

CCV as tenant main breaker with CC as aftermarket option.

Cross-Reference

CCV Catalog Number	CC Catalog Number	CCV Catalog Number	CC Catalog Number
CCV2100	CC2100	CCVH2100	CCH2100
CCV2100W	CC2100W	CCVH2100W	CCH2100W
CCV2100X	CC2100X	CCVH2100X	CCH2100X
CCV2100Y	CC2100Y	CCVH2100Y	CCH2100Y
CCV2125	CC2125	CCVH2125	CCH2125
CCV2125W	CC2125W	CCVH2125W	CCH2125W
CCV2125X	CC2125X	CCVH2125X	CCH2125X
CCV2125Y	CC2125Y	CCVH2125Y	CCH2125Y
CCV2150	CC2150	CCVH2150	CCH2150
CCV2150W	CC2150W	CCVH2150W	CCH2150W
CCV2150X	CC2150X	CCVH2150X	CCH2150X
CCV2150Y	CC2150Y	CCVH2150Y	CCH2150Y
CCV2175	CC2175	CCVH2175	CCH2175
CCV2175W	CC2175W	CCVH2175W	CCH2175W
CCV2175X	CC2175X	CCVH2175X	CCH2175X
CCV2175Y	CC2175Y	CCVH2175Y	CCH2175Y
CCV2200	CC2200	CCVH2200	CCH2200
CCV2200W	CC2200W	CCVH2200W	CCH2200W
CCV2200X	CC2200X	CCVH2200X	CCH2200X
CCV2200Y	CC2200Y	CCVH2200Y	CCH2200Y
CCV2225	CC2225	CCVH2225	CCH2225
CCV2225W	CC2225W	CCVH2225W	CCH2225W
CCV2225X	CC2225X	CCVH2225X	CCH2225X
CCV2225Y	CC2225Y	CCVH2225Y	CCH2225Y

Type JB

Shaded area denotes obsolete or discontinued products and services. ①

JB: 600 Vac; 250 Vdc



Type JB 90–250A, 600 Vac, 250 Vdc, Two- and Three-Pole, Fixed Trip, Thermal-Magnetic, Saf-T-Vue (Suitable for Reverse-Feed)

Continuous Ampere Rating at 40°C	Magnetic Trip Setting, Amperes (Set on High Side, Adjustable to Lower Limits)		Complete Breaker Includes Pressure Type Aluminum Terminals ②		Breaker Without Terminals		
	Low	High	Standard Catalog Number	Saf-T-Vue ③ Catalog Number	Standard Catalog Number	Saf-T-Vue ③ Catalog Number	
Two-Pole, 600 Vac, 250 Vdc ④							
70	350	700	JB2070	JB2070S	JB2070W	JB2070SW	
90	450	900	JB2090	JB2090S	JB2090W	JB2090SW	
100	500	1000	JB2100	JB2100S	JB2100W	JB2100SW	
125	625	1250	JB2125	JB2125S	JB2125W	JB2125SW	
150	750	1500	JB2150	JB2150S	JB2150W	JB2150SW	
175	875	1750	JB2175	JB2175S	JB2175W	JB2175SW	
200	1000	2000	JB2200	JB2200S	JB2200W	JB2200SW	
225	1125	2250	JB2225	JB2225S	JB2225W	JB2225SW	
250	1250	2500	JB2250	JB2250S	JB2250W	JB2250SW	
				Approx. shipping weight, 12 lbs		Approx. shipping weight 12 lbs	
Three-Pole, 600 Vac Only							
70	350	700	JB3070	JB3070S	JB3070W	JB3070SW	
90	450	900	JB3090	JB3090S	JB3090W	JB3090SW	
100	500	1000	JB3100	JB3100S	JB3100W	JB3100SW	
125	625	1250	JB3125	JB3125S	JB3125W	JB3125SW	
150	750	1500	JB3150	JB3150S	JB3150W	JB3150SW	
175	875	1750	JB3175	JB3175S	JB3175W	JB3175SW	
200	1000	2000	JB3200	JB3200S	JB3200W	JB3200SW	
225	1125	2250	JB3225	JB3225S	JB3225W	JB3225SW	
250	1250	2500	JB3250	JB3250S	JB3250W	JB3250SW	
				Approx. shipping weight 14 lbs		Approx. shipping weight 12 lbs	

Magnetic Only Breakers, Front Adjustable ③

Continuous Ampere Rating at 40°C	Magnetic Trip Setting, Amperes (Set on High Side, Adjustable to Lower Limits)		Breaker Only, No Terminals ⑤			
	Low	High	Two-Pole ④		Three-Pole	
			Standard Catalog Number	Saf-T-Vue Catalog Number	Standard Catalog Number	Saf-T-Vue Catalog Number
250	350	700	JB2700MW	JB2700SMW	JB3700MW	JB3700SMW
250	625	1250	JB21250MW	JB21250SMW	JB31250MW	JB31250SMW
250	750	1500	JB21500MW	JB21500SMW	JB31500MW	JB31500SMW
250	875	1750	JB21750MW	JB21750SMW	JB31750MW	JB31750SMW
250	1125	2250	JB22250MW	JB22250SMW	JB32250MW	JB32250SMW
250	1250	2500	JB22500MW	JB22500SMW	JB32500MW	JB32500SMW

Notes

- ① These frames are obsolete. For replacement solutions, see the cross-reference on **Pages V12-T3-114–V12-T3-167**.
- ② Terminals are shipped separately from breaker frame.
- ③ Not UL Listed.
- ④ Two-pole breakers are supplied in three-pole frames with current carrying parts omitted from center pole.
- ⑤ Select desired terminal from table and order as separate item.

UL Listed Interrupting Ratings ①

Maximum Volts	Amperes
240 AC	30,000 asymmetrical, 25,000 symmetrical
480 AC	25,000 asymmetrical, 22,000 symmetrical
600 AC	15,000 asymmetrical, 14,000 symmetrical
250 DC	10,000

Terminals

Maximum Amperes	Number of Cables, Wire Range, Type	Catalog Number
Standard Al/Cu Pressure Terminals		
250	(1) #4–350 kcmil Al/Cu	TA250KB
Optional Pressure Terminals		
250	(1) #4–350 kcmil Cu	T250KB

Note

① Ratings above 10,000A not UL Listed.

Accessories and Modifications

■ Shaded area denotes obsolete or discontinued products and services.

Special Calibrations

Special calibration price additions apply to ampere ratings not listed as standard or for ambients other than 40°C or 50°C. For frequencies other than 0–60 Hz AC, refer to Eaton.

Note: Not UL Listed.

50°C Calibration

Add suffix “V” to catalog number for complete breaker when ordering breakers to be used in 50°C ambients. Same price as standard 40°C breakers.

For CSA®, see Page V12-T3-48.

Type JB breakers meet requirements of Class 19a circuit breakers as defined by Federal Specification W-C-375b.

Note: Not UL Listed.

UL Listed Interrupting Rating (see table)

For all three-phase delta, grounded B phase applications, contact Avery Creek, NC, Technical Resource Center at **1-800-356-1243**.

Terminals (see table)

Two terminals are required per pole.

Terminals are UL Listed for wire type and range listed left. When used with aluminum conductors, use joint compound. To order optional copper only terminals, add suffix “C” to complete breaker catalog number.

Note: Terminals are shipped separately from breaker frame.

Magnetic Only Breakers

For description, refer to Application Data 29-160.

Additional Accessories and Modifications

Refer to **Pages V12-T3-65–V12-T3-79**.

Types KB and HKB

Shaded area denotes obsolete or discontinued products and services. ①

KB/MARK 75/HKB:
600 Vac; 250 Vdc



Type KB and MARK 75 Type HKB 90–250A, 600 Vac, 250 Vdc, Two- and Three-Pole, Interchangeable Trip Thermal-Magnetic, Saf-T-Vue

Continuous Ampere Rating at 40°C	Magnetic Trip Setting Amperes ③		Complete Breaker Includes Pressure Type Aluminum Terminals ③			Shipped as Frame, Trip Unit and Terminals ②			Trip Unit Only Standard Saf-T-Vue MARK 75 Catalog Number
	Low	High	Standard Catalog Number	Saf-T-Vue Catalog Number ③	MARK 75 Catalog Number	Standard Catalog Number	Saf-T-Vue Catalog Number ④	MARK 75 Catalog Number	
Two-Pole, 600 Vac, 250 Vdc ③									
70	350	700	KB2070	KB2070S	HKB2070	KB2250F	KB2250FS	HKB2250F	HKB2070T
90	450	900	KB2090	KB2090S	HKB2090	KB2250F	KB2250FS	HKB2250F	HKB2090T
100	500	1000	KB2100	KB2100S	HKB2100	KB2250F	KB2250FS	HKB2250F	HKB2100T
125	625	1250	KB2125	KB2125S	HKB2125	KB2250F	KB2250FS	HKB2250F	HKB2125T
150	750	1500	KB2150	KB2150S	HKB2150	KB2250F	KB2250FS	HKB2250F	HKB2150T
175	875	1750	KB2175	KB2175S	HKB2175	KB2250F	KB2250FS	HKB2250F	HKB2175T
200	1000	2000	KB2200	KB2200S	HKB2200	KB2250F	KB2250FS	HKB2250F	HKB2200T
225	1125	2250	KB2225	KB2225S	HKB2225	KB2250F	KB2250FS	HKB2250F	HKB2225T
250	1250	2500	KB2250	KB2250S	HKB2250	KB2250F	KB2250FS	HKB2250F	HKB2250T
Approx. shipping weight 12 lbs						Approx. shipping weight 9 lbs			Approx. shipping weight 2 lbs
Three-Pole, 600 Vac Only									
70	350	700	KB3070	KB3070S	HKB3070	KB3250F	KB3250FS	HKB3250F	HKB3070T
90	450	900	KB3090	KB3090S	HKB3090	KB3250F	KB3250FS	HKB3250F	HKB3090T
100	500	1000	KB3100	KB3100S	HKB3100	KB3250F	KB3250FS	HKB3250F	HKB3100T
125	625	1250	KB3125	KB3125S	HKB3125	KB3250F	KB3250FS	HKB3250F	HKB3125T
150	750	1500	KB3150	KB3150S	HKB3150	KB3250F	KB3250FS	HKB3250F	HKB3150T
175	875	1750	KB3175	KB3175S	HKB3175	KB3250F	KB3250FS	HKB3250F	HKB3175T
200	1000	2000	KB3200	KB3200S	HKB3200	KB3250F	KB3250FS	HKB3250F	HKB3200T
225	1125	2250	KB3225	KB3225S	HKB3225	KB3250F	KB3250FS	HKB3250F	HKB3225T
250	1250	2500	KB3250	KB3250S	HKB3250	KB3250F	KB3250FS	HKB3250F	HKB3250T
Approx. shipping weight 14 lbs						Approx. shipping weight 11 lbs			Approx. shipping weight 2 lbs

Magnetic Only, Front Adjustable Breakers ④

Continuous Ampere Rating	Magnetic Trip Setting Amperes ⑤		Trip Units Only	
	Low	High	Two-Pole ④ Catalog Number	Three-Pole Catalog Number
250	350	700	HKB2700TM	HKB3700TM
250	500	1000	HKB21000TM	HKB31000TM
250	625	1250	HKB21250TM	HKB31250TM
250	750	1500	HKB21500TM	HKB31500TM
250	875	1750	HKB21750TM	HKB31750TM
250	1125	2250	HKB22250TM	HKB32250TM
250	1250	2500	HKB22500TM	HKB32500TM

Notes

- ① These frames are obsolete. For replacement solutions, see the cross-reference on **Pages V12-T3-114–V12-T3-167**.
- ② Terminals shipped separately from breaker frame.
- ③ Not UL Listed.
- ④ Two-pole breakers are supplied in three-pole frames with current carrying parts omitted from center pole.
- ⑤ Set on high side, adjustable to lower limit.

UL Listed Interrupting Ratings

Maximum Volts	Amperes
Standard Breakers	
240 AC	30,000 asymmetrical, 25,000 symmetrical
480 AC	25,000 asymmetrical, 22,000 symmetrical
600 AC	15,000 asymmetrical, 14,000 symmetrical
250 DC	10,000
MARK 75 Breakers	
240 AC	75,000 asymmetrical., 65,000 symmetrical.
480 AC	30,000 asymmetrical, 25,000 symmetrical
600 AC	20,000 asymmetrical, 18,000 symmetrical
250 DC	20,000 ^①

Terminals ^②

Maximum Amperes	Number of Cables, Wire Range, Type	Catalog Number
Standard Al/Cu Pressure Terminals		
250	(1) #4–350 kcmil Al/Cu	TA250KB
Optional Pressure Terminals		
250	(1) #4–350 kcmil Cu	T250KB

Notes

- ① Ratings above 10,000A not UL Listed.
 ② Terminals shipped separately from breaker frame.

Accessories and Modifications

Shaded area denotes obsolete or discontinued products and services.

Magnetic Only, Front Adjustable Breakers (see table on Page V12-T3-21)

Special Calibrations

Special calibration price additions apply to ampere ratings not listed as standard or for ambients other than 40°C or 50°C. For frequencies other than 0–60 Hz AC, refer to Eaton.

Note: Two-pole breakers are supplied in three-pole frames with current carrying parts omitted from center pole.

50°C Calibration

Add suffix “V” to catalog number for complete breaker, listed on Page V12-T3-21, when ordering breakers to be used in 50°C ambients.

For CSA, see Page V12-T3-48.

Note: Two-pole breakers are supplied in three-pole frames with current carrying parts omitted from center pole.

Type KB breakers meet requirements for Class 19a, as defined by Federal Specification W-C-375b. Type HKB breakers not defined in W-C-375b.

UL Listed Interrupting Ratings (see table)

For all three-phase delta, grounded B phase applications, contact Avery Creek, NC, Technical Resource Center at **1-800-356-1243**.

Terminals (see table)

Two terminals are required per pole.

Terminals are UL Listed for wire type and range listed below. When used with aluminum conductors, use joint compound. To order optional copper only terminals, add suffix “C” to complete breaker catalog number.

Magnetic Only Breakers

For description, refer to Application Data 29-160. To order these breakers, select frame, trip unit and terminals.

Additional Accessories and Modifications

Refer to Pages V12-T3-65–V12-T3-79.

Type JA

Shaded area denotes obsolete or discontinued products and services. ①

JA: 600 Vac; 250 Vdc



Type JA 70–225A, 600 Vac, 250 Vdc, Two- and Three-Pole, Fixed Trip, Thermal-Magnetic, Saf-T-Vue (Suitable for Reverse-Feed)

Continuous Ampere Rating at 40°C	Magnetic Trip Setting, Amperes (Set on High Side, Adjustable to Lower Limits)		Complete Breaker Includes Pressure Type Aluminum Terminals ②		Breaker Without Terminals		
	Low	High	Standard Catalog Number	Saf-T-Vue Catalog Number	Standard Catalog Number	Saf-T-Vue Catalog Number	
Two-Pole, 600 Vac, 250 Vdc ③							
70	350	700	JA2070	JA2070S	JA2070W	JA2070SW	
90	450	900	JA2090	JA2090S	JA2090W	JA2090SW	
100	500	1000	JA2100	JA2100S	JA2100W	JA2100SW	
125	625	1250	JA2125	JA2125S	JA2125W	JA2125SW	
150	750	1500	JA2150	JA2150S	JA2150W	JA2150SW	
175	875	1750	JA2175	JA2175S	JA2175W	JA2175SW	
200	1000	2000	JA2200	JA2200S	JA2200W	JA2200SW	
225	1125	2250	JA2225	JA2225S	JA2225W	JA2225SW	
				Approx. shipping weight 12 lbs		Approx. shipping weight 12 lbs	

Three-Pole, 600 Vac Only

70	350	700	JA3070	JA3070S	JA3070W	JA3070SW	
90	450	900	JA3090	JA3090S	JA3090W	JA3090SW	
100	500	1000	JA3100	JA3100S	JA3100W	JA3100SW	
125	625	1250	JA3125	JA3125S	JA3125W	JA3125SW	
150	750	1500	JA3150	JA3150S	JA3150W	JA3150SW	
175	875	1750	JA3175	JA3175S	JA3175W	JA3175SW	
200	1000	2000	JA3200	JA3200S	JA3200W	JA3200SW	
225	1125	2250	JA3225	JA3225S	JA3225W	JA3225SW	
				Approx. shipping weight 14 lbs		Approx. shipping weight 12 lbs	

Special Breakers ④

Continuous Ampere Rating at 40°C	Magnetic Trip Setting, Amperes (Set on High Side, Adjustable to Lower Limits)		Two-Pole ④		Three-Pole	
	Low	High	Standard Catalog Number	Saf-T-Vue Catalog Number	Standard Catalog Number	Saf-T-Vue Catalog Number
Magnetic Only Breakers, Front Adjustable—Without Terminals ⑤						
225	350	700	JA2700MW	JA2700SMW	JA3700MW	JA3700SMW
225	625	1250	JA21250MW	JA21250SMW	JA31250MW	JA31250SMW
225	750	1500	JA21500MW	JA21500SMW	JA31500MW	JA31500SMW
225	875	1750	JA21750MW	JA21750SMW	JA31750MW	JA31750SMW
225	1125	2250	JA22250MW	JA22250SMW	JA32250MW	JA32250SMW

Ambient Compensating Breakers

70	350	700	JA2070A	—	JA3070A	—
100	500	1000	JA2100A	—	JA3100A	—
125	625	1250	JA2125A	—	JA3125A	—
150	750	1500	JA2150A	—	JA3150A	—
175	875	1750	JA2175A	—	JA3175A	—
200	1000	2000	JA2200A	—	JA3200A	—
225	1125	2250	JA2225A	—	JA3225A	—

Notes

- ① These frames are obsolete. For replacement solutions, see the cross-reference on **Pages V12-T3-114–V12-T3-167**.
- ② Terminals are shipped separately from breaker frame.
- ③ Not UL Listed.
- ④ Two-pole breakers are supplied in three-pole frames with current carrying parts omitted from center pole.
- ⑤ Select desired terminal from table and order as separate item.

UL Listed Interrupting Ratings

Maximum Volts	Amperes
240 AC	30,000 asymmetrical, 25,000 symmetrical
480 AC	25,000 asymmetrical, 22,000 symmetrical
600 AC	25,000 asymmetrical, 22,000 symmetrical
250 DC	10,000

Terminals

Maximum Amperes	Number of Cables, Wire Range, Type	Catalog Number
Standard Al/Cu Pressure Terminals		
70–225	(1) #6–350 kcmil Cu, or (1) #4–350 kcmil Al	TA225LA1
Optional Copper Pressure Terminals		
70–225	(1) #6–350 kcmil Cu	T225LA
70–225 ①	(1) #6–250 kcmil Cu	T225LBF

Note

① Optional terminal.

Accessories and Modifications

■ Shaded area denotes obsolete or discontinued products and services.

Special Calibrations (see table on Page V12-T3-23)

Special calibration price additions apply to ampere ratings not listed as standard or for ambients other than 40°C or 50°C. For frequencies other than 0–60 Hz AC, refer to Eaton.

See Application Data 29-160 for information regarding special conditions.

Note: Not UL Listed.

50°C Calibration

Add suffix “V” to catalog number for complete breaker when ordering breakers to be used in 50°C ambients.

For CSA, see Page V12-T3-48.

Type JA breakers meet requirements of Class 19a and 20a circuit breakers as defined by Federal Specification W-C-375b.

For all three-phase delta, grounded B phase applications, contact Avery Creek, NC, Technical Resource Center at **1-800-356-1243**.

Terminals (see table)

Two terminals are required per pole.

Terminals are UL Listed for wire type and range listed left. When used with aluminum conductors, use joint compound. To order optional copper only terminals, add suffix “C” to complete breaker catalog number.

Note: Terminals are shipped separately from breaker frame.

Note: If upgrading a JA breaker to a Series C K-Frame in a panelboard application, order TAD3 spacer kit.

UL Listed Interrupting Ratings (see table)**Magnetic Only and Ambient Compensating Breakers**

For description, refer to Application Data 29-160. To order, select catalog number from table on **Page V12-T3-23**.

Types KA and HKA

Shaded area denotes obsolete or discontinued products and services. ①

KA: 600 Vac; 250 Vdc



Type KA 70–225A, 600 Vac, 250 Vdc, Two- and Three-Pole, Interchangeable Trip, Thermal-Magnetic, Saf-T-Vue and MARK 75 Type HKA

Continuous Ampere Rating at 40°C	Magnetic Trip Setting Amperes ②		Complete Breaker Includes Pressure Type Aluminum Terminals ③			Shipped as Frame, Trip Unit and Terminals			Trip Unit Only Standard MARK 75 or Saf-T-Vue Catalog Number
	Low	High	Standard Catalog Number	Saf-T-Vue Catalog Number	MARK 75 Catalog Number	Standard Catalog Number	Saf-T-Vue Catalog Number	MARK 75 Catalog Number	
Two-Pole, 600 Vac, 250 Vdc ④									
70	350	700	KA2070	KA2070S	HKA2070	KA2225F	KA2225FS	HKA2225F	HKA2070T
90	450	900	KA2090	KA2090S	HKA2090	KA2225F	KA2225FS	HKA2225F	HKA2090T
100	500	1000	KA2100	KA2100S	HKA2100	KA2225F	KA2225FS	HKA2225F	HKA2100T
125	625	1250	KA2125	KA2125S	HKA2125	KA2225F	KA2225FS	HKA2225F	HKA2125T
150	750	1500	KA2150	KA2150S	HKA2150	KA2225F	KA2225FS	HKA2225F	HKA2150T
175	875	1750	KA2175	KA2175S	HKA2175	KA2225F	KA2225FS	HKA2225F	HKA2175T
200	1000	2000	KA2200	KA2200S	HKA2200	KA2225F	KA2225FS	HKA2225F	HKA2200T
225	1125	2250	KA2225	KA2225S	HKA2225	KA2225F	KA2225FS	HKA2225F	HKA2225T
Approx. shipping weight 12 lbs						Approx. shipping weight 9.5 lbs			Approx. shipping weight 2 lbs
Three-Pole, 600 Vac Only									
70	350	700	KA3070	KA3070S	HKA3070	KA3225F	KA3225FS	HKA3225F	HKA3070T
90	450	900	KA3090	KA3090S	HKA3090	KA3225F	KA3225FS	HKA3225F	HKA3090T
100	500	1000	KA3100	KA3100S	HKA3100	KA3225F	KA3225FS	HKA3225F	HKA3100T
125	625	1250	KA3125	KA3125S	HKA3125	KA3225F	KA3225FS	HKA3225F	HKA3125T
150	750	1500	KA3150	KA3150S	HKA3150	KA3225F	KA3225FS	HKA3225F	HKA3150T
175	875	1750	KA3175	KA3175S	HKA3175	KA3225F	KA3225FS	HKA3225F	HKA3175T
200	1000	2000	KA3200	KA3200S	HKA3200	KA3225F	KA3225FS	HKA3225F	HKA3200T
225	1125	2250	KA3225	KA3225S	HKA3225	KA3225F	KA3225FS	HKA3225F	HKA3225T
Approx. shipping weight 14 lbs					Approx. shipping weight 11 lbs			Approx. shipping weight 2.5 lb.	

Trip Units Only for Magnetic Only and Ambient Compensating Breakers ⑤

Continuous Ampere Rating	Magnetic Trip Setting, Amperes ②		Two-Pole ④ Catalog Number	Three-Pole Catalog Number
	Low	High		
Magnetic Only, Front Adjustable Breakers				
225	350	700	HKA2700TM	HKA3700TM
225	625	1250	HKA21250TM	HKA31250TM
225	750	1500	HKA21500TM	HKA31500TM
225	875	1750	HKA21750TM	HKA31750TM
225	1125	2250	HKA22250TM	HKA32250TM
Ambient Compensating Breakers				
70	350	700	HKA2070TA	HKA3070TA
100	500	1000	HKA2100TA	HKA3100TA
125	625	1250	HKA2125TA	HKA3125TA
150	750	1500	HKA2150TA	HKA3150TA
175	875	1750	HKA2175TA	HKA3175TA
200	1000	2000	HKA2200TA	HKA3200TA
225	1125	2250	HKA2225TA	HKA3225TA

Notes

- ① These frames are obsolete. For replacement solutions, see the cross-reference on Pages V12-T3-114–V12-T3-167.
- ② Set on high side, adjustable to lower limit.
- ③ Terminals are shipped separately from breaker frame.
- ④ Two-pole breakers are supplied in three-pole frames with current carrying parts omitted from center pole.
- ⑤ Not UL Listed.

UL Listed Interrupting Ratings

Maximum Volts	Amperes
Standard Breakers	
240 AC	30,000 asymmetrical, 25,000 symmetrical
480 AC	25,000 asymmetrical, 22,000 symmetrical
600 AC	25,000 asymmetrical, 22,000 symmetrical
250 DC	10,000
MARK 75 Breakers	
240 AC	75,000 asymmetrical, 65,000 symmetrical
480 AC	40,000 asymmetrical, 35,000 symmetrical
600 AC	30,000 asymmetrical, 25,000 symmetrical
250 DC	20,000 ^①

Terminals

Maximum Amperes	Number of Cables, Wire Range, Type	Catalog Numbers
Standard Al/Cu Pressure Terminals		
225	(1) #6–350 kcmil Cu, or (1) #4–350 kcmil Al	TA225LA1
Optional Copper Pressure Terminals		
225	(1) #6–350 kcmil Cu	T225LA
225 ^②	(1) #6–250 kcmil Cu	T225LBF

Notes

- ^① Ratings above 10,000A not UL Listed.
^② Optional terminal.

Accessories and Modifications

■ Shaded area denotes obsolete or discontinued products and services.

Special Calibrations

Special calibration price additions apply to ampere ratings not listed as standard or for ambients other than 40°C or 50°C. For frequencies other than 0–60 Hz AC, refer to Eaton. See Application Data 29-160 for information regarding special conditions.

Note: Not UL Listed.

50°C Calibration

Add suffix "V" to catalog number for complete breaker when ordering breakers to be used in 50°C ambients.

Note: Not UL Listed.

Terminals (see table)

Two terminals are required per pole.

Terminals are UL Listed for wire type and range listed below. When used with aluminum conductors, use joint compound. To order optional copper only terminals, add suffix "C" to complete breaker catalog number.

Type KA breakers meet requirements for Class 19a and 20a circuit breakers, and Type HKA meet requirements for Class 23a as defined by Federal Specification W-C-375b.

For all three-phase delta, grounded B phase applications, contact Avery Creek, NC, Technical Resource Center at **1-800-356-1243**.

Note: Terminals are shipped separately from breaker frame.

Note: If upgrading a KA, HKA breaker to a Series C K-Frame in a panelboard application, also order TAD3 spacer kit.

UL Listed Interrupting Ratings (see table)**Magnetic Only Breakers**

For description, refer to Application Data 29-160. To order these breakers, select frame, trip unit and terminals.

Type LBB

Shaded area denotes obsolete or discontinued products and services. ①

LBB: 600 Vac; 250 Vdc



Type LBB 125–400A, 600 Vac, 250 Vdc, Two- and Three-Pole, Fixed Trip, Thermal-Magnetic, Saf-T-Vue (Suitable for Reverse-Feed)

Continuous Ampere Rating at 40°C	Magnetic Trip Setting, Amperes ②		Complete Breaker Includes Pressure Type Aluminum Terminals ③		Breaker Without Terminals		
	Low	High	Standard Catalog Number	Saf-T-Vue Catalog Number	Standard Catalog Number	Saf-T-Vue Catalog Number	
Two-Pole, 600 Vdc, 250 Vdc ④							
125	625	1250	LBB2125	LBB2125S	LBB2125W	LBB2125SW	
150	750	1500	LBB2150	LBB2150S	LBB2150W	LBB2150SW	
175	875	1750	LBB2175	LBB2175S	LBB2175W	LBB2175SW	
200	1000	2000	LBB2200	LBB2200S	LBB2200W	LBB2200SW	
225	1125	2250	LBB2225	LBB2225S	LBB2225W	LBB2225SW	
250	1250	2500	LBB2250	LBB2250S	LBB2250W	LBB2250SW	
300	1500	3000	LBB2300	LBB2300S	LBB2300W	LBB2300SW	
350	1750	3500	LBB2350	LBB2350S	LBB2350W	LBB2350SW	
400	2000	4000	LBB2400	LBB2400S	LBB2400W	LBB2400SW	
				Approx. shipping weight 13 lbs		Approx. shipping weight 13 lbs	
Three-Pole, 600 Vac Only							
125	625	1250	LBB3125	LBB3125S	LBB3125W	LBB3125SW	
150	750	1500	LBB3150	LBB3150S	LBB3150W	LBB3150SW	
175	875	1750	LBB3175	LBB3175S	LBB3175W	LBB3175SW	
200	1000	2000	LBB3200	LBB3200S	LBB3200W	LBB3200SW	
225	1125	2250	LBB3225	LBB3225S	LBB3225W	LBB3225SW	
250	1250	2500	LBB3250	LBB3250S	LBB3250W	LBB3250SW	
300	1500	3000	LBB3300	LBB3300S	LBB3300W	LBB3300SW	
350	1750	3500	LBB3350	LBB3350S	LBB3350W	LBB3350SW	
400	2000	4000	LBB3400	LBB3400S	LBB3400W	LBB3400SW	
				Approx. shipping weight 15 lbs		Approx. shipping weight 15 lbs	

Notes

- ① These frames are obsolete. For replacement solutions, see the cross-reference on Pages V12-T3-114–V12-T3-167.
- ② Set on high side, adjustable to lower limits.
- ③ Terminals are shipped separately from breaker.
- ④ Two-pole breakers or trips are supplied in three-pole frames with current carrying parts omitted from center pole.

Shaded area denotes obsolete or discontinued products and services. ①

Magnetic Only, Ambient Compensating Breakers ②

Continuous Ampere Rating	Magnetic Trip Setting, Amperes ③		Two-Pole Breakers ④		Three-Pole Breakers	
	Low	High	Standard Catalog Number	Saf-T-Vue Catalog Number	Standard Catalog Number	Saf-T-Vue Catalog Number
Magnetic Only Breakers, Front Adjustable—Without Terminals ⑤						
400	350	700	LBB2700MW	LBB2700SMW	LBB3700MW	LBB3700SMW
400	625	1250	LBB21250MW	LBB21250SMW	LBB31250MW	LBB31250SMW
400	750	1500	LBB21500MW	LBB21500SMW	LBB31500MW	LBB31500SMW
400	875	1750	LBB21750MW	LBB21750SMW	LBB31750MW	LBB31750SMW
400	1125	2250	LBB22250MW	LBB22250SMW	LBB32250MW	LBB32250SMW
400	1500	3000	LBB23000MW	LBB23000SMW	LBB33000MW	LBB33000SMW
400	2000	4000	LBB24000MW	LBB24000SMW	LBB34000MW	LBB34000SMW

Ambient Compensating Breakers—Includes Terminals

125	625	1250	LBB2125A	LBB2125SA	LBB3125A	LBB3125SA
150	750	1500	LBB2150A	LBB2150SA	LBB3150A	LBB3150SA
175	875	1750	LBB2175A	LBB2175SA	LBB3175A	LBB3175SA
200	1000	2000	LBB2200A	LBB2200SA	LBB3200A	LBB3200SA
225	1125	2250	LBB2225A	LBB2225SA	LBB3225A	LBB3225SA
250	1250	2500	LBB2250A	LBB2250SA	LBB3250A	LBB3250SA
300	1500	3000	LBB2300A	LBB2300SA	LBB3300A	LBB3300SA
350	1750	3500	LBB2350A	LBB2350SA	LBB3350A	LBB3350SA
400	2000	4000	LBB2400A	LBB2400SA	LBB3400A	LBB3400SA

UL Listed Interrupting Ratings

Maximum Volts	Amperes
240 AC	50,000 asymmetrical, 42,000 symmetrical
480 AC	35,000 asymmetrical, 30,000 symmetrical
600 AC	25,000 asymmetrical, 22,000 symmetrical
250 DC	20,000 ⑥

Accessories and Modifications

Shaded area denotes obsolete or discontinued products and services.

Special Calibrations

Special calibration price additions apply to ampere ratings not listed as standard or for ambients other than 40°C or 50°C. For frequencies other than 0–60 Hz AC, refer to Eaton. See Application Data 29-160 for information regarding special conditions. Maximum calibration for 400 Hz is 300A.

Note: Not UL Listed.

50°C Calibration

Add suffix "V" to catalog number for complete breaker when ordering breakers to be used in 50°C ambients.

Note: Not UL Listed.

Terminals

Two terminals required per pole.

Select from **Page V12-T3-35**.

Note: Terminals are shipped separately from breaker.

Note: If upgrading an LBB breaker to a Series C K-Frame in a panelboard application, also order TAD3 spacer kit.

For CSA, see Page V12-T3-48.

Type LBB breakers meet requirements for Class 21a circuit breakers, as defined by Federal Specification W-C-375b.

UL Listed Interrupting Ratings (see table)

For all three-phase delta, grounded B phase applications, contact Avery Creek, NC, Technical Resource Center at **1-800-356-1243**.

Magnetic Only Breakers

For description, refer to Application Data 29-160. To order, select catalog number from table above.

Notes

- ① These frames are obsolete. For replacement solutions, see the cross-reference on **Pages V12-T3-114–V12-T3-167**.
- ② Not UL Listed.
- ③ Set on high side, adjustable to lower limits.
- ④ Two-pole breakers or trips are supplied in three-pole frames with current carrying parts omitted from center pole.
- ⑤ Select desired terminals from **V12-T3-30**, and order as separate item.
- ⑥ Ratings above 10,000A not UL Listed.

Types LB and HLB

■ Shaded area denotes obsolete or discontinued products and services. ①

LB: 600 Vac; 250 Vdc



Type LB and MARK 75 Type HLB 70–400A, 600 Vac, 250 Vdc, Two- and Three-Pole, Interchangeable Trip, Thermal-Magnetic, Saf-T-Vue and MARK 75

Continuous Ampere Rating at 40°C	Magnetic Trip Setting Amperes ②		Complete Breaker Includes Pressure Type Aluminum Terminals ③			Shipped as Frame, Trip Unit and Terminals ③				
	Low	High	Standard Catalog Number	Saf-T-Vue Catalog Number	MARK 75 Catalog Number	Frame Only		Trip Unit Only		
						Standard Catalog Number	Saf-T-Vue Catalog Number	MARK 75 Catalog Number	Standard Saf-T-Vue, MARK 75 Catalog Number	
Two-Pole, 600 Vac, 250 Vdc ④										
70	350	700	LB2070	LB2070S	—	LB2400F	LB2400FS	HLB2400F	HLB2070T	
90	450	900	LB2090	LB2090S	—	LB2400F	LB2400FS	HLB2400F	HLB2090T	
100	500	1000	LB2100	LB2100S	—	LB2400F	LB2400FS	HLB2400F	HLB2100T	
125	625	1250	LB2125	LB2125S	HLB2125	LB2400F	LB2400FS	HLB2400F	HLB2125T	
150	750	1500	LB2150	LB2150S	HLB2150	LB2400F	LB2400FS	HLB2400F	HLB2150T	
175	875	1750	LB2175	LB2175S	HLB2175	LB2400F	LB2400FS	HLB2400F	HLB2175T	
200	1000	2000	LB2200	LB2200S	HLB2200	LB2400F	LB2400FS	HLB2400F	HLB2200T	
225	1125	2250	LB2225	LB2225S	HLB2225	LB2400F	LB2400FS	HLB2400F	HLB2225T	
250	1250	2500	LB2250	LB2250S	HLB2250	LB2400F	LB2400FS	HLB2400F	HLB2250T	
300	1500	3000	LB2300	LB2300S	HLB2300	LB2400F	LB2400FS	HLB2400F	HLB2300T	
350	1750	3500	LB2350	LB2350S	HLB2350	LB2400F	LB2400FS	HLB2400F	HLB2350T	
400	2000	4000	LB2400	LB2400S	HLB2400	LB2400F	LB2400FS	HLB2400F	HLB2400T	
					Approx. shipping weight 13 lbs	Approx. shipping weight 10 lbs			Approx. shipping weight 2 lbs	
Three-Pole, 600 Vac Only										
70	350	700	LB3070	LB3070S	—	LB3400F	LB3400FS	HLB3400F	HLB3070T	
90	450	900	LB3090	LB3090S	—	LB3400F	LB3400FS	HLB3400F	HLB3090T	
100	500	1000	LB3100	LB3100S	—	LB3400F	LB3400FS	HLB3400F	HLB3100T	
125	625	1250	LB3125	LB3125S	HLB3125	LB3400F	LB3400FS	HLB3400F	HLB3125T	
150	750	1500	LB3150	LB3150S	HLB3150	LB3400F	LB3400FS	HLB3400F	HLB3150T	
175	875	1750	LB3175	LB3175S	HLB3175	LB3400F	LB3400FS	HLB3400F	HLB3175T	
200	1000	2000	LB3200	LB3200S	HLB3200	LB3400F	LB3400FS	HLB3400F	HLB3200T	
225	1125	2250	LB3225	LB3225S	HLB3225	LB3400F	LB3400FS	HLB3400F	HLB3225T	
250	1250	2500	LB3250	LB3250S	HLB3250	LB3400F	LB3400FS	HLB3400F	HLB3250T	
300	1500	3000	LB3300	LB3300S	HLB3300	LB3400F	LB3400FS	HLB3400F	HLB3300T	
350	1750	3500	LB3350	LB3350S	HLB3350	LB3400F	LB3400FS	HLB3400F	HLB3350T	
400	2000	4000	LB3400	LB3400S	HLB3400	LB3400F	LB3400FS	HLB3400F	HLB3400T	
					Approx. shipping weight 15 lbs	Approx. shipping weight 12 lbs			Approx. shipping weight 2.5 lbs	

Notes

- ① These frames are obsolete. For replacement solutions, see the cross-reference on **Pages V12-T3-126–V12-T3-167**.
- ② Set on high side, adjustable to lower limits.
- ③ Terminals are shipped separately from breaker.
- ④ Two-pole breakers or trips are supplied in three-pole frames with current carrying parts omitted from center pole.

Shaded area denotes obsolete or discontinued products and services. ①

Special Breakers—Trip Units Only ②

Continuous Ampere Rating	Magnetic Trip Setting, Amperes ③		Trip Unit Only	
	Low	High	Two-Pole ④ Catalog Number	Three-Pole Catalog Number
Magnetic Only Breakers, Front Adjustable				
400	350	700	HLB2700TM	HLB3700TM
400	625	1250	HLB21250TM	HLB31250TM
400	750	1500	HLB21500TM	HLB31500TM
400	875	1750	HLB21750TM	HLB31750TM
400	1125	2250	HLB22250TM	HLB32250TM
400	1125	2250	HLB22250TM	HLB32250TM
400	1500	3000	HLB23000TM	HLB33000TM
400	2000	4000	HLB24000TM	HLB34000TM

Ambient Compensating Breakers

70	350	700	HLB2070TA	HLB3070TA
90	450	900	HLB2090TA	HLB3090TA
100	500	1000	HLB2100TA	HLB3100TA
125	625	1250	HLB2125TA	HLB3125TA
150	750	1500	HLB2150TA	HLB3150TA
175	875	1750	HLB2175TA	HLB3175TA
200	1000	2000	HLB2200TA	HLB3200TA
225	1125	2250	HLB2225TA	HLB3225TA
250	1250	2500	HLB2250TA	HLB3250TA
300	1500	3000	HLB2300TA	HLB3300TA
350	1750	3500	HLB2350TA	HLB3350TA
400	2000	4000	HLB2400TA	HLB3400TA

Accessories and Modifications

Shaded area denotes obsolete or discontinued products and services.

Special Calibrations

Special calibration price additions apply to ampere ratings not listed as standard or for ambients other than 40°C or 50°C. For frequencies other than 0–60 Hz AC circuits, refer to Eaton. See Application Data 29-160 for information regarding special conditions. Maximum calibration for 400 Hz is 300A.

Note: Not UL Listed.

50°C Calibration

Add suffix “V” to catalog number for complete breaker or trip unit only, when ordering breakers to be used in 50°C ambients.

Note: Not UL Listed.

Magnetic Only Breakers

For description, refer to Application Data 29-160. To order, select trip unit from table above, frame and terminals.

Note: Not UL Listed.

For CSA, see Page V12-T3-48.

Type LB breakers meet requirements for Class 21a circuit breakers, and Type HLB meet requirements for Class 23a, as defined by Federal Specification W-C-375b.

UL Listed Interrupting Ratings

Maximum Volts	Amperes
Standard Breakers	
240 AC	50,000 asymmetrical, 42,000 symmetrical
480 AC	35,000 asymmetrical, 30,000 symmetrical
600 AC	25,000 asymmetrical, 22,000 symmetrical
250 DC	20,000 ⑤
MARK 75 Breakers	
240 AC	75,000 asymmetrical, 65,000 symmetrical
480 AC	40,000 asymmetrical, 35,000 symmetrical
600 AC	30,000 asymmetrical, 25,000 symmetrical
250 DC	20,000 ⑤

For all three-phase delta, grounded B phase applications, contact Avery Creek, NC, Technical Resource Center at **1-800-356-1243**.

Terminals

Two terminals are required per pole.

Terminals are UL Listed for wire type and range listed below. When used with aluminum cable, use joint compound. To order optional copper only terminals, add suffix “C” to complete breaker catalog number.

Note: Terminals are shipped separately from breaker. If upgrading an LB, HLB breaker to a Series C K-Frame in a panelboard application, also order TAD3 spacer kit.

Terminals

Maximum Amperes	Number of Cables, Wire Range, Type	Catalog Number
Standard Pressure Terminals		
225	(1) #6–350 kcmil Cu, or (1) #4–350 kcmil Al	TA225LA1
350	(1) 250–500 kcmil Al/Cu	TA350DA
400	(2) 3/0–250 kcmil Cu only	T400DA2
Optional Copper Pressure Terminals		
225	(1) #6–350 kcmil Cu	T225LA
225 ⑥	(1) #6–250 kcmil Cu	T225LBF
350	(1) 250–500 kcmil Cu	T350DA

Notes

- ① These frames are obsolete. For replacement solutions, see the cross-reference on **Pages V12-T3-126–V12-T3-167**.
- ② Not UL Listed.
- ③ Set on high side, adjustable to lower limits.
- ④ Two-pole breakers or trips are supplied in three-pole frames with current carrying parts omitted from center pole.
- ⑤ Ratings above 10,000A not UL Listed.
- ⑥ Optional terminal.

Type DA

■ Shaded area denotes obsolete or discontinued products and services. ①

DA: 240 Vac; 250 Vdc



Type DA Breakers 250–400A, 240 Vac, 250 Vdc, Two- and Three-Pole, Fixed Trip, Thermal-Magnetic (Suitable for Reverse-Feed)

Continuous Ampere Rating at 40°C	Breakers With Line Terminals Only		Breakers With Line and Load Terminals	
	Two-Pole ② Catalog Number	Three-Pole Catalog Number	Two-Pole ② Catalog Number	Three-Pole Catalog Number
250	DA2250Y	DA3250Y	DA2250	DA3250
300	DA2300Y	DA3300Y	DA2300	DA3300
350	DA2350Y	DA3350Y	DA2350	DA3350
400	DA2400Y	DA3400Y	DA2400	DA3400
	Approx. shipping weight 13 lbs	Approx. shipping weight 15 lbs	Approx. shipping weight 13 lbs	Approx. shipping weight 13 lbs

Accessories and Modifications

■ Shaded area denotes obsolete or discontinued products and services

Type DA breakers meet requirements of Federal Specification W-C-375b., Class 14b.

UL Listed Interrupting Ratings

Maximum Volts	Amperes
240 AC	25,000 asymmetrical, 22,000 symmetrical
250 DC	10,000

For all three-phase delta, grounded B phase applications, contact Avery Creek, NC, Technical Resource Center at **1-800-356-1243**.

Terminals

Terminals are UL Listed for the wire type and size listed below. When used with aluminum conductors, use joint compound.

Terminals

Maximum Amperes	Number of Cables, Wire Range, Type	Catalog Number
Standard Pressure Terminals		
350	(1) 250–500 kcmil Al/Cu	TA350DA
400	(2) 3/0–250 kcmil Cu only	T400DA2
Optional Terminals (for Copper Cable)		
350	(1) 250–500 kcmil Cu	T350DA

Note: If upgrading a DA breaker to a Series C K-Frame in a panelboard application, also order TAD3 spacer kit.

For CSA, see Page V12-T3-48.

Special Calibrations

Special calibration price additions apply to ampere ratings not listed as standard or for ambients other than 40°C or 50°C. For frequencies other than 0–60 Hz AC circuits, refer to Eaton. See Application Data 29-160 for information regarding special conditions. Maximum 400 Hz calibrations: Type DA, 300A.

Note: Not UL Listed.

50°C Calibration

Add suffix “V” to catalog number for complete breaker when ordering breakers to be used in 50°C ambients. Same price as standard 40°C breakers.

Note: Not UL Listed.

Notes

- ① These frames are obsolete. For replacement solutions, see the cross-reference on Pages V12-T3-114–V12-T3-167.
- ② Two-pole breakers are supplied in three-pole frames.

Type LAB

Shaded area denotes obsolete or discontinued products and services. ①

LAB: 600 Vac; 250 Vdc



Type LAB 125–400A, 600 Vac, 250 Vdc, Two- and Three-Pole, Fixed Trip, Thermal-Magnetic, Saf-T-Vue (Suitable for Reverse-Feed)

Continuous Ampere Rating at 40°C	Magnetic Trip Setting, Amperes ②		Complete Breaker Includes Pressure Type Aluminum Terminals ③		Breaker Without Terminals		
	Low	High	Standard Catalog Number	Saf-T-Vue Catalog Number	Standard Catalog Number	Saf-T-Vue Catalog Number	
Two-Pole, 600 Vac, 250 Vdc ④							
125	625	1250	LAB2125	LAB2125S	LAB2125W	LAB2125SW	
150	750	1500	LAB2150	LAB2150S	LAB2150W	LAB2150SW	
175	875	1750	LAB2175	LAB2175S	LAB2175W	LAB2175SW	
200	1000	2000	LAB2200	LAB2200S	LAB2200W	LAB2200SW	
225	1125	2250	LAB2225	LAB2225S	LAB2225W	LAB2225SW	
250	1250	2500	LAB2250	LAB2250S	LAB2250W	LAB2250SW	
300	1500	3000	LAB2300	LAB2300S	LAB2300W	LAB2300SW	
350	1750	3500	LAB2350	LAB2350S	LAB2350W	LAB2350SW	
400	2000	4000	LAB2400	LAB2400S	LAB2400W	LAB2400SW	
				Approx. shipping weight 22 lbs		Approx. shipping weight 22 lbs	
Three-Pole, 600 Vac Only							
125	625	1250	LAB3125	LAB3125S	LAB3125W	LAB3125SW	
150	750	1500	LAB3150	LAB3150S	LAB3150W	LAB3150SW	
175	875	1750	LAB3175	LAB3175S	LAB3175W	LAB3175SW	
200	1000	2000	LAB3200	LAB3200S	LAB3200W	LAB3200SW	
225	1125	2250	LAB3225	LAB3225S	LAB3225W	LAB3225SW	
250	1250	2500	LAB3250	LAB3250S	LAB3250W	LAB3250SW	
300	1500	3000	LAB3300	LAB3300S	LAB3300W	LAB3300SW	
350	1750	3500	LAB3350	LAB3350S	LAB3350W	LAB3350SW	
400	2000	4000	LAB3400	LAB3400S	LAB3400W	LAB3400SW	
				Approx. shipping weight 24.5 lbs		Approx. shipping weight 24.5 lbs	

Notes

- ① These frames are obsolete. For replacement solutions, see the cross-reference on Pages V12-T3-114–V12-T3-167.
- ② Set on high side, adjustable to lower limits.
- ③ Terminals shipped separately from breaker.
- ④ Two-pole breakers or trips are supplied in three-pole frames with current carrying parts omitted from center pole.

Shaded area denotes obsolete or discontinued products and services. ①

Special Breakers ②

Continuous Ampere Rating	Magnetic Trip Setting, Amperes ③		Breaker Catalog Number		Breaker Catalog Number	
	Low	High	Two-Pole ④ Standard Catalog Number	Saf-T-Vue Catalog Number	Three-Pole Standard Catalog Number	Saf-T-Vue Catalog Number
Magnetic Only Breakers, Front Adjustable—Without Terminals ⑤						
400	350	700	LAB2700MW	LAB2700SMW	LAB3700MW	LAB3700SMW
400	625	1250	LAB21250MW	LAB21250SMW	LAB31250MW	LAB31250SMW
400	750	1500	LAB21500MW	LAB21500SMW	LAB31500MW	LAB31500SMW
400	875	1750	LAB21750MW	LAB21750SMW	LAB31750MW	LAB31750SMW
400	1125	2250	LAB22250MW	LAB22250SMW	LAB32250MW	LAB32250SMW
400	1500	3000	LAB23000MW	LAB23000SMW	LAB33000MW	LAB33000SMW
400	2000	4000	LAB24000MW	LAB24000SMW	LAB34000MW	LAB34000SMW

Ambient Compensating Breakers—Includes Terminals

125	625	1250	LAB2125A	—	LAB3125A	—
150	750	1500	LAB2150A	—	LAB3150A	—
175	875	1750	LAB2175A	—	LAB3175A	—
200	1000	2000	LAB2200A	—	LAB3200A	—
225	1125	2250	LAB2225A	—	LAB3225A	—
250	1250	2500	LAB2250A	—	LAB3250A	—
300	1500	3000	LAB2300A	—	LAB3300A	—
350	1750	3500	LAB2350A	—	LAB3350A	—
400	2000	4000	LAB2400A	—	LAB3400A	—

Accessories and Modifications

Shaded area denotes obsolete or discontinued products and services.

Special Calibrations

Special calibration price additions apply to ampere ratings not listed as standard or for ambients other than 40°C or 50°C. For frequencies other than 0–60 Hz AC circuits, refer to Eaton. See Application Data 29-160 for information regarding special conditions. Maximum calibration for 400 Hz is 300A.

Note: Not UL Listed.

50°C Calibration

Add suffix “V” to catalog number for complete breaker when ordering breakers to be used in 50°C ambients. **For CSA, see Page V12-T3-48.**

Note: Not UL Listed.

Type LAB breakers meet requirements for Class 21a circuit breakers, as defined by Federal Specification W-C-375b.

UL Listed Interrupting Ratings ⑥

Maximum Volts	Amperes
240 AC	50,000 asymmetrical, 42,000 symmetrical
480 AC	35,000 asymmetrical, 30,000 symmetrical
600 AC	25,000 asymmetrical, 22,000 symmetrical
250 DC	20,000 ⑦

For all three-phase delta, grounded B phase applications, contact Avery Creek, NC, Technical Resource Center at **1-800-356-1243**.

Terminals

Two terminals required per pole.

Select from the table on **Page V12-T3-36**.

Note: Terminals shipped separately from breaker.

Magnetic Only and Ambient Compensating Breakers

To order, select catalog number from “Special Breakers” table above.

Additional Accessories and Modifications

Refer to **Pages V12-T3-65–V12-T3-79**.

Notes

- ① These frames are obsolete. For replacement solutions, see the cross-reference on **Pages V12-T3-114–V12-T3-167**.
- ② Not UL Listed.
- ③ Set on high side, adjustable to lower limits.
- ④ Two-pole breakers or trips are supplied in three-pole frames with current carrying parts omitted from center pole.
- ⑤ Select desired terminals from **Page V12-T3-39** and order as separate item.
- ⑥ Interrupting capacities shown do not apply to molded-case switches.
- ⑦ Ratings above 10,000A not UL Listed.

Types LA and HLA

Shaded area denotes obsolete or discontinued products and services. ①

LA: 600 Vac; 250 Vdc



3

Type LA and MARK 75 Type HLA 70–400A, 600 Vac, 250 Vdc, Two- and Three-Pole, Interchangeable Trip

Continuous Ampere Rating at 40°C	Magnetic Trip Setting Amperes ②		Complete Breaker Includes Pressure Type Aluminum Terminals ③			Shipped as Frame, Trip Unit and Terminals Frame Only			Trip Unit Only Standard, MARK 75, Saf-T-Vue Catalog Number
	Low	High	Standard Catalog Number	Saf-T-Vue Catalog Number	MARK 75 Catalog Number	Standard Catalog Number	Saf-T-Vue Catalog Number	MARK 75 Catalog Number	
400A Frame Breakers ④—Two-Pole, 600 Vac, 250 Vdc ⑤									
70 ⑥	350	700	LA2070	LA2070S	HLA2070	LA2400F	LA2400FS	HLA2400F	HLA2070T
90 ⑥	450	900	LA2090	LA2090S	HLA2090	LA2400F	LA2400FS	HLA2400F	HLA2090T
100 ⑥	500	1000	LA2100	LA2100S	HLA2100	LA2400F	LA2400FS	HLA2400F	HLA2100T
125	625	1250	LA2125	LA2125S	HLA2125	LA2400F	LA2400FS	HLA2400F	HLA2125T
150	750	1500	LA2150	LA2150S	HLA2150	LA2400F	LA2400FS	HLA2400F	HLA2150T
175	875	1750	LA2175	LA2175S	HLA2175	LA2400F	LA2400FS	HLA2400F	HLA2175T
200	1000	2000	LA2200	LA2200S	HLA2200	LA2400F	LA2400FS	HLA2400F	HLA2200T
225	1125	2250	LA2225	LA2225S	HLA2225	LA2400F	LA2400FS	HLA2400F	HLA2225T
250	1250	2500	LA2250	LA2250S	HLA2250	LA2400F	LA2400FS	HLA2400F	HLA2250T
300	1500	3000	LA2300	LA2300S	HLA2300	LA2400F	LA2400FS	HLA2400F	HLA2300T
350	1750	3500	LA2350	LA2350S	HLA2350	LA2400F	LA2400FS	HLA2400F	HLA2350T
400	2000	4000	LA2400	LA2400S	HLA2400	LA2400F	LA2400FS	HLA2400F	HLA2400T
Approx. shipping weight 21.75 lbs						Approx. shipping weight 17.5 lbs			Approx. shipping weight 2.25 lbs

Three-Pole, 600 Vac Only

70 ⑥	350	700	LA3070	LA3070S	HLA3070	LA3400F	LA3400FS	HLA3400F	HLA3070T
90 ⑥	450	900	LA3090	LA3090S	HLA3090	LA3400F	LA3400FS	HLA3400F	HLA3090T
100 ⑥	500	1000	LA3100	LA3100S	HLA3100	LA3400F	LA3400FS	HLA3400F	HLA3100T
125	625	1250	LA3125	LA3125S	HLA3125	LA3400F	LA3400FS	HLA3400F	HLA3125T
150	750	1500	LA3150	LA3150S	HLA3150	LA3400F	LA3400FS	HLA3400F	HLA3150T
175	875	1750	LA3175	LA3175S	HLA3175	LA3400F	LA3400FS	HLA3400F	HLA3175T
200	1000	2000	LA3200	LA3200S	HLA3200	LA3400F	LA3400FS	HLA3400F	HLA3200T
225	1125	2250	LA3225	LA3225S	HLA3225	LA3400F	LA3400FS	HLA3400F	HLA3225T
250	1250	2500	LA3250	LA3250S	HLA3250	LA3400F	LA3400FS	HLA3400F	HLA3250T
300	1500	3000	LA3300	LA3300S	HLA3300	LA3400F	LA3400FS	HLA3400F	HLA3300T
350	1750	3500	LA3350	LA3350S	HLA3350	LA3400F	LA3400FS	HLA3400F	HLA3350T
400	2000	4000	LA3400	LA3400S	HLA3400	LA3400F	LA3400FS	HLA3400F	HLA3400T
Approx. shipping weight 24.5 lbs						Approx. shipping weight 19 lbs			Approx. shipping weight 3 lbs

Notes

- ① These frames are obsolete. For replacement solutions, see the cross-reference on **Pages V12-T3-114–V12-T3-167**.
- ② Set on high side, adjustable to lower limits.
- ③ Terminals shipped separately from breaker.
- ④ Terminals, trip units and accessories are not interchangeable between 400 and 600A frames.
- ⑤ Two-pole breakers or trips are supplied in three-pole frames with current carrying parts omitted from center pole.
- ⑥ These ratings have interrupting capacities reduced to 25,000A symmetrical at 240V, 20,000A symmetrical at 480V, and 15,000A symmetrical at 600V.

■ Shaded area denotes obsolete or discontinued products and services. ①

Special Breakers ②—Trip Units Only

Continuous Ampere Rating	Magnetic Trip Setting, Amperes ③		Two-Pole ④ Catalog Number	Three-Pole Catalog Number
	Low	High		
Magnetic Only Breakers, Front Adjustable—400A Frame Breakers ⑤				
400	350	700	HLA2700TM	HLA3700TM
400	625	1250	HLA21250TM	HLA31250TM
400	750	1500	HLA21500TM	HLA31500TM
400	875	1750	HLA21750TM	HLA31750TM
400	1125	2250	HLA22250TM	HLA32250TM
400	1500	3000	HLA23000TM	HLA33000TM
400	2000	4000	HLA24000TM	HLA34000TM
Ambient Compensating Breakers—400A Frame Breakers Only ⑤				
70 ⑥	350	700	HLA2070TA	HLA3070TA
90 ⑥	450	900	HLA2090TA	HLA3090TA
100 ⑥	500	1000	HLA2100TA	HLA3100TA
125	625	1250	HLA2125TA	HLA3125TA
150	750	1500	HLA2150TA	HLA3150TA
175	875	1750	HLA2175TA	HLA3175TA
200	1000	2000	HLA2200TA	HLA3200TA
225	1125	2250	HLA2225TA	HLA3225TA
250	1250	2500	HLA2250TA	HLA3250TA
300	1500	3000	HLA2300TA	HLA3300TA
350	1750	3500	HLA2350TA	HLA3350TA
400	2000	4000	HLA2400TA	HLA3400TA

Notes

- ① These frames are obsolete. For replacement solutions, see the cross-reference on **Pages V12-T3-114–V12-T3-167**.
- ② Not UL Listed.
- ③ Set on high side, adjustable to lower limits.
- ④ Two-pole breakers or trips are supplied in three-pole frames with current carrying parts omitted from center pole.
- ⑤ Terminals, trip units and accessories are not interchangeable between 400 and 600A frames.
- ⑥ These ratings have interrupting capacities reduced to 25,000A symmetrical at 240V, 20,000A symmetrical at 480V, and 15,000A symmetrical at 600V.

3

Accessories and Modifications

Shaded area denotes obsolete or discontinued products and services.

Special Calibrations

Special calibration price additions apply to ampere ratings not listed as standard or for ambients other than 40°C or 50°C. For frequencies other than 0–60 Hz AC, refer to Eaton. See Application Data 29-160 for information regarding special conditions. Maximum 400 Hz calibration: 400A frame, 300A.

Note: Not UL Listed.

50°C Calibration

Add suffix “V” to catalog number for complete breaker or trip unit only, when ordering breakers to be used in 50°C ambients.

Note: Not UL Listed.

Terminals

Two terminals required per pole.

Select from table at right.

Note: Terminals shipped separately from breaker.

Magnetic Only Breakers

To order, select trip unit from the table on **Page V12-T3-35**, frame and terminals from table at right.

Note: Not UL Listed. MARK 75 frame color changed from gray to black in mid-2002.

UL Listed Except as Noted

Type LA breakers meet requirements for Class 21a circuit breakers, and Type HLA meet requirements for Class 23a as defined by Federal Specification W-C-375b.

UL Listed Interrupting Ratings ^①

	Maximum Volts	Amperes
Standard Breakers		
240 AC	50,000 asymmetrical, 42,000 symmetrical	
480 AC	35,000 asymmetrical, 30,000 symmetrical	
600 AC	25,000 asymmetrical, 22,000 symmetrical	
250 DC	20,000 ^②	
MARK 75 Breakers		
240 AC	75,000 asymmetrical, 65,000 symmetrical	
480 AC	40,000 asymmetrical, 35,000 symmetrical	
600 AC	30,000 asymmetrical, 25,000 symmetrical	
250 DC	20,000 ^②	

For all three-phase delta, grounded B phase applications, contact Avery Creek, NC, Technical Resource Center at **1-800-356-1243**.

Terminals

Two terminals are required per pole.

Terminals are UL Listed for wire type and range listed below. When used with aluminum cable, use joint compound. To order optional

copper only terminals, add suffix “C” to complete breaker catalog number.

Note: Terminals shipped separately from breaker. Terminals, trip units and accessories are not interchangeable between 400 and 600A frames.

Terminals

Maximum Amperes	Number of Cables, Wire Range, Type	Catalog Number
Standard Al/Cu Pressure Terminals		
225 ^③	(1) #6–350 kcmil Cu, or (1) #4–350 kcmil Al	TA225LA1
400 ^③	(1) #4–250 kcmil Al/Cu, plus (1) 3/0–600 kcmil Al/Cu	TA400LA1
Optional Copper Pressure Terminals		
225 ^③	(1) #6–350 kcmil Cu	T225LA
225 ^{③④}	(1) #6–250 kcmil Cu	T225LBF
400 ^③	(1) #4–250 kcmil Cu, plus (1) 3/0–600 kcmil Cu	T401LA

Notes

- ① Interrupting capacities do not apply to molded-case switches.
- ② Ratings above 10,000A not UL Listed.
- ③ 400A frame only.
- ④ Optional terminal.

Types LA and HLA

Shaded area denotes obsolete or discontinued products and services. ①

LA: 600 Vac; 250 Vdc



Type LA and MARK 75 Type HLA 250–600A, 600 Vac, 250 Vdc, Two-, Three-Pole, Interchangeable Trip Thermal-Magnetic, Saf-T-Vue and MARK 75 Breakers

Continuous Ampere Rating at 40°C	Magnetic Trip Setting, Amperes ②		Complete Breaker Includes Pressure Type Aluminum Terminals ③			Shipped as Frame, Trip Unit and Terminals ④			
	Low	High	Standard Catalog Number	Saf-T-Vue Catalog Number	MARK 75 Catalog Number	Frame Only		Trip Unit Only Standard Saf-T-Vue, MARK 75 Catalog Number	
						Standard Catalog Number	Saf-T-Vue Catalog Number	MARK 75 Catalog Number	
600A Frame Breakers ④—Two-Pole, 600 Vac, 250 Vdc ⑤									
250	1250	2500	2603D50G01	2603D50G13	1256C10G02	LA2600F	LA2600FS	HLA2600F	2603D46G07
300	1500	3000	2603D50G02	2603D50G14	1256C10G03	LA2600F	LA2600FS	HLA2600F	2603D46G08
350	1750	3500	2603D50G03	2603D50G15	1256C10G04	LA2600F	LA2600FS	HLA2600F	2603D46G09
350	1750	3500	2603D50G03	2603D50G15	1256C10G04	LA2600F	LA2600FS	HLA2600F	2603D46G09
400	2000	4000	2603D50G04	2603D50G16	1256C10G05	LA2600F	LA2600FS	HLA2600F	2603D46G10
500	2500	5000	LA2500	LA2500S	HLA2500	LA2600F	LA2600FS	HLA2600F	HLA2500T
600	3000	6000	LA2600	LA2600S	HLA2600	LA2600F	LA2600FS	HLA2600F	HLA2600T
Three-Pole, 600 Vac Only									
250	1250	2500	2603D50G07	2603D50G019	1256C10G12	LA3600F	LA3600FS	HLA3600F	2603D46G26
300	1500	3000	2603D50G08	2603D50G020	1256C10G13	LA3600F	LA3600FS	HLA3600F	2603D46G27
350	1750	3500	2603D50G09	2603D50G021	1256C10G14	LA3600F	LA3600FS	HLA3600F	2603D46G28
400	2000	4000	2603D50G10	2603D50G022	1256C10G15	LA3600F	LA3600FS	HLA3600F	2603D46G29
500	2500	5000	LA3500	LA3500S	HLA500	LA3600F	LA3600FS	HLA3600F	HLA3500T
600	3000	6000	LA3600	LA3600S	HLA3600	LA3600F	LA3600FS	HLA3600F	HLA3600T

Type Special Breakers ⑥—Trip Units Only

Continuous Ampere Rating	Magnetic Trip Setting, Amperes		Two-Pole ⑥ Catalog Number	Three-Pole Catalog Number
	Low	High		
600A Frame Breakers ④—Magnetic Only Breakers, Front Adjustable				
600	1125	2250	2603D47G07	2603D47G26
600	1500	3000	2603D47G08	2603D47G27
600	2000	4000	2603D47G10	2603D47G29
600	2500	5000	HLA25000TM	HLA35000TM
600	3000	6000	HLA26000TM	HLA36000TM
600A Frame Breakers—Ambient Compensating Breakers				
250	1250	2500	5683D88G07	5683D88G26
300	1500	3000	5683D88G08	5683D88G27
350	1750	3500	5683D88G09	5683D88G28
400	2000	4000	5683D88G10	5683D88G29
500	2500	5000	HLA2500TA	HLA3500TA
600	3000	6000	HLA2600TA	HLA3600TA

Notes

- ① These frames are obsolete. For replacement solutions, see the cross-reference on **Pages V12-T3-114–V12-T3-167**.
- ② Set on high side, adjustable to lower limits.
- ③ Terminals shipped separately from breakers.
- ④ Terminals, trip units and accessories are not interchangeable between 400 and 600A frames.
- ⑤ Two-pole breakers or trips are supplied in three-pole frames with current carrying parts omitted from center pole.
- ⑥ Not UL Listed.

Accessories and Modifications

Shaded area denotes obsolete or discontinued products and services.

3

Special Calibrations

Special calibration price additions apply to ampere ratings not listed as standard or for ambients other than 40°C or 50°C. For frequencies other than 0–60 Hz AC, refer to Eaton. See Application Data 29-160 for information regarding special conditions. Maximum 400 Hz calibration: 600A frame, 450A.

Note: Not UL Listed.

50°C Calibration

Add suffix “V” to catalog number for complete breaker or trip unit only, when ordering breakers to be used in 50°C ambients. Same price as standard 40°C breakers.

For CSA, see Page V12-T3-48.

Type LA breakers meet requirements for Class 21a circuit breakers, and type HLA meet requirements for Class 23a as defined by Federal Specification W-C-375b.

Note: Not UL Listed. MARK 75 frame color changed from gray to black in mid-2002.

UL Listed Interrupting Ratings ^①

Maximum Volts	Amperes
Standard Breakers	
240 AC	50,000 asymmetrical, 42,000 symmetrical
480 AC	35,000 asymmetrical, 30,000 symmetrical
600 AC	25,000 asymmetrical, 22,000 symmetrical
250 DC	20,000 ^②
MARK 75 Breakers	
240 AC	75,000 asymmetrical, 65,000 symmetrical
480 AC	40,000 asymmetrical, 35,000 symmetrical
600 AC	30,000 asymmetrical, 25,000 symmetrical
250 DC	20,000 ^②

For all three-phase delta, grounded B phase applications, contact Avery Creek, NC, Technical Resource Center at **1-800-356-1243**.

Terminals

Two terminals are required per pole. Terminals are UL Listed for wire type and range listed below. When used with aluminum cable, use joint compound. To order optional copper only terminals, add suffix “C” to complete breaker catalog number.

Note: Terminals shipped separately from breakers. Terminals, trip units and accessories are not interchangeable between 400 and 600A frames.

Terminals

Maximum Amperes	Number of Cables, Wire Range, Type	Catalog Number
Standard Al/Cu Pressure Terminals		
600 ^③	(2) 250–500 kcmil Al/Cu	TA600LA
Optional Copper Pressure Terminals		
600 ^③	(2) 250–500 kcmil Cu	T600LA

Notes

- ^① Interrupting capacities shown do not apply to molded case switches.
- ^② Ratings above 10,000A not UL Listed.
- ^③ For 600A frame breakers only.

Magnetic Only Breakers

To order, select frame, trip unit and terminals from tables on this page.

Accessories and Modifications

Refer to **Pages V12-T3-65–V12-T3-79**.

Type LAY

■ Shaded area denotes obsolete or discontinued products and services. ①

LAY: 240 Vac



Type LAY 250–600A, 240 Vac, Three-Pole, Interchangeable Trip Thermal-Magnetic, 600A Frame ②

Continuous Ampere Rating at 40°C	Magnetic Trip Setting Amperes ③		Complete Breaker Includes Pressure Type Aluminum Terminals ④	Shipped as Frame, Trip Unit and Terminals ⑤	
	Low	High	Catalog Number	Frame Only Catalog Number	Trip Unit Only Catalog Number
250	1250	2500	LAY3250	LAY3600F	2603D46G26
300	1500	3000	LAY3300	LAY3600F	2603D46G27
350	1750	3500	LAY3350	LAY3600F	2603D46G28
400	2000	4000	LAY3400	LAY3600F	2603D46G29
500	2500	5000	LAY3500	LAY3600F	HLA3500T
600	3000	6000	LAY3600	LAY3600F	HLA3600T

Accessories and Modifications

■ Shaded area denotes obsolete or discontinued products and services.

Special Calibrations

Special calibration price additions apply to ampere ratings not listed as standard or for ambients other than 40°C or 50°C. For frequencies other than 0–60 Hz AC, refer to Eaton. See Application Data 29-160 for information regarding special conditions. Maximum 400 Hz calibration: 600A frame, 450A.

Note: Not UL Listed.

50°C Calibration

Add suffix “V” to catalog number for complete breaker or trip unit only, when ordering breakers to be used in 50°C ambients. Same price as standard 40°C breakers.

For CSA, see Page V12-T3-48.

Type LAY breakers are not defined by Federal Specification W-C-375b.

Note: Not UL Listed.

For all three-phase delta, grounded B phase applications, contact Avery Creek, NC, Technical Resource Center at **1-800-356-1243**.

UL Listed Interrupting Ratings

Maximum Volts	Amperes
240 AC	115,000 asymmetrical, 100,000 symmetrical

Terminals

Two terminals are required per pole.

Terminals are UL Listed for wire type and range listed below. When used with aluminum cable, use joint compound.

Note: Terminals shipped separately from breaker.

Additional Accessories and Modifications

Refer to **Pages V12-T3-65–V12-T3-79**.

Terminals

Maximum Amperes	Number of Cables, Wire Range, Type	Catalog Number
Standard Al/Cu Pressure Terminals		
500 ⑤	(2) 3/0–250 kcmil Al/Cu	TA602LD
600 ⑤	(2) 400–500 kcmil Al/Cu	TA603LA
600 ⑤	(2) 250–500 kcmil Al/Cu	TA600LA
Optional Copper Pressure Terminals		
600 ⑥	(2) 250–500 kcmil Cu	T600LA

Notes

- ① These frames are obsolete. For replacement solutions, see the cross-reference on **Pages V12-T3-114–V12-T3-167**.
- ② Optional terminal.
- ③ Set on high side, adjustable to lower limits.
- ④ Terminals shipped separately from breaker.
- ⑤ For 600A frame breakers only.
- ⑥ Not UL Listed.

Types MA and HMA

Shaded area denotes obsolete or discontinued products and services. ①

MA: 600 Vac; 250 Vdc

Type MA 125–800A, 600 Vac, 250 Vdc ②, Two- and Three-Pole, Interchangeable Trip



3

Continuous Ampere Rating at 40°C	Magnetic Trip Setting Amperes ③		Complete Breaker Includes Pressure Type Copper Terminals ④			Shipped as Frame, Trip Unit and Terminals ④ Frame Only			Trip Unit Only Standard Saf-T-Vue, MARK 75 Catalog Number
	Low	High	Standard Catalog Number	Saf-T-Vue Catalog Number	MARK 75 Catalog Number	Standard Catalog Number	Saf-T-Vue Catalog Number	MARK 75 Catalog Number	
Two-Pole, 600 Vac, 250 Vdc ②⑤									
125	625	1250	MA2125	MA2125S	HMA2125	MA2800F	MA2800FS	HMA2800F	HMA2125T
150	750	1500	MA2150	MA2150S	HMA2150	MA2800F	MA2800FS	HMA2800F	HMA2150T
175	875	1750	MA2175	MA2175S	HMA2175	MA2800F	MA2800FS	HMA2800F	HMA2175T
200	1000	2000	MA2200	MA2200S	HMA2200	MA2800F	MA2800FS	HMA2800F	HMA2200T
225	1125	2250	MA2225	MA2225S	HMA2225	MA2800F	MA2800FS	HMA2800F	HMA2225T
250	1250	2500	MA2250	MA2250S	HMA2250	MA2800F	MA2800FS	HMA2800F	HMA2250T
300	1500	3000	MA2300	MA2300S	HMA2300	MA2800F	MA2800FS	HMA2800F	HMA2300T
350	1750	3500	MA2350	MA2350S	HMA2350	MA2800F	MA2800FS	HMA2800F	HMA2350T
400	2000	4000	MA2400	MA2400S	HMA2400	MA2800F	MA2800FS	HMA2800F	HMA2400T
500	2500	5000	MA2500	MA2500S	HMA2500	MA2800F	MA2800FS	HMA2800F	HMA2500T
600	3000	6000	MA2600	MA2600S	HMA2600	MA2800F	MA2800FS	HMA2800F	HMA2600T
700	3000	6000	MA2700 ⑥	MA2700S	HMA2700	MA2800F	MA2800FS	HMA2800F	HMA2700T ⑥
800	3000	6000	MA2800 ⑥	MA2800S	HMA2800	MA2800F	MA2800FS	HMA2800F	HMA2800T ⑥
800	MCS ⑦	—	MA2800WK	MA2800WSK	—	—	—	—	Incl. in Frame
					Approx. shipping weight 37 lbs		Approx. shipping weight 24 lbs		Approx. shipping weight 3.5 lbs

Three-Pole, 600 Vac Only

125	625	1250	MA3125	MA3125S	HMA3125	MA3800F	MA3800FS	HMA3800F	HMA3125T
150	750	1500	MA3150	MA3150S	HMA3150	MA3800F	MA3800FS	HMA3800F	HMA3150T
175	875	1750	MA3175	MA3175S	HMA3175	MA3800F	MA3800FS	HMA3800F	HMA3175T
200	1000	2000	MA3200	MA3200S	HMA3200	MA3800F	MA3800FS	HMA3800F	HMA3200T
225	1125 ②	2250	MA3225	MA3225S	HMA3225	MA3800F	MA3800FS	HMA3800F	HMA3225T
250	1250	2500	MA3250	MA3250S	HMA3250	MA3800F	MA3800FS	HMA3800F	HMA3250T
300	1500	3000	MA3300	MA3300S	HMA3300	MA3800F	MA3800FS	HMA3800F	HMA3300T
350	1750	3500	MA3350	MA3350S	HMA3350	MA3800F	MA3800FS	HMA3800F	HMA3350T
400	2000	4000	MA3400	MA3400S	HMA3400	MA3800F	MA3800FS	HMA3800F	HMA3400T
500	2500	5000	MA3500	MA3500S	HMA3500	MA3800F	MA3800FS	HMA3800F	HMA3500T
600	3000	6000	MA3600	MA3600S	HMA3600	MA3800F	MA3800FS	HMA3800F	HMA3600T
700	3000	6000	MA3700 ⑥	MA3700S	HMA3700	MA3800F	MA3800FS	HMA3800F	HMA3700T ⑥
800	3000	6000	MA3800 ⑥	MA3800S	HMA3800	MA3800F	MA3800FS	HMA3800F	HMA3800T ⑥
800	MCS ⑦	—	MA3800WK	MA3800WSK	—	—	—	—	Incl. in Frame
					Approx. shipping weight 44 lbs		Approx. shipping weight 28 lbs		Approx. shipping weight 4 lbs

Notes

① These frames are obsolete. For replacement solutions, see the cross-reference on Pages V12-T3-114–V12-T3-167.

② Above 600A, DC rating applies to magnetic only breakers.

③ Set on high side, adjustable to lower limits.

④ Terminals are shipped separately from breaker.

⑤ Two-pole breakers are supplied in three-pole frames with current carrying parts omitted from center pole.

⑥ 60 Hz AC only.

⑦ Interrupting capacities shown do not apply to high magnetic molded-case switches.

MARK 75 frame color changed from gray to black in mid-2002. Also magnetic only trip units available: HMA8000TM 4000–8000A.

■ Shaded area denotes obsolete or discontinued products and services. ①

Magnetic Only Breakers, Front Adjustable ②

Continuous Ampere Rating	Magnetic Trip Range ④		Trip Unit Only	
	Low	High	Two-Pole ④ Catalog Number	Three-Pole Catalog Number
800	625	1250	HMA21250TM	HMA31250TM
800	1000	2000	HMA22000TM	HMA32000TM
800	1500	3000	HMA23000TM	HMA33000TM
800	2000	4000	HMA24000TM	HMA34000TM
800	3000	6000	HMA26000TM	HMA36000TM
800	4000	8000	HMA28000TM	HMA38000TM

Ambient Compensating Breakers ②

Continuous Ampere Rating	Magnetic Trip Range ③		Trip Unit Only	
	Low	High	Two-Pole Catalog Number	Three-Pole Catalog Number
125	625	1250	HMA2125TA	HMA3125TA
150	750	1500	HMA2150TA	HMA3150TA
175	875	1750	HMA2175TA	HMA3175TA
200	1000	2000	HMA2200TA	HMA3200TA
220	1125	2250	HMA2225TA	HMA3225TA
250	1250	2500	HMA2250TA	HMA3250TA
300	1500	3000	HMA2300TA	HMA3300TA
350	1750	3500	HMA2350TA	HMA3350TA
400	2000	4000	HMA2400TA	HMA3400TA
500	2500	5000	HMA2500TA	HMA3500TA
600	3000	6000	HMA2600TA	HMA3600TA
700	3000	6000	HMA2700TA	HMA3700TA
800	3000	6000	HMA2800TA	HMA3800TA

Type MA Accessories and Modifications

Special Calibrations

Special calibration price additions apply to ampere ratings not listed as standard or for ambients other than 40°C or 50°C. For frequencies other than 0–60 Hz AC (50 Hz AC minimum, 60 Hz AC maximum, refer to Eaton. See Application Data 29-160 for additional information regarding special conditions.

Note: Not UL Listed.

50°C Calibration

Add suffix “V” to catalog number for complete breaker or trip unit only, when ordering breakers to be used in 50°C ambients.

Note: Not UL Listed.

For CSA, see Page V12-T3-48.

Type MA breakers meet requirements for Class 21a circuit breakers, and Type HMA meet requirements for Class 23a, as defined by Federal Specification W-C-375b.

For all three-phase delta, grounded B phase applications, contact Avery Creek, NC, Technical Resource Center at **1-800-356-1243**.

Type MA UL Listed Interrupting Ratings ⑤

Maximum Volts	Amperes
Standard Breakers	
240 AC	50,000 asymmetrical, 42,000 symmetrical
480 AC	35,000 asymmetrical, 30,000 symmetrical
600 AC	25,000 asymmetrical, 22,000 symmetrical
250 DC ⑥	20,000 ⑦
MARK 75 Breakers	
240 AC	75,000 asymmetrical, 65,000 symmetrical
480 AC	40,000 asymmetrical, 35,000 symmetrical
600 AC	30,000 asymmetrical, 25,000 symmetrical
250 DC ⑥	20,000 ⑦

Notes

- ① These frames are obsolete. For replacement solutions, see the cross-reference on Pages V12-T3-114–V12-T3-167.
- ② Not UL Listed.
- ③ Set on high side, adjustable to lower limits.
- ④ Two-pole breakers are supplied in three-pole frames with current carrying parts omitted from center pole.
- ⑤ Interrupting capacities shown do not apply to high magnetic molded-case switches.
- ⑥ Above 600A, DC rating applies to magnetic only breakers.
- ⑦ Ratings above 10,000A not UL Listed.

Shaded area denotes obsolete or discontinued products and services.

Terminals

Two terminals are required per pole.

Terminals are UL Listed for wire type and range listed below. When used with aluminum conductors, use joint compound.

Terminals ^①

Maximum Amperes	Number of Cables, Wire Range, Type	Catalog Number
Standard Al/Cu Pressure Terminals		
600	(2) #1–500 kcmil Al/Cu	TA700MA1
800 (Std.)	(3) 3/0–400 kcmil Al/Cu	TA800MA2
800 ^②	(2) 500–750 kcmil Al/Cu	TA801MA
Optional Copper Pressure Terminals		
350	(1) #1–600 kcmil Cu	T350MA
600	(2) 2/0–500 kcmil Cu	T600MA1
800	(3) 3/0–300 kcmil Cu	T800MA1

Note: Terminals are shipped separately from breaker.

Magnetic Only and Ambient Compensating Breakers

To order a complete breaker, select trip unit plus frame and terminals.

Type MAY Accessories and Modifications

Type MAY 600–800A, 240 Vac, Three-Pole, Interchangeable Trip ^①

Continuous Ampere Rating at 40°C	Magnetic Trip Setting, Amperes ^③		Complete Breaker Includes Pressure Type Aluminum Terminals ^④ Catalog Number	Shipped as Frame, Trip Unit and Terminals ^④	
	Low	High		Frame Only Catalog Number	Trip Unit Only Catalog Number
Three-Pole, 240 Vac Only					
600	3000	6000	MAY3600	MAY3800F	HMA3600T
700 ^⑤	3000	6000	MAY3700	MAY3800F	HMA3700T
800 ^⑤	3000	6000	MAY3800	MAY3800F	HMA3800T

Type MAY breakers are not defined by Federal Specification W-C-375b.

Note: Not UL listed.

Type MAY UL Listed Interrupting Ratings

Maximum Volts	Amperes
240 Vac	115,000 asymmetrical, 100,000 symmetrical

For all three-phase delta, grounded B phase applications, contact Avery Creek, NC, Technical Resource Center at **1-800-356-1243**.

Additional Accessories and Modifications

Refer to **Pages V12-T3-65–V12-T3-79**.

Notes

- ^① These frames are obsolete. For replacement solutions, see the cross-reference on **Pages V12-T3-114–V12-T3-167**.
- ^② Not UL Listed.
- ^③ Set on high side, adjustable to lower limits.
- ^④ Terminals are shipped separately from breaker.
- ^⑤ 60 Hz AC only.

Types NB and NHB

■ Shaded area denotes obsolete or discontinued products and services. ①

NB: 600 Vac; 250 Vdc



Type NB 700–1200A, 600V, 60 Hz AC ②, 250 Vdc ③, Two- and Three-Pole Interchangeable Trip

Continuous Ampere Rating at 40°C	Magnetic Trip Setting, Amperes ④		Complete Breaker Includes Pressure Type Copper Terminals ⑤			Shipped as Frame, Trip Unit and Terminals ⑥			Trip Unit Only Standard Saf-T-Vue, MARK 75 Catalog Number	
	Low	High	Standard Catalog Number	Saf-T-Vue Catalog Number	MARK 75 Catalog Number	Frame Only Standard Catalog Number	Saf-T-Vue Catalog Number	MARK 75 Catalog Number		
Two-Pole, 600 Vac, 250V DC ③⑥										
700	3000	6000	NB2700	NB2700S	HNB2700	NB21200F	NB21200FS	HNB21200F	HNB2700T	
800	3000	6000	NB2800	NB2800S	HNB2800	NB21200F	NB21200FS	HNB21200F	HNB2800T	
900	4000	8000	NB2900	NB2900S	HNB2900	NB21200F	NB21200FS	HNB21200F	HNB2900T	
1000	4000	8000	NB21000	NB21000S	HNB21000	NB21200F	NB21200FS	HNB21200F	HNB21000T	
1200	4000	8000	NB21200	NB21200S	HNB21200	NB21200F	NB21200FS	HNB21200F	HNB21200T	
600	3000	6000							HNB31200F	HNB3600T
					Approx. shipping weight 43 lbs		Approx. shipping weight 29 lbs		Approx. shipping weight 3.5 lbs	
Three-Pole, 600 Vac Only										
700	3000	6000	NB3700	NB3700S	HNB3700	NB31200F	NB31200FS	HNB31200F	HNB3700T	
800	3000	6000	NB3800	NB3800S	HNB3800	NB31200F	NB31200FS	HNB31200F	HNB3800T	
900	4000	8000	NB3900	NB3900S	HNB3900	NB31200F	NB31200FS	HNB31200F	HNB3900T	
1000	4000	8000	NB31000	NB31000S	HNB31000	NB31200F	NB31200FS	HNB31200F	HNB31000T	
1200	4000	8000	NB31200	NB31200S	HNB31200	NB31200F	NB31200FS	HNB31200F	HNB31200T	
					Approx. shipping weight 51 lbs		Approx. shipping weight 32 lbs		Approx. shipping weight 4 lbs	

Magnetic Only Breakers, Front Adjustable ⑦⑧

Continuous Ampere Rating	Magnetic Trip Range ④		Trip Unit Only	
	Low	High	Two-Pole ⑥ Catalog Number	Three-Pole Catalog Number
1200	3000	6000	HNB26000TM	HNB36000TM
1200	4000	8000	HNB28000TM	HNB38000TM
1200	5000	10000	HNB210000TM	HNB310000TM
1200	6000	12000	HNB212000TM	HNB312000TM

Notes

- ① These frames are obsolete. For replacement solutions, see the cross-reference on **Pages V12-T3-114–V12-T3-167**.
- ② Higher frequency calibration not available. Minimum of 50 Hz calibration available on special order.
- ③ 250 Vdc rating applied only to magnetic only type breakers.
- ④ Set on high side, adjustable to lower limits.
- ⑤ Terminals shipped separately from breaker.
- ⑥ Two-pole breakers supplied in three-pole frames with current carrying parts omitted from center pole.
- ⑦ Frames, terminals, studs, mounting hardware, dimensions and shipping weights are same as standard thermal-magnetic breakers.
- ⑧ Not UL Listed.

UL Listed Interrupting Ratings

Maximum Volts	Amperes
Standard Breakers	
240 AC	50,000 asymmetrical, 42,000 symmetrical
480 AC	35,000 asymmetrical, 30,000 symmetrical
600 AC	25,000 asymmetrical, 22,000 symmetrical
250 DC ^{①②}	20,000 ^③
MARK 75 Breakers	
240 AC	75,000 asymmetrical, 65,000 symmetrical
480 AC	40,000 asymmetrical, 35,000 symmetrical
600 AC	30,000 asymmetrical, 25,000 symmetrical
250 DC ^{①②}	20,000 ^③

Terminals ^④

Maximum Amperes	Number of Cables, Wire Range, Type,	Catalog Number
Standard Al/Cu Pressure Terminals		
1000	(3) 3/0–400 kcmil Al/Cu	TA1000NB1
1200	(4) 4/0–500 kcmil Al/Cu	TA1200NB1
Optional Copper or Al/Cu Pressure Terminals		
1000	(3) 3/0–500 kcmil Cu	T1000NB1
1200	(4) 3/0–400 kcmil Cu	T1200NB1
1200	(3) 500–750 kcmil Al/Cu	TA1201NB1

Accessories and Modifications

■ Shaded area denotes obsolete or discontinued products and services.

Special Calibrations

Special calibration price additions apply to ampere ratings not listed as standard or for ambients other than 40°C or 50°C. For frequencies other than 0–60 Hz AC (50 Hz AC minimum, 60 Hz AC maximum for ratings of 700A and above), refer to Eaton. See Application Data 29-160 for additional information regarding special conditions. Maximum 400 Hz calibration for type MA is 475A.

Note: Not UL Listed.

50°C Calibration

Add suffix "V" to catalog number for complete breaker or trip unit only, when ordering breakers to be used in 50°C ambients. **For CSA, see Page V12-T3-48.**

Note: Not UL Listed.

Type NB breakers meet requirements for Class 21a circuit breakers, and Type HNB meet requirements for Class 23a, as defined by Federal Specification W-C-375b.

For all three-phase delta, grounded B phase applications, contact Avery Creek, NC, Technical Resource Center at **1-800-356-1243**.

Terminals

Two terminals are required per pole.

Terminals are UL Listed for wire type and range listed below. When used with aluminum conductors, use joint compound. To order optional copper terminals, add suffix "C" to complete breaker catalog number.

Note: Frames, terminals, studs, mounting hardware, dimensions and shipping weights are same as standard thermal magnetic breakers.

Magnetic Only Breakers

To order a complete breaker, select trip unit, plus frame and terminals.

Note: Not UL Listed.

Additional Accessories and Modifications

Refer to **Pages V12-T3-65–V12-T3-79**.

Notes

- ① 250 Vdc rating applied only to magnetic only type breakers.
- ② Terminals shipped separately from breaker.
- ③ Ratings above 10,000A not UL Listed.
- ④ MARK 75 frame color changed from gray to black in mid-2002.

Type NBY

Shaded area denotes obsolete or discontinued products and services. ①

NBY: 240 Vac

Type NBY 700–1200A, 240V, 60 Hz AC ②, Three-Pole, Interchangeable Trip



Continuous Ampere Rating at 40°C	Magnetic Trip Setting Amperes ③		Complete Breaker Includes Pressure Type Aluminum Terminals ④ Catalog Number	Shipped as Frame, Trip Unit and Terminals ④	
	Low	High		Frame Only Catalog Number	Trip Unit Only Catalog Number
Three-Pole, 600 Vac Only					
700	3000	6000	NBY3700	NBY31200F	HNB3700T
800	3000	6000	NBY3800	NBY31200F	HNB3800T
900	4000	8000	NBY3900	NBY31200F	HNB3900T
1200	4000	8000	NBY31200	NBY31200F	HNB31200T

UL Listed Interrupting Ratings

Maximum Volts	Amperes
240 AC	115,000 asymmetrical, 100,000 symmetrical

For all three-phase delta, grounded B phase applications, contact Avery Creek, NC, Technical Resource Center at **1-800-356-1243**.

Terminals

Two terminals are required per pole.

Terminals are UL Listed for wire type and range listed below. When used with aluminum conductors, use joint compound.

Note: Terminals shipped separately from breaker.

Terminals

Max. Amperes	Number of Cables, Wire Range, Type,	Catalog Number
Standard Al/Cu Pressure Terminals		
1000	(3) 3/0–400 kcmil Al/Cu	TA1000NB1
1200	(4) 4/0–500 kcmil Al/Cu	TA1200NB1
1200	(3) 500–750 kcmil Al/Cu	TA1201NB1
Alternate Copper Pressure Terminals		
1000	(3) 3/0–500 kcmil Cu	T1000NB1
1200	(4) 3/0–400 kcmil Cu	T1200NB1

Accessories and Modifications

Shaded area denotes obsolete or discontinued products and services.

Special Calibrations

Special calibration price additions apply to ampere ratings not listed as standard or for ambients other than 40°C or 50°C. For frequencies other than 0–60 Hz AC (50 Hz AC minimum, 60 Hz AC maximum), refer to Eaton. See Application Data 29-160 for additional information regarding special conditions.

Note: Not UL Listed.

50°C Calibration

Add suffix “V” to catalog number for complete breaker or trip unit only, when ordering for breakers to be used in 50°C ambients.

Note: Not UL Listed.

For CSA, see Page V12-T3-48.

Type NBY breakers are not defined by Federal Specification W-C-375b.

Additional Accessories and Modifications

Refer to **Pages V12-T3-65–V12-T3-79**.

Notes

- ① These frames are obsolete. For replacement solutions, see the cross-reference on **Pages V12-T3-114–V12-T3-167**.
- ② Higher frequency calibration not available. Minimum of 50 Hz calibration available on special order.
- ③ Set on high side, adjustable to lower limits.
- ④ Terminals shipped separately from breaker.

Type PB

Shaded area denotes obsolete or discontinued products and services. ①

Rear Connected PB Breaker: 600 Vac



3

Type PB 600–25s00A, 600V, 60 Cycle AC ②, 250 Vdc ③, Two- and Three-Pole, Interchangeable Trip

Continuous Ampere Rating at 40°C	Magnetic Trip Setting, Amperes ④⑤		Complete Breaker Includes Busbar Connectors ⑥ Catalog Number	Shipped as Frame, Trip Unit and Rear Connectors	
	Low	High		Frame Only Catalog Number	Trip Unit Only Catalog Number
Two-Pole, 600 Vac Only ⑦					
600	1500	5000	PB2600	PB22500F	PB2600T
700	1500	5000	PB2700	PB22500F	PB2700T
800	1500	5000	PB2800	PB22500F	PB2800T
900	1500	5000	PB2900	PB22500F	PB2900T
1000	1500	5000	PB21000	PB22500F	PB21000T
1200	2000	6000	PB21200	PB22500F	PB21200T
1400	2500	7000	PB21400	PB22500F	PB21400T
1600	3000	8000	PB21600	PB22500F	PB21600T
1800	3000	8000	PB21800	PB22500F	PB21800T
2000	3000	8000	PB22000	PB22500F	PB22000T
	Approx. shipping weight		132 lbs	98 lbs	18 lbs
2500	3000	8000	PB22500	PB22500F	PB22500T
	Approx. shipping weight		144 lbs	98 lbs	18 lbs
Three-Pole, 600 Vac Only – Not UL Listed					
600	1500	5000	PB3600	PB32500F	PB3600T
700	1500	5000	PB3700	PB32500F	PB3700T
800	1500	5000	PB3800	PB32500F	PB3800T
900	1500	5000	PB3900	PB32500F	PB3900T
1000	1500	5000	PB31000	PB32500F	PB31000T
1200	2000	6000	PB31200	PB32500F	PB31200T
1400	2500	7000	PB31400	PB32500F	PB31400T
1600	3000	8000	PB31600	PB32500F	PB31600T
1800	3000	8000	PB31800	PB32500F	PB31800T
2000	3000	8000	PB32000	PB32500F	PB32000T
	Approx. shipping weight		155 lbs	108 lbs	23 lbs
2500	3000	8000	PB32500	PB32500F	PB32500T
	Approx. shipping weight		173 lbs	108 lbs	23 lbs

Notes

- ① These frames are obsolete. For replacement solutions, see the cross-reference on **Pages V12-T3-114–V12-T3-167**.
- ② Higher frequency calibration not available. Minimum of 50 Hz calibration available on special order.
- ③ Available only on magnetic only breakers.
- ④ Higher magnetic trip settings are available as special calibration. Refer to magnetic only breakers for specific trip ranges.
- ⑤ Set on high side, adjustable to lower limits.
- ⑥ Shipped separately from breaker.
- ⑦ Two-pole breakers are supplied in three-pole frames with current carrying parts omitted from center pole.

Type PBF

■ Shaded area denotes obsolete or discontinued products and services. ①

PBF Front Connected:
600 Vac



Type PBF Front-Connected 600–2000A, 600V, 60 Cycle AC ②, 250 Vdc ③, Two- and Three-Pole, Interchangeable Trip

Continuous Ampere Rating at 40°C	Magnetic Trip Setting, Amperes (Set on High Side, Adjustable to Lower Limits)		Complete Breaker Includes Busbar Connectors ④ Catalog Number	Shipped As:		Trip Unit Only Catalog Number
	Low	High		Frame Only Includes Busbar Connectors ④ Catalog Number		
Two-Pole, 600 Vac ⑤						
600	1500	5000	PBF2600	PBF22000F	PBF2600T	
700	1500	5000	PBF2700	PBF22000F	PBF2700T	
800	1500	5000	PBF2800	PBF22000F	PBF2800T	
900	1500	5000	PBF2900	PBF22000F	PBF2900T	
1000	1500	5000	PBF21000	PBF22000F	PBF21000T	
1200	2000	6000	PBF21200	PBF22000F	PBF21200T	
1400	2500	7000	PBF21400	PBF22000F	PBF21400T	
1600	3000	8000	PBF21600	PBF22000F	PBF21600T	
1800	3000	8000	PBF21800	PBF22000F	PBF21800T	
2000	3000	8000	PBF22000	PBF22000F	PBF22000T	
Three-Pole, 600 Vac—Not UL Listed						
600	1500	5000	PBF3600	PBF32000F	PBF3600T	
700	1500	5000	PBF3700	PBF32000F	PBF3700T	
800	1500	5000	PBF3800	PBF32000F	PBF3800T	
900	1500	5000	PBF3900	PBF32000F	PBF3900T	
1000	1500	5000	PBF31000	PBF32000F	PBF31000T	
1200	2000	6000	PBF31200	PBF32000F	PBF31200T	
1400	2500	7000	PBF31400	PBF32000F	PBF31400T	
1600	3000	8000	PBF31600	PBF32000F	PBF31600T	
1800	3000	8000	PBF31800	PBF32000F	PBF31800T	
2000	3000	8000	PBF32000	PBF32000F	PBF32000T	

Notes

- ① These frames are obsolete. For replacement solutions, see the cross-reference on **Pages V12-T3-114–V12-T3-167**.
- ② Higher frequency calibration not available. Minimum of 50 Hz calibration available on special order.
- ③ Available only on magnetic only breakers.
- ④ Included with frame.
- ⑤ Two-pole breakers are supplied in three-pole frames with current carrying parts omitted from center pole.

Types PB and PBF Accessories and Modifications

Shaded area denotes obsolete or discontinued products and services. ①

PB breakers are not UL Listed.

Special Breakers ② Magnetic Only, Front Adjustable ③ Trip Unit Only

Continuous Ampere Rating	Magnetic Trip Range, Amperes ④		Two-Pole ⑤ Catalog Number	Three-Pole Catalog Number
	Low	High		

For Rear-Connected Type PB Breakers

2000	1500	5000	PB25000TM	PB35000TM
2000	2000	6000	PB26000TM	PB36000TM
2000	2500	7000	PB27000TM	PB37000TM
2000	3000	8000	PB28000TM	PB38000TM
2000	3500	10,000	PB210000TM	PB310000TM
2000	4000	12,000	PB212000TM	PB312000TM
2500	4000	12,000	373D488G08	373D488G09

For Front-Connected Type PBF Breakers

2000	1500	5000	PBF25000TM	PBF35000TM
2000	2000	6000	PBF26000TM	PBF36000TM
2000	2500	7000	PBF27000TM	PBF37000TM
2000	3000	8000	PBF28000TM	PBF38000TM
2000	3500	10,000	PBF210000TM	PBF310000TM
2000	4000	12,000	PBF212000TM	PBF312000TM

Accessories and Modifications

Shaded area denotes obsolete or discontinued products and services.

Special Calibrations

Special calibration price additions apply to ampere ratings not listed as standard, or for ambients other than 40°C or 50°C. For frequencies other than 0–60 Hz AC, refer to Eaton. See Application Data 29-160 for information regarding special conditions.

Note: Not UL Listed.

50°C Calibration

Add suffix "V" to catalog number for complete breaker or trip unit only, when ordering breakers to be used in 50°C ambients.

Type PB breakers meet the requirements for Class 25a circuit breakers as defined by Federal Specification W-C-375b.

Interrupting Ratings

Maximum Volts	Amperes
240 AC ②	150,000 asymmetrical, 125,000 symmetrical
480 AC ②	115,000 asymmetrical, 100,000 symmetrical
600 AC ②	115,000 asymmetrical, 100,000 symmetrical
250 DC ②	75,000A ⑥

For all three-phase delta, grounded B phase applications, contact Avery Creek, NC, Technical Resource Center at **1-800-356-1243**.

Magnetic Only Breakers

To order a complete breaker, select trip unit, plus frame and connectors.

Note: Not UL Listed.

Busbar Connections

"T" Connector



Busbar Connections— "T" Connector (For Cu/Al Bus)

Catalog Number

BA2000PB

Two required per pole. For rear bus connection of breakers through 2000A. Accepts up to four bus bolts. May be rotated 90°.

Note: Shipped separately from breaker.

"C" Connector



"C" Connector (For Cu/Al Bus)

Breaker Amperes

2500

Catalog Number

BA2500PB

Two required per pole. For rear bus connection of 2500A breakers.

Cable Connector



Cable Connector

Catalog Number

505C706G04

Fits "T" Connector and 2000A front-connected breakers. Accepts four 400–600 kcmil copper cables.

Notes

- ① These frames are obsolete. For replacement solutions, see the cross-reference on **Pages V12-T3-114–V12-T3-167**.
- ② Not UL Listed.
- ③ Frames, connectors, dimensions and shipping weights are same as thermal-magnetic breakers.
- ④ Set on high side, adjustable to lower limits.
- ⑤ Two-pole breakers are supplied in three-pole frames with current carrying parts omitted from center pole.
- ⑥ Based on NEMA test procedure.

Types LC, LCC, LCA, LCCA, MARK 75 Types HLC, HLCC, HLCA, HLCCA SELTRONIC with Solid-State Trip Units 600 Vac, 50/60 Hz

Complete breaker requires frame and rating plug. See the table and terminals on **Page V12-T3-60**. Extra current transformer included for neutral. See accessories on **Page V12-T3-65** for remote ground fault trip indicator.

■ Shaded area denotes obsolete or discontinued products and services. ①

LCA: 600 Vac



Breakers for Standard Applications—Frame Only

Number of Poles ②	Standard (Long Delay and Short Time) Catalog Number	Short Time Only ③ Catalog Number	Long Delay, Short Time and Adjustable Short Delay Time (0.06–0.22 sec.) Catalog Number
Types LC 150 and LCA 150 (75–150A)			
2	LC2150F	LC2150FM	LCA2150F
3	LC3150F	LC3150FM	LCA3150F
MARK 75 Types HLC 150 and HLCA 150 (75–150A)			
2	HLC2150F	HLC2150FM	HLCA2150F
3	HLC3150F	HLC3150FM	HLCA3150F
Types LC 300 and LCA 300 (150–300A)			
2	LC2300F	LC2300FM	LCA2300F
3	LC3300F	LC3300FM	LCA3300F
MARK 75 Types HLC 300 and HLCA 300 (150–300A)			
2	HLC2300F	HLC2300FM	HLCA2300F
3	HLC3300F	HLC3300FM	HLCA3300F
Types LC 400 and LCA 400 (200–400A)			
2	LC2400F	LC2400FM	LCA2400F
3	LC3400F	LC3400FM	LCA3400F
MARK 75 Types HLC 400 and HLCA 400 (200–400A)			
2	HLC2400F	HLC2400FM	HLCA2400F
3	HLC3400F	HLC3400FM	HLCA3400F
Types LC 600 and LCA 600 (300–600A)			
2	LC2600F	LC2600FM	LCA2600F
3	LC3600F	LC3600FM	LCA3600F
MARK 75 Types HLC 600 and HLCA 600 (300–600A)			
2	HLC2600F	HLC2600FM	HLCA2600F
3	HLC3600F	HLC3600FM	HLCA3600F

Breakers for Applications at 100% Rating—Frame Only

Number of Poles ②	Standard (Long Delay and Short Time) Catalog Number	Short Time Only ③ Catalog Number	Long Delay, Short Time and Adjustable Short Delay Time (0.06–0.22 sec.) Catalog Number
Types LCC 600 and LCCA 600 (300–600A)			
3	LCC3600F	—	LCCA3600F
MARK 75 Types HLCC 600 and HLCCA 600 (300–600A)			
3	HLCC3600F	—	HLCCA3600F

Notes

① These frames are obsolete. For replacement solutions, see the cross-reference on **Pages V12-T3-114–V12-T3-167**.

② Two-pole breakers are supplied in three-pole frames with current carrying parts omitted from center pole.

③ UL Recognized component.

MARK 75 frame color changed from gray to black in mid-2002.

Types LCG, LCCG, LCGA, LCCGA, MARK 75 HLCG, HLCCG, HLCGA, HLCCGA SELTRONIC with Built-In Ground Fault Protection

Complete breaker requires frame and rating plug. See the table and terminals on **Page V12-T3-60**. Extra current transformer included for neutral. See accessories on **Page V12-T3-65** for remote ground fault trip indicator.

Shaded area denotes obsolete or discontinued products and services.

Note: Available without extra CT for neutral. Order by description as similar to above except without neutral CT or external CT terminal connections at same price. Note the standard ground fault unit can also be used without the neutral CT.

Note: These breakers use LC terminals. The fourth CT uses MC breaker terminals, **Page V12-T3-53**.

Shaded area denotes obsolete or discontinued products and services. ①

Breakers for Standard Application—Frame Only

Number of Poles ②	Standard (Long Delay, Short Time) and Ground Fault Trip Catalog Number	Long Delay, Short Time, Adjustable Short Delay Time and Ground Fault Trip	Ground Fault Characteristics Pickup Setting Amperes Time Setting	
Types LCG 150 and LCGA 150 (75–150A) ③				
3	LCG3150F	LCGA3150F	50–150	3.5–30 Cy
MARK 75 Types HLCG 150 and HLCGA 150 (75–150A) ③				
3	HLCG3150F	HLCGA3150F	50–150	3.5–30 Cy
Types LCG 300 and LCGA 300 (150–300A) ③				
3	LCG3300F	LCGA3300F	60–300	3.5–30 Cy
MARK 75 Types HLCG 300 and HLCGA 300 (150–300A) ③				
3	HLCG3300F	HLCGA3300F	60–300	3.5–30 Cy
Types LCG 400 and LCGA 400 (200–400A) ③				
3	LCG3400F	LCGA3400F	0–400	3.5–30 Cy
MARK 75 Types HLCG 400 and HLCGA 400 (200–400A) ③				
3	HLCG3400F	HLCGA3400F	80–400	3.5–30 Cy
Types LCG 600 and LCGA 600 (300–600 Amperes) ③				
3	LCG3600F	LCGA3600F	120–600	3.5–30 Cy
MARK 75 Types HLCG 600 and HLCGA 600 (300–600A) ③				
3	HLCG3600F	HLCGA3600F	120–600	3.5–30 Cy

Breakers for Application at 100% Rating—Frame Only

Number of Poles ②	Standard (Long Delay, Short Time) and Ground Fault Trip Catalog Number	Long Delay, Short Time, Adjustable Short Delay Time and Ground Fault Trip	Ground Fault Characteristics Pickup Setting Amperes Time Setting	
Types LCCG 600 and LCCGA 600 (300–600A) ③				
3	LCCG3600F	LCCGA3600F	120–600	3.5–30 Cy
MARK 75 Types HLCCG 600 and HLCCGA 600 (300–600A) ③				
3	HLCCG3600F	HLCCGA3600F	120–600	3.5–30 Cy

Notes

- ① These frames are obsolete. For replacement solutions, see the cross-reference on **Pages V12-T3-114–V12-T3-167**.
- ② Two-pole breakers supplied in three-pole frames with current carrying parts omitted from center pole.
- ③ For applications other than standard residual scheme, see Application Data 29-160.
- MARK 75 frame color changed from gray to black in mid-2002.

Types LCG, LCCG, LCGA, LCCGA, MARK 75 HLCG, HLCCG, HLCGA, HLCCGA SELTRONIC with Built-In Ground Fault Protection Accessories and Modifications

Field-Mountable Attachments ①②③④⑤

Description	Style Number
Provision to trip flux transfer shunt trip from external source 32 to 120 Vdc to 60 Hz ⑥	1371D11G22
240 to 600 Vac, 50/60 Hz ⑦	1371D11G32
Provision to trip flux transfer shunt trip from external source, plus a 1A-1B auxiliary switch 32 to 120 Vdc to 60 Hz ⑥	1371D11G15
240 to 600 Vac, 50/60 Hz ⑦	1371D11G25
Provision to trip flux transfer shunt trip from 24 Vdc source	1371D93G01
1A-1B auxiliary switch	1371D11G03
24 Vdc shunt trip and 1A-1B auxiliary switch	1371D94G08

For CSA, see Page V12-T3-48.

Type LC breakers meet requirements for Class 21a circuit breakers, and Type HLC meet requirements for Class 23a as defined by Federal Specification W-C-375b.

UL Listed Interrupting Ratings ⑧

Maximum Volts	Amperes
Standard Breakers	
240 AC	50,000 Asymmetrical, 42,000 Symmetrical
480 AC	35,000 Asymmetrical, 30,000 Symmetrical
600 AC	25,000 Asymmetrical, 22,000 Symmetrical
MARK 75 Breakers	
240 AC	75,000 Asymmetrical, 65,000 Symmetrical
480 AC	40,000 Asymmetrical, 35,000 Symmetrical
600 AC	30,000 Asymmetrical, 25,000 Symmetrical

For all three-phase delta, grounded B phase applications, contact Avery Creek, NC, Technical Resource Center at **1-800-356-1243**.

Additional Accessories and Modifications

Refer to Pages V12-T3-65–V12-T3-79.

Terminals

Note: Order separately.

Two terminals are required per pole.

Terminals are UL Listed for wire type and range listed below. When used with aluminum cable, use joint compound.

150, 300 and 400A Frames Only

Maximum Amperes	Number of Cables, Wire Range, Type	Catalog Number
Al/Cu Pressure Terminals		
225	(1) #6–350 kcmil Cu, or (1) #4–350 kcmil Al	TA225LA1
400	(1) #4–250 kcmil Al/Cu, plus (1) 3/0–600 kcmil Al/Cu	TA400LA1
Optional Copper Pressure Terminals		
225	(1) #6–350 kcmil Cu	T225LA
225	(1) #6–250 kcmil Cu	T225LBF
400	(1) #4–250 kcmil Cu, plus (1) 3/0–600 kcmil Cu	T401LA

600A Frame Only

Maximum Amperes	Number of Cables, Wire Range, Type	Catalog Number
Al/Cu Pressure Terminals		
500	(2) 250–350 kcmil Al/Cu	TA602LD
600	(2) 400–500 kcmil Al/Cu	TA603LA
600 (std.)	(2) 250–500 kcmil Al/Cu	TA600LA
Optional Copper Pressure Terminals		
600	(2) 250–500 kcmil Cu	T600LA

Notes

- ① Only one attachment may be mounted per breaker.
 - ② Contact Avery Creek, NC, Technical Resource Center for other combinations.
 - ③ Molded-case switches do not use standard SELTRONIC attachments, and should be ordered by description for factory mounting.
 - ④ Does not void listing of UL Listed breakers.
 - ⑤ Left pole mounting.
 - ⑥ Rated 48 volts minimum for ground fault applications requiring tripping at 55% of voltage.
 - ⑦ Not for use on ground fault applications.
 - ⑧ Interrupting capacities shown do not apply to molded-case switches.
- MARK 75 frame color changed from gray to black in mid-2002.

Types MC, MCC, MCA, MCCA, MARK 75 Types HMC, HMCC, HMCA, HMCCA SELTRONIC with Solid-State Trip Units 600 Vac, 50/60 Hz
 Shaded area denotes obsolete or discontinued products and services. ①

MCA: 600 Vac



Breakers for Standard Applications—Frame Only

Number of Poles ②	Standard (Long Delay and Short Time) Catalog Number	Short Time Only ③ Catalog Number	Long Delay, Short Time and Adjustable Short Delay Time (0.08–0.30 seconds) Catalog Number
Types MC and MCA (400–800A)			
2	MC2800F	MC2800FM	MCA2800F
3	MC3800F	MC3800FM	MCA3800F
MARK 75 Types HMC and HMCA (400–800A)			
2	HMC2800F	HMC2800FM	HMCA2800F
3	HMC3800F	HMC3800FM	HMCA3800F

Breakers for Application at 100% Rating—Frame Only ①

Number of Poles ②	Standard (Long Delay and Short Time) Catalog Number	Short Time Only ③ Catalog Number	Long Delay, Short Time and Adjustable Short Delay Time (0.08–0.30 seconds) Catalog Number
Types MCC and MCCA (400–800A)			
3	MCC3800F	—	MCCA3800F
MARK 75 Types HMCC and HMCCA (400–800A)			
3	HMCC3800F	—	HMCCA3800F

Notes

① These frames are obsolete. Effective 2/1/02, only the MARK 75 version is available. For replacement solutions, see the cross-reference on **Pages V12-T3-114–V12-T3-167**.

② Two-pole breakers are supplied in three-pole frames with current-carrying parts omitted from center pole.

③ UL Recognized component.

Type MC800 molded-case switch; refer to **Page V12-T3-62**. MARK 75 frame color changed from gray to black in mid-2002.

Types MCG, MCCG, MCGA, MCCGA and MARK 75 Types HMCG, HMCCG, HMCGA, HMCCGA SELTRONIC with Built-In Ground Fault Protection

Complete breaker requires frame and rating plug. See the table and terminals on **Page V12-T3-60**. Extra current transformer included for neutral. See accessories on **Page V12-T3-65** for remote ground fault trip indicator.

■ Shaded area denotes obsolete or discontinued products and services. ①

Note: Available without extra CT for neutral. Order by description as similar to above except without neutral CT or external CT terminal connections at same price.

Note: Order two of the desired terminals for each pole of the breaker and two for the neutral CT. The standard ground fault unit can also be used without the neutral CT. MARK 75 frame color changed from gray to black in mid-2002.

Breakers for Standard Applications—Frame Only

Number of Poles	Standard (Long Delay, Short Time and Ground Fault Trip)	Long Delay, Short Time, Adjustable Short Delay Time and Ground Fault Trip	Ground Fault Characteristics	Pickup Setting Amperes	Time Setting
	Catalog Number	Catalog Number			
Types MCG and MCGA (400–800A) ②					
3	MCG3800F	MCGA3800F	80–800		3.5–30 Cy
MARK 75 Types HMCG and HMCGA (400–800A) ②					
3	HMCG3800F	HMCGA3800F	80–800		3.5–30 Cy

Breakers for Application at 100% Rating—Frame Only

Number of Poles	Standard (Long Delay, Short Time and Ground Fault Trip)	Long Delay, Short Time, Adjustable Short Delay Time and Ground Fault Trip	Ground Fault Characteristics	Pickup Setting Amperes	Time Setting
	Catalog Number	Catalog Number			
Types MCCG and MCCGA (400–800A) ②					
3	MCCG3800F	MCCGA3800F	80–800		3.5–30 Cy
MARK 75 Types HMCCG and HMCCGA (400–800A) ②					
3	HMCCG3800F	HMCCGA3800F	80–800		3.5–30 Cy

Accessories and Modifications

Field-Mountable Attachments ③④⑤⑥

Description	Style Number
Provision to trip flux transfer shunt trip from external source 32 to 120 Vdc to 60 Hz ⑦	1371D72G22
240 to 600 Vac, 50/60 Hz ⑧	1371D72G32
Provision to trip flux transfer shunt trip from external source, plus 1a-1b auxiliary switch 32 to 120 Vdc to 60 Hz ⑦	1371D72G15
240 to 600 Vac, 50/60 Hz ⑧	1371D72G25
Provision to trip flux transfer shunt trip from external 24 Vdc source	1370D85G01
1A-1B auxiliary switch	1371D72G03

Additional Accessories and Modifications

Refer to **Pages V12-T3-65–V12-T3-79**.

Rating Plugs

Select from the table on **Page V12-T3-60**.

For CSA, see **Page V12-T3-48**.

Type MC SELTRONIC breakers meet requirements for Class 21a, and MARK 75. Type HMC meet Class 23a as defined by Federal Spec. W-C-375b.

UL Listed Interrupting Capacity, rms Symmetrical Amperes ⑨

Breaker	AC Volts		
	240	480	600
MC, MCG	42,000	30,000	22,000
HMC, HMCG	65,000	50,000	25,000

Terminals

Terminals—Two Terminals Required Per Pole

Maximum Amperes	Number of Cables, Wire Range, Type	Catalog Number
Al/Cu Pressure Terminals		
600	(2) #1–500 kcmil	TA700MA1 ⑩
800 (std.)	(3) 3/0–400 kcmil	TA800MA2 ⑩
800	(2) 500–750 kcmil	TA801MA ⑩
Optional Copper Pressure Terminals		
600	(2) 2/0–500 kcmil	T600MA1
800	(3) 3/0–300 kcmil	T800MA1

Notes

- ① These frames are obsolete. Effective 2/1/02, only the MARK 75 version is available. For replacement solutions, see the cross-reference on **Pages V12-T3-114–V12-T3-167**.
- ② For applications other than standard residual scheme, see Application Data 29-160.
- ③ Does not void listing of UL Listed breakers.
- ④ Only one of the attachments may be mounted per breaker.
- ⑤ For other possible combinations, refer to factory.
- ⑥ Molded-case switches do not use standard SELTRONIC attachments and should be ordered by description.
- ⑦ Rated 48V minimum for ground fault applications requiring tripping at 55% of voltage.
- ⑧ Not for ground fault applications.
- ⑨ Interrupting capacities shown do not apply to molded-case switches.
- ⑩ Type Al/Cu pressure terminal.

Also used on breakers with ground fault and on separately mounted neutral current transformers. MARK 75 frame color changed from gray to black in mid-2002.

Types NC, NCA, NCG, NCGA, MARK 75 Type HNC, HNCA, HNCG, HNCGA SELTRONIC with Solid-State Trip Units, 600 Vac

Complete breaker requires frame and rating plug. See the table and terminals on **Page V12-T3-60**. Extra current transformer included for neutral. See accessories on **Page V12-T3-65** for remote ground fault trip indicator.

Shaded area denotes obsolete or discontinued products and services. ①

3

NC: 600 Vac



Type NC, NCA, MARK 75 Type HNC, HNCA SELTRONIC with Solid-State Trip Units, 600 Vac—Frame Only ②

Number of Poles ③	Standard (Long Delay and Short Time) Catalog Number	Short Time Only ④ Catalog Number	Long Delay, Short Time and Adjustable Short Delay Time (0.08–0.30 Seconds) Catalog Number
Types NC and NCA (800–1200A)			
2	NC21200F	NC21200FM	NCA21200F
3	NC31200F	NC31200FM	NCA31200F
Mark 75 Types HNC and HNCA (800–1200A)			
2	HNC21200F	HNC21200FM	HNCA21200F
3	HNC31200F	HNC31200FM	HNCA31200F

Types NCG, NCGA, and MARK 75 Types HNCG, HNCGA SELTRONIC with Built-In Ground Fault Protection

Complete breaker requires frame and rating plug. See the table and terminals on **Page V12-T3-60**. Extra current transformer included for neutral. See accessories on **Page V12-T3-65** for remote ground fault trip indicator.

Note: The standard ground fault unit above can also be used without the neutral CT. Order two of the desired terminals for each pole of the breaker and two for the neutral CT.

Types NCG, NCGA and MARK 75 Type HNCG, HNCGA SELTRONIC with Built-In Ground Fault Protection—Frame Only

Number of Poles	Standard (Long Delay, Short Time and Ground Fault Trip) Catalog Number	Long Delay, Short Time, Adjustable Short Delay Time, and Ground Fault Trip Catalog Number	Ground Fault Characteristics	
			Pickup Setting Amperes	Time Setting
Types NCG and NCGA (800–1200A) ⑤				
3	NCG31200F	NCGA31200F	120–1200	3.5–30 Cy
MARK 75 Types HNCG and HNCGA (800–1200A) ⑤				
3	HNCG31200F	HNCGA31200F	120–1200	3.5–30 Cy

Notes

① These frames are obsolete. Effective 2/1/02, only the MARK 75 version is available. For replacement solutions, see the cross-reference on **Pages V12-T3-114–V12-T3-167**.

② Complete breaker requires frame and rating plug. See the table on **Page V12-T3-60**. For terminals, see the table on **Page V12-T3-55**.

③ Two-pole breakers are supplied in three-pole frames with current-carrying parts omitted from center pole.

④ UL Recognized component.

⑤ For applications other than standard residual scheme, see Application Data 29-160.

Type NC 1200A molded-case switch; refer to **Page V12-T3-62**. MARK 75 frame color changed from gray to black in mid-2002.

Types NC, NCA, NCG, NCGA, MARK 75 Type HNC, HNCA, HNCG, HNCGA SELTRONIC with Solid-State Trip Units, 600 Vac Accessories and Modifications

Field-Mountable Attachments—Left Handed ^{①②③④⑤}

Description	Style Number
Provision to trip flux transfer shunt trip from external source 32 to 120 Vdc to 60 Hz ^⑥	1372D39G13
240 to 600 Vac, 50/60 Hz ^⑦	1372D39G23
Provision to trip flux transfer shunt trip from external source, plus a 1A-1B auxiliary switch 32 to 120 Vdc to 60 Hz ^⑥	1372D39G16
240 to 600 Vac, 50/60 Hz ^⑦	1372D39G26
Provision to trip flux transfer shunt trip from external 24 Vdc source	1371D94G05
1A-1B auxiliary switch	1371D39G03
24 Vdc shunt trip and 1A-1B auxiliary switch	1371D94G08

For CSA, see Page V12-T3-48.

Type NC SELTRONIC breakers meet requirements for Class 21a, and MARK 75. Type HNC meet Class 23a as defined by Federal Spec. W-C-375b.

UL Listed Interrupting Capacity, rms Symmetrical Amperes ^⑧

Breaker	AC Volts		
	240	480	600
NC, NCG	42,000	30,000	22,000
HNC, HNCG	65,000	50,000	25,000

Rating Plugs

Select from the table on Page V12-T3-60.

Terminals

Note: Two terminals required per pole.

Terminals ^⑨

Maximum Amperes	Number of Cables, Wire Range, Type	Catalog Number
Al/Cu Pressure Terminals		
1000	(3) 3/0–400 kcmil	TA1000NB1 ^⑩
1200 (std.)	(4) 4/0–500 kcmil	TA1200NB1 ^⑩
1200	(3) 500–750 kcmil	TA1201NB1 ^⑩
Optional Copper Pressure Terminals		
1000	(3) 3/0–500 kcmil	T1000NB1
1200	(4) 3/0–400 kcmil	T1200NB1

Additional Accessories and Modifications

Refer to Pages V12-T3-65–V12-T3-79.

Note: MARK 75 frame color changed from gray to black in mid-2002.

Notes

- ① For other possible combinations, refer to factory.
- ② Molded-case switches do not use standard SELTRONIC attachments and should be ordered by description.
- ③ Does not void listing of UL Listed breakers.
- ④ Only one of the attachments may be mounted per breaker.
- ⑤ Left pole mounting.
- ⑥ Rated 48V minimum for ground fault applications requiring tripping at 55% of voltage.
- ⑦ Not for ground fault applications.
- ⑧ Interrupting capacities shown do not apply to molded-case switches.
- ⑨ Also used on breakers with ground fault and on separately mounted neutral current transformers.
- ⑩ Type Al/Cu pressure terminal.

Types PC, PCA, PCC, PCCA 2000, 2500 and 3000A SELTRONIC with Solid-State Trip Units, 600 Vac, 50/60 Hz

Complete breaker requires frame and rating plug. See the table on **Page V12-T3-60** and rear connectors (connectors are included in 3000A and all front-connected frames.) Suitable for reverse-feed applications.

Shaded area denotes obsolete or discontinued products and services. ①

3

PC: 600 Vac



Breakers for Standard Applications—Frame Only

Number of Poles ②	Standard (Long Delay and Short Time) Catalog Number	Short Time Only ③ Catalog Number	Long Delay, Short Time Trip, and Adjustable Short Delay Time (0.08–0.30 seconds) Catalog Number
Type PC 2000, 1000 to 2000A ④ Rear-Connected Breakers		Type PCA 2000 ④ Rear-Connected Breakers	
2	PC22000F	PC22000FM	PCA22000F
3	PC32000F	PC32000FM	PCA32000F
Front-Connected Breakers		Front-Connected Breakers	
2	PCF22000F	PCF22000FM	PCFA22000F
3	PCF32000F	PCF32000FM	PCFA32000F
Type PC 2500, 1400 to 2500A ④ Rear-Connected Breakers		Type PCA 2500 ④ Rear-Connected Breakers	
2	PC22500F	PC22500FM	PCA22500F
3	PC32500F	PC32500FM	PCA32500F
Front-Connected Breakers		Front-Connected Breakers	
2	PCF22500F	PCF22500FM	PCFA22500F
3	PCF32500F	PCF32500FM	PCFA32500F
Type PC 3000, 1600 to 3000A ④		Type PCA 3000 ④	
2	PC23000F	PC23000FM	PCA23000F
3	PC33000F	PC33000FM	PCA33000F

Breakers for Standard Application at 100% Rating—Frame Only

Number of Poles ②	Standard (Long Delay and Short Time) Catalog Number	Short Time Only ③ Catalog Number	Long Delay, Short Time Trip, and Adjustable Short Delay Time (0.08–0.30 seconds) Catalog Number
Type PCC 2000, 1000 to 2000A ⑤—Rear-Connected Breakers			
2	PCC22000F	PCC22000FM	PCCA22000F
3	PCC32000F	PCC32000FM	PCCA32000F
Front Connected Breakers			
2	PCCF22000F	PCCF22000FM	PCCFA22000F
3	PCCF32000F	PCCF32000FM	PCCFA32000F
Type PCC 2500, 1400 to 2500A ⑤—Rear-Connected Breakers			
2	PCC22500F	PCC22500FM	PCCA22500F
3	PCC32500F	PCC32500FM	PCCA32500F
Front-Connected Breakers			
2	PCCF22500F	PCCF22500FM	PCCFA22500F
3	PCCF32500F	PCCF32500FM	PCCFA32500F
Type PC 3000, 1600 to 3000A ⑤			
2	PCC23000F	PCC23000FM	PCCA23000F
3	PCC33000F	PCC33000FM	PCCA33000F

Notes

- ① These frames are obsolete. For replacement solutions, see the cross-reference on **Pages V12-T3-114–V12-T3-167**.
- ② Two-pole breakers are supplied in three-pole frames with current carrying parts omitted from center pole.
- ③ UL Recognized component.
- ④ UL Listed for standard applications.
- ⑤ These breakers are UL Listed for application at 100% of rating per NEC exceptions when used in a properly ventilated and listed enclosure.

Accessories and Modifications

Drawout Mounting Breakers, Three-Pole Only

Breaker frame and complete drawout frame with safety tripping interlock.

Order by description. Secondary contacts supplied as required at no extra charge. Order required rating plug separately. Refer to **Page V12-T3-79**.

Note: Includes breakers without adjustable short delay time.

Rating Plugs

Select from the table on **Page V12-T3-60**.

Stationary portion of drawout frame only for future breaker installations, three-pole only. Refer to **Page V12-T3-79**.

Special Type PCC Breakers for SCR Power Supplies

These drawout mounting breakers are designed with a 2 to 4 times magnetic trip adjustment and special time delay trip characteristics to provide maximum protection and coordination with SCR power supplies on offshore drilling rigs. Suitable for application at 100% of rating.

Order by description. Secondary contacts supplied as required. Order standard rating plugs separately.

Availability: PCC2000, PCC2500 drawout-mounting breakers.

Type PC and PCC meet requirements of Class 25a as defined in Federal Spec. W-C-375b.

For CSA, see Page V12-T3-48.

UL Listed Interrupting Capacity rms Symmetrical Amperes (Standard and Ground Fault Breakers) ^①

Breaker	AC Volts		
	240	480	600
PC, PCC	125,000	100,000	100,000

Note

^① Interrupting capacities shown do not apply to molded-case switches.

Additional Accessories and Modifications

Refer to **Pages V12-T3-65–V12-T3-79**.

Types PCG, PCGA, PCCG, PCCGA SELTRONIC with Built-In Ground Fault Protection Includes Extra Current Transformer for Neutral (Optional Remote Ground Fault Trip Indicator Kit, Page V12-T3-65)

Complete breaker requires frame and rating plug. See the table on **Page V12-T3-60** and rear connectors (except front-connected frames and 3000A frames include connectors).

Shaded area denotes obsolete or discontinued products and services.

Note: Available without extra CT for neutral. Order by description as similar to above except without neutral CT or external CT terminal connections at same price. Older catalog numbers: PCFGX—"X" means without fourth CT.

Note: The standard ground fault unit listed can also be used without the neutral CT.

Breakers for Standard Application—Frame Only

Number of Poles	Standard (Long Delay, Short Time and Ground Fault Trip) Catalog Number	Long Delay, Short Time, Ground Fault Trip, and Adjustable Short Delay Time (0.08–0.30 Seconds) Catalog Number	Ground Fault Characteristics	
			Pickup Setting	Time Setting
Type PCG 2000 ①②—Rear-Connected Breakers				
3	PCG32000F	PCGA32000F	200–1200	3.5–30 cycles
Front-Connected Breakers				
3	PCFG32000F	PCFGA32000F	200–1200	3.5–30 cycles
Type PCG 2500 ①②—Rear-Connected Breakers				
3	PCG32500F	PCGA32500F	240–1200	3.5–30 cycles
Front-Connected Breakers				
3	PCFG32500F	PCFGA32500F	240–1200	3.5–30 cycles
Type PCG 3000 ①②				
3	PCG33000F	PCGA33000F	300–1200	3.5–30 cycles

Breakers for Application at 100% Rating—Frame Only

Number of Poles	Standard (Long Delay, Short Time and Ground Fault Trip) Catalog Number	Long Delay, Short Time, Ground Fault Trip, and Adjustable Short Delay Time (0.08–0.30 Seconds) Catalog Number	Ground Fault Characteristics	
			Pickup Setting	Time Setting
Type PCCG 2000 ③—Rear-Connected Breakers				
3	PCCG32000F	PCCGA32000F	200–1200	3.5–30 cycles
Front-Connected Breakers				
3	PCCFG32000F	PCCFGA32000F	200–1200	3.5–30 cycles
Type PCCG 2500 ③—Rear-Connected Breakers				
3	PCCG32500F	PCCGA32500F	240–1200	3.5–30 cycles
Front-Connected Breakers				
3	PCCFG32500F	PCCFGA32500F	240–1200	3.5–30 cycles
Type PCCG 3000 ③				
3	PCCG33000F	PCCGA33000F	300–1200	3.5–30 cycles

Notes

- ① UL Listed for standard applications.
- ② For application other than standard residual schemes, refer to Application Data 29-160.
- ③ These breakers are UL Listed for application at 100% of rating per NEC exceptions when used in a properly ventilated and listed enclosure.

Types PCG, PCGA, PCCG, PCCGA SELTRONIC with Built-In Ground Fault Protection Accessories and Modifications

PC breakers are not UL Listed.

Field-Mountable Attachments ^{①②③}

Description	Style Number
Provision to trip flux transfer shunt trip from external source 32 to 120 Vdc to 60 Hz ^④	1372D35G22
240 to 600 Vac, 50/60 Hz ^⑤	1372D35G32
Provision to trip flux transfer shunt trip from external source plus 1A-1B auxiliary switch 32 to 120 Vdc to 60 Hz ^④	1372D35G15
240 to 600 Vac, 50/60 Hz ^⑤	1372D35G25
2A-2B auxiliary switch	1372D35G18
Provision to trip flux transfer shunt trip from external 24 Vdc source	1371D95G01
1A-1B auxiliary switch	1372D35G03
1A-1B auxiliary switch and 24 Vdc shunt trip	1371D95G04
2A-2B auxiliary switch and 24 Vdc shunt trip	1371D95G07
3A-3B auxiliary switch and 24 Vdc shunt trip	1371D95G10

Rear Bus Connectors

Two required per pole. Fixed mounting breakers.

Rear Bus Connectors

Breaker Frame ^⑥	Connector Style/Catalog Number
PC2000 ^⑦ , PCC2000 ^⑦	BA2000PB
PC2500 ^⑦ , PCC2500 ^⑦	BA2500PB
PC3000, PCC3000	Included in frame

Racking Crank for Drawout Frames

To engage or withdraw the moving portion of the drawout. A standard 0.50-inch hex socket with extension can be used for this purpose.

Racking Crank

Style Number

765A767G01

Cell Switches Mounted on Drawout Frames, All Ratings

A maximum of four switches can be provided. Order by description. Each switch provides a NO and NC contact that transfers before reaching the test position when being withdrawn, and after the test position when being racked in.

Approximate Shipping Weights, PC and PCC Breakers (Three-Pole)

Rating	Breaker			
	PC, PCC	PCF, PCCF	PCG, PCCG	PCFG, PCCFG
2000	136 lbs	163 lbs	160 lbs	185 lbs
2500	145 lbs	175 lbs	170 lbs	200 lbs
3000	220 lbs	—	245 lbs	—

Busbar Connections

"T" Connector



Busbar Connections— "T" Connector (For Cu/Al Bus)

Catalog Number

BA2000PB

Two required per pole. For rear bus connection of breakers through 2000A. Accepts up to four bus bolts. May be rotated 90°.

Note: Shipped separately from breaker.

"C" Connector



"C" Connector (For Cu/Al Bus)

Breaker Amperes

2500

Catalog Number

BA2500PB

Two required per pole. For rear bus connection of 2500A breakers.

Cable Connector



Cable Connector

Catalog Number

505C706G04

Fits "T" Connector and 2000A front-connected breakers. Accepts four 400–600 kcmil copper cables.

Notes

- ① For other possible combinations, contact your local Eaton Field Sales office.
- ② Only one of these attachments may be mounted per breaker.
- ③ Left pole mounting.
- ④ Rated 48V minimum for ground fault applications.
- ⑤ Not for ground fault applications.
- ⑥ Also apply to equivalent ratings of PCG and PCCG ground fault breakers.
- ⑦ Not required for front-connected frames.

SELTRONIC Rating Plug Selection Data

Rating plugs listed below are for both standard breakers and breakers with built-in ground fault protection.

Rating Plug Selection Data

Rating Plugs Only (For Two- or Three-Pole Frames)

Continuous Ampere Rating ^①	Magnetic Trip Setting, Amperes		Fixed Rating Plugs Catalog Number	Adjustable Rating Plugs ^{②③} Catalog Number
	Low	High		
For 150A Frames: LC, LCA, LCG, LCGA, HLC, HLCA, HLCG, HLCGA				
75	225	750	1LC75	—
90	270	900	1LC90	—
100	300	1000	1LC100	A1LC100 ^④
125	375	1250	1LC125	A1LC125
150	450	1500	1LC150	A1LC150 ^⑤
For 300A Frames: LC, LCA, LCG, LCGA, HLC, HLCA, HLCA, HLCG, HLCGA				
150	450	1500	3LC150	—
175	525	1750	3LC175	—
200	600	2000	3LC200	—
225	675	2250	3LC225	A3LC225
250	750	2500	3LC250	A3LC250
275	825	2750	3LC275	A3LC275
300	900	3000	3LC300	A3LC300 ^⑤
For 400A Frames: LC, LCA, LCG, LCGA, HLC, HLCA, HLCG, HLCGA				
200	600	2000	4LC200	—
225	675	2250	4LC225	—
250	750	2500	4LC250	—
300	900	3000	4LC300	A4LC300
350	1050	3500	4LC350	A4LC350
400	1200	4000	4LC400	A4LC400 ^⑤
For 600A Frames: LC, LCA, LCG, LCGA, HLC, HLCA, HLCG, HLCGA, LCC, LCCA, HLCC, HLCCA, LCCG, LCCGA, HLCCG, HLCCGA				
300	900	3000	6LC300	—
350	1050	3500	6LC350	—
400	1200	4000	6LC400	A6LC400 ^④
450	1350	4500	6LC450	A6LC450
500	1500	5000	6LC500	A6LC500
600	1800	6000	6LC600	A6LC600 ^⑤
For 800A Frames: MC, MCA, MCG, MCGA, HMC, HMCA, HMC, HMCG, HMCGA, MCC, MCCA, HMCC, HMCCA, MCCG, MCCGA, HMCCG, HMCCGA, MDS				
400	1200	4000	8MC400	—
500	1500	5000	8MC500	A8MC500 ^⑤
600	1800	6000	8MC600	A8MC600
700	2100	7000	8MC700	A8MC700
800	2400	8000	8MC800	A8MC800 ^⑤

Rating Plugs Only (For Two- or Three-Pole Frames)

Continuous Ampere Rating ^①	Magnetic Trip Setting, Amperes		Fixed Rating Plugs Catalog Number	Adjustable Rating Plugs ^{②③} Catalog Number
	Low	High		
For 1200A Frames: NC, NCA, NCG, NCGA, HNC, HNCA, HNCG, HNCGA				
800	1600	6400	12NC800	A12NC800 ^④
900	1800	7200	12NC900	A12NC900
1000	2000	8000	12NC1000	A12NC1000
1200	2400	9600	12NC1200	A12NC1200 ^⑤
For 2000A Frames: PC, PCA, PCC, PCCA, PCG, PCGA, PCCG, PCCGA				
1000	2000	8000	20PC1000	—
1200	2400	9600	20PC1200	—
1400	2800	11,200	20PC1400	—
1600	3200	12,800	20PC1600	A20PC1600
1800	3600	14,400	20PC1800	A20PC1800
2000	4000	16,000	20PC2000	A20PC2000 ^⑤
For 2500A Frames: PC, PCA, PCC, PCCA, PCG, PCGA, PCCG, PCCGA				
1400	2800	11,200	25PC1400	—
1600	3200	12,800	25PC1600	—
1800	3600	14,400	25PC1800	A25PC1800
2000	4000	16,000	25PC2000	A25PC2000
2500	5000	20,000	25PC2500	A25PC2500 ^⑤
For 3000A Frames: PC, PCA, PCC, PCCA, PCG, PCGA, PCCG, PCCGA				
1600	3200	12,800	30PC1600	—
1800	3600	14,400	30PC1800	—
2000	4000	16,000	30PC2000	—
2500	5000	20,000	30PC2500	A30PC2500
3000	6000	24,000	30PC3000	A30PC3000 ^⑤

Notes

- ① Ampere rating when used in short time only frames:
 LC-150: 150A MC-800: 800A PC-3000: 3000A
 LC-300: 300A NC-1200: 1200A LCL-250: 250A
 LC-400: 400A PC-2000: 2000A LCL-400: 400A
 LC-600: 600A PC-2500: 2500A
- ② Magnetic trip range of adjustable rating plugs:
 LC, HLC, MC, HMC: 3 to 10 times ampere setting
 NC, HNC, PC, PCC, LCL-400: 2 to 8 times ampere setting
 LCL-250: 3 to 9 times ampere setting
- ③ Adjustable 70 to 100% except as noted.
- ④ Adjustable 75 to 100%.
- ⑤ Adjustable 50 to 100%.
- ⑥ Adjustable 80 to 100%.

Contact Avery Creek, NC, Technical Resource Center for old style (three prong) ground fault rating plugs.

Molded-Case Switches

Molded-case switches are UL Listed devices and are available only as high magnetic trip type with fixed trip setting.

■ Shaded area denotes obsolete or discontinued products and services. ①

Molded-Case Switches with High Magnetic Trip (Fixed Trip Setting)

Number of Poles	Maximum Volts	Maximum Amperes	Switch Catalog Number ②③
2	240	400	DA2400WK
3	240	400	DA3400WK
1	120	100	EB1100LK
2	240	100	EB2100LK
3	240	100	EB3100LK
3	240	100	EB3100SLK
1	277	100	EHB1100LK
2	480	100	EHB2100LK
3	480	100	EHB3100LK
3	480	100	EHB3100SLK
2	600	100	FB2100LK
2	600	150	FB2150LK
3	600	100	FB3100LK
3	600	150	FB3150LK
3	600	150	FB3150SLK
4	277/480	100	FB4100LK
4	277/480	150	FB4150LK
2	600	225	JA2225WK
2	600	225	JA2225WSK
3	600	225	JA3225WK
3	600	225	JA3225WSK
2	600	250	JB2250WK
2	600	250	JB2250WSK
3	600	250	JB3250WK
3	600	250	JB3250WSK
2	600	225	KA2225WK
2	600	225	KA2225WSK
3	600	225	KA3225WK
3	600	225	KA3225WSK
2	600	250	KB2250WK
2	600	250	KB2250WSK
3	600	250	KB3250WK
3	600	250	KB3250WSK
2	600	400	LB2400WK
2	600	400	LB2400WSK
3	600	400	LB3400WK
3	600	400	LB3400WSK
2	600	400	LBB2400WK
2	600	400	LBB2400WSK
3	600	400	LBB3400WK
3	600	400	LBB3400WSK

Molded-Case Switch Terminal Data

MCS Type	Maximum Switch Amperes	Wire Type	Number of Wires	Wire Range	Terminal Type or Catalog Number
Standard Terminals					
DA, LB, LBB	400	Cu only	2	3/0–250 kcmil	T400DA2
EB, EHB, FB	100	Cu	1	#14–1/0	Pressure
FB	150	Cu/Al	1	#4–4/0	Pressure
JA, KA	225	Cu/Al	1	#4–350 kcmil	TA225LA1
JB, KB	250	Cu/Al	1	#4–350 kcmil	TA250KB
Optional Terminals					
DA, LB, LBB	400	—	—	—	—
EB, EHB, FB	100	Cu/Al	1	#4–4/0	Pressure
FB	150	—	—	—	—
JA, KA	225	Cu	1	#6–350 kcmil	T225LA
JB, KB	250	Cu	1	#4–350 kcmil	T250KB

Molded-Case Switches with High Magnetic Trip—Trip Setting and Tolerance

Frame	Rating	Trip Setting (Amperes)	Tolerance (%)
EB	100	1000	±20
EHB/FB	100	1200	±20
FB	150	1500	±20
DA/LB/LBB	400	4000	+10 –0
JA/KA	225	2250	+10 –0
JB/KB	250	2500	+10 –0

Notes

- ① These frames are obsolete. For replacement solutions, see the cross-reference on **Pages V12-T3-114–V12-T3-167**.
- ② Catalog number suffix identification:
 K = Molded-case switch with high magnetic trip (fixed trip setting)
 S = Saf-T-Vue cover
 L = With line and load terminals
 W = No terminals
- ③ Molded-case switch dimensions are the same as the equivalent thermal-magnetic breaker. Refer to Dimension Sheet 29-171.

Shaded area denotes obsolete or discontinued products and services. ①

Molded-Case Switches with High Magnetic Trip (Fixed Trip Setting)

Number of Poles	Maximum Volts	Maximum Amperes	Switch Catalog Number ②③
2	240	225	CA2225KW
3	240	225	CA3225KW
2	600	400	LA2400WK
2	600	400	LA2400WSK
2	600	600	LA2600WK
2	600	600	LA2600WSK
3	600	400	LA3400WK
3	600	400	LA3400WSK
3	600	400	LA3600WK
3	600	400	LA3600WSK
2	600	400	LAB2400WK
2	600	400	LAB2400WSK
3	600	400	LAB3400WK
3	600	400	LAB3400WSK
2	600	600	LC2600WK ④
3	600	600	LC3600WK ④
2	600	600	LCC2600WK ④
3	600	600	LCC3600WK ④
2	600	800	MA2800WK
2	600	800	MA2800WSK
3	600	800	MA3800WK
3	600	800	MA3800WSK
2	600	800	MC2800WK ④
3	600	800	MC3800WK ④
2	600	800	MCC2800WK ④
3	600	800	MCC3800WK ④
2	600	1200	NB21200WK
2	600	1200	NB21200WSK
3	600	1200	NB31200WK
3	600	1200	NB31200WSK
2	600	1200	NC21200WK ④
3	600	1200	NC31200WK ④
2	600	2000	PB22000WK
2	600	2500	PB22500WK
3	600	2000	PB32000WK
3	600	2500	PB32500WK
2	600	2000	PBF22000K
3	600	2000	PBF32000K
2 ⑤	600	2000	PC22000WK
2 ⑤	600	2500	PC22500WK
2 ⑤	600	3000	PC23000K
3 ⑤	600	2000	PC32000WK
3 ⑤	600	2500	PC32500WK
3 ⑤	600	3000	PC33000K
2 ⑤	600	2000	PCC22000WK
2 ⑤	600	2500	PCC22500WK
2 ⑤	600	3000	PCC23000K
3 ⑤	600	2000	PCC32000WK
3 ⑤	600	2500	PCC32500WK
3 ⑤	600	3000	PCC33000K
2 ⑤	600	2000	PCF22000K
3 ⑤	600	2000	PCF32000K

Molded-Case Switch Terminal Data

MCS Type	Maximum Switch Amperes	Wire Range	Wire Type	Number of Wires	Terminal Type or Catalog Number
Standard Terminals (Aluminum Body)					
CA	225	#1–300 kcmil	Cu/Al	1	TA225CA2
LA400, LAB	400	#4–250 kcmil, plus 3/0–600 kcmil	Cu/Al	1	TA400LA1
LA600, LC600	600	250/500 kcmil	Cu/Al	2	TA600LA
MC, MA	800	3/0–400 kcmil	Cu/Al	3	TA800MA2
NC, NB	1200	4/0–500 kcmil	Cu/Al	4	TA1200NB1
NC, NB	1200	—	—	—	—
PC2000, PCC2000	2000	BA2000PB rear bus connector			
PC2500, PCC2500	2500	BA2500PB rear bus connector			
PC3000, PCC3000	3000	Rear bus connector included in frame			
Optional Terminals					
CA	225	—	—	—	—
LA400, LAB	400	#4–250 kcmil, plus 3/0–600 kcmil	Cu	1	T401LA
LA600, LC600	600	250/500 kcmil	Cu	2	T600LA
MC, MA	800	3/0–300 kcmil	Cu	3	T800MA1
NC, NB	1200	3/0–400 kcmil	Cu	4	T1200NB1
NC, NB	1200	500–750 kcmil	Cu/Al	3	TA1201NB1
PC2000, PCC2000	2000	BA2000PB rear bus connector			
PC2500, PCC2500	2500	BA2500PB rear bus connector			
PC3000, PCC3000	3000	Rear bus connector included in frame			

Molded-Case Switches With High Magnetic Trip—Trip Setting and Tolerance

Frame	Rating	Trip Setting (Amperes)	Tolerance (%)
CA	225	2250	+20 –10
LA (400)	400	4000	+10 –0
LA/LC	600	6000	+10 –0
MA/MC	800	8000	+10 –0
NB/NC	1200	12,000	+10 –0
PB/PC	2000–3000	12,000	+10 –0

Notes

- ① These frames are obsolete. For replacement solutions, see the cross-reference on Pages V12-T3-114–V12-T3-167.
- ② Catalog number suffix identification:
K = Molded-case switch with high magnetic trip (fixed trip setting)
S = Saf-T-Vue cover
W = No terminals
- ③ Molded-case switch dimensions are the same as the equivalent thermal-magnetic breaker. Refer to Dimension Sheet 29-171.
- ④ For molded-case switch types LC, LCC—use LA attachments;
MC and MCC—use MA attachments; NC—use NB attachments.
- ⑤ For molded-case switch types PC, PCC and PCF, rating plug is included and use SELTRONIC PC attachments.

Type MCP Motor Circuit Protector

The motor circuit protector (MCP) is designed specifically for the protection of motor circuits. It operates on the magnetic principle with a current sensing coil in each of the three poles, with the trip-point adjustable from the front. MCPs are the fastest devices available for clearing low level faults and offer circuit breaker features and convenience—resettable, quick-make quick-break, deadfront and protection against single phasing.

MCPs are rated to correspond to NEMA starter size.

Current Limiter Attachment

The EL current limiter is an attachment that bolts to the load end of the MCP to provide increased interrupting capacity. The combination is UL Listed as a recognized component for application at up to 200,000A symmetrical at 600 Vac. It is coordinated with the MCP so that normal short circuits will be cleared automatically by the MCP, opening all three poles, and only the rare high fault will cause the limiter to function. Current limiters must be applied as shown in the terminal table above.

Note: Sizes 0–4 only.

Terminals

Terminals are included with both the MCP and the current limiter. Standard terminals are aluminum alloy, with non-aluminum terminals optional for use with only the MCP. Both standard and optional terminals will accommodate aluminum or copper conductors.

Note: Except 400A Size 5. Non-aluminum terminal suitable for copper only.

When using aluminum conductors, use of joint compound is recommended. Wire ranges are listed in the terminal table above.

Sizes 0–4 MCP with Current Limiter



Size 5 MCP 532500



Terminals

MCP or Limiter (Amperes)	Standard Aluminum	Optional Non-Aluminum
Size 0, 1, 2	#14–#4	#14–1/0
Size 3	#6–3/0	#14–1/0
Size 4	#4–4/0	#4–4/0
Size 5 (250)	#4–350 kcmil	#4–350 kcmil
Size 5 (400)	—	(2) 3/0–250 kcmil
Limiters to 50	#14–#2	—
Limiters to 100	#1–4/0	—
Limiters to 150	#1–4/0	—

Motor Circuit Protectors

Shaded area denotes obsolete or discontinued products and services. ①

Starter Size	Trip Range, Amperes	Continuous Ampere Rating	With Standard Aluminum Alloy Terminals Catalog Number	With Optional Non-Aluminum Terminals ② Catalog Number
0	7–22	3	MCP0322R	MCP0322CR
0	18–58	7	MCP0358R	MCP0358CR
0	50–150	15	MCP03150R	MCP03150CR
1	100–300	30	MCP13300R	MCP13300CR
2	160–480	50	MCP23480R	MCP23480CR
3	275–1000	100	MCP331000R	MCP331000CR
4	450–1550	150	MCP431550R	MCP431550CR
4	575–1800	150	MCP431800R	MCP431800CR
5	1250–2500	250	MCP532500	MCP532500C
5	2000–4000	400	—	MCP534000C

UL Listed

The MCP is UL Listed as a recognized component and requires additional listing by the control manufacturer in combination with a contactor and overload relay.

Modifications for MCP

These modifications must be factory installed. Consult factory for pricing.

Modifications for MCP ③

Description
Auxiliary switches ④—1A and 1B, 2As and 2Bs
Shunt trip ④
Undervoltage release ④⑤⑥
Moisture-fungus treatment

Accessories for MCP

For handle mechanisms refer to **Pages V12-T3-95–V12-T3-112**.

Note: On 400A Size 5, an external resistor is supplied for voltages, above 240 Vac and 24 Vdc.

Accessories for MCP

For MCP Size	Use Accessories For
Sizes 0–4	FB
5 (250A)	KB
5 (400A)	LB

Current Limiters

Limiter Catalog Numbers	For MCP Catalog Numbers ①
EL3003R	MCP0322R
EL3007R	MCP0358R
EL3015R	MCP03150R
EL3030R	MCP13300R
EL3050R	MCP23480R
EL3100R	MCP331000R
EL3150R	MCP431550R
EL3150R	MCP431800R

Interrupting Ratings

Maximum application current shall be determined by testing the MCP in combination with a contactor and overload relay. Additional capacity can be obtained by using the current limiter attachment.

Base Mounting Hardware

No charge when ordered with MCP. Order separately when required.

Base Mounting Hardware

Description	Style Number
Sizes 0–4	21C6782G18
Size 5 (250A)	673B125G12
Size 5 (400A)	21C6782G22

Notes

- ① These frames are obsolete. For replacement solutions, see the cross-reference on **Pages V12-T3-114–V12-T3-167**.
- ② Catalog numbers ending in CR were previously listed ending in RC. This is a catalog number change only, not a material change.
- ③ Not UL Listed.
- ④ Mounts only in right pole; only one Modification marked can be used in MCP (Sizes 0–4).
- ⑤ On 400A Size 5, an external resistor is supplied for voltages above 240 Vac and 24 Vdc.
- ⑥ On Sizes 0–4 and 250A Size 5, an external resistor is supplied for customer mounting, except for 120 Vac, 12, 24, 125 Vdc.
- ⑦ Also applicable to MCPs with optional terminals.

Series C 30 mA Ground Fault (Earth Leakage)

The Series C units (prefix only listed below) that included a breaker and integral Earth Leakage module have been replaced by the Series G solution that has the flexibility to add the Earth Leakage module in the field. The Series G solution has an extended range of 15–630A.

Series C 30 mA Ground Fault (Earth Leakage)

Ampere Range—15–400A

Catalog Prefix

Three-Pole	Four-Pole
ELFD	EL4FD
ELFW	EL4FW
ELHMCP	EL4HFD
ELHFD	EL4HFW
ELHFW	EL4HJW
ELHJD	EL4HKW
ELHJW	EL4JW
ELHKD	EL4KW
ELHKW	—
ELJD	—
ELJW	—
ELKD	—
ELKW	—

Note: Please contact Eaton customer service for assistance with crossing from the obsolete product to the new Series G.

Earth Leakage

Ampere Rating	Series C Four-Pole	Series G MCCB	Series G MCCB Alt	Series G Earth Leakage Module
15	EL4FD3015L	EGS4015FFG	EGC4015FFG	ELEBN4125G
20	EL4FD3020L	EGS4020FFG	EGC4020FFG	ELEBN4125G
25	EL4FD3025L	EGS4025FFG	EGC4025FFG	ELEBN4125G
30	EL4FD3030L	EGS4030FFG	EGC4030FFG	ELEBN4125G
35	EL4FD3035L	EGS4035FFG	EGC4035FFG	ELEBN4125G
40	EL4FD3040L	EGS4040FFG	EGC4040FFG	ELEBN4125G
45	EL4FD3045L	EGS4045FFG	EGC4045FFG	ELEBN4125G
50	EL4FD3050L	EGS4050FFG	EGC4050FFG	ELEBN4125G
60	EL4FD3060L	EGS4060FFG	EGC4060FFG	ELEBN4125G
70	EL4FD3070L	EGS4070FFG	EGC4070FFG	ELEBN4125G
80	EL4FD3080L	EGS4080FFG	EGC4080FFG	ELEBN4125G
90	EL4FD3090L	EGS4090FFG	EGC4090FFG	ELEBN4125G
100	EL4FD3100L	EGS4100FFG	EGC4100FFG	ELEBN4125G
110	EL4FD3110L	EGS4110FFG	EGC4110FFG	ELEBN4125G
125	EL4FD3125L	EGS4125FFG	EGC4125FFG	ELEBN4125G
150	EL4FD3150L	JGE4150FAG	JGC4150FAG	ELJBN4150W
50	EL4FW3050JL	GES4050AFM	—	ELEBE4125G
50	EL4FWC3050JL	GEC4050AFM	—	ELEBE4125G
15	EL4HFD3015L	EGH4015FFG	—	ELEBN4125G
20	EL4HFD3020L	EGH4020FFG	—	ELEBN4125G
25	EL4HFD3025L	EGH4025FFG	—	ELEBN4125G
30	EL4HFD3030L	EGH4030FFG	—	ELEBN4125G
35	EL4HFD3035L	EGH4035FFG	—	ELEBN4125G
40	EL4HFD3040L	EGH4040FFG	—	ELEBN4125G
45	EL4HFD3045L	EGH4045FFG	—	ELEBN4125G
50	EL4HFD3050L	EGH4050FFG	—	ELEBN4125G
60	EL4HFD3060L	EGH4060FFG	—	ELEBN4125G
70	EL4HFD3070L	EGH4070FFG	—	ELEBN4125G
80	EL4HFD3080L	EGH4080FFG	—	ELEBN4125G
90	EL4HFD3090L	EGH4090FFG	—	ELEBN4125G
100	EL4HFD3100L	EGH4100FFG	—	ELEBN4125G
110	EL4HFD3110L	EGH4110FFG	—	ELEBN4125G
125	EL4HFD3125L	EGH4125FFG	—	ELEBN4125G
150	EL4HFD3150L	JGH3150FAG	—	ELJBN4150W

Portable Test Kit and Remote Ground Fault Trip Indicator

Portable Test Kit



Provides verification of performance of all frame sizes of SELTRONIC breakers while devices are still in service under varying load and/or phase unbalance. The tester operates on 120V, 50/60 Hz, and includes complete instructions and test times for testing the long time, instantaneous operation and optional ground fault operation of the breaker.

Portable Test Kit

Style Number

STK2

Remote Ground Fault Trip Indicator



For use only with SELTRONIC circuit breakers (LCG, HLCG, MCG, HMCG, NCG, HNCG, PCG and PCCG) with built-in ground fault protection.

Note: UL Listed as a recognized component.

The SELTRONIC ground fault indicator is a remotely mounted device with a combination indicating light/reset/test button that will light when the breaker trips on a ground fault. Tripping from overloads or short circuits will not activate the device. A separate 120V, 50/60 Hz power source is required to power the light and internal relay, which has 1NO/1NC contacts for customer connected alarm, etc. Designed for panel mounting, it can be face-mounted by ordering the optional mounting bracket below.

Remote Ground Fault Indicator

Style Number Catalog Number

1259C14G01 GFAU

Face Mounting Bracket



Face Mounting Bracket for Ground Fault Indicator

Style Number

1264C67G01

Accessories

Rear-Connected Studs

For complete stud assembly, order a stud and an appropriate tube based on thickness of customer's

mounting panel. A short stud must be assembled adjacent to a long stud to maintain clearances required by Underwriters Laboratories.

400A LA studs of the same length have sufficient clearance; however, customer connections may make it necessary to use a short stud

adjacent to a long stud. Two studs are required per pole. Refer to DS29171 Dimension Sheets for stud sizes and extensions behind breaker.

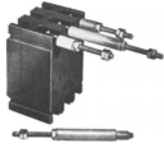
Rear Connected Stud**For DA, EB, EHB, FB, JA, KA, JB, KB, LB, LBB, HFB, HKA, HKB and HLB Breakers** ①

Mounting Panel Thickness, Inches	Stud ② Length	Style Number	Tube ③ Length	Style Number
DA, LB, LBB and HLB Breakers				
3/4-1	Short	656D565G03	27/32	313C909H17
3/4-1	Long	656D565G04	3-25/32	313C909H20
1/2-3/4	Short	656D565G03	1-3/32	313C909H18
1/2-3/4	Long	656D565G04	4-1/32	313C909H21
1/4-1/2	Short	656D565G03	1-11/32	313C909H19
1/4-1/2	Long	656D565G04	4-9/32	313C909H22
EB, EHB, FB and HFB (100A Maximum)				
1	Short	451D874G01	1-1/16	32B9446H20
1	Long	451D874G02	3-7/16	32B9446H24
1-1/16-15/16	Short	451D874G01	1-3/8	32B9446H21
1-1/16-15/16	Long	451D874G02	3-3/4	32B9446H25
3/8-5/8	Short	451D874G01	1-11/16	32B9446H22
3/8-5/8	Long	451D874G02	4-1/16	32B9446H26
1/4-5/16	Short	451D874G01	2	32B9446H23
1/4-5/16	Long	451D874G02	4-3/8	32B9446H27
FB, HFB 150 Ampere Breakers				
1	Short	374D883G01	1-1/16	374D883H06
1	Long	374D883G02	4-5/16	374D883H10
11/16-15/16	Short	374D883G01	1-3/8	374D883H07
11/16-15/16	Long	374D883G02	4-5/8	374D883H11
3/8-5/8	Short	374D883G01	1-11/16	374D883H08
3/8-5/8	Long	374D883G02	4-15/16	374D883H12
1/4-5/16	Short	374D883G01	2	374D883H09
1/4-5/16	Long	374D883G02	5-1/4	374D883H13
JA, KA and HKA Breakers				
3/4-1	Short	656D565G01	27/32	456D983H05
3/4-1	Long	656D565G02	3-25/32	456D983H08
1/2-3/4	Short	656D565G01	1-3/32	456D983H06
1/2-3/4	Long	656D565G02	4-1/32	456D983H09
1/4-1/2	Short	656D565G01	1-11/32	456D983H07
1/4-1/2	Long	656D565G02	4-9/32	456D983H10
JB, KB and HKB Breakers				
3/4-1	Short	5010D23G01	27/32	456D983H05
3/4-1	Long	5010D23G02	3-7/8	5010D23H05
1/2-3/4	Short	5010D23G01	1-3/32	456D983H06
1/2-3/4	Long	5010D23G02	4-1/8	5010D23H06
1/4-1/2	Short	5010D23G01	1-11/32	456D983H07
1/4-1/2	Long	5010D23G02	4-3/8	5010D23H07

Notes

- ① For insulated panels only; two required per pole.
- ② Not UL Listed.
- ③ Included at no charge when ordered with stud.

For LAB, LA, MA, HLA, HMA and HNB Breakers ^①

Stud Ampere Rating	Diameter, Inches and Thread	Extension Back of Breaker, Inches	Stud Style Number
LAB, LA, HLA, LC and HLC Breakers			
225 ^②	1/2-13	3-7/32	1241 345
225 ^②	1/2-13	6-9/32	1241 346
225 ^{②③}	1/2-13	4-31/32	1241 392
400 ^②	3/4-16	5-15/32	5B7383G15
400 ^②	3/4-16	7-31/32	5B7383G16
400 ^②	3/4-16	10-15/32	5B7383G17
600 ^④	1-12	5-29/32	314C960G07
600 ^④	1-12	5-13/32	314C960G08
600 ^④	1-12	5-29/32	314C960G09
MA, HMA, MC, HMC, MD and MDS Breakers			
225	1/2-13	3-21/32	314C960G01
400	3/4-16	5-29/32	314C960G04
400	3/4-16	8-13/32	314C960G05
400	3/4-16	10-29/32	314C960G06
600	1-12	5-29/32	314C960G07
600	1-12	8-13/32	314C960G08
600	1-12	10-29/32	314C960G09
800	1-1/8-12	5-29/32	314C960G10
800	1-1/8-12	8-13/32	314C960G11
800	1-1/8-12	10-29/32	314C960G12
NB, HNB, NC and HNC Breakers			
800	1-1/8-12	5-1/2	623B222G01
800	1-1/8-12	8	623B222G02
800	1-1/8-12	10-1/2	623B222G03
1200	1-1/4-12	5-1/2	373B375G04
1200	1-1/4-12	10-1/2	373B375G03

Notes

- ^① For insulated panels only; two required per pole.
^② 150, 250, 300 and 400A frames only.
^③ This is a special stud that includes six contact nuts for use where bus contact nuts must be used.
^④ 600A frames only.

Panelboard Connecting Straps

For connecting line end of breakers to panelboard bus.

Panelboard Connecting Strap

3

For DA, EB, EHB, FB, JA, KA, JB, KB, LB, LBB, HFB, HKB and HLB Breakers

Ampere Rating	Connector Type ^①	Style Number
EB, EHB, FB and HFB Breakers Narrow Distribution Panelboards ^②		
50	Center	673B142G02
50	Outside	673B142G09
100	Center	673B142G02
100	Outside	673B142G10
150	Center	673B142G04
150	Outside	673B142G03
Power Panelboards (Convertible) ^③		
50	Center	1253C72G01
50	Outside	1253C72G03
100	Center	1253C73G03
100	Outside	1253C73G06
150	Center	1253C73G01
150	Outside	1253C73G05
Three-pole mounting bracket		624B600H01
Two-pole mounting bracket		624B600H02
DA, LB, LBB and HLB Breakers ^③		
400	Center	314C940G04
400	Outside	505C680G01
Mounting bracket (one required)		208B264H01
JA, KA and HKA Breakers ^③		
225	Center	314C940G03
225	Outside	180C074G01
Mounting bracket (one required)		208B264H01
JB, KB and HKB Breakers ^③		
250	Center	2600D26G01
250	Outside	2600D26G02
Mounting bracket (one required)		1576707

For CA, LAB, LA, MA, HLA, HMA and HNB Breakers

Ampere Rating	Connector Type ^①	Style Number
CA Breaker Power Panelboards (Convertible) ^③		
225	Center	1253C74G01
225	Outside	1253C74G02
Three-pole mounting bracket		624B624H01
Two-pole mounting bracket		624B624H02
LAB, LA, HLA, LC, HLC 150, 300 and 400A Frames ^③		
400	Center	32B4570G02
400	Outside	314C541G01
Mounting bracket (two required)		208B297H01
LA, HLA, LC and HLC 600A Frames ^③		
600	Center	624B609G01
600	Outside	506C052G01
Mounting bracket (two required)		208B297H01
MA, HMA, MC, HMC, MD and MDS Breakers ^③		
800	Short	314C996G01
800	Medium	314C996G02
800	Long	314C996G03
Mounting bracket (four required)		315C270H01
NB, HNB, NC and HNC Breakers ^③		
1200	Short	505C606G04
1200	Medium	505C606G05
1200	Long	505C606G06
Mounting bracket (four required)		315C270H01

Notes

- ① Not UL Listed.
- ② Bus spacing 2.75 inches in box 5.75 inches deep (600V maximum).
- ③ Bus spacing 3.50 inches.

Plug-In Adapter Kits

For rear-connected applications such as switchboards. Facilitates ease of installation and front removal of breaker. Includes conductor for mounting on breaker, plug-in mounting blocks with matching conductor, rear studs and mounting hardware. Order two mounting blocks style number when line and load are required; order one mounting block style number when either line or load is required.

■ Shaded area denotes obsolete or discontinued products and services. ①

Flat Bus Type



Flat Bus Type

Description	Style Number
EB, EHB, FB Thermal-Magnetic Breakers ②	
Flat Bus Type—One Mounting Block, Line or Load	
Two-pole, 100A	1480D13G05
Two-pole, 150A	1480D13G05
Three-pole, 100A	1480D13G06
Three-pole, 150A	1480D13G06
FB and HFB Magnetic Only, HFB Thermal-Magnetic ②	
Flat Bus Type—One Mounting Block, Line or Load	
Two-pole, 100A	1480D13G05
Two-pole, 150A	1480D13G05
Three-pole, 100A	1480D13G06
Three-pole, 150A	1480D13G06
JB, KB, HKB Breakers ① Flat Bus Type—	
Two Mounting Blocks, Line and Load	
Two-pole	506C144G17
Three-pole	506C144G18
One Mounting Block, Line Only	
Two-pole	1260C86G01
Three-pole	1260C86G02
Two-pole	1260C86G03
Three-pole	1260C86G04
LAB, LA, HLA, LC and HLC (150, 250, 300 and 400A Frame) (Threaded Studs Type)—	
Two Mounting Blocks, Line and Load	
Two-pole	313C644G25
Three-pole	313C644G26
One Mounting Block, Line or Load	
Two-pole	450D010G15
Three-pole	450D010G16
DA, LB, LBB, HLB Breakers ② Flat Bus Type—	
Two Mounting Blocks, Line and Load	
Two-pole	313C644G45
Three-pole	313C644G46
One Mounting Block, Line or Load	
Two-pole	314C932G03
Three-pole	314C932G04
MA, HMA, MC, HMC, MD and MDS Breakers ③	
Threaded Studs—Two Mounting Blocks, Line and Load	
Two-pole, 125–600A	313C644G27
Two-pole, 700–800A	176C544G01 ③
Three-pole, 125–600A	313C644G28
Three-pole, 700–800A	176C544G02 ③
One Mounting Block, Line or Load	
Two-pole, 125–600A	313C370G03
Two-pole, 700–800A	507C049G01 ③
Three-pole, 125–600A	313C370G04
Three-pole, 700–800A	507C049G02 ③

Threaded Stud Type



Threaded Studs Type

Description	Style Number
JA, KA and HKA Breakers ④ (Threaded Studs Type)—Two Mounting Blocks, Line and Load	
Two-pole	313C644G29
Three-pole	313C644G30
One Mounting Block, Line or Load	
Two-pole	314C932G01
Three-pole	314C932G02
LA, HLA, LC and HLC (600A Frames) ② (Threaded Studs)—Two Mounting Blocks, Line and Load	
Two-pole	313C644G50
Three-pole	313C644G51
One Mounting Block, Line or Load	
Two-pole	506C059G03
Three-pole	506C059G04
One Mounting Block, Line or Load Flat Bus Type	
Two-pole	1288C19G01
Three-pole	1288C19G02
MA, HMA, MC, HMC, MD, MDS, NB, HNB, NC, HNC and NB TRI-PAC Breakers ④ (Flat Bus Type)—	
One Mounting Block, Line or Load	
MA, HMA, MC, HMC, MD, MDS two-pole	2614D53G05
MA, HMA, MC, HMC, MD, MDS three-pole	2614D53G06
NB, HNB, NC, HNC, NB TRI-PAC two-pole	2614D53G03
NB, HNB, NC, HNC, NB TRI-PAC three-pole	2614D53G04

Mounting Plates

Description	Style Number
Predrilled panels for:	
EB, EHB, FB, HFB	507C047H01
JB, KB	179C207H01
JA, KA	504C823H01
DA, LB, LBB, ALB	178C781H01
LA, LAB, HLA, LC, HLC	504C824H01
MA, HMA, MC, MMC, NB, HNB, NC, HNC	1290C73H01

Notes

- ① These accessories are no longer available.
- ② These plug-in adapter kits are UL Listed as recognized components.
- ③ 700–1200A adapter kit is front removable, bolt-on design—not plug-in type.
- ④ Not UL Listed.

Extended Line Terminal Shields

For shielding line side terminal connections. One shield required per breaker. Order separately when needed. Sold only in lots of 10, including hardware.

Line Terminal Shield



Extended Line Terminal Shields ①

Breaker Frame	Style Number
JB, KB, HKB	1266C07G01
MA, HMA, MC, HMC	208B966G01
NB, HNB, NC, HNC	208B966G02
LAB, LA, (Saf-T-Vue)	314C420G02
JA, KA, LB, LBB (Saf-T-Vue)	314C420G04
LAB, LA, HLA, LC, HLC	314C420G05
DA	314C420G06
JA, KA, HKA, LB, LBB, HLB (standard breaker)	314C420G06
EB, EHB, FB, HFB	625B229G08 ②

Base Mounting Hardware

No charge when ordered with breaker. Order separately when needed.

Line Terminal Shield



Base Mounting Hardware

Description	Style Number
Single-Pole Breakers	
EB, EHB, HFB ③	624B375G01
EB, EHB, HFB ④	624B375G02
Two- and Three-Pole Breakers	
LAB, LA, HLA, LC, HLC, MA, NB, HMA, HNB, MC	21C6782G05
HMC, NC, HNC	1091716
PB, PC, PCC	624B375G22
DA, JA, KA, HKA, LB, LBB, HLB	21C6782G22
EB, EHB, FB, HFB, MCP	21C6782G18
JB, KB, HKB	673B125G12
CA two-pole	21C6782G28
CA three-pole	21C6782G29

Fuse Mounting Base for PB Breakers

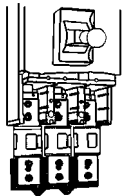

For 2000A non-automatic breakers only.

Fuse Mounting Base for PB Breakers

Style Number

6635C78G02 ①

For use with non-automatic, three-pole circuit breaker. Includes fuse mounting base and hardware to mount standard Class L current limiting fuses, 801–2000A (fuses not included).

Note: Interrupters used with fuse mounting base will accept all standard PB accessories. See Dimension Sheet 29-171 for mounting details.

For complete installation, order:

1. Front-connected, non-automatic PB breaker. (Order similar to standard front connected, except omit load conductor extensions.)
2. Fuse mounting base.
3. Fuses (from distributor).

Handle Locks

Non-Padlockable

For prevention of unintentional operation of breaker. Fits over breaker handle and may be removed.

Padlockable

For prevention of unauthorized operation of breaker. Is non-removable once installed on breaker. Meets Underwriters Laboratories and California Code requirements.

Handle Locks



Handle Locks ①⑤

Breaker Frame	Style Number
Non-Padlockable	
FA, EA, CA, EB, EHB, FB, HFB	29B2721H01
LAB, LA, LC, HLC, MA, NB, HLA, HMA, HNB, MC, HMC, NC, HNC	28B4596G01
GB, GC, GHB, GHC	1294C01H01
DA, JA, KA, HKA, LB, LBB, HLB	29B2721H04
Padlockable	
CA	506C438G01
FA, EA, EB, EHB, FB, HFB, MCP150	765A754G01
DA, JA, KA, LB, LBB, HKA, HLB, MCP400	673B796G02
JB, KB, HKB, MCP250	673B796G01
LAB, LA, HLA, LC, HLC	373B591G02
MA, HMA, MC, HMC, MD, MDS	6591C30G02–OFF
MA, HMA, MC, HMC, MD, MDS	6591C30G05–ON/OFF
NB, HNB, NC, HNC	6591C30G01–OFF
NB, HNB, NC, HNC	6591C30G04–ON/OFF
PA, SPCB, PB, Tri-Pac PB, PC	6591C30G03–OFF

Notes

- ① Not UL Listed.
- ② One of style 625B229G08 is one package of 10.
- ③ Individually mounted.
- ④ Group mounted.
- ⑤ All breakers are trip free and will trip with handle locks attached. Cannot be used when handle extension is used.

Cable Connectors

The fuse mounting base will accept the following terminals for front cable connection (omit "T" connectors from rear connected breakers).

Cable Connectors

Wire Range, Type Number of Cables	Style Number
(3) 3/0–400 kcmil Cu	672B655G01
(4) 400–500 kcmil Cu	180C046G03

Molded Type Handle Extension

For LAB, LA and HLA Breakers ①

Style Number

372B399G01

For MA, HMA, MC, HMC, NB, HNB, NC and HNC Breakers ①

Style Number

1251C65G01 ②

For PB, PC, PCC and PA/RD Breakers ①

Style Number

6635C78G02 ②

Modifications

Only two internally mounted modifications—shunt trip, undervoltage release, auxiliary switch, alarm switch—may be mounted in EB through PB. Only one of these modifications may be mounted in FB, HFB magnetic only, two-pole EB, EHB, FB and SELTRONIC breakers. None are available in single-pole breakers except alarm switch in EB, EHB and HFB. Contact Avery Creek, NC, Technical Resource Center for possible special combinations of the following modifications not in tabulations. Contact factory for pricing if accessories are factory installed.

Shunt Trip

For tripping breaker from a remote point. A solenoid device mounts within breaker case. Breaker trips when coil is energized.

Shunt trips should not be used as circuit interlocks using maintained contact pilot devices.

A cutoff switch breaks the circuit to the momentary rated coil when the breaker opens. Available for control voltages up to 250 Vdc or 600 Vac. Voltage and frequency must be specified. Standard leads extend 18.00 inches outside the breaker. Longer leads may be specified.

Factory-Mounted Shunt Trips

Factory-mounted shunt trips only can be supplied for the following breakers: CA, HCA, CAH, HFB magnetic only and PB/PBF non-automatic breakers (molded-case switches). They are 120 Vac rated, suitable for 55% pickup for ground fault application. Right hand mounting is standard and they are not UL Listed.

Notes

- ① Not UL listed.
- ② Included with frame at no charge.

Shaded area denotes obsolete or discontinued products and services. ④

Shunt Trip



Shunt Trip for Field Mounting ①②③

Voltage/Hz	Breaker Type Catalog Number						
	EB, EHB, FB, HFB ⑤ (Thermal-Magnetic Only)	JB, KB, HKB	JA, KA, HKA, DA, LB, LBB, HLB	LA, LAB, HLA	MA, HMA	NB, HNB	PB TRI-PAC and PA
Right-Hand Mounting							
600/50–60 Hz	2609D39G15	2609D42G15	2605D15G15	2606D56G15	2606D57G15	2606D58G15	2606D59G15
480/50–60 Hz	2609D39G16	2609D42G16	2605D15G16	2606D56G16	2606D57G16	2606D58G16	2606D59G16
240/50–60 Hz	2609D39G17	2609D42G17	2605D15G17	2606D56G17	2606D57G17	2606D58G17	2606D59G17
208/50–60 Hz	2609D39G18	2609D42G18	2605D15G18	2606D56G18	2606D57G18	2606D58G18	2606D59G18
120/50–60 Hz	2609D39G19	2609D42G19	2605D15G19	2606D56G19	2606D57G19	2606D58G19	2606D59G19
60/50–60 Hz	2609D39G20	2609D42G20	2605D15G20	2606D56G20	2606D57G20	2606D58G20	2606D59G20
48/50–60 Hz	2609D39G21	2609D42G21	2605D15G21	2606D56G21	2606D57G21	2606D58G21	2606D59G21
24/50–60 Hz	2609D39G22	2609D42G22	2605D15G22	2606D56G22	2606D57G22	2606D58G22	2606D59G22
250 DC	2609D39G23	2609D42G23	2605D15G23	2606D56G23	2606D57G23	2606D58G23	2606D59G23
125 DC	2609D39G24	2609D42G24	2605D15G24	2606D56G24	2606D57G24	2606D58G24	2606D59G24
60 DC	2609D39G25	2609D42G25	2605D15G25	2606D56G25	2606D57G25	2606D58G25	2606D59G25
48 DC	2609D39G26	2609D42G26	2605D15G26	2606D56G26	2606D57G26	2606D58G26	2606D59G26
24 DC	2609D39G27	2609D42G27	2605D15G27	2606D56G27	2606D57G27	2606D58G27	2606D59G27
12 DC	2609D39G28	2609D42G28	2605D15G28	2606D56G28	2606D57G28	2606D58G28	2606D59G28
Left-Hand Mounting							
600/50–60 Hz	2609D39G01	2609D42G01	2605D15G01	2606D56G01	2606D57G01	2606D58G01	2606D59G01
480/50–60 Hz	2609D39G02	2609D42G02	2605D15G02	2606D56G02	2606D57G02	2606D58G02	2606D59G02
240/50–60 Hz	2609D39G03	2609D42G03	2605D15G03	2606D56G03	2606D57G03	2606D58G03	2606D59G03
208/50–60 Hz	2609D39G04	2609D42G04	2605D15G04	2606D56G04	2606D57G04	2606D58G04	2606D59G04
120/50–60 Hz	2609D39G05	2609D42G05	2605D15G05	2606D56G05	2606D57G05	2606D58G05	2606D59G05
60/50–60 Hz	2609D39G06	2609D42G06	2605D15G06	2606D56G06	2606D57G06	2606D58G06	2606D59G06
48/50–60 Hz	2609D39G07	2609D42G07	2605D15G07	2606D56G07	2606D57G07	2606D58G07	2606D59G07
24/50–60 Hz	2609D39G08	2609D42G08	2605D15G08	2606D56G08	2606D57G08	2606D58G08	2606D59G08
250 DC	2609D39G09	2609D42G09	2605D15G09	2606D56G09	2606D57G09	2606D58G09	2606D59G09
125 DC	2609D39G10	2609D42G10	2605D15G10	2606D56G10	2606D57G10	2606D58G10	2606D59G10
60 DC	2609D39G11	2609D42G11	2605D15G11	2606D56G11	2606D57G11	2606D58G11	2606D59G11
48 DC	2609D39G12	2609D42G12	2605D15G12	2606D56G12	2606D57G12	2606D58G12	2606D59G12
24 DC	2609D39G13	2609D42G13	2605D15G13	2606D56G13	2606D57G13	2606D58G13	2606D59G13
12 DC	2609D39G14	2609D42G14	2605D15G14	2606D56G14	2606D57G14	2606D58G14	2606D59G14

Notes

- ① 120 Vac ratings suitable for 55% pickup for ground fault applications.
- ② Not field mountable on non-automatic breakers (molded-case switches).
- ③ Field mounting voids breakers' UL listing except on LA, HLA, MA, HMA, NB, HNB, PB, KB, HKB, KA, HKA, LB, HLB and SELTRONIC breakers.
- ④ These frames are obsolete. For replacement solutions, see the cross-reference on **Pages V12-T3-114–V12-T3-168**.
- ⑤ Available similar to this except "Leads out the load end—(not UL Listed)." Order by description.

Left-Hand Mounting Kits for SELTRONIC Breakers

Left-Hand Mounting Kits for SELTRONIC Breakers

Description	Breaker Type	Style Number
Provision to trip flux transfer shunt trip from external 32 to 120 Vdc and Vac to 60 Hz source ^{①②}	MC, HMC	1371D72G22
	NC, HNC	1372D39G13
	PC, PCC	1372D35G22
	LC, HLC	1371D11G22
Provision to trip flux transfer shunt trip from external 240 to 600 Vac, 50/60 Hz source ^{②③}	MC, HMC	1371D72G32
	NC, HNC	1372D39G23
	PC, PCC	1372D35G32
	LC, HLC	1371D11G32

Shunt Trip Coil Data

Shunt Trip Voltage Rating	For All Breakers Listed in Previous Table and on Previous Page Except CA and SELTRONIC Coil Inrush		SELTRONIC Coil Inrush	
	Amperes	Volt-Amperes	Amperes	Volt-Amperes
600 AC	0.105	63.0	—	—
480 AC	0.085	40.8	—	—
240 AC	1.7	408.0	—	—
208 AC	1.4	291.2	—	—
120 AC	0.88	105.6	15	18
60 AC	9.10	546.0	—	—
48 AC	7.50	360.0	—	—
24 AC	3.95	94.8	—	—
250 DC	2.5	625.0	—	—
125 DC	0.975	121.9	—	—
60 DC	0.525	31.5	—	—
48 DC	1.3	62.4	—	—
24 DC (FB)	6	144.0	—	—
24 DC (KB)	3.8	91.2	—	—
24 DC (others)	8	192	—	—
12 DC	6	72	—	—

Notes

- ① Rated 48V minimum for ground fault applications.
- ② Also available for 24 Vdc. Order by description.
- ③ Not for ground fault.

Standard Undervoltage Release

For undervoltage protection. A solenoid device mounts within a breaker case. Coil must be energized before closing breaker. Trips breaker when voltage drops below 35 to 70% of coil rating. Picks up and seals in at 85% of coil rating. For line voltages up to 250 Vdc or 600 Vac. Externally mounted resistors are supplied for certain ratings. Standard leads extend 18.00 inches outside of breaker. Longer leads may be specified.

Note: Undervoltage release attachments are not designed for, and should not be used as, circuit interlocks. For further information, Contact Avery Creek, NC, Technical Resource Center at **1-800-356-1243**.

Factory-Mounted Undervoltage Releases

All of the above undervoltage releases can be specified for factory mounting. Contact factory for pricing. These attachments have the leads out the side and are UL Listed when factory mounted unless other non-UL Listed modifications are used.

Note: Right-hand mounting is considered standard unless specified otherwise except JA, KA, DA, HKA, LB, LBB, HLB and SELTRONIC available for left-hand only. JB, KB, HKB are obsolete.

Factory-mounted undervoltage releases only can be supplied for the following breakers:

- SELTRONIC breakers (120 Vac, 60 Hz only standard), MC, HMC, NC, HNC, PC, PCC, LC, HLC
- SELTRONIC breakers with remote trip provisions, MC, HMC ②, NC, HNC ②, PC, PCC ②, LC, HLC ②
- EB ③, EHB ③, FB ③, HFB ③, FB ④⑤ and HFB magnetic only ④⑤
- No UVR available for CA, CAH and HCA

Standard Undervoltage Release

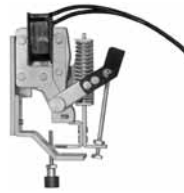

Undervoltage Release Attachment Kits for Field Mounting ⑥⑦

Attachment Voltage, Hz	Breaker Type				
	JA, KA, DA, HKA, LB, LBB, HLB	LA, LAB, HLA	MA, HMA	NB, HNB	PB, PA ④
For Right-Hand Mounting					
24, 60	—	60A9355G17	—	—	—
48, 60	—	60A9355G08	—	—	5674D29G16
120, 60	—	60A9355G01	457D727G01	373D632G01	5674D29G09
208, 60	—	60A9355G02	457D727G19	373D632G19	5674D29G10
240, 60	—	60A9355G03	457D727G02	373D632G02	5674D29G11
480, 60	—	60A9355G05	457D727G03	373D632G03	5674D29G13
600, 60	—	60A9355G06	457D727G04	373D632G04	5674D29G14
12 DC	—	458D020G01	457D727G09	372D032G01	4976D85G01
24 DC	—	458D020G02	457D727G10	372D032G02	4976D85G02
48 DC	—	458D020G03	457D727G11	372D032G03	4976D85G03
60 DC	—	458D020G04	457D727G21	—	4976D85G04
125 DC	—	458D020G07	457D727G12	372D032G04	4976D85G07
250 DC	—	458D020G08	457D727G13	372D032G05	4976D85G08
For Left-Hand Mounting					
48, 60	—	60A9355G16	—	—	5674D29G08
120, 60	458D070G01	60A9355G09	457D727G05	373D632G05	5674D29G01
208, 60	458D070G05	60A9355G10	457D727G20	373D632G20	5674D29G02
240, 60	458D070G02	60A9355G11	457D727G06	373D632G06	5674D29G03
480, 60	458D070G03	60A9355G13	457D727G07	373D632G07	5674D29G05
600, 60	458D070G04	60A9355G14	457D727G08	373D632G08	5674D29G06
12 DC	458D070G09	458D020G11	457D727G14	372D032G06	4976D85G11
24 DC	458D070G10	458D020G12	457D727G15	372D032G07	4976D85G12
48 DC	458D070G11	458D020G13	457D727G16	372D032G08	4976D85G13
60 DC	—	458D020G14	457D727G22	—	4976D85G14
125 DC	458D070G12	458D020G17	457D727G17	372D032G09	4976D85G17
250 DC	458D070G13	458D020G18	457D727G18	372D032G10	4976D85G18

Notes

- ① Cannot be used with other attachments except a small 1A-1B auxiliary switch rated 250V can be supplied in right-hand pole.
- ② Provided with two leads (total of four) for use with a remote normally open contact (pushbutton, etc.) to trip the breaker. No external power required.
- ③ Not available on ambient compensating breakers.
- ④ Not UL Listed.
- ⑤ Right-hand mounting only.
- ⑥ Not field mountable on non-automatic breakers (molded-case switches).
- ⑦ Field mounting voids UL listing of breaker except on LA, HLA, MA, HMA, NB, HNB, PB, KA, HKA, LB and HLB.

Undervoltage Release Coil Data

Voltage Rating Hz	Breaker Type			JA, KA, HKA, DA, LB, LBB and HLB			LA, LAB, HLA and PB		
	EB, EHB, FB, HFB, JB, KB and HKB			Coil Amperes	External Series Resistance (Ohms)	Total VA	Coil Amperes	External Series Resistance (Ohms)	Total VA
600 AC	0.020	25,000	12.0	0.012	50,000	7.2	0.029	20,000	17.4
480 AC	0.016	20,000	7.7	0.013	30,000	6.3	0.014	—	6.8
240 AC	0.021	6000	5.1	0.013	—	3.2	0.036	—	8.7
208 AC	0.019	6000	4.0	0.018	—	3.8	0.036	—	7.5
120 AC	0.023	—	2.8	0.023	—	2.8	0.073	—	8.8
60 AC	0.203	250	12.2	—	—	—	—	—	—
48 AC	0.245	150	11.8	—	—	—	0.152	—	7.3
24 AC	0.250	50	6.0	—	—	—	—	—	—
250 DC	0.026	5000	6.5	0.013	16,500	3.3	0.035	5000	8.8
125 DC	0.026	—	3.3	0.013	6500	1.7	0.039	1500	4.9
60 DC	0.248	200	14.9	0.013	1500	0.8	0.034	—	2.1
48 DC	0.260	150	12.5	0.012	600	0.6	0.040	—	2.0
24 DC	0.141	—	3.4	0.023	—	0.6	0.069	—	1.7
12 DC	0.286	—	3.5	0.048	—	0.6	0.136	—	1.7
	MA and HMA			NB and HNB			MC, HMC, NC, HNC, PC, PCC, LC and HLC		
	Coil Amperes	External Series Resistance (Ohms)	Total VA	Coil Amperes	External Series Resistance (Ohms)	Total VA	Coil Amperes	External Series Resistance (Ohms)	Total VA
600 AC	0.012	50,000	7.2	0.016	35,000	9.6	—	—	—
480 AC	0.013	30,000	6.3	0.013	30,000	6.3	—	—	—
240 AC	0.013	—	3.2	0.013	—	3.2	—	—	—
208 AC	0.018	—	3.8	0.018	—	3.8	—	—	—
120 AC	0.023	—	2.8	0.023	—	2.8	0.5	—	6
60 AC	—	—	—	—	—	—	—	—	—
48 AC	—	—	—	—	—	—	—	—	—
24 AC	—	—	—	—	—	—	—	—	—
250 DC	0.013	16,500	3.3	0.013	16,500	3.3	—	—	—
125 DC	0.013	6500	1.7	0.013	6500	1.7	—	—	—
60 DC	0.013	1500	0.8	—	—	—	—	—	—
48 DC	0.012	600	0.6	0.012	600	0.6	—	—	—
24 DC	0.02	—	0.6	0.023	—	0.6	—	—	—
12 DC	0.048	—	0.6	0.048	—	0.6	—	—	—

Alarm Switch

Availability: EB through PC. For light or alarm indication when breaker trips. Does not function with manual operation. Automatically resets when breaker is relatched. Standard leads extend 18.00 inches outside of breaker. Longer leads may be specified. Not field mountable.

Alarm Switch Contact Rating (Non-Inductive)

- MC, HMC, LA, LAB, HLA, LC, HLC: 10A, 120 Vac; 5A, 240 Vac
- EB, EHB, FB, HFB: 5A, 120 Vac
- All other breakers: 10A, 120–240 Vac

Auxiliary Switch

For auxiliary control circuits. Miniature switches mount within breaker. Commonly used for remote indication of open or closed breaker and electrically interlocking component control circuits. "A" contacts are closed when breaker is closed. "B" contacts are open when breaker is closed. Standard leads extend 18.00 inches outside of breaker. Longer leads may be specified.

Note: Right-hand mounting standard for EB, EHB, FB, HFB, JB, KB and HKB. All others are left-hand mounting as standard unless otherwise specified.

Factory-Mounted Auxiliary Switches

All of the above auxiliary switches can be specified for factory mounting at the same price as listed for the kit. These attachments have the leads out the side of the breaker and are UL Listed when factory mounted unless other non-UL Listed modifications are used (except as noted).

Note: Right-hand mounting standard for EB, EHB, FB, HFB, JB, KB and HKB. All others are left-hand mounting as standard unless otherwise specified.

Factory-mounted switches only can be supplied for the following breaker:

- JB, LBB, LAB, JA, DA, FB[Ⓜ] magnetic only[Ⓜ] and HFB magnetic only[Ⓜ]

Switch Schematic

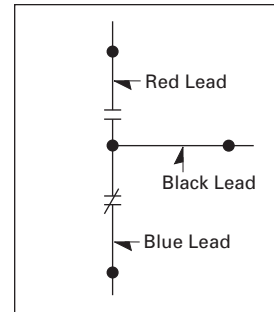

Switch with 2A-2B Contacts



Alarm Switch

Breaker Frame	Normal Pole Mounting	Contact Operation (Specify Type Desired)
DA ^①	Left	Make or break
EB ^① , EHB ^① , FB ^① , HFB ^{Ⓜ②③}	Mechanism	Make or break
JA ^① , KA ^① , LB ^① , LBB ^① , HKA, HLB	Left	Make or break
JB ^① , KB ^① , HKB ^①	Left	Make or break
LAB ^① , LA ^① , MA ^① , NB ^① , HLA, HMA, HNB	Left	Make or break
LC ^① , HLC	Left ^④	Make or break
MC ^① , HMC	Left only ^④	Make or break
NC ^① , HNC	Left only ^④	Make or break
PB	Left	Make or break
PC, PCC	Left ^{④⑤}	Make or break

Shaded area denotes obsolete or discontinued products and services. [Ⓜ]

Auxiliary Switch Attachment Kits for Field Mounting ^{Ⓜ②③}

Breaker Type	Maximum AC Voltage Rating [Ⓜ]	Non-inductive Amperes	For Left-Hand Mounting		For Right-Hand Mounting	
			1A-1B	2A-2B	1A-1B	2A-2B
EB, EHB, FB, HFB [Ⓜ]	240	5	4979D06G03	4979D06G09	4979D06G03	4979D06G08
JA, KA, DA, HKA, LB	480	10	458D067G03	—	458D067G08	—
LBB, HLB	240	5	—	656D527G01 ^②	—	656D527G09 ^②
JB, KB, HKB	480	10	2600D97G03	—	2600D97G08	—
JB, KB, HKB	240	5	—	2609D45G03 [Ⓜ]	—	2609D45G08 [Ⓜ]
LA, LAB, HLA	480	10	655D555G12	655D555G13	655D555G05	655D555G06
MA, HMA	480	10	458D013G12	458D013G13	458D013G05	458D013G06
NB, HNB	480	10	4980D16G12	4980D16G13	4980D16G05	4980D16G06
PB, PA	480	10	2602D32G11	2602D32G12	2602D32G14	2602D32G15
MC, HMC, MCG, HMCG	480	6 (10 at 24)	1371D72G03	1371D72G06	—	—
NC, HNC, NCG, HNCG	480	6 (10 at 24)	1372D39G03	1372D39G06	—	—
PC, PCC, PCG, PCCG	480	6 (10 at 24)	1372D35G03	1372D35G06	—	—
LC, HLC, LCG, HLCG	480	6 (10 at 24)	1371D11G03	1371D11G06	—	—

Notes

- ① Alarm switches are no longer available for these frames.
- ② Not UL Listed.
- ③ Not available for magnetic only, ambient compensating, or breakers with undervoltage release.
- ④ When alarm switch is used in conjunction with auxiliary switch, the auxiliary switch is rated 250 Vac, 5A maximum.

- ⑤ Except when other attachments are used, must be mounted in right pole.
- ⑥ Not for use on molded-case switches.
- ⑦ All switches are multiples of 1A-1B with a common electrical connection (see diagram above right).
- ⑧ Field mounting voids UL listing of breaker except on LA, HLA, MA, HMA, NB, HNB, KB, HKB, KA, HKA, LB, HLB and SELTRONIC breakers.

- ⑨ These accessories are no longer available.
- ⑩ For DC applications, refer to factory.
- ⑪ Thermal-magnetic only.
- ⑫ Auxiliary switches are no longer available for these frames.
- ⑬ Right-hand mounting only.

Shaded area denotes obsolete or discontinued products and services.

Moisture-Fungus-Corrosion Treatment

Availability: EB through PC.

Treatment can be provided to meet customer's specific atmospheric conditions. Moisture-fungus treating material used meets JAN-T-152; treatment meets MIL-V-173a. Requests and orders should specify government specifications or conditions to be met.

Note: Not UL Listed.

Mechanical Interlocks (A-C)

For mechanically interlocking a pair of breakers so that only one may be closed at one time, but both may be open simultaneously.

Note: Not UL Listed.

A. Walking Beam Type



Walking Beam

Availability: EB through PC.

Mounts on panel (not included) at rear of breaker. Standard breaker spacing: center to center; LAB, LA, LC, HLC, MA, MC, NB, NC, HLA, HMA, HMC, HNB and HNC 8.50-inch center to center; PB, PC and PCC 12.25-inch center to center; DA, JA, KA, HKA, LB, LBB and HLB 5.75 inch center to center; EB, EHB, FB, JB, KB, HFB and HKB 4.375 inch center to center. Order as a set of two special factory drilled breakers and one walking beam interlock. Specify breaker type, panel thickness and center to center dimension of breakers.

Note: Not UL Listed. 2000A maximum for PB breaker. Not available on drawout breakers.

B. Sliding Bar Type (Field Mountable)



Sliding Bar Type

Availability: HFB through PC.

Mounts on panel (not included) fitting over front of breakers. Standard breaker spacing: HLC, HLA, HMA, HMC, HNB and HNC 8.50-inch center to center; HKA and HLB 5.75-inch center to center; HFB 4.1875-inch center to center.

C. Kirk Key Interlock



Kirk Key Interlock

Availability: EB through PC.

Permits interlocking of two breakers or one breaker with other devices. Before breaker can be closed, key must be inserted and turned in breaker interlock. Breaker must be opened before key can be removed. It can then be inserted in interlock or other devices to permit their closure. Requests and orders should completely outline interlocking scheme, ultimate user and address.

Note: Not available on motor operated breakers. (No CA, LCL, FCL breakers.)

Center Studs



Center Studs

Availability: 600A frames (LA) through (NB) 1200A frames except SELTRONIC and current limiting breakers.

Provides connections for dual voltage generators, so that same trip unit can be used for protection at both voltages. At higher voltage, the trip unit carries full load current. At lower voltage, half the current bypasses the trip unit through the center studs. Trip rating cannot exceed 50% of frame rating.

Field Discharge Switch

Availability: 400, 600A frame (LA).

Breaker is used exclusively to discharge the field of a DC motor or generator, usually through a resistor. When the two outer poles open, the center pole closes.

Note: Not UL Listed.

Motor Operators

Motor operators provide complete remote control by means of a pushbutton or a similar pilot device.

Note: The pilot device must be maintained contact type for EB, EHB, FB, HFB, DA, JA, KA, JB, KB, HKB and LB mechanisms, momentary contact type for all others.

Positive switching action is accomplished by use of an operating arm engaging the breaker handle. The unit is energized momentarily to actuate the lever arm moving it to either the ON or OFF position. The control is broken by an internal cutoff switch. Means for emergency manual operations is provided.

Motor operations are available with motors rated 120 Vac, 208 Vac and 240 Vac.

Note: LA and larger available for 125 Vdc.

The 480V operators use a 120 Vac motor in conjunction with a 480/240V to 120V dual voltage transformer. (On LA and larger operators, the transformer is supplied for separate mounting by the customer.)

Note: The motor operator is intended only for infrequent operation in line with Underwriters Laboratories endurance standards for molded-case breakers. Minimum 1 kVA transformer is required for use with all motor operations.

Back Mounting Plates

Breaker Type	120, 208, 240, 480 Vac Style Number
EB, EHB, FB, HFB	503C707G01
DA, JA, KA, LB, HLB	503C981G01



For LAB, LA, HLA Breakers



For MA, HMA, NB, HNB Breakers



For PB Breakers

For EB, EHB, FB and HFB



Motor Operator Selection ^{①②}

Breaker Type	Style Number—AC Voltage				Style Number—DC Voltage	
	120	208	240	480	125	24
EB, EHB, FB, HFB	656D148G11	656D148G04	656D148G02	656D148G13	—	—
DA, JA, KA, HKA	657D819G23	657D819G10	657D819G08	657D819G24	—	—
LB, LBB, HLB	657D819G25	657D819G16	657D819G14	657D819G26	—	—
LAB, LA, HLA, LC, HLC	2607D97G37	2607D97G40	2607D97G38	2607D97G39	2607D97G51	2607D97G42
MA, HMA, MC, HMC	5664D54G75	5664D54G78	5664D54G76	5664D54G77	5664D54G96	5664D54G81
NB, HNB, NC, HNC, SPCB1200	1494D60G31	1494D60G32	1494D60G33	1494D60G34	1494D60G35	1494D60G36
PB, PC, PCC, PA, SPCB2000	5661D52G01	5661D52G04	5661D52G02	5661D52G03	5661D52G17	—

For DA, JA, KA, JB, LB, LBB, HKA, HKB and HLB Breakers



Motor Data

Breaker Type	Motor Type	Hp	Inrush Current, Ampere (Peak)			Continuous Current (rms)			Operating Time, Open or Close
			120V	208V	240V	120V	208V	240V	
EB, EHB, FB, HFB	Split-phase	1/75	10	4	5	2.3	1.17	1.65	1.5 seconds
DA, JA, KA, JB, KB, LB, LBB, HKB, HLB	Split-phase	1/50	14	6	7	3.5	1.6	1.75	1.5 seconds
LAB, LA, HLA	Reversing	—	8	5	4	—	—	—	12 cycles
MA, HMA, NB, HNB, SPCB1200	Reversing	—	11	7	6	—	—	—	12 cycles
PB, PA, SPCB2000	Reversing	—	20	12	11	—	—	—	10 cycles

Notes

- ① AC voltage rated operators are UL Listed as recognized components.
- ② See Dimension Sheet 29-170.

Drawout Frame

These drawout frames are for use with standard three-pole Cutler-Hammer molded-case circuit breakers. They consist of two separate parts: stationary mounting frame and movable carrier frame. Slide rails are drawer-type, and a screw mechanism is used to engage or withdraw the movable carrier frame.

The drawout frames have three positions: connected, test and disconnected. The frames do not include a safety tripping interlock or secondary contacts. These are optional items and may be ordered at additional cost.

Breakers mounted in the drawout frames can be equipped with standard breaker accessories including shunt trip, undervoltage release, auxiliary switch, alarm switch and motor operator.

Optional Features

Safety Interlock

This feature trips the breaker as the movable carrier frame is withdrawn, and must be factory installed. Order as follows.

Note: Safety interlock not available on MC, NC, HMC, HNC, LC and HLC.

For LA, MA and NB Breakers

Order standard stationary mounting frame. Order breaker and movable carrier frame assembled with safety interlock.

Secondary Contacts

These are used to disconnect auxiliary circuits when attachments such as shunt trip or motor operator are used. Available in multiples of four contacts with a maximum of 24 contacts for the LA 600 or 32 contacts for the MA and NB. They must be factory mounted. Order by description as similar to stationary or moving frame and specify number of contacts required.

Drawout Frame



Selection Data ^{①②}

Breaker Type	Stationary Mounting Frame Style Number	Movable Carrier Frame Style Number
HLA600, HLC600, LA600, LD, HLD ^③	2603D84G01	2608D35G06
HMA, HMC, MDL, HMDL ^③	2603D85G01	2608D34G10
HNB, HNC, ND, HND ^③	2603D85G01	2608D34G08
PB, PC, PCC 2000A ^④	2601D18G04	Order by description ^⑤
PB 2500A, PC, PCC 2500A and 3000A ^④	2601D18G05	Order by description ^⑤

Ordering Information

Note: SELTRONIC circuit breakers with built-in ground fault require a special breaker frame with leads out the side in place of standard terminal block. Order by description the breaker frame and carrier as one assembly.

Standard Installation

Order one stationary mounting frame and one movable carrier frame.

Order breakers without terminals or rear connectors.

Order any attachments desired (shunt trip, undervoltage release, etc.)

Order secondary contacts as required:

- A shunt trip, an undervoltage release or an alarm switch requires two contacts
- A 1A-1B auxiliary switch requires three contacts
- A motor operator requires a maximum of four contacts
- Others as required

With Safety Interlock

Order stationary mounting frame and movable carrier frame as directed under optional features.

Racking Crank

A special crank to engage or withdraw the moving portion of the drawout. A standard 0.50-inch hex socket with extension can be used for this purpose.

Racking Crank

Style Number

765A767G01

Cell Switches Mounted on Drawout Frames, All Ratings

Up to four switches can be provided. Order by description.

Each switch provides NO and NC contact that transfers before reaching the test position when being withdrawn, and after the test position when being racked in. Contact factory for pricing.

Notes

- ① Safety interlock not available on MC, NC, HMC, HNC, LC and HLC.
- ② SELTRONIC circuit breakers with built-in ground fault require a special breaker frame with leads out the side in place of standard terminal block. Order by description the breaker frame and carrier as one assembly.
- ③ These units are UL Listed.
- ④ Not UL Listed.
- ⑤ Factory installed only.

Panelboard “Only” Replacement Breaker Selection Guide

Panelboard “Only” replacement breakers are generally for use as replacement for out-of-production panelboard branch circuit breakers where both physical and electrical interchangeability is required. Where possible, consideration should be given to application of either current Series C or Series G circuit breakers.

For additional information, consult the charts on **Pages V12-T3-84 and V12-T3-85** or contact your local Eaton Field Sales office or the Breaker Service Centers.

Replacement Chart ①

Current Panelboard Circuit Breaker Type	Out-of-Production Circuit Breaker Type	Vac (50/60 Hz)		
		240	480	600
REA ①	EA ①	■		
RE	E ①	■		
REH	EH ①		■	
RFA ①	FA ①			■
RHFA	HFA ①			■
RF ①	F ①			■
RHF	HF ①			■
RJ	J ②			■
RK ①	K ②			■
RHK	HK ②			■
RKL ①	KL ②			■
RHKL	HKL ②			■
RLM ①	LM ②			■
RHLM	HLM ②			■
HLA	JK ②			■
HLA ①	JKL ②			■

■ Shaded area denotes obsolete or discontinued products and services. ③

Panelboard “Only” Replacement Breaker Selection Guide

Breaker Type	Amperes	Panelboard Replacement Breaker Interrupting Ampere Rating												
		120 Vac		240 Vac		277 (Single-Pole)		480 Vac		600 Vac		125 (Single-Pole)		250 Vdc
		Sym.	Asym.	Sym.	Asym.	Sym.	Asym.	Sym.	Asym.	Sym.	Asym.	Sym.	Asym.	
RE	15–20	—	—	—	—	10,000	10,000	—	—	—	—	—	—	—
RE	15–100	7500	7500	7500	7500	—	—	—	—	—	—	5000	5000	5000
REA	15–20	—	—	—	—	10,000	10,000	—	—	—	—	—	—	—
REA	15–100	7500	7500	7500	7500	—	—	—	—	—	—	5000	5000	5000
REH	15–100	—	—	18,000	20,000	10,000	10,000	14,000	15,000	—	—	—	—	10,000
RF	15–100	—	—	18,000	20,000	—	—	14,000	15,000	14,000	15,000	—	—	10,000
RFA	15–150	—	—	18,000	20,000	—	—	14,000	15,000	14,000	15,000	—	—	10,000
RHF	15–100	—	—	65,000	75,000	—	—	25,000	30,000	18,000	20,000	—	—	20,000
RHFA	15–100	—	—	65,000	75,000	—	—	25,000	30,000	18,000	20,000	—	—	20,000
RJ	70–225	—	—	22,000	25,000	—	—	18,000	20,000	14,000	15,000	—	—	10,000
HLA	70–225	—	—	42,000	50,000	—	—	30,000	35,000	22,000	25,000	—	—	20,000
HLA	125–400	—	—	42,000	50,000	—	—	30,000	35,000	22,000	25,000	—	—	20,000
RK	70–225	—	—	42,000	50,000	—	—	22,000	25,000	22,000	25,000	—	—	10,000
RKL	125–400	—	—	42,000	50,000	—	—	30,000	35,000	22,000	25,000	—	—	20,000
RLM	125–800	—	—	42,000	50,000	—	—	30,000	35,000	22,000	25,000	—	—	20,000
RHK	70–225	—	—	65,000	75,000	—	—	35,000	40,000	25,000	30,000	—	—	20,000
RHKL	125–400	—	—	65,000	75,000	—	—	35,000	40,000	25,000	30,000	—	—	20,000
RHLM	125–800	—	—	65,000	75,000	—	—	35,000	40,000	25,000	30,000	—	—	20,000

Replacement of all out-of-production panelboard circuit breakers are designated by the easily identifiable addition of an “R” prefix to the out-of-production circuit breaker catalog number that they replace.

An Example:

RHF3100 is a newly manufactured, three-pole, 100A trip panelboard replacement breaker for an out-of-production **HF3100**.

R Designates new panelboard “only” replacement breaker.

HF Identifies the out-of-production circuit breaker frame.

3 Number of poles.

100 Trip ampere rating.

Notes:







- Panelboard “only” replacement circuit breakers have non-interchangeable trip units and the same interrupting capacity as the out-of-production circuit breakers that they replace.
- The RE breaker has off-center terminals just like the E breaker it is replacing.
- For out-of-production breakers, the “B” suffix denotes 277 Vac rating for the panelboard replacement breaker. (Example: RE3020B)
- Some panelboard “only” replacement breakers do not have the same physical dimensions or mounting holes as the breakers that they replace. For example, the types REH and RHFA are 6.00 inches in length and the breakers that they replace, EH and HFA, are 6.50 inches in length.
- Panelboard “only” replacement breakers can be installed in the following styles of out-of-production Westinghouse panelboards:

6. ABH	NEB
A2B	NHDP
NHEB	NH1B
NA1B	NLAB-AB
NA1B-LX	NLAB-ABH
NDP	

Notes

- Last manufacture date—1974.
- Last manufacture date—1967.
- These frames are obsolete. For replacement solutions, see the cross-reference on **Pages V12-T3-114–V12-T3-167** or call 803-481-6843 for other panelboard solutions.

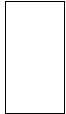
Panelboard “Only” Replacement Circuit Breaker Guide—Dimensions in Inches (Per Three-Pole Breaker)

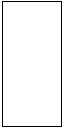
Description	Maximum Amperes			
	100A	225A		
Current Design				
Panelboard “only” replacement circuit breakers These circuit breakers, when used in a panelboard, are direct replacements for the circuit breakers listed below both electrically and physically.	RE ①, REA ② 	REH 	RFA ③, RHFA 	RF ④, RHF 
	Width: 4.13 Height: 6.00 Depth: 3.38	Width: 4.13 Height: 6.00 Depth: 3.38	Width: 4.13 Height: 6.00 Depth: 3.38	Width: 4.13 Height: 9.38 Depth: 3.81
Out-of-Production Westinghouse Circuit Breakers				
These circuit breakers are no longer manufactured These circuit breakers, when used in a panelboard, are directly replaced by the circuit breakers listed above. *Indicates last date of manufacture.	E, EA 	EH 	FA, HFA 	F, HF 
	*1974 Width: 4.13 Height: 6.00 Depth: 3.38	*1974 Width: 4.13 Height: 6.50 Depth: 3.38	*1974 Width: 4.13 Height: 6.50 Depth: 3.38	*1974 Width: 4.13 Height: 9.38 Depth: 3.81

Notes

- ① Obsolete—no replacement.
- ② Obsolete—use REH (available in three-pole only).
- ③ Obsolete—use RHFA (available in three-pole only).
- ④ Obsolete—use RHF (available in three-pole only).

Panelboard “Only” Replacement Circuit Breaker Guide—Dimensions in Inches (Per Three-Pole Breaker), continued

Maximum Amperes

225A

400A

400A

800A

Current Design

RJ



RK ①, RHK



RKL ②, RHKL



RLM ③, RHLM

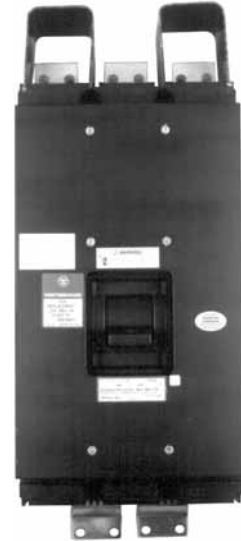

Width: 8.25
Height: 10.13
Depth: 4.06

Width: 8.25
Height: 15.50
Depth: 4.06

Width: 8.25
Height: 16.00
Depth: 4.06

Width: 8.25
Height: 22.00
Depth: 5.50

Out-of-Production Westinghouse Circuit Breakers

J

K, HK

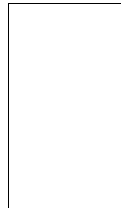

KL, HKL

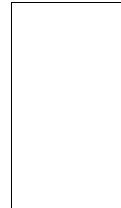

LM, HLM

*1967

*1967

*1967

*1967

Width: 8.25
Height: 10.13
Depth: 4.06

Width: 8.25
Height: 15.50
Depth: 4.06

Width: 8.25
Height: 16.00
Depth: 4.06

Width: 8.25
Height: 22.00
Depth: 5.50

Further Information

Publication Number	Description
IL 15558	Mounting information for the RE, REA breakers
IL 15559	Mounting information for the RF, RHF breakers
IL 15562	Mounting information for the REH, RFA, RHFA breakers
IL 15563	Mounting information for the RJ breaker
IL 15564	Mounting information for the RK, RHK breakers
IL 15565	Mounting information for the RKL, RHKL breakers
IL 15566	Mounting information for the RLM, RHLM breakers

Notes

- ① Obsolete—use RHK (available in three-pole only).
- ② Obsolete—use RHKL (available in three-pole only).
- ③ Obsolete—use RHLM (available in three-pole only).

■ Shaded area denotes obsolete or discontinued products and services. ①

Type REA



Type REA, Single-, Two- and Three-Pole, 240 Vac Maximum, Thermal-Magnetic

Continuous Ampere Rating at 40°C	Catalog Number		
	Single-Pole, 120 Vac	Two-Pole, 240 Vac	Three-Pole, 240 Vac
10	REA1010	—	—
15	REA1015	REA2015	REA3015
20	REA1020	REA2020	REA3020
25	REA1025	REA2025	REA3025
30	REA1030	REA2030	REA3030
40	REA1040	REA2040	REA3040
50	REA1050	REA2050	REA3050
60	REA1060	REA2060	REA3060
70	REA1070	REA2070	REA3070
80	REA1080	REA2080	REA3080
90	REA1090	REA2090	REA3090
100	REA1100	REA2100	REA3100

Type REH



Type REH, Single-, Two- and Three-Pole, 480 Vac Maximum, Thermal-Magnetic

Continuous Ampere Rating at 40°C	Catalog Number		
	Single-Pole, 277 Vac	Two-Pole, 480 Vac	Three-Pole, 480 Vac
10	REH1010	—	—
5	REH1015	REH2015	REH3015
20	REH1020	REH2020	REH3020
25	REH1025	REH2025	REH3025
30	REH1030	REH2030	REH3030
40	REH1040	REH2040	REH3040
50	REH1050	REH2050	REH3050
60	REH1060	REH2060	REH3060
70	REH1070	REH2070	REH3070
80	REH1080	REH2080	REH3080
90	REH1090	REH2090	REH3090
100	REH1100	REH2100	REH3100

Type RE



Type RE, Single-, Two- and Three-Pole, 240 Vac Maximum, Thermal-Magnetic

Continuous Ampere Rating at 40°C	Catalog Number		
	Single-Pole, 120 Vac	Two-Pole, 240 Vac	Three-Pole, 240 Vac
10	RE1010	—	—
15	RE1015	RE2015	RE3015
20	RE1020	RE2020	RE3020
25	RE1025	RE2025	RE3025
30	RE1030	RE2030	RE3030
40	RE1040	RE2040	RE3040
50	RE1050	RE2050	RE3050
60	RE1060	RE2060	RE3060
70	RE1070	RE2070	RE3070
80	RE1080	RE2080	RE3080
90	RE1090	RE2090	RE3090
100	RE1100	RE2100	RE3100

Terminals

Maximum Amperes	Wire Type	Wire Range	Style Number ②
Standard Pressure Type Terminals			
20 (EB, EHB)	Al/Cu	#14-#10	624B100G14
100	Al/Cu	#14-1/0	624B100G02
150	Al/Cu	#4-4/0	624B100G17
Optional Al/Cu Pressure Terminals			
50	Al/Cu	#14-#4	624B100G10
100	Al/Cu	#4-4/0	624B100G17

Accessories and Modifications

All accessories and modifications available for Replacement Breakers Types EB, EHB and FB are also available for Panelboard Replacement Breakers Types RE, REH, RFA, RF, RHF, REA and RHFA.

For accessories and modifications, refer to **Pages V12-T3-65-V12-T3-79**.

Terminals

See table on **Page V12-T3-83**.

50°C Calibration

Add suffix "V" to catalog number for breakers to be used in 50°C ambients. Same price as standard 40°C breakers.

Note: Not UL Listed.

Notes

- ① These frames are obsolete. For replacement solutions, see the cross-reference on **Pages V12-T3-114-V12-T3-167** or call 803-481-6843 for other panelboard solutions.
- ② Package of three.

Shaded area denotes obsolete or discontinued products and services. ①

Panelboard Replacement Circuit Breakers (Includes Terminals on Load Side Only)

Continuous Ampere Rating at 40°C	Catalog Number	
	Two-Pole, 600 Vac	Three-Pole, 600 Vac
Type RFA Two-, Three-Pole, 600 Vac Maximum, Thermal-Magnetic		
15	RFA2015	RFA3015
20	RFA2020	RFA3020
25	RFA2025	RFA3025
30	RFA2030	RFA3030
35	RFA2035	RFA3035
40	RFA2040	RFA3040
50	RFA2050	RFA3050
60	RFA2060	RFA3060
70	RFA2070	RFA3070
80	RFA2080	RFA3080
90	RFA2090	RFA3090
100	RFA2100	RFA3100
125	RFA2125	RFA3125
150	RFA2150	RFA3150
Type RF Two-, Three-Pole, 600 Vac Maximum, Thermal-Magnetic		
15	RF2015	RF3015
20	RF2020	RF3020
25	RF2025	RF3025
30	RF2030	RF3030
35	RF2035	RF3035
40	RF2040	RF3040
50	RF2050	RF3050
60	RF2060	RF3060
70	RF2070	RF3070
80	RF2080	RF3080
90	RF2090	RF3090
100	RF2100	RF3100
Type RHFA Two-, Three-Pole, 600 Vac Maximum, Thermal-Magnetic		
15	RHFA2015	RHFA3015
20	RHFA2020	RHFA3020
25	RHFA2025	RHFA3025
30	RHFA2030	RHFA3030
35	RHFA2035	RHFA3035
40	RHFA2040	RHFA3040
50	RHFA2050	RHFA3050
60	RHFA2060	RHFA3060
70	RHFA2070	RHFA3070
80	RHFA2080	RHFA3080
90	RHFA2090	RHFA3090
100	RHFA2100	RHFA3100
125	RHFA2125	RHFA3125
150	RHFA2150	RHFA3150

Note

① These frames are obsolete. For replacement solutions, see the cross-reference on **Pages V12-T3-114–V12-T3-167** or call 803-481-6843 for other panelboard solutions.

Type RFA



Type RF





Type RHFA



Shaded area denotes obsolete or discontinued products and services. ^①

Panelboard Replacement Circuit Breakers (Includes Terminals on Load Side Only)

	Continuous Ampere Rating at 40°C	Catalog Number	Three-Pole, 600 Vac
		Two-Pole, 600 Vac	
Type RHF 	Type RHF Two-, Three-Pole, 600 Vac Maximum, Thermal-Magnetic		
	15	RHF2015	RHF3015
	20	RHF2020	RHF3020
	25	RHF2025	RHF3025
	30	RHF2030	RHF3030
	40	RHF2040	RHF3040
	50	RHF2050	RHF3050
	60	RHF2060	RHF3060
	70	RHF2070	RHF3070
	80	RHF2080	RHF3080
	90	RHF2090	RHF3090
	100	RHF2100	RHF3100
Type RJ 	Type RJ Two-, Three-Pole, 600 Vac Maximum, Thermal-Magnetic		
	70	RJ2070	RJ3070
	90	RJ2090	RJ3090
	100	RJ2100	RJ3100
	125	RJ2125	RJ3125
	150	RJ2150	RJ3150
	175	RJ2175	RJ3175
	200	RJ2200	RJ3200
	225	RJ2225	RJ3225
	225 MCS	RJ2225K	RJ3225K
Type RK 	Type RK Two-, Three-Pole, 600 Vac Maximum, Thermal-Magnetic		
	70	RK2070	RK3070
	90	RK2090	RK3090
	100	RK2100	RK3100
	125	RK2125	RK3125
	150	RK2150	RK3150
	175	RK2175	RK3175
	200	RK2200	RK3200
	225	RK2225	RK3225
	225 MCS	RK2225K	RK3225K
Type RKL 	Type RKL Two-, Three-Pole, 600 Vac Maximum, Thermal-Magnetic		
	125	RKL2125	RKL3125
	150	RKL2150	RKL3150
	175	RKL2175	RKL3175
	200	RKL2200	RKL3200
	225	RKL2225	RKL3225
	250	RKL2250	RKL3250
	300	RKL2300	RKL3300
	350	RKL2350	RKL3350
	400	RKL2400	RKL3400
	400 MCS	RKL2400K	RKL3400K

Note

^① These frames are obsolete. For replacement solutions, see the cross-reference on **Pages V12-T3-114–V12-T3-167** or call 803-481-6843 for other panelboard solutions.

3

Molded-Case Circuit Breakers

Replacement Capabilities

Shaded area denotes obsolete or discontinued products and services. ①

Panelboard Replacement Circuit Breakers (Includes Terminals on Load Side Only)

Continuous Ampere Rating at 40°C Catalog Number
Two-Pole, 600 Vac Three-Pole, 600 Vac

3

Type RLM



Type RLM Two-, Three-Pole, 600 Vac Maximum, Thermal-Magnetic

125	RLM2125	RLM3125
150	RLM2150	RLM3150
175	RLM2175	RLM3175
200	RLM2200	RLM3200
225	RLM2225	RLM3225
250	RLM2250	RLM3250
275	RLM2275	RLM3275
300	RLM2300	RLM3300
350	RLM2350	RLM3350
400	RLM2400	RLM3400
500	RLM2500	RLM3500
600	RLM2600	RLM3600
600 MCS	RLM2600K	RLM3600K
700	RLM2700	RLM3700
800	RLM2800	RLM3800

Type RHK



Type RHK Two-, Three-Pole, 600 Vac Maximum, Thermal-Magnetic

70	RHK2070	RHK3070
90	RHK2090	RHK3090
100	RHK2100	RHK3100
125	RHK2125	RHK3125
150	RHK2150	RHK3150
175	RHK2175	RHK3175
200	RHK2200	RHK3200
225	RHK2225	RHK3225
225 MCS	RHK2225K	RHK3225K

Type RHKL



Type RHKL Two-, Three-Pole, 600 Vac Maximum, Thermal-Magnetic

125	RHKL2125	RHKL3125
150	RHKL2150	RHKL3150
175	RHKL2175	RHKL3175
200	RHKL2200	RHKL3200
225	RHKL2225	RHKL3225
250	RHKL2250	RHKL3250
300	RHKL2300	RHKL3300
350	RHKL2350	RHKL3350
400	RHKL2400	RHKL3400
400 MCS	RHKL2400K	RHKL3400K

Note

① These frames are obsolete. For replacement solutions, see the cross-reference on **Pages V12-T3-114–V12-T3-167** or call 803-481-6843 for other panelboard solutions.

Shaded area denotes obsolete or discontinued products and services. ①

Type RHLM



Panelboard Replacement Circuit Breakers (Includes Terminals on Load Side Only)

Continuous Ampere Rating at 40°C	Catalog Number	
	Two-Pole, 600 Vac	Three-Pole, 600 Vac
Type RHLM Two-, Three-Pole, 600 Vac Maximum, Thermal-Magnetic		
125	RHLM2125	RHLM3125
150	RHLM2150	RHLM3150
175	RHLM2175	RHLM3175
200	RHLM2200	RHLM3200
225	RHLM2225	RHLM3225
250	RHLM2250	RHLM3250
275	RHLM2275	RHLM3275
300	RHLM2300	RHLM3300
325	RHLM2325	RHLM3325
350	RHLM2350	RHLM3350
400	RHLM2400	RHLM3400
450	RHLM2450	RHLM3450
500	RHLM2500	RHLM3500
550	RHLM2550	RHLM3550
600	RHLM2600	RHLM3600
600 MCS	RHLM2600K	RHLM3600K
700	RHLM2700	RHLM3700
800	RHLM2800	RHLM3800

Accessories and Modifications

All accessories and modifications available for replacement breakers types KA, LA and MA are also available for panelboard replacement breakers types RJ, RK, RKL, RLM, RHK, RHKL and RHLM.

For additional accessories and modifications, refer to **Pages V12-T3-65–V12-T3-79**.

Terminals

Panelboard Circuit Breakers	Terminals ②
RJ	TA225LA1
RK	TA225LA1
RHK	TA225LA1
RKL	TA400LA1
RHKL	TA400LA1
RLM	TA700MA1 (for <600A)
RHLM	TA800MA1 (for 700–800A)

50°C Calibration

Add suffix “V” to catalog number for breakers to be used in 50°C ambients. Same price as standard 40°C breakers.

Note: Not UL Listed.

Special Breakers

Magnetic only (includes load terminals). Available for all ampere ratings for two- and three-pole RJ, RK, RKL, RLM, RHK, RHKL and RHLM.

High magnetic molded-case switches (K suffix) are available to replace out-of-production non-automatic breakers (N suffix).

Note: Not UL Listed.

Panelboard and Switchboard Replacement Breaker Ordering Instructions

1. Choose the breaker frame and amperage.
2. Select the proper connector kit (if needed).
3. Call your local distributor with catalog numbers and request Eaton's Free Express Service.

Compatible with Panelboards and Switchboards from: Westinghouse Distribution and Control Business Unit

1987–1998



1991–1998

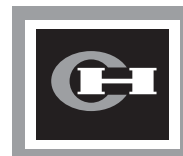

1994–2000



Cutler-Hammer

2000–2009



2009–Present

Connector Kits for Pow-R-Line 4 Panelboards and Pow-R-Line C Switchboards

Breaker Type	Catalog Number	
	Single	Twin
F-Frame	—	KPRL4FD
J-Frame	KPRL4JDS	KPRL4JDT
K-Frame	KPRL4KDS	KPRL4KDT
L-Frame	KPRL4LD	—
M-Frame	KPRL4MC	—
N-Frame	KPRL4ND	—

For further information, reference Page **V12-T3-168** in this catalog.

Notes

① These frames are obsolete. For replacement solutions, see the cross-reference on **Pages V12-T3-114–V12-T3-167** or call 803-481-6843 for other panelboard solutions.

② Packaged individually.

Shaded area denotes obsolete or discontinued products and services.

Replacement Capabilities

Cutler-Hammer motor control center replacement circuit breakers are newly manufactured and tested to the latest applicable standards at the Eaton molded-case circuit breaker plant in Beaver, PA. This plant has a long and well-recognized tradition of product safety, integrity and quality.

The motor control center replacement circuit breaker solution eliminates the need to consider alternative approaches. Eaton customers are ensured that the high standards of product quality and reliability do not have to be sacrificed when replacing Westinghouse out-of-production circuit breakers.

All motor control center replacement circuit breakers are easily identified by the prefix “RMC” added to the out-of-production type circuit breaker catalog number they replace.

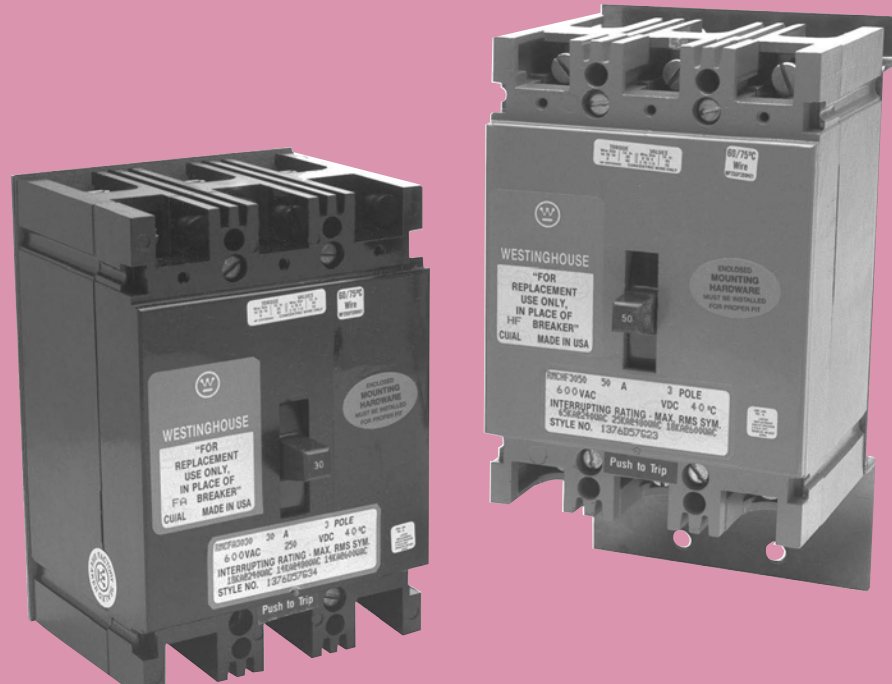

Replacement Motor Control Center Breakers

Replacement Chart

Current MCC Circuit Breaker Type	Out-of-Production Circuit Breaker Type ①	Volts AC (50/60 Hz) 600
RMCF	FA	■
RMCF	HFA	■
RMCF	F	■
RMCF	HF	■

Motor Control Center Replacement Breaker Interrupting Ampere Ratings

Breaker Type	Ampers	240 Vac	480 Vac	600 Vac	250 Vac
RMCF ②③	15–100	18,000	14,000	14,000	10,000
RMCF ②③④	15–150	18,000	14,000	14,000	10,000
RMCF ②③	15–100	65,000	25,000	18,000	20,000
RMCF ②③④	15–150	65,000	25,000	18,000	20,000

Example:

An **RMCF3100** is a newly manufactured, three-pole, 100A trip panelboard replacement circuit breaker. It replaces an out-of-production F circuit breaker.

Example:

RMC Designates new motor control center replacement circuit breaker.

F Identifies the out-of-production circuit breaker frame.

3 Number of poles.

100 Trip unit ampere rating.

Contact **1-800-OLD-UNIT** for replacement or **Page V12-T3-91** for Series C retrofit kits.



Notes

- ① Last manufacture date—1974.
- ② Motor control center replacement breakers do not have the same physical dimensions or mounting holes as the breakers they replace. Types **RMCF** and **RMCF** are 6.00 inches long and the breakers they replace, **FA** and **HFA**, are 6.50 inches long. Types **RMCF** and **RMCF** are 6.00 inches long and the breakers they replace, **F** and **HF**, are 9.375 inches long. A mounting plate is provided with each breaker to resolve these differences, and must be installed to ensure a proper fit.
- ③ Motor control center replacement circuit breakers have non-interchangeable trip units and the same interrupting capacity as the out-of-production circuit breakers they replace.
- ④ **RMCF** and **RMCF** two-pole breakers are supplied in a three-pole frame with current carrying parts omitted from the center pole.

Types RMCFA, RMCF, RMCHFA and RMCHF—Motor Control Center Replacement

■ Shaded area denotes obsolete or discontinued products and services. ①

Motor Control Center Replacement Circuit Breakers

	Continuous Ampere Rating at 40°C	Catalog Number		
		Single-Pole	Two-Pole	Three-Pole
Type RMCFA				
	Type RMCFA – 15–100A Two-, Three-Pole, 600 Vac Maximum, Thermal-Magnetic			
	15	—	RMCF2015	RMCF3015
	20	—	RMCF2020	RMCF3020
	25	—	RMCF2025	RMCF3025
	30	—	RMCF2030	RMCF3030
	35	—	RMCF2035	RMCF3035
	40	—	RMCF2040	RMCF3040
	50	—	RMCF2050	RMCF3050
	60	—	RMCF2060	RMCF3060
	70	—	RMCF2070	RMCF3070
	80	—	RMCF2080	RMCF3080
	90	—	RMCF2090	RMCF3090
100	—	RMCF2100	RMCF3100	
Type RMCF – 15–150A Two-, Three-Pole, 600 Vac Maximum, Thermal-Magnetic				
	15	—	RMCHF2015	RMCHF3015
	20	—	RMCHF2020	RMCHF3020
	25	—	RMCHF2025	RMCHF3025
	30	—	RMCHF2030	RMCHF3030
	35	—	RMCHF2035	RMCHF3035
	40	—	RMCHF2040	RMCHF3040
	50	—	RMCHF2050	RMCHF3050
	60	—	RMCHF2060	RMCHF3060
	70	—	RMCHF2070	RMCHF3070
	80	—	RMCHF2080	RMCHF3080
	90	—	RMCHF2090	RMCHF3090
	100	—	RMCHF2100	RMCHF3100
125	—	RMCHF2125	RMCHF3125	
150	—	RMCHF2150	RMCHF3150	

Notes

① These frames are obsolete. For more information, call 1-800-OLD-UNIT for Cutler-Hammer motor control solutions.

See Page V12-T3-91 for Series C retrofit kits.

3

Molded-Case Circuit Breakers

Replacement Capabilities

Shaded area denotes obsolete or discontinued products and services. ①

Motor Control Center Replacement Circuit Breakers

Continuous Ampere Rating at 40°C	Catalog Number		
	Single-Pole	Two-Pole	Three-Pole
Type RMCHFA – 15–100A Two-, Three-Pole, 600 Vac Maximum, Thermal-Magnetic			
15	—	RMCHFA2015	RMCHFA3015
20	—	RMCHFA2020	RMCHFA3020
25	—	RMCHFA2025	RMCHFA3025
30	—	RMCHFA2030	RMCHFA3030
35	—	RMCHFA2035	RMCHFA3035
40	—	RMCHFA2040	RMCHFA3040
50	—	RMCHFA2050	RMCHFA3050
60	—	RMCHFA2060	RMCHFA3060
70	—	RMCHFA2070	RMCHFA3070
80	—	RMCHFA2080	RMCHFA3080
90	—	RMCHFA2090	RMCHFA3090
100	—	RMCHFA2100	RMCHFA3100
125	—	RMCHFA2125	RMCHFA3125
150	—	RMCHFA2150	RMCHFA3150

Type RMCHFA



Type RMCHF – 15–100A Two-, Three-Pole, 600 Vac Maximum, Thermal-Magnetic

15	—	RMCHF2015	RMCHF3015
20	—	RMCHF2020	RMCHF3020
25	—	RMCHF2025	RMCHF3025
30	—	RMCHF2030	RMCHF3030
35	—	RMCHF2035	RMCHF3035
40	—	RMCHF2040	RMCHF3040
50	—	RMCHF2050	RMCHF3050
60	—	RMCHF2060	RMCHF3060
70	—	RMCHF2070	RMCHF3070
80	—	RMCHF2080	RMCHF3080
90	—	RMCHF2090	RMCHF3090
100	—	RMCHF2100	RMCHF3100

Type RMCHF



Notes

① These frames are obsolete. For more information, call **1-800-OLD-UNIT** for Cutler-Hammer motor control solutions.

See **Page V12-T3-91** for Series C retrofit kits.

Technology Upgrades

Series C Retrofit Kits

Series C Retrofit Kits are to be used to upgrade existing Type W and 5 Star motor control center units by changing out the old breakers with new Series C models. These kits can be applied to both starter and feeder units.

Some of the breakers that these kits will upgrade include:

- MCP, F, FA, FB, HFB, K, KA, KB, HKB, L, LA, LB and HLB breakers

5 Star Series C Retrofit Kit



5 Star Series C Retrofit Kit

The 5 Star Series C retrofit kit includes:

- Series C device, 65 kA (either HMCP or thermal-magnetic breaker)
- Operating handle, including tripped indication and push-to-trip mechanism
- Label stating that the MCC unit has been retrofitted with Series C device suitable for 65 kA (similar to UL quality label)
- Templates for desired frame size
- Assembly instructions

Customer benefits:

- Ease of ordering—one catalog number for all required parts
- Series C technology—higher AIC rating
- All new components associated with the breaker, including new stab assembly, operating mechanism and door, if required

Type W Series C Retrofit Kit



Type W Series C Retrofit Kit

The Type W Series C retrofit kit includes:

- Series C device, 65 kA (either HMCP or thermal-magnetic breaker)
- Operating handle, including tripped indication and push-to-trip mechanism
- Label stating that the MCC unit has been retrofitted with Series C device suitable for 65 kA (similar to UL quality label)
- Templates for proper hole placement for desired frame size
- Series C breaker mounting hardware
- New door and hardware
- New stab assembly
- Assembly instructions

310+ Electronic Trip Unit

The 310+ electronic trip unit has advantages and upgraded features over the Series C 310 electronic trip unit as follows:

- Adjustable I_r continuous current setting eliminates the need for rating plugs
- Cause of trip information can be extracted from the breaker
- Zone selective interlocking option for breaker coordination
- Ground fault alarm only option to keep critical equipment on-line when a ground fault is present
- Arcflash Reduction Maintenance System™ to improve worker safety

Note: Available only for the LG, NG, RG/RD 310+ models.

The 310+ electronic trip unit is available for the following MCCB breakers:

- Series C FDE
- Series G JG
- Series G LG
- Series G NG
- Series G RG
- Series C RD (available as a field retrofit kit)

Series C to Series G Upgrades

The Series C 250A JD and 600A LD breakers are being replaced by Series G 250A JG and 600A LG breakers respectively. There are several advantages in moving from these Series C to Series G breakers.

Series G 250A JG Molded-Case Circuit Breaker

- Smaller breaker footprint than Series C JD
- Breaker is dual rated, UL and IEC
- Interruption ratings up to 200 kAIC at 480 Vac
- Accessories are field installable thru-cover
- Now available with an electronic, 310+ trip unit
- Can accommodate the ANSI C12.1 Power Monitoring/Metering Module (PM3)

Series G 600A LG Molded-Case Circuit Breaker:

- Smaller breaker footprint Series C LD
- Breaker is dual rated, UL and IEC
- Interruption ratings up to 200 kAIC at 480 Vac
- Accessories are field installable thru-cover
- Upgraded from 310 electronic trip unit to a 310+ electronic trip unit
- Can accommodate the ANSI C12.1 Power Monitoring Metering Module (PM3)

Advantages of 310+ Electronic Trip Unit Technology Versus the 310 Electronic Trip Unit:

- Adjustable I_r continuous current setting eliminates the need for rating plugs
- Cause of trip information can be extracted from the breaker
- Zone selective interlocking option for breaker coordination
- Ground fault alarm only option to keep critical equipment on-line when a ground fault is present
- Arcflash Reduction Maintenance System to improve worker safety (not available in the JG 310+ electronic trip unit)

F10 Series C Retrofit Kit**F10 Series C Retrofit Kit**

The F10 Series C retrofit kit includes:

- Series C device, 65 kA (either HMCP or thermal-magnetic breaker)
- Operating handle mechanism, including tripped indication push-to-trip
- Label stating that the MCC unit has been retrofitted with Series C device suitable for 65 kA (similar to UL quality label)
- Templates for desired frame size
- Assembly instructions

Series C Molded-Case Circuit Breakers

Frame Type	Interrupting Rating (kAIC)			Trip Rating Amperes	Catalog Number
	240V	480V	600V		
HFD	100	65	25	15	HFD3015
HFD	100	65	25	20	HFD3020
HFD	100	65	25	25	HFD3025
HFD	100	65	25	30	HFD3030
HFD	100	65	25	40	HFD3040
HFD	100	65	25	50	HFD3050
HFD	100	65	25	60	HFD3060
HFD	100	65	25	70	HFD3070
HFD	100	65	25	80	HFD3080
HFD	100	65	25	90	HFD3090
HFD	100	65	25	100	HFD3100
HFD	100	65	25	125	HFD3125
HFD	100	65	25	150	HFD3150
FDC	200	100	35	15	FDC3015
FDC	200	100	35	20	FDC3020
FDC	200	100	35	25	FDC3025
FDC	200	100	35	30	FDC3030
FDC	200	100	35	40	FDC3040
FDC	200	100	35	50	FDC3050
FDC	200	100	35	60	FDC3060
FDC	200	100	35	70	FDC3070
FDC	200	100	35	80	FDC3080
FDC	200	100	35	90	FDC3090
FDC	200	100	35	100	FDC3100
FDC	200	100	35	125	FDC3125
FDC	200	100	35	150	FDC3150
HJD	100	65	25	175	HJD3175
HJD	100	65	25	200	HJD3200
HJD	100	65	25	225	HJD3225
HJD	100	65	25	250	HJD3250
JDC	200	100	35	175	JDC3175
JDC	200	100	35	200	JDC3200
JDC	200	100	35	225	JDC3225
JDC	200	100	35	250	JDC3250
HKD	100	65	35	300	HKD3300
HKD	100	65	35	350	HKD3350
HKD	100	65	35	400	HKD3400
KDC	200	100	50	300	KDC3300
KDC	200	100	50	350	KDC3350
KDC	200	100	50	400	KDC3400

Series C Motor Circuit Protectors

Starter Size	Magnetic Trip Range Amperes	Continuous Rating Amperes	Catalog Number
0	9–30	3	HMCP003A0
0	21–70	7	HMCP007C0
0	45–150	15	HMCP015E0
0	40–60	25	HMCP025D0
1	90–300	30	HMCP030H1
2	80–120	50	HMCP050G2
2	150–500	50	HMCP050K2
2	115–170	70	HMCP070J2
2	210–700	70	HMCP070M2
3	160–240	100	HMCP100L3
3	300–1000	100	HMCP100R3
4	450–1500	150	HMCP150T4
4	750–2500	150	HMCP150U4
4, 5	350–700	250	HMCP250A5
5	450–900	250	HMCP250C5
5	500–1000	250	HMCP250D5
5	625–1250	250	HMCP250F5
5	750–1500	250	HMCP250G5
5	875–1750	250	HMCP250J5
5	1000–2000	250	HMCP250K5
5	1125–2250	250	HMCP250L5
5	1250–2500	250	HMCP250W5
5	500–1000	400	HMCP400D5
5	625–1250	400	HMCP400F5
5	750–1500	400	HMCP400G5
5	875–1750	400	HMCP400J5
5	1000–2000	400	HMCP400K5
5	1125–2250	400	HMCP400L5
5	1250–2500	400	HMCP400M5
5	1500–3000	400	HMCP400N5
5	1750–3500	400	HMCP400R5
5, 6	2000–4000	400	HMCP400X5

Series C Retrofit Kit Catalog Numbering System

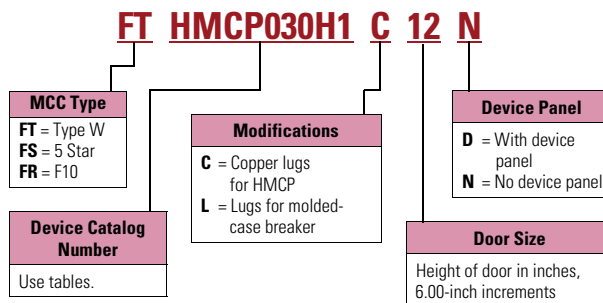

How to Order

Step 1: Select the correct Series C molded-case circuit breaker from the table on **Page V12-T3-92** or the Series C motor circuit protector from the table on this page.

Step 2: Create a catalog number based on the MCC type, device selected, modifications, door size and device panel.

Step 3: Select price from PL04304002E.

OPTIM 550 Trip Units for Upgrading Thermal/Magnetic Trips



Digitrip OPTIM 550

Replacement of the OPTIM 550 trip units and the associated accessories allows a customer to easily upgrade an existing Series C, K- or L-Frame molded-case circuit breaker equipped with a standard thermal-magnetic trip unit, without the need to purchase a new circuit breaker.

Key features and benefits of the OPTIM 550 trip unit include:

- 10 set points providing for premium protection and coordination
- Cause-of-Trip indication (LEDs and digital memory)
- Load monitoring to provide information for energy management
- Diagnostics to assist in system troubleshooting
- Communications and zone interlocking options—field or factory installed

OPTIM 550 Trip Units for Upgrading Thermal/Magnetic Trips

Maximum Ampere Rating (Sensor)	Catalog Number		
	Type of OPTIM 550 Trip Unit		
	LSI	LSIA	LSIG
KD, HKD, KDC, CKD and CHKD Breaker Frames			
125	KEP3125T52	KEP3125T57	KEP3125T56
250	KEP3250T52	KEP3250T57	KEP3250T56
400	KEP3400T52	KEP3400T57	KEP3400T56
LD, HLD, LDC, CLD, CHLD and CLDC Breaker Frames			
125	LEP3125T52	LEP3125T57	LEP3125T56
250	LEP3250T52	LEP3250T57	LEP3250T56
400	LEP3400T52	LEP3400T57	LEP3400T56
600	LEP3600T52	LEP3600T57	LEP3600T56

Cutler-Hammer PowerNet™ and Zone Interlock Kits (OPTIM 550 Only) K-, L- and N-Frames

PowerNet Communication Kit

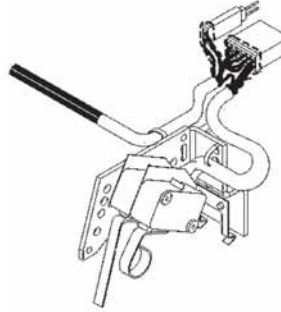

The Cutler-Hammer PowerNet communications kit can be ordered to add PowerNet communications to an existing OPTIM 550 breaker in the field. An 18.00-inch wiring pigtail is routed to the rear of the breaker: two wires for PowerNet and two wires for 24 Vdc (45 mA load). It is recommended that the power supply be an “isolated high quality” unit.

PowerNet and Zone Interlock Kits

Circuit Breaker	PowerNet		Zone Interlocking/ Ground ①		PowerNet and Zone Interlocking/Ground ①	
	Factory Install Suffix	Catalog Number	Factory Install Suffix	Catalog Number	Factory Install Suffix	Catalog Number
K-Frame	PN	ICK550K	ZG	ZGK550K	ZGP	ZGPK550K
L-Frame	PN	ICK550L	ZG	ZGK550L	ZGP	ZGPK550L
N-Frame	PN	ICK550N	ZG	ZGK550N	ZGP	ZGPK550N

Notes

① Includes a ground fault alarm signal that can drive the ground fault alarm unit (catalog number GFAU).

Instruction leaflet numbers (K) 29C506, (L) 29C897, (N) 29C898.

Handle Mechanisms

■ Shaded area denotes obsolete or discontinued products and services.

MCCB Handle Mechanism Introduction

Eaton offers a broad range of handle mechanisms for molded-case circuit breakers. Each of these has been designed specifically for safe, dependable operation and ease of installation.

Handle mechanisms are used in a wide variety of applications including enclosed molded-case circuit breakers, control panels and motor control centers.

Whether replacing a damaged handle mechanism with a like unit, switching from fuses to circuit breakers in order to limit downtime, or upgrading to take advantage of the many benefits associated with applying communicating, programmable molded-case circuit breaker technology, Eaton has the handle mechanism solution that is right for you.



Flex-Shaft Type—Page V12-T3-107



Slide Plate Type—Page V12-T3-99



Vari-Depth Type—Page V12-T3-105



*Type SM Safety Handle—
Page V12-T3-101*

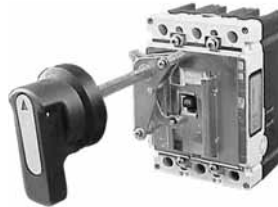

*Universal Rotary Type—
Page V12-T3-110*



*Type MC Motor Control—
Page V12-T3-103*



*Type AMT Vari-Depth—
Page V12-T3-104*

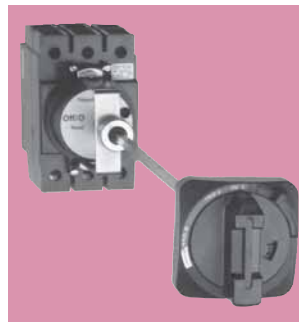

G-Frame Vari-Depth



Series C Rotary Type—Page V12-T3-109



Universal Direct—Page V12-T3-111



G Direct—Page V12-T3-111



Euro IEC Direct—Page V12-T3-111

3

Handle Mechanism Selection and Availability Guide

Circuit Breaker and Switch Type	Door Mounted				Flange Mounted			
	Vari-Depth	Series C ^① Rotary	Slide Plate	MC	Series C ^① Flex Shaft	SM	AMT Fixed Width	AMT Vari-Depth
Series C Breakers								
F-Frame/F HMCP ^②	■	■	■	■	■	■	■	■
J-Frame/J HMCP	■	■	■	■	■	■	■	■
K-Frame/K HMCP	■	■	■	■	■	■	■	■
L-Frame/L HMCP	■	■	■	■	■	■	■	■
M-Frame	■	■	■	■	■	■		■
N-Frame		■			■			
R-Frame			■		■			
Other Industrial Breakers								
GB/GHB/GC/GHC/GD/GMCP	■							
LA/LAB/HLA	■		■	■		■	■	■
LC/HLC/LCG	■		■	■		■	■	■
MA/HMA	■		■	■		■		■
MC/HMC	■		■	■		■		■
NB/HNB	■		■	■		■		■
NC/HNC	■		■	■		■		■
PB			■					
PC/PCC			■					
FB TRI-PAC	■		■	■		■		■
LA TRI-PAC	■		■			■		■
NB TRI-PAC	■		■			■		■
PB TRI-PAC			■					
FCL	■			■		■		
LCL	■			■		■		■
EB/EHB/FB/HFB	■		■	■		■	■	■
JA/KA/HKA/DA/LB/LBB/HLB	■		■	■		■	■	■
Disconnect Switches								
DE-ION [®] 30, 60, 100	■		■					
DS 30, 60, 100, 200	■		■	■		■	■	■
DS 400, 600			■					
Visi-Flex Model "T" 30, 60, 100			■					

Notes

① For application only with Series C molded-case circuit breakers and HMCPs.

② Series C F-Frame includes EHD, ED, FDB, FD, HFD and FDC designations.

Vari-Depth Type

General purpose vari-depth handle mechanisms are suitable for use with Type 1 fabricated enclosures. They are designed for use with breakers or disconnect switches when used in deep enclosures.

Required for a standard application are a padlockable operating handle, a shaft and a mechanism. Two variable depth shafts are offered to better cover the wide range of depths of various enclosures...these are referred to in the table as the standard and the long shaft. The dimensions for panel depth given in the following

table are from the mounting surface of the breaker or the disconnect to the inside of the enclosure cover.

Standard mechanisms do not include an internal lockoff device. Mechanisms with this feature are, however, offered as an optional item. The internal lockoff provides a means of padlocking the breaker or the switch in the OFF position while the enclosure door is open.

These mechanisms may also be used in conjunction with Type 4, 7 and 9 cast enclosures. When used with these enclosures, the special handle kits shown as accessory items must be

ordered in place of the standard handle.

The adapter bushing, a component of the special handle kit, may be ordered separately.

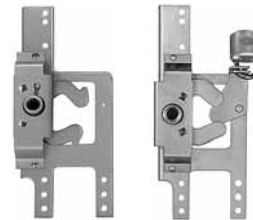

Mechanism



Handle

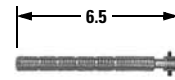

Standard Shaft

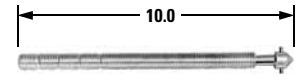

Long Shaft

3

Vari-Depth Type



Vari-Depth Type Catalog Numbers

For Complete Applications, Order Mechanism, Handle and Shaft	Mechanism ^{①②}		Handle ^③	Shaft	Standard Panel Depth	Standard Style Number	Long Panel Depth	Long Style Number
	Standard—(No Internal Lockoff) Style Number	Special—(With Internal Lockoff) Style Number	Type 1, 3R, 12 (With Hardware) Style Number	Standard Panel Depth				
Circuit Breakers								
Series C F-Frame and HMCP F ^④	373D958G22	373D958G23	504C323G07	5-10-1/4	47A4446G36	10-1/2-14	47A4446G37	
EB, EHB, FB, HFB, MCP	373D958G05	373D958G06	504C323G07	5-10-1/4	47A4446G36	10-1/2-14	47A4446G37	
CA	458D493G20	458D493G21	504C323G07	4-3/4-9-3/4	47A4446G36	9-3/4-13-1/2	47A4446G37	
Series C J-Frame and HMCP J	5092A62G03	5092A62G04	504C323G07	5-7/8-11-1/8	47A4446G36	11-1/8-14-7/8	47A4446G37	
Series C K-Frame and HMCP K	5092A62G01	5092A62G02	504C323G07	5-7/8-11-1/8	47A4446G36	11-1/8-14-7/8	47A4446G37	
Series C L-Frame and HMCP L	5092A62G05	5092A62G06	504C323G07	6-1/8-11-1/4	47A4446G36	11-1/4-15	47A4446G37	
JA, KA, HKA, DA, LB, LBB, HLB	458D493G03	458D493G11	504C323G07	5-7/8-11-1/8	47A4446G36	11-1/8-14-7/8	47A4446G37	
LA, HLA, LC, HLC	458D493G04	458D493G12	504C323G07	6-1/8-11-1/4	47A4446G36	11-1/4-15	47A4446G37	
TRI-PAC FB	373D958G10	373D958G11	504C323G07	5-10-1/4	47A4446G36	10-1/4-14	47A4446G37	
FCL	373D958G16	373D958G17	504C323G07	5-10-1/4	47A4446G36	10-1/4-14	47A4446G37	
MA, HMA, MC, HMC, Series C MD, MDS Frame (not MDL)	458D493G05	458D493G13	504C323G07	6-11/16-11-13/16	47A4446G36	11-13/16-15-9/16	47A4446G37	
NB, HNB, NC, HNC	373D958G07	373D958G08	504C323G07	7-15/16-13-1/4	47A4446G36	12-15/16-16-15/16	47A4446G37	
TRI-PAC LA	374D075G02	374D075G01	504C323G07	6-1/8-11-1/4	47A4446G36	11-1/4-15	47A4446G37	
TRI-PAC NB	373D958G12	373D958G13	504C323G07	7-15/16-13-1/4	47A4446G36	12-15/16-16-15/16	47A4446G37	
LCL	458D493G22	458D493G23	504C323G07	6-11/16-11-13/16	47A4446G36	11-13/16-15-9/16	47A4446G37	
Circuit Breakers								
30, 60, 100A DE-ION ^⑤	47A4446G34	—	⑥	5-3/4-11	⑥	11-14-3/4	47A4446G37	
Type DS 30, 60, 100A	4987D14G02	—	504C323G07	5-3/8-10-5/8	47A4446G36	10-3/8-14-5/16	47A4446G37	
Type DS 200A	4987D14G01	—	504C323G07	6-11/16-11-3/16	47A4446G36	10-7/8-14-7/8	47A4446G37	
200A DE-ION	458D493G04	458D493G12	504C323G07	6-1/8-11-1/4	47A4446G36	11-1/4-15	47A4446G37	

Notes

- ① Includes hardware.
- ② When used with plug-in adapter kits or rear-connected studs, special mounting hardware is required. Refer to Eaton.
- ③ UL File No. E56845 Vol. 1 Section 4.
- ④ Extra long shaft includes support bracket for Series C F-Frame with no internal lockoff. Order 373D958G24, which includes the mechanism, shaft and bracket. Order handle separately. Panel depth 16-3/8-24-1/4.
- ⑤ Mechanism style includes a handle and a standard shaft. A long shaft may be ordered separately if required.

Vari-Depth Type

Special Handles

Meet **Type 4 sheet steel requirements**. These handles are similar to standard handles, except they include an internal neoprene gasket. Due to gasketing effect between handle and housing, handle will not indicate a tripped position when used with circuit breakers.

UL File No. E56845 Vol. 1 Section 4.

Handle Kits

These kits are for use with **Type 4, 7 and 9 cast enclosures**. They include a special operating handle, mounting bolts and an adapter bushing (bushing may be purchased separately). Kits may be used with standard mechanisms and shafts. Instruction drawing **314C809** applies for assembly.

Handle Kits



Handle Kits

Description	Style Number
Standard finish	504C323G08
For Type 4, 9 enclosure	314C794G10
For Type 7 enclosure	314C794G09
Adapter bushing only	314C794G04

Slide Plate Type

These compact slide plate handle mechanisms are especially designed for use with AB DE-ION circuit breakers and disconnect switches when they are mounted in a shallow enclosure. They are suitable for use on Type 1 applications.

Because of the mechanisms' simplified installation—three mounting holes—and preassembled construction, these units are commonly used where high volume, standardized enclosures are being fabricated.

The mechanism styles listed on this page are for use on enclosures that have covers hinged on the right side. If these mechanisms are used on enclosures that have covers hinged on the left side, the door interlock will not function.

Vertical and Horizontal Mounting



Standard Slide Plate Mechanism Catalog Numbers

Enclosure Cover Hinged on Right	Vertical Mounting		Horizontal Mounting
	Padlocks in OFF Position Style Number	Padlocks in ON or OFF Position Style Number	Padlocks in OFF Position Style Number
Circuit Breakers			
KL and HKL frame MA, HMA, MC and HMC breaker LA, HLA, LC and HLC breaker JA, KA, HKA, DA, LB, LBB and HLB breaker NB, HNB, NC and HNC breaker JB, KB and HKB breaker LCL breaker	314C386G01	314C386G08	314C386G04
EH breaker 2P with long handle EH breaker 3P with long handle F-Frame 2P F- and HF-Frame 3P Type AQB and NQB 100A frames and Type PF 15–100A frame	314C386G02	314C386G09	314C386G05
EH standard 2P EH standard 3P and FA magnetic only 2 and 3P FA 2 and 3P thermal-magnetic EB, EHB, FB, HFB 3P MCP, HMCP (0-4) 2P FCL breaker	314C386G03	314C386G10	314C386G06
PB, TRI-PAC PB, PC, PCC, PCF	505C294G03	—	—
Series C Circuit Breakers			
F-Frame Series C + HMCP-F	314C386G03	314C386G10	314C386G06
J-Frame Series C + HMCP-J K-Frame Series C + HMCP-K	314C386G02	314C386G09	314C386G05
L-Frame Series C + HMCP-L, MDL	314C386G18	314C386G08	314C386G04
M-Frame Series C	314C386G01	314C386G08	314C386G04
R-Frame ①	505C294G03	—	—
TRI-PAC switches			
225A TRI-PAC Type K 400A TRI-PAC Type KL LA TRI-PAC NB TRI-PAC	314C386G01	314C386G08	314C386G04
100A TRI-PAC	314C386G02	314C386G09	314C386G05
FB TRI-PAC	314C386G03	314C386G10	314C386G06
Visi-Flex Switches (Model T) ②			
60–100A Visi-Flex	314C386G01	314C386G08	314C386G04
30A and Special 60A Visi-Flex	314C386G02	314C386G09	314C386G05
DE-ION Switches and Disconnect Switches			
30–60A (long handle) DE-ION 100A (long handle) DE-ION 200A disconnect switch 200 DS switch	314C386G01	314C386G08	314C386G04
30–60A disconnect switch 100A disconnect switch	314C386G02	314C386G09	314C386G05
30, 60, 100A DS switch	314C386G03	314C386G10	314C386G06
400 and 60A DS switch	314C386G15	—	—

Notes

- ① Does not padlock in OFF position. Type 3R version available as special. Contact Avery Creek, NC, Technical Resource Center.
- ② Handle mechanisms cannot be used on Visi-Flex switches with 200A fuse kits.

Outdoor or Hazardous Type

This handle mechanism is designed for use with fabricated or cast, Type 3, 4 or 5 enclosures. A butterfly cam type mechanism may be used on enclosures with either right- or left-hand hinged covers or on enclosures with bolted covers. The mechanism has a provision for padlocking. Will accept up to three locks. Assembly of this mechanism is accomplished by welding it to the enclosure door or the cover. Refer to IL29C287 for drilling plan. For PB, PC and RD, refer to drawing 372D690.

Outdoor or Hazardous Location Type**Mechanisms for Outdoor or Hazardous Locations**

Description	Drilling Plan Reference	Complete Handle Mechanisms Type 3, 4, 5	
		Padlocks in OFF Position Style Number	Padlocks in ON or OFF Position Style Number
Circuit Breakers			
Series C F-Frame EB, EHB, FB, HFB	48A3656	48A3656G03	48A3656G04
JA, KA, LA, MA, HKA, HLA, HMA, LB, HLB	452D028	452D028G01	—
DE-ION Switches			
30, 60, 100A	48A3656	48A3656G03	48A3656G04

Accessories**Door Interlock Kits**

Description	Drilling Plan Reference	Style Number
3 point—for mechanisms, style numbers: 314C386G01, 02, 03, 04, 05, 06, 08, 09, 10	208B624	28A2656G08
2 point—for PB mechanism, style number 505C294G03	372D690	1532990

Note: For use with slide plate mechanisms used in larger panels where regular interlock is not adequate.

Type SM Safety Handle



Enclosed Breaker with SM Handle

Type SM safety handle mechanism is designed to prevent tampering by unauthorized individuals and provides the optimum in personnel safety. When properly applied, these mechanisms conform to Type 12 and J.I.C. requirements, and are well-suited for use by the automotive and machine tool industries.

Completely preassembled in a rugged cast housing, the Type SM safety handle mechanism includes a predrilled mounting plate for simplified customer installation. Standard handles are 5.125 inches long and can be padlocked in the OFF position with as many as three padlocks. A shorter handle 3.875 inches long can be supplied on SM100, SM101 or SM150 mechanisms when specified.

All Type SM safety handle mechanisms can be used on any size enclosure. Order handle mechanism from the table at right, plus desired door hardware for complete application. Dress nameplate required to meet automotive specifications is available from accessories section.



Type SM Safety Handle Mechanism Catalog Numbers

Handle Mechanism for Use With:	Catalog Number ^①	
	Right-Hand Mounting Enclosure Cover Hinged On Left	Left-Hand Mounting Enclosure Cover Hinged On Right
Series C—F-Frame, MCP, HMCP F, EB, EHB, FB, HFB breakers, and Type DS 30, 60, 100A non-fusible switches	SM150R	SM150L
Type DS 30, 60, 100A fusible switches	SM100SFR	SM100SFL
FB TRI-PAC, FB breaker with current limiter, or Type FCL	SM101PR	SM101PL
30, 60, 100A DE-ION switches	SM100R	SM100L
DA, JA, KA, HKA, LB, LBB, HLB breakers	SM225R	SM225L
Series C—J-Frame, HMCP J	SM250JR	SM250JL
Series C—K-Frame, HMCP K	SM400KR	SM400KL
LAB, LA, HLA, LC, HLC breakers (400 and 600A)	SM400R	SM400L
Series C—L-Frame, HMCP L, MDL	SM600R	SM600L
Series C—M-Frame, MD, MDS	SM800R	SM800L
MA, HMA, MC, HMC breakers	SM800R	SM800L
TRI-PAC LA breaker	SM400PR	SM400PL
TRI-PAC NB	SM800PR	SM800PL
NB, HNB, NC, HNC breakers	SM1200R	SM1200L
Type DS 200A non-fusible switch	SM200SR	SM200SL
Type DS 200A fusible switch	SM200SFR	SM200SFL
Type LCL	SM400LCLR	SM400LCLL

Further Information

Publication Number	Description
IL 14439	F-Frame, EB, EHB, FB, FCL, HFB, MCP, FB-P, 30–100A DS switch
IL 29C274	J- and K-Frame
IL 29C284	L-Frame
IL 13282	JA, KA, JB, KB, LAB, LA, MA, NB, HLA, NB-P, 200A DS switch
IL 13327	DH1L door hardware
IL 13326	DH1R door hardware
IL 13325	DH2R door hardware
IL 13324	DH3L door hardware
IL 13322	DH3R door hardware
IL 13287	Electrical interlock

Notes

^① Must be ordered with door hardware; if not, door-operated defeater kit is required.

Mechanisms for Type 4 Applications—Mechanisms with stainless steel parts and special gasketing can be supplied. Order by description. 30% adder.





Type SM Safety Handle

Door Hardware

Three choices of door hardware and an auxiliary handle are offered to provide the best latching scheme for individual needs. The door hardware is designed with a provision for padlocking, and a coin-proof slot that requires the use of a tool to open the door, for maximum security.

Select desired hardware from the table below. Additional latches can be ordered from accessories section if desired. Type 1, 12 only.

Door Hardware

Description	Catalog Number	
	Right Hand	Left Hand
 With sliding latches for smaller panels up to approximately 30.00 inches high	DH1R ①	DH1L ②
 With 2-roller latches for intermediate panels up to approximately 40.00 inches high	DH2R ①	DH2L ②
 With 3-roller latches for larger panels, approximately 40.00 inches and higher	DH3R ①	DH3L ②
 Auxiliary handle for larger panels	DH4R ①	DH4L ②

Dress Nameplates

Required to meet automotive specifications. Mounts from inside enclosure and covers operating mechanism mounting bolts, making mechanism non-removable when enclosure door is closed.

Dress Nameplate

Description	Style Number
For SM100, SM150 mechanisms	373D260G05
For SM200, and larger mechanisms	373D260G05

Auxiliary Latch Kits

Provide an additional latch for use with applications where 2-point latching may not be adequate.

Slide and Roller Latches



Auxiliary Latch Kits

Description	Style Number
Door hardware using sliding latches, right- or left-hand mounting	656D669G01
Door hardware using roller latches, right-hand mounting	370D801G04
Left-hand mounting	370D802G04

Electrical Interlock Kit

Provides 1NC and 1NO contacts (SPDT switch) for use with auxiliary circuits. Mounts to end of mechanism housing as shown.

Electrical Interlock Kit



Electrical Interlock Kit

Style Number

622B747G01

Door Operated Interlock Defeater Kit

Required when door hardware is not used; operates as door closes. Additional method of securing door such as screw latch, also required (to be supplied by box manufacturer).

Door Operated Interlock Defeater Kit

Style Number

623B214G02

Notes

- ① Enclosure cover hinged on left.
- ② Enclosure cover hinged on right.

Type MC Motor Control



225A Mechanism

Type MC handle mechanisms are linear drive, fixed depth mechanisms designed for through-door mounting in standardized or shallow depth enclosures such as motor control centers or enclosed circuit breakers.

Mounting directly to the front of the disconnect, these mechanisms provide positive operation and handle indication. Both disconnect and mechanism mount simultaneously with mounting hardware supplied with the mechanism.

For security, the handle can be padlocked in the OFF position with up to three 0.375-inch hasp padlocks. Also, the mechanism is interlocked with the enclosure door so that the disconnect must be OFF before the door can be opened. A defeater is provided to bypass this interlock.

Catalog numbers listed include the mechanism, mounting hardware and door interlock clip.



Type MC Motor Control Catalog Numbers

Handle Mechanism ^① For Use With	Catalog Number ^{②③}	
	Type 1 Enclosure	Type 12 Enclosure
Series C F-Frame HMCP F	SMCU150FD	CMCU150FD
EB, EHB, FB, HFB breakers and MCP (Size 0–4)	SMCU150FD	CMCU150FD
FB TRI-PAC	SMCU100FBP	CMCU100FBP
FCL breakers	SMCU100FCL	CMCU100FCL
30, 60, 100A DS switch fusible, non-fusible	SMCU100DS	CMCU100DS
200A DS switch fusible, non-fusible	SMCU200DS	CMCU200DS
Series C J-Frame HMCP J	SMCU250JD	CMCU250JD
Series C K-Frame HMCP K, DA, JA, KA, HKA, LB, LBB, HLB Breakers, Size 5 MCP (400A)	SMCU400KD	CMCU400KD
Series C L-Frame HMCP L, MDL	SMCU600LD	CMCU600LD
Series C M-Frame not MDL	SMCU800MA	CMCU800MA
LAB, LA, HLA, LC, HLC breakers (400 and 600A frame)	SMCU400LA	SMCU400LA
LA TRI-PAC	SMCU400LAP	SMCU400LAP
MA, HMA, MC, HMC Breakers (800A frame)	SMCU800MA	SMCU800MA
NB, HNB, NC, HNC Breakers (1200A frame)	SMCU1200NB	SMCU1200NB
LCL225 and 400	SMCU400LCL	SMCU400LCL
Series C L-Frame HMCP L	SMCU600LD	SMCU600LD

Further Information

Publication Number	Description
IL 14572	F-Frame, EB, EHB, FB, MCP, HFB
IL 29C273	J- and K-Frame
IL 29C283	L-Frame
IL 14571	FB-P
IL 14938	JB, KB
IL 14573	30, 60, 100A DS switch
IL 14574	200A DS switch

Notes

- ① Mechanisms are shown mounted on breaker for illustration purposes only. Breakers are not included.
- ② These mechanisms are recognized under the component program of Underwriters Laboratories.
- ③ Selection data for handle mechanism only; circuit breaker not included.

AMT Vari-Depth

Fixed Width Type—Type AMT for Below Handle Mounting



3

Breaker or Switch Type	Complete Assembly ^{①②} Catalog Number	Backplate and Yoke Assembly Catalog Number	Rod and Brace Assembly Catalog Number	Pivot Mechanism Assembly Catalog Number	Operating Handle Assembly Catalog Number
Below the Handle—Fixed Width—with Short Brace and/or Rod as Listed (For all enclosures including Hoffman A-25 Enclosures)					
Series C F-Frame HMCP F ^③	AMTFDBSFH	AMTFD-B	AMTR	AMTPM-FH	AMTOP
Series C J-Frame HMCP J ^③	AMTJDBSFH	AMTKB-B	AMTRB1	AMTPM-FSH	AMTOP
Series C K-Frame HMCP K ^③	AMTKDBSFH	AMTLB-B	AMTRB1	AMTPM-FSH	AMTOP
Series C L-Frame HMCP L ^③	AMTLDBSFH	AMTLD-B	AMTRB1	AMTPM-FS	AMTOP
DS-30, 60, 100 unfused	AMTDSBSFH	AMTDS100-B	AMTR	AMTPM-FH	AMTOP
DS-30, 60, 100 fused ^④	AMTDSFBSFH	AMTDS100F-B	AMTR	AMTPM-FH	AMTOP
DS-30, 60, 100 fused ^⑤	AMTDSF1BSFH	AMTDS100F1-B	AMTR	AMTPM-FH	AMTOP
DS-200 unfused	AMTDS2BSFH	AMTDS200-B	AMTRB1	AMTPM-FSH	AMTOP
DS-200 fused	AMTDS2FBSFH	AMTDS200F-B	AMTRB1	AMTPM-FSH	AMTOP
Below the Handle—Fixed Width—with Short Brace and/or Rod as Listed (Not for use with Hoffman A-25 Enclosures)					
EB, EHB, FB, HFB, MCP (0-4)	AMTFBBSF	AMTFD-B	AMTR	AMTPM-F	AMTOP
JB, KB, MCP (250A)	AMTKBBSF	AMTKB-B	AMTRB1	AMTPM-FS	AMTOP
JA, KA, HKA, LB, LBB, HLB, DA MCP (400A)	AMTLBBSF	AMTLB-B	AMTRB1	AMTPM-FS	AMTOP
FB TRI-PAC, FCL	AMTFBPBSF	AMTFBP-B	AMTR	AMTPM-F	AMTOP
Optional rod and brace ^⑥					
AMTRB2 long rod and brace					
AMTRB3 extended rod and brace					

Standard Door Hardware ^{⑦⑧}

Catalog Number

DH1R

DH2R

DH3R

Door Hardware Adapter Kit ^⑨

Catalog Number

AMTDHA

Door Hardware Kit for Hoffman A-25 Enclosure ^{⑩⑪}

Catalog Number

HDH-2R ^⑫

HDH-3R ^⑬

Further Information

Publication Number	Description
IL 29C277	AMT Vari-Depth Handle Mechanism

Notes

- AMTR is rod only; AMTRI is rod and brace assembly.
- Complete assembly not available, order components parts listed above.
- Also for use with equivalent HMCP Frame.
- For switches using 30, 60, 100A, 600V NEC Class H, R or J fuses.
- For switches using 30, 60, 100A, 250V NEC Class H or R fuses.
- AMTR and AMTRB1 for use with enclosure depth of 6.50–14.25 inches. For 12.25–18.25 inch depth, use optional AMTRB2. For 18.00–24.00 inch depth, use optional AMTRB3.

- Requires adapter kit shown in Door Hardware Adapter Kit table.
- For standard door hardware description, see **Page V12-T3-102**.
- Required on standard door hardware only when used with any AMT handle mechanisms.
- Kit consists of special door hardware and door interlock pin. Available for right-hand flange mounting only.
- For use with AMT fixed width mechanisms only.
- 2-point latch for use with panels up to approximately 40.00 inches high.
- 3-point latch for use with panels approximately 40.00 inches and higher.

AMT Vari-Depth Vari-Width Type— Type AMT for Above Handle Mounting

The Type AMT is an extra heavy-duty handle mechanism designed for mounting in flange-type enclosures, and has provisions for mounting in various depth enclosures and for varying the width relationship between the disconnect device and the external handle.

A door interlock is provided to prevent opening the enclosure door with the disconnect in the ON position or to close the disconnect with the enclosure door open. The external handle can be locked in the OFF position with up to three padlocks. The AMT mechanism is supplied for mounting in right-hand flange enclosures but can be easily converted for left-hand mounting.

AMT mechanisms are available for above the handle mounting or below the handle mounting. Mechanisms for below the handle mounting are also available as fixed width units. When door hardware is used with an AMT handle mechanism, a door hardware adapter kit is required.

Accessories

Spacer kit to Vari-Width (not for use with fixed mechanisms) catalog number AMTSK1 for up to 1.00-inch variation.

Note: This spacer kit is for up to 1.00-inch variation and consists of multiples of thin spacers to be used as required. A maximum of two kits per installation may be used. Due to the possible variation in dimensions, hardware is not supplied. Use standard 1/4–20 bolts.

Further Information

Pub. Number	Description
IL 14946	AMT Vari-Depth handle mechanism

MD, MSM Vari-Width Type— Type AMT for Above Handle Mounting



Breaker or Switch Type	Complete Assembly ^{①②} Catalog Number	Backplate and Yoke Assembly Catalog Number	Operating Rod and Brace Assembly Catalog Number	Flange Mounted Pivot Mechanism Assembly ^{③④} Catalog Number	External Operating Handle Catalog Number
Above the Handle Mounting with Short Rod and Brace					
Series C F-Frame ^⑤ EB, EHB, FB, HFB, MCP (0–4)	AMTFDASV	AMTFB	AMTRB1	AMTPM	AMTOP
Series C J-Frame ^⑤	AMTJDASV	AMTJD	AMTRB1	AMTPM	AMTOP
Series C K-Frame ^⑤	AMTKDASV	AMTKD	AMTRB1	AMTPM	AMTOP
Series C L-Frame, MDL ^⑤	AMTLDASV	AMTLD	AMTRB1	AMTPM	AMTOP
JA, KA, HKA, LB, LBB, HLB, DA, MCP (400A)	AMTLBASV	AMTLB	AMTRB1	AMTPM	AMTOP
LA, HLA, LC, HLC	AMTLAASV	AMTLA	AMTRB1	AMTPM	AMTOP
MD, MDS, MA, HMA, MC, HMC, Series C M-Frame, LCL	AMTMAASV	AMTMA	AMTRB1	AMTPM	AMTOP
NB, HNB, NC, HNC	AMTNBASV	AMTNB	AMTRB1	AMTPMNB	AMTOP
FB TRI-PAC, FCL	AMTFBASV	AMTFB	AMTRB1	AMTPM	AMTOP
LA TRI-PAC	AMTLAPASV	AMTLAP	AMTRB1	AMTPM	AMTOP
NB TRI-PAC	AMTNBPASV	AMTNBP	AMTRB1	AMTPMNB	AMTOP
DS-30, 60, 100 unfused	AMTDSASV	AMTDS100	AMTRB1	AMTPM	AMTOP
DS-30, 60, 100 fused ^⑥	AMTDSFASV	AMTDS100F	AMTRB1	AMTPM	AMTOP
DS-30, 60, 100 fused ^⑦	AMTDSF1ASV	AMTDS100F1	AMTRB1	AMTPM	AMTOP
DS-200 unfused	AMTDS2ASV	AMTDS200	AMTRB1	AMTPM	AMTOP
DS-200 fused	AMTDS2FASV	AMTDS200F	AMTRB1	AMTPM	AMTOP
Above the Handle Mounting with Long Rod and Brace					
Series C F-Frame ^⑤ EB, EHB, FB, HFB, MCP (0–4)	AMTFDALV	AMTFB	AMTRB2	AMTPM	AMTOP
Series C J-Frame ^⑤	AMTJDALV	AMTJD	AMTRB2	AMTPM	AMTOP
Series C K-Frame ^⑤	AMTKDALV	AMTKD	AMTRB2	AMTPM	AMTOP
Series C L-Frame, MDL ^⑤	AMTLDALV	AMTLD	AMTRB2	AMTPM	AMTOP
JA, KA, HKA, LB, LBB, HLB, DA, MCP (400A)	AMTLBALV	AMTLB	AMTRB2	AMTPM	AMTOP
LA, HLA, LC, HLC	AMTLAALV	AMTLA	AMTRB2	AMTPM	AMTOP
MD, MDS, MA, HMA, MC, HMC, Series C M-Frame, LCL	AMTMAALV	AMTMA	AMTRB2	AMTPM	AMTOP
NB, HNB, NC, HNC	AMTNBALV	AMTNB	AMTRB2	AMTPMNB	AMTOP
FB TRI-PAC, FCL	AMTFBALV	AMTFB	AMTRB2	AMTPM	AMTOP
LA TRI-PAC	AMTLAPALV	AMTLAP	AMTRB2	AMTPM	AMTOP
NB TRI-PAC	AMTNBPALV	AMTNBP	AMTRB2	AMTPMNB	AMTOP
DS-30, 60, 100 unfused	AMTDSALV	AMTDS100	AMTRB2	AMTPM	AMTOP
DS-30, 60, 100 fused ^⑥	AMTDSFALV	AMTDS100F	AMTRB2	AMTPM	AMTOP
DS-30, 60, 100 fused ^⑦	AMTDSF1ALV	AMTDS100F1	AMTRB2	AMTPM	AMTOP
DS-200 unfused	AMTDS2ALV	AMTDS200	AMTRB2	AMTPM	AMTOP
DS-200 fused	AMTDS2FALV	AMTDS200F	AMTRB2	AMTPM	AMTOP

Notes

- ① Assembled Type AMT for above handle mounting (breaker not included).
- ② Complete assembly not available, order components parts listed above.
- ③ Width spacer kit not included.

- ④ This spacer kit is for up to 1.00-inch variation and consists of multiples of thin spacers to be used as required. A maximum of two kits per installation may be used. Due to the possible variation in dimensions, hardware is not supplied. Use standard 1/4–20 bolts.

- ⑤ Also for use with equivalent HMCP frame.
- ⑥ For switches using 30, 60, 100A, 600V NEC Class H, R or J fuses.
- ⑦ For switches using 30, 60, 100A, 600V NEC Class H or R fuses.

Vari-Width Type—Type AMT for Below Handle Mounting



3

Breaker or Switch Type	Complete Assembly ^{①②} Catalog Number	Backplate and Yoke Assembly Catalog Number	Rod and Brace Assembly Catalog Number	Flange Mounted Pivot Mechanism Assembly ^{③④} Catalog Number	External Operating Handle Assembly Catalog Number
Below the Handle Mounting with Short Rod and Brace					
Series C F-Frame ^⑤ EB, EHB, FB, HFB, MCP (0–4)	AMTFDBSV	AMTFD-B	AMTRB1	AMTPM-B	AMTOP
Series C J-Frame ^⑤	AMTJDBSV	AMTJD-B	AMTRB1	AMTPM-B	AMTOP
Series C K-Frame ^⑤	AMTKDBSV	AMTKD-B	AMTRB1	AMTPM-B	AMTOP
Series C L-Frame MDL ^⑤	AMTLDBSV	AMTLD-B	AMTRB1	AMTPM-B	AMTOP
JA, KA, HKA, LB, LBB, HLB, DA, MCP (400A)	AMTLBBSV	AMTLB-B	AMTRB1	AMTPM-B	AMTOP
LA, HLA, LC, HLC	AMTLABSV	AMTLA-B	AMTRB1	AMTPM-B	AMTOP
MD, MDS, MA, HMA, MC, HMC, Series C M-Frame, LCL	AMTMABSV	AMTMA-B	AMTRB1	AMTPM-B	AMTOP
NB, HNB, NC, HNC	AMTNBSV	AMTNB-B	AMTRB1	AMTPM-B	AMTOP
FB TRI-PAC, FCL	AMTFBPSV	AMTFBP-B	AMTRB1	AMTPM-B	AMTOP
LA TRI-PAC	AMTLAPSV	AMTLAP-B	AMTRB1	AMTPM-B	AMTOP
NB TRI-PAC	AMTNBPSV	AMTNBP-B	AMTRB1	AMTPM-B	AMTOP
DS-30, 60, 100 unfused	AMTDSBSV	AMTDS100-B	AMTRB1	AMTPM-B	AMTOP
DS-30, 60, 100 fused ^⑥	AMTDSFBSV	AMTDS100F-B	AMTRB1	AMTPM-B	AMTOP
DS-30, 60, 100 fused ^⑦	AMTDSF1BSV	AMTDS100F1-B	AMTRB1	AMTPM-B	AMTOP
DS-200 unfused	AMTDS2BSV	AMTDS200-B	AMTRB1	AMTPM-B	AMTOP
DS-200 fused	AMTDS2FBSV	AMTDS200F-B	AMTRB1	AMTPM-B	AMTOP
Below the Handle Mounting with Long Rod and Brace					
Series C F-Frame ^⑤ EB, EHB, FB, HFB, MCP (0–4)	AMTFDBLV	AMTFD-B	AMTRB2	AMTPM-B	AMTOP
Series C J-Frame ^⑤	AMTJDBLV	AMTJD-B	AMTRB2	AMTPM-B	AMTOP
Series C K-Frame ^⑤	AMTKDBLV	AMTKD-B	AMTRB2	AMTPM-B	AMTOP
Series C L-Frame MDL ^⑤	AMTLDBLV	AMTLD-B	AMTRB2	AMTPM-B	AMTOP
JA, KA, HKA, LB, LBB, HLB, DA, MCP (400A)	AMTLBBLV	AMTLB-B	AMTRB2	AMTPM-B	AMTOP
LA, HLA, LC, HLC	AMTLABLV	AMTLA-B	AMTRB2	AMTPM-B	AMTOP
MD, MDS, MA, HMA, MC, HMC, Series C M-Frame, LCL	AMTMABLV	AMTMA-B	AMTRB2	AMTPM-B	AMTOP
NB, HNB, NC, HNC	AMTNBBLV	AMTNB-B	AMTRB2	AMTPM-B	AMTOP
FB TRI-PAC, FCL	AMTFBPBLV	AMTFBP-B	AMTRB2	AMTPM-B	AMTOP
LA TRI-PAC	AMTLAPBLV	AMTLAP-B	AMTRB2	AMTPM-B	AMTOP
NB TRI-PAC	AMTNBPBLV	AMTNBP-B	AMTRB2	AMTPM-B	AMTOP
DS-30, 60, 100 unfused	AMTDSBLV	AMTDS100-B	AMTRB2	AMTPM-B	AMTOP
DS-30, 60, 100 fused ^⑥	AMTDSFBLV	AMTDS100F-B	AMTRB2	AMTPM-B	AMTOP
DS-30, 60, 100 fused ^⑦	AMTDSF1BLV	AMTDS100F1-B	AMTRB2	AMTPM-B	AMTOP
DS-200 unfused	AMTDS2BLV	AMTDS200-B	AMTRB2	AMTPM-B	AMTOP
DS-200 fused	AMTDS2FBLV	AMTDS200F-B	AMTRB2	AMTPM-B	AMTOP

Notes

- ① AMTR is rod only; AMTRI is rod and brace assembly.
- ② Complete assembly not available, order components parts listed above.
- ③ Width spacer kit not included.
- ④ This spacer kit is for up to 1-inch variation and consists of multiples of thin spacers to be used as required. A maximum of two kits per installation may be used. Due to the possible variation in dimensions, hardware is not supplied. Use standard 1/4–20 bolts.
- ⑤ Also for use with equivalent HMCP Frame.
- ⑥ For switches using 30, 60, 100A, 600V NEC Class H, R or J fuses.
- ⑦ For switches using 30, 60, 100A, 600V NEC Class H or R fuses.

Accessories

Spacer kit for Vari-Width (not for use with fixed mechanisms) catalog number AMTSK1 for up to 1.00-inch variation.

Note: This spacer kit is for up to 1.00-inch variation and consists of multiples of thin spacers to be used as required. A maximum of two kits per installation may be used. Due to the possible variation in dimensions, hardware is not supplied. Use standard 1/4–20 bolts.

Ordering Information

- Complete assembly not available, order components parts as listed on **Pages V12-T3-104, V12-T3-105 and V12-T3-106**
- Order spacer kits or door hardware adapter as required
- Individual component parts may be ordered by catalog number

Flex Shaft

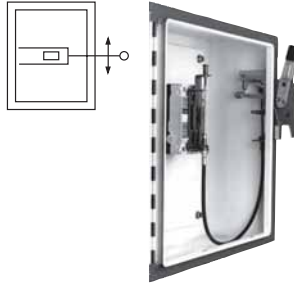

Flex Shaft

The Flex Shaft is an extra heavy-duty mechanism that includes a flexible shaft in various lengths, 3 feet (0.9m)

through 10 feet (3m) for use with various size enclosures.

The Flex Shaft handle will accept up to three padlock shackles, each with a maximum diameter of 0.375-inch (9.5 mm). Can be used with Type 1, 3R and 12 fabricated enclosures. An optional handle is available for Flex Shaft that is suitable for use with Type 4 and 4X environments. Flex Shaft comes preset from the factory, requiring only minor field adjustments on installation, which takes about 10 minutes—

a significant time savings compared to installation of other types of flange handle mechanisms. The Flex Shaft mechanism also takes up less interior enclosure space than competitive designs and the handle fits standard flange cutouts. Flex Shaft handle can be remotely mounted from breaker, where an operator can use it by “funneling” the cable through conduit.

Flex Shaft is UL Listed under File E64983 and meets CSA requirements.

Flex Shaft Ordering Information (Three-Pole Only) ①②③

Breaker Frame	Flexible Shaft Length in Feet (m)							
	3.00 (0.9)	4.00 (1.2)	5.00 (1.5)	6.00 (1.8)	7.00 (2.1)	8.00 (2.4)	9.00 (2.7)	10.00 (3.0)
E125	EHMFS03	EHMFS04	EHMFS05	EHMFS06	—	—	—	—
J250	JHMFS03	JHMFS04	JHMFS05	JHMFS06	JHMFS07	JHMFS08	JHMFS09	JHMFS10
G	F0S03C	F0S04C	F0S05C	F0S06C	—	—	—	—
F	F1S03C	F1S04C	F1S05C	F1S06C	F1S07C	F1S08C	F1S09C	F1S10C
F (Dual)	F1S03CD	F1S04CD	F1S05CD	F1S06CD	F1S07CD	F1S08CD	F1S09CD	F1S10CD
J	F2S03C	F2S04C	F2S05C	F2S06C	F2S07C	F2S08C	F2S09C	F2S10C
K	F3S03C	F3S04C	F3S05C	F3S06C	F3S07C	F3S08C	F3S09C	F3S10C
L and MDL	—	F4S04C	F4S05C	F4S06C	—	—	—	F4S10C
N	—	F5S04C	F5S05C	F5S06C	—	—	—	F5S10C
R	—	F6S04	F6S05	F6S06	—	—	—	—
MD	—	F7S04C	F7S05C	F7S06C	—	—	—	F7S10C

Flex Shaft Accessories (F- through R-Frame)

NEMA 12 Safety Door Hardware for Flex Shaft ④

Handle Length in Inches (mm)	Catalog Number ⑤
4.00 (101.6)	C361KJ4
6.00 (152.4)	C361KJ6
Roller latch ⑥	C361KR

Notes

- Type 4/4X handle mechanisms are available. Add Suffix **X** to complete catalog number. Add Suffix **I** to complete catalog number for IEC handle. Add Suffix **L** (Standard on F, J, K and L) to complete catalog number for 6.00-inch (152.4 mm) handle. Original narrow handle design (no **C** suffix) is available. Remove **C** from catalog number.
- When selecting the length of shaft, ensure minimum bending radius of 4.00 inches (101.6 mm) is maintained to operate properly. The standard method of shipment includes the mechanism preset at the factory; however, minor field adjustments may be required.

- Dual breakers operator available on F-Frame only.
- Customer: Consult with box manufacturer for correct door hardware and any adapters required for assembly.
- The 0.25 inch x 0.50 inch (6.35 x 12.7 mm) standard mill rectangular locking bar is not supplied with these kits.
- Third roller latch for use with 4.00- or 6.00-inch (101.6 or 152.4 mm) handle when 3-point latching is required.

Refer to handle mechanisms in the molded-case circuit breaker section of Volume 4—Circuit Protection Catalog, CA08100005E, Tab 2.

The Type C371 circuit breaker operating mechanisms are designed for installation in control enclosures where main or branch circuit protective devices are required. All circuit breaker mechanisms are suitable for right-hand mounting.

Auxiliary contacts are not available for mounting on operating mechanisms. Where required, have them installed in circuit breaker.

Type C371 is UL Listed under File E62635.

Type C371 Ordering Information—Dimensions in Inches (mm)

Circuit Breaker or Motor Circuit Protector	Frame Size	Variable Depth Mounting Range Min./Max. ①②	Operating Mechanism Only ③ Catalog Number	Operating Mechanism With 4.00-Inch Handle	
				For Type 1–12 Enclosure Catalog Number	For Type 4 Enclosure Catalog Number
HMCP and Series C EHD, FDB, FD, FDC, HFD, ED	150	6.50–16.0 (165.1–406.4)	C371E	C371E1	C371E2
HMCP and Series C HJD, JD, JDB, JDC	250	6.50–16.63 (165.1–422.4)	C371F	C371F5	C371F6
HMCP and Series C DK, HKD, KD, KDB	400	6.50–16.63 (165.1–422.4)	C371F	C371F5	C371F6
Series C HLD, LD, LDC	600	8.50–22.00 (215.9–558.8)	C371G	C371G5	C371G6
Series C MD, MDS	800	8.75–22.00 (222.3–558.8)	C371K	C371K5	C371K6
Series C HND, ND, NDC	1200	9.75–22.00 (247.7–558.8)	C371K	C371K5	C371K6

Handle Only—Dimensions in Inches (mm)

Circuit Breaker Frame Size (Amperes)	NEMA Enclosure Type	Operating Handle Length	Catalog Number
150	1, 3R, 3, 12	4.00 (101.6)	C371H1
	4/4X	4.00 (101.6)	C371H2
	1, 3R, 3, 12	4.00 (101.6)	C371H3
	4/4X	4.00 (101.6)	C371H4
250–1200	1, 3R, 3, 12	4.00 (101.6)	C371H5
	4/4X	4.00 (101.6)	C371H6
	1, 3R, 3, 12	4.00 (101.6)	C371H7
	4/4X	4.00 (101.6)	C371H8

Channel Support Kit (Rod Not Supplied) ④

Catalog Number

C371CS6

Connecting Rods ⑤

Application	Catalog Number
Disconnect switches (30, 60, 100, 200A sizes)	C371CS1
Circuit breakers (150, 250, 400A sizes)	C371CS1
Circuit breakers (600, 800, 1200A sizes)	C371CS2

Flange-Mounted Instruction Leaflets

Breaker Frame Instruction Leaflet Number

Flex Shaft

E125	IL0510TE0002
J250	IL0510TE0005
G	TBD
F	15609
J	15605
K	15604
L and M	15606
N	15606
R	15606

Notes

- ① For increased maximum allowable depth, see connecting rods table to the left.
- ② Dimensions shown are from panel flange surface.
- ③ Does not include handle.
- ④ For use to prevent bending of the operating handle mounting surface. This is especially useful when the operating handle is mounted on a channel in a multi-door enclosure. Included in 600–1200A.
- ⑤ Increase maximum allowable depth by 5.00 inches (127.0 mm).

Refer to handle mechanisms in the molded-case circuit breaker section of Volume 4—Circuit Protection Catalog, CA08100005E, Tab 2.

Series C Rotary and Universal Rotary



Series C Rotary

Series C rotary and universal rotary handle mechanisms are for use with molded-case circuit breakers (G, F, J, K, L, MDL), molded-case switches and motor circuit protectors.

Series C rotary is suitable for use with Type 1, 3R, 12 and 4/4X enclosure types. Type 4/4X application requires special handle, see "Ordering Information."

The universal rotary is suitable for use with Type 1 and 12 enclosure types. All rotary handle mechanisms include a handle "Lock Off," to prevent turning the breaker ON while in the OFF position. All rotary handles indicate ON/OFF/Tripped/Reset positions; however, Universal Rotary has the added feature of international markings for ON (I) and OFF (O). Series C rotary handle is metal. Universal rotary is made of molded material. Series C rotary handle is black and universal rotary is available in black or yellow/red.

Series C rotary handle was ergonomically designed with extra clearance for a "gloved hand" to operate. Handle has a 45° rotation. Universal Rotary has a 90° rotation ("pipe valve" operation) where ON is vertical and OFF is horizontal. Shafts include a support brace to ensure proper alignment.

In addition, the 16.00-inch (406.4 mm) and 24.00-inch (609.6 mm) extra long shafts include an adjustable support bracket.

Series C rotary and universal rotary, are UL Listed and meet CSA requirements. Universal rotary also meets IEC947-1/2 for international compliance. Rotary UL File Number is E64983.

Series C Rotary Ordering Information

Shaft Length Inches (mm)	Complete Catalog Number ①	Separate Catalog Number		Shaft ④	Catalog Number	
		Standard Handle ②	Breaker Mechanism ③		IEC IP65 ⑤⑥	IEC IP66 ⑤⑥
F-Frame						
6.00 (152.4)	HM1R06	6648C22G01	6648C23G11	4217B37G04	WHM1R06	WHM1R06X
12.00 (304.8)	HM1R12	6648C22G01	6648C23G11	4217B37G01	WHM1R12	WHM1R12X
16.00 (406.4)	HM1R16	6648C22G01	6648C23G11	4217B37G02	WHM1R16	WHM1R16X
24.00 (609.6)	HM1R24	6648C22G01	6648C23G11	4217B37G03	WHM1R24	WHM1R24X
J-Frame						
6.00 (152.4)	HM2R06	6648C22G01	6648C23G21	4217B37G04	WHM2R06	WHM2R06X
12.00 (304.8)	HM2R12	6648C22G01	6648C23G21	4217B37G01	WHM2R12	WHM2R12X
16.00 (406.4)	HM2R16	6648C22G01	6648C23G21	4217B37G02	WHM2R16	WHM2R16X
24.00 (609.6)	HM2R24	6648C22G01	6648C23G21	4217B37G03	WHM2R24	WHM2R24X
K-Frame						
6.00 (152.4)	HM3R06	6648C22G01	6648C23G25	4217B37G04	WHM3R06	WHM3R06X
12.00 (304.8)	HM3R12	6648C22G01	6648C23G25	4217B37G01	WHM3R12	WHM3R12X
16.00 (406.4)	HM3R16	6648C22G01	6648C23G25	4217B37G02	WHM3R16	WHM3R16X
24.00 (609.6)	HM3R24	6648C22G01	6648C23G25	4217B37G03	WHM3R24	WHM3R24X
L- and MDL-Frame						
6.00 (152.4)	HM4R06	6648C22G11	6648C23G19	4217B37G04	WHM4R06	WHM4R06X
12.00 (304.8)	HM4R12	6648C22G11	6648C23G19	4217B37G01	WHM4R12	WHM4R12X
16.00 (406.4)	HM4R16	6648C22G11	6648C23G19	4217B37G02	WHM4R16	WHM4R16X
24.00 (609.6)	HM4R24	6648C22G11	6648C23G19	4217B37G03	WHM4R24	WHM4R24X
MD/MDS						
6.00 (152.4)	HM7R06	6648C22G21	6648C23G17	4217B37G04	—	—
12.00 (304.8)	HM7R12	6648C22G21	6648C23G17	4217B37G01	—	—
16.00 (406.4)	HM7R16	6648C22G21	6648C23G17	4217B37G02	—	—
24.00 (609.6)	HM7R24	6648C22G21	6648C23G17	4217B37G03	—	—
N-Frame						
6.00 (152.4)	HM5R06	6648C22G21	6648C23G08	4217B37G04	WHM5R06	WHM5R06X
12.00 (304.8)	HM5R12	6648C22G21	6648C23G08	4217B37G01	WHM5R12	WHM5R12X
16.00 (406.4)	HM5R16	6648C22G21	6648C23G08	4217B37G02	WHM5R16	WHM5R16X
24.00 (609.6)	HM5R24	6648C22G21	6648C23G08	4217B37G03	WHM5R24	WHM5R24X

Notes

- ① Complete catalog number includes the standard handle, mechanism, shaft and support brace/bracket.
- ② Handle is designed suitable for Types 1, 3R and 12 enclosures. Use style number **6648C22G03** for Type 4/4X handle or add **X** Suffix to complete catalog number.
- ③ Breaker mechanism includes a shaft support bracket and its parts.
- ④ Longer shafts, 16.00-inch (406.4 mm) and 24.00-inch (609.6 mm), include an adjustable support extension.
- ⑤ IEC handle mechanism supplied with metric thread mounting hardware.
- ⑥ Complete catalog number includes a handle, mechanism and shaft.

Refer to handle mechanisms in the molded-case circuit breaker section of Volume 4—Circuit Protection Catalog, CA08100005E, Tab 2.

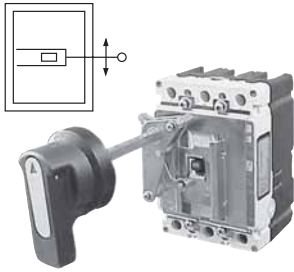
Universal Rotary**Universal Rotary**

Type 4/4X handles are similar to standard handles except that they include an internal neoprene gasket. Type 4/4X handle style number is 6648C22G03. Due to gasketing effect between the handle and the housing, the handle may not indicate a tripped position.

Series C Rotary Accessories

As an option, an auxiliary switch is offered so that the control panel builder may electrically indicate the status of the breaker. This accessory would be mounted on the mechanism and comes with 24.00-inch (609.6 mm) pigtail leads.

Series C Auxiliary Switch**Catalog Number****5108A61G01****Universal Rotary Ordering Information**

Shaft Length in Inches (mm)	Handle Color	Complete Catalog Number
E125 Frame		
6.00 (152.4)	Black	EHMVD06B
12.00 (304.8)	Black	EHMVD12B
6.00 (152.4)	Red	EHMVD06R
12.00 (304.8)	Red	EHMVD12R
J250 Frame		
6.00 (152.4)	Black	FJHMVD06B
12.00 (304.8)	Black	FJHMVD12B
6.00 (152.4)	Red	FJHMVD06R
12.00 (304.8)	Red	FJHMVD12R
G-Frame		
6.00 (152.4)	Black	GHMVD06B
12.00 (304.8)	Black	GHMVD12B
6.00 (152.4)	Red	GHMVD06R
12.00 (304.8)	Red	GHMVD12R
F-Frame		
6.00 (152.4)	Black	FHMVD06B
12.00 (304.8)	Black	FHMVD12B
6.00 (152.4)	Red	FHMVD06R
12.00 (304.8)	Red	FHMVD12R
J-Frame		
6.00 (152.4)	Black	JHMVD06B
12.00 (304.8)	Black	JHMVD12B
6.00 (152.4)	Red	JHMVD06R
12.00 (304.8)	Red	JHMVD12R
K-Frame		
6.00 (152.4)	Black	KHMVD06B
12.00 (304.8)	Black	KHMVD12B
6.00 (152.4)	Red	KHMVD06R
12.00 (304.8)	Red	KHMVD12R
L- and MDL-Frames		
6.00 (152.4)	Black	LHMVD06B
12.00 (304.8)	Black	LHMVD12B
6.00 (152.4)	Red	LHMVD06R
12.00 (304.8)	Red	LHMVD12R

Through-the-Door Instruction Leaflets Number

Breaker Frame	Series C Rotary	Universal Rotary
E125	—	IL0510TE0001
J250	—	IL0510TE0001
G	—	29C250
F	15594	29C250
J	15599	29C250
K	15600	29C250
L and MDL	15601	29C250
N	15602	—

Note: Refer to handle mechanisms in the molded-case circuit breaker section of Volume 4—Circuit Protection Catalog, CA08100005E, Tab 2.

Direct (Close-Coupled) Handle Mechanisms



Universal Direct



Euro IEC Direct



G Direct

Direct (close-coupled) handle mechanisms mount directly to the circuit breaker. They are used in shallow enclosures where the standard variable depth through-the-door type mechanism is not practical or cannot be used. They are typically for applications where high volume, standardized enclosures are being fabricated.

The Universal Direct handle mechanism is designed exclusively for the new Cutler-Hammer E125 and J250 circuit breakers. It is available as standard with a door interlock to prevent opening the enclosure while the circuit breaker is in the ON position. It is also available without a door interlock.

The Euro IEC Direct handle mechanism can be used on F- through R-Frames.

The G Direct is available with a black or a yellow handle, and with or without a shroud. It is suitable for use with Type 1 enclosures. It is for use only with the G-Frame (GD, GC, GHC, GMCP).

An escutcheon ring and an interlock clip are provided as standard. The standard design includes a lock-off feature.

The Universal Direct handle mechanism is UL 489 Listed, IEC947-1/2 and meets CSA requirements. The Euro IEC Direct handle mechanism is IEC-240-1. G Direct is UL Listed and meets CSA requirements.

Universal Direct Ordering Information

Frame	Universal Direct Domestic		International
	With Interlock (White) Catalog Number	Without Interlock (White) Catalog Number	Without Interlock (Charcoal With Global Label) Catalog Number
E125	EHMCCBI	EHMCCB	EHMCCR
J250	JHMCCBI	JHMCCB	JHMCCR

Euro IEC Direct Ordering Information

Frame	Black Handle Catalog Number	Red Handle Catalog Number
F	HMCC1B	HMCC1R
J	HMCC2B	HMCC2R
K	HMCC3B	HMCC3R
L and M	HMCC4B	HMCC4R
N	HMCC5B	HMCC5R
R	HMCC6B	HMCC6R

G Direct Ordering Information ^①

Frame	Black Handle		Yellow Handle	
	With Shroud Catalog Number	Without Shroud Catalog Number	With Shroud Catalog Number	Without Shroud Catalog Number
GD/GHC	HRGCC1S	HRGCC10	HRGCC3S	HRGCC30
GMCP	HRGMC1S	HRGMC10	HRGMC3S	HRGMC30

Direct (Close-Coupled) Instruction Leaflets

Frame	Instruction Leaflet Number		
	Universal Direct	Euro IEC Direct	G Direct
E125	29C255	—	—
J250	29C256	—	—
G	—	—	15567
F	—	29C288A	—
J	—	29C288A	—
K	—	29C288A	—
L and MDL	—	29C289	—
N	—	29C290	—
R	—	29C291	—

Notes

^① Suitable for use on two- or three-pole G-Frame.

Refer to handle mechanisms in the molded-case circuit breaker section of Volume 4—Circuit Protection Catalog, CA08100005E, Tab 2.

Handle Extensions**Handle Extension**

Handle extension is not included with J-, K-, L- and M-Frame breakers. It must be purchased separately.

Handle Extension

Frame	Style Number
J, K	HEX3
L, M	HEX4

Handle extension is included with breaker with N- and R-Frame breakers.

Handle Extension

Frame	Style Number
N	HEX5
R	HEX6

Note: Refer to handle mechanisms in the molded-case circuit breaker section of Volume 4—Circuit Protection Catalog, CA08100005E, Tab 2.

Replacement and Service Capabilities**Breaker Service Center Factory Service for Mining and Industrial Molded-Case Circuit Breakers**

Eaton owns and operates two fully authorized Breaker Service Centers (BSC) in Skelton, WV, and Evansville, IN. They are available to support all non-warranty service needs for Cutler-Hammer industrial molded-case breakers 600A and above and all frames of mining duty breakers.

The Breaker Service Centers, as extensions of our manufacturing plants, are the only facilities authorized to provide breaker service solutions for Eaton, Cutler-Hammer and historic Westinghouse molded-case circuit breakers. Staff are dedicated to providing genuine factory-supported solutions to our customers.

This is just another example of how Eaton supports a complete offering of solutions for circuit breakers.

See the following for the benefits of choosing the BSC and our service offerings.

Offerings**Basic Tune-Up**

Clean, test and re-certify.

Basic Modification

Replace accessories and attachments including terminals, trip units, UVRs, shunt trips and auxiliary switches.

Basic Service

Replace components including covers, handles and stationary contacts.

Custom Service

Replace frame or trip unit, with or without accessories.

Full Service

Replace both frame and trip unit, with or without accessories.

Factory Modifications

For new or existing operational breakers

- Trip unit upgrades
- Addition of accessories and attachments
- UL modifications to factory-sealed breakers

Facilities

- Dedicated sites supported by engineering and manufacturing
- Staffed by factory trained technicians with experience servicing molded-case circuit breakers
- State-of-the-art cleaning and testing equipment

The Breaker Service Centers are open to help you. Give us a call at **1-877-BRK-SRVC** or contact your local Eaton authorized distributor or sales office for more information.

Know What You're Getting—Here's the Reality of Third-Party Repair

- Breakers are serviced using least worn, counterfeit or reverse engineered components
- You get no technical support from the original manufacturer
- There is no option for an upgrade to new technology
- You could end up with a breaker that doesn't perform as expected

Reasons to Use Eaton's Breaker Service Centers

- Eaton is a world leader in circuit breaker technology and manufacturing
- The Breaker Service Centers are staffed by factory trained technicians
- One year warranty.
- Eaton uses only genuine replacement parts and components
- Full engineering support—original product specifications and manufacturing data
- State-of-the-art cleaning equipment—uses a non-destructive cleaning process while maintaining integrity of the breaker
- Modern test equipment—the breaker service center uses the same hi-tech test equipment used by engineering, development and manufacturing facilities. This allows the breaker service center to match original test conditions at the factory
- Exchange option—we can upgrade to the newest technology
- Competitive price—all the benefits of third-party prices

For more information on Eaton products and services, call 1-877-386-2273. Select option 1 for technical support and select option 6 for Eaton's Electrical Services & Systems, or visit our website at www.eaton.com/electrical.

Cross-Reference

Westinghouse and Challenger

Cross-Reference for Cutler-Hammer Industrial MCB/MCCBs

Circuit Breaker Brand and Type

Westinghouse	Challenger	Cutler-Hammer
BAB	CBB	BAB
BAB-H	CBB-H	BAB-H
CA	CD	CA
CAH	CDH	CAH
CHKD	CKHC	CHKD
CHLD	CLHC	CHLD
CHND	CNHC	CHND
CKD	CKC	CKD
CKDC	CKVC	CKDC
CLD	CLC	CLD
CLDC	CLVC	CLDC
CND	CNC	CND
CNDC	CNVC	CNDC
CRD	CRC	CRD
CRDC	CRVC	CRDC
DK	CDK	DK
EB	—	EB
ED	CED	ED
EDC	CEV	EDC
EDH	CEH	EDH
EHB	—	EHB
EHD	CE	EHD
FB	—	FB
FB-P	CTB	FB-P
FCL	CXF	FCL
FD	CF	FD
FDB	CFS	FDB
FDC	CFV	FDC
GB	CG	GB
GC	CGL	GC
GDB	CGDB	GDB
GHB	CH	GHB
GHBS	CSCB	GHBS
GHC	CHL	GHC
HCA	CDT	HCA
HFB	—	HFB
HFD	CFH	HFD
HJD	CJH	HJD
HKB	—	HKB
HKD	CKH	HKD
HLA	—	HLA
HLC	CSHL	HLC
HLCC	CSHLC	HLCC
HLD	CLH	HLD
HMA	—	HMA

Circuit Breaker Brand and Type

Westinghouse	Challenger	Cutler-Hammer
HMC	CSHM	HMC
HMCC	CSHMC	HMCC
HNB	—	HNB
HNC	CSHN	HNC
HND	CNH	HND
JB, KB	—	JB, KB
JD	CJ	JD
JDB	CJS	JDB
JDC	CJV	JDC
KD	CK	KD
KDB	CKS	KDB
KDC	CKV	KDC
LA	—	LA
LA-P	CTL	LA-P
LC	CSL	LC
LCC	CSLC	LCC
LCL	CXL	LCL
LCY	CSLY	LCY
LD	CL	LD
LDB	CK	LDB
LDC	CLV	LDC
MA	—	MA
MC	CSM	MC
MCC	CSMC	MCC
MCY	CSMY	MCY
MDS	CSMD	MDS
MDSC	CSMDC	MDSC
MDSY	CSMDY	MDSY
NB	—	NB
NB-P	CTN	NB-P
NC	CSN	NC
NCY	CSNY	NCY
ND	CN	ND
NDC	CNV	NDC
PB-P	CTP	PB-P
PC	CSP	PC
PCC	CSPC	PCC
QBGF	CBBGF	QBGF
QBGFEP	CBBGFEP	QBGFEP
QBHGF	CBBHGF	QBHGF
QBHGFEP	CBBHGFEP	QBHGFEP
QBHW	CBBH	QBHW
QBHW-H	CBBH-H	QBHW-H
RD	CR	RD
RDC	CRV	RDC

Westinghouse, Challenger and Bryant**Cross-Reference for Cutler-Hammer Residential MCBs****Circuit Breaker Brand and Type**

Westinghouse	Challenger	Bryant	Cutler-Hammer
BR	C	BR	BR
BRD	A	BRD	BRD
BRH	HC	BRH	BRH
BRHH	VC	BRHH	BRHH
—	XC	—	BRX
BRO	C	BRO	BRO
GFCB	HAGF	GFCB	GFCB
GFCBH	HAGFH	GFCBH	GFCBH
GFEP	HAGFEP	GFEP	GFEP
GFEPH	HAGFEPH	GFEPH	GFEPH
—	CM	—	BW
—	CMH	—	BWH
—	CMV	—	BWHH
—	CB	—	CC
WFL	QFL	—	QFL
WFP	QFP	—	QFP

Notes for Replacement Breaker and Mining Breaker Replacement Tables (Pages V12-T3-113–V12-T3-167)

- Many of the suggested Series C replacements are electrical replacements only, and may have different dimensions, mountings, handle forces and throw (which would require a handle mechanism change). The MARK 75 replacement would have the same dimensions, mountings, handle forces and throw. Only three-pole MARK 75 available.
- Replacement breaker frames, trips, plugs and some of the terminals and attachments are not interchangeable with the Series C. Obsolete frames and trips, etc., may require a complete breaker change.
- Replacing with a Higher IC MARK 75 or Series C breaker does not increase the IC rating of the assembly (panelboard, switchboard, etc.).
- Saf-T-Vue is no longer available on the replacement breaker line. Eaton Canada does make the Series C with Saf-T-Vue and may be sourced through our **Canadian Distribution Center** at **905-631-4318**.
- Suggested replacements also apply to breakers that had suffixes such as "L," line and load terminals, "V" 50C calibration and "W" without terminals.
- The HFB two-pole breaker is on a three-pole frame. The Series C replacement is a true two-pole.
- Continuous amperes and/or trip range may be a little different on the replacement Series C.
- Replacement breaker MARK 75 breakers with interchangeable trip units are to be supplied as frame, trip, terminals and attachment as separate items (except when accessories must be factory installed). No single-phase, ambient compensated, Saf-T-Vue, reverse-feed, or SELTRONIC magnetic only are available on replacement breakers.
- JA, DA, KA, HKA, LB, LBB and HLB breakers when replaced with a Series C breaker "K" frame, when bussed on the line side such as a panelboard, requires a TAD3 spacer kit.
- Contact the local Eaton Satellite for complete panelboard replacement or new interior replacement. Use Panelboard Replacement Breakers where possible. MARK 75 and three-pole only replacements are available. Contact the **Breaker Service Center** at **1-877-275-7782** for reconditioned breaker solutions.

Note: If accessories are to be factory installed, contact the factory for pricing.

Cross-Reference

Replacement Breaker Cross-Reference

Replacement Breaker			Replacements			Notes
Catalog Number	Style Number	Status ^①	MARK 75 Catalog Number	MARK 75 Style Number	Series C Catalog Number	(See Page V12-T3-114)
1256C10G03	1256C10G03	0	—	—	LD2300	1–3, 5, 8
1256C10G04	1256C10G04	0	—	—	LD2350	1–3, 5, 8
1256C10G05	1256C10G05	0	—	—	LD2400	1–3, 5, 8
1256C10G12	1256C10G12	A	—	—	KD3250	1–3, 5, 8
1256C10G13	1256C10G13	A	—	—	LD3300	1–3, 5, 8
1256C10G14	1256C10G14	A	—	—	LD3350	1–3, 5, 8
1256C10G15	1256C10G15	A	—	—	LD3400	1–3, 5, 8
1268C14G01	1268C14G01	0	—	—	HMCP050G2C	1–3, 7
1268C14G02	1268C14G02	0	—	—	HMCP050G2C	1–3, 7
1268C14G03	1268C14G03	0	65E4667	65E466	HMCP100L3C	1–3, 7
1268C14G04	1268C14G04	0	65E4667	65E4667	HMCP100L3C	1–3, 7
1268C14G05	1268C14G05	0	—	—	HMCP050G2C	1–3, 7
1268C14G06	1268C14G06	0	—	—	HMCP050G2C	1–3, 7
2603D46G07	2603D46G07	0	—	—	KT2250T	2, 8
2603D46G08	2603D46G08	0	—	—	LT2300T	2, 8
2603D46G09	2603D46G09	0	—	—	LT2350T	2, 8
2603D46G10	2603D46G10	0	—	—	LT2400T	2, 8
2603D46G26	2603D46G26	A	—	—	KT3250T	2, 8
2603D46G27	2603D46G27	A	—	—	LT3300T	2, 8
2603D46G28	2603D46G28	A	—	—	LT3350T	2, 8
2603D46G29	2603D46G29	A	—	—	LT3400T	2, 8
2603D47G07	2603D47G07	0	—	—	—	2, 8
2603D47G08	2603D47G08	0	—	—	—	2, 8
2603D47G10	2603D47G10	0	—	—	—	2, 8
2603D47G26	2603D47G26	A	—	—	—	2, 8
2603D47G27	2603D47G27	A	—	—	—	2, 8
2603D47G29	2603D47G29	A	—	—	—	2, 8
2603D50G01	2603D50G01	0	—	—	KD2250	1–3, 5, 8
2603D50G02	2603D50G02	0	—	—	LD2300	1–3, 5, 8
2603D50G03	2603D50G03	0	—	—	LD2350	1–3, 5, 8
2603D50G04	2603D50G04	0	—	—	LD2400	1–3, 5, 8
2603D50G07	2603D50G07	0	—	—	KD3250	1–3, 5, 8
2603D50G08	2603D50G08	0	1256C10G13	1256C10G13	LD3300	1–3, 5, 8
2603D50G09	2603D50G09	0	1256C10G14	1256C10G14	LD3350	1–3, 5, 8
2603D50G10	2603D50G10	0	1256C10G15	1256C10G15	LD3400	1–3, 5, 8
2603D50G13	2603D50G13	0	—	—	KD2250	1–5, 8
2603D50G14	2603D50G14	0	—	—	LD2300	1–5, 8
2603D50G15	2603D50G15	0	—	—	LD2350	1–5, 8
2603D50G16	2603D50G16	0	—	—	LD2400	1–5, 8
2603D50G19	2603D50G19	0	1256C10G12	1256C10G12	KD3250	1–5, 8
2603D50G20	2603D50G20	0	1256C10G13	1256C10G13	LD3300	1–5, 8
2603D50G21	2603D50G21	0	1256C10G14	1256C10G14	LD3350	1–5, 8
2603D50G22	2603D50G22	0	1256C10G15	1256C10G15	LD3400	1–5, 8
2610D53G12	2610D53G12	0	4994D96G30	4994D96G30	HMCP025DOC	1–3, 7
2610D53G13	2610D53G13	0	4994D96G31	4994D96G31	HMCP07QJ2C	1–3, 7

Note

① 0 = Obsolete, A = Available.

Replacement Breaker Cross-Reference

Replacement Breaker		Status ①	Replacements			Notes (See Page V12-T3-114)
Catalog Number	Style Number		MARK 75 Catalog Number	MARK 75 Style Number	Series C Catalog Number	
2610D53G30	2610D53G30	0	4994D96G30	4994D96G30	HMCP025DOC	1-3, 7
2610D53G31	2610D53G31	0	4994D96G31	4994D96G31	HMCP070J2C	1-3, 7
2610D58G31	2610D58G31	0	—	—	—	1-4, 7
373D488G08	373D488G08	0	373D488G09	373D488G09	—	2, 8
4994D96G12	4994D96G12	0	4994D96G30	4994D96G30	HMCP025DOC	1-3, 7
4994D96G13	4994D96G13	0	4994D96G31	4994D96G31	HMCP070J2C	1-3, 7
4994D96G30	4994D96G30	A	—	—	HMCP025DOC	1-3, 7
4994D96G31	4994D96G31	A	—	—	HMCP070J2C	1-3, 7
4998D89G30	4998D89G30	0	—	—	—	1-4, 7
5683D88G07	5683D88G07	0	—	—	KT2250T	2, 8
5683D88G08	5683D88G08	0	—	—	LT2300T	2, 8
5683D88G09	5683D88G09	0	—	—	LT2350T	2, 8
5683D88G10	5683D88G10	0	—	—	LT2400T	2, 8
5683D88G26	5683D88G26	0	2603D46G26	2603D46G26	KT3250T	2, 8
5683D88G27	5683D88G27	0	2603D46G27	2603D46G27	LT3300T	2, 8
5683D88G28	5683D88G28	0	2603D46G28	2603D46G28	LT3350T	2, 8
5683D88G29	5683D88G29	0	2603D46G29	2603D46G29	LT3400T	2, 8
65E4667	65E4667	A	—	—	HMCP100L3C	1-3, 7
81E4647	81E4647	0	—	—	—	1-4, 7
DA2250	375D152G11	0	—	—	DK2250	1-3, 5, 8, 9
DA2250Y	376D872G11	0	—	—	DK2250Y	1-3, 5, 8, 9
DA2300	375D152G12	0	—	—	DK2300	1-3, 5, 8, 9
DA2300Y	376D872G12	0	—	—	DK2300Y	1-3, 5, 8, 9
DA2350	375D152G13	0	—	—	DK2350	1-3, 5, 8, 9
DA2350Y	376D872G13	0	—	—	DK2350Y	1-3, 5, 8, 9
DA2400	375D152G14	0	—	—	DK2400	1-3, 5, 8, 9
DA2400WK	752B050G01	0	—	—	DK2400KW	1-3, 5, 8
DA2400Y	376D872G14	0	—	—	DK2400Y	1-3, 5, 8, 9
DA3250	375D152G26	0	—	—	DK3250	1-3, 5, 8, 9
DA3250Y	376D872G26	0	—	—	DK3250Y	1-3, 5, 8, 9
DA3300	375D152G27	0	—	—	DK3300	1-3, 5, 8, 9
DA3300Y	376D872G27	0	—	—	DK3300Y	1-3, 5, 8, 9
DA3350	375D152G28	0	—	—	DK3350	1-3, 5, 8, 9
DA3350Y	376D872G28	0	—	—	DK3350Y	1-3, 5, 8, 9
DA3400	375D152G29	0	—	—	DK3400	1-3, 5, 8, 9
DA3400WK	752B050G06	0	—	—	DK3400KW	1-3, 5, 8
DA3400Y	376D872G29	0	—	—	DK3400Y	1-3, 5, 8, 9
EB1015	4990D03G02	0	—	—	EHD1015	1-3, 5
EB1020	4990D03G03	0	—	—	EHD1020	1-3, 5
EB1025	4990D03G04	0	—	—	EHD1025	1-3, 5
EB1030	4990D03G05	0	—	—	EHD1030	1-3, 5
EB1035	4990D03G06	0	—	—	EHD1035	1-3, 5
EB1040	4990D03G07	0	—	—	EHD1040	1-3, 5
EB1045	4990D03G14	0	—	—	EHD1045	1-3, 5
EB1050	4990D03G08	0	—	—	EHD1050	1-3, 5
EB1060	4990D03G09	0	—	—	EHD1060	1-3, 5
EB1070	4990D03G10	0	—	—	EHD1070	1-3, 5

Note

① 0 = Obsolete, A = Available.

Replacement Breaker Cross-Reference

Replacement Breaker			Replacements			Notes
Catalog Number	Style Number	Status ①	MARK 75 Catalog Number	MARK 75 Style Number	Series C Catalog Number	(See Page V12-T3-114)
EB1080	4990D03G65	0	—	—	EHD1080	1–3, 5
EB1090	4990D03G11	0	—	—	EHD1090	1–3, 5
EB1100	4990D03G12	0	—	—	EHD1100	1–3, 5
EB1100LK	1226C25G01	0	—	—	—	1–3, 5, 8
EB2015	4990D03G18	0	—	—	EHD2015	1–3, 5
EB2020	4990D03G19	0	—	—	EHD2020	1–3, 5
EB2025	4990D03G20	0	—	—	EHD2025	1–3, 5
EB2030	4990D03G21	0	—	—	EHD2030	1–3, 5
EB2035	4990D03G22	0	—	—	EHD2035	1–3, 5
EB2040	4990D03G23	0	—	—	EHD2040	1–3, 5
EB2050	4990D03G24	0	—	—	EHD2050	1–3, 5
EB2060	4990D03G25	0	—	—	EHD2060	1–3, 5
EB2070	4990D03G26	0	—	—	EHD2070	1–3, 5
EB2080	4990D03G32	0	—	—	EHD2080	1–3, 5
EB2090	4990D03G27	0	—	—	EHD2090	1–3, 5
EB2100	4990D03G28	0	—	—	EHD2100	1–3, 5
EB2100LK	1226C25G02	0	—	—	EHD2100KL	1–3, 5, 8
EB3015	4990D03G34	0	HFB3015L	4997D19G34	EHD3015	1–3, 5
EB3015S	4991D35G02	0	HFB3015L	4997D19G34	EHD3015	1–5
EB3020	4990D03G35	0	HFB3020L	4997D19G35	EHD3020	1–3, 5
EB3020S	4991D35G03	0	HFB3020L	4997D19G35	EHD3020	1–5
EB3025	4990D03G36	0	HFB3025L	4997D19G36	EHD3025	1–3, 5
EB3025S	4991D35G04	0	HFB3025L	4997D19G36	EHD3025	1–5
EB3030	4990D03G37	0	HFB3030L	4997D19G37	EHD3030	1–3, 5
EB3030S	4991D35G05	0	HFB3030L	4997D19G37	EHD3030	1–5
EB3035	4990D03G38	0	HFB3035L	4997D19G38	EHD3035	1–3, 5
EB3035S	4991D35G06	0	HFB3035L	4997D19G38	EHD3035	1–5
EB3040	4990D03G39	0	HFB3040L	4997D19G39	EHD3040	1–3, 5
EB3040S	4991D35G07	0	HFB3040L	4997D19G39	EHD3040	1–5
EB3045	4990D03G46	0	HFB3045L	4997D19G54	EHD3045	1–3, 5
EB3045S	4990D03G40	0	HFB3045L	4997D19G54	EHD3045	1–5
EB3050	4991D35G08	0	HFB3050L	4997D19G40	EHD3050	1–3, 5
EB3050S	4990D03G41	0	HFB3050L	4997D19G40	EHD3050	1–5
EB3060	4991D35G09	0	HFB3060L	4997D19G41	EHD3060	1–3, 5
EB3060S	4990D03G42	0	HFB3060L	4997D19G41	EHD3060	1–5
EB3070	4991D35G10	0	HFB3070L	4997D19G42	EHD3070	1–3, 5
EB3070S	4990D03G48	0	HFB3070L	4997D19G42	EHD3070	1–5
EB3080	4990D03G43	0	HFB3080L	4997D19G55	EHD3080	1–3, 5
EB3080S	4991D35G11	0	HFB3080L	4997D19G55	EHD3080	1–5
EB3090	4990D03G43	0	HFB3090L	4997D19G43	EHD3090	1–3, 5
EB3090S	4991D35G11	0	HFB3090L	4997D19G43	EHD3090	1–5
EB3100	4990D03G44	0	HFB3100L	4997D19G44	EHD3100	1–3, 5
EB3100LK	1226C25G03	0	—	—	EHD3100KL	1–3, 5, 8
EB3100S	4991D35G12	0	HFB3100L	4997D19G44	EHD3100	1–5
EB3100SLK	1226C25G04	0	—	—	EHD3100KL	1–3, 5, 8
EHB1015	4989D52G02	0	—	—	EHD1015	1–3, 5
EHB1020	4989D52G03	0	—	—	EHD1020	1–3, 5

Note

① 0 = Obsolete, A = Available.

Replacement Breaker Cross-Reference

Replacement Breaker		Status ①	Replacements			Notes (See Page V12-T3-114)
Catalog Number	Style Number		MARK 75 Catalog Number	MARK 75 Style Number	Series C Catalog Number	
EHB1025	4989D52G04	0	—	—	EHD1025	1–3, 5
EHB1030	4989D52G05	0	—	—	EHD1030	1–3, 5
EHB1035	4989D52G06	0	—	—	EHD1035	1–3, 5
EHB1040	4989D52G07	0	—	—	EHD1040	1–3, 5
EHB1050	4989D52G08	0	—	—	EHD1050	1–3, 5
EHB1060	4989D52G09	0	—	—	EHD1060	1–3, 5
EHB1070	4989D52G10	0	—	—	EHD1070	1–3, 5
EHB1080	4989D52G14	0	—	—	EHD1080	1–3, 5
EHB1090	4989D52G11	0	—	—	EHD1090	1–3, 5
EHB1100	4989D52G12	0	—	—	EHD1100	1–3, 5
EHB1100LK	1226C25G11	0	—	—	—	1–3, 5, 8
EHB2015	4989D52G18	0	—	—	EHD2015	1–3, 5
EHB2020	4989D52G19	0	—	—	EHD2020	1–3, 5
EHB2025	4989D52G20	0	—	—	EHD2025	1–3, 5
EHB2030	4989D52G21	0	—	—	EHD2030	1–3, 5
EHB2035	4989D52G22	0	—	—	EHD2035	1–3, 5
EHB2040	4989D52G23	0	—	—	EHD2040	1–3, 5
EHB2045	4989D52G29	0	—	—	EHD2045	1–3, 5
EHB2050	4989D52G24	0	—	—	EHD2050	1–3, 5
EHB2060	4989D52G25	0	—	—	EHD2060	1–3, 5
EHB2070	4989D52G26	0	—	—	EHD2070	1–3, 5
EHB2090	4989D52G27	0	—	—	EHD2090	1–3, 5
EHB2100	4989D52G28	0	—	—	EHD2100	1–3, 5
EHB2100LK	1226C25G12	0	—	—	EHD2100KL	1–3, 5, 8
EHB3015	4989D52G34	0	HFB3015L	4997D19G34	EHD3015	1–3, 5
EHB3015S	4991D35G18	0	HFB3015L	4997D19G34	EHD3015	1–5
EHB3020	4989D52G35	0	HFB3020L	4997D19G35	EHD3020	1–3, 5
EHB3020S	4991D35G19	0	HFB3020L	4997D19G35	EHD3020	1–5
EHB3025	4989D52G36	0	HFB3025L	4997D19G36	EHD3025	1–3, 5
EHB3025S	4991D35G20	0	HFB3025L	4997D19G36	EHD3025	1–5
EHB3030	4989D52G37	0	HFB3030L	4997D19G37	EHD3030	1–3, 5
EHB3030S	4991D35G21	0	HFB3030L	4997D19G37	EHD3030	1–5
EHB3035	4989D52G38	0	HFB3035L	4997D19G38	EHD3035	1–3, 5
EHB3035S	4991D35G22	0	HFB3035L	4997D19G38	EHD3035	1–5
EHB3040	4989D52G39	0	HFB3040L	4997D19G39	EHD3040	1–3, 5
EHB3040S	4991D35G23	0	HFB3040L	4997D19G39	EHD3040	1–5
EHB3045	4989D52G45	0	HFB3045L	4997D19G54	EHD3045	1–3, 5
EHB3045S	NO STYLE	0	HFB3045L	4997D19G54	EHD3045	1–5
EHB3050	4993D67G40	0	HFB3050L	4997D19G40	EHD3050	1–3, 5
EHB3050S	4991D35G24	0	HFB3050L	4997D19G40	EHD3050	1–5
EHB3060	4993D67G41	0	HFB3060L	4997D19G41	EHD3060	1–3, 5
EHB3060S	4991D35G25	0	HFB3060L	4997D19G41	EHD3060	1–5
EHB3070	4993D67G42	0	HFB3070L	4997D19G42	EHD3070	1–3, 5
EHB3070S	4991D35G26	0	HFB3070L	4997D19G42	EHD3070	1–5
EHB3080	4993D67G46	0	HFB3080L	4997D19G55	EHD3080	1–3, 5
EHB3080S	NO STYLE	0	HFB3080L	4997D19G55	EHD3080	1–5
EHB3090	4993D67G43	0	HFB3090L	4997D19G43	EHD3090	1–3, 5

Note

① 0 = Obsolete, A = Available.

Replacement Breaker Cross-Reference

Replacement Breaker			Replacements			Notes
Catalog Number	Style Number	Status ^①	MARK 75 Catalog Number	MARK 75 Style Number	Series C Catalog Number	(See Page V12-T3-114)
EHB3090S	4991D35G27	0	HFB3090L	4997D19G43	EHD3090	1-5
EHB3100	4993D67G44	0	HFB3100L	4997D19G44	EHD3100	1-3, 5
EHB3100LK	1226C25G13	0	—	—	EHD3100KL	1-3, 5, 8
EHB3100S	4991D35G28	0	—	—	EHD3100	1-5
EHB3100SLK	1226C25G14	0	—	—	EHD3100KL	1-3, 5, 8
FB2015	4975D71G18	0	—	—	FD2015	1-3, 5
FB2020	4975D71G19	0	—	—	FD2020	1-3, 5
FB2022MRL	2610D53G03	0	—	—	HMCP003AOC	1-3, 7
FB2025	4975D71G20	0	—	—	FD2025	1-3, 5
FB2030	4975D71G21	0	—	—	FD2030	1-3, 5
FB2035	4975D71G22	0	—	—	FD2035	1-3, 5
FB2040	4975D71G23	0	—	—	FD2040	1-3, 5
FB2045MRL	2610D53G04	0	—	—	HMCP007COC	1-3, 7
FB2050	4975D71G24	0	—	—	FD2050	1-3, 5
FB2060	4975D71G25	0	—	—	FD2060	1-3, 5
FB2070	4975D71G26	0	—	—	FD2070	1-3, 5
FB2080	4975D71G02	0	—	—	FD2080	1-3, 5
FB2090	4975D71G27	0	—	—	FD2090	1-3, 5
FB2100	4975D71G28	0	—	—	FD2100	1-3, 5
FB2100LK	1226C25G21	0	—	—	FD2100KL	1-3, 5, 8
FB2110MRL	2610D53G05	0	—	—	HMCP015E0C	1-3, 7
FB2150LK	1226C25G22	0	—	—	FD2150KL	1-3, 5, 8
FB21550MRL	2610D53G08	0	—	—	HMCP150T4C	1-3, 7
FB21800MRL	2610D53G11	0	—	—	HMCP150U4C	1-3, 7
FB2190MRL	2610D53G06	0	—	—	HMCP030H1C	1-3, 7
FB2270MRL	2610D53G10	0	—	—	HMCP030H1C	1-3, 7
FB2480MRL	2610D53G07	0	—	—	HMCP050K2C	1-3, 7
FB3015	4975D71G34	0	HFB3015L	4997D19G34	FD3015	1-3, 5
FB3015S	4991D35G34	0	HFB3015L	4997D19G34	FD3015	1-5
FB3020	4975D71G35	0	HFB3020L	4997D19G35	FD3020	1-3, 5
FB3020S	4991D35G35	0	HFB3020L	4997D19G35	FD3020	1-5
FB3022MRL	2606D96G21	0	HFB3022ML	4994D96G21	HMCP003AOC	1-3, 7
FB3022SMRL	2610D58G21	0	HFB3022ML	4994D96G21	HMCP003AOC	1-4, 7
FB3025	4975D71G36	0	HFB3025L	4997D19G36	FD3025	1-3, 5
FB3025S	4991D35G36	0	HFB3025L	4997D19G36	FD3025	1-5
FB3030	4975D71G37	0	HFB3030L	4997D19G37	FD3030	1-3, 5
FB3030S	4991D35G37	0	HFB3030L	4997D19G37	FD3030	1-5
FB3035	4975D71G38	0	HFB3035L	4997D19G38	FD3035	1-3, 5
FB3040	4975D71G39	0	HFB3040L	4997D19G39	FD3040	1-3, 5
FB3040S	4991D35G39	0	HFB3040L	4997D19G39	FD3040	1-5
FB3045L	4975D71G05	0	HFB3045L	4997D19G54	FD3045	1-3, 5
FB3045MRL	2610D53G22	0	HFB3045ML	4994D96G22	HMCP007COC	1-3, 7
FB3045S	NO STYLE	0	HFB3045L	4997D19G54	FD3045	1-5
FB3045SMRL	2610D58G22	0	HFB3045ML	4994D96G22	HMCP007COC	1-4, 7
FB3050	4975D71G40	0	HFB3050L	4997D19G40	FD3050	1-3, 5
FB3050S	4991D35G40	0	HFB3050L	4997D19G40	FD3050	1-5
FB3060	4975D71G41	0	HFB3060L	4997D19G41	FD3060	1-3, 5

Note

① 0 = Obsolete, A = Available.

Replacement Breaker Cross-Reference

Replacement Breaker		Status ①	Replacements			Notes (See Page V12-T3-114)
Catalog Number	Style Number		MARK 75 Catalog Number	MARK 75 Style Number	Series C Catalog Number	
FB3060S	4991D35G41	0	HFB3060L	4997D19G41	FD3060	1-5
FB3070	4975D71G42	0	HFB3070L	4997D19G42	FD3070	1-3, 5
FB3070S	4991D35G42	0	HFB3070L	4997D19G42	FD3070	1-5
FB3080	4975D71G06	0	HFB3080L	4997D19G55	FD3080	1-3, 5
FB3080S	NO STYLE	0	HFB3080L	4997D19G55	FD3080	1-5
FB3090	4975D71G43	0	HFB3090L	4997D19G43	FD3090	1-3, 5
FB3090S	4991D35G43	0	HFB3090L	4997D19G43	FD3090	1-5
FB3100	4975D71G44	0	HFB3100L	4997D19G44	FD3100	1-3, 5
FB3100LK	1226C25G23	0	—	—	FD3100KL	1-3, 5, 8
FB3100S	4991D35G44	0	HFB3100L	4997D19G44	FD3100	1-5
FB3110	4975D71G07	0	—	—	FD3110	1-3, 5
FB3110MRL	2610D53G23	0	HFB3110ML	4994D96G23	HMCP015E0C	1-3, 7
FB3110S	NO STYLE	0	—	—	FD3110	1-5
FB3110SMRL	2610D58G23	0	—	—	HMCP015E0C	1-4, 7
FB3125	4975D71G45	0	—	—	FD3125	1-3, 5
FB3125S	4991D35G45	0	—	—	FD3125	1-4, 5
FB3150	4975D71G46	0	—	—	FD3150	1-3, 5
FB3150LK	1226C25G24	0	—	—	FD3150KL	1-3, 5, 8
FB3150S	4991D35G46	0	—	—	FD3150	1-5
FB3150SLK	1226C25G25	0	—	—	FD3150KL	1-3, 5, 8
FB31550MRL	2610D53G26	0	HFB31550ML	4994D96G26	HMCP150T4C	1-3, 7
FB31550SMRL	2610D58G26	0	HFB31550ML	4994D96G26	HMCP150T4C	1-4, 7
FB31800MRL	2610D53G29	0	—	—	HMCP150U4C	1-3, 7
FB31800SMRL	2610D58G29	0	—	—	HMCP150U4C	1-4, 7
FB3190MRL	2610D53G24	0	HFB3190ML	4994D96G24	HMCP030H1C	1-3, 7
FB3190SMRL	2610D58G24	0	HFB3190ML	4994D96G24	HMCP030H1C	1-4, 7
FB3270MRL	2610D53G28	0	HFB3270ML	4994D96G28	HMCP030H1C	1-3, 7
FB3270SMRL	2610D58G28	0	HFB3270ML	4994D96G28	HMCP030H1C	1-4, 7
FB3480MRL	2610D53G25	0	HFB3480ML	4994D96G25	HMCP050K2C	1-3, 7
FB3480SMRL	2610D58G25	0	HFB3480ML	4994D96G25	HMCP050K2C	1-4, 7
FB4015	4975D71G50	0	—	—	FD4015	1-3, 5
FB4020	4975D71G51	0	—	—	FD4020	1-3, 5
FB4025	4975D71G52	0	—	—	FD4025	1-3, 5
FB4030	4975D71G53	0	—	—	FD4030	1-3, 5
FB4035	4975D71G54	0	—	—	FD4035	1-3, 5
FB4040	4975D71G55	0	—	—	FD4040	1-3, 5
FB4045	NO STYLE	0	—	—	FD4045	1-3, 5
FB4050	4975D71G56	0	—	—	FD4050	1-3, 5
FB4060	4975D71G57	0	—	—	FD4060	1-3, 5
FB4070	4975D71G58	0	—	—	FD4070	1-3, 5
FB4080	NO STYLE	0	—	—	FD4080	1-3, 5
FB4090	4975D71G59	0	—	—	FD4090	1-3, 5
FB4100	4975D71G60	0	—	—	FD4100	1-3, 5
FB4100LK	1226C25G26	0	—	—	FD4100KL	1-3, 5, 8
FB4150LK	1226C25G27	0	—	—	FD4150KL	1-3, 5, 8
HFB1015	4976D04G02	0	—	—	HFD1015	1-3, 5
HFB1020	4976D04G03	0	—	—	HFD1020	1-3, 5

Note

① 0 = Obsolete, A = Available.

Replacement Breaker Cross-Reference

Replacement Breaker			Replacements			Notes
Catalog Number	Style Number	Status ^①	MARK 75 Catalog Number	MARK 75 Style Number	Series C Catalog Number	(See Page V12-T3-114)
HFB1025	4976D04G04	0	—	—	HFD1025	1–3, 5
HFB1030	4976D04G05	0	—	—	HFD1030	1–3, 5
HFB1035	4976D04G06	0	—	—	HFD1035	1–3, 5
HFB1040	4976D04G07	0	—	—	HFD1040	1–3, 5
HFB1045	4976D04G49	0	—	—	HFD1045	1–3, 5
HFB1050	4976D04G08	0	—	—	HFD1050	1–3, 5
HFB1060	4976D04G09	0	—	—	HFD1060	1–3, 5
HFB1070	4976D04G10	0	—	—	HFD1070	1–3, 5
HFB1080	4976D04G50	0	—	—	HFD1080	1–3, 5
HFB1090	4976D04G11	0	—	—	HFD1090	1–3, 5
HFB1100	4976D04G12	0	—	—	HFD1100	1–3, 5
HFB2015	4976D04G18	0	—	—	FD3015	1–3, 5, 6
HFB2020	4976D04G19	0	—	—	FD3020	1–3, 5, 6
HFB2022ML	2610D57G03	0	—	—	HMCP003AOC	1, 2, 3, 7
HFB2025	4976D04G20	0	—	—	FD3025	1, 2, 3, 5, 6
HFB2030	4976D04G21	0	—	—	FD3030	1, 2, 3, 5, 6
HFB2035	4976D04G22	0	—	—	FD3035	1, 2, 3, 5, 6
HFB2040	4976D04G23	0	—	—	FD3040	1, 2, 3, 5, 6
HFB2045	4976D04G51	0	—	—	FD3045	1, 2, 3, 5, 6
HFB2045ML	2610D57G04	0	—	—	HMCP007COC	1, 2, 3, 7
HFB2050	4976D04G24	0	—	—	FD3050	1, 2, 3, 5, 6
HFB2060	4976D04G25	0	—	—	FD3060	1, 2, 3, 5, 6
HFB2070	4976D04G26	0	—	—	FD3070	1, 2, 3, 5, 6
HFB2080	4976D04G52	0	—	—	FD3080	1, 2, 3, 5, 6
HFB2090	4976D04G27	0	—	—	FD3090	1, 2, 3, 5, 6
HFB2100	4976D04G28	0	—	—	FD3100	1, 2, 3, 5, 6
HFB2125	4976D04G29	0	—	—	FD3125	1, 2, 3, 5, 6
HFB2150	4976D04G30	0	—	—	FD3150	1, 2, 3, 5, 6
HFB2110ML	2610D57G05	0	—	—	HMCP015EOC	1, 2, 3, 7
HFB21550ML	2610D57G08	0	—	—	HMCP150T4C	1, 2, 3, 7
HFB21800ML	2610D57G11	0	—	—	HMCP150U4C	1, 2, 3, 7
HFB2190ML	2610D57G06	0	—	—	HMCP030H1C	1, 2, 3, 7
HFB2270ML	2610D57G10	0	—	—	HMCP030H1C	1, 2, 3, 7
HFB2480ML	2610D57G07	0	—	—	HMCP050K2C	1, 2, 3, 7
HFB3015	4976D04G34	0	HFB3015L	4997D19G34	FD3015	1, 2, 3, 5
HFB3020	4976D04G35	0	HFB3020L	4997D19G35	FD3020	1, 2, 3, 5
HFB3022ML	2610D57G21	A	—	—	HMCP003AOC	1, 2, 3, 7
HFB3025	4976D04G36	0	HFB3025L	4997D19G36	FD3025	1, 2, 3, 5
HFB3030	4976D04G37	0	HFB3030L	4997D19G37	FD3030	1, 2, 3, 5
HFB3035	4976D04G38	0	HFB3035L	4997D19G38	FD3035	1, 2, 3, 5
HFB3040	4976D04G39	0	HFB3040L	4997D19G39	FD3040	1–3, 5
HFB3045	4976D04G54	0	HFB3045L	4997D19G54	FD3045	1–3, 5
HFB3045ML	2610D57G22	A	—	—	HMCP007COC	1–3, 7
HFB3050	4976D04G40	0	HFB3050L	4997D19G40	FD3050	1–3, 5
HFB3060	4976D04G41	0	HFB3060L	4997D19G41	FD3060	1–3, 5
HFB3070	4976D04G42	0	HFB3070L	4997D19G42	FD3070	1–3, 5
HFB3080	4976D04G55	0	HFB3080L	4997D19G55	FD3080	1–3, 5

Note

① 0 = Obsolete, A = Available.

Replacement Breaker Cross-Reference

Replacement Breaker		Status ①	Replacements			Notes (See Page V12-T3-114)
Catalog Number	Style Number		MARK 75 Catalog Number	MARK 75 Style Number	Series C Catalog Number	
HFB3090	4976D04G43	0	HFB3090L	4997D19G43	FD3090	1-3, 5
HFB3100	4976D04G44	0	HFB3100L	4997D19G44	FD3100	1-3, 5
HFB3110	4976D04G56	0	—	—	FD3110	1-3, 5
HFB3110ML	2610D57G23	A	—	—	HMCP015EOC	1-3, 7
HFB3125	4976D04G45	0	—	—	FD3125	1-3, 5
HFB3150	4976D04G46	0	—	—	FD3150	1-3, 5
HFB31550ML	2610D57G26	0	—	—	HMCP150T4C	1-3, 7
HFB31800ML	2610D57G29	0	—	—	HMCP150U4C	1-3, 7
HFB3190ML	2610D57G24	A	—	—	HMCP030H1C	1-3, 7
HFB3270ML	2610D57G28	A	—	—	HMCP030H1C	1-3, 7
HFB3480ML	2610D57G25	A	—	—	HMCP050K2C	1-3, 7
HKA2070	1255C59G02	0	—	—	JD2070	1-3, 5, 8, 9
HKA2070T	2602D83G02	0	—	—	—	2, 8
HKA2070TA	459D987G02	0	—	—	JT2070T	2, 8
HKA2090	1255C59G03	0	—	—	JD2090	1-3, 5, 8, 9
HKA2090T	657D789G03	0	—	—	—	2, 8
HKA2090TA	459D987G03	0	—	—	—	2, 8
HKA2100	1255C59G04	0	—	—	KD2100	1-3, 5, 8, 9
HKA2100T	2602D83G04	0	—	—	—	2, 8
HKA2100TA	459D987G04	0	—	—	—	2, 8
HKA2125	1255C59G05	0	—	—	KD2125	1-3, 5, 8, 9
HKA21250TM	2602D84G05	0	—	—	—	2, 8
HKA2125T	2602D83G05	0	—	—	—	2, 8
HKA2125TA	459D987G05	0	—	—	—	2, 8
HKA2150	1255C59G06	0	—	—	KD2150	1-3, 5, 8, 9
HKA21500TM	2602D84G06	0	—	—	—	2, 8
HKA2150T	2602D83G06	0	—	—	—	2, 8
HKA2150TA	459D987G06	0	—	—	—	2, 8
HKA2175	1255C59G07	0	—	—	KD2175	1-3, 5, 8, 9
HKA21750TM	2602D84G07	0	—	—	—	2, 8
HKA2175T	2602D83G07	0	—	—	—	2, 8
HKA2175TA	459D987G07	0	—	—	—	2, 8
HKA2200	1255C59G08	0	—	—	KD2200	1-3, 5, 8, 9
HKA2200T	2602D83G08	0	—	—	—	2, 8
HKA2200TA	459D987G08	0	—	—	—	2, 8
HKA2225	1255C59G09	0	—	—	KD2225	1-3, 5, 8, 9
HKA22250TM	2602D84G09	0	—	—	—	2, 8
HKA2225F	2602D86G05	0	—	—	KD2400F	2, 8
HKA2225T	2602D83G09	0	—	—	KT2225T	2, 8
HKA2225TA	459D987G09	0	—	—	KT2225T	2, 8
HKA2700TM	2602D84G02	0	—	—	—	2, 8
HKA3070	1255C59G17	0	—	—	JD3070	1-3, 5, 8, 9
HKA3070T	657D788G17	A	—	—	—	2, 5
HKA3070TA	459D987G17	0	HKA3070T	657D789G17	—	2, 8
HKA3090	1255C59G18	0	—	—	JD3090	1-3, 5, 8, 9
HKA3090T	2602D83G18	A	—	—	—	2, 5
HKA3090TA	459D987G18	0	HKA3090T	657D789G18	—	2, 8

Note

① 0 = Obsolete, A = Available.

Replacement Breaker Cross-Reference

Replacement Breaker			Replacements			Notes
Catalog Number	Style Number	Status ^①	MARK 75 Catalog Number	MARK 75 Style Number	Series C Catalog Number	(See Page V12-T3-114)
HKA3100	1255C59G19	0	—	—	KD3100	1-3, 5, 8, 9
HKA3100T	2602D83G19	A	—	—	—	2, 5
HKA3100TA	459D987G19	0	HKA3100T	657D789G19	—	2, 8
HKA3125	1255C59G20	0	—	—	KD3125	1-3, 5, 8, 9
HKA3125T	2602D83G20	A	—	—	—	2, 5
HKA3125TA	459D987G20	0	HKA3125T	657D789G20	—	2, 8
HKA3150	1255C59G21	0	—	—	KD3150	1-3, 5, 8, 9
HKA3150T	2602D83G21	A	—	—	—	2, 5
HKA3150TA	459D987G21	0	HKA3150T	657D789G21	—	2, 8
HKA3175	1255C59G22	0	—	—	KD3175	1-3, 5, 8, 9
HKA3175T	2602D83G22	A	—	—	—	2, 5
HKA3175TA	459D987G22	0	HKA3175T	657D789G22	—	2, 8
HKA3200	1255C59G23	0	—	—	KD3200	1-3, 5, 8, 9
HKA3200T	2602D83G23	A	—	—	—	2, 5
HKA3200TA	459D987G23	0	HKA3200T	657D789G23	—	2, 8
HKA3225	1255C59G24	0	—	—	KD3225	1-3, 5, 8, 9
HKA3225F	2602D86G06	0	—	—	KD3400F	2, 8
HKA3225T	2602D83G24	A	—	—	—	2, 5
HKA3225TA	459D987G24	0	HKA3225T	657D789G24	—	2, 8
HKB2070	1291C44G01	0	—	—	JD2070	1-3, 5
HKB2070T	1293C31G01	0	—	—	—	2, 5
HKB2090	1291C44G02	0	—	—	JD2090	1-3, 5
HKB2090T	1293C31G02	0	—	—	—	—
HKB2100	1291C44G03	0	—	—	JD2100	1-3, 5
HKB21000TM	1293C35G03	0	—	—	—	—
HKB2100T	1293C31G03	0	—	—	—	—
HKB2125	1291C44G04	0	—	—	JD2125	1-3, 5
HKB21250TM	1293C35G04	0	—	—	—	—
HKB2125T	1293C31G04	0	—	—	—	—
HKB2150	1291C44G05	0	—	—	JD2150	1-3, 5
HKB21500TM	1293C35G05	0	—	—	—	—
HKB2150T	1293C31G05	0	—	—	—	—
HKB2175	1291C44G06	0	—	—	JD2175	1-3, 5
HKB21750TM	1293C35G06	0	—	—	—	—
HKB2175T	1293C31G06	0	—	—	—	—
HKB2200	1291C44G07	0	—	—	JD2200	1-3, 5
HKB2200T	1293C31G07	0	—	—	—	—
HKB2225	1291C44G08	0	—	—	JD2225	1-3, 5
HKB22250TM	1293C35G07	0	—	—	—	—
HKB2225T	1293C31G08	0	—	—	—	—
HKB2250	1291C44G09	0	—	—	JD2250	1-3, 5
HKB22500TM	1293C35G09	0	—	—	—	—
HKB2250F	2601D44G15	0	—	—	JD2250F	—
HKB2250T	4974D52G12	0	—	—	—	—
HKB2700TM	1293C35G01	0	—	—	—	—
HKB3070	1291C44G16	0	—	—	JD3070	1-3, 5
HKB3070T	1293C32G01	0	—	—	—	—

Note

① 0 = Obsolete, A = Available.

Replacement Breaker Cross-Reference

Replacement Breaker		Status ①	Replacements			Notes (See Page V12-T3-114)
Catalog Number	Style Number		MARK 75 Catalog Number	MARK 75 Style Number	Series C Catalog Number	
HKB3090	1291C44G17	0	—	—	JD3090	1–3, 5
HKB3090T	1293C32G02	0	—	—	—	—
HKB3100	1291C44G18	0	—	—	JD3100	1–3, 5
HKB31000TM	1293C36G03	0	—	—	—	—
HKB3100T	1293C32G03	0	—	—	—	—
HKB3125	1291C44G19	0	—	—	JD3125	1–3, 5
HKB31250TM	1293C36G04	0	—	—	—	—
HKB3125T	1293C32G04	0	—	—	—	—
HKB3150	1291C44G20	0	—	—	JD3150	1–3, 5
HKB31500TM	1293C36G05	0	—	—	—	—
HKB3150T	1293C32G05	0	—	—	—	—
HKB3175	1291C44G21	0	—	—	JD3175	1–3, 5
HKB31750TM	1293C36G06	0	—	—	—	—
HKB3175T	1293C32G06	0	—	—	—	—
HKB3200	1291C44G22	0	—	—	JD3200	1–3, 5
HKB3200T	1293C32G06	0	—	—	—	—
HKB3225	1291C44G23	0	—	—	JD3225	1–3, 5
HKB32250TM	1293C36G08	0	—	—	—	—
HKB3225T	1293C32G07	0	—	—	—	—
HKB3250	1291C44G24	0	—	—	JD3250	1–3, 5
HKB32500TM	1293C36G09	0	—	—	—	2, 5
HKB3250F	2601D44G16	0	—	—	JD3250F	—
HKB3250FS	NO STYLE	0	—	—	JD3250F	—
HKB3250T	1293C32G08	0	—	—	—	—
HKB3700TM	1293C36G01	0	—	—	—	—
HLA2070T	2602D98G02	0	—	—	—	2, 8
HLA2070TA	457D581G02	0	—	—	—	2, 8
HLA2090T	2602D98G03	0	—	—	—	2, 8
HLA2090TA	457D581G03	0	—	—	—	2, 8
HLA2100T	2602D98G04	0	—	—	—	2, 8
HLA2100TA	457D581G04	0	—	—	—	2, 8
HLA2125	1255C74G05	0	—	—	KD2125	1–3, 5, 8
HLA21250TM	2602D97G03	0	—	—	—	2, 8
HLA2125T	2602D98G05	0	—	—	—	2, 8
HLA2125TA	457D581G05	0	—	—	—	2, 8
HLA2150	1255C74G06	0	—	—	KD2150	1–3, 5, 8
HLA21500TM	2602D97G04	0	—	—	—	2, 8
HLA2150T	2602D98G06	0	—	—	—	2, 8
HLA2150TA	457D581G06	0	—	—	—	2, 8
HLA2175	1255C74G07	0	—	—	KD2175	1–3, 5, 8
HLA21750TM	2602D97G05	0	—	—	—	2, 8
HLA2175T	2602D98G07	0	—	—	—	2, 8
HLA2175TA	457D581G07	0	—	—	—	2, 8
HLA2200	1255C74G08	0	—	—	KD2200	1–3, 5, 8
HLA2200T	2602D98G08	0	—	—	—	2, 8
HLA2200TA	457D581G08	0	—	—	—	2, 8
HLA2225	1255C74G09	0	—	—	KD2225	1–3, 5, 8

Note

① 0 = Obsolete, A = Available.

Replacement Breaker Cross-Reference

Replacement Breaker			Replacements			Notes
Catalog Number	Style Number	Status ^①	MARK 75 Catalog Number	MARK 75 Style Number	Series C Catalog Number	(See Page V12-T3-114)
HLA22250TM	2602D97G06	0	—	—	—	2, 8
HLA2225T	2602D98G09	0	—	—	—	2, 8
HLA2225TA	457D581G09	0	—	—	—	2, 8
HLA2250	1255C74G10	0	—	—	KD2250	1–3, 5, 8
HLA2250T	2602D98G10	0	—	—	—	2, 8
HLA2250TA	457D581G10	0	—	—	—	2, 8
HLA2300	1255C74G11	0	—	—	KD2300	1–3, 5, 8
HLA23000TM	2602D97G07	0	—	—	—	2, 8
HLA2300T	2602D98G11	0	—	—	—	2, 8
HLA2300TA	457D581G11	0	—	—	—	2, 8
HLA2350	1255C74G12	0	—	—	KD2350	1–3, 5, 8
HLA2350T	2602D98G12	0	—	—	—	2, 8
HLA2350TA	457D781G12	0	—	—	—	2, 8
HLA2400	1255C74G13	0	—	—	KD2400	1–3, 5, 8
HLA24000TM	2602D97G08	0	—	—	—	2, 8
HLA2400F	673B352G01	0	—	—	KD2400F	1–3, 5, 8
HLA2400T	2602D98G13	0	—	—	—	2, 8
HLA2400TA	457D581G13	0	—	—	—	2, 8
HLA2500	1256C10G10	0	—	—	LD2500	1–3, 5, 8
HLA25000TM	2603D47G12	0	—	—	—	2, 8
HLA2500T	2603D46G12	0	—	—	—	2, 8
HLA2500TA	5683D88G12	0	—	—	—	2, 8
HLA2600	1256C10G07	0	—	—	LD2600	1–3, 5, 8
HLA26000TM	2603D47G13	0	—	—	—	2, 8
HLA2600F	375D400G09	0	—	—	LD2600F	1–3, 5, 8
HLA2600T	2603D46G13	0	—	—	—	2, 8
HLA2600TA	5683D88G13	0	—	—	—	2, 8
HLA2700TM	2602D97G02	0	—	—	—	2, 8
HLA3070T	2602D98G21	A	—	—	—	2, 8
HLA3070TA	457D581G21	0	HLA3070T	370D749G21	—	2, 8
HLA3090T	2602D98G22	A	—	—	—	2, 8
HLA3090TA	457D581G22	0	HLA3090T	370D749G22	—	2, 8
HLA3100T	2602D98G23	A	—	—	—	2, 8
HLA3100TA	457D581G23	0	HLA3100T	370D749G23	—	2, 8
HLA3125	504C740G20	A	—	—	KD3125	1–3, 5, 8
HLA31250TM	2602D97G25	A	—	—	—	2, 8
HLA3125T	2602D98G24	A	—	—	—	2, 8
HLA3125TA	457D581G24	0	HLA3125T	370D749G24	—	2, 8
HLA3150	504C740G21	A	—	—	KD3150	1–3, 5, 8
HLA31500TM	2602D97G26	A	—	—	—	2, 8
HLA3150T	2602D98G25	A	—	—	—	2, 8
HLA3150TA	457D581G25	0	HLA3150T	370D749G25	—	2, 8
HLA3175	504C740G22	A	—	—	KD3175	1–3, 5, 8
HLA31750TM	2602D97G27	A	—	—	—	2, 8
HLA3175T	2602D98G26	A	—	—	—	2, 8
HLA3175TA	457D581G26	0	HLA3175T	370D749G26	—	2, 8
HLA3200	504C740G23	A	—	—	KD3200	1–3, 5, 8

Note

① 0 = Obsolete, A = Available.

Replacement Breaker Cross-Reference

Replacement Breaker		Status ①	Replacements			Notes (See Page V12-T3-114)
Catalog Number	Style Number		MARK 75 Catalog Number	MARK 75 Style Number	Series C Catalog Number	
HLA3200T	2602D98G27	A	—	—	—	2, 8
HLA3200TA	457D581G27	O	HLA3200T	370D749G27	—	2, 8
HLA3225	504C740G24	A	—	—	KD3225	1–3, 5, 8
HLA32250TM	2602D97G28	A	—	—	—	2, 8
HLA3225T	2602D98G28	A	—	—	—	2, 8
HLA3225TA	457D581G28	O	HLA3225T	370D749G28	—	2, 8
HLA3250	504C740G25	A	—	—	KD3250	1–3, 5, 8
HLA3250T	2602D98G29	A	—	—	—	2, 8
HLA3250TA	457D581G29	O	HLA3250T	370D749G29	—	2, 8
HLA3300	504C740G26	A	—	—	KD3300	1–3, 5, 8
HLA33000TM	2602D97G29	A	—	—	—	2, 8
HLA3300T	2602D98G30	A	—	—	—	2, 8
HLA3300TA	457D581G30	O	HLA3300T	370D749G30	—	2, 8
HLA3350T	2602D98G31	A	—	—	—	2, 8
HLA3350TA	457D581G31	O	HLA3350T	370D749G31	—	2, 8
HLA3400	504C740G28	A	—	—	KD3400	1–3, 5, 8
HLA34000TM	2602D97G30	A	—	—	—	2, 8
HLA3400F	673B352G02	A	—	—	KD3400F	1–3, 5, 8
HLA3400T	2602D98G32	A	—	—	—	2, 8
HLA3400TA	457D581G32	O	HLA3400T	370D749G32	—	2, 8
HLA3500	177C429G16	A	—	—	LD3500	1–3, 5, 8
HLA35000TM	2603D47G31	A	—	—	—	2, 8
HLA3500T	2603D46G31	A	—	—	—	2, 8
HLA3500TA	5683D88G31	O	HLA3500T	375D259G31	—	2, 8
HLA3600	177C429G17	A	—	—	LD3600	1–3, 5, 8
HLA36000TM	2603D47G32	A	—	—	—	2, 8
HLA3600F	2603D48G06	A	—	—	LD3600F	1–3, 5, 8
HLA3600T	2603D46G32	A	—	—	—	2, 8
HLA3600TA	5683D88G32	O	HLA3600T	375D259G32	—	2, 8
HLA3700TM	455D565G24	A	—	—	—	2, 8
HLB2070T	5680D04G07	O	—	—	—	2, 8
HLB2070TA	5680D04G31	O	—	—	—	2, 8
HLB2090T	5680D04G08	O	—	—	—	2, 8
HLB2090TA	5680D04G32	O	—	—	—	2, 8
HLB2100T	5680D04G09	O	—	—	—	2, 8
HLB2100TA	5680D04G33	O	—	—	—	2, 8
HLB2125	179C848G04	O	—	—	KD2125	1–3, 5, 8, 9
HLB21250TM	5680D04G56	O	—	—	—	2, 8
HLB2125T	5680D04G10	O	—	—	—	2, 8
HLB2125TA	5680D04G34	O	—	—	—	2, 8
HLB2150	179C848G05	O	—	—	KD2150	1–3, 5, 8, 9
HLB21500TM	5680D04G57	O	—	—	—	2, 8
HLB2150T	5680D04G11	O	—	—	—	2, 8
HLB2150TA	5680D04G35	O	—	—	—	2, 8
HLB2175	179C848G06	O	—	—	KD2175	1–3, 5, 8, 9
HLB21750TM	5680D04G58	O	—	—	—	2, 8
HLB2175T	5680D04G12	O	—	—	—	2, 8

Note

① O = Obsolete, A = Available.

Replacement Breaker Cross-Reference

Replacement Breaker		Status ①	Replacements			Notes (See Page V12-T3-114)
Catalog Number	Style Number		MARK 75 Catalog Number	MARK 75 Style Number	Series C Catalog Number	
HLB2175TA	5680D04G36	0	—	—	—	2, 8
HLB2200	179C848G07	0	—	—	KD2200	1–3, 5, 8, 9
HLB2200T	5680D04G13	0	—	—	—	2, 8
HLB2200TA	5680D04G37	0	—	—	—	2, 8
HLB2225	179C848G08	0	—	—	KD2225	1–3, 5, 8, 9
HLB22250TM	5680D04G59	0	—	—	—	2, 8
HLB2225T	5680D04G14	0	—	—	—	2, 8
HLB2225TA	5680D04G38	0	—	—	—	2, 8
HLB2250	179C848G09	0	—	—	KD2250	1–3, 5, 8, 9
HLB2250T	5680D04G15	0	—	—	—	2, 8
HLB2250TA	5680D04G39	0	—	—	—	2, 8
HLB2300	179C848G10	0	—	—	KD2300	1–3, 5, 8, 9
HLB23000TM	5680D04G60	0	—	—	—	2, 8
HLB2300T	5680D04G16	0	—	—	—	2, 8
HLB2300TA	5680D04G40	0	—	—	—	2, 8
HLB2350	179C848G11	0	—	—	KD2350	1–3, 5, 8, 9
HLB2350TA	5680D04G41	0	—	—	—	2, 8
HLB2400	179C848G12	0	—	—	KD2400	1–3, 5, 8, 9
HLB24000TM	5680D04G61	0	—	—	—	2, 8
HLB2400F	5680D03G09	0	—	—	KD2400F	1–3, 5, 8, 9
HLB2400T	5680D04G18	0	—	—	—	2, 8
HLB2400TA	5680D04G42	0	—	—	—	2, 8
HLB2700TM	5680D04G55	0	—	—	—	2, 8
HLB3070T	5680D04G19	0	—	—	—	2, 8
HLB3070TA	5680D04G43	0	—	—	—	2, 8
HLB3090T	5680D04G20	0	—	—	—	2, 8
HLB3090TA	5680D04G44	0	—	—	—	2, 8
HLB3100T	5680D04G21	0	—	—	—	2, 8
HLB3100TA	5680D04G45	0	—	—	—	2, 8
HLB3125	179C848G19	0	—	—	KD3125	1–3, 5, 8, 9
HLB31250TM	5680D04G63	0	—	—	—	2, 8
HLB3125T	5680D04G22	0	—	—	—	2, 8
HLB3125TA	5680D04G46	0	—	—	—	2, 8
HLB3150	179C848G20	0	—	—	KD3150	1–3, 5, 8, 9
HLB31500TM	5680D04G64	0	—	—	—	2, 8
HLB3150T	5680D04G23	0	—	—	—	2, 8
HLB3150TA	5680D04G47	0	—	—	—	2, 8
HLB3175	179C848G21	0	—	—	KD3175	1–3, 5, 8, 9
HLB31750TM	5680D04G65	0	—	—	—	2, 8
HLB3175T	5680D04G24	0	—	—	—	2, 8
HLB3175TA	5680D04G48	0	—	—	—	2, 8
HLB3200	179C848G22	0	—	—	KD3200	1–3, 5, 8, 9
HLB3200T	5680D04G25	0	—	—	—	2, 8
HLB3200TA	5680D04G49	0	—	—	—	2, 8
HLB3225	179C848G23	0	—	—	KD3225	1–3, 5, 8, 9
HLB32250TM	5680D04G66	0	—	—	—	2, 8
HLB3225T	5680D04G26	0	—	—	—	2, 8

Note

① 0 = Obsolete, A = Available.

Replacement Breaker Cross-Reference

Replacement Breaker		Status ①	Replacements			Notes (See Page V12-T3-114)
Catalog Number	Style Number		MARK 75 Catalog Number	MARK 75 Style Number	Series C Catalog Number	
HLB3225TA	5680D04G50	0	—	—	—	2, 8
HLB3250	179C848G24	0	—	—	KD3250	1-3, 5, 8, 9
HLB3250T	5680D04G27	0	—	—	—	2, 8
HLB3250TA	5680D04G51	0	—	—	—	2, 8
HLB3300	179C848G25	0	—	—	KD3300	1-3, 5, 8, 9
HLB33000TM	5680D04G67	0	—	—	—	2, 8
HLB3300T	5680D04G28	0	—	—	—	2, 8
HLB3300TA	5680D04G52	0	—	—	—	2, 8
HLB3350TA	5680D04G53	0	—	—	—	2, 8
HLB3400	179C848G27	0	—	—	KD3400	1-3, 5, 8, 9
HLB34000TM	5680D04G68	0	—	—	—	2, 8
HLB3400F	5680D03G10	0	—	—	KD3400F	1-3, 5, 8, 9
HLB3400T	5680D04G30	0	—	—	—	2, 8
HLB3400TA	5680D04G54	0	—	—	—	2, 8
HLB3700TM	5680D04G62	0	—	—	—	2, 8
HLC2150F	1242C92G01	0	—	—	KD3400F/KES3150LS	1-3, 5, 8
HLC2150FM	1242C92G03	0	—	—	KD3400F/KES3150LS	1-3, 5, 8
HLC2300F	1242C92G05	0	—	—	KD3400F/KES3400LS	1-3, 5, 8
HLC2300FM	1242C92G07	0	—	—	KD3400F/KES3400LS	1-3, 5, 8
HLC2400F	1242C92G09	0	—	—	KD3400F/KES3400LS	1-3, 5, 8
HLC2400FM	1242C92G11	0	—	—	KD3400F/KES3400LS	1-3, 5, 8
HLC2600F	1242C92G13	0	—	—	LD3600F/LES3600LS	1-3, 5, 8
HLC2600FM	1242C92G15	0	—	—	LD3600F/LES3600LS	1-3, 5, 8
HLC3150F	1242C92G02	A	—	—	KD3400F/KES3150LS	1-3, 5, 8
HLC3150FM	1242C92G04	0	HLC3150F	1284C66G02	KD3400F/KES3150LS	1-3, 5, 8
HLC3300F	1242C92G06	A	—	—	KD3400F/KES3400LS	1-3, 5, 8
HLC3300FM	1242C92G08	0	HLC3300F	2612D41G46	KD3400F/KES3400LS	1-3, 5, 8
HLC3400F	1242C92G10	A	—	—	KD3400F/KES3400LS	1-3, 5, 8
HLC3400FM	1242C92G12	0	HLC3400F	2613D44G08	KD3400F/KES3400LS	1-3, 5, 8
HLC3600F	1242C92G14	A	—	—	LD3600F/LES3600LS	1-3, 5, 8
HLC3600FM	1242C92G16	0	HLC3600F	2612D41G48	LD3600F/LES3600LS	1-3, 5, 8
HLCA2150F	1242C92G23	0	—	—	KD3400F/KES3150LSI	1-3, 5, 8
HLCA2300F	1242C92G27	0	—	—	KD3400F/KES3400LSI	1-3, 5, 8
HLCA2400F	1242C92G31	0	—	—	KD3400F/KES3400LSI	1-3, 5, 8
HLCA2600F	1242C92G35	0	—	—	LD3600F/LES3600LSI	1-3, 5, 8
HLCA3150F	1242C92G24	A	—	—	KD3400F/KES3150LSI	1-3, 5, 8
HLCA3300F	1242C92G28	A	—	—	KD3400F/KES3400LSI	1-3, 5, 8
HLCA3400F	1242C92G32	A	—	—	KD3400F/KES3400LSI	1-3, 5, 8
HLCA3600F	1284C66G36	A	—	—	LD3600F/LES3600LSI	1-3, 5, 8
HLCC3600F	6590C11G14	A	—	—	CLD3600F/LES3600LS	1-3, 5, 8
HLCCA3600F	6590C11G36	A	—	—	CLD3600F/LES3600LSI	1-3, 5, 8
HLCCG3600F	1242C94G04	A	—	—	CLD3600F/LES3600LSG	1-3, 5, 8
HLCCGA3600F	1242C94G12	A	—	—	CLD3600F/LES3600LSIG	1-3, 5, 8
HLCG3150F	1242C89G01	A	—	—	KD3400F/KES3150LSG	1-3, 5, 8
HLCG3300F	1242C89G02	A	—	—	KD3400F/KES3400LSG	1-3, 5, 8
HLCG3400F	1242C89G03	A	—	—	KD3400F/KES3400LSG	1-3, 5, 8
HLCG3600F	1371D17G40	A	—	—	LD3600F/LES3600LS	1-3, 5, 8

Note

① 0 = Obsolete, A = Available.

Replacement Breaker Cross-Reference

Replacement Breaker			Replacements			Notes
Catalog Number	Style Number	Status ^①	MARK 75 Catalog Number	MARK 75 Style Number	Series C Catalog Number	(See Page V12-T3-114)
HLCGA3150F	1242C89G09	A	—	—	KD3400F/KES3150LSIG	1–3, 5, 8
HLCGA3300F	1242C89G10	A	—	—	KD3400F/KES3400LSIG	1–3, 5, 8
HLCGA3400F	1242C89G11	A	—	—	KD3400F/KES3400LSIG	1–3, 5, 8
HLCGA3600F	1270C61G12	A	—	—	LD3600F/LES3600LSIG	1–3, 5, 8
HMA2125	1252C22G01	0	—	—	KD2125	1–3, 5, 8
HMA21250TM	457D455G07	0	—	—	—	2, 8
HMA2125T	371D371G05	0	—	—	—	2, 8
HMA2125TA	457D458G05	0	—	—	—	2, 8
HMA2150	1252C22G02	0	—	—	KD2150	1–3, 5, 8
HMA2150T	371D371G06	0	—	—	—	2, 8
HMA2150TA	457D458G06	0	—	—	—	2, 8
HMA2175	1252C22G03	0	—	—	KD2175	1–3, 5, 8
HMA2175T	371D371G07	0	—	—	—	2, 8
HMA2175TA	457D458G07	0	—	—	—	2, 8
HMA2200	1252C22G04	0	—	—	KD2200	1–3, 5, 8
HMA22000TM	457D455G08	0	—	—	—	2, 8
HMA2200T	371D371G08	0	—	—	—	2, 8
HMA2200TA	457D458G08	0	—	—	—	2, 8
HMA2225	1252C22G05	0	—	—	KD2225	1–3, 5, 8
HMA2225T	371D371G09	0	—	—	—	2, 8
HMA2225TA	457D458G09	0	—	—	—	2, 8
HMA2250	1252C22G06	0	—	—	KD2250	1, 2, 3, 5, 8
HMA2250T	371D371G10	0	—	—	—	2, 8
HMA2250TA	457D458G10	0	—	—	—	2, 8
HMA2300	1252C22G07	0	—	—	MDL2300	1–3, 5, 8
HMA23000TM	457D455G09	0	—	—	—	2, 8
HMA2300T	371D371G11	0	—	—	—	2, 8
HMA2300TA	457D458G11	0	—	—	—	2, 8
HMA2350	1252C22G08	0	—	—	MDL2350	1–3, 5, 8
HMA2350T	371D371G12	0	—	—	—	2, 8
HMA2350TA	457D458G12	0	—	—	—	2, 8
HMA2400	1252C22G09	0	—	—	MDL2400	1–3, 5, 8
HMA24000TM	457D455G10	0	—	—	—	2, 8
HMA2400T	371D371G13	0	—	—	—	2, 8
HMA2400TA	457D458G13	0	—	—	—	2, 8
HMA2500	1252C22G10	0	—	—	MDL2500	1–3, 5, 8
HMA2500T	371D372G06	0	—	—	—	2, 8
HMA2500TA	457D459G06	0	—	—	—	2, 8
HMA2600	1252C22G11	0	—	—	MDL2600	1–3, 5, 8
HMA2600T	371D372G08	0	—	—	—	2, 8
HMA2600TA	457D459G08	0	—	—	—	2, 8
HMA2700	1252C22G12	0	—	—	MDL2700	1, 2, 3, 5, 8
HMA2700T	371D373G10	0	—	—	—	2, 8
HMA2700TA	457D460G10	0	—	—	—	2, 8
HMA2800	1252C22G13	0	—	—	MDL2800	1, 2, 3, 5, 8
HMA28000TM	457D455G12	0	—	—	—	2, 8
HMA2800F	373B237G03	0	—	—	MDL2800F	—

Note

① 0 = Obsolete, A = Available.

Replacement Breaker Cross-Reference

Replacement Breaker		Status ①	Replacements			Notes (See Page V12-T3-114)
Catalog Number	Style Number		MARK 75 Catalog Number	MARK 75 Style Number	Series C Catalog Number	
HMA2800T	371D373G12	O	—	—	—	2, 8
HMA2800TA	457D460G12	O	—	—	—	2, 8
HMA3125	1252C22G16	A	—	—	KD3125	1, 2, 3, 5, 8
HMA31250TM	457D455G23	A	—	—	—	2, 8
HMA3125T	371D371G21	A	—	—	—	2, 8
HMA3125TA	457D458G21	O	HMA3125T	371D371G21	—	2, 8
HMA3150	1252C22G17	A	—	—	KD3150	1, 2, 3, 5, 8
HMA3150T	371D371G22	A	—	—	—	2, 8
HMA3150TA	457D458G22	O	HMA3150T	371D371G22	—	2, 8
HMA3175	1252C22G18	A	—	—	KD3175	1, 2, 3, 5, 8
HMA3175T	371D371G23	A	—	—	—	2, 8
HMA3175TA	457D458G23	O	HMA3175T	371D371G23	—	2, 8
HMA3200	1252C22G19	A	—	—	KD3200	1, 2, 3, 5, 8
HMA32000TM	457D455G24	A	—	—	—	2, 8
HMA3200T	371D371G24	A	—	—	—	2, 8
HMA3200TA	457D458G24	O	HMA3200T	371D371G24	—	2, 8
HMA3225	1252C22G20	A	—	—	KD3225	1, 2, 3, 5, 8
HMA3225T	371D371G25	A	—	—	—	2, 8
HMA3225TA	457D458G25	O	HMA3225T	371D371G25	—	2, 8
HMA3250	1252C22G21	A	—	—	KD3250	1, 2, 3, 5, 8
HMA3250T	371D371G26	A	—	—	—	2, 8
HMA3250TA	457D458G26	O	HMA3250T	371D371G26	—	2, 8
HMA3300	1252C22G22	A	—	—	MDL3300	1, 2, 3, 5, 8
HMA33000TM	457D455G25	A	—	—	—	2, 8
HMA3300T	371D371G27	A	—	—	—	2, 8
HMA3300TA	457D458G27	O	HMA3300T	371D371G27	—	2, 8
HMA3350	1252C22G23	A	—	—	MDL3350	1, 2, 3, 5, 8
HMA3350T	371D371G28	A	—	—	—	2, 8
HMA3350TA	457D458G28	O	HMA3350T	371D371G28	—	2, 8
HMA3400	1252C22G24	A	—	—	MDL3400	1, 2, 3, 5, 8
HMA34000TM	457D455G26	A	—	—	—	2, 8
HMA3400T	371D371G29	A	—	—	—	2, 8
HMA3400TA	457D458G29	O	HMA3400T	371D371G29	—	2, 8
HMA3500	1252C22G25	A	—	—	MDL3500	1, 2, 3, 5, 8
HMA3500T	371D372G22	A	—	—	—	2, 8
HMA3500TA	457D459G22	O	HMA3500T	371D372G22	—	2, 8
HMA3600	1252C22G26	A	—	—	MDL3600	1, 2, 3, 5, 8
HMA36000TM	457D455G27	A	—	—	—	2, 8
HMA3600T	371D372G24	A	—	—	—	2, 8
HMA3600TA	457D459G24	O	HMA3600T	371D372G24	—	2, 8
HMA3700	1252C22G27	A	—	—	MDL3700	1, 2, 3, 5, 8
HMA3700T	371D373G26	A	—	—	—	2, 8
HMA3700TA	457D460G26	O	HMA3700T	371D373G26	—	2, 8
HMA3800	1252C22G28	A	—	—	MDL3800	1, 2, 3, 5, 8
HMA38000TM	457D455G28	A	—	—	—	2, 8
HMA3800F	2600D43G10	A	—	—	MDL3800F	2, 8
HMA3800T	371D373G28	A	—	—	—	2, 8

Note

① O = Obsolete, A = Available.

Replacement Breaker Cross-Reference

Replacement Breaker			Replacements			Notes (See Page V12-T3-114)
Catalog Number	Style Number	Status ①	MARK 75 Catalog Number	MARK 75 Style Number	Series C Catalog Number	
HMA3800TA	457D460G28	0	HMA3800T	371D373G28	—	2, 8
HMC2800F	6590C16G05	0	—	—	MDL3800F/MES3800LS	1, 2, 3, 5, 8
HMC2800FM	6590C16G07	0	—	—	MDL3800F/MES3800LS	1, 2, 3, 5, 8
HMC3800F	6590C16G06	A	—	—	MDL3800F/MES3800LS	1, 2, 3, 5, 8
HMC3800FM	6590C16G08	0	HMC3800F	6590C16G06	MDL3800F/MES3800LS	1, 2, 3, 5, 8
HMCA2800F	6590C16G17	A	—	—	MDL3800F/MES3800LSI	1, 2, 3, 5, 8
HMCA3800F	6590C16G18	A	—	—	MDL3800F/MES3800LSI	1–3, 5, 8
HMCC3800F	6590C14G06	A	—	—	CMDL3800F/MES3800LS	1–3, 5, 8
HMCCA3800F	6590C14G18	A	—	—	CMDL3800F/MES3800LSI	1–3, 5, 8
HMCCG3800F	1242C62G09	A	—	—	CMDL3800F/MES3800LSG	1–3, 5, 8
HMCCGA3800F	1242C62G11	A	—	—	CMDL3800F/MES3800LSIG	1–3, 5, 8
HMCG3800F	1242C60G09	A	—	—	MDL3800F/MES3800LSG	1–3, 5, 8
HMCGA3800F	1242C60G11	A	—	—	MDL3800F/MES3800LSIG	1–3, 5, 8
HNB21000	1234C26G15	0	—	—	ND212T33W/12NES1000T+	1–3, 5, 8
HNB21000TM	371D590G13	0	—	—	—	2, 8
HNB21000T	371D589G13	0	—	—	—	2, 8
HNB21200	1234C26G17	0	—	—	ND212T33W/12NES1200T+	1–3, 5, 8
HNB21200TM	371D590G14	0	—	—	—	2, 8
HNB21200F	2610D64G19	0	—	—	ND212T33W	1–3, 5, 8
HNB21200T	371D589G15	0	—	—	—	2, 8
HNB26000TM	371D590G11	0	—	—	—	2, 8
HNB2700	1234C26G12	0	—	—	ND2800T33W/8NES700T+	1–3, 5, 8
HNB2700T	371D589G10	0	—	—	—	2, 8
HNB2800	1234C26G13	0	—	—	ND2800T33W/8NES800T+	1–3, 5, 8
HNB2800TM	371D590G12	0	—	—	—	2, 8
HNB2800T	371D589G11	0	—	—	—	2, 8
HNB2900	1234C26G14	0	—	—	ND212T33W/12NES900T+	1–3, 5, 8
HNB2900T	371D589G12	0	—	—	—	2, 8
HNB31000	1234C26G33	A	—	—	ND312T33W/12NES1000T+	1–3, 5, 8
HNB31000TM	371D590G29	A	—	—	—	2, 8
HNB31000T	371D589G29	A	—	—	—	2, 8
HNB31200	1234C26G35	A	—	—	ND312T33W/12NES1200T+	1–3, 5, 8
HNB31200TM	371D590G30	A	—	—	—	2, 8
HNB31200F	625B494G08	A	—	—	ND312T33W	1–3, 5, 8
HNB31200T	371D589G31	A	—	—	—	2, 8
HNB36000TM	371D590G27	A	—	—	—	2, 8
HNB3700	1234C26G30	A	—	—	ND3800T33W/8NES700T+	1–3, 5, 8
HNB3700T	371D589G26	A	—	—	—	2, 8
HNB3800	1234C26G31	A	—	—	ND3800T33W/8NES800T+	1–3, 5, 8
HNB3800TM	371D590G28	A	—	—	—	2, 8
HNB3800T	371D589G27	A	—	—	—	2, 8
HNB3900	1234C26G32	A	—	—	ND312T33W/12NES900T+	1–3, 5, 8
HNB3900T	371D589G28	A	—	—	—	2, 8
HNC21200F	2613D29G06	0	—	—	ND212T33W	1–3, 5, 8
HNC21200FM	2613D29G08	0	—	—	—	1–3, 5, 8
HNC31200F	2613D29G05	A	—	—	ND312T33W	1–3, 5, 8
HNC31200FM	2613D29G07	0	HNC31200F	2613D29G05	—	1–3, 5, 8

Note

① 0 = Obsolete, A = Available.

Replacement Breaker Cross-Reference

Replacement Breaker		Status ①	Replacements			Notes (See Page V12-T3-114)
Catalog Number	Style Number		MARK 75 Catalog Number	MARK 75 Style Number	Series C Catalog Number	
HNCA21200F	2613D29G18	0	HNCA31200F	2613D29G17	ND212T32W	1-3, 5, 8
HNCA31200F	2613D29G17	A	—	—	ND312T32W	1-3, 5, 8
HNCG31200F	1242C72G04	A	—	—	ND312T35W	1-3, 5, 8
HNCGA31200F	1242C72G12	A	—	—	ND312T36W	1-3, 5, 8
JA2070	371D957G02	0	—	—	JDB2070	1-3, 5, 8, 9
JA2070A	456D988G80	0	—	—	JDB2070	1-3, 8, 9
JA2070S	657D791G46	0	—	—	JDB2070	1-5, 8, 9
JA2070SW	657D791G26	0	—	—	JDB2070W	1-5, 8, 9
JA2070W	657D791G02	0	—	—	JDB2070W	1-3, 5, 8, 9
JA2090	371D957G03	0	—	—	JDB2090	1-3, 5, 8, 9
JA2090A	456D988G81	0	—	—	JDB2090	1-3, 8, 9
JA2090S	657D791G47	0	—	—	JDB2090	1-5, 8, 9
JA2090SW	657D791G27	0	—	—	JDB2090W	1-5, 8, 9
JA2090W	657D791G03	0	—	—	JDB2090W	1-3, 5, 8, 9
JA2100	371D957G04	0	—	—	KDB2100	1-3, 5, 8, 9
JA2100A	456D988G82	0	—	—	KDB2100	1-3, 8, 9
JA2100S	657D791G48	0	—	—	KDB2100	1-5, 8, 9
JA2100SW	657D791G28	0	—	—	KDB2100W	1-5, 8, 9
JA2100W	657D791G04	0	—	—	KDB2100W	1-3, 5, 8, 9
JA2125	371D957G05	0	—	—	KDB2125	1-3, 5, 8, 9
JA21250MW	371D957G67	0	—	—	HM2P400F5W	1-3, 8, 9
JA21250SMW	NO STYLE	0	—	—	HM2P400F5W	1-4, 8, 9
JA2125A	456D988G83	0	—	—	KDB2125	1-3, 8, 9
JA2125S	657D791G49	0	—	—	KDB2125	1-5, 8, 9
JA2125SW	657D791G29	0	—	—	KDB2125W	1-5, 8, 9
JA2125W	657D791G05	0	—	—	KDB2125W	1-3, 5, 8, 9
JA2150	371D957G06	0	—	—	KDB2150	1-3, 5, 8, 9
JA21500MW	371D957G68	0	—	—	HM2P400G5W	1-3, 8, 9
JA21500SMW	NO STYLE	0	—	—	HM2P400G5W	1-4, 8, 9
JA2150A	456D988G84	0	—	—	KDB2150	1-3, 8, 9
JA2150S	657D791G50	0	—	—	KDB2150	1-5, 8, 9
JA2150SW	657D791G30	0	—	—	KDB2150W	1-5, 8, 9
JA2150W	657D791G06	0	—	—	KDB2150W	1-3, 5, 8, 9
JA2175	371D957G07	0	—	—	KDB2175	1-3, 5, 8, 9
JA21750MW	371D957G69	0	—	—	HM2P400J5W	1-3, 8, 9
JA21750SMW	NO STYLE	0	—	—	HM2P400J5W	1-4, 8, 9
JA2175A	456D988G85	0	—	—	KDB2175	1-3, 8, 9
JA2175S	657D791G51	0	—	—	KDB2175	1-5, 8, 9
JA2175SW	657D791G31	0	—	—	KDB2175W	1-5, 8, 9
JA2175W	657D791G07	0	—	—	KDB2175W	1-3, 5, 8, 9
JA2200	371D957G08	0	—	—	KDB2200	1-3, 5, 8, 9
JA2200A	456D988G86	0	—	—	KDB2200	1-3, 8, 9
JA2200S	657D791G52	0	—	—	KDB2200	1-5, 8, 9
JA2200SW	657D791G32	0	—	—	KDB2200W	1-5, 8, 9
JA2200W	657D791G08	0	—	—	KDB2200W	1-3, 5, 8, 9
JA2225	371D957G09	0	—	—	KDB2225	1-3, 5, 8, 9
JA22250MW	371D957G70	0	—	—	HM2P400L5W	1-3, 8, 9

Note

① 0 = Obsolete, A = Available.

Replacement Breaker Cross-Reference

Replacement Breaker			Replacements			Notes
Catalog Number	Style Number	Status ①	MARK 75 Catalog Number	MARK 75 Style Number	Series C Catalog Number	(See Page V12-T3-114)
JA22250SMW	NO STYLE	0	—	—	HM2P400L5W	1-4, 8, 9
JA2225A	456D988G87	0	—	—	KDB2225	1-3, 8, 9
JA2225S	657D791G53	0	—	—	KDB2225	1-5, 8, 9
JA2225SW	657D791G33	0	—	—	KDB2225W	1-5, 8, 9
JA2225W	657D791G09	0	—	—	KDB2225W	1-3, 5, 8, 9
JA2225WK	752B047G01	0	—	—	KDB2400KW	1-3, 5, 8, 9
JA2225WSK	752B047G02	0	—	—	KDB2400KW	1-3, 5, 8, 9
JA2250W	NO STYLE	0	—	—	KDB2250W	1-3, 5, 8, 9
JA2700MW	371D957G66	0	—	—	HM2P400D5W	1-3, 5, 7, 8, 9
JA2700SMW	NO STYLE	0	—	—	HM2P400D5W	1-5, 7-9
JA3070	371D957G12	0	—	—	JDB3070	1-3, 8, 9
JA3070A	456D988G90	0	—	—	JDB3070	1-3, 8, 9
JA3070S	657D791G56	0	—	—	JDB3070	1-5, 8, 9
JA3070SW	657D791G36	0	—	—	JDB3070W	1-5, 8, 9
JA3070W	657D791G12	0	—	—	JDB3070W	1-3, 5, 8, 9
JA3090	371D957G13	0	—	—	JDB3090	1-3, 8, 9
JA3090A	456D988G91	0	—	—	JDB3090	1-3, 8, 9
JA3090S	657D791G57	0	—	—	JDB3090	1-5, 8, 9
JA3090SW	657D791G37	0	—	—	JDB3090W	1-5, 8, 9
JA3090W	657D791G13	0	—	—	JDB3090W	1-3, 5, 8, 9
JA3100	371D957G14	0	—	—	KDB3100	1-3, 8, 9
JA3100A	456D988G92	0	—	—	KDB3100	1-3, 8, 9
JA3100S	657D791G58	0	—	—	KDB3100	1-5, 8, 9
JA3100SW	657D791G38	0	—	—	KDB3100W	1-5, 8, 9
JA3100W	657D791G14	0	—	—	KDB3100W	1-3, 5, 8, 9
JA3125	371D957G15	0	—	—	KDB3125	1-3, 8, 9
JA31250MW	371D957G74	0	—	—	HMCP400F5W	1-3, 8, 9
JA31250SMW	NO STYLE	0	—	—	HMCP400F5W	1-4, 8, 9
JA3125A	456D988G93	0	—	—	KDB3125	1-3, 8, 9
JA3125S	657D791G59	0	—	—	KDB3125	1-5, 8, 9
JA3125SW	657D791G39	0	—	—	KDB3125W	1-5, 8, 9
JA3125W	657D791G15	0	—	—	KDB3125W	1-3, 5, 8, 9
JA3150	371D957G16	0	—	—	KDB3150	1-3, 8, 9
JA31500MW	371D957G75	0	—	—	HMCP400G5W	1-3, 8, 9
JA31500SMW	82E2537	0	—	—	HMCP400G5W	1-4, 8, 9
JA3150A	456D988G94	0	—	—	KDB3150	1-3, 8, 9
JA3150S	657D791G60	0	—	—	KDB3150	1-5, 8, 9
JA3150SW	657D791G40	0	—	—	KDB3150W	1-5, 8, 9
JA3150W	657D791G16	0	—	—	KDB3150W	1-3, 5, 8, 9
JA3175	371D957G17	0	—	—	KDB3175	1-3, 8, 9
JA31750MW	371D957G76	0	—	—	HMCP400J5W	1-3, 8, 9
JA31750SMW	82E0668	0	—	—	HMCP400J5W	1-4, 8, 9
JA3175A	456D988G95	0	—	—	KDB3175	1-3, 8, 9
JA3175S	657D791G61	0	—	—	KDB3175	1-5, 8, 9
JA3175SW	657D791G41	0	—	—	KDB3175W	1-5, 8, 9
JA3175W	657D791G17	0	—	—	KDB3175W	1-3, 5, 8, 9
JA3200	371D957G18	0	—	—	KDB3200	1-3, 8, 9

Note

① 0 = Obsolete, A = Available.

Replacement Breaker Cross-Reference

Replacement Breaker		Status ①	Replacements			Notes (See Page V12-T3-114)
Catalog Number	Style Number		MARK 75 Catalog Number	MARK 75 Style Number	Series C Catalog Number	
JA3200A	456D988G96	0	—	—	KDB3200	1-3, 8, 9
JA3200S	657D791G62	0	—	—	KDB3200	1-5, 8, 9
JA3200SW	657D791G42	0	—	—	KDB3200W	1-5, 8, 9
JA3200W	657D791G18	0	—	—	KDB3200W	1-3, 5, 8, 9
JA3225	371D957G19	0	—	—	KDB3225	1-3, 8, 9
JA32250MW	371D957G77	0	—	—	HMCP400L5W	1-3, 8, 9
JA32250SMW	82E8642	0	—	—	HMCP400L5W	1-4, 8, 9
JA3225A	456D988G97	0	—	—	KDB3225	1-3, 8, 9
JA3225S	657D791G63	0	—	—	KDB3225	1-5, 8, 9
JA3225SW	657D791G43	0	—	—	KDB3225W	1-5, 8, 9
JA3225W	657D791G19	0	—	—	KDB3225W	1-3, 5, 8, 9
JA3225WK	752B047G06	0	—	—	KDB3400KW	1-3, 5, 8, 9
JA3225WSK	752B047G07	0	—	—	KDB3400KW	1-3, 5, 8, 9
JA3250W	NO STYLE	0	—	—	KDB3250W	1-3, 5, 8, 9
JA3700MW	NO STYLE	0	—	—	HMCP400D5W	1-3, 5, 7-9
JA3700SMW	NO STYLE	0	—	—	HMCP400D5W	1-5, 7-9
JB2070	NO STYLE	0	—	—	JDB2070	1-3, 5
JB2070S	NO STYLE	0	—	—	JDB2070	1-5
JB2070SW	NO STYLE	0	—	—	JDB2070W	1-5
JB2070W	752B417G34	0	—	—	JDB2070W	1-3, 5
JB2090	NO STYLE	0	—	—	JDB2090	1-3, 5
JB2090S	NO STYLE	0	—	—	JDB2090	1-5
JB2090SW	NO STYLE	0	—	—	JDB2090W	1-5
JB2090W	752B417G35	0	—	—	JDB2090W	1-3, 5
JB2100	NO STYLE	0	—	—	JDB2100	1-3, 5
JB2100S	NO STYLE	0	—	—	JDB2100	1-5
JB2100SW	NO STYLE	0	—	—	JDB2100W	1-5
JB2100W	752B417G01	0	—	—	JDB2100W	1-3, 5
JB2125	NO STYLE	0	—	—	JDB2125	1-3, 5
JB21250MW	752B416G02	0	—	—	HM2P250F5W	1-3
JB21250SMW	752B416G14	0	—	—	HM2P250F5W	1-4
JB2125S	NO STYLE	0	—	—	JDB2125	1-5
JB2125SW	NO STYLE	0	—	—	JDB2125W	1-5
JB2125W	752B417G02	0	—	—	JDB2125W	1-3, 5
JB2150	NO STYLE	0	—	—	JDB2150	1-3, 5
JB21500MW	752B416G03	0	—	—	HM2P250G5W	1-3
JB21500SMW	752B416G15	0	—	—	HM2P250G5W	1-4
JB2150S	NO STYLE	0	—	—	JDB2150	1-5
JB2150SW	NO STYLE	0	—	—	JDB2150W	1-5
JB2150W	752B417G03	0	—	—	JDB2150W	1-3, 5
JB2175	NO STYLE	0	—	—	JDB2175	1-3, 5
JB21750MW	752B416G04	0	—	—	HM2P250J5W	1-3
JB21750SMW	752B416G16	0	—	—	HM2P250J5W	1-4
JB2175S	NO STYLE	0	—	—	JDB2175	1-5
JB2175SW	NO STYLE	0	—	—	JDB2175W	1-5
JB2175W	752B417G04	0	—	—	JDB2175W	1-3, 5
JB2200	NO STYLE	0	—	—	JDB2200	1-3, 5

Note

① 0 = Obsolete, A = Available.

Replacement Breaker Cross-Reference

Replacement Breaker			Replacements			Notes
Catalog Number	Style Number	Status ①	MARK 75 Catalog Number	MARK 75 Style Number	Series C Catalog Number	(See Page V12-T3-114)
JB2200S	81E6623	0	—	—	JDB2200	1–5
JB2200SW	NO STYLE	0	—	—	JDB2200W	1–5
JB2200W	752B417G05	0	—	—	JDB2200W	1–3, 5
JB2225	NO STYLE	0	—	—	JDB2225	1–3, 5
JB22250MW	752B416G05	0	—	—	HM2P250L5W	1–3
JB22250SMW	752B416G17	0	—	—	HM2P250L5W	1–3, 4
JB2225S	NO STYLE	0	—	—	JDB2225	1–5
JB2225SW	NO STYLE	0	—	—	JDB2225W	1–5
JB2225W	752B417G06	0	—	—	JDB2225W	1–3, 5
JB2250	NO STYLE	0	—	—	JDB2250	1–3, 5
JB2250MW	752B416G06	0	—	—	HM2P250W5W	1–3
JB2250SMW	752B416G18	0	—	—	HM2P250W5W	1–3, 4
JB2250S	NO STYLE	0	—	—	JDB2250	1–5
JB2250SW	NO STYLE	0	—	—	JDB2250W	1–5
JB2250SWK	NO STYLE	0	—	—	JDB2250KW	1–3, 5, 8
JB2250W	752B417G07	0	—	—	JDB2250W	1–3, 5
JB2250WK	752B046G01	0	—	—	JDB2250KW	1–3, 5, 8
JB2700MW	752B416G01	0	—	—	HM2P250A5W	1–3
JB2700SMW	752B416G13	0	—	—	HM2P250A5W	1–4
JB3070	NO STYLE	0	—	—	JDB3070	1–3, 5
JB3070S	NO STYLE	0	—	—	JDB3070	1–5
JB3070SW	NO STYLE	0	—	—	JDB3070W	1–5
JB3070W	752B417G08	0	—	—	JDB3070W	1–3, 5
JB3090	NO STYLE	0	—	—	JDB3090	1–3, 5
JB3090S	NO STYLE	0	—	—	JDB3090	1–5
JB3090SW	NO STYLE	0	—	—	JDB3090W	1–5
JB3090W	752B417G09	0	—	—	JDB3090W	1–3, 5
JB3100	NO STYLE	0	—	—	JDB3100	1–3, 5
JB3100S	NO STYLE	0	—	—	JDB3100	1–5
JB3100SW	NO STYLE	0	—	—	JDB3100W	1–5
JB3100W	752B417G10	0	—	—	JDB3100W	1–3, 5
JB3125	NO STYLE	0	—	—	JDB3125	1–3, 5
JB31250MW	752B416G08	0	—	—	HMCP250F5W	1–3
JB3100W	752B417G10	0	—	—	JDB3100W	1–3, 5
JB3125	NO STYLE	0	—	—	JDB3125	1–3, 5
JB31250MW	752B416G08	0	—	—	HMCP250F5W	1–3
JB31250SMW	752B416G20	0	—	—	HMCP250F5W	1–4
JB3125S	NO STYLE	0	—	—	JDB3125	1–5
JB3125SW	NO STYLE	0	—	—	JDB3125W	1–5
JB3125W	752B417G11	0	—	—	JDB3125W	1–3, 5
JB3150	NO STYLE	0	—	—	JDB3150	1–3, 5
JB31500MW	752B416G09	0	—	—	HMCP250G5W	1–3
JB31500SMW	752B416G21	0	—	—	HMCP250G5W	1–4
JB3150S	NO STYLE	0	—	—	JDB3150	1–5
JB3150SW	NO STYLE	0	—	—	JDB3150W	1–5
JB3150W	752B417G12	0	—	—	JDB3150W	1–3, 5
JB3175	69E1870	0	—	—	JDB3175	1–3, 5

Note

① 0 = Obsolete, A = Available.

Replacement Breaker Cross-Reference

Replacement Breaker		Status ①	Replacements			Notes (See Page V12-T3-114)
Catalog Number	Style Number		MARK 75 Catalog Number	MARK 75 Style Number	Series C Catalog Number	
JB31750MW	752B416G10	0	—	—	HMCP250J5W	1-3
JB31750SMW	752B416G22	0	—	—	HMCP250J5W	1-4
JB3175S	NO STYLE	0	—	—	JDB3175	1-5
JB3175SW	NO STYLE	0	—	—	JDB3175W	1-5
JB3175W	752B417G13	0	—	—	JDB3175W	1-3, 5
JB3200	69E9992	0	—	—	JDB3200	1-3, 5
JB3200S	NO STYLE	0	—	—	JDB3200	1-5
JB3200SW	NO STYLE	0	—	—	JDB3200W	1-5
JB3200W	752B417G14	0	—	—	JDB3200W	1-3, 5
JB3225	80E9836	0	—	—	JDB3225	1-3, 5
JB32250MW	752B416G11	0	—	—	HMCP250L5W	1-3
JB32250SMW	752B416G23	0	—	—	HMCP250L5W	1-4
JB3225S	63E6442	0	—	—	JDB3225	1-5
JB3225SW	752B417G15	0	—	—	JDB3225W	1-5
JB3225W	80E8211	0	—	—	JDB3225W	1-3, 5
JB3250	752B416G12	0	—	—	JDB3250	1-3, 5
JB32500MW	752B416G24	0	—	—	HMCP250W5W	1-3
JB32500SMW	NO STYLE	0	—	—	HMCP250W5W	1-4
JB3250S	NO STYLE	0	—	—	JDB3250	1-5
JB3250SW	NO STYLE	0	—	—	JDB3250W	1-5
JB3250W	752B417G16	0	—	—	JDB3250W	1-3, 5
JB3250WK	752B046G06	0	—	—	JDB3250KW	1-3, 5, 8
JB3250WSK	752B046G07	0	—	—	JDB3250KW	1-3, 5, 8
JB3700MW	752B416G07	0	—	—	HMCP250A5W	1-3
JB3700SMW	752B416G19	0	—	—	HMCP250A5W	1-4
KA2070	1255C53G02	0	—	—	JD2070	1-3, 5, 8, 9
KA2070S	1255C54G02	0	—	—	JD2070	1-5, 8, 9
KA2090	1255C53G03	0	—	—	JD2090	1-3, 5, 8, 9
KA2090S	1255C54G03	0	—	—	JD2090	1-5, 8, 9
KA2100	1255C53G04	0	—	—	KD2100	1-3, 5, 8, 9
KA2100S	1255C54G04	0	—	—	KD2100	1-5, 8, 9
KA2125	1255C53G05	0	—	—	KD2125	1-3, 5, 8, 9
KA2125S	1255C54G05	0	—	—	KD2125	1-5, 8, 9
KA2150	1255C53G06	0	—	—	KD2150	1-3, 5, 8, 9
KA2175	1255C53G07	0	—	—	KD2175	1-3, 5, 8, 9
KA2175S	1255C54G07	0	—	—	KD2175	1-5, 8, 9
KA2200	1255C53G08	0	—	—	KD2200	1-3, 5, 8, 9
KA2200S	1255C54G08	0	—	—	KD2200	1-5, 8, 9
KA2225	1255C53G09	0	—	—	KD2225	1-3, 5, 8, 9
KA2225F	2602D86G01	0	—	—	KD2400F	2, 8
KA2225FS	2602D86G03	0	—	—	KD2400F	2, 4, 8
KA2225S	1255C54G09	0	—	—	KD2225	1-5, 8, 9
KA2225WK	752B047G03	0	—	—	KD2400KW	1-3, 5, 8, 9
KA2225WSK	752B047G04	0	—	—	KD2400KW	1-3, 5, 8, 9
KA2150S	1255C54G06	0	—	—	KD2150	1-5, 8, 9
KA3070	1255C53G17	0	—	—	JD3070	1-3, 5, 8, 9
KA3070S	1255C54G17	0	—	—	JD3070	1-5, 8, 9

Note

① 0 = Obsolete, A = Available.

Replacement Breaker Cross-Reference

Replacement Breaker			Replacements			Notes
Catalog Number	Style Number	Status ^①	MARK 75 Catalog Number	MARK 75 Style Number	Series C Catalog Number	(See Page V12-T3-114)
KA3090	1255C53G18	0	—	—	JD3090	1-3, 5, 8, 9
KA3090S	1255C54G18	0	—	—	JD3090	1-5, 8, 9
KA3100	1255C53G19	0	—	—	KD3100	1-3, 5, 8, 9
KA3100S	1255C54G19	0	—	—	KD3100	1-5, 8, 9
KA3125	1255C53G20	0	—	—	KD3125	1-3, 5, 8, 9
KA3125S	1255C54G20	0	—	—	KD3125	1-5, 8, 9
KA3150	1255C53G21	0	—	—	KD3150	1-3, 5, 8, 9
KA3150S	1255C54G21	0	—	—	KD3150	1-5, 8, 9
KA3175	1255C53G22	0	—	—	KD3175	1-3, 5, 8, 9
KA3175S	504C335G22	0	—	—	KD3175	1-5, 8, 9
KA3200	504C335G23	0	—	—	KD3200	1-3, 5, 8, 9
KA3200S	504C335G23	0	—	—	KD3200	1-5, 8, 9
KA3225	504C336G24	0	—	—	KD3225	1-3, 5, 8, 9
KA3225F	2602D86G02	0	—	—	KD3400F	2, 8
KA3225FS	2602D86G04	0	—	—	KD3400F	2, 4, 8
KA3225S	504C335G24	0	—	—	KD3225	1-5, 8, 9
KA3225WK	752B047G08	0	—	—	KD3400KW	1-3, 5, 8, 9
KA3225WSK	752B047G09	0	—	—	KD3400KW	1-3, 5, 8, 9
KB2070	1291C40G01	0	—	—	JD2070	1-3, 5
KB2090	1291C40G02	0	—	—	JD2090	1-3, 5
KB2100	1291C40G03	0	—	—	JD2100	1-3, 5
KB2125	1291C40G04	0	—	—	JD2125	1-3, 5
KB2150	1291C40G05	0	—	—	JD2150	1-3, 5
KB2175	1291C40G06	0	—	—	JD2175	1-3, 5
KB2200	1291C40G07	0	—	—	JD2200	1-3, 5
KB2225	1291C40G08	0	—	—	JD2225	1-3, 5
KB2250	1291C40G09	0	—	—	JD2250	1-3, 5
KB2250F	2601D44G13	0	—	—	JD2250F	—
KB2250FS	2601D44G17	0	—	—	JD2250F	—
KB2250WK	752B046G03	0	—	—	JD2250KW	1-3, 5, 8
KB2250WSK	752B046G04	0	—	—	JD2250KW	1-3, 5, 8
KB3070	1291C40G16	0	—	—	JD3070	1-3, 5
KB3090	1291C40G17	0	—	—	JD3090	1-3, 5
KB3100	1291C40G18	0	—	—	JD3100	1-3, 5
KB3125	1291C40G19	0	—	—	JD3125	1-3, 5
KB3150	1291C40G20	0	—	—	JD3150	1-3, 5
KB3175	1291C40G21	0	—	—	JD3175	1-3, 5
KB3200	1291C40G22	0	—	—	JD3200	1-3, 5
KB3225	1291C40G23	0	—	—	JD3225	1-3, 5
KB3250	1291C40G24	0	—	—	JD3250	1-3, 5
KB3250F	2601D44G14	0	—	—	JD3250F	—
KB3250WK	752B046G08	0	—	—	JD3250KW	1-3, 5, 8
KB3250WSK	752B046G09	0	—	—	JD3250KW	1-3, 5, 8
LA2070	1255C72G02	0	—	—	KD2070	1-3, 5, 8
LA2070S	1255C73G02	0	—	—	KD2070	1-5, 8
LA2090	1255C72G03	0	—	—	KD2090	1-3, 5, 8
LA2090S	1255C73G03	0	—	—	KD2090	1-5, 8

Note

① 0 = Obsolete, A = Available.

Replacement Breaker Cross-Reference

Replacement Breaker		Status ^①	Replacements		Series C Catalog Number	Notes (See Page V12-T3-114)
Catalog Number	Style Number		MARK 75 Catalog Number	MARK 75 Style Number		
LA2100	1255C72G04	0	—	—	KD2100	1-3, 5, 8
LA2100S	1255C73G04	0	—	—	KD2100	1-5, 8
LA2125	1255C72G05	0	—	—	KD2125	1-3, 5, 8
LA2125S	1255C73G05	0	—	—	KD2125	1-5, 8
LA2150	1255C72G06	0	—	—	KD2150	1-3, 5, 8
LA2150S	1255C73G06	0	—	—	KD2150	1-5, 8
LA2175	1255C72G07	0	—	—	KD2175	1-3, 5, 8
LA2175S	1255C73G07	0	—	—	KD2175	1-5, 8
LA2200	1255C72G08	0	—	—	KD2200	1-3, 5, 8
LA2200S	1255C73G08	0	—	—	KD2200	1-5, 8
LA2225	1255C72G09	0	—	—	KD2225	1-3, 5, 8
LA2225S	1255C73G09	0	—	—	KD2225	1-5, 8
LA2250	1255C72G10	0	—	—	KD2250	1-3, 5, 8
LA2250S	1255C73G10	0	—	—	KD2250	1-5, 8
LA2300	1255C72G11	0	—	—	KD2300	1-3, 5, 8
LA2300S	1255C73G11	0	—	—	KD2300	1-5, 8
LA2350	1255C72G12	0	—	—	KD2350	1-3, 5, 8
LA2350S	1255C73G12	0	—	—	KD2350	1-5, 8
LA2400	1255C72G13	0	—	—	KD2400	1-3, 5, 8
LA2400F	2602D99G01	0	—	—	KD2400F	1-3, 5, 8
LA2400FS	2602D99G03	0	—	—	KD2400F	1-5, 8
LA2400S	1255C73G13	0	—	—	KD2400	1-5, 8
LA2400WK	752B042G01	0	—	—	KD2400KW	1-3, 5, 8
LA2400WSK	752B042G02	0	—	—	KD2400KW	1-3, 5, 8
LA2500	2603D50G05	0	—	—	LD2500	1-3, 5, 8
LA2500S	2603D50G17	0	—	—	LD2500	1-5, 8
LA2600	2603D50G06	0	—	—	LD2500	1-3, 5, 8
LA2600F	2603D48G01	0	—	—	LD2600F	1-3, 5, 8
LA2600FS	2603D48G03	0	—	—	LD2600F	1-5, 8
LA2600S	2600D50G18	0	—	—	LD2600	1-5, 8
LA2600WK	752B043G01	0	—	—	LD2600KW	1-3, 5, 8
LA2600WSK	752B043G02	0	—	—	LD2600KW	1-3, 5, 8
LA3070	1255C72G17	0	HLA3070	504C740G17	KD3070	1-3, 5, 8
LA3070S	504C612G17	0	HLA3070	504C740G17	KD3070	1-5, 8
LA3090	1255C72G18	0	HLA3090	504C740G18	KD3090	1-3, 5, 8
LA3090S	504C612G18	0	HLA3090	504C740G18	KD3090	1-5, 8
LA3100	1255C72G19	0	HLA3100	504C740G19	KD3100	1-3, 5, 8
LA3100S	504C612G19	0	HLA3100	504C740G19	KD3100	1-5, 8
LA3125	1255C72G20	0	HLA3125	504C740G20	KD3125	1-3, 5, 8
LA3125S	504C612G20	0	HLA3125	504C740G20	KD3125	1-5, 8
LA3150	1255C72G21	0	HLA3150	504C740G21	KD3150	1-3, 5, 8
LA3150S	504C612G21	0	HLA3150	504C740G21	KD3150	1-5, 8
LA3175	1255C72G22	0	HLA3175	504C740G22	KD3175	1-3, 5, 8
LA3175S	504C612G22	0	HLA3175	504C740G22	KD3175	1-5, 8
LA3200	1255C72G23	0	HLA3200	504C740G23	KD3200	1-3, 5, 8
LA3200S	504C612G23	0	HLA3200	504C740G23	KD3200	1-5, 8
LA3225	1255C72G24	0	HLA3225	504C740G24	KD3225	1-3, 5, 8

Note

^① 0 = Obsolete, A = Available.

Replacement Breaker Cross-Reference

Replacement Breaker			Replacements			Notes
Catalog Number	Style Number	Status ①	MARK 75 Catalog Number	MARK 75 Style Number	Series C Catalog Number	(See Page V12-T3-114)
LA3225S	504C612G24	0	HLA3225	504C740G24	KD3225	1-5, 8
LA3250	1255C72G25	0	HLA3250	504C740G25	KD3250	1-3, 5, 8
LA3250S	504C612G25	0	HLA3250	504C740G25	KD3250	1-5, 8
LA3300	1255C72G26	0	HLA3300	504C740G26	KD3300	1-3, 5, 8
LA3300S	504C612G26	0	HLA3300	504C740G26	KD3300	1-5, 8
LA3350	1255C72G27	0	HLA3350	504C740G27	KD3350	1-3, 5, 8
LA3350S	504C612G27	0	HLA3350	504C740G27	KD3350	1-5, 8
LA3400	1255C72G27	0	HLA3400	504C740G28	KD3400	1-3, 5, 8
LA3400F	2602D99G02	0	HLA3400F	673B352G02	KD3400F	1-3, 5, 8
LA3400FS	673B352G02	0	HLA3400F	673B352G02	KD3400F	1-5, 8
LA3400S	1255C73G28	0	HLA3400	504C740G28	KD3400	1-5, 8
LA3400WK	752B042G06	0	—	—	KD3400KW	1-3, 5, 8
LA3400WSK	752B042G07	0	—	—	KD3400KW	1-3, 5, 8
LA3500	376D551G11	0	HLA3500	177C429G16	LD3500	1-3, 5, 8
LA3500S	376D551G23	0	HLA3500	177C429G16	LD3500	1-5, 8
LA3600	376D551G12	0	HLA3600	177C429G17	LD3600	1-3, 5, 8
LA3600F	375D400G02	0	HLA3600F	375D400G10	LD3600F	1-3, 5, 8
LA3600FS	375D400G04	0	HLA3600F	375D400G10	LD3600F	1-5, 8
LA3600S	376D551G24	0	HLA3600	177C429G17	LD3600	1-5, 8
LA3600WK	752B043G06	0	—	—	LD3600KW	1-3, 5, 8
LA3600WSK	752B043G07	0	—	—	LD3600KW	1-3, 5, 8
LAB2125	372D300G05	0	—	—	KDB2125	1-3, 5, 8
LAB21250MW	371D426G03	0	—	—	HM2P400F5W	1-3, 5, 8
LAB21250SMW	371D426G23	0	—	—	HM2P400F5W	1-5, 8
LAB2125A	372D301G45	0	—	—	KDB2125	1-3, 5, 8
LAB2125S	372D300G37	0	—	—	KDB2125	1-5, 8
LAB2125SW	371D333G37	0	—	—	KDB2125W	1-5, 8
LAB2125W	371D333G05	0	—	—	KDB2125W	1-3, 5, 8
LAB2150	372D300G06	0	—	—	KDB2150	1-3, 5, 8
LAB21500MW	371D426G04	0	—	—	HM2P400G5W	1-3, 5, 8
LAB21500SMW	371D426G24	0	—	—	HM2P400G5W	1-5, 8
LAB2150A	372D301G46	0	—	—	KDB2150	1-3, 5, 8
LAB2150S	372D300G38	0	—	—	KDB2150	1-5, 8
LAB2150SW	371D333G38	0	—	—	KDB2150W	1-5, 8
LAB2150W	371D333G06	0	—	—	KDB2150W	1-3, 5, 8
LAB2175	372D300G07	0	—	—	KDB2175	1-3, 5, 8
LAB21750MW	371D426G05	0	—	—	HM2P400J5W	1-3, 5, 8
LAB21750SMW	371D426G25	0	—	—	HM2P400J5W	1-5, 8
LAB2175A	372D301G47	0	—	—	KDB2175	1-3, 5, 8
LAB2175S	372D300G39	0	—	—	KDB2175	1-5, 8
LAB2175SW	371D333G39	0	—	—	KDB2175W	1-5, 8
LAB2175W	371D333G07	0	—	—	KDB2175W	1-3, 5, 8
LAB2200	372D300G08	0	—	—	KDB2200	1-3, 5, 8
LAB2200A	371D301G48	0	—	—	KDB2200	1-3, 5, 8
LAB2200S	372D300G40	0	—	—	KDB2200	1-5, 8
LAB2200SW	371D333G40	0	—	—	KDB2200W	1-5, 8
LAB2200W	371D333G08	0	—	—	KDB2200W	1-3, 5, 8

Note

① 0 = Obsolete, A = Available.

Replacement Breaker Cross-Reference

Replacement Breaker		Status ①	Replacements		Series C Catalog Number	Notes (See Page V12-T3-114)
Catalog Number	Style Number		MARK 75 Catalog Number	MARK 75 Style Number		
LAB2225	372D300G09	0	—	—	KDB2225	1-3, 5, 8
LAB22250MW	371D426G06	0	—	—	HM2P400L5W	1-3, 5, 8
LAB22250SMW	371D426G26	0	—	—	HM2P400L5W	1-5, 8
LAB2225A	372D301G49	0	—	—	KDB2225	1-3, 5, 8
LAB2225S	372D300G41	0	—	—	KDB2225	1-5, 8
LAB2225SW	371D333G41	0	—	—	KDB2225W	1-5, 8
LAB2225W	371D333G09	0	—	—	KDB2225W	1-3, 5, 8
LAB22400A	NO STYLE	0	—	—	KDB2400	1-3, 5, 8
LAB2250	372D300G10	0	—	—	KDB2250	1-3, 5, 8
LAB2250A	372D301G50	0	—	—	KDB2250	1-3, 5, 8
LAB2250S	372D300G42	0	—	—	KDB2250	1-5, 8
LAB2250SW	371D333G42	0	—	—	KDB2250W	1-5, 8
LAB2250W	371D333G10	0	—	—	KDB2250W	1-3, 5, 8
LAB2300	372D300G11	0	—	—	KDB2300	1-3, 5, 8
LAB23000MW	371D426G07	0	—	—	HM2P400N5W	1-3, 5, 8
LAB23000SMW	371D426G27	0	—	—	HM2P400N5W	1-5, 8
LAB2300A	372D301G51	0	—	—	KDB2300	1-3, 5, 8
LAB2300S	372D300G43	0	—	—	KDB2300	1-5, 8
LAB2300SW	371D333G43	0	—	—	KDB2300W	1-5, 8
LAB2300W	371D333G11	0	—	—	KDB2300W	1-3, 5, 8
LAB2350	372D300G12	0	—	—	KDB2350	1-3, 5, 8
LAB2350A	372D301G52	0	—	—	KDB2350	1-3, 5, 8
LAB2350S	372D300G44	0	—	—	KDB2350	1-5, 8
LAB2350W	371D333G12	0	—	—	KDB2350W	1-3, 5, 8
LAB2400	372D300G13	0	—	—	KDB2400	1-3, 5, 8
LAB24000MW	371D426G08	0	—	—	HM2P400X5W	1-3, 5, 8
LAB24000SMW	371D426G28	0	—	—	HM2P400X5W	1-5, 8
LAB2400S	372D300G45	0	—	—	KDB2400	1-5, 8
LAB2400SW	371D333G45	0	—	—	KDB2400W	1-5, 8
LAB2400W	371D333G13	0	—	—	KDB2400W	1-3, 5, 8
LAB2400WK	752B042G03	0	—	—	KDB2400KW	1-3, 5, 8
LAB2400WSK	752B042G04	0	—	—	KDB2400KW	1-3, 5, 8
LAB2700MW	371D426G02	0	—	—	HM2P400D5W	1-3, 5, 8
LAB2700SMW	371D426G22	0	—	—	HM2P400D5W	1-3, 5, 8
LAB3125	372D300G20	0	HLA3125	504C740G20	KDB3125	1-3, 5, 8
LAB31250MW	371D426G13	0	HLA31250MW	—	HMCP400F5W	1-3, 5, 8
LAB31250SMW	371D426G33	0	HLA31250MW	—	HMCP400F5W	1-5, 8
LAB3125A	372D301G60	0	HLA3125	504C740G20	KDB3125	1-3, 5, 8
LAB3125S	372D300G52	0	HLA3125	504C740G20	KDB3125	1-5, 8
LAB3125SW	371D333G52	0	HLA3125W	—	KDB3125W	1-5, 8
LAB3125W	371D333G20	0	HLA3125W	—	KDB3125W	1-3, 5, 8
LAB3150	372D300G21	0	HLA3150	504C740G21	KDB3150	1-3, 5, 8
LAB31500MW	371D426G14	0	HLA31500MW	—	HMCP400G5W	1-3, 5, 8
LAB31500SMW	371D426G34	0	HLA31500MW	—	HMCP400G5W	1-5, 8
LAB3150A	372D301G61	0	HLA3150	504C740G21	KDB3150	1-3, 5, 8
LAB3150S	372D300G53	0	HLA3150	504C740G21	KDB3150	1-5, 8
LAB3150SW	371D333G53	0	HLA3150W	—	KDB3150W	1-5, 8

Note

① 0 = Obsolete, A = Available.

Replacement Breaker Cross-Reference

Replacement Breaker			Replacements			Notes
Catalog Number	Style Number	Status ①	MARK 75 Catalog Number	MARK 75 Style Number	Series C Catalog Number	(See Page V12-T3-114)
LAB3150W	371D333G21	0	HLA3150W	—	KDB3150W	1–3, 5, 8
LAB3175	372D300G22	0	HLA3175	504C740G22	KDB3175	1–3, 5, 8
LAB31750MW	371D426G15	0	HLA31750MW	—	HMCP400J5W	1–3, 5, 8
LAB31750SMW	371D426G35	0	HLA31750MW	—	HMCP400J5W	1–5, 8
LAB3175A	372D301G62	0	HLA3175	504C740G22	KDB3175	1–3, 5, 8
LAB3175S	372D300G54	0	HLA3175	504C740G22	KDB3175	1–5, 8
LAB3175SW	371D333G54	0	HLA3175W	—	KDB3175W	1–5, 8
LAB3175W	371D333G22	0	HLA3175W	—	KDB3175W	1–3, 5, 8
LAB3200	372D300G23	0	HLA3200	504C740G23	KDB3200	1–3, 5, 8
LAB3200A	372D301G63	0	HLA3200	504C740G23	KDB3200	1–3, 5, 8
LAB3200S	372D300G55	0	HLA3200	504C740G23	KDB3200	1–5, 8
LAB3200SW	371D333G55	0	HLA3200W	—	KDB3200W	1–5, 8
LAB3200W	371D333G23	0	HLA3200W	—	KDB3200W	1–3, 5, 8
LAB3225	372D300G24	0	HLA3225	504C740G24	KDB3225	1–3, 5, 8
LAB32250MW	371D426G16	0	HLA32250MW	—	HMCP400L5W	1–3, 5, 8
LAB32250SMW	371D426G36	0	HLA32250MW	—	HMCP400L5W	1–5, 8
LAB3225A	372D301G64	0	HLA3225	504C740G24	KDB3225	1–3, 5, 8
LAB3225S	372D300G56	0	HLA3225	504C740G24	KDB3225	1–5, 8
LAB3225SW	371D333G56	0	HLA3225W	—	KDB3225W	1–5, 8
LAB3225W	371D333G24	0	HLA3225W	—	KDB3225W	1–3, 5, 8
LAB3250	372D300G25	0	HLA3250	504C740G25	KDB3250	1–3, 5, 8
LAB3250A	372D301G65	0	HLA3250	504C740G25	KDB3250	1–3, 5, 8
LAB3250S	372D300G57	0	HLA3250	504C740G25	KDB3250	1–5, 8
LAB3250SW	371D333G57	0	HLA3250W	—	KDB3250W	1–5, 8
LAB3250W	371D333G25	0	HLA3250W	—	KDB3250W	1–3, 5, 8
LAB3300	372D300G26	0	HLA3300	504C740G26	KDB3300	1–3, 5, 8
LAB33000MW	371D426G17	0	HLA33000MW	—	HMCP400N5W	1–3, 5, 8
LAB33000SMW	371D426G37	0	HLA33000MW	—	HMCP400N5W	1–5, 8
LAB3300A	372D301G66	0	HLA3300	504C740G26	KDB3300	1–3, 5, 8
LAB3300S	372D300G58	0	HLA3300	504C740G26	KDB3300	1–5, 8
LAB3300SW	371D333G58	0	HLA3300W	—	KDB3300W	1–, 5, 8
LAB3300W	371D333G26	0	HLA3300W	—	KDB3300W	1–3, 5, 8
LAB3350A	372D301G67	0	HLA3350	504C740G27	KDB3350	1–3, 5, 8
LAB3350S	372D300G59	0	HLA3350	504C740G27	KDB3350	1–5, 8
LAB3350SW	371D333G59	0	HLA3350W	—	KDB3350W	1–5, 8
LAB3400	372D300G28	0	HLA3400	504C740G28	KDB3400	1–3, 5, 8
LAB34000MW	371D426G18	0	HLA34000MW	—	HMCP400X5W	1–3, 5, 8
LAB34000SMW	371D426G38	0	HLA34000MW	—	HMCP400X5W	1–5, 8
LAB3400A	372D301G68	0	HLA3400	504C740G28	KDB3400	1–3, 5, 8
LAB3400S	372D300G60	0	HLA3400	504C740G28	KDB3400	1–5, 8
LAB3400SW	371D333G60	0	HLA3400W	—	KDB3400W	1–5, 8
LAB3400W	371D333G28	0	HLA3400W	—	KDB3400W	1–3, 5, 8
LAB3400WK	752B042G08	0	—	—	KDB3400KW	1–3, 5, 8
LAB3400WSK	752B042G09	0	—	—	KDB3400KW	1–3, 5, 8
LAB3700MW	371D426G12	0	HLA3700MW	—	HMCP400D5W	1–3, 5, 8
LAB3700SMW	371D426G32	0	HLA3700MW	—	HMCP400D5W	1–5, 8
LAY3250	NO STYLE	0	—	—	HKD3250	—

Note

① 0 = Obsolete, A = Available.

Replacement Breaker Cross-Reference

Replacement Breaker		Status ①	Replacements			Notes (See Page V12-T3-114)
Catalog Number	Style Number		MARK 75 Catalog Number	MARK 75 Style Number	Series C Catalog Number	
LAY3300	NO STYLE	0	—	—	HLD3300	—
LAY3350	NO STYLE	0	—	—	HLD3350	—
LAY3400	NO STYLE	0	—	—	HLD3400	—
LAY3500	NO STYLE	0	—	—	HLD3500	—
LAY3600	NO STYLE	0	—	—	HLD3600	—
LAY3600F	1240C53G01	0	—	—	HLD3600F	—
LB2070	179C800G01	0	—	—	KD2070	1–3, 5, 8, 9
LB2070S	179C803G01	0	—	—	KD2070	1–5, 8, 9
LB2090	179C800G02	0	—	—	KD2090	1–3, 5, 8, 9
LB2090S	179C803G02	0	—	—	KD2090	1–5, 8, 9
LB2100	179C800G03	0	—	—	KD2100	1–3, 5, 8, 9
LB2100S	179C803G03	0	—	—	KD2100	1–5, 8, 9
LB2125	179C800G04	0	—	—	KD2125	1–3, 5, 8, 9
LB2125S	179C803G04	0	—	—	KD2125	1–5, 8, 9
LB2150	179C800G05	0	—	—	KD2150	1–3, 5, 8, 9
LB2150S	179C803G05	0	—	—	KD2150	1–5, 8, 9
LB2175	179C800G06	0	—	—	KD2175	1–3, 5, 8, 9
LB2175S	179C803G06	0	—	—	KD2175	1–5, 8, 9
LB2200	179C800G07	0	—	—	KD2200	1–3, 5, 8, 9
LB2200S	179C803G07	0	—	—	KD2200	1–5, 8, 9
LB2225	179C800G08	0	—	—	KD2225	1–3, 5, 8, 9
LB2225S	179C803G08	0	—	—	KD2225	1–5, 8, 9
LB2250	179C800G09	0	—	—	KD2250	1–3, 5, 8, 9
LB2250S	179C803G09	0	—	—	KD2250	1–5, 8, 9
LB2300	179C800G10	0	—	—	KD2300	1–3, 5, 8, 9
LB2300S	179C803G10	0	—	—	KD2300	1–5, 8, 9
LB2350	179C800G11	0	—	—	KD2350	1–3, 5, 8, 9
LB2400	179C800G12	0	—	—	KD2400	1–3, 5, 8, 9
LB2400F	5680D03G07	0	—	—	KD2400F	1–3, 5, 8, 9
LB2400FS	5680D03G11	0	—	—	KD2400F	1–5, 8, 9
LB2400S	179C803G12	0	—	—	KD2400	1–5, 8, 9
LB2400WK	752B048G02	0	—	—	KD2400KW	1–3, 5, 8, 9
LB2400WSK	752B048G04	0	—	—	KD2400KW	1–3, 5, 8, 9
LB3070	179C800G16	0	—	—	KD3070	1–3, 5, 8, 9
LB3070S	179C803G16	0	—	—	KD3070	1–5, 8, 9
LB3090	179C800G17	0	—	—	KD3090	1–3, 5, 8, 9
LB3090S	179C803G17	0	—	—	KD3090	1–5, 8, 9
LB3100	179C800G18	0	—	—	KD3100	1–3, 5, 8, 9
LB3100S	179C803G18	0	—	—	KD3100	1–5, 8, 9
LB3125	179C800G19	0	—	—	KD3125	1–3, 5, 8, 9
LB3125S	179C803G19	0	—	—	KD3125	1–5, 8, 9
LB3150	179C800G20	0	—	—	KD3150	1–3, 5, 8, 9
LB3150S	179C803G20	0	—	—	KD3150	1–5, 8, 9
LB3175	179C800G21	0	—	—	KD3175	1–3, 5, 8, 9
LB3175S	179C803G21	0	—	—	KD3175	1–5, 8, 9
LB3200	179C800G22	0	—	—	KD3200	1–3, 5, 8, 9
LB3200S	179C803G22	0	—	—	KD3200	1–5, 8, 9

Note

① 0 = Obsolete, A = Available.

Replacement Breaker Cross-Reference

Replacement Breaker			Replacements			Notes
Catalog Number	Style Number	Status ①	MARK 75 Catalog Number	MARK 75 Style Number	Series C Catalog Number	(See Page V12-T3-114)
LB3225	179C800G23	0	—	—	KD3225	1-3, 5, 8, 9
LB3225S	179C803G23	0	—	—	KD3225	1-5, 8, 9
LB3250	179C800G24	0	—	—	KD3250	1-3, 5, 8, 9
LB3250S	179C803G24	0	—	—	KD3250	1-5, 8, 9
LB3300	179C800G25	0	—	—	KD3300	1-3, 5, 8, 9
LB3300S	179C803G25	0	—	—	KD3300	1-5, 8, 9
LB3350	179C800G26	0	—	—	KD3350	1-3, 5, 8, 9
LB3400	179C800G27	0	—	—	KD3400	1-3, 5, 8, 9
LB3400F	5680D03G08	0	—	—	KD3400F	1-3, 5, 8, 9
LB3400FS	5680D03G12	0	—	—	KD3400F	1-5, 8, 9
LB3400S	179C803G27	0	—	—	KD3400	1-5, 8, 9
LB3400WK	752B048G07	0	—	—	KD3400KW	1-3, 5, 8, 9
LB3400WSK	752B048G09	0	—	—	KD3400KW	1-3, 5, 8, 9
LBB2125	179C806G04	0	—	—	KDB2125	1-3, 5, 8, 9
LBB21250MW	179C811G02	0	—	—	HM2P400F5W	1-3, 5, 8, 9
LBB21250SMW	179C832G02	0	—	—	HM2P400F5W	1-5, 8, 9
LBB2125A	179C807G04	0	—	—	KDB2125	1-3, 5, 8, 9
LBB2125S	179C827G04	0	—	—	KDB2125	1-5, 8, 9
LBB2125SA	179C828G04	0	—	—	KDB2125	1-5, 8, 9
LBB2125SW	179C830G04	0	—	—	KDB2125W	1-5, 8, 9
LBB2125W	179C809G04	0	—	—	KDB2125W	1-3, 5, 8, 9
LBB2150	179C806G05	0	—	—	KDB2150	1-3, 5, 8, 9
LBB21500MW	179C811G03	0	—	—	HM2P400G5W	1-3, 5, 8, 9
LBB21500SMW	179C832G03	0	—	—	HM2P400G5W	1-5, 8, 9
LBB2150A	179C807G05	0	—	—	KDB2150	1-3, 5, 8, 9
LBB2150S	179C827G05	0	—	—	KDB2150	1-5, 8, 9
LBB2150SA	179C828G05	0	—	—	KDB2150	1-5, 8, 9
LBB2150SW	179C830G05	0	—	—	KDB2150W	1-5, 8, 9
LBB2150W	179C809G05	0	—	—	KDB2150W	1-3, 5, 8, 9
LBB2175	179C806G06	0	—	—	KDB2175	1-3, 5, 8, 9
LBB21750MW	179C811G04	0	—	—	HM2P400J5W	1-3, 5, 8, 9
LBB21750SMW	179C832G04	0	—	—	HM2P400J5W	1-5, 8, 9
LBB2175A	179C807G06	0	—	—	KDB2175	1-3, 5, 8, 9
LBB2175S	179C827G06	0	—	—	KDB2175	1-5, 8, 9
LBB2175SA	179C828G06	0	—	—	KDB2175	1-5, 8, 9
LBB2175SW	179C830G06	0	—	—	KDB2175W	1-5, 8, 9
LBB2175W	179C809G06	0	—	—	KDB2175W	1-3, 5, 8, 9
LBB2200	179C806G07	0	—	—	KDB2200	1-3, 5, 8, 9
LBB2200A	179C807G07	0	—	—	KDB2200	1-3, 5, 8, 9
LBB2200S	179C827G07	0	—	—	KDB2200	1-5, 8, 9
LBB2200SA	179C828G07	0	—	—	KDB2200	1-5, 8, 9
LBB2200SW	179C830G07	0	—	—	KDB2200W	1-5, 8, 9
LBB2200W	179C809G07	0	—	—	KDB2200W	1-3, 5, 8, 9
LBB2225	179C806G08	0	—	—	KDB2225	1-3, 5, 8, 9
LBB22250MW	179C811G05	0	—	—	HM2P400L5W	1-3, 5, 8, 9
LBB22250SMW	179C832G05	0	—	—	HM2P400L5W	1-5, 8, 9
LBB2225A	179C807G08	0	—	—	KDB2225	1-3, 5, 8, 9

Note

① 0 = Obsolete, A = Available.

Replacement Breaker Cross-Reference

Replacement Breaker		Status ①	Replacements			Notes (See Page V12-T3-114)
Catalog Number	Style Number		MARK 75 Catalog Number	MARK 75 Style Number	Series C Catalog Number	
LBB2225S	179C827G08	0	—	—	KDB2225	1-5, 8, 9
LBB2225SA	179C828G08	0	—	—	KDB2225	1-5, 8, 9
LBB2225SW	179C830G08	0	—	—	KDB2225W	1-5, 8, 9
LBB2225S	179C827G08	0	—	—	KDB2225	1-5, 8, 9
LBB2225SA	179C828G08	0	—	—	KDB2225	1-5, 8, 9
LBB2225SW	179C830G08	0	—	—	KDB2225W	1-5, 8, 9
LBB2225W	179C809G08	0	—	—	KDB2225W	1-3, 5, 8, 9
LBB2250	179C806G09	0	—	—	KDB2250	1-3, 5, 8, 9
LBB2250A	179C807G09	0	—	—	KDB2250	1-3, 5, 8, 9
LBB2250S	179C827G09	0	—	—	KDB2250	1-5, 8, 9
LBB2250SA	179C828G09	0	—	—	KDB2250	1-5, 8, 9
LBB2250SW	179C830G09	0	—	—	KDB2250W	1-5, 8, 9
LBB2250W	179C809G09	0	—	—	KDB2250W	1-3, 5, 8, 9
LBB2300	179C806G10	0	—	—	KDB2300	1-3, 5, 8, 9
LBB2300MW	179C811G06	0	—	—	HM2P400N5W	1-3, 5, 8, 9
LBB2300SMW	179C832G06	0	—	—	HM2P400N5W	1-5, 8, 9
LBB2300A	179C807G10	0	—	—	KDB2300	1-3, 5, 8, 9
LBB2300S	179C827G10	0	—	—	KDB2300	1-5, 8, 9
LBB2300SA	179C828G10	0	—	—	KDB2300	1-5, 8, 9
LBB2300SW	179C830G10	0	—	—	KDB2300W	1-5, 8, 9
LBB2300W	179C809G10	0	—	—	KDB2300W	1-3, 5, 8, 9
LBB2350	179C806G11	0	—	—	KDB2350	1-3, 5, 8, 9
LBB2350A	179C807G11	0	—	—	KDB2350	1-3, 5, 8, 9
LBB2350SA	179C828G11	0	—	—	KDB2350	1-5, 8, 9
LBB2350SW	179C830G11	0	—	—	KDB2350W	1-5, 8, 9
LBB2350W	179C809G11	0	—	—	KDB2350W	1-3, 5, 8, 9
LBB2400	179C806G12	0	—	—	KDB2400	1-3, 5, 8, 9
LBB2400MW	179C811G07	0	—	—	HM2P400X5W	1-3, 5, 8, 9
LBB2400SMW	179C832G07	0	—	—	HM2P400X5W	1-5, 8, 9
LBB2400A	179C807G12	0	—	—	KDB2400	1-3, 5, 8, 9
LBB2400S	179C827G12	0	—	—	KDB2400	1-5, 8, 9
LBB2400SA	179C828G12	0	—	—	KDB2400	1-5, 8, 9
LBB2400SW	179C830G12	0	—	—	KDB2400W	1-5, 8, 9
LBB2400W	179C809G12	0	—	—	KDB2400W	1-3, 5, 8, 9
LBB2400WK	752B048G01	0	—	—	KDB2400KW	1-3, 5, 8, 9
LBB2400WSK	752B048G03	0	—	—	KDB2400KW	1-3, 5, 8, 9
LBB2700MW	179C811G01	0	—	—	HM2P400D5W	1-3, 5, 7-9
LBB2700SMW	179C832G01	0	—	—	HM2P400D5W	1-5, 7-9
LBB3125	179C806G19	0	—	—	KDB3125	1-3, 5, 8, 9
LBB3125MW	179C811G17	0	—	—	HMCP400F5W	1-3, 5, 8, 9
LBB3125SMW	179C832G17	0	—	—	HMCP400F5W	1-5, 8, 9
LBB3125A	179C807G19	0	—	—	KDB3125	1-3, 5, 8, 9
LBB3125S	179C827G19	0	—	—	KDB3125	1-5, 8, 9
LBB3125SA	179C828G19	0	—	—	KDB3125	1-5, 8, 9
LBB3125SW	179C830G19	0	—	—	KDB3125W	1-5, 8, 9
LBB3125W	179C809G19	0	—	—	KDB3125W	1-3, 5, 8, 9
LBB3150	179C806G20	0	—	—	KDB3150	1-3, 5, 8, 9

Note

① 0 = Obsolete, A = Available.

Replacement Breaker Cross-Reference

Replacement Breaker			Replacements			Notes
Catalog Number	Style Number	Status ①	MARK 75 Catalog Number	MARK 75 Style Number	Series C Catalog Number	(See Page V12-T3-114)
LBB31500MW	179C811G18	0	—	—	HMCP400G5W	1-3, 5, 8, 9
LBB31500SMW	179C832G18	0	—	—	HMCP400G5W	1-5, 8, 9
LBB3150A	179C807G20	0	—	—	KDB3150	1-3, 5, 8, 9
LBB3150S	179C827G20	0	—	—	KDB3150	1-5, 8, 9
LBB3150SA	179C828G20	0	—	—	KDB3150	1-5, 8, 9
LBB3150SW	179C830G20	0	—	—	KDB3150W	1-5, 8, 9
LBB3150W	179C809G20	0	—	—	KDB3150W	1-3, 5, 8, 9
LBB3175	179C806G21	0	—	—	KDB3175	1-3, 5, 8, 9
LBB31750MW	179C811G19	0	—	—	HMCP400J5W	1-3, 5, 8, 9
LBB31750SMW	179C832G19	0	—	—	HMCP400J5W	1-5, 8, 9
LBB3175A	179C807G21	0	—	—	KDB3175	1-3, 5, 8, 9
LBB3175S	179C827G21	0	—	—	KDB3175	1-5, 8, 9
LBB3175SA	179C828G21	0	—	—	KDB3175	1-5, 8, 9
LBB3175SW	179C830G21	0	—	—	KDB3175W	1-5, 8, 9
LBB3175W	179C809G21	0	—	—	KDB3175W	1-3, 5, 8, 9
LBB3200	179C806G22	0	—	—	KDB3200	1-3, 5, 8, 9
LBB3200A	179C807G22	0	—	—	KDB3200	1-3, 5, 8, 9
LBB3200S	179C827G22	0	—	—	KDB3200	1-5, 8, 9
LBB3200SA	179C828G22	0	—	—	KDB3200	1-5, 8, 9
LBB3200SW	179C830G22	0	—	—	KDB3200W	1-5, 8, 9
LBB3200W	179C809G22	0	—	—	KDB3200W	1-3, 5, 8, 9
LBB3225	179C806G23	0	—	—	KDB3225	1-3, 5, 8, 9
LBB32250MW	179C811G20	0	—	—	HMCP400L5W	1-3, 5, 8, 9
LBB32250SMW	179C832G20	0	—	—	HMCP400L5W	1-5, 8, 9
LBB3225S	179C827G23	0	—	—	KDB3225	1-5, 8, 9
LBB3225SA	179C828G23	0	—	—	KDB3225	1-5, 8, 9
LBB3225SW	179C830G23	0	—	—	KDB3225W	1-5, 8, 9
LBB3225W	179C809G23	0	—	—	KDB3225W	1-3, 5, 8, 9
LBB3250	179C806G24	0	—	—	KDB3250	1-3, 5, 8, 9
LBB3250A	179C807G24	0	—	—	KDB3250	1-3, 5, 8, 9
LBB3250S	179C827G24	0	—	—	KDB3250	1-5, 8, 9
LBB3250SA	179C828G24	0	—	—	KDB3250	1-5, 8, 9
LBB3250SW	179C830G24	0	—	—	KDB3250W	1-5, 8, 9
LBB3250W	179C809G24	0	—	—	KDB3250W	1-3, 5, 8, 9
LBB3300	179C806G25	0	—	—	KDB3300	1-3, 5, 8, 9
LBB33000MW	179C811G21	0	—	—	HMCP400N5W	1-3, 5, 8, 9
LBB33000SMW	179C832G21	0	—	—	HMCP400N5W	1-5, 8, 9
LBB3300A	179C807G25	0	—	—	KDB3300	1-3, 5, 8, 9
LBB3300S	179C827G25	0	—	—	KDB3300	1-5, 8, 9
LBB3300SA	179C828G25	0	—	—	KDB3300	1-5, 8, 9
LBB3300SW	179C830G25	0	—	—	KDB3300W	1-5, 8, 9
LBB3300W	179C809G25	0	—	—	KDB3300W	1-3, 5, 8, 9
LBB3350	179C806G26	0	—	—	KDB3350	1-3, 5, 8, 9
LBB3350A	179C807G26	0	—	—	KDB3350	1-3, 5, 8, 9
LBB3350SA	179C828G26	0	—	—	KDB3350	1-5, 8, 9
LBB3350W	179C809G26	0	—	—	KDB3350W	1-3, 5, 8, 9
LBB3400	179C806G27	0	—	—	KDB3400	1-3, 5, 8, 9

Note

① 0 = Obsolete, A = Available.

Replacement Breaker Cross-Reference

Replacement Breaker		Status ①	Replacements		Series C Catalog Number	Notes (See Page V12-T3-114)
Catalog Number	Style Number		MARK 75 Catalog Number	MARK 75 Style Number		
LBB34000MW	179C811G22	0	—	—	HMCP400X5W	1-3, 5, 8, 9
LBB34000SMW	179C832G22	0	—	—	HMCP400X5W	1-5, 8, 9
LBB3400A	179C807G27	0	—	—	KDB3400	1-3, 5, 8, 9
LBB3400S	179C827G27	0	—	—	KDB3400	1-5, 8, 9
LBB3400SA	179C828G27	0	—	—	KDB3400	1-5, 8, 9
LBB3400SW	179C830G27	0	—	—	KDB3400W	1-5, 8, 9
LBB3400W	179C809G27	0	—	—	KDB3400W	1-3, 5, 8, 9
LBB3400WK	752B048G06	0	—	—	KDB3400KW	1-3, 5, 8, 9
LBB3400WSK	752B048G08	0	—	—	KDB3400KW	1-3, 5, 8, 9
LBB3700MW	179C811G16	0	—	—	HMCP400D5W	1-3, 5, 7-9
LBB3700SMW	179C832G16	0	—	—	HMCP400D5W	1-5, 7-9
LC2150F	1242C91G01	0	—	—	KD3400F/KES3150LS	1-3, 5, 8
LC2150FM	1242C91G03	0	—	—	KD3400F/KES3150LS	1-3, 5, 8
LC2300F	1242C91G05	0	—	—	KD3400F/KES3400LS	1-3, 5, 8
LC2300FM	1242C91G07	0	—	—	KD3400F/KES3400LS	1-3, 5, 8
LC2400F	1242C91G09	0	—	—	KD3400F/KES3400LS	1-3, 5, 8
LC2400FM	1242C91G11	0	—	—	KD3400F/KES3400LS	1-3, 5, 8
LC2600F	1242C91G13	0	—	—	LD3600F/LES3600LS	1-3, 5, 8
LC2600FM	1242C91G15	0	—	—	LD3600F/LES3600LS	1-3, 5, 8
LC2600WK	752B043G03	0	—	—	LD2600WK	1-3, 5, 8
LC3150F	1242C91G02	0	HLC3150F	1284C66G02	KD3400F/KES3150LS	1-3, 5, 8
LC3150FM	1242C91G04	0	HLC3150F	1284C66G02	KD3400F/KES3150LS	1-3, 5, 8
LC3300F	1242C91G06	0	HLC3300F	2612D41G46	KD3400F/KES3400LS	1-3, 5, 8
LC3300FM	1242C91G08	0	HLC3300F	2612D41G46	KD3400F/KES3400LS	1-3, 5, 8
LC3400F	1242C91G10	0	HLC3400F	2613D44G08	KD3400F/KES3400LS	1-3, 5, 8
LC3400FM	1242C91G12	0	HLC3400F	2613D44G08	KD3400F/KES3400LS	1-3, 5, 8
LC3600F	1242C91G14	0	HLC3600F	2612D41G48	LD3600F/LES3600LS	1-3, 5, 8
LC3600FM	1242C91G16	0	HLC3600F	2612D41G48	LD3600F/LES3600LS	1-3, 5, 8
LC3600WK	752B043G08	0	—	—	LD3600WK	1-3, 5, 8
LCA2150F	1242C91G23	0	—	—	KD3400F/KES3150LSI	1-3, 5, 8
LCA2150FM	1242C91G25	0	—	—	KD3400F/KES3150LSI	1-3, 5, 8
LCA2300F	1242C91G27	0	—	—	KD3400F/KES3400LSI	1-3, 5, 8
LCA2300FM	1242C91G29	0	—	—	KD3400F/KES3400LSI	1-3, 5, 8
LCA2400F	1242C91G31	0	—	—	KD3400F/KES3400LSI	1-3, 5, 8
LCA2400FM	1242C91G33	0	—	—	KD3400F/KES3400LSI	1-3, 5, 8
LCA2600F	1242C91G35	0	—	—	LD3600F/LES3600LSI	1-3, 5, 8
LCA2600FM	1242C91G37	0	—	—	LD3600F/LES3600LSI	1-3, 5, 8
LCA3150F	1242C91G24	0	HLCA3150F	1242C92G24	KD3400F/KES3150LSI	1-3, 5, 8
LCA3150FM	1242C91G26	0	HLCA3150F	1242C92G24	KD3400F/KES3150LSI	1-3, 5, 8
LCA3300F	1242C91G28	0	HLCA3300F	1242C92G28	KD3400F/KES3400LSI	1-3, 5, 8
LCA3300FM	1242C91G30	0	HLCA3300F	1242C92G28	KD3400F/KES3400LSI	1-3, 5, 8
LCA3400F	1242C91G32	0	HLCA3400F	1242C92G32	KD3400F/KES3400LSI	1-3, 5, 8
LCA3400FM	1242C91G34	0	HLCA3400F	1242C92G34	KD3400F/KES3400LSI	1-3, 5, 8
LCA3600F	1242C91G36	0	HLCA3600F	1284C66G36	LD3600F/LES3600LSI	1-3, 5, 8
LCA3600FM	1242C91G38	0	HLCA3600F	1284C66G36	LD3600F/LES3600LSI	1-3, 5, 8
LCC2600WK	NO STYLE	0	—	—	—	1-3, 5, 8
LCC3600F	6590C10G14	0	HLCC3600F	6590C11G14	CLD3600F/LES3600LS	1-3, 5, 8

Note

① 0 = Obsolete, A = Available.

Replacement Breaker Cross-Reference

Replacement Breaker			Replacements			Notes
Catalog Number	Style Number	Status ①	MARK 75 Catalog Number	MARK 75 Style Number	Series C Catalog Number	(See Page V12-T3-114)
LCC3600WK	NO STYLE	0	—	—	—	1–3, 5, 8
LCCA3600F	6590C10G36	0	HLCCA3600F	6590C11G36	CLD3600F/LES3600LSI	1–3, 5, 8
LCCG3600F	1242C93G04	0	HLCGG3600F	1242C94G04	CLD3600F/LES3600LSG	1–3, 5, 8
LCCGA3600F	1242C93G12	0	HLCGA3600F	1242C94G12	CLD3600F/LES3600LSIG	1–3, 5, 8
LCG3150F	1242C88G01	0	HLCG3150F	1242C89G01	KD3400F/KES3150LSG	1–3, 5, 8
LCG3300F	1242C88G02	0	HLCG3300F	1242C89G02	KD3400F/KES3400LS	1–3, 5, 8
LCG3400F	1242C88G03	0	HLCG3400F	1242C89G03	KD3400F/KES3400LSG	1–3, 5, 8
LCG3600F	1242C88G04	0	HLCG3600F	1371D17G40	LD3600F/LES3600LSG	1–3, 5, 8
LCGA3150F	1242C88G09	0	HLCGA3150F	1242C89G09	KD3400F/KES3150LSIG	1–3, 5, 8
LCGA3300F	1242C88G10	0	HLCGA3300F	1242C89G10	KD3400F/KES3400LSIG	1–3, 5, 8
LCGA3400F	1242C88G11	0	HLCGA3400F	1242C89G11	KD3400F/KES3400LSIG	1–3, 5, 8
LCGA3600F	1242C88G12	0	HLCGA3600F	1270C61G12	LD3600F/LES3600LSIG	1–3, 5, 8
LCY3600F	6590C12G04	0	—	—	HLD3600F/LES3600LS	1–3, 5, 8
LCYA3600F	6590C12G08	0	—	—	HLD3600F/LES3600LSI	1–3, 5, 8
LCYG3600F	1242C95G04	0	—	—	HLD3600F/LES3600LSG	1–3, 5, 8
LCYGA3600F	1242C95G08	0	—	—	HLD3600F/LES3600LSIG	1–3, 5, 8
MA2125	1252C17G01	0	—	—	KD2125	1–3, 5, 8
MA2125S	1252C21G01	0	—	—	KD2125	1–5, 8
MA2150	1252C17G02	0	—	—	KD2150	1–3, 5, 8
MA2150S	1252C21G02	0	—	—	KD2150	1–5, 8
MA2175	1252C17G03	0	—	—	KD2175	1–3, 5, 8
MA2175S	1252C21G03	0	—	—	KD2175	1–5, 8
MA2200	1252C17G04	0	—	—	KD2200	1–3, 5, 8
MA2200S	1252C21G04	0	—	—	KD2200	1–5, 8
MA2225	1252C17G05	0	—	—	KD2225	1–3, 5, 8
MA2225S	1252C21G05	0	—	—	KD2225	1–5, 8
MA2250	1252C17G06	0	—	—	KD2250	1–3, 5, 8
MA2250S	1252C21G06	0	—	—	KD2250	1–5, 8
MA2300	1252C17G07	0	—	—	MDL2300	1–3, 5, 8
MA2300S	1252C21G07	0	—	—	MDL2300	1–5, 8
MA2350	1252C17G08	0	—	—	MDL2350	1–3, 5, 8
MA2350S	1252C21G08	0	—	—	MDL2350	1–5, 8
MA2400	1252C17G09	0	—	—	MDL2400	1–3, 5, 8
MA2400S	1252C21G09	0	—	—	MDL2400	1–5, 8
MA2500	1252C17G10	0	—	—	MDL2500	1–3, 5, 8
MA2500S	1252C21G10	0	—	—	MDL2500	1–5, 8
MA2600	1252C17G11	0	—	—	MDL2600	1–3, 5, 8
MA2600S	1252C21G11	0	—	—	MDL2600	1–5, 8
MA2700	1252C17G14	0	—	—	MDL2700	1–3, 5, 8
MA2700S	1252C21G14	0	—	—	MDL2700	1–5, 8
MA2800	1252C17G15	0	—	—	MDL2800	1–3, 5, 8
MA2800F	2600D43G01	0	—	—	MDL2800F	1–3, 5, 8
MA2800FS	2600D43G03	0	—	—	MDL2800F	1–5, 8
MA2800S	1252C21G15	0	—	—	MDL2800	1–5, 8
MA2800WK	752B071G01	0	—	—	MDL2800WK	1–3, 5, 8
MA2800WSK	752B071G02	0	—	—	MDL2800WK	1–3, 5, 8
MA3125	1252C17G16	0	HMA3125	504C741G16	KD3125	1–3, 5, 8

Note

① 0 = Obsolete, A = Available.

Replacement Breaker Cross-Reference

Replacement Breaker		Status ①	Replacements			Notes (See Page V12-T3-114)
Catalog Number	Style Number		MARK 75 Catalog Number	MARK 75 Style Number	Series C Catalog Number	
MA3125S	1252C21G16	0	HMA3125	504C741G16	KD3125	1-5, 8
MA3150	1252C17G17	0	HMA3150	504C741G17	KD3150	1-3, 5, 8
MA3150S	1252C21G17	0	HMA3150	504C741G17	KD3150	1-5, 8
MA3175	1252C17G18	0	HMA3175	504C741G18	KD3175	1-3, 5, 8
MA3175S	1252C21G18	0	HMA3175	504C741G18	KD3175	1-5, 8
MA3200	1252C17G19	0	HMA3200	504C741G19	KD3200	1-3, 5, 8
MA3200S	1252C21G19	0	HMA3200	504C741G19	KD3200	1-5, 8
MA3225	1252C17G20	0	HMA3225	504C741G20	KD3225	1-3, 5, 8
MA3225S	1252C21G20	0	HMA3225	504C741G20	KD3225	1-5, 8
MA3250	1252C17G21	0	HMA3250	504C741G21	KD3250	1-3, 5, 8
MA3250S	1252C21G21	0	HMA3250	504C741G21	KD3250	1-5, 8
MA3300	1252C17G22	0	HMA3300	504C741G22	MDL3300	1-3, 5, 8
MA3300S	1252C21G22	0	HMA3300	504C741G22	MDL3300	1-5, 8
MA3350	1252C17G23	0	HMA3350	504C741G23	MDL3350	1-3, 5, 8
MA3350S	1252C21G23	0	HMA3350	504C741G23	MDL3350	1-5, 8
MA3400	1252C17G24	0	HMA3400	504C741G24	MDL3400	1-3, 5, 8
MA3400S	1252C21G24	0	HMA3400	504C741G24	MDL3400	1-5, 8
MA3500	1252C17G25	0	HMA3500	504C741G25	MDL3500	1-3, 5, 8
MA3500S	1252C21G25	0	HMA3500	504C741G25	MDL3500	1-5, 8
MA3600	1252C17G26	0	HMA3600	504C741G26	MDL3600	1-3, 5, 8
MA3600S	1252C21G26	0	HMA3600	504C741G26	MDL3600	1-5, 8
MA3700	1252C17G27	0	HMA3700	504C741G27	MDL3700	1-3, 5, 8
MA3700S	1252C21G27	0	HMA3700	504C741G27	MDL3700	1-5, 8
MA3800	1252C17G28	0	HMA3800	504C741G28	MDL3800	1-3, 5, 8
MA3800F	2600D43G02	0	HMA3800F	373B237G04	MDL3800F	—
MA3800FS	2600D43G04	0	HMA3800F	373B237G04	MDL3800F	1-5, 8
MA3800S	1252C21G28	0	HMA3800	504C741G28	MDL3800	1-5, 8
MA3800WK	752B071G06	0	—	—	MDL3800WK	1-3, 5, 8
MA3800WSK	752B071G07	0	—	—	MDL3800WK	1-3, 5, 8
MAY3600	NO STYLE	0	—	—	HMDL3600	—
MAY3700	NO STYLE	0	—	—	HMDL3700	—
MAY3800	NO STYLE	0	—	—	HMDL3800	—
MAY3800F	1240C54G01	0	—	—	HMDL3800F	—
MC2800F	6590C16G01	0	—	—	MDL3800F/MES3800LS	1-3, 5, 8
MC2800FM	6590C16G03	0	—	—	MDL3800F/MES3800LS	1-3, 5, 8
MC2800WK	752B071G03	0	—	—	MDL2800WK	1-3, 5, 8
MC3800F	6590C16G02	0	HMC3800F	6590C16G06	MDL3800F/MES3800LS	1-3, 5, 8
MC3800FM	6590C16G04	0	HMC3800F	6590C16G06	MDL3800F/MES3800LS	1-3, 5, 8
MC3800WK	752B071G08	0	—	—	MDL3800WK	1-3, 5, 8
MCA2800F	6590C16G13	0	—	—	MDL3800F/MES3800LSI	1-3, 5, 8
MCA3800F	6590C16G14	0	HMCA3800F	6590C16G18	MDL3800F/MES3800LSI	1-3, 5, 8
MCC2800WK	NO STYLE	0	—	—	—	1-3, 5, 8
MCC3800F	6590C14G02	0	HMCC3800F	6590C14G06	CMDL3800F/MES3800LS	1-3, 5, 8
MCC3800WK	NO STYLE	0	—	—	—	1-3, 5, 8
MCCA3800F	6590C14G14	0	HMCCA3800F	6590C14G18	CMDL3800F/MES3800LSI	1-3, 5, 8
MCCG3800F	1242C62G01	0	HMCCG3800F	1242C62G09	CMDL3800F/MES3800LSG	1-3, 5, 8
MCCGA3800F	1242C62G03	0	HMCCGA3800F	1242C62G11	CMDL3800F/MES3800LSIG	1-3, 5, 8

Note

① 0 = Obsolete, A = Available.

Replacement Breaker Cross-Reference

Replacement Breaker			Replacements			Notes
Catalog Number	Style Number	Status ①	MARK 75 Catalog Number	MARK 75 Style Number	Series C Catalog Number	(See Page V12-T3-114)
MCG3800F	1242C60G01	O	HMCG3800F	2612D86G08	MDL3800F/MES3800LSG	1-3, 5, 8
MCGA3800F	1270C62G03	O	HMCGA3800F	1242C60G11	MDL3800F/MES3800LSIG	1-3, 5, 8
MCP03150CR	2610D55G04	A	—	—	HMCP015E0C	1-3, 5, 7, 8
MCP03150R	2610D54G24	A	—	—	HMCP015E0	1-3, 5, 7, 8
MCP0322CR	2610D55G02	A	—	—	HMCP003A0C	1-3, 5, 7, 8
MCP0322R	2610D54G22	A	—	—	HMCP003A0	1-3, 5, 7, 8
MCP0358CR	2610D55G03	A	—	—	HMCP007C0C	1-3, 5, 7, 8
MCP0358R	2610D54G23	A	—	—	HMCP007C0	1-3, 5, 7, 8
MCP13300CR	2610D55G05	A	—	—	HMCP030H1C	1-3, 5, 7, 8
MCP13300R	2610D54G25	A	—	—	HMCP030H1	1-3, 5, 7, 8
MCP23480CR	2610D55G06	A	—	—	HMCP050K2C	1-3, 5, 7, 8
MCP23480R	2610D54G26	A	—	—	HMCP050K2	1-3, 5, 7, 8
MCP331000CR	2610D55G07	A	—	—	HMCP100R3C	1-3, 5, 7, 8
MCP331000R	2610D54G27	A	—	—	HMCP100R3	1-3, 5, 7, 8
MCP431550CR	2610D55G09	A	—	—	HMCP150T4C	1-3, 5, 7, 8
MCP431550R	2610D54G28	A	—	—	HMCP150T4	1-3, 5, 7, 8
MCP431800CR	2610D55G08	A	—	—	HMCP150U4C	1-3, 5, 7, 8
MCP431800R	2610D54G30	A	—	—	HMCP150U4	1-3, 5, 7, 8
MCP532500	752B418G21	O	—	—	HMCP250W5	1-3, 5, 7, 8
MCP532500C	752B418G11	O	—	—	HMCP250W5C	1-3, 5, 7, 8
MCP534000	673B019G15	O	HLB34000M	179C850G22	HMCP400X5	1-3, 5, 7, 8
MCP534000C	673B019G21	O	HLB34000M	179C850G22	HMCP400X5C	1-3, 5, 7, 8
NB21000	1234C24G15	O	—	—	ND212T33W/12NES1000T+	1-3, 5, 8
NB21000S	1234C25G16	O	—	—	ND212T33W/12NES1000T+	1-5, 8
NB21200	1234C24G17	O	—	—	ND212T33W/12NES1200T+	1-3, 5, 8
NB21200F	2610D64G01	O	—	—	ND212T33W	—
NB21200FS	4997D20G03	O	—	—	ND212T33W/12NES1200T+	1-5, 8
NB21200S	1234C25G18	O	—	—	ND212T33W/12NES1200T+	1-5, 8
NB21200WK	752B682G01	O	—	—	ND312WK	1-3, 5, 8
NB21200WSK	752B682G02	O	—	—	ND312WK	1-3, 5, 8
NB2700	1234C24G12	O	—	—	ND2800T33W/8NES700T+	1-3, 5, 8
NB2700S	1234C25G13	O	—	—	ND2800T33W/8NES700T+	1-5, 8
NB2800	1234C24G13	O	—	—	ND2800T33W/8NES800T+	1-3, 5, 8
NB2800S	1234C25G14	O	—	—	ND2800T33W/8NES800T+	1-5, 8
NB2900	1234C25G14	O	—	—	ND212T33W/12NES900T+	1-3, 5, 8
NB2900S	1234C25G15	O	—	—	ND212T33W/12NES900T+	1-5, 8
NB31000	1234C24G33	O	HNB31000	177C099G33	ND312T33W/12NES1000T+	1-3, 5, 8
NB31000S	1234C25G33	O	HNB31000	177C099G33	ND312T33W/12NES1000T+	1-5, 8
NB31200	1234C24G35	O	HNB31200	177C099G35	ND312T33W/12NES1200T+	1-3, 5, 8
NB31200F	2610D64G02	O	HNB31200F	625B494G08	ND312T33W	—
NB31200FS	2610D64G04	O	HNB31200F	625B494G08	ND312T33W	1-5, 8
NB31200S	1234C25G35	O	HNB31200	177C099G35	ND312T33W/12NES1200T+	1-5, 8
NB31200WK	752B682G06	O	—	—	ND312WK	1-3, 5, 8
NB31200WSK	752B682G07	O	—	—	ND312WK	1-3, 5, 8
NB3700	1234C24G30	O	HNB3700	177C099G30	ND3800T33W/8NES700T+	1-3, 5, 8
NB3700S	1234C25G30	O	HNB3700	177C099G30	ND3800T33W/8NES700T+	1-5, 8
NB3800	1234C24G31	O	HNB3800	177C099G31	ND3800T33W/8NES800T+	1-3, 5, 8

Note

① O = Obsolete, A = Available.

Replacement Breaker Cross-Reference

Replacement Breaker			Replacements			Notes (See Page V12-T3-114)
Catalog Number	Style Number	Status ①	MARK 75 Catalog Number	MARK 75 Style Number	Series C Catalog Number	
NB3800S	1234C25G31	0	HNB3800	177C099G31	ND3800T33W/8NES800T+	1-5, 8
NB3900	1234C24G32	0	HNB3900	177C099G32	ND312T33W/12NES900T+	1-3, 5, 8
NB3900S	1234C25G32	0	HNB3900	177C099G32	ND312T33W/12NES900T+	1-5, 8
NBY31000	NO STYLE	0	—	—	HND312T33W/12NES1000T+	—
NBY31200F	1240C62G01	0	—	—	HND312T33W/12NES1200T+	—
NBY3700	NO STYLE	0	—	—	HND3800T33W/8NES700T+	—
NBY3800	NO STYLE	0	—	—	HND3800T33W/8NES800T+	—
NBY3900	NO STYLE	0	—	—	HND312T33W/12NES900T+	—
NC21200F	2613D29G10	0	—	—	ND212T33W	1-3, 5, 8
NC21200FM	2613D29G12	0	—	—	ND212T33W	1-3, 5, 8
NC21200WK	752B682G03	0	—	—	ND312WK	1-3, 5, 8
NC31200F	2613D29G09	0	HNC31200F	2613D29G05	ND312T33W	1-3, 5, 8
NC31200FM	2613D29G11	0	HNC31200F	2613D29G05	ND312T33W	1-3, 5, 8
NC31200WK	752B682G08	0	—	—	ND312WK	1-3, 5, 8
NCA21200F	2613D29G22	0	OMIT	OMIT	ND312T32W	1-3, 5, 8
NCA31200F	2613D29G21	0	HNCA31200F	2613D29G17	ND312T32W	1-3, 5, 8
NCG31200F	1242C72G18	0	HNCG31200F	2612D87G07	ND312T35W	1-3, 5, 8
NCGA31200F	1242C72G11	0	HNCGA31200F	1373D87G12	ND312T36W	1-3, 5, 8
PB21000	177C181G29	0	—	—	RD316T33W/16RES10T+	1-3, 5, 8
PB21000TM	373D488G04	0	—	—	—	2, 8
PB21200	177C181G30	0	—	—	RD316T33W/16RES12T+	1-3, 5, 8
PB21200TM	373D488G06	0	—	—	—	2, 8
PB21400	177C181G31	0	—	—	RD316T33W/16RES14T	1-3, 5, 8
PB21600	177C181G32	0	—	—	RD316T33W/16RES16T	1-3, 5, 8
PB21800	177C181G33	0	—	—	—	—
PB22000	177C181G34	0	—	—	RD320T33W/20RES20T	1-3, 5, 8
PB22000WK	752B076G01	0	—	—	RD320WK	1-3, 5, 8
PB22500F	654D456G05	0	—	—	—	1-3, 5, 8
PB22500WK	752B076G02	0	—	—	—	1-3, 5, 8
PB25000TM	373D487G02	0	—	—	—	2, 8
PB2600	177C181G25	0	—	—	RD316T33W/16RES08T	1-3, 5, 8
PB26000TM	373D487G04	0	—	—	—	2, 8
PB2700	177C181G26	0	—	—	RD316T33W/16RES08T	1-3, 5, 8
PB27000TM	373D487G06	0	—	—	—	2, 8
PB2800	177C181G27	0	—	—	RD316T33W/16RES08T	1-3, 5, 8
PB28000TM	373D488G02	0	—	—	—	2, 8
PB2900	177C181G28	0	—	—	—	—
PB31000	177C181G41	A	—	—	RD316T33W/16RES10T+	1-3, 5, 8
PB31200	177C181G42	A	—	—	RD316T33W/16RES12T+	1-3, 5, 8
PB31400	177C181G43	A	—	—	RD316T33W/16RES14T+	1-3, 5, 8
PB31600	177C181G44	A	—	—	RD316T33W/16RES16T+	1-3, 5, 8
PB31800	177C181G45	A	—	—	—	—
PB32000	177C181G46	A	—	—	RD320T33W/20RES20T+	1-3, 5, 8
PB32000WK	752B076G12	A	—	—	RD320WK	1-3, 5, 8
PB32500F	654D456G06	A	—	—	RD325T33W	1-3, 5, 8
PB32500WK	752B076G13	A	—	—	—	1-3, 5, 8
PB3600	177C181G37	A	—	—	—	—

Note

① 0 = Obsolete, A = Available.

Replacement Breaker Cross-Reference

Replacement Breaker			Replacements			Notes
Catalog Number	Style Number	Status ①	MARK 75 Catalog Number	MARK 75 Style Number	Series C Catalog Number	(See Page V12-T3-114)
PB3700	177C181G38	A	—	—	—	—
PB3800	177C181G39	A	—	—	RD316T33W+/16RES08T	1–3, 5, 8
PB3900	177C181G40	A	—	—	—	—
PBF21000	177C771G05	O	—	—	RD316T33W/16RES10T+	1–3, 5, 8
PBF210000TM	506C131G32	O	—	—	—	2, 8
PBF21200	177C771G06	O	—	—	RD316T33W/16RES12T+	1–3, 5, 8
PBF212000TM	506C131G33	O	—	—	—	2, 8
PBF21400	177C771G07	O	—	—	RD316T33W/16RES14T	1–3, 5, 8
PBF21600	177C771G08	O	—	—	RD316T33W/16RES16T	1–3, 5, 8
PBF21800	177C771G09	O	—	—	—	—
PBF22000	177C771G10	O	—	—	RE320T33W/20RES20T	1–3, 5, 8
PBF22000F	5663D38G03	O	—	—	—	1–3, 5, 8
PBF22000K	PBF22000K	O	—	—	RD320WK	1–3, 5, 8
PBF25000TM	506C131G28	O	—	—	—	2, 8
PBF2600	177C771G01	O	—	—	—	—
PBF26000TM	506C131G29	O	—	—	—	2, 8
PBF2700	177C771G02	O	—	—	—	—
PBF27000TM	506C131G30	O	—	—	—	2, 8
PBF2800	177C771G03	O	—	—	RD316T33W/16RES08T	1–3, 5, 8
PBF28000TM	506C131G31	O	—	—	—	2, 8
PBF2900	177C771G04	O	—	—	—	—
PBF31000	177C771G17	A	—	—	RD316T33W+	1–3, 5, 8
PBF31200	177C771G18	A	—	—	RD316T33W+	1–3, 5, 8
PBF31400	177C771G19	A	—	—	RD316T33W+	1–3, 5, 8
PBF31600	177C771G20	A	—	—	RD316T33W+	1–3, 5, 8
PBF31800	177C771G21	A	—	—	—	—
PBF32000	177C771G22	A	—	—	RD320T33W+	1–3, 5, 8
PBF32000F	5663D38G01	A	—	—	—	1–3, 5, 8
PBF32000WK	752B076G13	A	—	—	RD320WK	1–3, 5, 8
PBF3600	177C771G13	A	—	—	RD316T33W/16RES08T+	1–3, 5, 8
PBF3700	177C771G14	A	—	—	RD316T33W/16RES08T+	1–3, 5, 8
PBF3800	177C771G15	A	—	—	RD316T33W/16RES08T+	1–3, 5, 8
PBF3900	177C771G16	A	—	—	RD316T33W/16RES10T+	1–3, 5, 8
PC22000F	6590C19G01	O	—	—	RD320T33W	1–3, 5, 8
PC22000FM	6590C19G03	O	—	—	RD320T33W	1–3, 5, 8
PC22000WK	753B081G04	O	—	—	RD320WK	1–3, 5, 8
PC22500F	6590C19G05	O	—	—	RD325T33W	1–3, 5, 8
PC22500FM	6590C19G07	O	—	—	RD325T33W	1–3, 5, 8
PC22500WK	752B076G05	O	—	—	—	1–3, 5, 8
PC23000F	6590C19G09	O	—	—	—	1–3, 5, 8
PC23000FM	6590C19G11	O	—	—	—	1–3, 5, 8
PC23000K	753B081G06	O	—	—	—	1–3, 5, 8
PC32000F	6590C19G02	A	—	—	RD320T33W	1–3, 5, 8
PC32000FM	6590C19G04	O	PC32000F	6590C19G02	RD320T33W	1–3, 5, 8
PC32000WK	753B081G15	A	—	—	RD320WK	1–3, 5, 8
PC32500F	6590C19G06	A	—	—	RD325T33W	1–3, 5, 8
PC32500FM	6590C19G08	O	PC32500F	6590C19G06	RD325T33W	1–3, 5, 8

Note

① O = Obsolete, A = Available.

Replacement Breaker Cross-Reference

Replacement Breaker		Status ①	Replacements			Notes (See Page V12-T3-114)
Catalog Number	Style Number		MARK 75 Catalog Number	MARK 75 Style Number	Series C Catalog Number	
PC32500WK	753B081G16	A	—	—	—	1-3, 5, 8
PC33000F	6590C19G10	A	—	—	—	1-3, 5, 8
PC33000FM	6590C19G12	O	PC33000F	6590C19G10	—	1-3, 5, 8
PC33000K	753B081G17	A	—	—	—	1-3, 5, 8
PCA22000F	6590C19G17	O	—	—	RD320T32W	1-3, 5, 8
PCA22500F	6590C19G21	O	—	—	RD325T32W	1-3, 5, 8
PCA22500FM	6590C19G07	O	—	—	RD325T32W	1-3, 5, 8
PCA23000F	6590C19G25	O	—	—	—	1-3, 5, 8
PCA32000F	6590C19G18	A	—	—	RD320T32W	1-3, 5, 8
PCA32500F	6590C19G22	A	—	—	RD325T32W	1-3, 5, 8
PCA33000F	6590C19G26	A	—	—	—	1-3, 5, 8
PCC22000F	6590C20G01	O	—	—	CRD320T33W	1-3, 5, 8
PCC22000FM	6590C20G03	O	—	—	CRD320T33W	1-3, 5, 8
PCC22000WK	752B076G09	O	—	—	—	1-3, 5, 8
PCC22500F	6590C20G05	O	—	—	—	1-3, 5, 8
PCC22500FM	6590C20G07	O	—	—	—	1-3, 5, 8
PCC22500WK	753B081G05	O	—	—	—	1-3, 5, 8
PCC23000F	6590C20G09	O	—	—	—	1-3, 5, 8
PCC23000FM	6590C20G11	O	—	—	—	1-3, 5, 8
PCC23000K	753B081G11	O	—	—	—	1-3, 5, 8
PCC32000F	6590C20G02	A	—	—	CRD320T33W	1-3, 5, 8
PCC32000FM	6590C20G04	O	PCC32000F	6590C20G02	CRD320T33W	1-3, 5, 8
PCC32000WK	753B081G20	A	—	—	—	1-3, 5, 8
PCC32500F	6590C20G06	A	—	—	—	1-3, 5, 8
PCC32500FM	6590C20G08	O	PCC32500F	6590C20G06	—	1-3, 5, 8
PCC32500WK	753B081G21	A	—	—	—	1-3, 5, 8
PCC33000F	6590C20G10	A	—	—	—	1-3, 5, 8
PCC33000FM	6590C20G12	O	PCC33000F	6590C20G10	—	1-3, 5, 8
PCC33000K	753B081G22	A	—	—	—	1-3, 5, 8
PCCA22000F	6590C20G17	O	—	—	CRD320T32W	1-3, 5, 8
PCCA22500F	6590C20G21	O	—	—	—	1-3, 5, 8
PCCA23000F	6590C20G25	O	—	—	—	1-3, 5, 8
PCCA32000F	6590C20G18	A	—	—	CRD320T32W	1-3, 5, 8
PCCA32500F	6590C20G22	A	—	—	—	1-3, 5, 8
PCCA33000F	6590C20G26	A	—	—	—	1-3, 5, 8
PCCF22000F	6590C18G01	O	—	—	CRD320T33W	1-3, 5, 8
PCCF22000FM	6590C18G03	O	—	—	CRD320T33W	1-3, 5, 8
PCCF22500F	6590C18G05	O	—	—	—	1-3, 5, 8
PCCF22500FM	6590C18G07	O	—	—	—	1-3, 5, 8
PCCF32000F	6590C18G02	A	—	—	CRD320T33W	1-3, 5, 8
PCCF32000FM	6590C18G04	O	PCCF32000F	6590C18G02	CRD320T33W	1-3, 5, 8
PCCF32500F	6590C18G06	A	—	—	—	1-3, 5, 8
PCCF32500FM	6590C18G08	O	PCCF32500F	6590C18G06	—	1-3, 5, 8
PCCFA22000F	1225C07G13	O	—	—	CRD320T32W	1-3, 5, 8
PCCFA22500F	6590C18G17	O	—	—	—	1-3, 5, 8
PCCFA32000F	6590C18G14	A	—	—	CRD320T32W	1-3, 5, 8
PCCFA32500F	6590C18G18	A	—	—	—	1-3, 5, 8

Note

① O = Obsolete, A = Available.

Replacement Breaker Cross-Reference

Replacement Breaker			Replacements			Notes
Catalog Number	Style Number	Status ①	MARK 75 Catalog Number	MARK 75 Style Number	Series C Catalog Number	(See Page V12-T3-114)
PCCFG32000F	1242C76G17	A	—	—	CRD320T35W	1–3, 5, 8
PCCFG32500F	1242C76G18	A	—	—	—	1–3, 5, 8
PCCFGA32000F	1242C78G21	A	—	—	CRD320T36W	1–3, 5, 8
PCCFGA32500F	1242C78G22	A	—	—	—	1–3, 5, 8
PCCG32000F	1242C75G25	A	—	—	CRD320T35W	1–3, 5, 8
PCCG32500F	1242C75G26	A	—	—	—	1–3, 5, 8
PCCG33000F	1242C75G27	A	—	—	—	1–3, 5, 8
PCCGA32000F	1242C75G31	A	—	—	CRD320T36W	1–3, 5, 8
PCCGA32500F	1242C75G32	A	—	—	—	1–3, 5, 8
PCCGA33000F	1242C75G33	A	—	—	—	1–3, 5, 8
PCF22000F	6590C17G01	O	—	—	RD320T33W	1–3, 5, 8
PCF22000FM	6590C17G03	O	—	—	RD320T33W	1–3, 5, 8
PCF22000K	753B081G08	O	—	—	RD320WK	1–3, 5, 8
PCF22500FM	6590C17G07	O	—	—	RD325T33W	1–3, 5, 8
PCF32000F	6590C17G02	A	—	—	RD320T33W	1–3, 5, 8
PCF32000FM	6590C17G04	O	PCF32000F	6590C17G02	RD320T33W	1–3, 5, 8
PCF32000K	753B081G19	A	—	—	RD320WK	1–3, 5, 8
PCF32500F	6590C17G06	A	—	—	RD325T33W	1–3, 5, 8
PCF32500FM	6590C17G08	O	PCF32500F	6590C17G06	RD325T33W	1–3, 5, 8
PCFA22000F	6590C17G13	O	—	—	RD320T32W	1–3, 5, 8
PCFA22500F	6590C17G17	O	—	—	RD325T32W	1–3, 5, 8
PCFA32000F	6590C17G14	A	—	—	RD320T32W	1–3, 5, 8
PCFA32500F	6590C17G18	A	—	—	RD325T32W	1–3, 5, 8
PCFG32000F	1242C76G01	A	—	—	RD320T35W	1–3, 5, 8
PCFG32500F	1242C76G02	A	—	—	RD325T35W	1–3, 5, 8
PCFGA32000F	1242C76G05	A	—	—	RD320T36W	1–3, 5, 8
PCFGA32500F	1242C76G06	A	—	—	RD325T36W	1–3, 5, 8
PCG32000F	1242C75G01	A	—	—	RD320T35W	1–3, 5, 8
PCG32500F	1242C75G02	A	—	—	RD325T35W	1–3, 5, 8
PCG33000F	1242C75G03	A	—	—	—	1–3, 5, 8
PCGA32000F	1242C75G07	A	—	—	RD320T36W	1–3, 5, 8
PCGA32500F	1242C75G08	A	—	—	RD325T36W	1–3, 5, 8
PCGA33000F	1242C75G09	A	—	—	—	1–3, 5, 8
RE1010	1375D81G01	O	—	—	—	3, 10
RE1015	1375D81G02	O	—	—	Reconditioned E1015	10
RE1020	1375D81G03	O	—	—	Reconditioned E1020	10
RE1025	1375D81G04	O	—	—	Reconditioned E1025	10
RE1030	1375D81G05	O	—	—	Reconditioned E1030	10
RE1040	1375D81G07	O	—	—	Reconditioned E1040	10
RE1050	1375D81G08	O	—	—	Reconditioned E1050	10
RE1060	1375D81G09	O	—	—	Reconditioned E1060	10
RE1070	1375D81G10	O	—	—	Reconditioned E1070	10
RE1080	1375D81G11	O	—	—	Reconditioned E1080	10
RE1090	1375D81G12	O	—	—	Reconditioned E1090	10
RE1100	1375D81G13	O	—	—	Reconditioned E1100	10
RE2015	1375D81G18	O	—	—	Reconditioned E2015	10
RE2020	1375D81G19	O	—	—	Reconditioned E2020	10

Note

① O = Obsolete, A = Available.

Replacement Breaker Cross-Reference

Replacement Breaker		Status ①	Replacements		Series C Catalog Number	Notes (See Page V12-T3-114)
Catalog Number	Style Number		MARK 75 Catalog Number	MARK 75 Style Number		
RE2025	1375D81G20	0	—	—	Reconditioned E2025	10
RE2030	1375D81G21	0	—	—	Reconditioned E2030	10
RE2040	1375D81G23	0	—	—	Reconditioned E2040	10
RE2050	1375D81G24	0	—	—	Reconditioned E2050	10
RE2060	1375D81G25	0	—	—	Reconditioned E2060	10
RE2070	1375D81G26	0	—	—	Reconditioned E2070	10
RE2080	1375D81G27	0	—	—	Reconditioned E2080	10
RE2090	1375D81G28	0	—	—	Reconditioned E2090	10
RE2100	1375D81G29	0	—	—	Reconditioned E2100	10
RE3015	1375D81G34	0	—	—	Reconditioned E3015	10
RE3020	1375D81G35	0	—	—	Reconditioned E3020	10
RE3025	1375D81G36	0	—	—	Reconditioned E3025	10
RE3030	1375D81G37	0	—	—	Reconditioned E3030	10
RE3040	1375D81G39	0	—	—	Reconditioned E3040	10
RE3050	1375D81G40	0	—	—	Reconditioned E3050	10
RE3060	1375D81G41	0	—	—	Reconditioned E3060	10
RE3070	1375D81G42	0	—	—	Reconditioned E3070	10
RE3080	1375D81G43	0	—	—	Reconditioned E3080	10
RE3090	1375D81G44	0	—	—	Reconditioned E3090	10
RE3100	1375D81G45	0	—	—	Reconditioned E3100	10
REA1010	1375D82G01	0	—	—	—	—
REA1015	1375D82G02	0	—	—	Reconditioned EA1015	10
REA1020	1375D82G03	0	—	—	Reconditioned EA1020	10
REA1025	1375D82G04	0	—	—	Reconditioned EA1025	10
REA1030	1375D82G05	0	—	—	Reconditioned EA1030	10
REA1035	1375D82G06	0	—	—	Reconditioned EA1035	10
REA1040	1375D82G07	0	—	—	Reconditioned EA1040	10
REA1050	1375D82G08	0	—	—	Reconditioned EA1050	10
REA1060	1375D82G09	0	—	—	Reconditioned EA1060	10
REA1070	1375D82G10	0	—	—	Reconditioned EA1070	10
REA1080	1375D82G11	0	—	—	Reconditioned EA1080	10
REA1090	1375D82G12	0	—	—	Reconditioned EA1090	10
REA1100	1375D82G13	0	—	—	Reconditioned EA1100	10
REA2015	1375D82G18	0	—	—	Reconditioned EA2015	10
REA2020	1375D82G19	0	—	—	Reconditioned EA2020	10
REA2025	1375D82G20	0	—	—	Reconditioned EA2025	10
REA2030	1375D82G21	0	—	—	Reconditioned EA2030	10
REA2040	1375D82G23	0	—	—	Reconditioned EA2040	10
REA2050	1375D82G24	0	—	—	Reconditioned EA2050	10
REA2060	1375D82G25	0	—	—	Reconditioned EA2060	10
REA2070	1375D82G26	0	—	—	Reconditioned EA2070	10
REA2080	1375D82G27	0	—	—	Reconditioned EA2080	10
REA2090	1375D82G28	0	—	—	Reconditioned EA2090	10
REA2100	1375D82G29	0	—	—	Reconditioned EA2100	10
REA3015	1375D82G34	0	—	—	Use REH3015	10
REA3020	1375D82G35	0	—	—	Use REH3020	10
REA3025	1375D82G36	0	—	—	Use REH3025	10

Note

① 0 = Obsolete, A = Available.

Replacement Breaker Cross-Reference

Replacement Breaker			Replacements			Notes
Catalog Number	Style Number	Status ^①	MARK 75 Catalog Number	MARK 75 Style Number	Series C Catalog Number	(See Page V12-T3-114)
REA3030	1375D82G37	0	—	—	Use REH3030	10
REA3040	1375D82G39	0	—	—	Use REH3040	10
REA3050	1375D82G40	0	—	—	Use REH3050	10
REA3060	1375D82G41	0	—	—	Use REH3060	10
REA3070	1375D82G42	0	—	—	Use REH3070	10
REA3080	1375D82G43	0	—	—	Use REH3080	10
REA3090	1375D82G44	0	—	—	Use REH3090	10
REA3100	1375D82G45	0	—	—	Use REH3100	10
REH1010	1375D83G01	0	—	—	—	3, 10
REH1015	1375D83G02	0	—	—	Reconditioned EH1015	10
REH1020	1375D83G03	0	—	—	Reconditioned EH1020	10
REH1025	1375D83G04	0	—	—	Reconditioned EH1025	10
REH1030	1375D83G05	0	—	—	Reconditioned EH1030	10
REH1040	1375D83G07	0	—	—	Reconditioned EH1040	10
REH1050	1375D83G08	0	—	—	Reconditioned EH1050	10
REH1060	1375D83G09	0	—	—	Reconditioned EH1060	10
REH1070	1375D83G10	0	—	—	Reconditioned EH1070	10
REH1080	1375D83G11	0	—	—	Reconditioned EH1080	10
REH1090	1375D83G12	0	—	—	Reconditioned EH1090	10
REH1100	1375D83G13	0	—	—	Reconditioned EH1100	10
REH2015	1375D83G18	0	—	—	Reconditioned EH2015	10
REH2020	1375D83G19	0	—	—	Reconditioned EH2020	10
REH2025	1375D83G20	0	—	—	Reconditioned EH2025	10
REH2030	1375D83G21	0	—	—	Reconditioned EH2030	10
REH2040	1375D83G23	0	—	—	Reconditioned EH2040	10
REH2050	1375D83G24	0	—	—	Reconditioned EH2050	10
REH2060	1375D83G25	0	—	—	Reconditioned EH2060	10
REH2070	1375D83G26	0	—	—	Reconditioned EH2070	10
REH2080	1375D83G27	0	—	—	Reconditioned EH2080	10
REH2090	1375D83G28	0	—	—	Reconditioned EH2090	10
REH2100	1375D83G29	0	—	—	Reconditioned EH2100	10
REH3015	1375D83G34	A	—	—	—	3, 10
REH3020	1375D83G35	A	—	—	—	3, 10
REH3025	1375D83G36	A	—	—	—	3, 10
REH3030	1375D83G37	A	—	—	—	3, 10
REH3040	1375D83G39	A	—	—	—	3, 10
REH3050	1375D83G40	A	—	—	—	3, 10
REH3060	1375D83G41	A	—	—	—	3, 10
REH3070	1375D83G42	A	—	—	—	3, 10
REH3080	1375D83G43	A	—	—	—	3, 10
REH3090	1375D83G44	A	—	—	—	3, 10
REH3100	1375D83G45	A	—	—	—	3, 10
RF2015	1375D86G02	0	—	—	Reconditioned F2015	3, 10
RF2020	1375D86G03	0	—	—	Reconditioned F2020	3, 10
RF2025	NO STYLE	0	—	—	Reconditioned F2025	3, 10
RF2030	1375D86G05	0	—	—	Reconditioned F2030	3, 10
RF2040	1375D86G07	0	—	—	Reconditioned F2040	3, 10

Note

① 0 = Obsolete, A = Available.

Replacement Breaker Cross-Reference

Replacement Breaker		Status ①	Replacements			Notes (See Page V12-T3-114)
Catalog Number	Style Number		MARK 75 Catalog Number	MARK 75 Style Number	Series C Catalog Number	
RF2050	1375D86G08	0	—	—	Reconditioned F2050	3, 10
RF2060	1375D86G09	0	—	—	Reconditioned F2060	3, 10
RF2070	1375D86G10	0	—	—	Reconditioned F2070	3, 10
RF2080	1375D86G11	0	—	—	Reconditioned F2080	3, 10
RF2090	1375D86G12	0	—	—	Reconditioned F2090	3, 10
RF2100	1375D86G13	0	—	—	Reconditioned F2100	3, 10
RF3015	1375D86G18	0	RHF3015	1375D87G18	—	3, 10
RF3020	1375D86G19	0	RHF3020	1375D87G19	—	3, 10
RF3025	1375D86G20	0	RHF3025	1375D87G20	—	3, 10
RF3030	1375D86G21	0	RHF3030	1375D87G21	—	3, 10
RF3040	1375D86G23	0	RHF3040	1375D87G23	—	3, 10
RF3050	1375D86G24	0	RHF3050	1375D87G24	—	3, 10
RF3060	1375D86G25	0	RHF3060	1375D87G25	—	3, 10
RF3070	1375D86G26	0	RHF3070	1375D87G26	—	3, 10
RF3080	1375D86G27	0	RHF3080	1375D87G27	—	3, 10
RF3090	1375D86G28	0	RHF3090	1375D87G28	—	3, 10
RF3100	1375D86G29	0	RHF3100	1375D87G29	—	3, 10
RFA2010	1375D84G01	0	—	—	—	3, 10
RFA2015	1375D84G02	0	—	—	Reconditioned FA2015	3, 10
RFA2020	1375D84G03	0	—	—	Reconditioned FA2020	3, 10
RFA2025	1375D84G04	0	—	—	Reconditioned FA2025	3, 10
RFA2030	1375D84G05	0	—	—	Reconditioned FA2030	3, 10
RFA2040	1375D84G07	0	—	—	Reconditioned FA2040	3, 10
RFA2045	1375D84G16	0	—	—	Reconditioned FA2045	3, 10
RFA2050	1375D84G08	0	—	—	Reconditioned FA2050	3, 10
RFA2060	1375D84G09	0	—	—	Reconditioned FA2060	3, 10
RFA2070	1375D84G10	0	—	—	Reconditioned FA2070	3, 10
RFA2080	1375D84G11	0	—	—	Reconditioned FA2080	3, 10
RFA2090	1375D84G12	0	—	—	Reconditioned FA2090	3, 10
RFA2100	1375D84G13	0	—	—	Reconditioned FA2100	3, 10
RFA2100K	1375D84G17	0	—	—	—	3, 10
RFA3010	1375D84G21	0	RHFA3010	1375D85G21	—	—
RFA3015	1375D84G22	0	RHFA3015	1375D85G22	—	3, 10
RFA3020	1375D84G23	0	RHFA3020	1375D85G23	—	3, 10
RFA3025	1375D84G24	0	RHFA3025	1375D85G24	—	3, 10
RFA3030	1375D84G25	0	RHFA3030	1375D85G25	—	3, 10
RFA3040	1375D84G27	0	RHFA3040	1375D85G27	—	3, 10
RFA3045	1375D84G36	0	RHFA3045	1375D85G36	—	3, 10
RFA3050	1375D84G28	0	RHFA3050	1375D85G28	—	3, 10
RFA3060	1375D84G29	0	RHFA3060	1375D85G29	—	3, 10
RFA3070	1375D84G30	0	RHFA3070	1375D85G30	—	3, 10
RFA3080	1375D84G31	0	RHFA3080	1375D85G31	—	3, 10
RFA3090	1375D84G32	0	RHFA3090	1375D85G32	—	3, 10
RFA3100	1375D84G33	0	RHFA3100	1375D85G33	—	3, 10
RFA3100K	1375D84G37	0	—	—	—	—
RHF2015	1375D87G02	0	—	—	Reconditioned HF2015	10
RHF2020	1375D87G03	0	—	—	Reconditioned HF2020	10

Note

① 0 = Obsolete, A = Available.

Replacement Breaker Cross-Reference

Replacement Breaker			Replacements			Notes
Catalog Number	Style Number	Status ^①	MARK 75 Catalog Number	MARK 75 Style Number	Series C Catalog Number	(See Page V12-T3-114)
RHF2030	1375D87G05	0	—	—	Reconditioned HF2030	10
RHF2040	1375D87G07	0	—	—	Reconditioned HF2040	10
RHF2050	1375D87G08	0	—	—	Reconditioned HF2050	10
RHF2060	1375D87G09	0	—	—	Reconditioned HF2060	10
RHF2070	1375D87G10	0	—	—	Reconditioned HF2070	10
RHF2080	1375D87G11	0	—	—	Reconditioned HF2080	10
RHF2090	1375D87G12	0	—	—	Reconditioned HF2090	10
RHF2100	1375D87G13	0	—	—	Reconditioned HF2100	10
RHF3015	1375D87G18	A	—	—	—	10
RHF3020	1375D87G19	A	—	—	—	10
RHF3025	1375D87G20	A	—	—	—	10
RHF3030	1375D87G21	A	—	—	—	10
RHF3040	1375D87G23	A	—	—	—	10
RHF3050	1375D87G24	A	—	—	—	10
RHF3060	1375D87G25	A	—	—	—	10
RHF3070	1375D87G26	A	—	—	—	10
RHF3080	1375D87G27	A	—	—	—	10
RHF3090	1375D87G28	A	—	—	—	10
RHF3100	1375D87G29	A	—	—	—	10
RHFA2015	1375D85G02	0	—	—	Reconditioned FA2015	10
RHFA2020	1375D85G03	0	—	—	Reconditioned FA2020	10
RHFA2025	1375D85G04	0	—	—	Reconditioned FA2025	10
RHFA2030	1375D85G05	0	—	—	Reconditioned FA2030	10
RHFA2040	1375D85G07	0	—	—	Reconditioned FA2040	10
RHFA2050	1375D85G08	0	—	—	Reconditioned FA2050	10
RHFA2060	1375D85G09	0	—	—	Reconditioned FA2060	10
RHFA2070	1375D85G10	0	—	—	Reconditioned FA2070	10
RHFA2080	1375D85G11	0	—	—	Reconditioned FA2080	10
RHFA2090	1375D85G12	0	—	—	Reconditioned FA2090	10
RHFA2100	1375D85G13	0	—	—	Reconditioned FA2100	10
RHFA2150	1375D85G15	0	—	—	Reconditioned FA2150	10
RHFA3015	1375D85G22	A	—	—	—	10
RHFA3020	1375D85G23	A	—	—	—	10
RHFA3025	1375D85G24	A	—	—	—	10
RHFA3030	1375D85G25	A	—	—	—	10
RHFA3040	1375D85G27	A	—	—	—	10
RHFA3050	1375D85G28	A	—	—	—	10
RHFA3060	1375D85G29	A	—	—	—	10
RHFA3070	1375D85G30	A	—	—	—	10
RHFA3080	1375D85G31	A	—	—	—	10
RHFA3090	1375D85G32	A	—	—	—	10
RHFA3100	1375D85G33	A	—	—	—	10
RHFA3150	1375D85G35	A	—	—	—	10
RHK2070	1376D14G02	0	—	—	Reconditioned HK2070	10
RHK2090	1376D14G03	0	—	—	Reconditioned HK2090	10
RHK2100	1376D14G04	0	—	—	Reconditioned HK2100	10
RHK2125	1376D14G05	0	—	—	Reconditioned HK2125	10

Note

① 0 = Obsolete, A = Available.

Replacement Breaker Cross-Reference

Replacement Breaker		Status ①	Replacements		Series C Catalog Number	Notes (See Page V12-T3-114)
Catalog Number	Style Number		MARK 75 Catalog Number	MARK 75 Style Number		
RHK2150	1376D14G06	0	—	—	Reconditioned HK2150	10
RHK2175	1376D14G07	0	—	—	Reconditioned HK2175	10
RHK2200	1376D14G08	0	—	—	Reconditioned HK2200	10
RHK2225	1376D14G09	0	—	—	Reconditioned HK2225	10
RHK2225K	NO STYLE	0	—	—	—	—
RHK3070	1376D14G22	A	—	—	—	10
RHK3090	1376D14G23	A	—	—	—	10
RHK3100	1376D14G24	A	—	—	—	10
RHK3125	1376D14G25	A	—	—	—	10
RHK3150	1376D14G26	A	—	—	—	10
RHK3175	1376D14G27	A	—	—	—	10
RHK3200	1376D14G28	A	—	—	—	10
RHK3225	1376D14G29	A	—	—	—	10
RHK3225K	NO STYLE	0	—	—	—	—
RHKL2125	1376D15G05	0	—	—	Reconditioned KL2125	10
RHKL2150	1376D15G06	0	—	—	Reconditioned KL2150	10
RHKL2175	1376D15G07	0	—	—	Reconditioned KL2175	10
RHKL2200	1376D15G08	0	—	—	Reconditioned KL2200	10
RHKL2225	1376D15G09	0	—	—	Reconditioned KL2225	10
RHKL2250	1376D15G10	0	—	—	Reconditioned KL2250	10
RHKL2300	1376D15G12	0	—	—	Reconditioned KL2300	10
RHKL2350	1376D15G14	0	—	—	Reconditioned KL2350	10
RHKL2400	1376D15G15	0	—	—	Reconditioned KL2400	10
RHKL2400K	NO STYLE	0	—	—	—	—
RHKL3125	1376D15G25	A	—	—	—	10
RHKL3150	1376D15G26	A	—	—	—	10
RHKL3175	1376D15G27	A	—	—	—	10
RHKL3200	1376D15G28	A	—	—	—	10
RHKL3225	1376D15G29	A	—	—	—	10
RHKL3250	1376D15G30	A	—	—	—	10
RHKL3300	1376D15G32	A	—	—	—	10
RHKL3350	1376D15G34	A	—	—	—	10
RHKL3400	1376D15G35	A	—	—	—	10
RHKL3400K	NO STYLE	A	—	—	—	10
RHLM2125	1376D16G05	0	—	—	Reconditioned LM2125	10
RHLM2150	1376D16G06	0	—	—	Reconditioned LM2150	10
RHLM2175	1376D16G07	0	—	—	Reconditioned LM2175	10
RHLM2200	1376D16G08	0	—	—	Reconditioned LM2200	10
RHLM2225	1376D16G09	0	—	—	Reconditioned LM2225	10
RHLM2250	1376D16G10	0	—	—	Reconditioned LM2250	10
RHLM2275	1376D16G11	0	—	—	Reconditioned LM2275	10
RHLM2300	1376D16G12	0	—	—	Reconditioned LM2300	10
RHLM2350	1376D16G14	0	—	—	Reconditioned LM2350	10
RHLM2400	1376D16G15	0	—	—	Reconditioned LM2400	10
RHLM2450	1376D16G16	0	—	—	Reconditioned LM2450	10
RHLM2500	1376D16G17	0	—	—	Reconditioned LM2500	10
RHLM2550	1376D16G18	0	—	—	Reconditioned LM2550	10

Note

① 0 = Obsolete, A = Available.

Replacement Breaker Cross-Reference

Replacement Breaker			Replacements			Notes
Catalog Number	Style Number	Status ^①	MARK 75 Catalog Number	MARK 75 Style Number	Series C Catalog Number	(See Page V12-T3-114)
RHLM2600	1376D16G19	0	—	—	Reconditioned LM2600	10
RHLM2600K	1376D16G20	0	—	—	—	—
RHLM2700	NO STYLE	0	—	—	Reconditioned LM2700	10
RHLM2800	1376D16G22	0	—	—	Reconditioned LM2800	10
RHLM3125	1376D16G35	A	—	—	—	10
RHLM3150	1376D16G36	A	—	—	—	10
RHLM3175	1376D16G37	A	—	—	—	10
RHLM3200	1376D16G38	A	—	—	—	10
RHLM3225	1376D16G39	A	—	—	—	10
RHLM3250	1376D16G40	A	—	—	—	10
RHLM3275	1376D16G41	A	—	—	—	10
RHLM3300	1376D16G42	A	—	—	—	10
RHLM3325	1376D16G43	A	—	—	—	10
RHLM3350	1376D16G44	A	—	—	—	10
RHLM3400	1376D16G45	A	—	—	—	10
RHLM3450	1376D16G46	A	—	—	—	10
RHLM3500	1376D16G47	A	—	—	—	10
RHLM3550	1376D16G48	A	—	—	—	10
RHLM3600	1376D16G49	A	—	—	—	10
RHLM3600K	1376D16G50	0	—	—	—	—
RHLM3700	1376D16G51	A	—	—	—	10
RHLM3800	1376D16G52	A	—	—	—	10
RJ2070	1376D10G02	0	—	—	Reconditioned J2070	3, 10
RJ2090	1376D10G03	0	—	—	Reconditioned J2090	3, 10
RJ2100	1376D10G04	0	—	—	Reconditioned J2100	3, 10
RJ2125	1376D10G05	0	—	—	Reconditioned J2125	3, 10
RJ2150	1376D10G06	0	—	—	Reconditioned J2150	3, 10
RJ2175	1376D10G07	0	—	—	Reconditioned J2175	3, 10
RJ2200	1376D10G08	0	—	—	Reconditioned J2200	3, 10
RJ2225	1376D10G09	0	—	—	Reconditioned J2225	3, 10
RJ2225K	NO STYLE	0	—	—	—	—
RJ3070	1376D10G22	A	—	—	—	3, 10
RJ3090	1376D10G23	A	—	—	—	3, 10
RJ3100	1376D10G24	A	—	—	—	3, 10
RJ3125	1376D10G25	A	—	—	—	3, 10
RJ3150	1376D10G26	A	—	—	—	3, 10
RJ3175	1376D10G27	A	—	—	—	3, 10
RJ3200	1376D10G28	A	—	—	—	3, 10
RJ3225	1376D10G29	A	—	—	—	3, 10
RJ3225K	NO STYLE	0	—	—	—	—
RK2070	1376D11G02	0	—	—	Reconditioned K2070	3, 10
RK2090	1376D11G03	0	—	—	Reconditioned K2090	3, 10
RK2100	1376D11G04	0	—	—	Reconditioned K2100	3, 10
RK2125	1376D11G05	0	—	—	Reconditioned K2125	3, 10
RK2150	1376D11G06	0	—	—	Reconditioned K2150	3, 10
RK2175	1376D11G07	0	—	—	Reconditioned K2175	3, 10
RK2200	1376D11G08	0	—	—	Reconditioned K2200	3, 10

Note

① 0 = Obsolete, A = Available.

Replacement Breaker Cross-Reference

Replacement Breaker		Status ①	Replacements			Notes (See Page V12-T3-114)
Catalog Number	Style Number		MARK 75 Catalog Number	MARK 75 Style Number	Series C Catalog Number	
RK2225	1376D11G09	0	—	—	Reconditioned K2225	3, 10
RK2225K	1376D11G10	0	—	—	—	—
RK3070	1376D11G22	0	RHK3070	1376D14G22	—	3, 10
RK3090	1376D11G23	0	RHK3090	1376D14G23	—	3, 10
RK3100	1376D11G24	0	RHK3100	1376D14G24	—	3, 10
RK3125	1376D11G25	0	RHK3125	1376D14G25	—	3, 10
RK3150	1376D11G26	0	RHK3150	1376D14G26	—	3, 10
RK3175	1376D11G27	0	RHK3175	1376D14G27	—	3, 10
RK3200	1376D11G28	0	RHK3200	1376D14G28	—	3, 10
RK3225	1376D11G29	0	RHK3225	1376D14G29	—	3, 10
RK3225K	1376D11G30	0	—	—	—	—
RKL2125	1376D12G05	0	—	—	Reconditioned L2125	3, 10
RKL2150	1376D12G06	0	—	—	Reconditioned L2150	3, 10
RKL2175	1376D12G07	0	—	—	Reconditioned L2175	3, 10
RKL2200	1376D12G08	0	—	—	Reconditioned L2200	3, 10
RKL2225	1376D12G09	0	—	—	Reconditioned L2225	3, 10
RKL2250	1376D12G10	0	—	—	Reconditioned L2250	3, 10
RKL2275	NO STYLE	0	—	—	—	3, 10
RKL2300	1376D12G12	0	—	—	Reconditioned L2300	3, 10
RKL2350	1376D12G14	0	—	—	Reconditioned L2350	3, 10
RKL2400	1376D12G15	0	—	—	Reconditioned L2400	3, 10
RKL2400K	NO STYLE	0	—	—	—	—
RKL3125	1376D12G25	0	RHKL3125	1376D15G25	—	3, 10
RKL3150	1376D12G26	0	RHKL3150	1376D15G26	—	3, 10
RKL3175	1376D12G27	0	RHKL3175	1376D15G27	—	3, 10
RKL3200	1376D12G28	0	RHKL3200	1376D15G28	—	3, 10
RKL3225	1376D12G29	0	RHKL3225	1376D15G29	—	3, 10
RKL3250	1376D12G30	0	RHKL3250	1376D15G30	—	3, 10
RKL3300	1376D12G32	0	RHKL3300	1376D15G32	—	3, 10
RKL3350	1376D12G34	0	RHKL3350	1376D15G34	—	3, 10
RKL3400	1376D12G35	0	RHKL3400	1376D15G35	—	3, 10
RLM2125	1376D13G05	0	—	—	Reconditioned LM2125	3, 10
RLM2150	1376D13G06	0	—	—	Reconditioned LM2150	3, 10
RLM2175	1376D13G07	0	—	—	Reconditioned LM2175	3, 10
RLM2200	1376D13G08	0	—	—	Reconditioned LM2200	3, 10
RLM2225	1376D13G09	0	—	—	Reconditioned LM2225	3, 10
RLM2250	1376D13G10	0	—	—	Reconditioned LM2250	3, 10
RLM2275	1376D13G11	0	—	—	Reconditioned LM2275	3, 10
RLM2300	1376D13G12	0	—	—	Reconditioned LM2300	3, 10
RLM2350	1376D13G14	0	—	—	Reconditioned LM2350	3, 10
RLM2400	1376D13G15	0	—	—	Reconditioned LM2400	3, 10
RLM2500	1376D13G17	0	—	—	Reconditioned LM2500	3, 10
RLM2600	1376D13G19	0	—	—	Reconditioned LM2600	3, 10
RLM2600K	1376D13G20	0	—	—	—	—
RLM2700	1376D13G21	0	—	—	Reconditioned LM2700	3, 10
RLM3150	1376D13G36	0	RHLM3150	1376D16G36	—	3, 10
RLM3175	1376D13G37	0	RHLM3175	1376D16G37	—	3, 10

Note

① 0 = Obsolete, A = Available.

Replacement Breaker Cross-Reference

Replacement Breaker			Replacements			Notes (See Page V12-T3-114)
Catalog Number	Style Number	Status ^①	MARK 75 Catalog Number	MARK 75 Style Number	Series C Catalog Number	
RLM3200	1376D13G38	0	RHLM3200	1376D16G38	—	3, 10
RLM3225	1376D13G39	0	RHLM3225	1376D16G39	—	3, 10
RLM3250	1376D13G40	0	RHLM3250	1376D16G40	—	3, 10
RLM3275	1376D13G41	0	RHLM3275	1376D16G41	—	3, 10
RLM3300	1376D13G42	0	RHLM3300	1376D16G42	—	3, 10
RLM3350	1376D13G44	0	RHLM3350	1376D16G44	—	3, 10
RLM3400	1376D13G45	0	RHLM3400	1376D16G45	—	3, 10
RLM3500	1376D13G47	0	RHLM3500	1376D16G47	—	3, 10
RLM3600	1376D13G49	0	RHLM3600	1376D16G49	—	3, 10
RLM3600K	1376D13G50	0	—	—	—	—
RLM3700	1376D13G51	0	RHLM3700	1376D16G51	—	3, 10
RLM3800	1376D13G52	0	RHLM3800	1376D16G52	—	3, 10

Note

^① 0 = Obsolete, A = Available.

Mining Breaker Replacement Cross-Reference

Replacement Breaker Mining and 1000V Catalog Number		Style Number	Status ^①	Replacements MARK 75 Catalog Number	E2 Style Number	Notes (See Page V12-T3-114)
1227C36G09	1227C36G09	0		1227C36G11	E2N312W	1-3, 5, 7, 8
1227C36G10	1227C36G10	0		1227C36G12	E2N310W	1-3, 5, 7, 8
1227C36G11	1227C36G11	A		—	E2NM312W	1-3, 5, 7, 8
1227C36G12	1227C36G12	A		—	E2NM310W	1-3, 5, 7, 8
1227C36G13	1227C36G13	0		—	E2N310WS10	1-3, 5, 7, 8
1227C36G14	1227C36G14	0		—	E2N312WS10	1-3, 5, 7, 8
1227C36G19	1227C36G19	0		—	E2N312MW	1-3, 5, 7, 8
1227C37G15	1227C37G15	0		—	E2N310WU66	1-3, 5, 7, 8
1227C37G16	1227C37G16	0		—	E2N312WU66	1-3, 5, 7, 8
1227C37G17	1227C37G17	0		1227C36G12	E2N310W	1-3, 5, 7, 8
1227C37G18	1227C37G18	0		1229C37G19	E2N310WU66	1-3, 5, 7, 8
1227C37G19	1227C37G19	0		—	E2N310WS10	1-3, 5, 7, 8
1227C37G21	1227C37G21	0		—	E2N312WS10	1-3, 5, 7, 8
1227C37G22	1227C37G22	0		1227C36G12	E2N312W	1-3, 5, 7, 8
1227C37G23	1227C37G23	0		1229C37G20	E2N312WU66	1-3, 5, 7, 8
1227C37G27	1227C37G27	0		—	E2N312MW	1-3, 5, 7, 8
1227C37G28	1227C37G28	0		1229C37G18	E2N312MWU66	1-3, 5, 7, 8
1228C81G01	1228C81G01	A		—	—	1-3, 5, 7, 8
1228C81G02	1228C81G02	A		—	—	1-3, 5, 7, 8
1228C81G03	1228C81G03	A		—	—	1-3, 5, 7, 8
1228C81G04	1228C81G04	A		—	—	1-3, 5, 7, 8
1228C82G01	1228C82G01	A		—	—	1-3, 5, 7, 8
1228C82G02	1228C82G02	A		—	—	1-3, 5, 7, 8
1228C82G03	1228C82G03	A		—	—	1-3, 5, 7, 8
1228C82G04	1228C82G04	A		—	—	1-3, 5, 7, 8
1229C37G13	1229C37G13	0		—	E2N310WU66	1-3, 5, 7, 8
1229C37G14	1229C37G14	0		—	E2N312WU66	1-3, 5, 7, 8
1229C37G15	1229C37G15	0		1229C37G19	E2N310WU66	1-3, 5, 7, 8
1229C37G16	1229C37G16	0		—	E2N312WU66	1-3, 5, 7, 8
1229C37G17	1229C37G17	0		1227C37G28	E2N312MWU66	1-3, 5, 7, 8
1229C37G18	1229C37G18	A		—	E2NM312MWU66	1-3, 5, 7, 8
1229C37G19	1229C37G19	A		—	E2NM310WU66	1-3, 5, 7, 8
1229C37G20	1229C37G20	A		—	E2NM312WU66	1-3, 5, 7, 8
1259C52G12	1259C52G12	0		—	E2FM050YM	1-3, 5, 7, 8
1259C52G13	1259C52G13	0		—	E2FM050KM	1-3, 5, 7, 8
1259C52G14	1259C52G14	0		—	E2FM100KM	1-3, 5, 7, 8
1259C52G15	1259C52G15	0		—	E2FM150TM	1-3, 5, 7, 8
1259C52G16	1259C52G16	0		—	E2FM050YM	1-3, 5, 7, 8
1259C52G17	1259C52G17	0		—	E2FM100KM	1-3, 5, 7, 8
1278C71G03	1278C71G03	0		5685D48G87	E2KE3225W	1-3, 5, 7, 8
1278C71G04	1278C71G04	0		5685D48G86	E2KE3225W	1-3, 5, 7, 8
1278C71G07	1278C71G07	0		—	E2KE3225WS10	1-3, 5, 7, 8
1278C71G08	1278C71G08	0		—	E2KE3225WS10	1-3, 5, 7, 8
1278C71G11	1278C71G11	0		—	E2KE3225MW	1-3, 5, 7, 8
1278C71G12	1278C71G12	0		—	E2KE3225MW	1-3, 5, 7, 8
1278C72G02	1278C72G02	0		5685D48G85	E2KE34002W	1-3, 5, 7, 8

Note

① 0 = Obsolete, A = Available.

Mining Breaker Replacement Cross-Reference

Replacement Breaker Mining and 1000V Catalog Number	Style Number	Status ①	Replacements MARK 75 Catalog Number	E2 Style Number	Notes (See Page V12-T3-114)
1278C72G04	1278C72G04	0	—	E2KE34002WS10	1-3, 5, 7, 8
1278C72G06	1278C72G06	0	—	E2KE3400M2W	1-3, 5, 7, 8
1278C73G01	1278C73G01	0	—	E2N3600WU66	1-3, 5, 7, 8
1278C73G02	1278C73G02	0	—	E2N3800WU66	1-3, 5, 7, 8
1278C73G03	1278C73G03	0	5685D48G84	E2N3600WU66	1-3, 5, 7, 8
1278C73G04	1278C73G04	0	2609D60G28	E2N3600WU66	1-3, 5, 7, 8
1278C73G05	1278C73G05	0	—	E2N3600WS10	1-3, 5, 7, 8
1278C73G07	1278C73G07	0	—	E2N3800WS10	1-3, 5, 7, 8
1278C73G08	1278C73G08	0	5685D48G83	E2N3800W	1-3, 5, 7, 8
1278C73G09	1278C73G09	0	2609D60G29	E2N3800WU66	1-3, 5, 7, 8
1278C73G11	1278C73G11	0	—	E2N3800MW	1-3, 5, 7, 8
1278C73G12	1278C73G12	0	2609D60G57	E2N3800MWU66	1-3, 5, 7, 8
1278C73G13	1278C73G13	0	—	E2N3800MW	1-3, 5, 7, 8
1278C73G14	1278C73G14	0	2609D60G58	E2N3800MWU66	1-3, 5, 7, 8
1284C67G01	1284C67G01	0	1284C68G01	E2KE3150W	1-3, 5, 7, 8
1284C67G02	1284C67G02	0	1284C68G02	E2KE3150WS10	1-3, 5, 7, 8
1284C67G03	1284C67G03	0	1284C68G03	E2KE3150WU66	1-3, 5, 7, 8
1284C67G04	1284C67G04	0	1284C68G04	E2KE3150WU66	1-3, 5, 7, 8
1284C67G05	1284C67G05	0	1284C68G05	E2LE3300W	1-3, 5, 7, 8
1284C67G06	1284C67G06	0	1284C68G06	E2LE3300WS10	1-3, 5, 7, 8
1284C67G07	1284C67G07	0	1284C68G07	E2LE3300WU66	1-3, 5, 7, 8
1284C67G08	1284C67G08	0	1284C68G08	E2LE3300WU66	1-3, 5, 7, 8
1284C67G09	1284C67G09	0	1284C68G09	E2LE3600W	1-3, 5, 7, 8
1284C67G10	1284C67G10	0	1284C68G10	E2LE3600WS10	1-3, 5, 7, 8
1284C67G11	1284C67G11	0	1284C68G11	E2LE3600WU66	1-3, 5, 7, 8
1284C67G12	1284C67G12	0	1284C68G12	E2LE3600WU66	1-3, 5, 7, 8
1284C68G01	1284C68G01	A	—	E2KEM3150W	1-3, 5, 7, 8
1284C68G02	1284C68G02	A	—	E2KEM3150WS10	1-3, 5, 7, 8
1284C68G03	1284C68G03	A	—	E2KEM3150WU66	1-3, 5, 7, 8
1284C68G04	1284C68G04	A	—	E2KEM3150WU66	1-3, 5, 7, 8
1284C68G05	1284C68G05	A	—	E2KEM3400W	1-3, 5, 7, 8
1284C68G06	1284C68G06	A	—	E2KEM3400WS10	1-3, 5, 7, 8
1284C68G07	1284C68G07	A	—	E2KEM3400WU66	1-3, 5, 7, 8
1284C68G08	1284C68G08	A	—	E2KEM3400WU66	1-3, 5, 7, 8
1284C68G09	1284C68G09	A	—	E2LEM3600W	1-3, 5, 7, 8
1284C68G10	1284C68G10	A	—	E2LEM3600WS10	1-3, 5, 7, 8
1284C68G11	1284C68G11	A	—	E2LEM3600WU66	1-3, 5, 7, 8
1284C68G12	1284C68G12	A	—	E2LEM3600WU66	1-3, 5, 7, 8
1284C80G01	1284C80G01	0	1284C68G01	E2KE3150W	1-3, 5, 7, 8
1284C80G02	1284C80G02	0	1284C68G02	E2KE3150WS10	1-3, 5, 7, 8
1284C80G03	1284C80G03	0	1284C68G03	E2KE3150WU66	1-3, 5, 7, 8
1284C80G04	1284C80G04	0	1284C68G04	E2KE3150WU66	1-3, 5, 7, 8
1284C80G05	1284C80G05	0	1284C68G05	E2LE3300W	1-3, 5, 7, 8
1284C80G06	1284C80G06	0	1284C68G06	E2LE3300WS10	1-3, 5, 7, 8
1284C80G07	1284C80G07	0	1284C68G07	E2LE3300WU66	1-3, 5, 7, 8
1284C80G08	1284C80G08	0	1284C68G08	E2LE3300WU66	1-3, 5, 7, 8

Note

① 0 = Obsolete, A = Available.

Mining Breaker Replacement Cross-Reference

Replacement Breaker		Status ^①	Replacements		Notes (See Page V12-T3-114)
Mining and 1000V Catalog Number	Style Number		MARK 75 Catalog Number	E2 Style Number	
1284C80G09	1284C80G09	0	1284C68G09	E2LE3600W	1-3, 5, 7, 8
1284C80G10	1284C80G10	0	1284C68G10	E2LE3600WS10	1-3, 5, 7, 8
1284C80G11	1284C80G11	0	1284C68G11	E2LE3600WU66	1-3, 5, 7, 8
1284C80G12	1284C80G12	0	1284C68G12	E2LE3600WU66	1-3, 5, 7, 8
1284C81G01	1284C81G01	0	1284C83G01	E2N3800W	1-3, 5, 7, 8
1284C81G02	1284C81G02	0	1284C83G02	E2N3800WS10	1-3, 5, 7, 8
1284C81G03	1284C81G03	0	1284C83G03	E2N3800WU66	1-3, 5, 7, 8
1284C81G04	1284C81G04	0	1284C83G04	E2N3800WU66	1-3, 5, 7, 8
1284C82G01	1284C82G01	0	1284C83G01	E2N3800W	1-3, 5, 7, 8
1284C82G02	1284C82G02	0	1284C83G02	E2N3800WS10	1-3, 5, 7, 8
1284C82G03	1284C82G03	0	1284C83G03	E2N3800WU66	1-3, 5, 7, 8
1284C82G04	1284C82G04	0	1284C83G04	E2N3800WU66	1-3, 5, 7, 8
1284C83G01	1284C83G01	A	—	E2NM3800W	1-3, 5, 7, 8
1284C83G02	1284C83G02	A	—	E2NM3800WS10	1-3, 5, 7, 8
1284C83G03	1284C83G03	A	—	E2NM3800WU66	1-3, 5, 7, 8
1284C83G04	1284C83G04	A	—	E2NM3800WU66	1-3, 5, 7, 8
1291C26G01	1291C26G01	0	—	E2K3225AWU66	1-3, 5, 7, 8
1291C26G02	1291C26G02	0	—	E2K3225DWU66	1-3, 5, 7, 8
1291C26G03	1291C26G03	0	1291C26G12	E2K3225AWU66	1-3, 5, 7, 8
1291C26G04	1291C26G04	0	1291C26G13	E2K3225DWU66	1-3, 5, 7, 8
1291C26G05	1291C26G05	0	1291C26G14	E2K3400MAWU66	1-3, 5, 7, 8
1291C26G06	1291C26G06	0	1291C26G15	E2K3400MDWU66	1-3, 5, 7, 8
1291C26G07	1291C26G07	0	—	E2K3400MAWU66	1-3, 5, 7, 8
1291C26G08	1291C26G08	0	1291C26G16	E2K3400MAWU66	1-3, 5, 7, 8
1291C26G12	1291C26G12	A	—	E2KEM3225WU66	1-3, 5, 7, 8
1291C26G13	1291C26G13	A	—	E2KEM3225WU66	1-3, 5, 7, 8
1291C26G14	1291C26G14	A	—	E2KEM3225MWU66	1-3, 5, 7, 8
1291C26G15	1291C26G15	A	—	E2KEM3225MWU66	1-3, 5, 7, 8
1291C26G16	1291C26G16	A	—	E2KEM3225MWU66	1-3, 5, 7, 8
1291C26G17	1291C26G17	0	—	E2KE3225WU66	1-3, 5, 7, 8
1291C26G18	1291C26G18	0	—	E2KE3225WU66	1-3, 5, 7, 8
1291C26G19	1291C26G19	0	1291C26G12	E2KE3225WU66	1-3, 5, 7, 8
1291C26G20	1291C26G20	0	1291C26G13	E2KE3225WU66	1-3, 5, 7, 8
1291C26G21	1291C26G21	0	—	E2KE3225MWU66	1-3, 5, 7, 8
1291C26G22	1291C26G22	0	1291C26G15	E2KE3225MWU66	1-3, 5, 7, 8
1291C32G01	1291C32G01	0	—	E2LE3400WU66	1-3, 5, 7, 8
1291C32G02	1291C32G02	0	1291C32G07	E2LE3400WU66	1-3, 5, 7, 8
1291C32G03	1291C32G03	0	OMIT	E2LE3400WU66	1-3, 5, 7, 8
1291C32G04	1291C32G04	0	1291C32G09	E2LE3400MWU66	1-3, 5, 7, 8
1291C32G05	1291C32G05	0	—	E2KE3400WU66	1-3, 5, 7, 8
1291C32G06	1291C32G06	0	1291C32G07	E2KE34002WU66	1-3, 5, 7, 8
1291C32G07	1291C32G07	A	—	E2KEM34002WU66	1-3, 5, 7, 8
1291C32G08	1291C32G08	0	1291C32G09	E2KE3400M2WU66	1-3, 5, 7, 8
1291C32G09	1291C32G09	A	—	E2KEM3400M2WU66	1-3, 5, 7, 8
1366D21G01	1366D21G01	0	—	E2F030EM	1-3, 5, 7, 8
1366D21G02	1366D21G02	0	—	E2F050YM	1-3, 5, 7, 8

Note

① 0 = Obsolete, A = Available.

Mining Breaker Replacement Cross-Reference

Replacement Breaker		Status ^①	Replacements		Notes (See Page V12-T3-114)
Mining and 1000V Catalog Number	Style Number		MARK 75 Catalog Number	E2 Style Number	
1366D21G03	1366D21G03	0	—	E2F050YM+ 625B229G08	1-3, 5, 7, 8
1366D21G04	1366D21G04	0	—	E2F100KM	1-3, 5, 7, 8
1366D21G05	1366D21G05	0	—	E2F100KMU62+ 625B229G08	1-3, 5, 7, 8
1366D21G06	1366D21G06	0	—	E2F050YM+ 625B229G08	1-3, 5, 7, 8
1366D21G07	1366D21G07	0	—	E2F100KMU62+ 625B229G08	1-3, 5, 7, 8
1366D21G08	1366D21G08	0	—	E2F030EM	1-3, 5, 7, 8
1366D21G09	1366D21G09	0	—	E2F030EM+ 625B229G08	1-3, 5, 7, 8
1366D21G10	1366D21G10	0	—	E2F030EMU62+ 625B229G08	1-3, 5, 7, 8
1366D21G11	1366D21G11	0	—	E2F030EMS22+ 625B229G08	1-3, 5, 7, 8
1366D21G12	1366D21G12	0	—	E2F030EMU62	1-3, 5, 7, 8
1366D21G13	1366D21G13	0	—	E2F030EM	1-3, 5, 7, 8
1366D21G14	1366D21G14	0	—	E2F3030	1-3, 5, 7, 8
1366D21G15	1366D21G15	0	—	E2F3030U62	1-3, 5, 7, 8
1366D21G16	1366D21G16	0	—	E2F3030S22	1-3, 5, 7, 8
1366D21G17	1366D21G17	0	—	E2F050YM	1-3, 5, 7, 8
1366D21G18	1366D21G18	0	—	E2F100KM	1-3, 5, 7, 8
1366D21G19	1366D21G19	0	—	E2F100KM+ 625B229G08	1-3, 5, 7, 8
1366D21G20	1366D21G20	0	—	E2F100KMU62+ 625B229G08	1-3, 5, 7, 8
1366D21G22	1366D21G22	0	—	E2F100KMS22+ 625B229G08	1-3, 5, 7, 8
1366D21G23	1366D21G23	A	—	E2F100KM+ 625B229G08	1-3, 5, 7, 8
1366D21G24	1366D21G24	A	—	E2F100KMU62+ 625B229G08	1-3, 5, 7, 8
1366D21G27	1366D21G27	0	—	E2F100KMU62	1-3, 5, 7, 8
1366D21G28	1366D21G28	0	—	E2F3100	1-3, 5, 7, 8
1366D21G29	1366D21G29	0	—	E2F3100U62	1-3, 5, 7, 8
1366D21G30	1366D21G30	A	—	E2F100KM	1-3, 5, 7, 8
1366D21G31	1366D21G31	A	—	E2F100KMU62	1-3, 5, 7, 8
1366D21G32	1366D21G32	A	—	E2F100KMS22	1-3, 5, 7, 8
1366D21G33	1366D21G33	0	—	E2F3100S22	1-3, 5, 7, 8
1366D21G34	1366D21G34	0	—	E2F050YMU62	1-3, 5, 7, 8
1366D21G35	1366D21G35	0	—	E2F050YM+ 625B229G08	1-3, 5, 7, 8
1366D21G36	1366D21G36	0	—	E2F050YMU62+ 625B229G08	1-3, 5, 7, 8
1366D21G37	1366D21G37	0	—	E2F050YMS22	1-3, 5, 7, 8
1366D21G38	1366D21G38	A	—	E2F050YMU62	1-3, 5, 7, 8
1366D21G39	1366D21G39	A	—	E2F050YM+ 625B229G08	1-3, 5, 7, 8

Note

① 0 = Obsolete, A = Available.

Mining Breaker Replacement Cross-Reference

Replacement Breaker Mining and 1000V Catalog Number	Style Number	Status ^①	Replacements MARK 75 Catalog Number	E2 Style Number	Notes (See Page V12-T3-114)
1366D21G40	1366D21G40	A	—	E2F050YMU62+ 625B229G08	1-3, 5, 7, 8
1366D21G41	1366D21G41	A	—	E2F050YMS22	1-3, 5, 7, 8
1366D21G42	1366D21G42	A	—	E2F030EMU62+ 625B229G08	1-3, 5, 7, 8
1366D21G43	1366D21G43	O	—	E2F100KMS22+ 625B229G08	1-3, 5, 7, 8
1366D21G44	1366D21G44	A	—	E2F100KMS22+ 625B229G08	1-3, 5, 7, 8
1366D21G45	1366D21G45	O	—	E2F100RMS22	1-3, 5, 7, 8
1366D21G46	1366D21G46	O	—	E2F3015U62	1-3, 5, 7, 8
1373D88G13	1373D88G13	O	1373D89G09	E2N312W	1-3, 5, 7, 8
1373D88G14	1373D88G14	O	1373D89G10	E2N312WS10	1-3, 5, 7, 8
1373D88G15	1373D88G15	O	1373D89G11	E2N312WU66	1-3, 5, 7, 8
1373D88G16	1373D88G16	O	1373D89G12	E2N312WU66	1-3, 5, 7, 8
1373D88G17	1373D88G17	O	1373D89G09	E2N312W	1-3, 5, 7, 8
1373D88G18	1373D88G18	O	1373D89G10	E2N312WS10	1-3, 5, 7, 8
1373D88G19	1373D88G19	O	1373D89G11	E2N312WU66	1-3, 5, 7, 8
1373D88G20	1373D88G20	O	1373D89G12	E2N312WU66	1-3, 5, 7, 8
1373D89G09	1373D89G09	A	—	E2NM312W	1-3, 5, 7, 8
1373D89G10	1373D89G10	A	—	E2NM312WS10	1-3, 5, 7, 8
1373D89G11	1373D89G11	A	—	E2NM312WU66	1-3, 5, 7, 8
1373D89G12	1373D89G12	A	—	E2NM312WU66	1-3, 5, 7, 8
2600D43G11	2600D43G11	O	1264C99G03	—	—
2600D43G12	2600D43G12	O	1264C99G03	—	—
2600D43G14	2600D43G14	O	1264C99G03	—	—
2602D86G11	2602D86G11	O	1264C99G05	—	—
2602D86G12	2602D86G12	O	1264C99G05	—	—
2602D86G13	2602D86G13	O	1264C99G05	—	—
2602D86G14	2602D86G14	O	1264C99G05	—	—
2602D99G05	2602D99G05	O	1264C99G02	—	—
2602D99G06	2602D99G06	O	1264C99G02	—	—
2602D99G07	2602D99G07	O	1264C99G02	—	—
2602D99G08	2602D99G08	O	1264C99G02	—	—
2603D48G07	2603D48G07	O	2603D48G09	—	—
2603D48G08	2603D48G08	O	2603D48G09	—	—
2609D60G01	2609D60G01	O	—	E2K3225AWS10	1-3, 5, 7, 8
2609D60G02	2609D60G02	O	—	E2K3225DWS10	1-3, 5, 7, 8
2609D60G03	2609D60G03	O	—	E2LE3400WS10	1-3, 5, 7, 8
2609D60G04	2609D60G04	O	—	E2N3600WS10	1-3, 5, 7, 8
2609D60G05	2609D60G05	O	—	E2N3800WS10	1-3, 5, 7, 8
2609D60G08	2609D60G08	O	—	E2FM100KM	1-3, 5, 7, 8
2609D60G09	2609D60G09	O	—	E2FM100KMU13	1-3, 5, 7, 8
2609D60G10	2609D60G10	O	—	E2FM050YM	1-3, 5, 7, 8
2609D60G17	2609D60G17	O	—	E2N3600WU66	1-3, 5, 7, 8
2609D60G18	2609D60G18	O	—	E2N3800WU66	1-3, 5, 7, 8
2609D60G19	2609D60G19	O	—	E2N3600W	1-3, 5, 7, 8
2609D60G20	2609D60G20	O	2609D60G29	E2N3800WU66	1-3, 5, 7, 8

Note

① O = Obsolete, A = Available.

Mining Breaker Replacement Cross-Reference

Replacement Breaker Mining and 1000V Catalog Number		Style Number	Status ①	Replacements MARK 75 Catalog Number	E2 Style Number	Notes (See Page V12-T3-114)
2609D60G28	2609D60G28	A	—	—	E2LEM36002WU66	1-3, 5, 7, 8
2609D60G29	2609D60G29	A	—	—	E2NM3800WU66	1-3, 5, 7, 8
2609D60G40	2609D60G40	O	—	—	E2K3400MAW	1-3, 5, 7, 8
2609D60G41	2609D60G41	O	—	—	E2K3400MDW	1-3, 5, 7, 8
2609D60G44	2609D60G44	O	—	—	E2LE3400MW	1-3, 5, 7, 8
2609D60G46	2609D60G46	O	—	—	E2N3800MW	1-3, 5, 7, 8
2609D60G47	2609D60G47	O	—	—	E2N3800MWU66	1-3, 5, 7, 8
2609D60G48	2609D60G48	O	—	—	E2N3800MW	1-3, 5, 7, 8
2609D60G49	2609D60G49	O	2609D60G58	—	E2N3800MWU66	1-3, 5, 7, 8
2609D60G57	2609D60G57	A	—	—	E2NM3800MW	1-3, 5, 7, 8
2609D60G58	2609D60G58	A	—	—	E2NM312MW	1-3, 5, 7, 8
2609D60G61	2609D60G61	O	—	—	E2LE3400MWS86	1-3, 5, 7, 8
2609D60G63	2609D60G63	O	—	—	E2LE34002WU66	1-3, 5, 7, 8
2609D60G64	2609D60G64	O	—	—	E2K3400MAW	1-3, 5, 7, 8
2609D60G66	2609D60G66	O	—	—	E2K3400MAWS10	1-3, 5, 7, 8
2609D60G67	2609D60G67	O	2609D60G70	—	E2K3400MAW	1-3, 5, 7, 8
2609D60G69	2609D60G69	O	—	—	E2K3400MAWS10	1-3, 5, 7, 8
2609D60G70	2609D60G70	A	—	—	E2KEM3225MW	1-3, 5, 7, 8
2610D64G07	2610D64G07	O	2610D64G13	—	—	—
2610D64G08	2610D64G08	O	2610D64G13	—	—	—
2610D64G09	2610D64G09	O	2610D64G13	—	—	—
2610D64G10	2610D64G10	O	2610D64G13	—	—	—
5685D48G45	5685D48G45	O	—	—	E2FM100KMU13+ 625B229G08	1-3, 5, 7, 8
5685D48G71	5685D48G71	O	5685D48G83	—	E2N3800W	1-3, 5, 7, 8
5685D48G72	5685D48G72	O	5685D48G84	—	E2N3600W	1-3, 5, 7, 8
5685D48G73	5685D48G73	O	5685D48G85	—	E2LE3400W	1-3, 5, 7, 8
5685D48G74	5685D48G74	O	5685D48G86	—	E2K3225DW	1-3, 5, 7, 8
5685D48G75	5685D48G75	O	1291C26G12	—	E2K3225AW	1-3, 5, 7, 8
5685D48G83	5685D48G83	A	—	—	E2NM3800W	1-3, 5, 7, 8
5685D48G84	5685D48G84	A	—	—	E2LEM36002W	1-3, 5, 7, 8
5685D48G85	5685D48G85	A	—	—	E2KEM34002W	1-3, 5, 7, 8
5685D48G86	5685D48G86	A	—	—	E2KEM3225W	1-3, 5, 7, 8
5685D48G87	5685D48G87	A	—	—	E2KEM3225W	1-3, 5, 7, 8
5685D48G88	5685D48G88	O	—	—	E2FM100KM+ 625B229G08	1-3, 5, 7, 8
5685D48G89	5685D48G89	O	—	—	E2FM050YM+ 625B229G08	1-3, 5, 7, 8
5685D48G90	5685D48G90	O	—	—	E2FM050YMU13	1-3, 5, 7, 8
2609D99G06	2609D99G06	O	—	—	—	—
5685D48G42	5685D48G42	O	—	—	—	—
5685D48G36	5685D48G36	O	—	—	—	—
5685D48G30	5685D48G30	O	—	—	—	—
5685D48G24	5685D48G24	O	—	—	—	—
5685D48G18	5685D48G18	O	—	—	—	—
5685D48G12	5685D48G12	O	—	—	—	—
5685D48G06	5685D48G06	O	—	—	—	—

Note

① O = Obsolete, A = Available.

Pricing Information

Price and Availability Digest (PAD)

Vista/VISTALINE Discount Symbol RCB-2

X-ON Electronics

Largest Supplier of Electrical and Electronic Components

Click to view similar products for [Eaton manufacturer](#):

Other Similar products are found below :

[BK1-S506-2-R](#) [BK/C520-4A](#) [BK/GMW-3/4](#) [BK/MDL-V-12](#) [BK/FRN-R-1/2](#) [FHN31G1](#) [CH222B](#) [SAMI-2I](#) [SAMI-6I](#) [LPN-RK-25SP](#) [ZE9](#)
[ZE6](#) [LPN-RK-15SP](#) [BK/GMD-200MA](#) [LPN-RK-3SP](#) [BK/HBV-M](#) [BK/FRN-R-1](#) [SAMI-1I](#) [2499](#) [GMC-500MA](#) [BK/AGC-3/10](#) [BK/ETF-2](#)
[BK/AGC-1-6/10](#) [BK/TDC180-2](#) [AT-20](#) [BK/HTB-92I](#) [BK/MDA-1](#) [BK/SC-45](#) [BK/C519-1A](#) [BK/MDA-2-1/2](#) [BK/MDA-7](#) [BK/C520-500MA](#)
[BK/GMC-300MA](#) [BK/MDA-15](#) [BK/C519-2.5A](#) [BK/GMD-125MA](#) [BK/GMC-125MA](#) [BK/MDA-4](#) [BK/C519-500MA](#) [BK/C519-1.5A](#)
[BK/AGC-1/8](#) [BK/GMD-600MA](#) [BK/MDL-1-6/10](#) [BK/ABC-6](#) [AGC-1-2](#) [BK/MDL-3-2/10](#) [BK/GMA-3A](#) [89096-015](#) [8943K28](#) [8946K153](#)