

LAN2VSOP

1000BASE-T LAN transformer, PoE



Photo is representative

Product features

- IEEE 802.3ab, 802.3.at compliant
- 1500 Vac isolation between primary and secondary
- Single and dual port options
- Toroid core winding, open header, surface mount
- Weight 2.04 g-3.30 g typical
- Moisture sensitivity level (MSL): 1

Applications

- SELV/ELV equipment
- IP telephones
- Wireless LAN access point
- IoT, Remote monitoring
- Smart TV
- Network camera
- Data centers

Environmental compliance and general specifications

- Operating ambient temperature range: -40 °C to +85 °C
- Storage temperature range (component): -40 °C to +125 °C



Product specifications (+25 °C)

Meets IEEE 802.3at Standards 720 mA current capability Per PoE Port / Two-pair.

Part number ⁴	Port	Pins	Inductance ^{1,5} (μ H)	Leakage inductance ^{1,5} (μ H)	DCR ^{2,5} (Ω)	CWW ^{1,5} (pF)	Turns ratio ³	Insertion loss ^{3,5} (dB)	Return loss ^{3,5} (dB)	Cross talk ⁵ (dB) (between each channel)	CMRR ^{3,5} (dB)
LAN2VSOPS24351C2*	Single	24	350 @ 13 mA DC Bias	0.5	1.4	35	1CT:1CT, $\pm 2\%$	-1.1 @ 0.5-100 MHz	-18 @ 0.5-40 MHz -12+20*log(f/80) @40.1-100 MHz	-35 @ 0.5-40 MHz -33+20*log(f/50) @ 40.1-100 MHz	-30 @ 0.5-100 MHz
LAN2VSOPD48351C2*	Dual	48	350 @ 10.8 mA DC Bias	0.5	0.6	35	1CT:1CT, $\pm 2\%$	-1.1 @ 0.5-100 MHz	-18 @ 0.5-40 MHz -12+20*log(f/80) @40.1-100 MHz	-35 @ 0.5-40 MHz -33+20*log(f/50) @ 40.1-100 MHz	-30 @ 0.5-100 MHz

1. Inductance (Transformer side), Leakage Inductance (Transformer side, short CMC side),
CWW (Interwinding Capacitance, Pri to Sec): Test parameters: 100 kHz, 0.2 V

2. DCR: CMC side

3. Turns ratio, Insertion loss, return loss and CMRR (Common mode rejection ratio): Primary to secondary.
Polarity pin 1 side in phase

*Operating temperature: (temperature rise not included) -40 °C to +85 °C

LAN2VSOPS24351C2: Temperature rise \leq 15 °C; Hipot 1500 Vac primary to secondary

LAN2VSOPD48351C2: Temperature rise \leq 35 °C, inductance will be 300 μ H min @ 10.8 mA DC Bias @ +120 °C include temperature rise;
Hipot 1500 Vac primary to secondary

4. Part number definition: LAN2VSOPxxx351xx
LAN2VSOP= Product code

xxx: S24 = Single port, 24 Pin, D48 = Dual port, 48 Pin

xx: C2 = -40 to +85 °C

5. DCR, CWW, Leakage inductance and Insertion loss values are maximum; Inductance, Return loss, CMRR and Cross talk values are minimum

Mechanical parameters (mm)

LAN2VSOPS24351C2

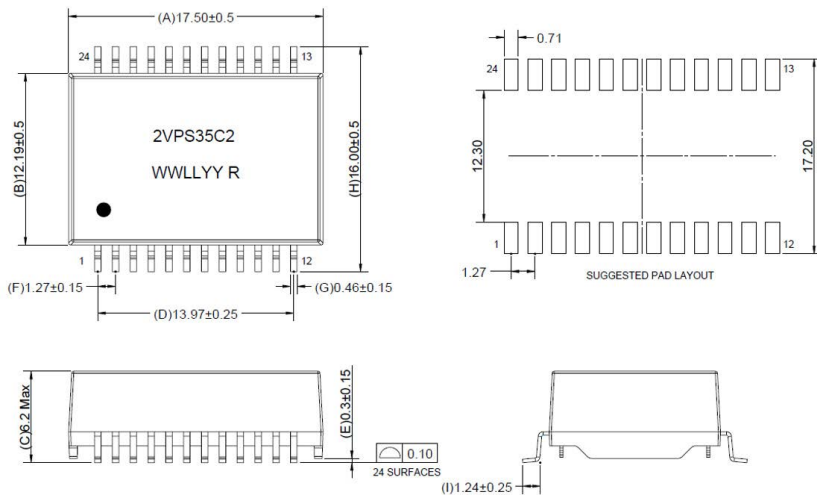

Schematic

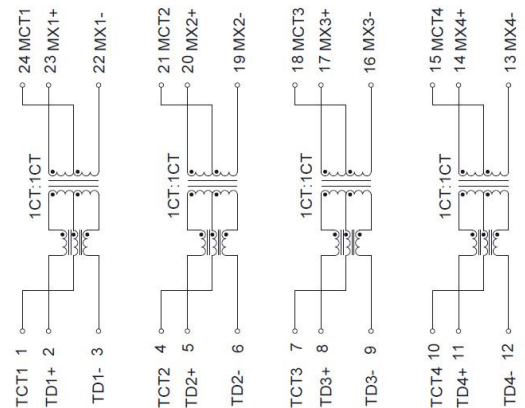

Part marking: 2VPS35C2, WWLLYY R = Lot code, Dot indicates pin 1

Pin length does not include include solder point

Silkscreen thickness: 0.1 mm to 0.15 mm

Traces or vias underneath the transformer is not recommended

Mechanical parameters (mm)
LAN2VSOPD48351C2

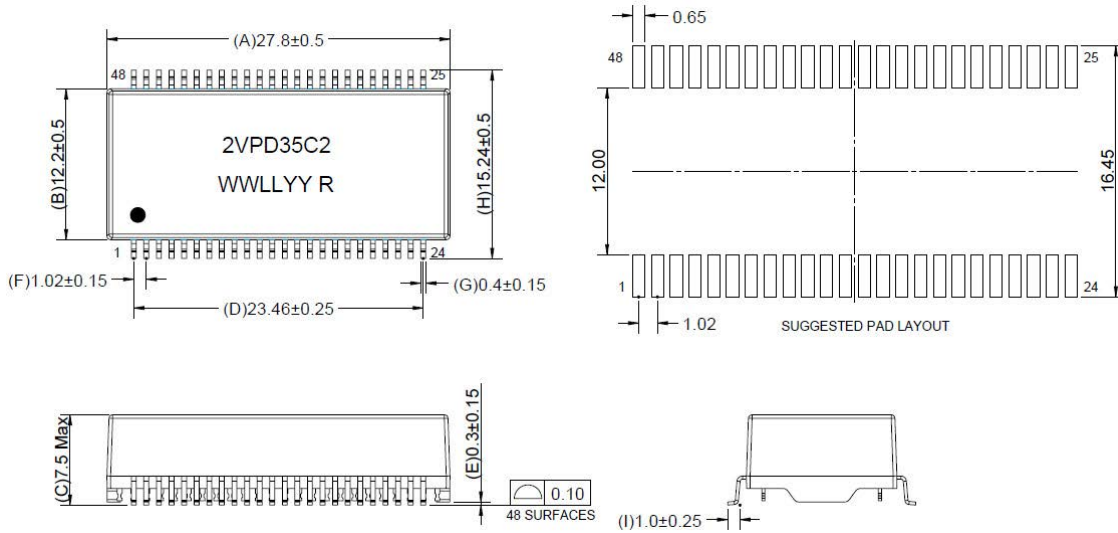

Part marking: 2VPD35C2, WWLLYY R = Lot code, Dot indicates pin 1

Pin length does not include include solder point

Silkscreen thickness: 0.1 mm to 0.15 mm

Traces or vias underneath the transformer is not recommended

Schematic

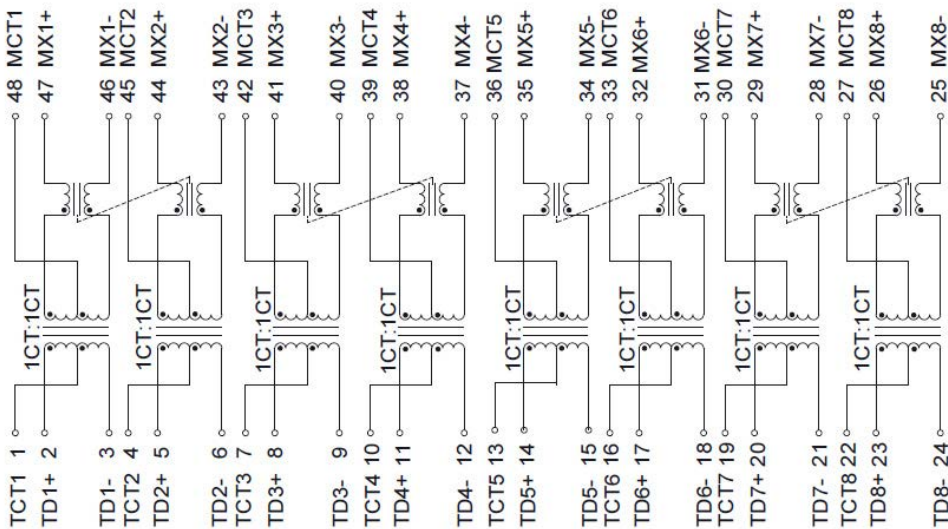

Packaging information (mm)

Drawing not to scale

Supplied in tape and reel packaging on a 13" diameter reel, EIA-481 compliant

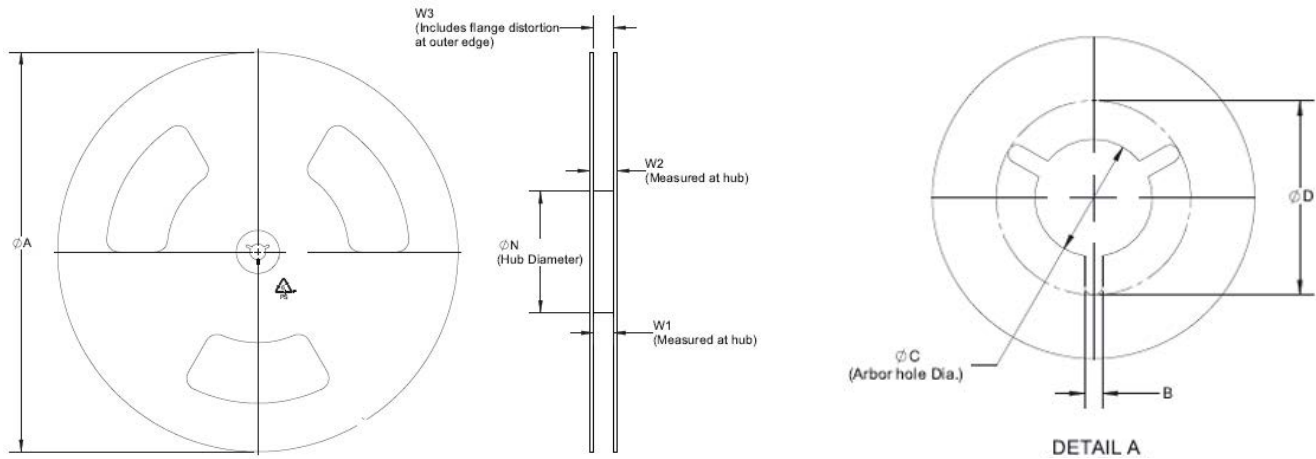

Reel dimension (mm)

Part number	ØA	B	ØC	ØD	ØN	W1	W2	W3
LAN2VSOPS24351C2	330 ± 2	1.5 min	13 + 0.5 / -0.2	20.2 min	100	32.4 + 2 / -0	38.4 max	N/A
LAN2VSOPD48351C2	330 ± 2	1.5 min	13 + 0.5 / -0.2	20.2 min	100	44.4 + 2 / -0	50.4 max	N/A

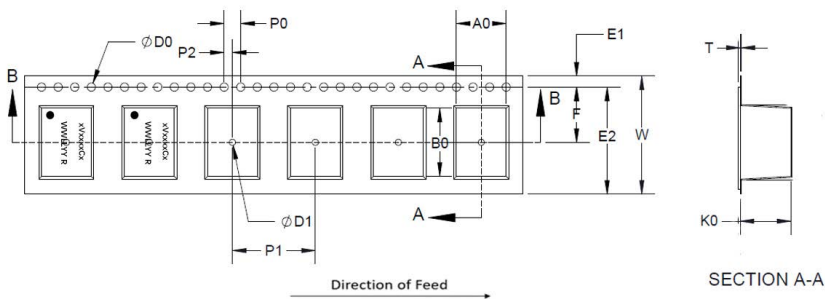

Tape dimension (mm)

Part number	Ao	Bo	Ko	T	W	F	E1	E2	P0	P1	P2	ØD0	ØD1
LAN2VSOPS24351C2	17 ± 0.1	17.9 ± 0.1	7.2 ± 0.1	0.5 ± 0.05	32 ± 0.3	14.2 ± 0.1	1.75 ± 0.1	29.85 min	4 ± 0.1	20 ± 0.1	2 ± 0.15	1.5 + 0.1 / -0	2.0 min
LAN2VSOPD48351C2	16 ± 0.15	28.2 ± 0.1	7.8 ± 0.1	0.5 ± 0.05	44 ± 0.3	20.2 ± 0.1	1.75 ± 0.1	41.85 min	4 ± 0.1	24 ± 0.1	2 ± 0.1	1.5 + 0.1 / -0	2 + 0.1 / -0

Packaging quantity

Part number	Reel	Bag	Box	Carton
LAN2VSOPS24351C2	400	400	400	1600
LAN2VSOPD48351C2	300	300	600	1200

General specifications

Solderability	J-STD-002.	8 hours steam age test, Solder: +245 °C ± 5 °C (5 s)
Reflow	MIL-STD-202G Condition J	+260 °C ± 5 °C, 30 s ± 5 s, 1 times reflow
Resistance soldering heat	MIL-STD-202H, Method 210	+260 °C , 10 s
Operational life	MIL-STD-202, Method 108	1000 hours, +85 °C @ 720 mA
Temperature cycling	MIL-STD-202G	High temperature= +125 °C, low temperature -40 °C, conversion time 15 minutes, 32 cycles
Biased humidity	MIL-STD-202G	+85 °C, 85% RH, Duration= 1000 hours
Vibration	MIL-STD-202	10 Hz to 80 Hz, Increased at +3 dB/octave, 80 Hz to 350 Hz, 0.053 g ² /Hz, 350 Hz to 2000 Hz, Decrease at -3 dB/octave, X, Y and Z vibrate for 15 minutes each.
Mechanical shock	MIL-STD-202, Method 213	Half-sine shock pulse, peak=50 g's, 11 ms, total 18 shocks
Terminal strength	CBA203A-001	Standard: 4.5 kg, Minimum: 60 s, no visible damage

Solder reflow profile

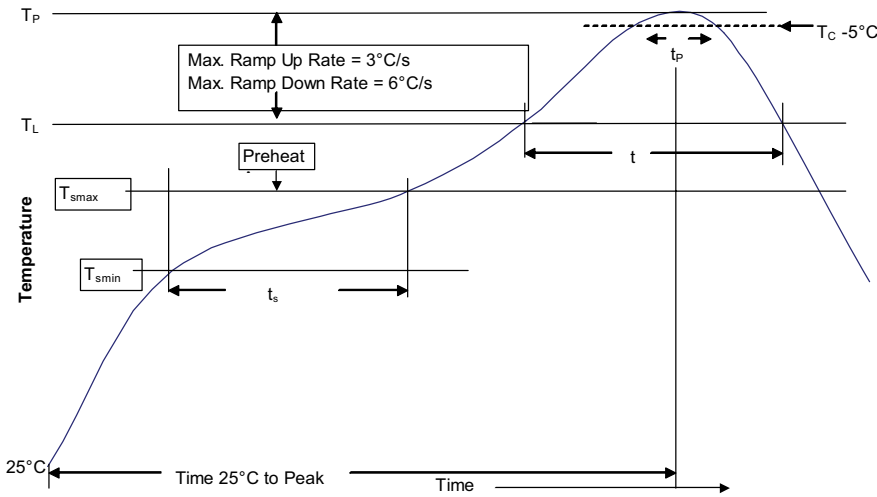

Table 1 - Standard SnPb solder (T_c)

Package thickness	Volume mm^3 <350	Volume mm^3 \geq 350
<2.5 mm	235 °C	220 °C
\geq 2.5 mm	220 °C	220 °C

Table 2 - Lead (Pb) free solder (T_c)

Package thickness	Volume mm^3 <350	Volume mm^3 350 - 2000	Volume mm^3 >2000
<1.6 mm	260 °C	260 °C	260 °C
1.6 – 2.5 mm	260 °C	250 °C	245 °C
>2.5 mm	250 °C	245 °C	245 °C

Reference J-STD-020

Profile feature	Standard SnPb solder	Lead (Pb) free solder
Preheat and soak		
• Temperature min. (T_{smin})	100 °C	150 °C
• Temperature max. (T_{smax})	150 °C	200 °C
• Time (T_{smin} to T_{smax}) (t_s)	60-120 seconds	60-120 seconds
Ramp up rate T_L to T_p	3 °C/ second max.	3 °C/ second max.
Liquidous temperature (T_L)	183 °C	217 °C
Time (t_L) maintained above T_L	60-150 seconds	60-150 seconds
Peak package body temperature (T_p)*	Table 1	Table 2
Time (t_p)* within 5 °C of the specified classification temperature (T_c)	20 seconds*	30 seconds*
Ramp-down rate (T_p to T_L)	6 °C/ second max.	6 °C/ second max.
Time 25 °C to peak temperature	6 minutes max.	8 minutes max.

* Tolerance for peak profile temperature (T_p) is defined as a supplier minimum and a user maximum.

Life Support Policy: Eaton does not authorize the use of any of its products for use in life support devices or systems without the express written approval of an officer of the Company. Life support systems are devices which support or sustain life, and whose failure to perform, when properly used in accordance with instructions for use provided in the labeling, can be reasonably expected to result in significant injury to the user.

Eaton reserves the right, without notice, to change design or construction of any products and to discontinue or limit distribution of any products. Eaton also reserves the right to change or update, without notice, any technical information contained in this bulletin.

Eaton
Electronics Division
1000 Eaton Boulevard
Cleveland, OH 44122
United States
Eaton.com/electronics

© 2023 Eaton
All Rights Reserved
Printed in USA
Publication No. ELX1376 BU-ELX22244
October 2023

Eaton is a registered trademark.
All other trademarks are property of their respective owners.

Follow us on social media to get the latest product and support information.



X-ON Electronics

Largest Supplier of Electrical and Electronic Components

Click to view similar products for [Audio Transformers](#) / [Signal Transformers](#) category:

Click to view products by [Eaton](#) manufacturer:

Other Similar products are found below :

[CU4S0506AT-2655-H1](#) [MGPWT-00449-P](#) [PE-64961](#) [1812WBT2-4](#) [BX1194WNL](#) [1879479-1](#) [PA1528ANL](#) [T1137NLT](#) [PE-65848FNLT](#)
[H5019EFNL](#) [CX2045ALNLT](#) [TG1G-E201NV6LF](#) [MGPWT-00059-P](#) [MGPWT-00266-P](#) [MGPWT-00278-P](#) [MGPWT-00431-P](#) [TTC-100](#)
[TTC-143-H](#) [TTC-5032-1](#) [4-1879391-0](#) [100213](#) [T1142NL](#) [TG1G-S001NZLF](#) [T1124NL](#) [1879732-1](#) [2-1879391-5](#) [MABA-010321-CT1A42](#)
[TX1341NL](#) [H0013FNL](#) [H5020FNL](#) [H2009FNLT](#) [H5004NLT](#) [S553-5999-52-F](#) [SCMS7D43AY100PT1](#) [T5008NLT](#) [PE-68517T](#) [MGPWT-](#)
[00339-P](#) [H5014FNLT](#) [TX1473NLT](#) [PE-69011NLT](#) [CX2043LNLT](#) [H7137FNLT](#) [H1259NLT](#) [TX1344NLT](#) [LM-LP-1005L](#) [H0013NLT](#)
[S558-5500-JV](#) [TX1193NLT](#) [T7015NL](#) [T1124NLT](#)