

RMQ Titan Description



Aesthetics and functionality

Attractive looks and practical operation – this combination is exemplified by industrial design from Moeller. The new RMQ Titan Control Circuit Devices program underscores this claim. The titanium-coloured front ring lends the program its name – and offers the devices and systems in a modern package with numerous application advantages. Naturally, RMQ Titan Control Circuit Devices are designed for worldwide application. They comply with all relevant international standards such as IEC/EN 60 947 as well as certification requirements and guidelines such as UL and CE. The high IP 66 degree of protection permits use in rugged industrial applications. The program is therefore extremely flexible.

Practical orientation that pays off

The ergonomic design of the new control circuit devices pays dividends in daily use. Button elements, for instance, are correctly shaped for the fingertips. Indicator lights are fitted with specially developed lenses which guarantee perfect illumination.

Colours speak louder than words

A clear colour signal replaces long explanations. Specified colours are assigned commands and meanings which are internationally understood. The illuminated operating elements and Indicator lights clearly display these colours even in darkness or distraction from other lights. To prevent yellow light from filament bulbs interfering with the lens colours, RMQ Titan Control Circuit Devices are provided with LEDs in red, green, white and also blue, when required.

LEDs – dependable, economical lighting elements

LEDs require less current and thus produce less heat than filament bulbs. They also have no thin little wires that often burn through after a time or break due to shock or vibration. In fact, LEDs are completely vibration-proof and they function 100,000 hours non-stop with no loss of signal data. With no chance of sudden outages, device monitoring is best ensured.



11.5 years non-stop – a far-sighted decision

100,000 operating hours corresponds to 11.5 years in constant operation. After this length of time, RMQ Titan LED elements do not simply go out – their illumination intensity has simply dropped by half. Replacing a lamp is just as superfluous as planning and wiring a new lamp circuit. Even ordering is simplified since the LED and holder are delivered as a complete unit. With two voltage ranges from 18 – 30 VAC/DC and 85 – 264 V AC, all common applications are covered. Storage requirements are thus reduced considerably as well.



LED – illuminating the future for control circuit devices

RMQ Titan Description



RMQ Titan sheds light on all processes

Whether in the control panel or, for example, in suspension panels, signals are securely transmitted with RMQ Titan. The new illuminated emergency stop button has an integrated indicator light. This safety component is thus highly visible even in darkened rooms, eliminating the need for a separate indicator light. Important alarms can now be further reinforced by a warning tone: the buzzer in the RMQ Titan program ensures that a danger will be more quickly recognized by sounding a piercing, continuous tone.

Special buttons for special demands

Especially dangerous production processes require not only the full concentration of service personnel but also special operating elements. Control devices – mushroom actuators with large button surfaces, for example – provide more security because their shape contrasts with other operating elements and they can also be easily pressed when wearing gloves. Key-operated actuators ensure that certain functions can only be controlled by specialist personnel. These actuators are especially space-saving with RMQ Titan whereby assembled height has been reduced by 50 %.

The double push-button actuators combine up to three functions in one mounting location. An integrated indicator light, for example, is thus optional. For especially rugged industrial applications, individual actuators can be protected from dust, flour, cement, etc. with diaphragms. The special form of actuator diaphragm and the high IP 67 degree of protection also permits application in food industries, in which machines must be frequently cleaned.

Flexibility for individual mounting

RMQ Titan fits into the 22.3 mm standard bore. Up to six contact elements can be snapped on in two levels behind the front. The actuators have become more flush and mounting depth optimized overall. Therefore, a simple switch can now fit into standard commercial wall outlets.

As customary, three mounting styles are possible: flush, surface, and rear. On surface mounting enclosures, the fixing adapter is already integrated into the bottom of the enclosure. Telescopic clips are provided for use in control panels to adjust varying panel depths.

Made-to-measure symbols and text

All button plates, indicator lights and additional button plates from the RMQ Titan Control Circuit Devices program can be supplied with any text and symbols. The information is etched by laser and will remain permanently – in contrast to printed elements. Additional button plates can also be engraved, in addition to laser printing.

Stay-put or spring-return – simple to convert

All RMQ Titan stay-put push-button actuators can be set to stay-put or spring-return functions from the side. This pays off, for example, when a jog function is needed during set-up but the actuator is to later remain stay-put. A metal ring is visible from the side when the button is pressed halfway - a simple push converts the function.

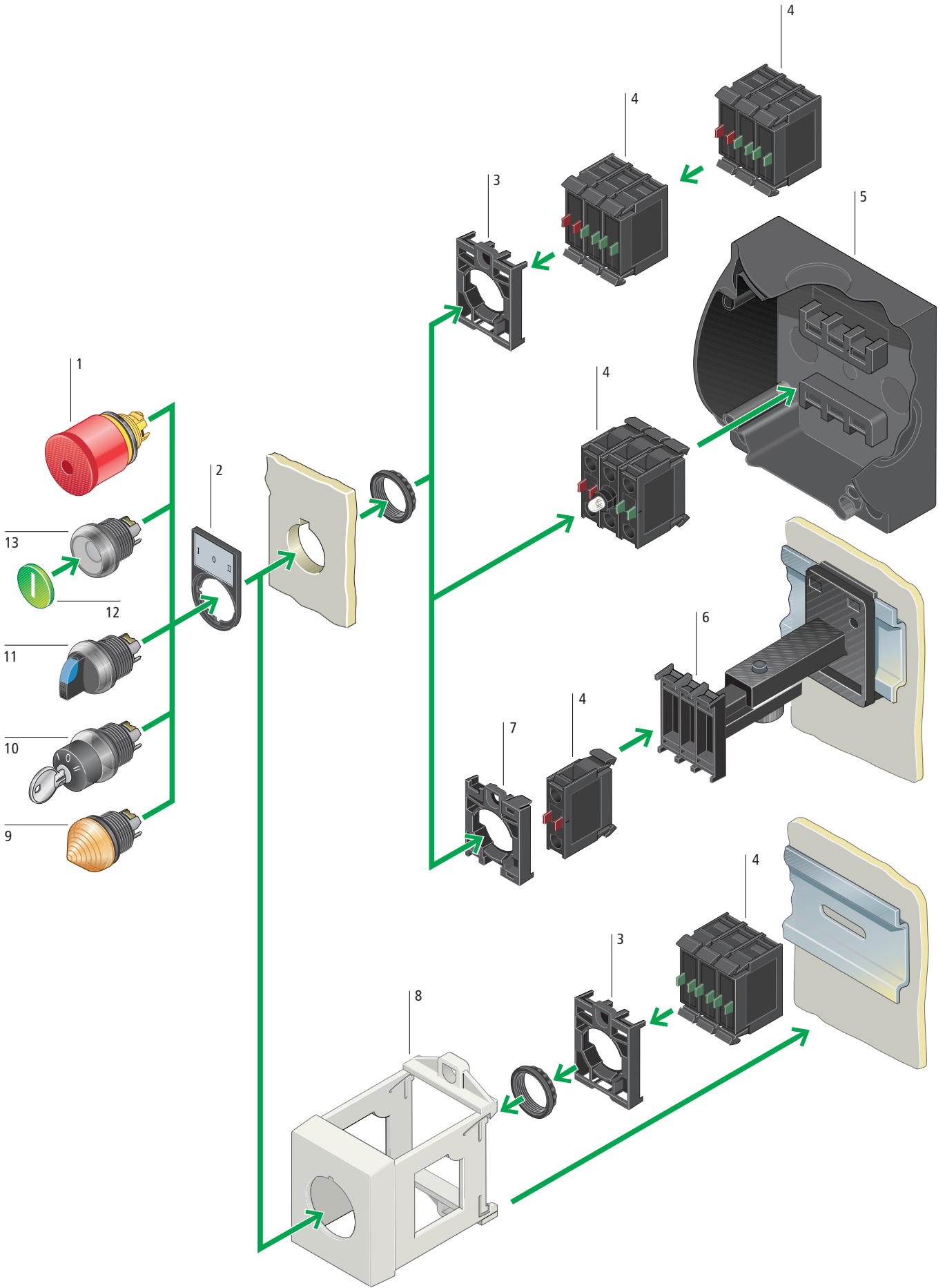

And what applies to the push-button actuators also applies to all selector switches. The switching behaviour (spring-return/stay-put) and the withdrawal option for the key can be modified at any time and adapted to the application at hand. Ordering and storage are thus considerably reduced.

RMQ Titan System Overview



RMQ Titan

System Overview

















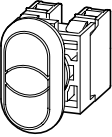

Emergency-Stop actuators	1	Enclosures	5	Selector switch actuators	11
Tamper-proof to ISO 13 850/EN 418		IP 66 surface mounting enclosure up to 6 locations		Two or three positions	
Can be secured by means of sealable shroud		IP 54 flush mounting panel up to 6 locations		With rotary head, thumb-grip handle	
Additional plates with and without text		IP 40 shrouds for flush mounting plates		Programmable spring-return/stay-put function	
  		→ Page 27		Illuminated selector switch actuators with transparent thumb-grip	
BG classification applied for				Colours: white, green, red, yellow, blue	
→ Page 9		Telescopic clips	6	→ Page 15	
		For adjusting the depth of rear mounting devices in CI enclosures, CI-K4 enclosures and panels		Button plates/button lenses	12
		→ Page 29		Laser-engraved text for push-button actuators and mushroom actuators	
Label mounts	2			Button lenses for illuminated push-button actuators and indicator lights, flush	
For insert plates		Centring adapter	7	With standard text and symbols or individual text	
Colour: black		For centring of actuators and indicators when using telescopic clips		→ Page 26	
Insert plates aluminium-coloured, with and without text, can be engraved		→ Page 29		Push-button actuators	13
→ Page 25				Spring-return and stay-put	
		IVS top-hat rail adapter	8	Flush and extended	
Fixing adapter	3	For direct mounting to top-hat rail to EN 50 022		With and without guard ring	
For front fixing		→ Page 29		Mushroom actuators	
For contact and LED elements				Double actuators	
→ Page 22		Indicator lights	9	Colour: white, green, red, yellow, blue, black	
		Flush and conical versions		Illuminated push-button actuators	
Contact elements	4	Colours: white, green, red, yellow, blue		Colour: white, green, red, yellow, blue	
Break and make		→ Page 18		→ Page 11	
Universal contacts suitable for use with electronic devices		Key-operated actuators	10		
Positive opening safety function to IEC/EN 60 947-5 -1		Two or three positions			
→ Page 22		Programmable spring-return/stay-put function and key withdrawal			
		Suitable for master key systems			
LED elements	4	→ Page 16			
Voltage range:					
18 – 30 V DC					
85 – 264 V AC					
→ Page 23					

Product features

- Snap-fitting modular system
- Front ring in titanium or black
- Mounting diameter: 22.3 mm
- Minimum grid spacing 30 × 40 mm
- IP 66 degree of protection
- Up to 6 contacts per location
- Switching of different potentials
- Approved throughout the world

RMQ Titan

Complete Units for Front Mounting, Front IP 66

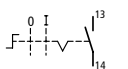
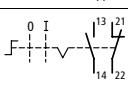
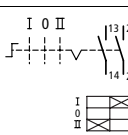
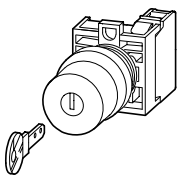
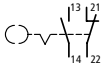















				Front ring titanium		
Button plate	Contacts ¹⁾ M = Make, B = Break, ⊕ = Positive opening safety function to IEC/EN 60 947-5-1			Type Article no.	Price See Price List	Std. pack
Push-button actuators						
Flush 		1 M –		M22-D-G-X1/K10 216512		5 off
		– 1 B ⊕		M22-D-R-X0/K01 216510		
		1 M 1 B ⊕		M22-D-G-X1/K11 216513		
		1 M 1 B ⊕		M22-D-R-X0/K11 216511		
Double push-buttons						
Cover plate, black 		1 M –		M22-DD-GR-X1/X0/K11 216506		5 off
		– 1 B ⊕				
With LED element Lens assembly, white 85 – 264 V AC		1 M –		M22-DDL-GR-X1/X0/K11/230-W 216509		5 off
		– 1 B ⊕				
Selector switch actuator, black thumb-grip handle						
Stay-put/spring-return function can be changed using M22-XC-. coding adapters						
Two positions, stay-put 		1 M –		M22-WRK/K10 216518		5 off
		1 M 1 B ⊕		M22-WRK/K11 216519		
		2 M –		M22-WRK3/K20 216520		
Key-operated actuator, with 1 key						
Stay-put/spring-return function and key withdrawal can be changed with M22-XC-. coding adapter						
Two positions, stay-put MS 1 lock mechanism 		1 M 1 B ⊕		M22-WRS/K11 216517		5 off

Notes

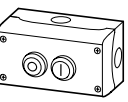
¹⁾ Special versions can be supplied as complete units for orders of 50 or more.
Switch positions 0, I, II correspond to the position of the actuating element viewed from the front.

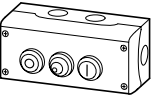
RMQ Titan

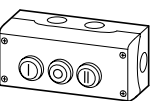

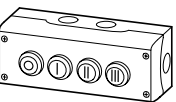
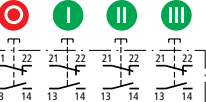















Complete Units for Surface Mounting, IP 66

						Front ring titanium	
	Number of locations	Contacts ¹⁾ M = Make, B = Break, ⊕ = Positive opening safety function to IEC/EN 60 947-5-1		Colour ²⁾ Enclosure top	Type Article no.	Price See Price List	Std. pack
Push-button actuators							
Flush 	1	1 M 1 B ⊕		Grey	M22-D-G-X1/KC11/I 216522		2 off
	1	1 M 1 B ⊕		Grey	M22-D-G-X0/KC11/I 216521		2 off
Key-release mushroom buttons²⁾							
With 1 key MS 1 lock mechanism 	1	1 M 1 B ⊕		Yellow	M22-PVS/KC11/IY 216523		2 off
Key-operated buttons With 1 key, Two positions, stay-put MS 1 lock mechanism 	1	1 M 1 B ⊕		Grey	M22-WRS/KC11/I 216526		2 off
Enclosures							
With contact elements Without actuator 	1	1 M 1 B ⊕		Grey	M22-I1-M1 216527		2 off
	1	1 M 1 B ⊕		Yellow	M22-I1Y-M1 216528		2 off
Two-way push-button station 	2	2 M 2 B ⊕		Grey	M22-I2-M1 216529		2 off
Two-way push-button station With indicator light LED element 85 – 264 V AC 	2	2 M 2 B ⊕		Grey	M22-I3-M2 216533		1 off
Three-way push-button station 	3	3 M 3 B ⊕		Grey	M22-I3-M1 216532		1 off
Four-way push-button station 	4	4 M 4 B ⊕		Grey	M22-I4-M1 216534		1 off

Notes

















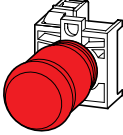

- Special versions can be supplied as complete units for orders of 50 or more.
Switch positions 0, I, II correspond to the position of the actuating element viewed from the front.
- grey = RAL 7035
yellow = RAL 1004

RMQ Titan Double Actuators

	Button plate version	Front ring titanium	Front ring black	Price See Price List	Std. pack		
		Type Article no.	Type Article no.				
Double actuators, IP 65							
Without indicator light, Cover plate, black 		M22-DD-GR-X1/X0 216685	M22S-DD-GR-X1/X0 216686		5 off		
		M22-DD-WS-X1/X0 216691	M22S-DD-WS-X1/X0 216692				
		M22-DD-GR-GB1/GB0 216687	M22S-DD-GR-GB1/GB0 216688				
		M22-DD-WS-GB1/GB0 216693	M22S-DD-WS-GB1/GB0 216694				
		M22-DD-S-X7/X7 216695	M22S-DD-S-X7/X7 216696				
		M22-DD-S-X4/X5 218143	M22S-DD-S-X4/X5 218144				
		M22-DD-GR 216683	M22S-DD-GR 216684				
		M22-DD-WS 216689	M22S-DD-WS 216690				
	With indicator light, Lens assembly, white 		M22-DDL-GR-X1/X0 216700	M22S-DDL-GR-X1/X0 216701			5 off
			M22-DDL-WS-X1/X0 216706	M22S-DDL-WS-X1/X0 216707			
			M22-DDL-GR-GB1/GB0 216702	M22S-DDL-GR-GB1/GB0 216703			
			M22-DDL-WS-GB1/GB0 216708	M22S-DDL-WS-GB1/GB0 216709			
			M22-DDL-S-X7/X7 216710	M22S-DDL-S-X7/X7 216711			
			M22-DDL-S-X4/X5 218145	M22S-DDL-S-X4/X5 218146			
		M22-DDL-GR 216698	M22S-DDL-GR 216699				
		M22-DDL-WS 216704	M22S-DDL-WS 216705				

RMQ Titan

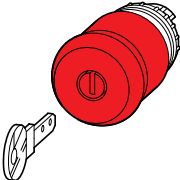
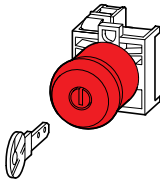
Emergency-Stop Actuators







		Contacts M = Make, B = Break, ⊕ = Positive opening safety function to IEC/EN 60 947-5-1	Colour: Enclosure top, yellow Plunger ¹⁾	Type Article no.	Price See Price List	Std. pack
Complete units for surface mounting, IP 66						
Emergency-Stop actuator, tamper-proof to ISO 13 850/EN 418 Pull to release Max. configuration: 3 × M22-(C)K...						
   	1 M 1 B		●	M22/PV/KC11/I 216525		2 off
	- 2 B		●	M22/PV/KC02/I 216524		2 off
Complete units for front mounting, IP 66						
Emergency-Stop actuator, tamper-proof to ISO 13 850/EN 418 Pull to release Max. configuration: 4 × M22-(C)K...						
  	- 1 B ⊕		●	M22-PV/K01 216515		5 off
	1 M 1 B ⊕		●	M22-PV/K11 216516		5 off
Emergency-stop actuator Non-illuminated						
  	- -	-	●	M22-PV 216876		10 off
	- -	-	●	M22-PV-GVP 216877		50 off
Emergency-stop actuator Illuminated						
  	- -	-	●	M22-PVL 216878		5 off
Emergency-Stop key-operated actuators IP 66						
With 1 key						
	Individual lock mechanism MS 1	- -	-	●	M22-PVS 216879	5 off
	Individual lock mechanism MS 2 – 20	- -	-	●	M22-PVS-MS* 216880	1 off
Emergency-stop key-operated mushroom actuator to ISO 13 850/EN 418						
With 1 key, Individual lock mechanism MS 1						
	- 1 B ⊕		●	M22-PVS/K01 216514		5 off

Notes

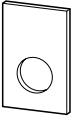
¹⁾ Red = RAL 3000

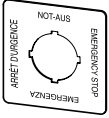
RMQ Titan























Emergency-Stop Labels, Sealable Shroud

	Text	Country code Explanation	Colour	Type Article no.	Price See Price List	Std. pack
Emergency-stop labels, IP 66						
Text black, 33 × 50 mm						
	Emergency-stop	D		M22-XZK-D99 216471		10 off
	Emergency Stop	GB		M22-XZK-GB99 216472		
	Arrêt d'urgence	F		M22-XZK-F99 216473		
	EMERGENZA	I		M22-XZK-I99 216474		
	NOODSTOP	NL		M22-XZK-NL99 216475		
	NÖDSTOPP	S		M22-XZK-S99 216476		
	HÄTÄ-SEIS	SF		M22-XZK-SF99 216477		
	NØDSTOP	DK		M22-XZK-DK99 216478		
	Blank	–		M22-XZK 216470		
	With individual text ¹⁾			M22-XZK-* 216479		10 off
50 × 50 mm						
	Four-language	D, GB, F, I		M22-XYK1 216484		10 off
Ø = 90 mm						
	Blank			M22-XAK 216464		10 off
	Four-language	D, GB, F, I		M22-XAK1 216465		
	Four-language	D, GB, E, POR		M22-XAK2 216466		
	Four-language	D, GB, NL, F		M22-XAK3 216467		
	Four-language	GB, S, SF, DK		M22-XAK4 216468		
	With individual text			M22-XAK-* 216469		
Ø = 60 mm						
	Four-language	D, GB, F, I		M22-XBK1 216483		
Sealable shroud²⁾						
				M22-PL-PV 216397		2 off























Notes

- Height of letters: 5 mm
Number of lines: Maximum 2
characters per line: Maximum 7
- Transparent with collapse point, can be reused after an emergency stop.
For use with M22-PV, M22-PVL, M22-PVS
Adjacent holes should be sealed with M22(S)-B blanking plugs at 30 × 50 mm intervals.

























RMQ Titan Push-Button Actuators

		Front ring titanium	Front ring black		
	Button plate	Type Article no.	Type Article no.	Price See Price List	Std. pack
Push-button actuators, IP 66					
Flush, spring-return 		M22-D-S 216590	M22S-D-S 216591		10 off
		M22-D-W 216592	M22S-D-W 216593		
		M22-D-R 216594	M22S-D-R 216595		
		M22-D-G 216596	M22S-D-G 216597		
		M22-D-Y 216598	M22S-D-Y 216599		
		M22-D-B 216600	M22S-D-B 216601		
	Without	M22-D-X 216602	M22S-D-X 216604		
	Without	M22-D-X-GVP 216603	–		50 off
		M22-D-R-X0 216605	M22S-D-R-X0 216606		10 off
		M22-D-G-X1 216607	M22S-D-G-X1 216608		
		M22-D-S-X0 216609	M22S-D-S-X0 216610		
		M22-D-W-X1 216611	M22S-D-W-X1 216612		
	Flush, stay-put  Programmable stay-put/spring-return function		M22-DR-S 216613	M22S-DR-S 216614	
		M22-DR-W 216615	M22S-DR-W 216616		
		M22-DR-R 216617	M22S-DR-R 216618		
		M22-DR-G 216619	M22S-DR-G 216620		
		M22-DR-Y 216621	M22S-DR-Y 216622		
		M22-DR-B 216623	M22S-DR-B 216624		
Without		M22-DR-X 216625	M22S-DR-X 216627		
Without		M22-DR-X-GVP 216626	–		50 off
		M22-DR-R-X0 216628	M22S-DR-R-X0 216629		5 off
		M22-DR-G-X1 216630	M22S-DR-G-X1 216631		
		M22-DR-S-X0 216632	M22S-DR-S-X0 216633		
		M22-DR-W-X1 216634	M22S-DR-W-X1 216635		

























RMQ Titan Push-Button Actuators

		Front ring titanium	Front ring black		
	Button plate	Type Article no.	Type Article no.	Price See Price List	Std. pack
Push-button actuators, IP 66					
Extended, spring-return 		M22-DH-S 216636	M22S-DH-S 216637		5 off
		M22-DH-W 216638	M22S-DH-W 216639		
		M22-DH-R 216640	M22S-DH-R 216642		
		M22-DH-G 216643	M22S-DH-G 216644		
		M22-DH-Y 216646	M22S-DH-Y 216647		
		M22-DH-B 216649	M22S-DH-B 216650		
		M22-DH-R-X0 216655	M22S-DH-R-X0 216656		
		M22-DH-G-X1 216657	M22S-DH-G-X1 216658		
		M22-DH-S-X0 216659	M22S-DH-S-X0 216660		
		M22-DH-W-X1 216661	M22S-DH-W-X1 216662		
Extended, stay-put 		M22-DRH-S 216663	M22S-DRH-S 216664		5 off
		M22-DRH-W 216665	M22S-DRH-W 216666		
		M22-DRH-R 216667	M22S-DRH-R 216668		
		M22-DRH-G 216669	M22S-DRH-G 216670		
		M22-DRH-Y 216671	M22S-DRH-Y 216672		
		M22-DRH-B 216673	M22S-DRH-B 216674		
		M22-DRH-R-X0 216675	M22S-DRH-R-X0 216676		
		M22-DRH-G-X1 216677	M22S-DRH-G-X1 216678		
		M22-DRH-S-X0 216679	M22S-DRH-S-X0 216680		
		M22-DRH-W-X1 216681	M22S-DRH-W-X1 216682		
With guard ring, spring-return 	Without	M22-DG-X 220921	-		













RMQ Titan Push-Button Actuators

	Button plate	Colour Mushroom	Front ring titanium	Front ring black	Price See Price List	Std. pack
			Type Article no.	Type Article no.		
Mushroom actuators, IP 66						
Spring-return			M22-DP-S 216712	M22S-DP-S 216713		5 off
			M22-DP-R 216714	M22S-DP-R 216715		
			M22-DP-G 216716	M22S-DP-G 216717		
			M22-DP-Y 216718	M22S-DP-Y 216719		
			M22-DP-R-X0 216720	M22S-DP-R-X0 216721		5 off
			M22-DP-G-X1 216722	M22S-DP-G-X1 216723		
			M22-DP-S-X0 216724	M22S-DP-S-X0 216725		
			M22-DP-W-X1 216726	M22S-DP-W-X1 216727		5 off
	Without		M22-DP-S-X 216728	M22S-DP-S-X 216730		
	Without		M22-DP-R-X 216731	M22S-DP-R-X 216733		
	Without		M22-DP-G-X 216734	M22S-DP-G-X 216736		
	Without		M22-DP-Y-X 216737	M22S-DP-Y-X 216739		
	Without		M22-DP-S-X-GVP 216729	–		25 off
	Without		M22-DP-R-X-GVP 216732	–		
	Without		M22-DP-G-X-GVP 216735	–		
	Without		M22-DP-Y-X-GVP 216738	–		

RMQ Titan Push-Button Actuators

			Front ring titanium	Front ring black	
	Button plate	Colour Mushroom	Type Article no.	Type Article no.	Price See Price List
Mushroom actuators, IP 66					
Stay-put			M22-DRP-S 216743	M22S-DRP-S 216744	5 off
			M22-DRP-R 216745	M22S-DRP-R 216746	
Programmable stay-put/spring-return function			M22-DRP-G 216747	M22S-DRP-G 216748	5 off
			M22-DRP-Y 216749	M22S-DRP-Y 216750	
			M22-DRP-R-X0 216751	M22S-DRP-R-X0 216752	5 off
			M22-DRP-G-X1 216753	M22S-DRP-G-X1 216754	
			M22-DRP-S-X0 216755	M22S-DRP-S-X0 216756	5 off
			M22-DRP-W-X1 216757	M22S-DRP-W-X1 216758	
Without			M22-DRP-S-X 216759	M22S-DRP-S-X 216761	5 off
Without			M22-DRP-R-X 216762	M22S-DRP-R-X 216764	
Without			M22-DRP-G-X 216765	M22S-DRP-G-X 216767	5 off
Without			M22-DRP-Y-X 216768	M22S-DRP-Y-X 216770	
Without			M22-DRP-S-X-GVP 216760	–	25 off
Without			M22-DRP-R-X-GVP 216763	–	
Without			M22-DRP-G-X-GVP 216766	–	
Without			M22-DRP-Y-X-GVP 216769	–	

RMQ Titan Selector Switches

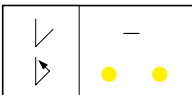
			Front ring titanium		Front ring black		
Function			Type	Type	Price		
↳ = stay-put ▷ = spring-return			Article no.	Article no.	See Price		Std.
Selector switch actuators, Two positions IP 66							
Rotary head 	↳	40°		M22-W 216853	M22S-W 216854		5 off
	↳	60°		M22-WR 216855	M22S-WR 216856		
	↳	60°		M22-WR-X92 216857	M22S-WR-X92 216858		
	↳	60°	HAND AUTO 	M22-WR-X91 216859	M22S-WR-X91 216860		
Thumb-grip handle 	↳	40°	—	M22-WK 216865	M22S-WK 216866		
	↳	60°	—	M22-WRK 216867	M22S-WRK 216869		10 off
	↳	60°	—	M22-WRK-GVP 216868	—		50 off
Thumb-grip handle, V position 	∨	60°	—	M22-WKV 216874	M22S-WKV 216875		5 off
Selector switch actuators, Three positions IP 66							
Rotary head 	40°	↔ 40°		M22-W3 216861	M22S-W3 216862		5 off
	60°	↔ 60°		M22-WR3 216863	M22S-WR3 216864		
Thumb-grip handle 	40°	↔ 40°	—	M22-WK3 216870	M22S-WK3 216871		
	60°	↔ 60°	—	M22-WRK3 216872	M22S-WRK3 216873		
	1)		—	M22-WRK3-* 217436	M22S-WRK3-* 217437		
Coding adapters, for all selector switch actuators							
For converting between stay-put and spring-return functions							
				M22-XC-Y 216407	M22S-XC-Y 216407		10 off





Notes

1) Example: M22-WRK3-*

└ 1 = 60° ↔ 40°
 └ 2 = 40° ↔ 60°

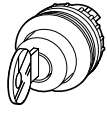
RMQ Titan

Key-Operated Actuators, Individual Lock Mechanisms

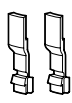
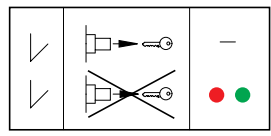
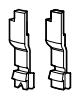
			Front ring titanium	Front ring black	
	Function ↳ = stay-put ↳ = spring-return	Key can be withdrawn in position	Type Article no.	Type Article no.	Price See Price List
Std. pack					
Key-operated actuators, IP 66					
Two positions Individual lock mechanisms not suitable for master key systems, with 1 key Stay-put/spring-return function and withdrawable key facility can be changed with M22-XC coding adapters					
	↳ 40°	0	M22-WS 216881	M22S-WS 216882	1 off
	↳ 60°	0 I	M22-WRS 216887	M22S-WRS 216889	5 off
	↳ 60°	0 I	M22-WRS-GVP 216888	—	25 off
Lock mechanism MS 2 – 20 ¹⁾ Include the lock mechanism number in the type designation	↳ 40°	0	M22-WS-MS* 216883	M22S-WS-MS* 216884	1 off
	↳ 60°	0 I	M22-WRS-MS* 216890	M22S-WRS-MS* 216891	1 off
Lock mechanism MS 1 – 20	↳ 50°	0	M22-WRS-MS*-A1 217440	M22S-WRS-MS*-A1 217441	5 off
 Key for MS 1 individual lock mechanism Key for MS 2 – 20 individual lock mechanisms			M22-ES-MS1 216416	M22-ES-MS1 216416	5 off
			M22-ES-MS* 216417	M22-ES-MS* 216417	1 off
Three positions Individual lock mechanisms not suitable for master key systems, with 1 key Stay-put/spring-return function and withdrawable key facility can be changed with M22-XC coding adapters					
	40° ⇄ 40°	0	M22-WS3 216894	M22S-WS3 216895	1 off
	60° ⇄ 60°	I 0 II	M22-WRS3 216900	M22S-WRS3 216901	5 off
	60° ⇄ 60°	I 0 II	M22-WRS3-GVP 216902	—	25 off
	2)	I 0	M22-WRS3-MS*-A* 217442	M22S-WRS3-MS*-A* 217443	5 off
MS 2 – 20 lock mechanism Include the lock mechanism number in the type designation	40° ⇄ 40°	0	M22-WS3-MS* 216896	M22S-WS3-MS* 216897	1 off
	60° ⇄ 60°	I 0 II	M22-WRS3-MS* 216903	M22S-WRS3-MS* 216904	
 Key for MS 1 individual lock mechanism Key for MS 2 – 20 individual lock mechanisms			M22-ES-MS1 216416	M22-ES-MS1 216416	
			M22-ES-MS* 216417	M22-ES-MS* 216417	
Set of coding adapters					
For converting between the stay-put/spring-return function and withdrawable key facility					
			M22-XC-R 216406	M22-XC-R 216406	10 off
			M22-XC-Y 216407	M22-XC-Y 216407	10 off

Notes



- 1) MS 2 – 20: 4 weeks delivery time
- 2) Example: M22(S)-WRS3-MS*-A*

	Function	can be withdrawn in switching position
A1	⇄	0
A2	↳	I 0
A3	⇄	0 II
A4	↳	I 0
A5	↳	0
A6	⇄	0 II
A7	⇄	0

↳ 1 – 20
(Individual lock mechanism no.)

RMQ Titan

Key-Operated Actuators for Master Key Systems

			Front ring titanium	Front ring black	
Function ↳ = stay-put ↳ = spring-return	Key can be withdrawn in position	Type Article no.	Type Article no.	Price See Price List	Std. pack
Two positions, cannot be fitted with coding adapters with 2 keys ²⁾ 	↳ 40°	0	M22-WS-SA(*)-* 216885	M22S-WS-SA(*)-* 216886	1 off
	↳ 60°	0	M22-WRS-SA(*)-* 216892	M22S-WRS-SA(*)-* 216893	
Three positions, cannot be fitted with coding adapters with 2 keys ²⁾ 	↳ 40°	0	M22-WS3-SA(*)-* 216898	M22S-WS3-SA(*)-* 216899	
	↳ 60°	0	M22-WRS3-SA(*)-* 216905	M22S-WRS3-SA(*)-* 216906	
Standard key 			M22-ES-SA(*)-* 217444	M22-ES-SA(*)-* 217444	

Notes

- 1) Master key systems: 6 – 8 weeks delivery time
 - 2) Example: M22-WS-SA(*)-* — Levels e. g. 2.3.1 — Standard key
 - ↳ Group master key
 - ↳ Master key
 - 0 = General master key
- for new orders = new
For repeat orders = Master key system no. acc. security certificate

Master key systems

- 8000 different lock mechanisms
- Security certificate prevents unauthorized purchase of keys: enter with repeat orders
- Special key profile provided only by the manufacturer
- Moeller master key systems cannot be combined with domestic locks







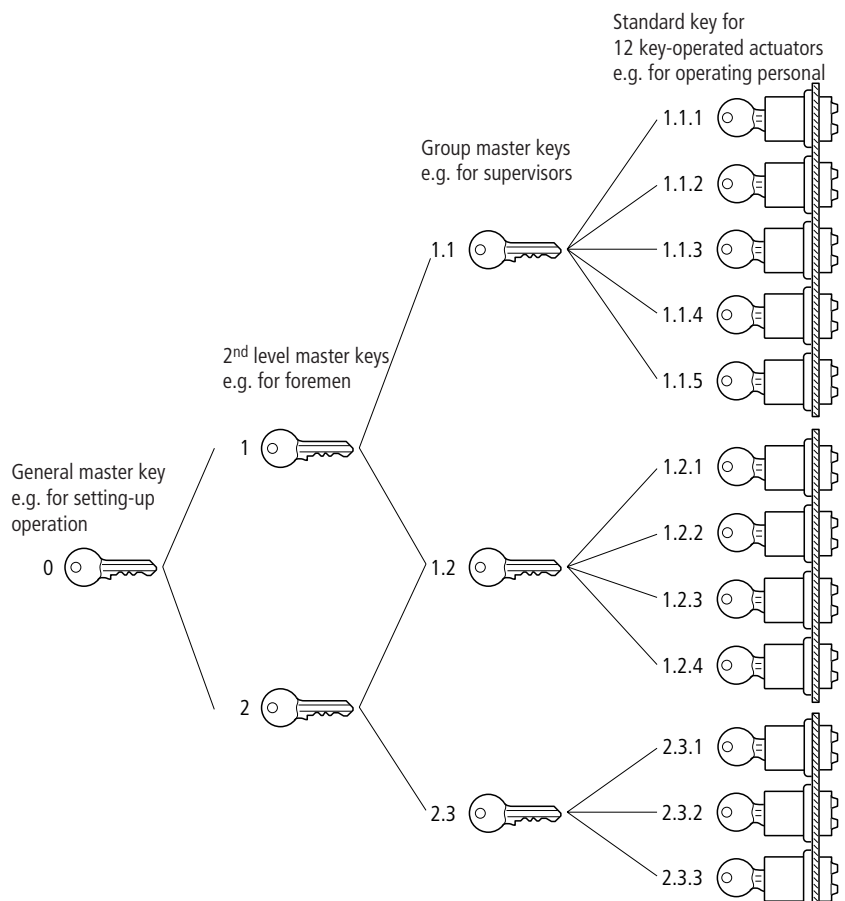





Lock plan

Example of a GHS general master key system:



















The system consists of 12 individual locks and the associated different keys. At the first level the locks are combined to form 3 groups. For each of the 3 groups there is one master key that can open all locks in its groups. In the 2nd level, the 3 groups are combined to form 2 main groups, the 2nd level master keys can open all the locks from several groups. The general master key covers the 2 main groups can thus open all 12 locks of the master key system.























RMQ Titan Indicator Lights

		Front ring titanium		
	Actuator lens style	Type Article no.	Price See Price List	Std. pack
Indicator light IP 66				
Flush				
		M22-L-W 216771		10 off
		M22-L-R 216772		
		M22-L-G 216773		
		M22-L-Y 216774		
		M22-L-B 216775		
	Without lens	M22-L-X 216776		
	Without lens	M22-L-X-GVP 216777		50 off
Extended				
		M22-LH-W 216778		10 off
		M22-LH-R 216779		
		M22-LH-G 216780		
		M22-LH-Y 216781		
		M22-LH-B 216782		







RMQ Titan Illuminated Push-Buttons

		Front ring titanium	Front ring black		
Actuator lens style		Type Article no.	Type Article no.	Price See Price List	
				Std. pack	
Illuminated push-button actuators IP 66					
Flush, spring-return 		M22-DL-W 216922	M22S-DL-W 216924	10 off	
		M22-DL-R 216925	M22S-DL-R 216926		
		M22-DL-G 216927	M22S-DL-G 216928		
		M22-DL-Y 216929	M22S-DL-Y 216930		
		M22-DL-B 216931	M22S-DL-B 216932		
	Without	M22-DL-X 216933	M22S-DL-X 216935		
	Without	M22-DL-X-GVP 216934	–		50 off
		M22-DL-R-X0 216936	M22S-DL-R-X0 216937		10 off
		M22-DL-G-X1 216938	M22S-DL-G-X1 216939		5 off
		M22-DL-W-X1 216942	M22S-DL-W-X1 216943		
Flush, stay-put  Programmable stay-put/spring-return function		M22-DRL-W 216944	M22S-DRL-W 216945	5 off	
		M22-DRL-R 216946	M22S-DRL-R 216947		
		M22-DRL-G 216948	M22S-DRL-G 216949		
		M22-DRL-Y 216950	M22S-DRL-Y 216951		
		M22-DRL-B 216952	M22S-DRL-B 216953		
	Without	M22-DRL-X 216954	M22S-DRL-X 216956		
	Without	M22-DRL-X-GVP 216955	–		50 off
		M22-DRL-R-X0 216957	M22-DRL-R-X0 216958		5 off
		M22-DRL-G-X1 216959	M22S-DRL-G-X1 216960		
		M22-DRL-W-X1 216963	M22S-DRL-W-X1 216964		

RMQ Titan Illuminated Push-Buttons

		Front ring titanium	Front ring black	
	Actuator lens style	Type Article no.	Type Article no.	Price See Price List
Illuminated push-button actuators IP 66				
Extended, spring-return 		M22-DLH-W 216965	M22S-DLH-W 216966	5 off
		M22-DLH-R 216967	M22S-DLH-R 216968	
		M22-DLH-G 216969	M22S-DLH-G 216970	
		M22-DLH-Y 216971	M22S-DLH-Y 216972	
		M22-DLH-B 216973	M22S-DLH-B 216974	
		M22-DLH-R-X0 216975	M22S-DLH-R-X0 216976	
		M22-DLH-G-X1 216977	M22S-DLH-G-X1 216978	
		M22-DLH-W-X0 216979	M22S-DLH-W-X0 216980	
		M22-DLH-W-X1 216981	M22S-DLH-W-X1 216982	
Extended, stay-put 		M22-DRLH-W 216788	M22S-DRLH-W 216791	5 off
		M22-DRLH-R 216789	M22S-DRLH-R 216792	
		M22-DRLH-G 216796	M22S-DRLH-G 216798	
		M22-DRLH-Y 216799	M22S-DRLH-Y 216801	
		M22-DRLH-B 216802	M22S-DRLH-B 216803	
		M22-DRLH-R-X0 216804	M22S-DRLH-R-X0 216808	
		M22-DRLH-G-X1 216805	M22S-DRLH-G-X1 216809	
		M22-DRLH-W-X0 216806	M22S-DRLH-W-X0 216810	
		M22-DRLH-W-X1 216807	M22S-DRLH-W-X1 216811	
Programmable stay-put/spring-return function				

RMQ Titan Illuminated Selector Switch Actuators

				Front ring titanium	Front ring black		
		Function	Thumb-grip colour	Type	Type	Price	
		↳ = stay-put		Article no.	Article no.	See Price List	
		↳ = spring-return				Std. pack	
Illuminated selector switch actuators, thumb-grip handle IP 66							
Two positions							
 Spring-return	↳	40°	○	M22-WLK-W 216812	M22S-WLK-W 216813	5 off	
	↳	40°	●	M22-WLK-R 216814	M22S-WLK-R 216815		
	↳	40°	●	M22-WLK-G 216816	M22S-WLK-G 216817		
	↳	40°	●	M22-WLK-Y 216818	M22S-WLK-Y 216819		
	↳	40°	●	M22-WLK-B 216820	M22S-WLK-B 216821		
 Stay-put	↳	60°	○	M22-WRLK-W 216823	M22S-WRLK-W 216824		
	↳	60°	●	M22-WRLK-R 216825	M22S-WRLK-R 216826		
	↳	60°	●	M22-WRLK-G 216827	M22S-WRLK-G 216828		
	↳	60°	●	M22-WRLK-Y 216829	M22S-WRLK-Y 216830		
	↳	60°	●	M22-WRLK-B 216831	M22S-WRLK-B 216832		
Three positions							
 Spring-return	40°	↔	40°	○	M22-WLK3-W 216833	M22S-WLK3-W 216834	5 off
	40°	↔	40°	●	M22-WLK3-R 216835	M22S-WLK3-R 216836	
	40°	↔	40°	●	M22-WLK3-G 216837	M22S-WLK3-G 216838	
	40°	↔	40°	●	M22-WLK3-Y 216839	M22S-WLK3-Y 216840	
	40°	↔	40°	●	M22-WLK3-B 216841	M22S-WLK3-B 216842	
 Stay-put	60°	↔	60°	○	M22-WRLK3-W 216843	M22S-WRLK3-W 216844	
	60°	↔	60°	●	M22-WRLK3-R 216845	M22S-WRLK3-R 216846	
	60°	↔	60°	●	M22-WRLK3-G 216847	M22S-WRLK3-G 216848	
	60°	↔	60°	●	M22-WRLK3-Y 216849	M22S-WRLK3-Y 216850	
	60°	↔	60°	●	M22-WRLK3-B 216851	M22S-WRLK3-B 216852	
Stay-put, spring-return ¹⁾	40°	↔	60°	M22-WRLK3-*/ 217438	M22S-WRLK3-*/ 216439		
Coding adapters, for all selector switch actuators							
For converting between stay-put and spring-return functions							
				M22-XC-Y 216407	M22-XC-Y 216407	10 off	

Notes

¹⁾ Example: M22-WRLK3-*/*

└── 1 = ↕, 2 = ↔
Colour

RMQ Titan

Fixing Adapters, Contact Elements

Contacts¹⁾
 M = Make, B = Break, ⊕ = Positive
 opening safety function to
 IEC/EN 60 947-5-1

Configuration²⁾

Type	Price	Std. pack
Article no.	See Price List	

Fixing adapter (front fixing)

for M22-K contact elements.
 Sequence numbers on fixing adapter

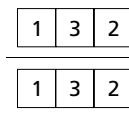
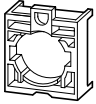

M22-A 216374		50 off
M22-A-GVP 216375		500 off

Contact elements with screw terminals

Front fixing

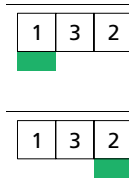
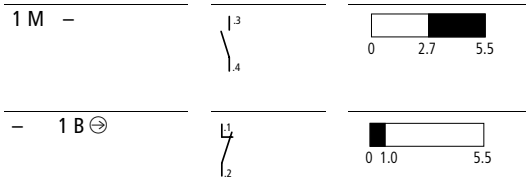
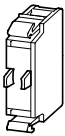

M22-K10 216376		50 off
M22-K10-GVP 216377		500 off
M22-K01 216378		50 off
M22-K01-GVP 216379		500 off

Base fixing

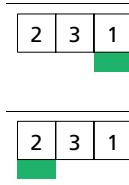
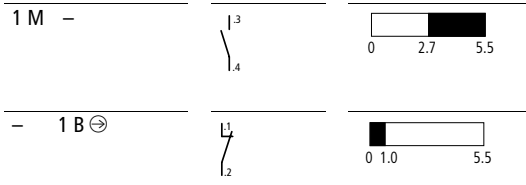
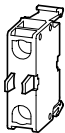

M22-KC10 216380		20 off
M22-KC10-GVP 216381		200 off
M22-KC01 216382		20 off
M22-KC01-GVP 216383		200 off

Contact elements with cage clamp³⁾

Front fixing

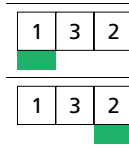
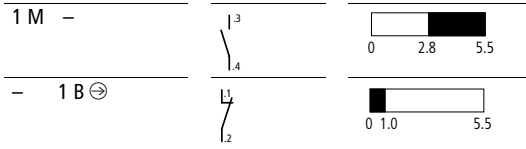
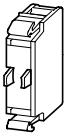

M22-CK10 216384		10 off
M22-CK01 216385		10 off

Base fixing

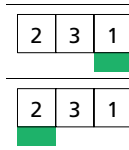
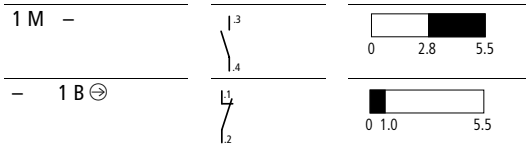
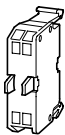

M22-CKC10 216386		10 off
M22-CKC01 216387		10 off

Complete modules

Combination of contact element and fixing adapter,
 Front fixing

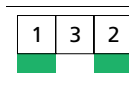
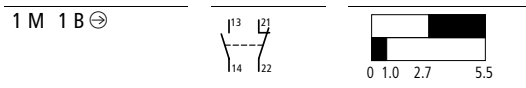
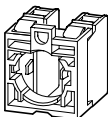

M22-AK11 216505		5 off
--------------------	--	-------

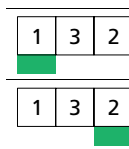
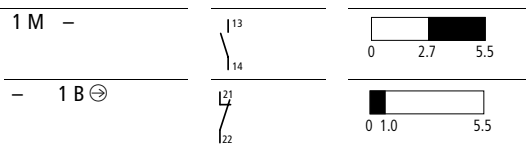
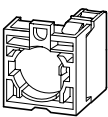









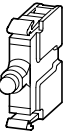
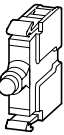

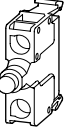



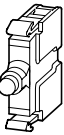

M22-AK10 216504		
M22-AK01 216503		

Notes

- ¹⁾ $\begin{matrix} |_{xy} \\ |_{xy} \end{matrix}$ x = Sequence numbers on fixing adapter
 y = Function numbers on contact element
- ²⁾ Configuration of fixing adapter with sequence numbers to EN 50 013
- ³⁾ Cage Clamp is a registered trademark of Wago Contact Technik GmbH, Minden

RMQ Titan LED Elements

	Rated operational voltage	Rated operational current	Rated lifespan at $T_a = +25^\circ\text{C}$	Colour	Type Article no.	Price See Price List	Std. pack
LED elements with screw terminals							
Front fixing							
	18 – 30 V AC/DC	8 – 15 mA	100,000 h		M22-LED-W 216557		20 off
					M22-LED-R 216558		
					M22-LED-G 216559		
					M22-LED-B 218057		
Base fixing							
	18 – 30 V AC/DC	8 – 15 mA	100,000 h		M22-LEDC-W 216560		20 off
					M22-LEDC-R 216561		
					M22-LEDC-G 216562		
					M22-LEDC-B 218058		
Front fixing							
	85 – 264 V AC	5 – 15 mA	100,000 h		M22-LED230-W 216563		20 off
					M22-LED230-R 216564		
					M22-LED230-G 216565		
					M22-LED230-B 218059		
Base fixing							
	85 – 264 V AC	5 – 15 mA	100,000 h		M22-LEDC230-W 216566		20 off
					M22-LEDC230-R 216567		
					M22-LEDC230-G 216568		
					M22-LEDC230-B 218060		

RMQ Titan LED Elements

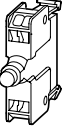
	Rated operational voltage	Rated operational current	Rated lifespan at $T_a = +25\text{ °C}$	Colour	Type Article no.	Price See Price List	Std. pack
LED elements with Cage Clamp¹⁾							
Front fixing							
	18 – 30 V AC/DC	8 – 15 mA	100,000 h	○	M22-CLED-W 216569		10 off
				●	M22-CLED-R 216570		
				●	M22-CLED-G 216571		
				●	M22-CLED-B 218061		
Base fixing							
	18 – 30 V AC/DC	8 – 15 mA	100,000 h	○	M22-CLEDC-W 216572		10 off
				●	M22-CLEDC-R 216573		
				●	M22-CLEDC-G 216574		
				●	M22-CLEDC-B 218062		
Front fixing							
	85 – 264 V AC	5 – 15 mA	100,000 h	○	M22-CLED230-W 216575		10 off
				●	M22-CLED230-R 216576		
				●	M22-CLED230-G 216577		
				●	M22-CLED230-B 218063		
Base fixing							
	85 – 264 V AC	5 – 15 mA	100,000 h	○	M22-CLEDC230-W 216578		10 off
				●	M22-CLEDC230-R 216579		
				●	M22-CLEDC230-G 216580		
				●	M22-CLEDC230-B 218064		

Notes

¹⁾ Cage Clamp is a registered trademark of Wago Contact Technik GmbH, Minden





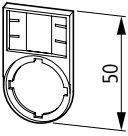
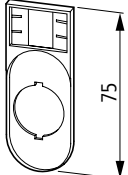















RMQ Titan

Label Mounts Complete, Insert Plates

	Type	Price	Std. pack
	Article no.	See Price List	
Complete Legend Plates			
30 × 50 mm, round, black			
0 I	M22S-ST-X88 216485		10 off
I 0 II	M22S-ST-X89 216486		
0 I	M22S-ST-X93 218147		
STOP	M22S-ST-GB0 216494		
START	M22S-ST-GB1 216495		
Aus	M22S-ST-D5 218299		
OFF	M22S-ST-GB5 218300		
Ein	M22S-ST-D6 216487		
ON	M22S-ST-GB6 216496		
Störung	M22S-ST-D8 216489		
FAULT	M22S-ST-GB8 216498		
Betrieb	M22S-ST-D7 216488		
RUN	M22S-ST-GB7 216497		
HAND AUTO	M22S-ST-D11 216492		
MAN. AUTO	M22S-ST-GB11 216500		
Aus Ein	M22S-ST-D10 216490		
OFF ON	M22S-ST-GB10 216499		
HAND 0 AUTO	M22S-ST-D12 216493		
MAN. 0 AUTO	M22S-ST-GB12 216501		
Insert plates for label mounts, 18 × 27 mm			
	Aluminium blank	M22-XST 216480	100 off
	Aluminium blank	M22-XST-GVP 216481	500 off
	With individual text	M22-XST- 216482	1 off
			Letter height mm
			No. of lines max.
			Characters per line max.
			3
			3
			5
			2
			8
Legend plates, without labels			
Round, black, 30 mm wide			
	M22S-ST-X 216392		100 off
	M22S-ST-X-GVP 216393		500 off
For double actuators	M22S-STDD-X 216394		10 off
			

RMQ Titan

Button Plates, Button Lenses, Lenses

For use with	Colour	Style: Flush Type Article no.	Price See Price List	Style: Extended Type Article no.	Price See Price List	Std. pack
Button plates, Push-button actuator						
M22(S)-D-X M22(S)-DR-X		M22-XD-S 216421		M22-XDH-S 216428		1 off
		M22-XD-W 216422		M22-XDH-W 216429		
		M22-XD-R 216423		M22-XDH-R 216430		
		M22-XD-G 216424		M22-XDH-G 216431		
		M22-XD-Y 216425		M22-XDH-Y 216432		
		M22-XD-B 216426		M22-XDH-B 216433		
	With individual text ¹⁾	M22-XD-*. * 216427		M22-XDH-*. * 216434		
Button lenses, Push-button actuator						
M22(S)-DL-X M22(S)-DRL-X		M22-XDL-W 216441		M22-XDHL-W 216447		10 off
		M22-XDL-R 216442		M22-XDHL-R 216448		
		M22-XDL-G 216443		M22-XDHL-G 216449		
		M22-XDL-Y 216444		M22-XDHL-Y 216450		
		M22-XDL-B 216445		M22-XDHL-B 216451		
	With individual text ¹⁾	M22-XDL-*. * 216446		M22-XDHL-*. * 216452		1 off
Button plates, Mushroom actuator						
M22-L-X M22-LC-X		M22-XDP-S 216435		–		10 off
		M22-XDP-W 216436		–		
		M22-XDP-R 216437		–		
		M22-XDP-G 216438		–		
		M22-XDP-Y 216439		–		
	With individual text ¹⁾	M22-XDP-*. * 216440		–		1 off
Lens, Indicator light						
		M22-XL-W 216453		M22-XLH-W 216459		10 off
		M22-XL-R 216454		M22-XLH-R 216460		
		M22-XL-G 216455		M22-XLH-G 216461		
		M22-XL-Y 216456		M22-XLH-Y 216462		
		M22-XL-B 216457		M22-XLH-B 216463		
	With individual text ¹⁾	M22-XL-*. * 216458		–		1 off

Notes

¹⁾ Example: M22-X...*. *.

Symbol (new or designator from library e. g. GB12)





Colour: e. g. -R, -G, -B, -W, -Y

Height of letters 3 mm: Max. 8 character in 1st line, 10 characters in 2nd line 8 characters in 3rd line

Height of letters 5 mm: Max. 5 characters in one line

RMQ Titan

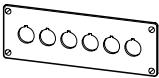

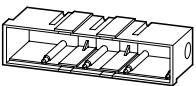
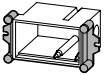







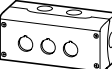

Flush Mounting Plates, Shrouds

	Number of locations		Cable entry knockouts	Type Article no.	Price See Price List	Std. pack
	Number	Colour ¹⁾	Number × M20			
Flush mounting panels IP 54						
Legend plates cannot be used if push-buttons are fitted in vertical column Without apertures, if required						
						
Aluminium with yellow paint finish for Emergency-Stop buttons	1		–	M22-EY1 2165472		5 off
Aluminium, light anodized	1		–	M22-E1 216541		
	2		–	M22-E2 216543		
	3		–	M22-E3 216544		
	4		–	M22-E4 216545		1 off
	5		–	M22-E5 216546		
	6		–	M22-E6 216547		
						
Shrouds, IP 40						
Plastic, light grey						
	1		3	M22-H1 216548		1 off
	2		4	M22-H2 216549		
	3		4	M22-H3 216550		
	4		4	M22-H4 216551		
	5		5	M22-H5 216552		
	6		6	M22-H6 216553		
						
Set of plaster keys						
Consists of two plaster keys as an aid to flush mounting of shrouds in plaster						
	–	–	–	M22-UPE 216554		1 off

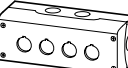
Notes

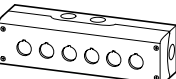
¹⁾ yellow RAL 1004,
light gray RAL 7035

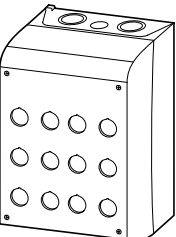







RMQ Titan Surface Mounting Enclosures

	Number of locations	Cable entry knockouts		Colour ¹⁾	Type Article no.	Price See Price List	Std. pack
		Bottom	Sides:				
		Number	Number × M...				
Surface mounting enclosure IP66 <small>totally insulated</small>							
With stainless steel screws							
For Emergency-Stop actuator	1	2 × 16	2 × 25/20 1 × 20		M22-IY1 216536		2 off
	1	2 × 16	2 × 25/20 1 × 20		M22-I1 216535		2 off
	2	2 × 16	1 × 20 2 × 25/20		M22-I2 216537		1 off
	3	2 × 16	2 × 25/20 2 × 20		M22-I3 216538		
	4	2 × 16	2 × 25/20 2 × 20		M22-I4 216539		
	6	2 × 16	2 × 25/20 2 × 20		M22-I6 216540		
Surface mounting enclosure IP 65 <small>totally insulated</small>							
	12	2 × 32/25	4 × 32/25 2 × 20		M22-I12 222688		1 off





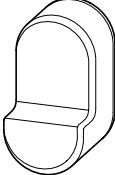
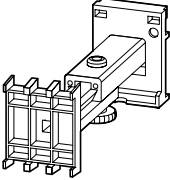
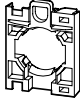







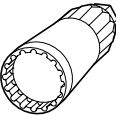
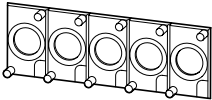

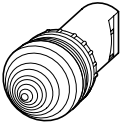

Notes

¹⁾ Colour: yellow RAL 1004, enclosure cover light grey RAL 7035, enclosure base anthracite RAL 9005

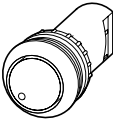
RMQ Titan Accessories

For use with	Colour	Type Article no.	Price See Price List	Std. pack
Blanking plugs, IP 66				
For blanking off reserve locations				
Round design				
		M22S-B 216390		50 off
		M22S-B-GVP 216391		250 off
		M22-B 216388		50 off
		M22-B-GVP 216389		250 off
Actuator diaphragms for IP 67				
Transparent diaphragms for severe environmental conditions and use in the food industry. Do not use with label mounts since degree of protection is not guaranteed				
		Push-button actuators M22(S)-D(R)-... Illuminated push-button actuators M22(S)-DL-..., M22(S)-DRL-... Indicator light, flush M22(S)-L(C)-...	M22-T-D 216395	10 off
		Double actuators M22(S)-DD(L)-...	M22-T-DD 216396	10 off
Telescopic clip				
For adjusting depth of rear mounting devices in CI enclosures and panels with a mounting depth of 125 – 157mm. Stepless adjustment from 64 – 95 mm, screw and snap fastener. Maximum of 10 × M22-TC per CI enclosure, five of which can hold stay-put actuators. Do not use with Emergency-Stop actuators.				
			M22-TC 216398	10 off
Centring adapter				
for use with M22-TC telescopic clips				
			M22-ZA 216399	10 off
IVS top-hat rail adapter				
For front fixing				
			M22-IVS 216400	1 off
Plunger bridge				
For medium contact (1 piece), black				
			M22-XW 216405	10 off

RMQ Titan Accessories

	For use with	Colour	Type Article no.	Price See Price List	Std. pack	
Threaded ring M22 × 1,5 mm 			M22-GR 216401		50 off	
			M22-GR-GVP 216404		500 off	
Adapter ring set 30/22.5 mm Black, consisting of adapter ring and lock nut 	for mounting of \varnothing 22.5 units in \varnothing 30.5 holes		M22S-R30 216408		10 off	
Combination box spanner 	For front ring and lock nuts as well as illuminated actuator lens assemblies	–	M22-MS 216402		5 off	
Fixing plate 	For fixing shrouds (M22-H...) to M22-E... flush mounting panel, for 5 locations		M22-XE5 218945		1 off	
Indicator light, compact IP 66 Flush, with BA 9s lamp socket 			M22-LC-W 216907		10 off	
			M22-LC-R 216908			
			M22-LC-G 216909			
			M22-LC-Y 216910			
			M22-LC-B 216911			
		Without lens	M22-LC-X 216912			
	Extended, with BA 9s lamp socket 			M22-LCH-W 216914		
				M22-LCH-R 216915		
				M22-LCH-G 216916		
				M22-LCH-Y 216917		
		M22-LCH-B 216918				
Acoustic indicator, IP 40 Front black incl. buzzer 18 – 30 V DC			M22-AM 216913		10 off	
Bulb extractor 	for compact indicator light M22-LC(H)...	–	M22-LG 216403		5 off	

RMQ Titan

Technical Data

				Contact elements	LED elements	Push-button actuators Mushroom actuators	Double actuators	Selector switch actuators Illuminated selector actuators
General								
Standards				IEC/EN 60 947, VDE 0660				
Lifespan, mechanical	Operations	$\times 10^6$		10	–	5	0.2	0.1
Maximum operating frequency		Ops/h		3600	–	3600	3600	2000
Operating force		N		≤ 5	–	≤ 5	≤ 5	–
Operating torque		Nm		–	–	–	–	$\leq 0,3$
Degree of protection to IEC/EN 60 529				IP 20	IP 20	IP 66	IP 66	IP 66
Climatic proofing				Damp heat, constant, to IEC 60 068-2-3 Damp heat, cyclical, to IEC 60 068-2-30				
Ambient temperature								
	Min./Max.	$^{\circ}\text{C}$		$-25/+70$	$-25/+70^{1)}$	$-25/+70$	$-25/+70$	$-25/+70$
Mounting position				As required				
Mechanical shock resistance (shock duration 11 ms) to IEC 60 068-2-27				g				
				> 30				
Terminal capacity								
Solid	Min./Max.	mm^2		0.75/2.5	0.75/2.5	–	–	–
Stranded	Min./Max.	mm^2		0.5/1.5	0.5/1.5	–	–	–
Dimensions				\rightarrow Page 34				
				–				
				\rightarrow Page 33				
				\rightarrow Page 33				
				\rightarrow Page 33				
Contacts								
Rated impulse withstand voltage U_{imp}				V				
				6000				
Rated insulation voltage U_i				V				
				500				
Overvoltage category/pollution degree				III/3				
Control circuit reliability at								
24 V DC/5 mA	Fault probability H_F			$< 10^{-7}$, < 1 fault in 10^7 operations				
5 V DC/1 mA	Fault probability H_F			$> = \times 10^{-6}$, < 1 fault in 5×10^6 operations				
Max. short-circuit protective device								
Fuseless	Type			PKZM0–10/ FAZ-B6	–	–	–	–
Fuse	A gL/gG			10	–	–	–	–
Switching capacity								
Rated operational current I_e								
AC-15	115 V	A		6	–	–	–	–
	230 V	A		6	–	–	–	–
	400 V	A		4	–	–	–	–
	500 V	A		2	–	–	–	–
DC-13	24 V	A		3	–	–	–	–
	42 V	A		1.7	–	–	–	–
	60 V	A		1.2	–	–	–	–
	110 V	A		0.8	–	–	–	–
	220 V	A		0.3	–	–	–	–
Lifespan, electrical								
AC-15	230 V/0.5 A	Operations	$\times 10^6$	1.6	–	–	–	–
	230 V/1.0 A	Operations	$\times 10^6$	1.0	–	–	–	–
	230 V/3.0 A	Operations	$\times 10^6$	0.7	–	–	–	–
DC-13	12 V/2.8 A	Operations	$\times 10^6$	1.2	–	–	–	–

Notes

¹⁾ > 200 V AC/60 Hz: $-25/+55$ $^{\circ}\text{C}$

RMQ Titan

Technical Data

			Key-operated actuators	Indicator lights	Illuminated push-button actuators, Push-button actuators Mushroom actuators Stay-put	Emergency-Stop actuators
General						
Standards			IEC/EN 60 947, VDE 0660			
Lifespan, mechanical	Operations	× 10 ⁶	0.1	–	3 ²⁾	0.1
Maximum operating frequency		Ops/h	100	–	1800	600
Operating force		N	–	–	≤ 5	≤ 50
Operating torque		Nm	≤ 0.5	–	–	–
Degree of protection to IEC/EN 60 529			IP 66	IP 66	IP 66	IP 66
Climatic proofing			Damp heat, constant, to IEC 60 068-2-3 Damp heat, cyclical, to IEC 60 068-2-30			
Ambient temperature						
	Min./Max.	°C	–25/+70	–25/+70	–25/+70	–25/+70
Mounting position			As required	As required	As required	As required
Mechanical shock resistance (shock duration 11 ms) to IEC 60 068-2-27			g	> 30	> 30	> 50
Terminal capacity						
Solid	Min./Max.	mm ²	–	–	–	–
Stranded	Min./Max.	mm ²	–	–	–	–
Dimensions			→ Page 33	→ Page 33	→ Page 33	→ Page 33

Notes

2) 0.3 for M22-DRL-...

RMQ Titan Dimensions

Actuators and indicators

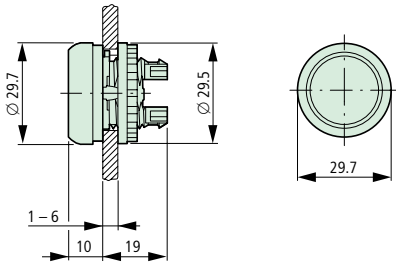

Push-button actuators

M22-D

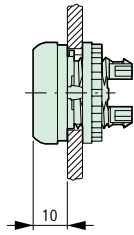

M22-DH

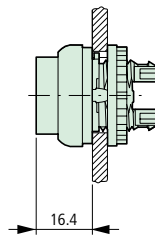

M22-DG

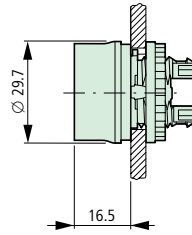

M22-DD

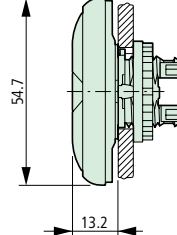

Push-button actuator in base fixing

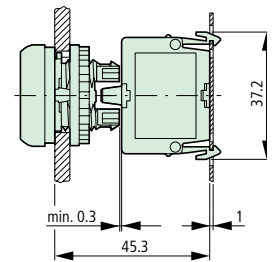

Selector switch actuators

M22-W(R)...

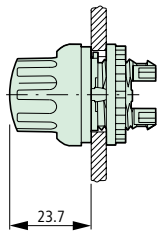

M22-W(R)K...
M22-W(R)LK...

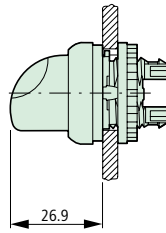

Key-operated actuators Individual lock mechanism

M22(S)-W(R)S-(MS...)

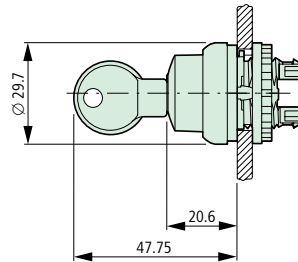

Master key systems

M22(S)-W(R)S-SA...

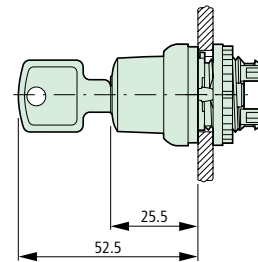

Indicator lights

M22-LH

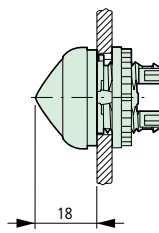

M22-L

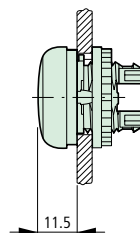

Illuminated push-button actuators

M22-DL

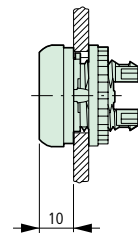

M22-DLH

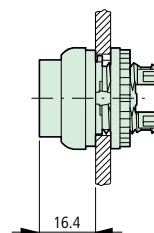

Mushroom actuators

M22-DP

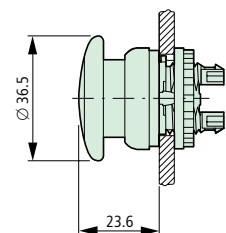

Emergency-Stop actuator

M22-PV, M22S-PV
M22-PVL, M22-PVS...

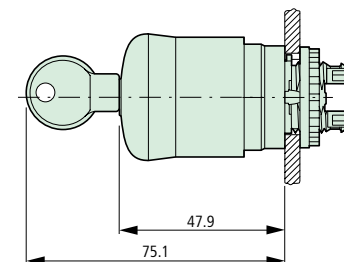

RMQ Titan Dimensions

Front fixing (style: flush mounting)

Fixing adapter

M22-A

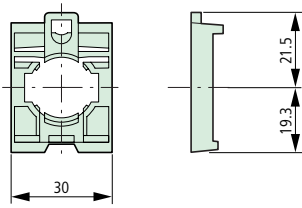

Centring adapter

M22-ZA

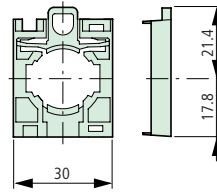

Actuator with M22-(C)K...

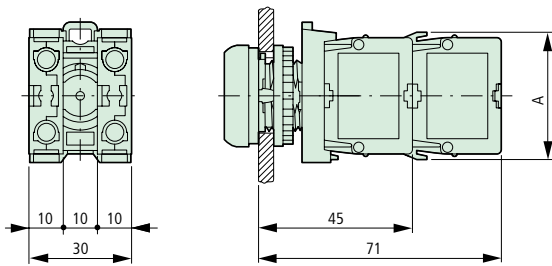

Indicator light/Illuminated actuator

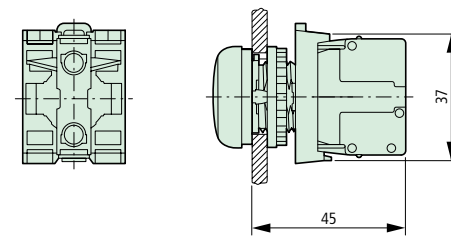

	1 × M22-K...	2 × M22-K...	1 × M22-CK...	2 × M22-CK...
A	37.2	37.2	39	39

IVS Top-hat rail adapter

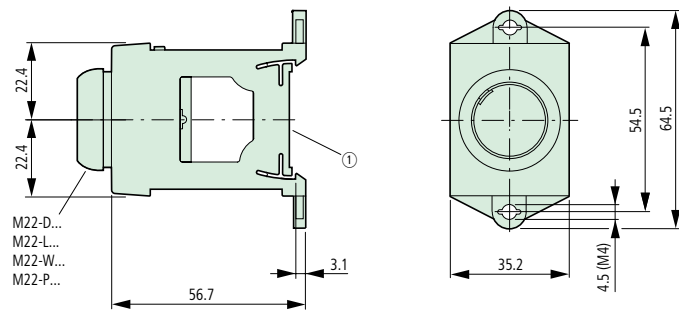

① For top-hat rails to EN 50 022

Button, illuminated push-button, indicator light With telescopic clip

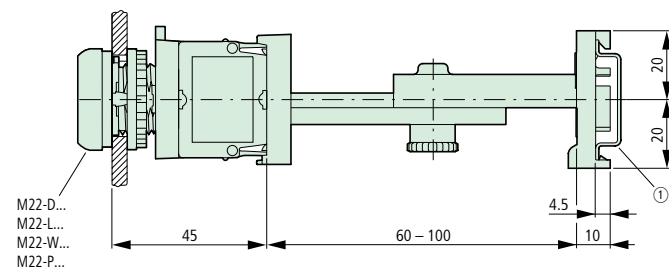

① Top-hat rail to EN 50 022

RMQ Titan Dimensions

Front fixing (style: flush mounting) Flush mounting panel M22-E...

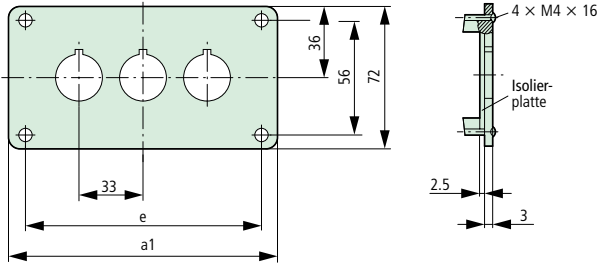

Type	a1	e
E (Y) 1	72	56
E 2	105	89
E 3	138	122
E 4	171	155
E 5	204	188
E 6	237	221

Base fixing (style: surface mounting) Surface mounting enclosure M22-I...

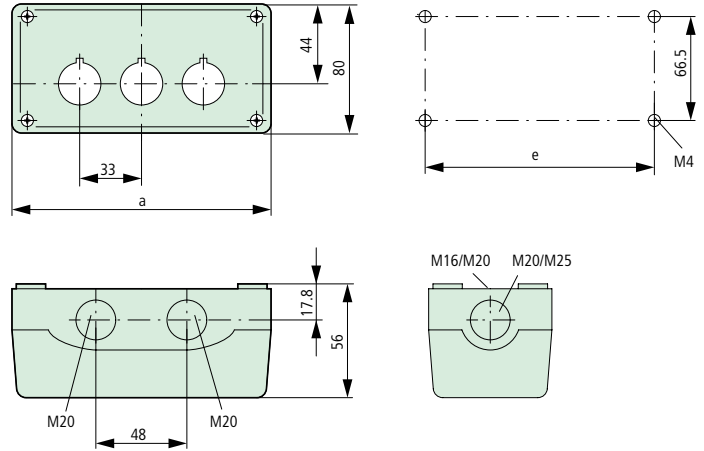

Type	Number of locations	a	e	Cable entries		
M22-I (Y) 1	1	72	58.5	2 × M16	3 × M20	2 × M25
M22-I 2	2	120	106.5	2 × M16	3 × M20	2 × M25
M22-I 3	3	153	139.5	2 × M16	2 × M25	4 × M20
M22-I 4	4	186	172.5	2 × M16	2 × M25	4 × M20
M22-I 6	6	252	238.5	2 × M16	2 × M25	4 × M20

Shroud M22-H...

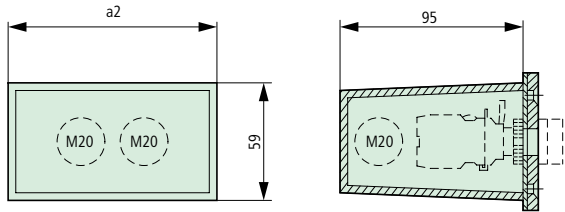

Type	a2	Cable entry	Style
H 1	42	3 × M20	One-part
H 2	75	4 × M20	
H 3	108	4 × M20	
H 4	141	4 × M20	Multi-part
H 5	174	5 × M20	
H 6	207	6 × M20	

Shroud with plaster keys M22-UPE

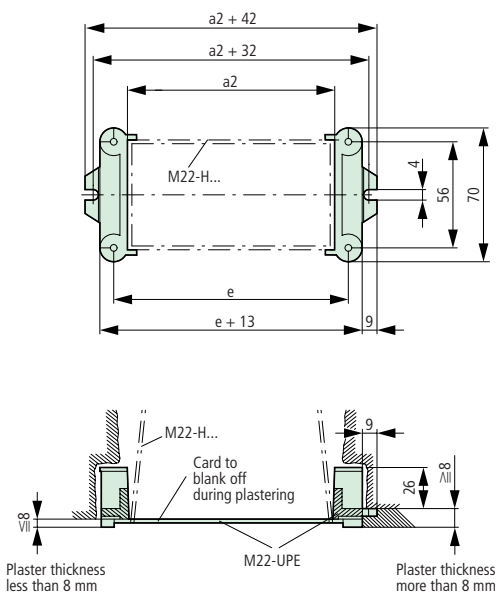

Surface mounting enclosure for 12 locations M22-112

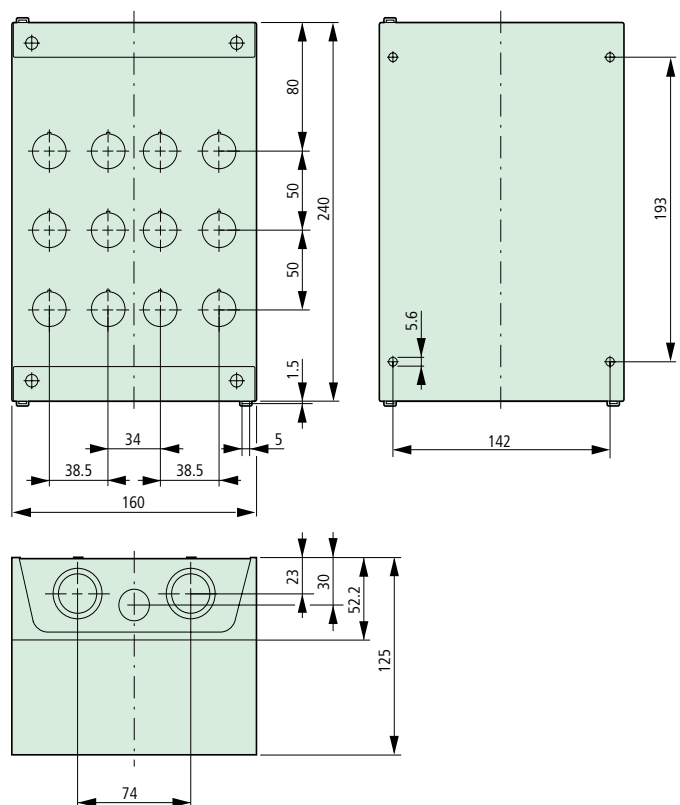

RMQ Titan Dimensions

Label mounts

M22-ST

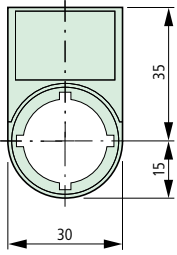

Grid dimension to IEC/EN 60 947

M22-STDD

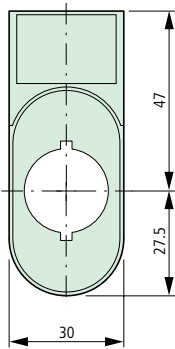

Minimal grid dimension

Mounting holes with/without lug slot

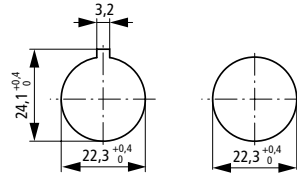

Grid dimension for different combinations

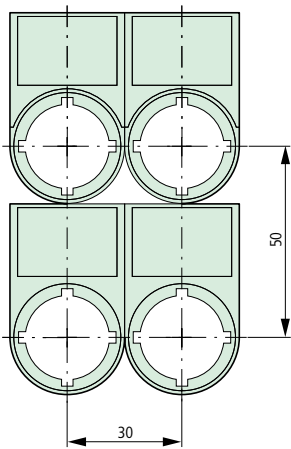

Grid dimension for M22-DD...

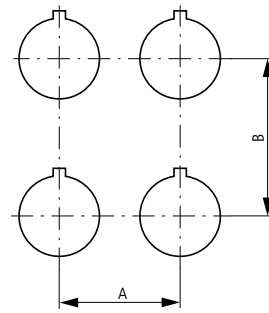
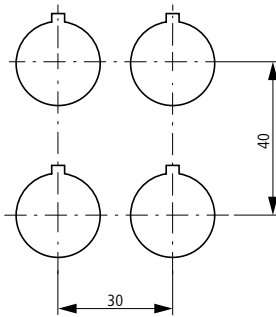

Do not use actuator diaphragm with label mounts since the mounts do not conform to IP 67.

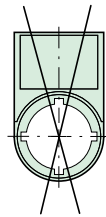

	A ≙	B ≙
IEC/EN 60 947	30	50
RMQ Titan min.	30	40
D + T-D	33	
DP	37	
D+DP	30	
PV	38	
PV+PL-PV	48	56
DD	30	55
DD+T-DD	33	58
DD+STDD	30	75

Grid dimension for QDD double actuators plus MT-DD diaphragms

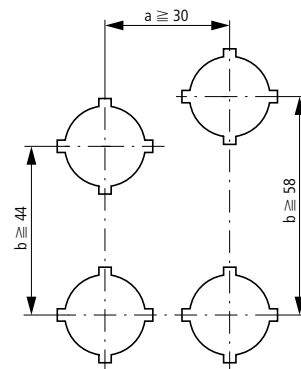
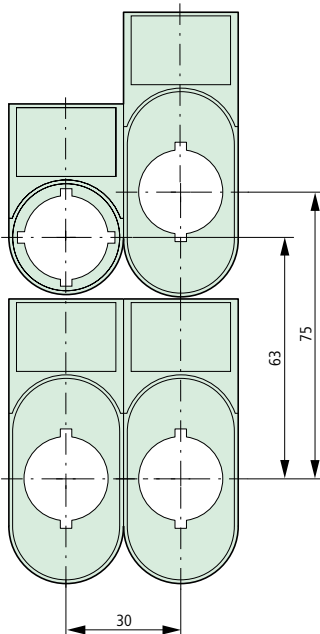

Do not use actuator diaphragm with label mounts since the mounts do not conform to IP 67.

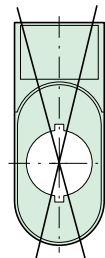

RMQ Titan Dimensions

Accessories

M22-PL-PV

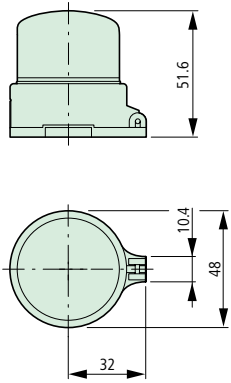

M22-B

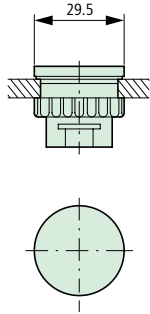

M22-T-D

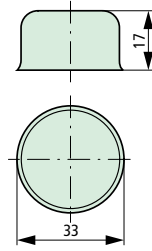

M22-T-DD

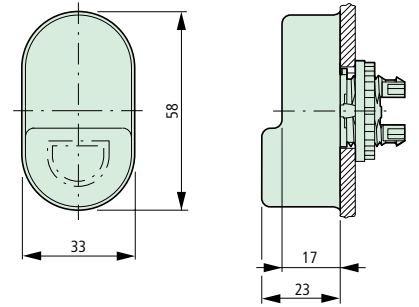

Emergency-Stop label

M22-XAK

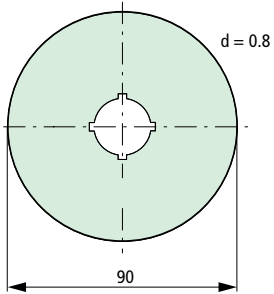

M22-XZK...

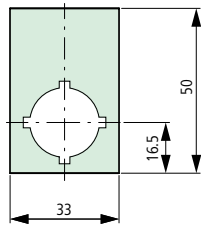

M22-XBK1

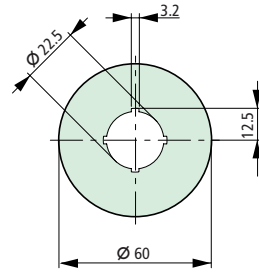

M22-XYK1

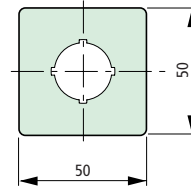

RMQ Titan Conversion Table

Unit	Type RMQ22	New type RMQ Titan	Unit	Type RMQ22	New type RMQ Titan
Push-button actuators			Double actuators		
Flush, spring-return	RD-01	M22-D-S	Non-illuminated	QDD-X	M22-DD-GR
	RD-02	M22-D-W		QDD-11/10	M22-DD-GR-X1/X0
	RD-03	M22-D-R		QDD-111/110	M22-DD-GR-GB1/GB0
	RD-04	M22-D-G		QDD-X	M22-DD-WS
	RD-05	M22-D-Y		QDD-20/19	M22-DD-WS-X1/X0
	RD-06	M22-D-B		QDD-122/112	M22-DD-WS-GB1/GB0
	RD-X	M22-D-X		QDD-32/32	M22-DD-S-X7/X7
				QDD-37/38	M22-DD-S-X4/X5
			Illuminated	QDDL-X	M22-DDL-GR
	RD-10	M22-D-R-X0		QDDL-11/10	M22-DDL-GR-X1/X0
	RD-11	M22-D-G-X1		QDDL-111/110	M22-DDL-GR-GB1/GB0
	RD-19	M22-D-S-X0		QDDL-X	M22-DDL-WS
	RD-20	M22-D-W-X1		QDDL-20/19	M22-DDL-WS-X1/X0
				QDDL-122/112	M22-DDL-WS-GB1/GB0
Flush, stay-put	–	M22-DR-S	QDDL-32/32	M22-DDL-S-X7/X7	
	–	M22-DR-W	QDDL-37/38	M22-DDL-S-X4/X5	
	–	M22-DR-R	Mushroom actuators		
	–	M22-DR-G	Spring-return	RP-SW01	M22-DP-S
	–	M22-DR-Y		RP-RT03	M22-DP-R
	–	M22-DR-B		RP-GN04	M22-DP-G
	–	M22-DR-X		RP-GE05	M22-DP-Y
	–			RP-RT10	M22-DP-R-X0
	–	M22-DR-R-X0		RP-RT11	M22-DP-G-X1
	–	M22-DR-G-X1		RP-SW19	M22-DP-S-X0
–	M22-DR-S-X0	RP-SW20		M22-DP-W-X1	
–	M22-DR-W-X1	RP-SW-X		M22-DP-S-X	
		RP-RT-X		M22-DP-R-X	
Extended, spring-return	RDH-SW01	M22-DH-S	RP-GN-X	M22-DP-G-X	
	–	M22-DH-W	RP-GE-X	M22-DP-Y-X	
	RDH-RT03	M22-DH-R	Stay-put	–	M22-DRP-S
	RDH-GN04	M22-DH-G		–	M22-DRP-R
	RDH-GE05	M22-DH-Y		–	M22-DRP-G
	–	M22-DH-B		–	M22-DRP-Y
	RDH-RT10	M22-DH-R-X0		–	M22-DRP-R-X0
	RDH-GN11	M22-DH-G-X1		–	M22-DRP-G-X1
	RDH-SW19	M22-DH-S-X0		–	M22-DRP-S-X0
	RDH-SW20	M22-DH-W-X1		–	M22-DRP-W-X1
		–		M22-DRP-S-X	
		–		M22-DRP-R-X	
Extended, stay-put	–	M22-DRH-S	–	M22-DRP-G-X	
	–	M22-DRH-W	–	M22-DRP-Y-X	
	–	M22-DRH-R	–		
	–	M22-DRH-G	–		
	–	M22-DRH-Y	–		
	–	M22-DRH-B	–		
	–		–		
	–	M22-DRH-R-X0	–		
	–	M22-DRH-G-X1	–		
	–	M22-DRH-S-X0	–		
–	M22-DRH-W-X1	–			
With guard ring	RDK-X	M22-DG-X			
Emergency-Stop actuators	RPV	M22-PV			
	–	M22-PVL			
Emergency-Stop Key-operated actuators	RPSR	M22-PVS			
	RPSR-KMS...	M22-PVS-MS*			

RMQ Titan Conversion Table

Unit	Type RMQ22	New type RMQ Titan	Unit	Type RMQ22	New type RMQ Titan
Illuminated push-button actuators			Illuminated selector switch actuators		
Flush, spring-return	RLT-WS	M22-DL-W	Thumb-grip, Two positions, spring-return	RLWK1-WS	M22-WLK-W
	RLT-RT	M22-DL-R		RLWK1-RT	M22-WLK-R
	RLT-GN	M22-DL-G		RLWK1-GN	M22-WLK-G
	RLT-GE	M22-DL-Y		RLWK1-GE	M22-WLK-Y
	RLT-BL	M22-DL-B		RLWK1-BL	M22-WLK-B
	–	M22-DL-X	Thumb-grip, Two positions, stay-put	RLWK1R-WS	M22-WRLK-W
	–	M22-DL-R-X0		RLWK1R-RT	M22-WRLK-R
	–	M22-DL-G-X1		RLWK1R-GN	M22-WRLK-G
	–	M22-DL-W-X0		RLWK1R-GE	M22-WRLK-Y
	RLT-WS11	M22-DL-W-X1		RLWK1R-BL	M22-WRLK-B
Flush, stay-put	RLTR-WS	M22-DRL-W	Thumb-grip, Three positions, spring-return	RLWK3-WS	M22-WLK3-W
	RLTR-RT	M22-DRL-R		RLWK3-RT	M22-WLK3-R
	RLTR-GN	M22-DRL-G		RLWK3-GN	M22-WLK3-G
	RLTR-GE	M22-DRL-Y		RLWK3-GE	M22-WLK3-Y
	RLTR-BL	M22-DRL-B		RLWK3-BL	M22-WLK3-B
	–	M22-DRL-X	Thumb-grip, Three positions, stay-put	RLWK3R-WS	M22-WRLK3-W
	–	M22-DRL-R-X0		RLWK3R-RT	M22-WRLK3-R
	–	M22-DRL-G-X1		RLWK3R-GN	M22-WRLK3-G
	–	M22-DRL-W-X0		RLWK3R-GE	M22-WRLK3-Y
	–	M22-DRL-W-X1		RLWK3R-BL	M22-WRLK3-B
Extended, spring-return	RLTH-WS	M22-DLH-W	RLWK3R-...	M22-WRLK3-*/*	
	RLTH-RT	M22-DLH-R	Indicator lights		
	RLTH-GN	M22-DLH-G	Flush	RLF-WS	M22-L-W
	RLTH-GE	M22-DLH-Y		RLF-RT	M22-L-R
	RLTH-BL	M22-DLH-B		RLF-GN	M22-L-G
	–	M22-DLH-R-X0		RLF-GE	M22-L-Y
	–	M22-DLH-G-X1		RLF-BL	M22-L-B
	–	M22-DLH-W-X0	–	M22-L-X	
	RLTH-WS11	M22-DLH-W-X1	Extended	RL-WS	M22-LH-W
	–	M22-DLH-R-X0		RL-RT	M22-LH-R
–	M22-DLH-G-X1	RL-GN		M22-LH-G	
–	M22-DLH-W-X0	RL-GE		M22-LH-Y	
–	M22-DLH-W-X1	RL-BL		M22-LH-B	
Extended, stay-put	–	M22-DRLH-W	Compact, flush	–	M22-LC-W
	–	M22-DRLH-R		–	M22-LC-R
	–	M22-DRLH-G		–	M22-LC-G
	–	M22-DRLH-Y		–	M22-LC-Y
	–	M22-DRLH-B		–	M22-LC-B
	–	M22-DRLH-R-X0	–	M22-LC-X	
	–	M22-DRLH-G-X1	Compact, extended	–	M22-LCH-W
	–	M22-DRLH-W-X0		–	M22-LCH-R
	–	M22-DRLH-W-X1		–	M22-LCH-G
	–			–	M22-LCH-Y
–		–		M22-LCH-B	
			Acoustic indicator		
			–	M22-AM	

RMQ Titan Conversion Table

Unit	Type RMQ22	New type RMQ Titan	Unit	Type RMQ22	New type RMQ Titan
Key-operated actuators			LED elements		
Two positions	RS-KMS1-A1	M22-WS	Screw terminal	EF + GL24	M22-LED-W
	RS-KMS...-A1	M22-WS-MS*		EF + GL24	M22-LED-R
	RS-SA(...)	M22-WS-SA(*)-*		EF + GL24	M22-LED-G
	RS	M22-WRS		EF + GL24	M22-LED-B
	RS-KMS...	M22-WRS-MS*		EFC + GL24	M22-LEDC-W
	RS-KMS...	M22-WRS-MS*-A1		EFC + GL24	M22-LEDC-R
	RS-SA(...)	M22-WRS-SA(*)-*		EFC + GL24	M22-LEDC-G
Three positions	RS3-KMS1-A1	M22-WS3		EFC + GL24	M22-LEDC-B
	RS3-KMS...-A1	M22-WS3-MS*		EF3 + GL130	M22-LED230-W
	RS3-SA(...)	M22-WS3-SA(*)-*		EF3 + GL130	M22-LED230-R
	RS3	M22-WRS3		EF3 + GL130	M22-LED230-G
	RS3-KMS...	M22-WRS3-MS*		EF3 + GL130	M22-LED230-B
	RS3-KMS...	M22-WRS3-MS*-A*		EF3C + GL130	M22-LEDC230-W
	RS3-SA(...)	M22-WRS3-SA(*)-*	EF3C + GL130	M22-LEDC230-R	
Replacement key			EF3C + GL130	M22-LEDC230-G	
Individual lock mechanism MS1	ES-KMS1	M22-ES-MS1	EF3C + GL130	M22-LEDC230-B	
Individual lock mechanism MS2-20	ES-KMS...	M22-ES-MS*	Cage Clamp		
for SA(...)	ES-NS...	M22-ES-SA(*)-*	–	M22-CLED-W	
Selector switch actuators			–	M22-CLED-R	
Rotary head, Two positions	RW1	M22-W	–	M22-CLED-G	
	RW1R	M22-WR	–	M22-CLED-B	
	RW1R+92T	M22-WR-X92	–	M22-CLED230-W	
	RW1R+97T	M22-WR-X91	–	M22-CLED230-R	
Rotary head, Three positions	RW3	M22-W3	–	M22-CLED230-G	
	RW3R	M22-WR3	–	M22-CLED230-B	
Thumb-grip, Two positions	RWK1	M22-WK	–	M22-CLED230-W	
	RWK1R	M22-WRK	–	M22-CLED230-R	
Thumb-grip, Three positions	RWK3	M22-WK3	–	M22-CLED230-G	
	RWK3R	M22-WRK3	–	M22-CLED230-B	
	RWK3R-...	M22-WRK3-*	–	M22-CLED230-W	
V position	RWK1V	M22-WKV	–	M22-CLED230-R	
Functional elements			–	M22-CLED230-G	
Make contact, Screw terminal	EK10	M22-K10	–	M22-CLED230-B	
	EK10C	M22-KC10	Functional elements		
Break contact, Screw terminal	EK01	M22-K01	Make contact, Screw terminal	EK10	M22-K10
	EK01C	M22-KC01	Break contact, Screw terminal	EK10C	M22-KC10
Make contact, Cage Clamp	–	M22-CK10	Make contact, Cage Clamp	–	M22-CK10
	–	M22-CKC10	Break contact, Cage Clamp	–	M22-CKC10
Break contact, Cage Clamp	–	M22-CK01	Fixing adapter (front)	BE3, BE6	M22-A
	–	M22-CKC01			

RMQ Titan Conversion Table

Unit	Type RMQ22	New type RMQ Titan	Unit	Type RMQ22	New type RMQ Titan
Enclosures			Button lenses, Illuminated		
Surface mounting enclosure	I1M	M22-I1	Push-button actuator, flush	LLT-WS	M22-XDL-W
	IGE1M	M22-IY1		LLT-RT	M22-XDL-R
	I2M	M22-I2		LLT-GN	M22-XDL-G
	I3M	M22-I3		LLT-GE	M22-XDL-Y
	I4M	M22-I4		LLT-BL	M22-XDL-B
	I5M	M22-I6		Sond	M22-XDL-*. *
	I12M	M22-I12	Push-button actuator, extended	LLTH-WS	M22-XDLH-W
Flush mounting panel	E1M	M22-E1		LLTH-RT	M22-XDLH-R
	EGE1M	M22-EY1		LLTH-GN	M22-XDLH-G
	E2M	M22-E2		LLTH-GE	M22-XDLH-Y
	E3M	M22-E3		LLTH-BL	M22-XDLH-B
	E4M	M22-E4		Sond	M22-XDLH-*. *
	E5M	M22-E5	Lenses, Indicator lights		
	E6M	M22-E6	Flush	LLF-WS	M22-XL-W
Shroud	H1M	M22-H1		LLF-RT	M22-XL-R
	H2M	M22-H2		LLF-GN	M22-XL-G
	H3M	M22-H3		LLF-GE	M22-XL-Y
	H4M	M22-H4		LLF-BL	M22-XL-B
	H5M	M22-H5		Sond	M22-XL-*. *
	H6M	M22-H6	Extended	LL-WS	M22-XLH-W
Plaster Fixing key	UPE	M22-UPE		LL-RT	M22-XLH-R
	Button plates, Non-illuminated			LL-GN	M22-XLH-G
Push-button actuators, flush	01T	M22-XD-S		LL-GE	M22-XLH-Y
	02T	M22-XD-W		LL-BL	M22-XLH-B
	03T	M22-XD-R	Emergency-Stop labels		
	04T	M22-XD-G	1AK	M22-XAK	
	05T	M22-XD-Y	1AK-...	M22-XAK1	
	06T	M22-XD-B	1AK-...	M22-XAK2	
	Sond	M22-XD-*. *	1AK-...	M22-XAK3	
Push-button actuators, extended	01T	M22-XDH-S	1AK-...	M22-XAK4	
	02T	M22-XDH-W	Sond	M22-XAK-*	
	03T	M22-XDH-R	SR22	M22-XBK1	
	04T	M22-XDH-G	SQ22	M22-XYK1	
	05T	M22-XDH-Y	ZK05	M22-XZK	
	06T	M22-XDH-B	ZK-199	M22-XZK-D99	
	Sond	M22-XDH-*. *	ZK-299	M22-XZK-GB99	
Mushroom actuator	01T	M22-XDP-S	ZK-399	M22-XZK-F99	
	02T	M22-XDP-W	ZK-899	M22-XZK-199	
	03T	M22-XDP-R	ZK-599	M22-XZK-NL99	
	04T	M22-XDP-G	ZK-499	M22-XZK-S99	
	05T	M22-XDP-Y	ZK-699	M22-XZK-SF99	
	Sond	M22-XDP-*. *	ZK-1099	M22-XZK-DK99	
	Sond		Sond	M22-XZK-*	
Insert plate For label mounts			XB	M22-XST	
			Sond	M22-XST-*	

RMQ Titan Conversion Table

Unit	Type RMQ22	New type RMQ Titan	Unit	Type RMQ22	New type RMQ Titan	
Legend plate complete	RBS-90	M22S-ST-X88	Accessories			
	RBS-98	M22S-ST-X89	Blanking plug	RB22G	M22-B	
	RBS-93	M22S-ST-X93	Blanking plug	RB22S	M22S-B	
	RBS-117	M22S-ST-D5	Legend plate Label mounts; without label	RBS-X	M22S-ST-X	
	RBS-121	M22S-ST-D6	Legend plate Label mounts f. DD(L)	QBS-X	M22S-STDD-X	
	RBS-183	M22S-ST-D7	Actuator protectivediaphragm	MT-D	M22-T-D	
	RBS-150	M22S-ST-D8	Actuator protectivediaphragm	MT-DD	M22-T-DD	
	RBS-196	M22S-ST-D10	Sealable shroud	PL-RPV	M22-PL-PV	
	RBS-195	M22S-ST-D11	Telescopic clip	TC-RMQ	M22-TC	
	RBS-197	M22S-ST-D12	Centring adapter	BE3Z	M22-ZA	
	RBS-110	M22S-ST-GB0	IVS Top-hat rail adapter	–	M22-IVS	
	RBS-111	M22S-ST-GB1	Threading ring	GR22	M22-GR	
	RBS-217	M22S-ST-GB5	Combination box spanner	R22-MS	M22-MS	
	RBS-221	M22S-ST-GB6	Bulb extractor	R22-MS	M22-LG	
	RBS-283	M22S-ST-GB7	Plunger bridge	–	M22-XW	
	RBS-250	M22S-ST-GB8	Coding adapter	SP-RMQ-RT	M22-XC-R	
	RBS-296	M22S-ST-GB10	Coding adapter	SP-RMQ-GE	M22-XC-Y	
	RBS-395	M22S-ST-GB11	Set of adapter rings 30/22.5mm	R22/30-SW	M22S-R30	
	RBS-397	M22S-ST-GB12	Fixing plate	Z2116-171.03.5	M22-XE5	
	Complete modules	BK01	M22-AK01			
		BK10	M22-AK10			
BK11		M22-AK11				
Complete units	QDD-11/10/K11	M22-DD-GR-X1/X0/K11				
	QDDL-11/10/K11/F	M22-DDL-GR-X1/X0/K11/230-W				
	RD-10/K01	M22-D-R-X0/K01				
	RD-10/K11	M22-D-R-X0/K11				
	RD-11/K10	M22-D-G-X1/K10				
	RD-11/K11	M22-D-G-X1/K11				
	RPSR/K01	M22-PVS/K01				
	RPV/K01	M22-PV/K01				
	RPV/K11	M22-PV/K11				
	RS/K11	M22-WRS/K11				
	RWK1R/K10	M22-WRK/K10				
	RWK1R/K11	M22-WRK/K11				
	RWK3R/K20	M22-WRK3/K20				
	RD-10/KC/I	M22-D-R-X0/KC11/I				
	RD-11/KC/I	M22-D-G-X1/KC11/I				
	RPSR/KC/I	M22-PVS/KC11/IY				
	RPV/K02C/I	M22-PV/KC02/IY				
	RPV/KC/I	M22-PV/KC11/IY				
	RS/KC/I	M22-WRS/KC11/I				
	1M/I	M22-I1-M1				
	1M/IGE	M22-I1Y-M1				
	R2M/I	M22-I2-M1				
	R3M/I	M22-I3-M1				
	R3M-L/I	M22-I3-M2				
	R4M/I	M22-I4-M1				

X-ON Electronics

Largest Supplier of Electrical and Electronic Components

Click to view similar products for [Pushbutton Switches](#) category:

Click to view products by [Eaton](#) manufacturer:

Other Similar products are found below :

[8940K2012](#) [8971K1133](#) [LW1L-M1C10V-A](#) [LW1L-M1C70-A](#) [LW2L-A1C20M-GD](#) [LW2L-M1C20M-A](#) [60324L](#) [M22-D-R-GB0/K11](#) [M7E-HRN2](#) [67021K512](#) [67081K512X](#) [701PB580](#) [7199K101](#) [810K12910](#) [810KSV30B](#) [MML21EA2ADK](#) [MML21KA3ABK](#)
[MML23KA3AC05K-001](#) [MML23KW3AA01W](#) [8418K2](#) [8442K3](#) [8450K1](#) [860K11911T01A](#) [861901](#) [861K11911T01A07](#)
[861K13810T00A14](#) [861K13911](#) [8646AB6X718UL](#) [8646ABUL](#) [9001KXRK](#) [907AYY100](#) [PMHD155A1](#) [9533CD4+U574+U4922](#) [95-414.000](#) [99-450.837](#) [99-453.837](#) [PV3H2B0NN-341](#) [1203MRA](#) [A22NZBGANGA](#) [A22NZBNANGA](#) [A22NZMPATRA](#) [A2PMA1X03EC56](#)
[A3A-5123-02](#) [A3A-7140](#) [A3A-7310](#) [A3A-7340](#) [A3U-TMW-A2C-5M](#) [A595](#) [12037A2ULCSA](#) [ABD122N-B](#)