

P6SMB

600 W Transient voltage suppressor

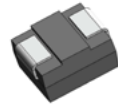

Product features

- Low profile SMB package
- Excellent clamping capability
- 600 W peak pulse power capability at 10/1000 μ s waveform
- Typical I_R less than 1 μ A above 12 V
- Fast response time: typically less than 1.0 ps from 0 V to V_{BR} minimum
- High temperature reflow soldering: +260 °C /40 s at terminal
- Plastic package meets UL 94 V-0 flammability rating
- Meets moisture sensitivity level (MSL) level 1
- Terminal: Solder plated leads, solderable per J-STD-002
- For surface mounted applications in order to optimize board space
- UL 497B recognized.
File No. : E198449 Guide QVGO2

Applications

- Consumer electronics
- Telecommunications
- Computing and servers
- Appliances
- Industrial automation
- Mobile and wearables

Environmental compliance and general specifications



Ordering part number

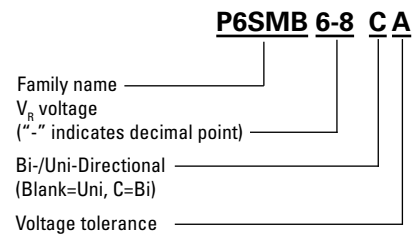

PIN configuration

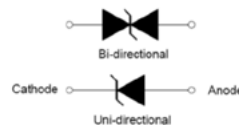
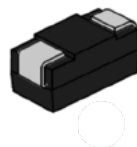

Absolute maximum ratings

(+25 °C, RH=45%-75%, unless otherwise noted)

Parameter	Symbol	Value	Unit
Storage operating junction temperature range	T_{STG}/T_J	-55 to +150	°C
Steady state power dissipation at $T_L = +75$ °C	$P_{M(AV)}$	5.0	W
Peak pulse power dissipation on 10/1000 μ s waveform	P_{PP}	600	W
Maximum instantaneous forward voltage at 100 A for unidirectional	V_F	5.0	V
Peak forward surge current, 8.3 ms single half sine wave ¹	I_{FSM}	100	A
Typical thermal resistance junction to lead	$R_{\theta JL}$	20	°C/W
Typical thermal resistance junction to ambient	$R_{\theta JA}$	100	°C/W

1. Measured on 8.3 ms single half sine wave or equivalent square wave for unidirectional device only, duty cycle = 4 per minute maximum

Mechanical parameters, pad layout- mm

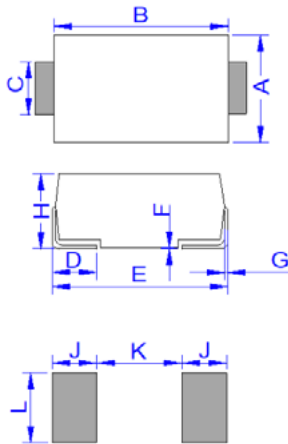

Dimension	Millimeters		Inches	
	Minimum	Maximum	Minimum	Maximum
A	3.30	3.94	0.130	0.155
B	4.30	4.80	0.169	0.189
C	1.90	2.20	0.075	0.087
D	0.95	1.52	0.037	0.060
E	5.20	5.60	0.205	0.220
F	0.051	0.203	0.002	0.008
G	0.15	0.31	0.006	0.012
H	2.10	2.40	0.083	0.094
J	2.20		0.087	
K		2.60		0.102
L	2.30		0.091	

Part marking



Cathode band (Uni-polar only)

Part marking: xxxx = Date code
yyyy- Refer to marking designator listed in Electrical Characteristics table

Packaging information (mm)

Drawing not to scale.

Supplied in tape and reel packaging, 3,000 parts per 13" diameter reel (EIA-481 compliant)

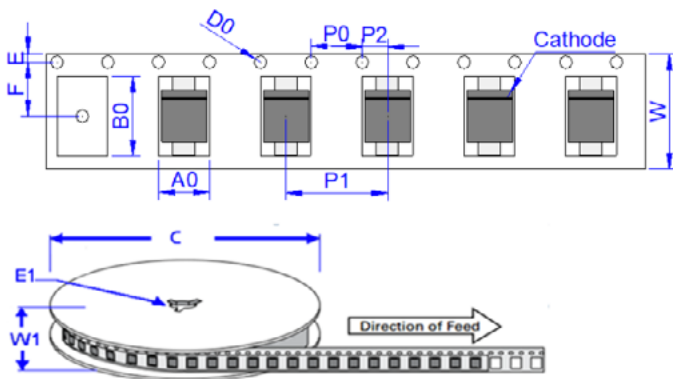

Dimension	Millimeters	Inches
A0	3.76 ± 0.3	0.148 ± 0.012
B0	5.69 ± 0.3	0.224 ± 0.012
C	330.0	13.0
D0	1.55 ± 0.1	0.061 ± 0.004
E	1.75 ± 0.2	0.069 ± 0.008
E1	13.3 ± 0.3	0.524 ± 0.012
F	5.5 ± 0.2	0.217 ± 0.008
P0	4.00 ± 0.2	0.157 ± 0.008
P1	8.00 ± 0.2	0.315 ± 0.008
P2	2.00 ± 0.2	0.079 ± 0.008
W	12.0 ± 0.2	0.472 ± 0.008
W1	15.7 ± 2.0	0.618 ± 0.079

Electrical characteristics (+25 °C)

Part number	Uni-polar	Bi-polar	Marking		V_R (V)	$I_R @ V_R$ (μ A)	$V_{BR} @ I_T$ min (V)	max (V)	I_T (mA)	$V_C @ I_{PP}$ max (V)	I_{PP} (A)
			Uni	Bi							
P6SMB6-8A	P6SMB6-8CA	6V8A	6V8C	5.8	150	6.45	7.14	10	10.5	58.1	
P6SMB7-5A	P6SMB7-5CA	7V5A	7V5C	6.4	120	7.13	7.88	10	11.3	54	
P6SMB8-2A	P6SMB8-2CA	8V2A	8V2C	7.02	50	7.79	8.61	10	12.1	50.4	
P6SMB9-1A	P6SMB9-1CA	9V1A	9V1C	7.78	20	8.65	9.55	1	13.4	45.5	
P6SMB10A	P6SMB10CA	10A	10C	8.55	10	9.5	10.5	1	14.5	42.1	
P6SMB11A	P6SMB11CA	11A	11C	9.4	5	10.5	11.6	1	15.6	39.1	
P6SMB12A	P6SMB12CA	12A	12C	10.2	2	11.4	12.6	1	16.7	36.5	
P6SMB13A	P6SMB13CA	13A	13C	11.1	1	12.4	13.7	1	18.2	33.5	
P6SMB15A	P6SMB15CA	15A	15C	12.8	1	14.3	15.8	1	21.2	28.8	
P6SMB16A	P6SMB16CA	16A	16C	13.6	1	15.2	16.8	1	22.5	27.1	
P6SMB18A	P6SMB18CA	18A	18C	15.3	1	17.1	18.9	1	25.2	24.2	
P6SMB20A	P6SMB20CA	20A	20C	17.1	1	19	21	1	27.7	21.7	
P6SMB22A	P6SMB22CA	22A	22C	18.8	1	20.9	23.1	1	30.6	19.7	
P6SMB24A	P6SMB24CA	24A	24C	20.5	1	22.8	25.2	1	33.2	18.4	
P6SMB27A	P6SMB27CA	27A	27C	23.1	1	25.7	28.4	1	37.5	16.3	
P6SMB30A	P6SMB30CA	30A	30C	25.6	1	28.5	31.5	1	41.4	14.7	
P6SMB33A	P6SMB33CA	33A	33C	28.2	1	31.4	34.7	1	45.7	13.3	
P6SMB36A	P6SMB36CA	36A	36C	30.8	1	34.2	37.8	1	49.9	12.2	
P6SMB39A	P6SMB39CA	39A	39C	33.3	1	37.1	41	1	53.9	11.3	
P6SMB43A	P6SMB43CA	43A	43C	36.8	1	40.9	45.2	1	59.3	10.3	
P6SMB47A	P6SMB47CA	47A	47C	40.2	1	44.7	49.4	1	64.8	9.4	
P6SMB51A	P6SMB51CA	51A	51C	43.6	1	48.5	53.6	1	70.1	8.7	
P6SMB56A	P6SMB56CA	56A	56C	47.8	1	53.2	58.8	1	77	7.9	
P6SMB62A	P6SMB62CA	62A	62C	53	1	58.9	65.1	1	85	7.2	
P6SMB68A	P6SMB68CA	68A	68C	58.1	1	64.6	71.4	1	92	6.6	
P6SMB75A	P6SMB75CA	75A	75C	64.1	1	71.3	78.8	1	103	5.9	
P6SMB82A	P6SMB82CA	82A	82C	70.1	1	77.9	86.1	1	113	5.4	
P6SMB91A	P6SMB91CA	91A	91C	77.8	1	86.5	95.5	1	125	4.9	
P6SMB100A	P6SMB100CA	100A	100C	85.5	1	95	105	1	137	4.5	
P6SMB110A	P6SMB110CA	110A	110C	94	1	105	116	1	152	4	
P6SMB120A	P6SMB120CA	120A	120C	102	1	114	126	1	165	3.7	
P6SMB130A	P6SMB130CA	130A	130C	111	1	124	137	1	179	3.4	
P6SMB150A	P6SMB150CA	150A	150C	128	1	143	158	1	207	2.9	
P6SMB160A	P6SMB160CA	160A	160C	136	1	152	168	1	219	2.8	
P6SMB170A	P6SMB170CA	170A	170C	145	1	162	179	1	234	2.6	
P6SMB180A	P6SMB180CA	180A	180C	154	1	171	189	1	246	2.5	
P6SMB200A	P6SMB200CA	200A	200C	171	1	190	210	1	274	2.2	
P6SMB220A	P6SMB220CA	220A	220C	185	1	209	231	1	328	1.9	
P6SMB250A	P6SMB250CA	250A	250C	214	1	237	263	1	344	1.8	
P6SMB300A	P6SMB300CA	300A	300C	256	1	285	315	1	414	1.5	
P6SMB350A	P6SMB350CA	350A	350C	300	1	332	368	1	482	1.3	
P6SMB400A	P6SMB400CA	400A	400C	342	1	380	420	1	548	1.1	
P6SMB440A	P6SMB440CA	440A	440C	376	1	418	462	1	602	1	
P6SMB480A	P6SMB480CA	480A	480C	408	1	456	504	1	658	0.9	
P6SMB510A	P6SMB510CA	510A	510C	434	1	485	535	1	698	0.9	
P6SMB540A	P6SMB540CA	540A	540C	460	1	513	567	1	740	0.8	
P6SMB600A	P6SMB600CA	600A	600C	512	1	570	630	1	828	0.75	

Ratings and V-I characteristic curves (+25 °C unless otherwise noted)

V- I curve characteristics (Uni-directional)

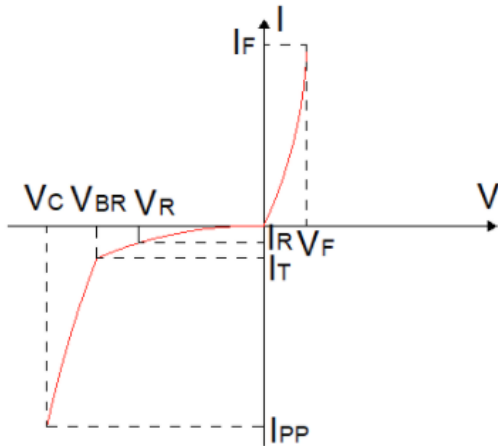

V- I curve characteristics (Bi-directional)

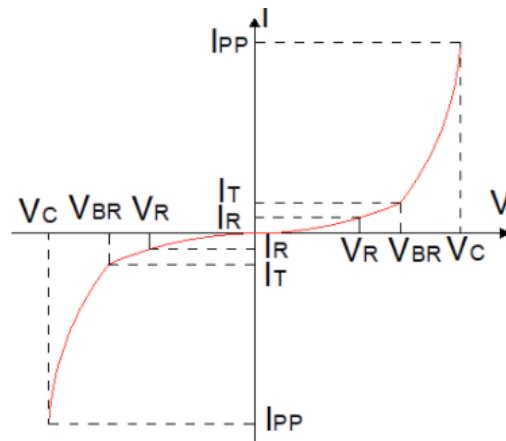

Surge waveform: 10/1000 μ s

V_R : Stand-off voltage – Maximum voltage that can be applied

V_{BR} : Breakdown voltage

V_C : Clamping voltage – Peak voltage measured across the suppressor at a specified I_{PP}

I_R : Reverse leakage current

I_T : Test current

V_F : Forward voltage drop for Uni-directional TVS diode

Pulse waveform

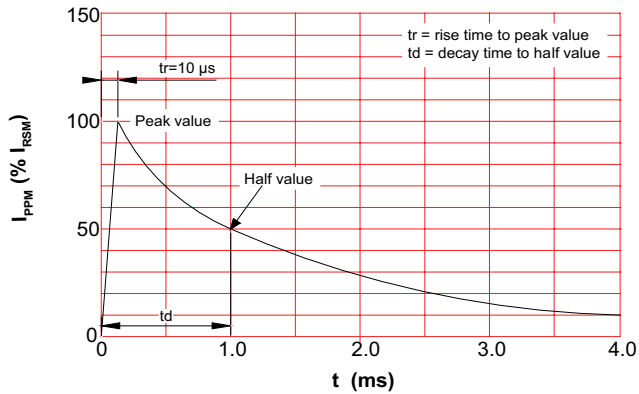

Pulse derating curve

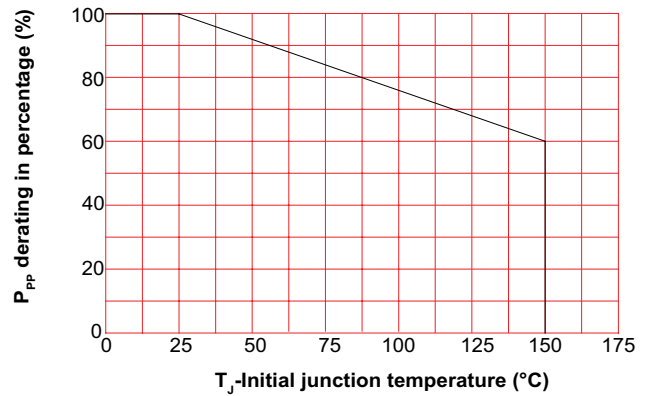

Peak pulse power dissipation vs. pulse width

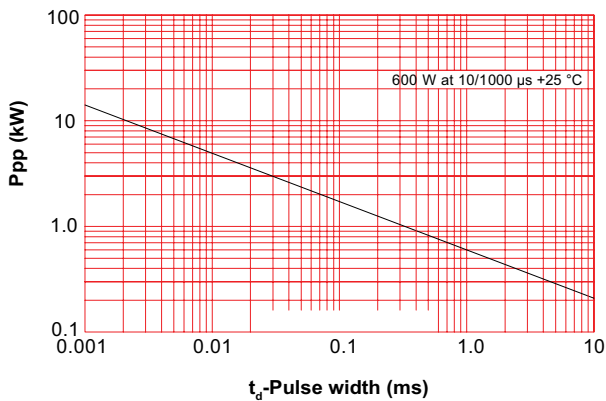

Solder reflow profile

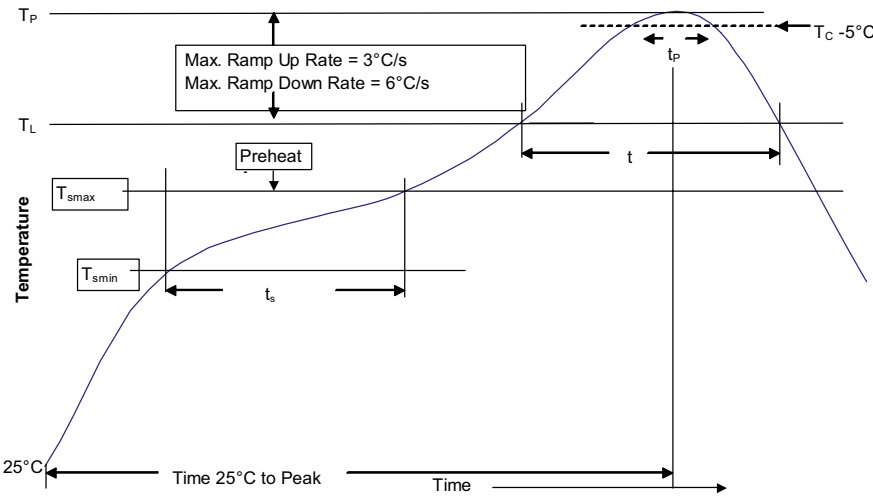

Table 1 - Standard SnPb solder (T_C)

Package thickness	Volume mm ³ <350	Volume mm ³ ≥350
<2.5 mm	235 °C	220 °C
≥2.5 mm	220 °C	220 °C

Table 2 - Lead (Pb) free solder (T_C)

Package thickness	Volume mm ³ <350	Volume mm ³ 350 - 2000	Volume mm ³ >2000
<1.6 mm	260 °C	260 °C	260 °C
1.6 – 2.5 mm	260 °C	250 °C	245 °C
>2.5 mm	250 °C	245 °C	245 °C

Reference J-STD-020

Profile feature	Standard SnPb solder	Lead (Pb) free solder
Preheat and soak	<ul style="list-style-type: none"> Temperature min. (T_{smin}) Temperature max. (T_{smax}) Time (T_{smin} to T_{smax}) (t_s) 	<ul style="list-style-type: none"> 100 °C 150 °C 60-120 seconds
Ramp up rate T_L to T_p	3 °C/ second max.	3 °C/ second max.
Liquidous temperature (T_L) Time (t_L) maintained above T_L	<ul style="list-style-type: none"> 183 °C 60-150 seconds 	<ul style="list-style-type: none"> 217 °C 60-150 seconds
Peak package body temperature (T_p)*	Table 1	Table 2
Time (t_p)* within 5 °C of the specified classification temperature (T_C)	20 seconds*	40 seconds*
Ramp-down rate (T_p to T_L)	6 °C/ second max.	6 °C/ second max.
Time 25 °C to peak temperature	6 minutes max.	8 minutes max.

* Tolerance for peak profile temperature (T_p) is defined as a supplier minimum and a user maximum.

Life Support Policy: Eaton does not authorize the use of any of its products for use in life support devices or systems without the express written approval of an officer of the Company. Life support systems are devices which support or sustain life, and whose failure to perform, when properly used in accordance with instructions for use provided in the labeling, can be reasonably expected to result in significant injury to the user.

Eaton reserves the right, without notice, to change design or construction of any products and to discontinue or limit distribution of any products. Eaton also reserves the right to change or update, without notice, any technical information contained in this bulletin.

Eaton
Electronics Division
1000 Eaton Boulevard
Cleveland, OH 44122
United States
Eaton.com/electronics

© 2020 Eaton
All Rights Reserved
Printed in USA
Publication No. 11212 BU-MC20190
November 2020

Eaton is a registered trademark.
All other trademarks are property of their respective owners.

Follow us on social media to get the latest product and support information.



X-ON Electronics

Largest Supplier of Electrical and Electronic Components

Click to view similar products for [ESD Suppressors / TVS Diodes](#) category:

Click to view products by [Eaton](#) manufacturer:

Other Similar products are found below :

[60KS200C](#) [D12V0H1U2WS-7](#) [D18V0L1B2LP-7B](#) [82356050220](#) [D5V0M5U6V-7](#) [NTE4902](#) [P4KE27CA](#) [P6KE11CA](#) [P6KE39CA-TP](#)
[P6KE8.2A](#) [SA110CA](#) [SA60CA](#) [SA64CA](#) [SMBJ12CATR](#) [SMBJ8.0A](#) [SMLJ30CA-TP](#) [ESD101-B1-02ELS E6327](#) [ESD112-B1-02EL E6327](#)
[ESD119B1W01005E6327XTSA1](#) [ESD5V0L1B02VH6327XTSA1](#) [ESD7451N2T5G](#) [19180-510](#) [CPDT-5V0USP-HF](#) [3.0SMCJ33CA-F](#)
[3.0SMCJ36A-F](#) [HSPC16701B02TP](#) [D3V3Q1B2DLP3-7](#) [D55V0M1B2WS-7](#) [DESD5V0U1BL-7B](#) [DRTR5V0U4SL-7](#) [SCM1293A-04SO](#)
[ESD200-B1-CSP0201 E6327](#) [ESD203-B1-02EL E6327](#) [SM12-7](#) [SMF8.0A-TP](#) [SMLJ45CA-TP](#) [CEN955 W/DATA](#) [82350120560](#)
[82356240030](#) [VESD12A1A-HD1-GS08](#) [CPDUR5V0R-HF](#) [CPDUR24V-HF](#) [CPDQC5V0U-HF](#) [CPDQC5V0USP-HF](#) [CPDQC5V0-HF](#)
[D1213A-01LP4-7B](#) [D1213A-02WL-7](#) [ESDLIN1524BJ-HQ](#) [5KP100A](#) [5KP15A](#)