

Installation devices



Catalogue

Valid from 1. 10. 2010

EATON

Powering Business Worldwide

MOELLER 

An Eaton Brand

Contents

Business information

Residual Current Devices	
Residual Current Devices PF7	5
Residual Current Devices dRCM Digital	9
Residual Current Relays PFR, Core Balance Transformers Z-WFR	11
Residual Current Devices PHF7	13
Residual Current Devices PFDM	15
Residual Current Devices PF6	17
PDIM Leakage Current Monitor	19
Add-on Residual Current Protection Unit PBHT	21
Combined RCD/MCB Devices PFL7, 1+N-pole	23
Combined RCD/MCB Devices PFL6, 1+N-pole	27
Combined RCD/MCB Devices mRB6, 3+N-pole	29
Miniature Circuit Breakers	
Miniature Circuit Breakers PL7	31
Miniature Circuit Breakers PL7-DC	36
Miniature Circuit Breakers PL6	37
Miniature Circuit Breakers PLHT and Accessories	41
Other Devices, Accessories	
Main Switch Disconnecter IS, Switch Disconnectors ZP-A	46
Accessories for MCBs and RCDs	47
Other installation devices, relays	50
Measuring Instruments and Accessories	60
Manual Motor Starters Z-MS	65
Busbar Systems	67
Fuse-links and Fuse Disconnectors	
Fuse-links D II, D III, D IV	74
Cylindrical Fuse-links Z-C	76
Fuse-Links Photovoltaic application	78
Fuse-Links D0	79
NH-Fuse-Links	85
Circuit Breakers LZM and Switch Disconnectors LN	91
Surge Arresters	97
Photovoltaic - Inverter	105
Control Relays EASY	107

Contents

Technical Data

Types and Characteristics of Residual Current Devices	110
Residual Current Devices PF7	113
Residual Current Devices dRCM Digital	115
Residual Current Relays PFR, Core Balance Transformers Z-WFR	117
Residual Current Devices PHF7	119
Residual Current Devices PFDM	121
Residual Current Devices PF6	122
PDIM Leakage Current Monitor	126
Add-on Residual Current Protection Unit PBHT	125
Combined RCD/MCB Devices PFL7, 1+N-pole	128
Combined RCD/MCB Devices PFL6, 1+N-pole	132
Combined RCD/MCB Devices mRB6, 3+N-pole	136
Miniature Circuit Breakers PL7	137
Miniature Circuit Breakers PL7-DC	137
Miniature Circuit Breakers PL6	144
Miniature Circuit Breakers PLHT and Accessories	150
Main Switch Disconnecter IS	155
Switch Disconnectors ZP-A	156
Accessories for MCBs and RCDs	158
Other installation devices, relays	169
Impulse Relays Z-S	179
Installation Relays Z-R, Z-TN	189
Installation contactors Z-SCH	191
Digital Timers	200
Measuring Instruments and Accessories	201
Manual Motor Starters Z-MS	213
Busbar Systems	218
Fuse-links and Fuse Disconnectors	224
Circuit Breakers LZM and Switch Disconnectors LN	273
Surge Arresters	276
Photovoltaic - Inverter	297

Pictures used inside of this catalogue are illustrative, they need not to correspond to actual product version.

Explanatory notes to used marking

New item 

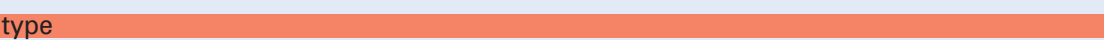
Phase-out type 

Change in type designation or in article number 

Residual current devices PF7

- A complete spectrum of compact residual current devices up to 100 A
- Rated short circuit strength 10 kA
- Especially for protection against accidents caused by current and property protection
- Wide variety of types (G, S, A, G/A, S/A, R, U, ...)
- Special type U for frequency converter applications with high surge current proof
- Accessories suitable for subsequent installation
-  Frost resistance

SG 05506



Residual Current Devices PF7

- Can be used as an additional protection against dangerous contact with live parts ($I_{\Delta n} \leq 30 \text{ mA}$), as a protection against dangerous contact with exposed conductive parts ($I_{\Delta n} > 30 \text{ mA}$) or as a fire protection ($I_{\Delta n} \leq 300 \text{ mA}$)
- Rated short circuit strength 10 kA
- Busbar positioning for input optionally above or below
- The device function irrespective of the position of installation
- Contact position indicator red-green
- Twin purpose terminal (lift/open – mouthed) above or below
- Free terminal space despite installed busbar
- 4-pole device can also be used for 2-pole or 3-pole connection
- Test key "T" must be pressed once a month
- Additional protection against overload must be used for devices with rated current 80 A and 100 A
- Terminal capacity 1.5 – 35 mm²

Surge current proof 250 A



- Type AC – sensitive to residual AC
- Without time delay – surge current-proof 250 A

$I_n/I_{\Delta n}$ [A]	Type Designation	Article No.	Units per package
2-pole			
25/0.03	PF7-25/2/003	263577	1/60
25/0.10	PF7-25/2/01	263578	1/60
40/0.03	PF7-40/2/003	263579	1/60
40/0.10	PF7-40/2/01	263580	1/60
63/0.03	PF7-63/2/003	263581	1/60
63/0.10	PF7-63/2/01	263582	1/60
63/0.30	PF7-63/2/03	263583	1/60

sg 05406



4-pole			
25/0.03	PF7-25/4/003	263584	1/30
25/0.10	PF7-25/4/01	263585	1/30
40/0.03	PF7-40/4/003	263586	1/30
40/0.10	PF7-40/4/01	263587	1/30
40/0.30	PF7-40/4/03	263588	1/30
40/0.50	PF7-40/4/05	263589	1/30
63/0.03	PF7-63/4/003	263590	1/30
63/0.10	PF7-63/4/01	263591	1/30
63/0.30	PF7-63/4/03	263592	1/30
63/0.50	PF7-63/4/05	263593	1/30
80/0.03	PF7-80/4/003	263594	1/30
80/0.10	PF7-80/4/01	263595	1/30
80/0.30	PF7-80/4/03	263596	1/30
80/0.50	PF7-80/4/05	263597	1/30
100/0.03	PF7-100/4/003	102925	1/30
100/0.10	PF7-100/4/01	102926	1/30
100/0.30	PF7-100/4/03	102927	1/30
100/0.50	PF7-100/4/05	102928	1/30

SG05506



Surge current proof 250 A, sensitive also to pulsating DC



- Type A – sensitive to residual AC and residual pulsating DC
- Without time delay – surge current-proof 250 A

$I_n/I_{\Delta n}$ [A]	Type Designation	Article No.	Units per package
2-pole			
16/0.01	PF7-16/2/001-A	263598	1/60
25/0.03	PF7-25/2/003-A	263599	1/60
25/0.10	PF7-25/2/01-A	263600	1/60
25/0.30	PF7-25/2/03-A	263601	1/60
40/0.03	PF7-40/2/003-A	263602	1/60
40/0.10	PF7-40/2/01-A	263603	1/60
40/0.30	PF7-40/2/03-A	263604	1/60
63/0.03	PF7-63/2/003-A	263605	1/60
63/0.10	PF7-63/2/01-A	263606	1/60
63/0.30	PF7-63/2/03-A	263607	1/60

sg 05406



SG05506



4-pole

25/0.03	PF7-25/4/003-A	263608	1/30
25/0.10	PF7-25/4/01-A	263609	1/30
25/0.30	PF7-25/4/03-A	263610	1/30
40/0.03	PF7-40/4/003-A	263611	1/30
40/0.10	PF7-40/4/01-A	263612	1/30
40/0.30	PF7-40/4/03-A	263613	1/30
63/0.03	PF7-63/4/003-A	263614	1/30
63/0.10	PF7-63/4/01-A	263615	1/30
63/0.30	PF7-63/4/03-A	263616	1/30
80/0.03	PF7-80/4/003-A	263617	1/30
80/0.30	PF7-80/4/03-A	263618	1/30
100/0.03	PF7-100/4/003-A	102929	1/30
100/0.10	PF7-100/4/01-A	102930	1/30
100/0.30	PF7-100/4/03-A	102931	1/30
100/0.50	PF7-100/4/05-A	102932	1/30

Surge current-proof 3 kA, type G



- Type AC – sensitive to residual AC
- G with time delay – surge current-proof 3 kA

$I_n/I_{\Delta n}$ [A]	Type Designation	Article No.	Units per package
------------------------	------------------	-------------	-------------------

2-pole

25/0.03	PF7-25/2/003-G	263619	1/60
25/0.10	PF7-25/2/01-G	263620	1/60
40/0.03	PF7-40/2/003-G	263621	1/60
40/0.10	PF7-40/2/01-G	263622	1/60

sg 05406



4-pole

40/0.03	PF7-40/4/003-G	263623	1/30
40/0.10	PF7-40/4/01-G	263624	1/30
63/0.03	PF7-63/4/003-G	263625	1/30
63/0.10	PF7-63/4/01-G	263627	1/30

SG05506



Surge current-proof 3 kA, for x-rays – R



- Type A – sensitive to residual AC and residual pulsating DC
- R – for x-rays – surge current-proof 3 kA

$I_n/I_{\Delta n}$ [A]	Type Designation	Article No.	Units per package
------------------------	------------------	-------------	-------------------

4-pole

63/0.03	PF7-63/4/003-R	263628	1/30
100/0.03	PF7-100/4/003-R	102935	1/30

SG05506



sg 05406



Selective, surge current-proof 5 kA, type S



- Type AC – sensitive to residual AC
- S selective with time delay – surge currentproof 5 kA

$I_n/I_{\Delta n}$ [A]	Type Designation	Article No.	Units per package
2-pole			
40/0.10	PF7-40/2/01-S	263629	1/60
40/0.30	PF7-40/2/03-S	263630	1/60
4-pole			
80/0.10	PF7-80/4/01-S	263636	1/30

SG05506



Selective, surge current-proof 5 kA, sensitive also to pulsating DC



- Type A – sensitive to residual AC and residual AC and residual pulsating DC
- S selective with time delay – surge currentproof 5 kA

$I_n/I_{\Delta n}$ [A]	Type Designation	Article No.	Units per package
4-pole			
25/0.10	PF7-25/4/01-S/A	263631	1/30
40/0.10	PF7-40/4/01-S/A	263632	1/30
40/0.30	PF7-40/4/03-S/A	263633	1/30
63/0.10	PF7-63/4/01-S/A	263634	1/30
63/0.30	PF7-63/4/03-S/A	263635	1/30
80/0.30	PF7-80/4/03-S/A	263637	1/30
100/0.30	PF7-100/4/03-S/A	292494	1/30

SG05506



Selective, surge current-proof 5 kA, frequency converter-proof, type U



- Type A – sensitive to residual AC and residual pulsating DC
- U – for frequency converter applications
- S selective with time delay – surge currentproof 5 kA

$I_n/I_{\Delta n}$ [A]	Type Designation	Article No.	Units per package
4-pole			
40/0.10	PF7-40/4/01-U	263638	1/30
40/0.30	PF7-40/4/03-U	263639	1/30
63/0.10	PF7-63/4/01-U	263640	1/30
63/0.30	PF7-63/4/03-U	263641	1/30
80/0.30	PF7-80/4/03-U	292495	1/30
100/0.30	PF7-100/4/03-U	292496	1/30

Compact residual current devices type U – see page 12.

Sealing Cover Set Z-RC/AK

- For PF7, PFR (not to use for PFDM)

	Type Designation	Article No.	Units per package
for 2-pole	Z-RC/AK-2TE	285385	10/30
for 4-pole	Z-RC/AK-4TE	101062	10/600

Z-HWS



Notification label Z-HWS-FI

- Notification of operator of responsibility to check functionality of residual current devices regularly (once a month)
- Languages: D, E, I, F, CZ, RUS, PL, H

	Type Designation	Article No.	Units per package
Notification label	Z-HWS-FI	236980	100

Residual Current Devices dRCM

Digital

- Line voltage independent RCCB for fault or additional protection with additional digital features.
- Rated short circuit strength 10 kA
- System Monitoring: Preventive information / warning before the RCD trips in case of leakage currents.
 - Integrated auxiliary contact
 - Local Indication
- New level of accuracy -> Reduced unwanted tripping
- No monthly test required
- Contact position indicator
- Fault current tripping indicator
- Transparent designation plate
- Accessories suitable for subsequent installation
-  Frost resistance

SG01509



Residual Current Devices dRCM

- Can be used as an additional protection against dangerous contact with live parts ($I_{\Delta n} \leq 30$ mA), as a protection against dangerous contact with exposed conductive parts ($I_{\Delta n} > 30$ mA) or as a fire protection ($I_{\Delta n} \leq 300$ mA)
- Rated short circuit strength 10 kA
- Busbar positioning for input optionally above or below
- The device function irrespective of the position of installation
- Protection functions voltage independent
- Contact position indicator red-green
- Fault current tripping indicator (blue / white)
- Twin purpose terminal (lift/open – mouthed) above or below
- Free terminal space despite installed busbar
- 4-pole device can also be used for 2-pole or 3-pole connection
- Test key "T" must be pressed once a month
- Integrated overload protection
- Terminal capacity 1.5 – 35 mm²

Surge current-proof 3 kA



- Type A – sensitive to residual AC and residual pulsating DC
- G with time delay 10 ms – surge current-proof 3 kA

SG01509



$I_n/I_{\Delta n}$ [A]	Type Designation	Article No.	Units per package
4-pole			
25/0.03	dRCM-25/4/003-G/A+	120834	1/30
25/0.30	dRCM-25/4/03-G/A+	120835	1/30
40/0.03	dRCM-40/4/003-G/A+	120836	1/30
40/0.30	dRCM-40/4/03-G/A+	120837	1/30
63/0.03	dRCM-63/4/003-G/A+	120838	1/30
63/0.30	dRCM-63/4/03-G/A+	120839	1/30
80/0.03	dRCM-80/4/003-G/A+	120840	1/30
80/0.30	dRCM-80/4/03-G/A+	120841	1/30

Surge current-proof 3 kA, X-ray application, type R



- Type A – sensitive to residual AC and residual pulsating DC
- X-ray application, type R – surge current-proof 3 kA

$I_n/I_{\Delta n}$ [A]	Type Designation	Article No.	Units per package
4-pole			
63/0.03	dRCM-63/4/003-R+	120842	1/30

Selective + surge current-proof typ. 5 kA, sensitive to residual pulsating DC, type S/A



- Type A – sensitive to residual AC and residual pulsating DC
- S with time delay 40 ms – surge current-proof 5 kA

$I_n/I_{\Delta n}$ [A]	Type Designation	Article No.	Units per package
4-pole			
40/0.30	dRCM-40/4/03-S/A+	120843	1/30
63/0.30	dRCM-63/4/03-S/A+	120844	1/30
80/0.30	dRCM-80/4/03-S/A+	120845	1/30

Frequency converter-proof, type U



- Type A – sensitive to residual AC and residual pulsating DC
- Version with residual current 300 mA – S selective with initial insensitiveness 40 ms – surge current-proof typ. 5 kA
- Version with residual current 30 mA – G with initial insensitiveness 10 ms – surge current proof 3 kA

$I_n/I_{\Delta n}$ [A]	Type Designation	Article No.	Units per package
4-pole			
40/0.03	dRCM-40/4/003-U+	120850	1/30
40/0.3	dRCM-40/4/03-U+	120851	1/30
63/0.03	dRCM-63/4/003-U+	120846	1/30
63/0.3	dRCM-63/4/03-U+	120847	1/30
80/0.3	dRCM-80/4/03-U+	120848	1/30

Residual Current Relays PFR Core Balance Transformers Z-WFR

- Especially matched residual current relays and core balance transformers intended for RCD set with indirect releasing
- Rated current up to 400 A
- Rated residual/fault currents 0.3 A and 1 A
- Standard S/A for usual installations
- Type U – frequency converter-proof
-  Frost resistance

SG05606



420801f



Residual Current Relays PFR

- Can be used as an additional protection against dangerous contact with exposed conductive parts ($I_{\Delta n} > 30 \text{ mA}$) or as a fire protection ($I_{\Delta n} \leq 300 \text{ mA}$)
- Contact position indicator red-green
- A pair of NC contacts
- Rated current of relay contacts 25 A / 400 V DC, 16 A / 230 V AC

Selective, surge current-proof 5 kA, sensitive also to residual pulsating DC, type S/A

- Type A – sensitive to residual AC and residual pulsating DC
- S selective with time delay – surge currentproof 5 kA
- PFR2-..-S/A can be combined only with Z-WFR 2-S/A
- PFR3-..-S/A can be combined only with Z-WFR 3-S/A

SG05606



$I_{\Delta n}$ [A]	Type Designation	Article No.	Units per package
0.30	PFR2-03-S/A	235864	1/30
0.30	PFR3-03-S/A	235865	1/30
1.0	PFR2-1-S/A	235866	1/30
1.0	PFR3-1-S/A	235867	1/30

Core Balance Transformers Z-WFR for PFR-S/A

420801



Maximum cable lead-through diameter	Type Designation	Article No.	Units per package
60 mm	Z-WFR 2-S/A	236981	1
130 mm	Z-WFR 3-S/A	236982	1

Selective, surge current-proof 5 kA, frequency converter-proof, type U

- Type A – sensitive to residual AC and residual pulsating DC
- U – for frequency converter applications
- S selective with time delay – surge current-proof 5 kA
- PFR2-..-U can be combined only with Z-WFR 2-U
- PFR3-..-U can be combined only with Z-WFR 3-U

SG05606



$I_{\Delta n}$ [A]	Type Designation	Article No.	Units per package
0.30	PFR2-03-U	235868	1/30
0.30	PFR3-03-U	235869	1/30
1.0	PFR2-1-U	235870	1/30
1.0	PFR3-1-U	235871	1/30

Core Balance Transformers Z-WFR for PRF-U

420801



Maximum cable lead-through diameter	Type Designation	Article No.	Units per package
60 mm	Z-WFR 2-U	104386	1
130 mm	Z-WFR 3-U	104387	1

Residual Current Devices PHF7

- Residual current devices with high operational reliability
- High reliability against unwanted tripping – type G, S, G/A
- Regular monthly testing of the device functionality is not necessary
- Integrated overload protection
-  Frost resistance

SG5602



Residual Current Devices PHF7

- Can be used as an additional protection against dangerous contact with live parts ($I_{\Delta n} \leq 30$ mA), as a protection against dangerous contact with exposed conductive parts ($I_{\Delta n} > 30$ mA) or as a fire protection ($I_{\Delta n} \leq 300$ mA)
- Rated short circuit strength 10 kA
- Integrated overload protection
- High reliability – testing of device need not be proven every month
- Test key "T" must be pressed once a year
- Busbar positioning optionally above or below
- The device function irrespective of the position of installation
- Contact position indicator red-green
- Twin purpose terminal (lift/open – mouthed) above or below
- Free terminal space despite installed busbar

SG5502



Surge current-proof 3 kA, type G



- Type AC – sensitive to residual AC
- G with time delay – surge current-proof 3 kA

$I_n/I_{\Delta n}$ [A]	Type Designation	Article No.	Units per package
2-pole			
25/0.03	PHF7-25/2/003-G	263642	1/60
40/0.03	PHF7-40/2/003-G	263643	1/60

SG5602



4-pole

25/0.03	PHF7-25/4/003-G	263644	1/30
40/0.03	PHF7-40/4/003-G	263645	1/30
63/0.03	PHF7-63/4/003-G	263646	1/30

SG20902



Surge current-proof 3 kA, sensitive also to residual pulsating DC, type G/A



- Type A – sensitive to residual AC and residual pulsating DC
- G with time delay – surge current-proof 3 kA

$I_n/I_{\Delta n}$ [A]	Type Designation	Article No.	Units per package
4-pole			
40/0.03	PHF7-40/4/003-G/A	263647	1/30
63/0.03	PHF7-63/4/003-G/A	263648	1/30

SG21002



Surge current-proof 5 kA, type S



- Type AC – sensitive to residual AC
- S selective with time delay – surge current-proof 5 kA

$I_n/I_{\Delta n}$ [A]	Type Designation	Article No.	Units per package
4-pole			
40/0.10	PHF7-40/4/01-S	263649	1/30
40/0.30	PHF7-40/4/03-S	263650	1/30
63/0.10	PHF7-63/4/01-S	263651	1/30
63/0.30	PHF7-63/4/03-S	263652	1/30

Residual Current Devices PFDM

- Residual current devices PFDM for the 125 A rated current range
- Suitable also for additional protection against dangerous contact with live parts
- Auxiliary contact for subsequent installation
- Special devices for variety of applications – types AC, A, and S/A
-  Frost resistance

SG0802



Residual Current Devices PFDM

- Can be used as an additional protection against dangerous contact with live parts ($I_{\Delta n} \leq 30 \text{ mA}$), as a protection against dangerous contact with exposed conductive parts ($I_{\Delta n} > 30 \text{ mA}$) or as a fire protection ($I_{\Delta n} \leq 300 \text{ mA}$)
- Rated short circuit strength 10 kA
- Busbar positioning optionally above or below
- The device function irrespective of the position of installation
- Contact position indicator red-green
- Twin-purpose terminal (lift/open – mouthed) above and below
- Free terminal space despite installed busbar
- Test key "T" must be pressed once a month
- Terminal capacity 1.5–50 mm²



SG0802



Conditionally surge current-proof (0.5 μs / 100 kHz)

- Type AC – sensitive to residual AC
- Without time delay

$I_n/I_{\Delta n}$ [A]	Type Designation	Article No.	Units per package
4-pole			
125/0.03	PFDM-125/4/003	235916	1/30
125/0.10	PFDM-125/4/01	235917	1/30
125/0.30	PFDM-125/4/03	235918	1/30
125/0.50	PFDM-125/4/05	235919	1/30

- Type A – sensitive to residual AC and residual pulsating DC
- Without time delay



$I_n/I_{\Delta n}$ [A]	Type Designation	Article No.	Units per package
4-pole			
125/0.03	PFDM-125/4/003-A	235920	1/30
125/0.10	PFDM-125/4/01-A	235921	1/30
125/0.30	PFDM-125/4/03-A	235922	1/30
125/0.50	PFDM-125/4/05-A	235923	1/30

- Type S/A – sensitive to residual AC and residual pulsating DC
- Selective – with time delay 40 ms



$I_n/I_{\Delta n}$ [A]	Type Designation	Article No.	Units per package
4-pole			
125/0.30	PFDM-125/4/03-S/A	285639	1/30

Accessories for protective devices PFDM

Description	Contacts	Type Designation	Article No.	Units per package
Auxiliary contacts 6 A (AC11) 230 V AC	1 NO + 1 NC	Z-HD	265620	1

Connection diagram

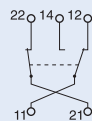

Residual Current Devices PF6

- Economy series of RCD
- Rated short circuit strength 6 kA
- For fault current/residual current protection and additional protection
- Accessories suitable for subsequent installation
-  Frost resistance

SG05506



Residual Current Devices PF6

- Can be used as an additional protection against dangerous contact with live parts ($I_{\Delta n} \leq 30$ mA), as a protection against dangerous contact with exposed conductive parts ($I_{\Delta n} > 30$ mA) or as a fire protection ($I_{\Delta n} \leq 300$ mA)
- Rated short circuit strength 6 kA
- Busbar positioning optionally above or below
- The device function irrespective of the position of installation
- Contact position indicator red-green
- Twin-purpose terminal (lift/open – mouthed) above and below
- Possibility of using of busbar
- 4-pole device can also be used for 2-pole or 3-pole connection
- Test key "T" must be pressed once a month
- Terminal capacity 1.5–35 mm²

Surge current-proof 250 A



- Type AC – sensitive to residual AC
- Without time delay – surge current-proof 250 A

$I_n/I_{\Delta n}$ [A]	Type Designation	Article No.	Units per package
2-pole			
25/0.03	PF6-25/2/003	286492	1/60
40/0.03	PF6-40/2/003	286496	1/60
40/0.30	PF6-40/2/03	286498	1/60
4-pole			
25/0.03	PF6-25/4/003	286504	1/30
40/0.03	PF6-40/4/003	286508	1/30
40/0.30	PF6-40/4/03	286510	1/30
63/0.03	PF6-63/4/003	286512	1/30
63/0.30	PF6-63/4/03	286514	1/30

SG05406



SG 05506



PDIM Leakage Current Monitor

- Reliable, universal monitoring of residual current - EN 62020
- Without main contacts
- Conditional rated short circuit strength 10 kA
- Rated residual current adjustable in steps 30, 100, 300, 500 and 1000 mA
- Type A – sensitive to residual AC and residual pulsating DC
- Possibility to set delay: undelayed – delayed G type – selective S type
- Local status indication of residual current through 3 LEDs
- 2 potential-free signalling contacts

SG05807



PDIM Leakage Current Monitor

- Devices for monitoring of residual currents acc. to EN 62020
- Without main contacts
- Conditional rated short circuit strength 10 kA
- Rated residual current adjustable in steps 30, 100, 300, 500 and 1000 mA
- Type A – sensitive to residual AC and residual pulsating DC
- Possibility to set delay: undelayed – delayed G type – selective S type
- Local indication of residual current level with LED
- Remote indication of residual current level with two free-potential auxiliary contacts 10 A / 230 V AC
- Busbar positioning optionally above or below
- The device function irrespective of the position of installation
- Twin purpose terminal (lift/open – mouthed) above or below
- Free terminal space despite installed busbar
- Terminal capacity 1.5–35 mm²

sg05807



$I_n/I_{\Delta n}$ [A]	Type Designation	Article No.	Units per Package
4-pole			
40/0.03; 0.1; 0.3; 0.5; 1	PDIM-40/4	111760	1/30
100/0.03; 0.1; 0.3; 0.5; 1	PDIM-100/4	111761	1/30

Add-on Residual Current Protection Unit PBHT

- For combination with miniature circuit breaker PLHT
- Add-on residual current unit (screw connection)
- 4-pole
- High flexibility and ease of installation thanks to variable wiring
- Auxiliary switch 1 NO contact included as standard in all PBHT versions
- The screw connection to the PLHT-device can be unscrewed at any time. Consequently, in case of modifications of the systems to be protected, the installation can be adapted to new requirements at any time.
- Permits combinations with a variety of characteristics thanks to the different rated currents and characteristics of the miniature circuit breakers PLHT which can be connected

SG6002



Add-on Residual Current Protection UNIT PBHT

- For mounting onto PLHT MCBs
- Rated conditional short circuit strength PBHT + PLHT given by PLHT (15–25 kA)
- Build-in auxiliary NO switch
- Wires for connection with PLHT as well as mounting screws are included in standard delivery
- 4-pole

- Type A sensitive to residual AC and pulsating residual DC
- Surge current-proof 250 A

SG6002



$I_n/I_{\Delta n}$ [A]	Type Designation	Article No.	Units per package
80/0.03	PBHT-80/4/003-A	248827	1/4
80/0.30	PBHT-80/4/03-A	248829	1/4
80/0.50	PBHT-80/4/05-A	248832	1/4
80/1.00	PBHT-80/4/1-A	248835	1/4
125/0.03	PBHT-125/4/003-A	248808	1/4
125/0.30	PBHT-125/4/03-A	248810	1/4
125/0.50	PBHT-125/4/05-A	248813	1/4
125/1.00	PBHT-125/4/1-A	248816	1/4

- Type A sensitive to residual AC and pulsating residual DC
- S selective with time delay – surge currentproof 5 kA

SG6002



$I_n/I_{\Delta n}$ [A]	Type Designation	Article No.	Units per package
80/0.30	PBHT-80/4/03-S/A	248830	1/4
80/0.50	PBHT-80/4/05-S/A	248833	1/4
80/1.00	PBHT-80/4/1-S/A	248836	1/4
125/0.30	PBHT-125/4/03-S/A	248811	1/4
125/0.50	PBHT-125/4/05-S/A	248814	1/4
125/1.00	PBHT-125/4/1-S/A	248817	1/4

Technical information p. 125

Shunt trip release for residual protection unit PBHT

Operational voltage range	Type Designation	Article No.	Units per package
110–415 V AC / 110–230 V DC	Z-BHASA/230	248445	8
12–60 V AC/DC	Z-BHASA/24	248444	8

SG9998



Technical information p. 127

Combined RCD/MCB Devices PFL7, 1+N-pole

- Residual current device / miniature circuit breaker combination
- Tripping characteristics of MCB B, C
- Rated breaking capacity 10 kA
- Rated currents up to 40 A
- Contact position indicator red-green
- Guide for secure terminal connection
- 3-position DIN rail clip, permits removal from existing busbar system
- Accessories suitable for subsequent installation
-  Frost resistance

SG4202



Combined RCD/MCB Devices PFL7

- Can be used as an additional protection against dangerous contact with live parts ($I_{\Delta n} \leq 30 \text{ mA}$)
- Rated breaking capacity 10 kA
- Busbar positioning optionally above or below
- The device function irrespective of the position of installation
- Contact position indicator red-green
- Twin-purpose terminal (lift/open – mouthed) above and below
- Free terminal space despite installed busbar
- Test key "T" must be pressed once a month
- Terminal capacity 1–25 mm²

Surge current-proof 250 A

Rated breaking capacity of MCB 10 kA, 1+N-pole

- Type AC – sensitive to residual AC
- Without time delay – surge current-proof 250 A

$I_n/I_{\Delta n}$ [A]	Type Designation	Article No.	Units per package
Characteristic B			
6/0.03	PFL7-6/1N/B/003	263430	1/60
10/0.03	PFL7-10/1N/B/003	263434	1/60
13/0.03	PFL7-13/1N/B/003	263518	1/60
16/0.03	PFL7-16/1N/B/003	263534	1/60
20/0.03	PFL7-20/1N/B/003	263540	1/60
25/0.03	PFL7-25/1N/B/003	263546	1/60
32/0.03	PFL7-32/1N/B/003	263552	1/60
40/0.03	PFL7-40/1N/B/003	263558	1/60

Characteristic C

6/0.03	PFL7-6/1N/C/003	263432	1/60
10/0.03	PFL7-10/1N/C/003	263516	1/60
13/0.03	PFL7-13/1N/C/003	263531	1/60
16/0.03	PFL7-16/1N/C/003	263537	1/60
20/0.03	PFL7-20/1N/C/003	263543	1/60
25/0.03	PFL7-25/1N/C/003	263549	1/60
32/0.03	PFL7-32/1N/C/003	263555	1/60
40/0.03	PFL7-40/1N/C/003	263561	1/60

SG4202



Surge current-proof 250 A, sensitive also to residual pulsating DC

Rated breaking capacity of MCB 10 kA, 1+N-pole

- Type A – sensitive to residual AC and residual pulsating DC
- Without time delay – surge current-proof 250 A

$I_n/I_{\Delta n}$ [A]	Type Designation	Article No.	Units per package
Characteristic B			
6/0.03	PFL7-6/1N/B/003-A	263431	1/60
10/0.03	PFL7-10/1N/B/003-A	263435	1/60
13/0.03	PFL7-13/1N/B/003-A	263519	1/60
16/0.03	PFL7-16/1N/B/003-A	263535	1/60

Characteristic C

6/0.03	PFL7-6/1N/C/003-A	263515	1/60
10/0.03	PFL7-10/1N/C/003-A	263517	1/60
13/0.03	PFL7-13/1N/C/003-A	263532	1/60
16/0.03	PFL7-16/1N/C/003-A	263538	1/60

SG4202



Surge current-proof 3 kA, type G ☒

Rated breaking capacity of MCB 10 kA, 1+N-pole

- Type AC – sensitive to residual AC
- Type G with time delay min. 10 ms – surge current-proof 3 kA

$I_n/I_{\Delta n}$ [A]	Type Designation	Article No.	Units per package
Characteristic B			
13/0.03	PFL7-13/1N/B/003-G	263530	1/60
16/0.03	PFL7-16/1N/B/003-G	263536	1/60
20/0.03	PFL7-20/1N/B/003-G	263542	1/60
25/0.03	PFL7-25/1N/B/003-G	263548	1/60

Characteristic C			
13/0.03	PFL7-13/1N/C/003-G	263533	1/60
16/0.03	PFL7-16/1N/C/003-G	263539	1/60
20/0.03	PFL7-20/1N/C/003-G	263545	1/60
25/0.03	PFL7-25/1N/C/003-G	263551	1/60

SG4202



Combined RCD/MCB Devices PFL6, 1+N-pole

- Economy series mainly for house installations
- Residual current device / miniature circuit breaker combination
- Tripping characteristics of MCB B, C
- Rated breaking capacity 6 kA
- Rated residual current 30 mA
- Contact position indicator red-green
- Accessories suitable for subsequent installation
-  Frost resistance

wa_sg16604



Combined RCD/MCB Devices PFL6

- Can be used as an additional protection against dangerous contact with live parts ($I_{\Delta n} \leq 30 \text{ mA}$)
- Rated breaking capacity 6 kA
- Busbar positioning optionally above or below
- The device function irrespective of the position of installation
- Contact position indicator red-green
- Twin-purpose terminal (lift/open – mouthed) above and below
- Possibility to use busbar
- Test key "T" must be pressed once a month
- Terminal capacity 1–25 mm²

Surge current-proof 250 A

Rated breaking capacity of MCB 6 kA, 1+N-pole

- Type AC – sensitive to residual AC
- Without time delay – surge current-proof 250 A

wa_sg16604



wa_sg16604



$I_n/I_{\Delta n}$ [A]	Type Designation	Article No.	Units per package
Characteristic B			
6/0.03	PFL6-6/1N/B/003	286428	1/60
10/0.03	PFL6-10/1N/B/003	286429	1/60
13/0.03	PFL6-13/1N/B/003	286430	1/60
16/0.03	PFL6-16/1N/B/003	286431	1/60
20/0.03	PFL6-20/1N/B/003	286432	1/60
25/0.03	PFL6-25/1N/B/003	286433	1/60
Characteristic C			
6/0.03	PFL6-6/1N/C/003	286464	1/60
10/0.03	PFL6-10/1N/C/003	286465	1/60
13/0.03	PFL6-13/1N/C/003	286466	1/60
16/0.03	PFL6-16/1N/C/003	286467	1/60
20/0.03	PFL6-20/1N/C/003	286468	1/60
25/0.03	PFL6-25/1N/C/003	286469	1/60

Combined RCD/MCB Devices mRB6, 3+N-pole

- Residual current device / miniature circuit breaker combination
- Tripping characteristics of MCB B, C, D
- Rated breaking capacity 6 kA
- Rated currents up to 16 A
- Contact position indicator red-green
- Tripping indicator white - blue
- Guide for secure terminal connection
- 3-position DIN rail clip, permits removal from existing busbar system
- Accessories suitable for subsequent installation
- Suitable mainly for applications with high demand on installation-space savings, e.g. industrial ones (machinery installations, ...)

sg12309



Combined RCD/MCB Devices mRB6



- Can be used as an additional protection against dangerous contact with live parts ($I_{\Delta n} \leq 30 \text{ mA}$), as a protection against dangerous contact with exposed conductive parts ($I_{\Delta n} > 30 \text{ mA}$) or as a fire protection ($I_{\Delta n} \leq 300 \text{ mA}$)
- Rated breaking capacity 6 kA
- Busbar positioning optionally above or below
- Contact position indicator red-green
- Tripping indicator white - blue
- Twin-purpose terminal (lift/open - mouthed) above and below
- Free terminal space despite installed busbar
- Test key "T" must be pressed once a month
- Terminal capacity 1-25 mm²

Conditionally surge current-proof 250 A

- Type A – sensitive to residual AC and residual pulsating DC
- Without time delay – surge current-proof 250 A

sg12309



$I_n/I_{\Delta n}$ [A]	Type Designation	Article No.	Units per package
Characteristic B			
13/0.03	mRB6-13/3N/B/003-A	120651	1/30
13/0.1	mRB6-13/3N/B/01-A	120653	1/30
13/0.3	mRB6-13/3N/B/03-A	120655	1/30
16/0.03	mRB6-16/3N/B/003-A	120652	1/30
16/0.1	mRB6-16/3N/B/01-A	120654	1/30
16/0.3	mRB6-16/3N/B/03-A	120656	1/30
Characteristic C			
6/0.03	mRB6-6/3N/C/003-A	120657	1/30
6/0.1	mRB6-6/3N/C/01-A	120661	1/30
6/0.3	mRB6-6/3N/C/03-A	120665	1/30
10/0.03	mRB6-10/3N/C/003-A	120658	1/30
10/0.1	mRB6-10/3N/C/01-A	120662	1/30
10/0.3	mRB6-10/3N/C/03-A	120666	1/30
13/0.03	mRB6-13/3N/C/003-A	120659	1/30
13/0.1	mRB6-13/3N/C/01-A	120663	1/30
13/0.3	mRB6-13/3N/C/03-A	120667	1/30
16/0.03	mRB6-16/3N/C/003-A	120660	1/30
16/0.1	mRB6-16/3N/C/01-A	120664	1/30
16/0.3	mRB6-16/3N/C/03-A	120668	1/30
Characteristic D			
6/0.03	mRB6-6/3N/D/003-A	120669	1/30
6/0.1	mRB6-6/3N/D/01-A	120673	1/30
10/0.03	mRB6-10/3N/D/003-A	120670	1/30
10/0.1	mRB6-10/3N/D/01-A	120674	1/30
13/0.03	mRB6-13/3N/D/003-A	120671	1/30
13/0.1	mRB6-13/3N/D/01-A	120675	1/30
16/0.03	mRB6-16/3N/D/003-A	120672	1/30
16/0.1	mRB6-16/3N/D/01-A	120676	1/30

Miniature Circuit Breakers PL7

- MCB for protection against overload and short circuit current in installations
- Tripping characteristics B, C, D
- Rated breaking capacity 10 kA
- Rated currents up to 63 A
- Contact position indicator red-green
- Guide for secure terminal connection
- 3-position DIN rail clip, permits removal from existing busbar system
- Accessories suitable for subsequent installation

wa_sg00808



Miniature Circuit Breakers PL7

- Rated voltage 230/400V AC; 48 V DC
- Selectivity class 3 – high capacity to limit short circuit currents
- Maximum back-up fuse 125 A gL
- Degree of protection IP20
- Contact position indicator red-green
- Terminal capacity 1–25 mm²
- Accessories suitable for subsequent installation
- The device function irrespective of the position of installation

Characteristic B, rated breaking capacity 10 kA

- For socket and light applications with low surge currents

Rated Current I _n [A]	Type Designation	Article No.	Units per package
1-pole			
2	PL7-B2/1	264839	12/120
4	PL7-B4/1	264850	12/120
6	PL7-B6/1	262673	12/120
10	PL7-B10/1	262674	12/120
13	PL7-B13/1	262675	12/120
16	PL7-B16/1	262676	12/120
20	PL7-B20/1	262677	12/120
25	PL7-B25/1	262678	12/120
32	PL7-B32/1	262679	12/120
40	PL7-B40/1	262690	12/120
50	PL7-B50/1	262691	12/120
63	PL7-B63/1	262692	12/120

wa_sg00608



wa_sg01108



1+N-pole 1.5 MU			
6	PL7-B6/1N	262727	8/80
10	PL7-B10/1N	262728	8/80
13	PL7-B13/1N	262729	8/80
16	PL7-B16/1N	262740	8/80
20	PL7-B20/1N	262741	8/80
25	PL7-B25/1N	262742	8/80
32	PL7-B32/1N	262743	8/80

wa_sg00708



2-pole 2 MU			
6	PL7-B6/2	262761	6/60
10	PL7-B10/2	262762	6/60
13	PL7-B13/2	262764	6/60
16	PL7-B16/2	262765	6/60
20	PL7-B20/2	262766	6/60
25	PL7-B25/2	262767	6/60
32	PL7-B32/2	262768	6/60
40	PL7-B40/2	262769	6/60
50	PL7-B50/2	263350	6/60
63	PL7-B63/2	263351	6/60

wa_sg00808



3-pole			
6	PL7-B6/3	263386	4/40
10	PL7-B10/3	263387	4/40
13	PL7-B13/3	263388	4/40
16	PL7-B16/3	263389	4/40
20	PL7-B20/3	263390	4/40
25	PL7-B25/3	263391	4/40
32	PL7-B32/3	263392	4/40
40	PL7-B40/3	263393	4/40
50	PL7-B50/3	263400	4/40
63	PL7-B63/3	263401	4/40

wa_sg01008



3+N-pole 4 MU

6	PL7-B6/3N	263982	3/30
10	PL7-B10/3N	263983	3/30
13	PL7-B13/3N	263984	3/30
16	PL7-B16/3N	263985	3/30
20	PL7-B20/3N	263986	3/30
25	PL7-B25/3N	263987	3/30
32	PL7-B32/3N	263988	3/30
40	PL7-B40/3N	263989	3/30
50	PL7-B50/3N	263990	3/30
63	PL7-B63/3N	263991	3/30

Characteristic C, rated breaking capacity 10 kA

- For applications with motors and applications with higher surge currents

wa_sg00608



Rated Current I_n [A]	Type Designation	Article No.	Units per package
1-pole			
0.16	PL7-C0,16/1	262693	12/120
0.25	PL7-C0,25/1	262694	12/120
0.5	PL7-C0,5/1	262695	12/120
0.75	PL7-C0,75/1	262696	12/120
1	PL7-C1/1	262697	12/120
1.6	PL7-C1,6/1	262698	12/120
2	PL7-C2/1	262699	12/120
4	PL7-C4/1	262700	12/120
6	PL7-C6/1	262701	12/120
10	PL7-C10/1	262702	12/120
13	PL7-C13/1	262703	12/120
16	PL7-C16/1	262704	12/120
20	PL7-C20/1	262705	12/120
25	PL7-C25/1	262706	12/120
32	PL7-C32/1	262707	12/120
40	PL7-C40/1	262708	12/120
50	PL7-C50/1	262709	12/120
63	PL7-C63/1	262710	12/120

wa_sg01108



1+N-pole 1.5 MU

2	PL7-C2/1N	262744	8/80
4	PL7-C4/1N	262745	8/80
6	PL7-C6/1N	262746	8/80
10	PL7-C10/1N	262747	8/80
13	PL7-C13/1N	262748	8/80
16	PL7-C16/1N	262749	8/80
20	PL7-C20/1N	262750	8/80
25	PL7-C25/1N	262751	8/80
32	PL7-C32/1N	262752	8/80

wa_sg00708



Rated Current I_n [A]	Type Designation	Article No.	Units per package
2-pole			
0.5	PL7-C0,5/2	263352	6/60
1	PL7-C1/2	263353	6/60
2	PL7-C2/2	263354	6/60
4	PL7-C4/2	263355	6/60
6	PL7-C6/2	263356	6/60
10	PL7-C10/2	263357	6/60
13	PL7-C13/2	263358	6/60
16	PL7-C16/2	263359	6/60
20	PL7-C20/2	263360	6/60
25	PL7-C25/2	263361	6/60
32	PL7-C32/2	263362	6/60
40	PL7-C40/2	263363	6/60
50	PL7-C50/2	263364	6/60
63	PL7-C63/2	263365	6/60

wa_sg00808



3-pole			
0.5	PL7-C0,5/3	263402	4/40
1	PL7-C1/3	263403	4/40
2	PL7-C2/3	263404	4/40
4	PL7-C4/3	263405	4/40
6	PL7-C6/3	263406	4/40
10	PL7-C10/3	263407	4/40
13	PL7-C13/3	263408	4/40
16	PL7-C16/3	263409	4/40
20	PL7-C20/3	263410	4/40
25	PL7-C25/3	263411	4/40
32	PL7-C32/3	263412	4/40
40	PL7-C40/3	263413	4/40
50	PL7-C50/3	263414	4/40
63	PL7-C63/3	263415	4/40

wa_sg01008



3+N-pole 4 MU			
6	PL7-C6/3N	263992	3/30
10	PL7-C10/3N	263993	3/30
13	PL7-C13/3N	263994	3/30
16	PL7-C16/3N	263995	3/30
20	PL7-C20/3N	263996	3/30
25	PL7-C25/3N	263997	3/30
32	PL7-C32/3N	263998	3/30
40	PL7-C40/3N	263999	3/30
50	PL7-C50/3N	264000	3/30
63	PL7-C63/3N	264001	3/30

Characteristic D, rated breaking capacity 10 kA

• For applications with high surge currents

wa_sg00608



Rated Current I_n [A]	Type Designation	Article No.	Units per package
1-pole			
2	PL7-D2/1	262711	12/120
4	PL7-D4/1	262712	12/120
6	PL7-D6/1	262713	12/120
10	PL7-D10/1	262714	12/120
13	PL7-D13/1	262715	12/120
16	PL7-D16/1	262716	12/120
20	PL7-D20/1	262717	12/120
25	PL7-D25/1	262718	12/120
32	PL7-D32/1	262719	12/120
40	PL7-D40/1	262720	12/120

wa_sg00708



2-pole			
4	PL7-D4/2	263367	6/60
6	PL7-D6/2	263368	6/60
10	PL7-D10/2	263369	6/60
13	PL7-D13/2	263380	6/60
16	PL7-D16/2	263381	6/60
20	PL7-D20/2	263382	6/60
25	PL7-D25/2	263383	6/60
32	PL7-D32/2	263384	6/60
40	PL7-D40/2	263385	6/60

wa_sg00808



3-pole			
6	PL7-D6/3	263418	4/40
10	PL7-D10/3	263419	4/40
13	PL7-D13/3	263420	4/40
16	PL7-D16/3	263421	4/40
20	PL7-D20/3	263422	4/40
25	PL7-D25/3	263423	4/40
32	PL7-D32/3	263424	4/40
40	PL7-D40/3	263425	4/40

wa_sg01008



3+N-pole 4 MU			
6	PL7-D6/3N	264002	3/30
10	PL7-D10/3N	264003	3/30
13	PL7-D13/3N	264004	3/30
16	PL7-D16/3N	264005	3/30
20	PL7-D20/3N	264006	3/30
25	PL7-D25/3N	264007	3/30
32	PL7-D32/3N	264008	3/30
40	PL7-D40/3N	264009	3/30

Miniature Circuit Breakers PL7 – DC for all types of current

Characteristic C, rated breaking capacity 10 kA (EN 60947-2)

- For applications with DC
- Rated voltage 230/400 V AC; 250 V DC
- Take into account polarity!

wa_sg01508



Rated Current I_n [A]	Type Designation	Article No.	Units per package
1-pole			
1	PL7-C1/1-DC	264851	12/120
2	PL7-C2/1-DC	264883	12/120
3	PL7-C3/1-DC	264884	12/120
4	PL7-C4/1-DC	264885	12/120
6	PL7-C6/1-DC	264886	12/120
10	PL7-C10/1-DC	264887	12/120
13	PL7-C13/1-DC	264888	12/120
16	PL7-C16/1-DC	264889	12/120
20	PL7-C20/1-DC	264890	12/120
25	PL7-C25/1-DC	264891	12/120
32	PL7-C32/1-DC	264892	12/120
40	PL7-C40/1-DC	264893	12/120
50	PL7-C50/1-DC	264894	12/120

wa_sg01608



2-pole			
1	PL7-C1/2-DC	264895	6/60
2	PL7-C2/2-DC	264896	6/60
3	PL7-C3/2-DC	264897	6/60
4	PL7-C4/2-DC	264898	6/60
6	PL7-C6/2-DC	264899	6/60
10	PL7-C10/2-DC	264900	6/60
13	PL7-C13/2-DC	264901	6/60
16	PL7-C16/2-DC	264902	6/60
20	PL7-C20/2-DC	264903	6/60
25	PL7-C25/2-DC	264904	6/60
32	PL7-C32/2-DC	264905	6/60
40	PL7-C40/2-DC	264906	6/60
50	PL7-C50/2-DC	264907	6/60

Miniature Circuit Breakers PL6

- Economy series suitable for house installations
- Tripping characteristics B, C, D
- Rated breaking capacity 6 kA
- Rated currents up to 63 A
- Contact position indicator red-green
- Accessories suitable for subsequent installation

wa_sg16804



Miniature Circuit Breakers PL6

- Rated voltage 230/400V AC; 48 V DC
- Selectivity class 3 – high capacity to limit shortcircuit currents
- Maximum back-up fuse 100 A gL
- Degree of protection IP20
- Contact position indicator red-green
- Terminal capacity 1–25 mm²
- The device function irrespective of the position of installation
- Accessories suitable for subsequent installation

Characteristic B, rated breaking capacity 6 kA

- For socket and light applications with low surge currents

wa_sg16704



Rated Current I _n [A]	Type Designation	Article No.	Units per package
1-pole			
2	PL6-B2/1	286516	12/120
4	PL6-B4/1	286517	12/120
6	PL6-B6/1	286518	12/120
10	PL6-B10/1	286519	12/120
13	PL6-B13/1	286520	12/120
16	PL6-B16/1	286521	12/120
20	PL6-B20/1	286522	12/120
25	PL6-B25/1	286523	12/120
32	PL6-B32/1	286524	12/120
40	PL6-B40/1	286525	12/120
50	PL6-B50/1	286526	12/120
63	PL6-B63/1	286527	12/120

wa_sg16504



2-pole			
2	PL6-B2/2	286550	6/60
4	PL6-B4/2	286551	6/60
6	PL6-B6/2	286552	6/60
10	PL6-B10/2	286553	6/60
13	PL6-B13/2	286554	6/60
16	PL6-B16/2	286555	6/60
20	PL6-B20/2	286556	6/60
25	PL6-B25/2	286557	6/60
32	PL6-B32/2	286558	6/60
40	PL6-B40/2	286559	6/60
50	PL6-B50/2	286560	6/60
63	PL6-B63/2	286561	6/60

wa_sg16804



3-pole			
2	PL6-B2/3	286584	4/40
4	PL6-B4/3	286585	4/40
6	PL6-B6/3	286586	4/40
10	PL6-B10/3	286587	4/40
13	PL6-B13/3	286588	4/40
16	PL6-B16/3	286589	4/40
20	PL6-B20/3	286590	4/40
25	PL6-B25/3	286591	4/40
32	PL6-B32/3	286592	4/40
40	PL6-B40/3	286593	4/40
50	PL6-B50/3	286594	4/40
63	PL6-B63/3	286595	4/40

Characteristic C, rated breaking capacity 6 kA

- For applications with motors and applications with higher surge currents

Rated Current I_n [A]	Type Designation	Article No.	Units per package
1-pole			
2	PL6-C2/1	286528	12/120
4	PL6-C4/1	286529	12/120
6	PL6-C6/1	286530	12/120
10	PL6-C10/1	286531	12/120
13	PL6-C13/1	286532	12/120
16	PL6-C16/1	286533	12/120
20	PL6-C20/1	286534	12/120
25	PL6-C25/1	286535	12/120
32	PL6-C32/1	286536	12/120
40	PL6-C40/1	286537	12/120
50	PL6-C50/1	286538	12/120
63	PL6-C63/1	286539	12/120

wa_sg16704



2-pole			
2	PL6-C2/2	286562	6/60
4	PL6-C4/2	286563	6/60
6	PL6-C6/2	286564	6/60
10	PL6-C10/2	286565	6/60
13	PL6-C13/2	286566	6/60
16	PL6-C16/2	286567	6/60
20	PL6-C20/2	286568	6/60
25	PL6-C25/2	286569	6/60
32	PL6-C32/2	286570	6/60
40	PL6-C40/2	286571	6/60
50	PL6-C50/2	286572	6/60
63	PL6-C63/2	286573	6/60

wa_sg16504



3-pole			
2	PL6-C2/3	286596	4/40
4	PL6-C4/3	286597	4/40
6	PL6-C6/3	286598	4/40
10	PL6-C10/3	286599	4/40
13	PL6-C13/3	286600	4/40
16	PL6-C16/3	286601	4/40
20	PL6-C20/3	286602	4/40
25	PL6-C25/3	286603	4/40
32	PL6-C32/3	286604	4/40
40	PL6-C40/3	286605	4/40
50	PL6-C50/3	286606	4/40
63	PL6-C63/3	286607	4/40

wa_sg16804



Characteristic D, rated breaking capacity 6 kA

• For applications with high surge currents

Rated Current I_n [A]	Type Designation	Article No.	Units per package
1-pole			
2	PL6-D2/1	286540	12/120
4	PL6-D4/1	286541	12/120
6	PL6-D6/1	286542	12/120
10	PL6-D10/1	286543	12/120
13	PL6-D13/1	286544	12/120
16	PL6-D16/1	286545	12/120
20	PL6-D20/1	286546	12/120
25	PL6-D25/1	286547	12/120
32	PL6-D32/1	286548	12/120
40	PL6-D40/1	286549	12/120

wa_sg16704



2-pole			
2	PL6-D2/2	286574	6/60
4	PL6-D4/2	286575	6/60
6	PL6-D6/2	286576	6/60
10	PL6-D10/2	286577	6/60
13	PL6-D13/2	286578	6/60
16	PL6-D16/2	286579	6/60
20	PL6-D20/2	286580	6/60
25	PL6-D25/2	286581	6/60
32	PL6-D32/2	286582	6/60
40	PL6-D40/2	286583	6/60

wa_sg16504



3-pole			
2	PL6-D2/3	286608	4/40
4	PL6-D4/3	286609	4/40
6	PL6-D6/3	286610	4/40
10	PL6-D10/3	286611	4/40
13	PL6-D13/3	286612	4/40
16	PL6-D16/3	286613	4/40
20	PL6-D20/3	286614	4/40
25	PL6-D25/3	286615	4/40
32	PL6-D32/3	286616	4/40
40	PL6-D40/3	286617	4/40

wa_sg16804



Miniature Circuit Breakers PLHT and Accessories

- MCBs for higher rated currents suitable also for industrial applications
- Tripping characteristics B, C, D
- Rated breaking capacity from 15 to 25 kA - EN 60947-2
- Rated breaking capacity from 15 to 20 kA - EN 60898-1
- Rated current up to 125 A
- Contact position indicator red-green
- Accessories suitable for subsequent installation
- Mounting onto DIN rail

SG13102



Miniature Circuit Breakers PLHT

- Rated voltage 230/400V AC; 60 V DC
- Selectivity class 3
- Maximum back-up fuse 200 A gL
- Contact position indicator red-green
- Terminal capacity 2.5–50 mm²
- The device function irrespective of the position of installation
- Accessories suitable for subsequent installation

Characteristic B, breaking capacity 15 ... 25 kA (according to rated current)

- For socket and light applications with low surge currents
- Rated breaking capacity for B characteristic:

$I_n = 20-63 \text{ A}$	25 kA
$I_n = 80-100 \text{ A}$	20 kA
$I_n = 125 \text{ A}$	15 kA

Rated Current I_n [A]	Type Designation	Article No.	Units per package
-------------------------	------------------	-------------	-------------------

1-pole 1.5 MU

20	PLHT-B20	247972	12
25	PLHT-B25	247973	12
32	PLHT-B32	247974	12
40	PLHT-B40	247975	12
50	PLHT-B50	247976	12
63	PLHT-B63	247977	12
80	PLHT-B80	247978	12
100	PLHT-B100	247979	12
125	PLHT-B125	247980	12

SG12902



2-pole 3 MU

20	PLHT-B20/2	247998	6
25	PLHT-B25/2	247999	6
32	PLHT-B32/2	248000	6
40	PLHT-B40/2	248001	6
50	PLHT-B50/2	248002	6
63	PLHT-B63/2	248003	6
80	PLHT-B80/2	248004	6
100	PLHT-B100/2	248005	6
125	PLHT-B125/2	248006	6

SG13002



3-pole 4.5 MU

20	PLHT-B20/3	248024	4
25	PLHT-B25/3	248025	4
32	PLHT-B32/3	248026	4
40	PLHT-B40/3	248027	4
50	PLHT-B50/3	248028	4
63	PLHT-B63/3	248029	4
80	PLHT-B80/3	248030	4
100	PLHT-B100/3	248031	4
125	PLHT-B125/3	248032	4

SG13102



3+N-pole 6 MU

20	PLHT-B20/3N	248050	3
25	PLHT-B25/3N	248051	3
32	PLHT-B32/3N	248052	3
40	PLHT-B40/3N	248053	3
50	PLHT-B50/3N	248054	3
63	PLHT-B63/3N	248055	3
80	PLHT-B80/3N	248056	3
100	PLHT-B100/3N	248057	3
125	PLHT-B125/3N	248058	3

SG13202



Characteristic C, breaking capacity 15 ... 25 kA (according to rated current)

• For applications with motors and applications with higher surge currents

• Rated breaking capacity for C characteristic:

$I_n = 20-63 \text{ A}$	25 kA
$I_n = 80-100 \text{ A}$	20 kA
$I_n = 125 \text{ A}$	15 kA

Rated Current I_n [A]	Type Designation	Article No.	Units per package
-------------------------	------------------	-------------	-------------------

SG12902



1-pole 1.5 MU

20	PLHT-C20	247981	12
25	PLHT-C25	247982	12
32	PLHT-C32	247983	12
40	PLHT-C40	247984	12
50	PLHT-C50	247985	12
63	PLHT-C63	247986	12
80	PLHT-C80	247987	12
100	PLHT-C100	247988	12
125	PLHT-C125	247989	12

SG13002



2-pole 3 MU

20	PLHT-C20/2	248007	6
25	PLHT-C25/2	248008	6
32	PLHT-C32/2	248009	6
40	PLHT-C40/2	248010	6
50	PLHT-C50/2	248011	6
63	PLHT-C63/2	248012	6
80	PLHT-C80/2	248013	6
100	PLHT-C100/2	248014	6
125	PLHT-C125/2	248015	6

SG13102



3-pole 4.5 MU

20	PLHT-C20/3	248033	4
25	PLHT-C25/3	248034	4
32	PLHT-C32/3	248035	4
40	PLHT-C40/3	248036	4
50	PLHT-C50/3	248037	4
63	PLHT-C63/3	248038	4
80	PLHT-C80/3	248039	4
100	PLHT-C100/3	248040	4
125	PLHT-C125/3	248041	4

SG13202



3+N-pole 6 MU

20	PLHT-C20/3N	248059	3
25	PLHT-C25/3N	248060	3
32	PLHT-C32/3N	248061	3
40	PLHT-C40/3N	248062	3
50	PLHT-C50/3N	248063	3
63	PLHT-C63/3N	248064	3
80	PLHT-C80/3N	248065	3
100	PLHT-C100/3N	248066	3
125	PLHT-C125/3N	248067	3

Characteristic D, breaking capacity 15 ... 25 kA (according to rated current)

• For applications with high surge currents

• Rated breaking capacity for D characteristic:

$I_n = 20 - 63 \text{ A}$	25 kA
$I_n = 80 \text{ A}$	20 kA
$I_n = 100 \text{ A}$	15 kA

SG12902



Rated Current I_n [A]	Type Designation	Article No.	Units per package
1-pole 1.5 MU			
20	PLHT-D20	247990	12
25	PLHT-D25	247991	12
32	PLHT-D32	247992	12
40	PLHT-D40	247993	12
50	PLHT-D50	247994	12
63	PLHT-D63	247995	12
80	PLHT-D80	247996	12
100	PLHT-D100	247997	12

SG13002



Rated Current I_n [A]	Type Designation	Article No.	Units per package
2-pole 3 MU			
20	PLHT-D20/2	248016	6
25	PLHT-D25/2	248017	6
32	PLHT-D32/2	248018	6
40	PLHT-D40/2	248019	6
50	PLHT-D50/2	248020	6
63	PLHT-D63/2	248021	6
80	PLHT-D80/2	248022	6
100	PLHT-D100/2	248023	6

SG13102



Rated Current I_n [A]	Type Designation	Article No.	Units per package
3-pole 4.5 MU			
20	PLHT-D20/3	248042	4
25	PLHT-D25/3	248043	4
32	PLHT-D32/3	248044	4
40	PLHT-D40/3	248045	4
50	PLHT-D50/3	248046	4
63	PLHT-D63/3	248047	4
80	PLHT-D80/3	248048	4
100	PLHT-D100/3	248049	4

SG13202



Rated Current I_n [A]	Type Designation	Article No.	Units per package
3+N-pole 6 MU			
20	PLHT-D20/3N	248068	3
25	PLHT-D25/3N	248069	3
32	PLHT-D32/3N	248070	3
40	PLHT-D40/3N	248071	3
50	PLHT-D50/3N	248072	3
63	PLHT-D63/3N	248073	3
80	PLHT-D80/3N	248074	3
100	PLHT-D100/3N	248075	3

Technical information p. 150

SG25702



Z-LHASA

SG25802



Z-LHK

Accessories for Miniature Circuit Breakers PLHT

Description	Type Designation	Article No.	Units per package
Shunt Trip Release			
110–415 V	Z-LHASA/230	248442	8
12–60 V	Z-LHASA/24	248441	8
Auxiliary Switch			
1NC + 1NO contact	Z-LHK	248440	10/100
Busbar blocks Z-SV (1.5 MU)			
16 mm ² (up to 80 A)	Z-SV-16/3P	271072	20
End cover	Z-AK-16/2+3P	271070	10/600
35 mm ² (up to 110 A)	Z-SV-35/PLHT-V	264939	4
End cover	Z-V-35/AK/3P	264932	10/600

Note: Residual Currents Blocks PBHT see page 21

Technical information p. 154

Other Devices, Accessories

- Disconnecter switch
 - Auxiliary switch
 - Shunt trip release
 - Relays
 - Pushbuttons with signalisation
 - Motor starters
 - Measuring devices
-
- Utility design
 - Universal utilization
 - Easy mounting

SG13805



SG11402



SG17902



Main Switch Disconnecter IS

- Can be used as a main switch disconnector of distribution board
- Rated voltage 240 / 415 V AC
- Rated short circuit strength 12.5 kA (for $I_n = 16-80$ A) and 6 kA (for $I_n = 100-125$ A)
- Busbar positioning optionally above or below
- Utilization category AC-22
- Degree of protection IP10
- Terminal capacity 2.5–50 mm²
- The device function irrespective of the position of installation

SG14205



SG14305



SG14405



SG14505



Rated Current [A]	Poles	Type Designation	Article No.	Units per package
16	1	IS-16/1	276254	12/120
16	2	IS-16/2	276255	1/60
16	3	IS-16/3	276256	1/40
16	4	IS-16/4	276257	1/30
20	1	IS-20/1	276258	12/120
20	2	IS-20/2	276259	1/60
20	3	IS-20/3	276260	1/40
20	4	IS-20/4	276261	1/30
25	1	IS-25/1	276262	12/120
25	2	IS-25/2	276263	1/60
25	3	IS-25/3	276264	1/40
25	4	IS-25/4	276265	1/30
32	1	IS-32/1	276266	12/120
32	2	IS-32/2	276267	1/60
32	3	IS-32/3	276268	1/40
32	4	IS-32/4	276269	1/30
40	1	IS-40/1	276270	12/120
40	2	IS-40/2	276271	1/60
40	3	IS-40/3	276272	1/40
40	4	IS-40/4	276273	1/30
63	1	IS-63/1	276274	12/120
63	2	IS-63/2	276275	1/60
63	3	IS-63/3	276276	1/40
63	4	IS-63/4	276277	1/30
80	1	IS-80/1	276278	12/120
80	2	IS-80/2	276279	1/60
80	3	IS-80/3	276280	1/40
80	4	IS-80/4	276281	1/30
100	1	IS-100/1	276282	12/120
100	2	IS-100/2	276283	1/60
100	3	IS-100/3	276284	1/40
100	4	IS-100/4	276285	1/30
125	1	IS-125/1	276286	12/120
125	2	IS-125/2	276287	1/60
125	3	IS-125/3	276288	1/40
125	4	IS-125/4	276289	1/30
Accessories				
Locking set (without lock)		IS/SPE-1TE	101911	5/30
Terminal cover		Z-IS/AK-1TE	276290	10/600

Technical information p. 155

Switch Disconnectors ZP-A..

- Can be used as a main switch disconnector of distribution board
- Rated voltage 230 / 400 V AC
- Rated short circuit strength 3 kA (with back-up fuse 63 A gL)
- Degree of protection IP20
- Terminal capacity 1.5–25 mm²
- The same accessories as for MCBs PL6, PL7 can be used (auxiliary switch, shunt trip release, undervoltage release etc.)

SG23602



Rated Current [A]	Poles	Type Designation	Article No.	Units per package
40	1	ZP-A40/1	248263	12/120
40	2	ZP-A40/2	248264	1/60
40	3	ZP-A40/3	248265	1/40
40	3+N	ZP-A40/3N	248266	1/30
63	1	ZP-A63/1	284906	12/120
63	2	ZP-A63/2	284907	1/60
63	3	ZP-A63/3	284908	1/40
63	3+N	ZP-A63/3N	284909	1/30

Technical information p. 156



Z-D63 Z-D63/P

Technical information p. 156

Lead-through terminal

- For interconnection between top and bottom busbar system
- Rated current 63 or 80 A
- Version Z-D63/P with test socket
- Degree of protection IP20
- Terminal capacity 1–25 mm² (or 2.5–50 mm² for Z-D80)

Rated Current [A]	Type Designation	Article No.	Units per package
63	Z-D63	248267	12/120
63, with test socket	Z-D63/P	248268	12/120
80	Z-D80	248269	12/120

MCBs for Auxiliary Circuits PL7-B4/.-HS

Characteristic B, rated breaking capacity 10 kA

- For protection of contacts of auxiliary circuits
- Strongly reduced value of I²t decreases worn-out of contacts in auxiliary circuits
- Rated voltage 230/400 V AC
- Rated current 4 A
- Degree of protection IP20
- Terminal capacity 1.5–25 mm²



Technical information p. 157

Poles	Breaking capacity	Type Designation	Article No.	Units per package
1	10 kA	PL7-B4-HS	264908	2/120
1N	10 kA	PL7-B4/1N-HS	264909	1/80
2	10 kA	PL7-B4/2-HS	264910	1/60

Auxiliary Switch Z-HK, Z-AHK, Tripping Signal Switch Z-NHK, Z-HD

- Design according to EN 60947-5-1, EN 62019
- Mounting by means of screws
- **Z-AHK, Z-NHK:** Contact function with relative movement (self-cleaning contacts)
- Contact material and design particularly suitable for extra low voltage
- **Z-HK:** only for RCDs PF7, PFR, PHF7-4p, PF6
- **Z-AHK:** for PHF7-2p
- **Z-NHK:** Universal design for PF7, PHF7, PFR, PF6
- The function of one of the two change-over contacts (25/21, 26/22, 28/24) can be switched from "auxiliary switch" to "tripping signal switch" by means of SEL driver
- Auxiliary switch (11, 12, 14; 21, 22, 24) is active with both electrical and mechanical tripping
- Tripping signal switch (25, 26, 28) is active with electrical tripping only
- Contact position indicator blue-white
- **Z-HD:** for PFDM RCDs



Z-HK

Connection diagrams

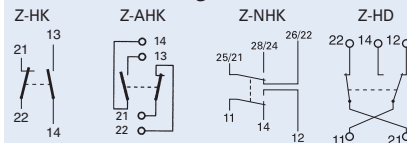

For Protective Device	Rated Current [A]	Type Designation	Article No.	Units per package
PF7, PF6, PHF7-4p, PFR	8	Z-HK	248432	4/120
PHF7-2p	4	Z-AHK	248433	4/120
PF7, PHF7, PF6	4	Z-NHK	248434	4/120
PFDM	6 A AC11 1 A DC11	Z-HD	265620	1

Technical information p. 158, 121

SG11502



ZP-NHK

SG13505



ZP-IHK

Auxiliary Switch ZP-IHK, ZP-WHK, Tripping Signal Switch ZP-NHK

- Design according to EN 62019
- Snap-on mounting, can be mounted onto PL7, PFL7, PL6, PFL6, ZP-A40, ZP-A63, Z-MS a mRB6
- **ZP-NHK:** Contact function with relative movement (self-cleaning contacts)
- Contact material and design particularly suitable for extra low voltage
- **ZP-IHK, ZP-WHK:** 2 switches can be mounted onto itself thanks to mechanical design (2 x ZP-IHK or 2 x ZP-WHK or alternatively 1 x ZP-IHK + 1 x ZP-WHK)
- **ZP-NHK:** Universal design for PL7, PFL7. The function of one of the two change-over contacts (25/21, 26/22, 28/24) can be switched from "auxiliary switch" to "tripping signal switch" by means of SEL driver
- Auxiliary switch (11, 12, 14; 21, 22, 24) is active with both electrical and mechanical tripping
- Tripping signal switch (25, 26, 28) is active with electrical tripping only

Connection diagram

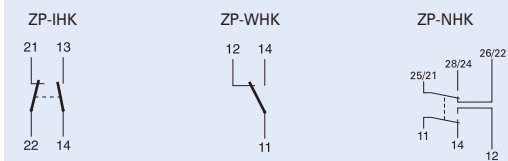

Function	Rated Current [A]	Type Designation	Article No.	Units per package
1 NO + 1 NC	6	ZP-IHK	286052	4/120
1 CO	6	ZP-WHK	286053	4/120
2 CO	4	ZP-NHK	248437	4/120

Technical information p. 160

SG23702



ZP-ASA

Shunt Trip Release ZP-ASA

- Shunt trip release for subsequent mounting onto PL7, PL6, PFL7, PFL6, ZP-A40, ZP-A63, Z-MS, mRB6
- Width 1 MU
- Additional installation of standard auxiliary switch is possible
- Position indicator red - green
- Snap-on mounting

Operational voltage range	Type Designation	Article No.	Units per package
12–110 V AC / 12–60 V DC	ZP-ASA/24	248438	1/60
110–415 V AC / 110–220 V DC	ZP-ASA/230	248439	1/60

Technical information p. 161

Additional terminal

- For connection of conductors up to 35 mm²

Description	Type Designation	Article No.	Units per package
Additional terminal 35 mm ²	Z-HA-EK/35	263960	12/720

Switching interlocks

- Sets for locking of toggle in ON or OFF position
- If locked in ON position, the function of electrical tripping of a breaker is not affected, mechanical operation is blocked only
- Delivered without lock

For device	Type Designation	Article No.	Units per package
IS, PF7, PF6, PHF7, dRCM, PFL7, PFL6, mRB6, PFR	IS/SPE-1TE	101911	5/30
PL7, PL6, ZP-A, Z-MS	Z-IS/SPE-1TE	274418	5/30

Undervoltage release Z-USA, Z-USD

- Undervoltage releases:
without delay Z-USA
delayed Z-USD with delay 0.4 s
- Release position indicator blue / white
- Test button for checking of proper function
- Can be mounted onto PL7, ZP-A40, ZP-A63, Z-MS, PL6 and mRB6
- Screws mounting
- Switch on limit 80 % U_n
- Lowest switch off limit 50 % U_n



SG12702

Voltage AC [V] / Function	Type Designation	Article No.	Units per package
115 / without delay	Z-USA/115	248288	1/60
230 / without delay	Z-USA/230	248289	1/60
400 / without delay	Z-USA/400	248290	1/60
115 / delayed 0.4 s	Z-USD/115	248292	1/60
230 / delayed 0.4 s	Z-USD/230	248291	1/60

Technical information p. 162

Undervoltage relay Z-UR/400

- Relay is switched on by connection of voltage to terminals L1, L2, L3 and neutral conductor to N-terminal. LED is switched on. On condition that voltage at one, two, or three phases is below than U_s ($U_s = U_n \times 0.85$), the relay and LED are switched off.
- One-phase applications: interconnection of L1-L2-L3 terminals.



SG2002

Connection diagram

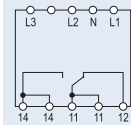

Switching Voltage U_s	Rated Current	Type Designation	Article No.	Units per package
$U_n \times 0.85$ 230 / 400 V AC	5 A	Z-UR/400	248252	1

Technical information p. 163

RCD Tripping Module Z-AM

- For remote breaking of RCDs
- Rated voltage 230/400 V AC
- Degree of protection IP20
- Terminal capacity 2 x 2.5 mm²



Z-FAM



Z-KAM

For device	Type Designation	Article No.	Units per package
PF7, PF6, PHF7-4p	Z-FAM	248293	1/60
PFL7, PFL6, PHF7-2p	Z-KAM	248294	1/60

Technical information p. 164

SG13905



SG13705



Technical information p. 165

SG12202



Technical information p. 166

SG07708



Technical information p. 167

SG09906



FFS/16

SG09708



Z-NKA-SCH

Technical information p. 169

Automatic Switching Device Z-FW

- For automatic or remote control of hardly accessible distribution rooms or distribution rooms without supervisor
- For subsequent mounting onto PL7, PL6, PF7, PF6, PHF7-4p, ZP-A40, ZP-A63, PFR, Z-MS, dRCM, mRB6
- **Z-FW-LP** for automatic repeated switching, supply voltage 230 V AC
- **Z-FW-LPD** for automatic repeated switching, supply voltage 24–48 V DC

- **Z-FW-LP(D)/MO** pre-mounted set consisting of Z-FW-LP(D) and remote control Z-FW-MO
- Mechanical interlock, can be sealed with leads
- Mechanical switching capability up to max. PF7-100/4p, PF6-63/4p, PL7-63/4p, PL6 all types
- Operating and alarm display by green and red LED
- Module for remote testing Z-FW of residual current devices PF7 a PF6

Function	Supply voltage	Type Designation	Article No.	Units per package
Without remote control	230 V AC	Z-FW-LP	248296	1/20
Without remote control	24–48 V DC	Z-FW-LPD	265244	1/20
Set with remote control	230 V AC	Z-FW-LP/MO	290171	1/12
Set with remote control	24–48 V DC	Z-FW-LPD/MO	290172	1/12
Remote control ON/OFF/TEST (only in connection with Z-FW-LP, -LPD from delivery date 2006!)				
		Z-FW-MO	284730	1

Module for remote testing

Residual current [A]	Type Designation	Article No.	Units per package
0.01	Z-FW/001	248297	4/120
0.03	Z-FW/003	248298	4/120
0.1	Z-FW/010	248299	4/120
0.3	Z-FW/030	248300	4/120
0.5	Z-FW/050	248301	4/120

Communication Center Z-CC/2CO

- Universal GSM device for monitoring as well as controlling of devices via SMS
- Integrated 4-band GSM modem
- 4 digital inputs
- 2 relay outputs
- Activation of inputs generates sending of SMS up to 3 telephone numbers and 1 e-mail address
- Actual device status can be checked via SMS anytime
- Possibility of connection to local network

Description	Type Designation	Article No.	Units per package
Communication Center	Z-CC/2CO	119383	1
Power supply unit (24 V / 0.2 A)	EASYPOW200	229424	1
Temperature sensor	Z-CC/2CO-SE	119430	1
Patch cord 2.0 m	DNW-PX/0200/RJ45/RJ45/5E/CSUTP/GR/PV	237271	1

Bio-switch FFS/16

- For automatic disconnection from supply voltage in time without current consumption
- 2 NO contacts 16 A / 250 V
- Line voltage LED
- Not suitable for consumers with electronic control
- Detecting voltage about 4 V DC in controlled circuit during off state
- For consumers with extremely low consumption, it is necessary to use basic load Z-NHK-SCH to ensure start up current for proper function (basic load is automatically disconnected after 5 minutes)

Description	Rated Current [A]	Type Designation	Article No.	Units per package
Bio-switch	16	FFS/16	107325	1/60
Basic load		Z-NKA-SCH	120890	1/12

SG12502



Front Plate Tripping Device Z-MFPA

- To switch off connected device if front plate is removed
- Mechanical breaker for ZP-A40, ZP-A63, PL7, PL6, PFL7, PFL6
- Trips connected device when front plate is taken out
- Maximum tripped capacity: 4 + 4 poles symmetrically (4 left, 4 right)
- Can be interlocked by twisting when the tripping pin is in the pressed position
- Meets requirements of standards for automatic disconnection from power supply if front plate of distribution box is removed (see HD 60364-4-41 cl. A.2.4)

	Type Designation	Article No.	Units per package
Front plate tripping device	Z-MFPA	248302	6/60

Technical information p. 170

SG4100



Protective Earth Socket for DIN rail Z-SD..

- Meets requirements of VDE, ÖVE, ČSN
- Possibility of screw mounting
- Width 2.5 MU
- Design -BS with child protection device

Design	Type Designation	Article No.	Units per package
Protective earth socket with child protection device	Z-SD230-BS	266876	10/50
Protective earth socket in Schuko design	Z-SD230	266875	10/50

SG4100



Technical information p. 170

Priority-(Current) Relay Z-LAR/..

- For simple priority connection of important consumers
- Wide range of currents
- Expensive peak loads are avoided efficiently (staggered heating)
- Integrated auxiliary switch, 1 NC or 1 NO or 1 CO contact
- NC and NO contact are potential free
- Rated current 8, 16, 32 A
- Rated voltage 250 V AC

Contacts	Rated Current [A]	Type Designation	Article No.	Units per package
1 NC	3–8	Z-LAR/8-O	248256	1/60
1 NC	10–16	Z-LAR/16-O	248257	1/60
1 NC	15–32	Z-LAR/32-O	248258	1/60
1 NO	3–8	Z-LAR/8-S	248259	1/60
1 NO	10–16	Z-LAR/16-S	248260	1/60
1 NO	15–32	Z-LAR/32-S	248261	1/60
1 CO	3–8	Z-LAR/8-W	248262	1/60

SG11702



Technical information p. 171

Signal Lamps Z-EL, Z-DLD, Z-UEL, Z-UDL, Z-BEL

- Rated voltage 24 V AC/DC or 230 V AC/DC
- Colour red/green, can be selected by alternative wiring
- Flash option by usage of different terminals only, changeover option
- Terminal capacity 1–10 mm²
- Twin lamp means 50 % saving of space in comparison to a pair of individual lamps

SG12003



LED colour	Rated voltage LED	Type Designation	Article No.	Units per package
Single Lamp				
Z-EL				
orange	24 V AC/DC	Z-EL/OR24	275444	2/120
red	230 V AC/DC	Z-EL/R230	284921	2/120
green	230 V AC/DC	Z-EL/G230	284922	2/120
orange	230 V AC/DC	Z-EL/OR230	275865	2/120
blue	230 V AC/DC	Z-EL/BL230	103131	2/120
Twin Lamp				
Z-DLD				
red + green	24 V AC/DC	Z-DLD/2/24	284926	2/120
red + green	230 V AC/DC	Z-DLD/2/230	284925	2/120
Universal Single Lamp - changeover function				
Z-UEL				
red / green	24 V AC/DC	Z-UEL24	284924	2/120
red / green	230 V AC/DC	Z-UEL230	284923	2/120
Universal Twin Lamp - changeover function				
Z-UDL				
red / green	24 V AC/DC	Z-UDL24	284928	2/120
red / green	230 V AC/DC	Z-UDL230	284927	2/120
Signal Lamp - with integrated flash function				
Z-BEL				
red	24 V AC/DC	Z-BEL/R24	284931	2/120
green	24 V AC/DC	Z-BEL/G24	284932	2/120
red	230 V AC/DC	Z-BEL/R230	284929	2/120
green	230 V AC/DC	Z-BEL/G230	284930	2/120

Technical information p. 172

Pushbutton Unit Z-PU, Pushbutton Unit with LED Z-PUL

- Rated voltage of LED 24 V AC/DC or 230 V AC/DC
- Rated current of contacts 16 A 250 V AC
- Low power consumption of LED
- Terminal capacity 1–10 mm²
- LED colour orange
- Pushbutton colour
 - NO contact green
 - NC contact red
 - NO + NC contact black

SG12203



Rated voltage LED	Contacts	Type Designation	Article No.	Units per package
-	1 NO	Z-PU/S	276291	2/120
-	2 NO	Z-PU/SS	276292	2/120
-	1 NO + 1 NC	Z-PU/SO	276293	2/120
-	2 NC	Z-PU/OO	276294	2/120
24 V AC/DC	2 NO	Z-PUL24/SS	276295	2/120
24 V AC/DC	1 NO + 1 NC	Z-PUL24/SO	276296	2/120
230 V AC/DC	2 NO	Z-PUL230/SS	276297	2/120
230 V AC/DC	1 NO + 1 NC	Z-PUL230/SO	276298	2/120
230 V AC/DC	2 NC	Z-PUL230/OO	276299	2/120

Technical information p. 172

Switch Z-SW and Switch with LED Z-SWL

- Rated voltage of LED 24 V AC/DC or 230 V AC/DC
- Rated current of contacts 16 A, 250 V AC
- Low power consumption of LED
- Standard colour of LED orange, standard colour of pushbutton black
- Terminal capacity 1–10 mm²

SG12103



Rated voltage LED	Contacts	Type Designation	Article No.	Units per package
-	1 NO	Z-SW/S	276300	2/120
-	2 NO	Z-SW/SS	276301	2/120
-	1 NO + 1 NC	Z-SW/SO	276302	2/120
-	1 CO	Z-SW/W	276303	2/120
24 V AC / DC	2 NO	Z-SWL24/SS	276304	2/120
24 V AC / DC	1 NO + 1 NC	Z-SWL24/SO	276305	2/120
230 V AC / DC	2 NO	Z-SWL230/SS	276306	2/120
230 V AC / DC	1 NO + 1 NC	Z-SWL230/SO	276307	2/120
230 V AC / DC	1 NO	Z-SWL230/S	292300	2/120

Technical information p. 172

Pushbutton Z-T

- Rated voltage 230 V AC
- Rated current of contacts 16 A
- Terminal capacity 1–10 mm²

SG18502



Filter/push button	Contacts	Type Designation	Article No.	Units per package
- / green	4 NO	Z-T/4S-G	248328	12/120
- / black	3 NO + 1 NC	Z-T/3S10	248330	12/120

Technical information p. 173

Switch Z-S

- Rated voltage 230 V AC
- Rated current of contacts 16; 32 A
- Terminal capacity 1–10 mm²

SG18702



Rated Current	Contacts	Type Designation	Article No.	Units per package
16 A	3 NO	Z-S/3S	248334	12/120
16 A	4 NO	Z-S/4S	248335	12/120
16 A	2 NO + 2 NC	Z-S/SSOO	248337	12/120
16 A	3 NO + 1 NC	Z-S/3S10	248338	12/120
32 A	1 NO	Z-S32/S	248339	12/120
32 A	2 NO	Z-S32/SS	248340	12/120
32 A	3 NO	Z-S32/3S	248341	12/120
32 A	4 NO	Z-S32/4S	248342	12/120

Technical information p. 173

Changeover Switch Z-S/W..

- Rated voltage 230 V AC
- Rated current of contacts 16 A
- Degree of protection IP20
- Terminal capacity 1–10 mm²

SG18602



Contacts	Type Designation	Article No.	Units per package
2 CO	Z-S/2WE	248344	12/120
1 CO I-0-II	Z-S/WM	248345	12/120
2 CO I-0-II	Z-S/2WM	248346	12/120

Technical information p. 173

Rotary Switch Z-DS

- Suitable for direct switching of motors, lighting, heating system or as instrument switches
- Degree of protection IP20
- Rated voltage 690 V AC
- Terminal capacity 2 x 0.75–1.5 mm²
- Rated current 20 A

SG3602



Z-DSU1-102

SG3702



Z-DSA2-01-SL

Function	Description	Type Designation	Article No.	Units per package
1pole OFF	0 - 1	Z-DSA1-01	248868	1/40
1pole CHANGE	1 - 0 - 2	Z-DSU1-102	248869	1/40
2pole OFF	0 - 1	Z-DSA2-01	248872	1/40
2pole OFF with lock *)	0 - 1	Z-DSA2-01-SL	248873	1/40
2pole CHANGE	1 - 2	Z-DSU2-12	248874	1/40
2pole CHANGE	1 - 0 - 2	Z-DSU2-102	248875	1/40
2pole CHANGE	HA - 0 - AU	Z-DSU2-H0A	248876	1/40
3pole CHANGE	1 - 0 - 2	Z-DSU3-102	248877	1/40
Voltmeter L-N	L1 - N...	Z-DSV-LN	248878	1/40
Voltmeter L-L	L1 - L2...	Z-DSV-LL	248879	1/40
Voltmeter L+N	L1 - N3...	Z-DSV-LLLN	248880	1/40
Amperemeter	0 - 1 - 2 - 3	Z-DSAM-0123	129712	1/40

*) Key can be pulled out in both positions "0" and "1".

Technical information p. 174

Time-Lag Relay ZR

- Driving voltage 24 – 240 V AC/DC
- Rated switching capacity for AC-1 2000 VA
- Rated current of output contacts 8 A at 250 V AC
- Terminal capacity 2 x 0.5–2.5 mm²

SG09807



ZRMF1/W

SG09907



ZRMF2/WW

Function	Contacts	Type Designation	Article No.	Units per package
E, R	1 CO	ZRER/W	110405	2/120
E, R, Ws, Wa, Es, Wu, Bp	1 CO	ZRMF1/W	110406	2/120
E, R, Ws, Wa, Es, Wu, Bp	2 CO	ZRMF2/WW	110408	1/60
Ip, li	1 CO	ZRTAK/W	110747	2/120

Technical information p. 177

Impulse Relays Z-S...

- Suitable for switching electrical consumers in impulse operation
- Rated control voltage 12 V, 24 V, 48 V, 230 V AC; 12 V, 24 V DC
- Rated current of output contacts 16 A at 230 V AC
- Rated switching capacity for AC-1 2000 VA
- Degree of protection IP20
- Terminal capacity 0.5–10 mm²

WA_SG12802



Z-S24/SO

Type Z-S for local control

- with pushbutton

Control voltage	Contacts	Width MU	Type Designation	Article No.	Units per package
230 V AC	1 NO	1	Z-S230/S	265262	2/120
230 V AC	2 NO	1	Z-S230/SS	265271	2/120
230 V AC	1 CO	1	Z-S230/W	265290	2/120
230 V AC	2 CO	2	Z-S230/WW	265312	1/60
230 V AC	1 NO + 1 NC	1	Z-S230/SO	265283	2/120
230 V AC	2 NO + 2 NC	2	Z-S230/2S2O	265305	1/60
48 V AC / 24 V DC*)	1 NO	1	Z-S48/S	265534	2/120
48 V AC / 24 V DC*)	2 NO	1	Z-S48/SS	265536	2/120
48 V AC / 24 V DC*)	1 NO + 1 NC	1	Z-S48/SO	265538	2/120
48 V AC / 24 V DC*)	2 NO + 2 NC	2	Z-S48/2S2O	265540	1/60
48 V AC / 24 V DC*)	1 CO	1	Z-S48/W	265544	2/120
48 V AC / 24 V DC*)	2 CO	2	Z-S48/WW	265542	1/60
24 V AC / 12 V DC*)	1 NO	1	Z-S24/S	265535	2/120
24 V AC / 12 V DC*)	2 NO	1	Z-S24/SS	265537	2/120
24 V AC / 12 V DC*)	1 NO + 1 NC	1	Z-S24/SO	265539	2/120
24 V AC / 12 V DC*)	2 NO + 2 NC	2	Z-S24/2S2O	265541	1/60
24 V AC / 12 V DC*)	1 CO	1	Z-S24/W	265545	2/120
24 V AC / 12 V DC*)	2 CO	2	Z-S24/WW	265543	1/60
12 V AC	2 NO	1	Z-S12/SS	265278	2/120

*) Possibility of AC/DC control

WA_SG13002



Type Z-SB for local control

- with pushbutton and LED

Control voltage	Contacts	Width MU	Type Designation	Article No.	Units per package
230 V AC	2 NO	1	Z-SB230/SS	265301	2/120
24 V AC	2 NO	1	Z-SB24/SS	265302	2/120
24 V DC	2 NO	1	Z-SB23/SS	265303	2/120

WA_SG13102



Z-SC230/S

Type Z-SC for central control

- with pushbutton

Control voltage	Contacts	Width MU	Type Designation	Article No.	Units per package
230 V AC	1 NO	1	Z-SC230/S	265299	2/120
230 V AC	1 NO + 1 CO	2	Z-SC230/1S1W	265324	1/60
230 V AC	2 NO + 1 NC	2	Z-SC230/2S1O	265327	1/60
230 V AC	3 NO	2	Z-SC230/3S	265321	1/60
24 V AC	1 NO	1	Z-SC24/S	265300	2/120

Accessories for impulse relays

Compensator		1	Z-S/KO	270588	2/120
Group block		1	Z-SC/GP	270587	2/120
Spacer 0.5 MU			Z-DST	248949	10

Note:

Spacer is designed for separation of a pair of impulse relays with air gap – duty of inputs of relays with spacer is higher (of order of hours, < 100 %). In continual regime of operation (long control pulse), surface temperature of a relay can be increased in accordance with EN 60669.

sg 12705



TLK

Technical information p. 182

Staircase Switch TL.

- Rated permanent current 16 A AC
- Switching capacity 4000 VA / AC1
- Adjustment range 0.5–15 min
- Terminal capacity 1 x 4 mm²
2 x 2.5 mm²

- Type TLE – with switchoff warning and stop function
- Type TLK – with additional control input for central control, zero-voltage proof

Function	Type Designation	Article No.	Units per package
Staircase switch with STOP and alarm	TLE	101064	2/120
As TLE with central control input, zero-voltage proof	TLK	101066	2/120

SG11207



SG11107



DS-TA/WA

DS-TD/WA

Technical information p. 183

Light Intensity Switch for wall mounting DS-T.

- For automatic control of lighting systems with respect to light intensity at sensor
- Wall-mounted
- Rated voltage 230 V AC
- Rated current 10 - 16 A (AC-1)
- 1 NO contact
- DS-TD with integrated timer
- With internal light sensor
- Terminal capacity 1-4 mm²

Light intensity [Lux]	Type Designation	Article No.	Units per package
5 – 200	DS-TA/WA	111454	1/40
2 – 2000	DS-TA/VWA	111455	1/40
2 – 200	DS-TD/WA	111456	1/40

SG11807



DS-TA/1S

SG11607

SG11507



Z-DS/S-A



DS-TD/1W

Technical information p. 185

Light Intensity Switch for support rail assembly DS-T.

- For automatic switching of lights with respect to light intensity at the sensor
- Mounting onto device rail
- Rated voltage 230 V AC
- Rated current 10 - 16 A (AC-1)
- DS-TD with integrated timer
- With external light sensor
- Terminal capacity 1-4 mm²

Switching contact	Light intensity [Lux]	Type Designation	Article No.	Units per package
1 NO	2 - 100	DS-TA/1S	111451	1/40
1 CO	2 - 2000	DS-TA/1W	111452	1/40
1 CO	2 - 2000	DS-TD/1W	111453	1/40

Accessories

Description	Type Designation	Article No.	Units per package
Spare Built-in Light Sensor	Z-DS/S-E	111457	1/40
Spare External Light Sensor	Z-DS/S-A	111458	1/40

SG07003



TR-G/8

SG07103



TR-G2/63-SF

Technical information p. 187, 188

Bell Transformers TR-G

- Rated primary voltage 230 V AC
- ...-SF types safety transformers with separate windings for continual duty, the other types with reduced duty

MU	Rated output [VA]	Sec. voltage [V]	Sec. current [A]	Type Designation	Article No.	Units per package
2	8	8	1	TR-G/8	272480	1
2	8	4-8-12	1-1-0,67	TR-G3/8	272481	1
2	18	4-8-12	2-2-1,5	TR-G3/18	272483	1
3	24	12-24	2-1	TR-G2/24	272484	1
5	63	12-24	5,2-2,6	TR-G2/63-SF	272485	1
3	24	8-12	2-2	TR-G2/24-SF	272486	1
5	24	12-24	2-1	TR-G2/24-SF2	272487	1

Sets for surface mounting of transformers TR-G

- Accessories for surface mounting
- 1 Set = Mounting plate + 2 Terminal covers

For width [MU]	Type Designation	Article No.	Units per package
2 MU	Z-TR/AP-2TE	272488	1/28
3 MU	Z-TR/AP-3TE	272489	1/28
5 MU	Z-TR/AP-5TE	272500	1/28

Installation Relays Z-R.., Z-TN

- Suitable for switching 1-phase or 3-phase consumers
- Rated current up to 20 A / 250 V AC
- Suitable for mounting into distribution boxes

WA_SG12402



Z-R230/2S2O

Type Z-R

- With pushbutton

Control voltage	Contacts	Width MU	Type Designation	Article No.	Units per package
230 V AC	1 NO	1	Z-R230/S	265149	2/120
230 V AC	2 NO	1	Z-R230/SS	265168	2/120
230 V AC	4 NO	2	Z-R230/4S	265226	1/60
230 V AC	1 NO + 1 NC	1	Z-R230/SO	265181	2/120
230 V AC	2 NC	1	Z-R230/OO	265188	2/120
230 V AC	2 NO + 2 NC	2	Z-R230/2S2O	265215	1/60
24 V AC	1 NO	1	Z-R24/S	265160	2/120
24 V AC	2 NO	1	Z-R24/SS	265173	2/120
24 V AC	1 NO + 1 NC	1	Z-R24/SO	265183	2/120
24 V AC	2 NO + 2 NC	2	Z-R24/2S2O	265218	1/60
24 V AC	2 NC	1	Z-R24/OO	265189	2/120
24 V DC	2 NO	1	Z-R23/SS	265174	2/120
24 V DC	2 NO + 2 NC	2	Z-R23/2S2O	265219	1/60
12 V AC	2 NO	1	Z-R12/SS	265175	2/120
8 V AC	2 NO	1	Z-R8/SS	265177	2/120

WA_SG12302a



Z-RE24/SO

Type Z-RE

- With LED
- Rated current 20 A / 250 V AC

Control voltage	Contacts	Width MU	Type Designation	Article No.	Units per package
230 V AC	1 NO	1	Z-RE230/S	265190	2/120
230 V AC	2 NO	1	Z-RE230/SS	265193	2/120
230 V AC	1 NO + 1 NC	1	Z-RE230/SO	265197	2/120
24 V AC	2 NO	1	Z-RE24/SS	265194	2/120
24 V AC	1 NO + 1 NC	1	Z-RE24/SO	265198	2/120
24 V DC	2 NO + 2 NC	2	Z-RE23/2S2O	265232	1/60

WA_SG12702a



Z-RK230/SS

Type Z-RK

- With pushbutton and LED
- Rated current 20 A / 250 V AC

Control voltage	Contacts	Width MU	Type Designation	Article No.	Units per package
230 V AC	1 NO	1	Z-RK230/S	265200	2/120
230 V AC	2 NO	1	Z-RK230/SS	265203	2/120
230 V AC	1 NO + 1 NC	1	Z-RK230/SO	265208	2/120
24 V AC	2 NO	1	Z-RK24/SS	265205	2/120
24 V AC	1 NO + 1 NC	1	Z-RK24/SO	265209	2/120
24 V DC	2 NO + 2 NC	2	Z-RK23/2S2O	271464	1/60

SG01603



Z-TN230/4S

Type Z-TN

- With mechanical pre-selection ON / AUT / OFF
- Rated current 20 A / 250 V AC

Control voltage	Contacts	Width MU	Type Designation	Article No.	Units per package
230 V AC	2 NO	1	Z-TN230/SS	265574	2/120
230 V AC	3 NO	2	Z-TN230/3S	265576	1/60
230 V AC	4 NO	2	Z-TN230/4S	265579	1/60
230 V AC	1 NO + 1 NC	1	Z-TN230/1S1O	267975	2/120
24 V AC	2 NO	1	Z-TN24/SS	267976	2/120
24 V AC	3 NO	2	Z-TN24/3S	267977	1/60
24 V AC	4 NO	2	Z-TN24/4S	267978	1/60
24 V AC	1 NO + 1 NC	1	Z-TN24/1S1O	267979	2/120

Accessories for installation relays Z-R..

Spacer 0.5 MU	Z-DST	248949	10
---------------	-------	--------	----

Note:

Spacer is designed for separation of a pair of installation relays with air gap in case of ambient temperature over 40 °C or in case of full current load of all contacts.

SG0102



Z-SCH230/25-40

SG0502



Z-SCH230/63-40

SG0602



Z-SC

Technical information p. 191

Installation contactors Z-SCH

- Designed for switching 1-phase or 3-phase consumers up to 63 A AC. Suitable for installation in modular distribution boxes.
- Coil voltage 24 V, 230 V 50 Hz
- Rated current of contacts 25 to 63 A 250 V AC for AC-1
- Rated voltage of contacts 440 V; 50 Hz
- Terminal capacity 2.5–25 mm²

Coil voltage	Rated current	Contacts	Type Designation	Article No.	Units per package
24 V AC	25 A	4 NO	Z-SCH24/25-40	248851	1/40
24 V AC	25 A	2 NO + 2 NC	Z-SCH24/25-22	248850	1/40
230 V AC	25 A	2 NO	Z-SCH230/1/25-20	120853	2/120
230 V AC	25 A	4 NO	Z-SCH230/25-40	248847	1/60
230 V AC	25 A	4 NC	Z-SCH230/25-04	248848	1/60
230 V AC	25 A	3 NO + 1 NC	Z-SCH230/25-31	248846	1/60
230 V AC	25 A	2 NO + 2 NC	Z-SCH230/25-22	248849	1/60
230 V AC	40 A	4 NO	Z-SCH230/40-40	248852	1/40
230 V AC	40 A	3 NO + 1 NC	Z-SCH230/40-31	248854	1/40
230 V AC	40 A	2 NO + 2 NC	Z-SCH230/40-22	248853	1/40
230 V AC	40 A	2 NO	Z-SCH230/40-20	248855	1/40
230 V AC	63 A	4 NO	Z-SCH230/63-40	248856	1/40
230 V AC	63 A	4 NC	Z-SCH230/63-04	285735	1/40
230 V AC	63 A	3 NO + 1 NC	Z-SCH230/63-31	248858	1/40
230 V AC	63 A	2 NO + 2 NC	Z-SCH230/63-22	248857	1/40
230 V AC	63 A	2 NO	Z-SCH230/63-20	248859	1/40

Accessories

Description	Function	Type Designation	Article No.	Units per package
Auxiliary switch	1 NO + 1 NC	Z-SC	248862	3
Spacer	0.5 MU	Z-DST	248949	10
Suppressor RC-Combination	12 - 250 V AC	Z-RC/230	101428	2/120
Sealing cover	for 25 A versions	Z-SCHAK-2TE	248860	10
Sealing cover	for 40, 63 A versions	Z-SCHAK-3TE	248861	10

Relay for low-level signals RE

- Electronic relays, noiseless
- Single device contains 2 independent relays with 1 CO contact (i.e. configuration 1 CO + 1 CO)
- For switching of low levels signals from 10 mV / 1 µA
- Universal control voltage 24 – 230 V AC/DC
- Width 1 MU

Obr. SG06709



Rat. op. voltage U_e / rat. op. current I_e	U_{min} / I_{min}	Type Designation	Article No.	Units per package
30 V DC / 2 A, 220 V DC / 0.3 A, 250 V AC / 5 A, 30 V DC / 5 A, 300 V DC / 0.25 A	10mV / 10µA	RELLVA	120854	1/40
30 V DC / 2 A, 220 V DC / 0.3 A, 250 V AC / 5 A, 30 V DC / 5 A, 300 V DC / 0.25 A	10mV / 10µA	REHLVA	120855	1/40
Contact 11/12/14 30 V DC / 2 A, 220 V DC / 0.3 A, Contact 21/22/24 250 V AC / 5 A, 30 V DC / 5 A, 300 V DC / 0.25 A	100mV / 10mA	REMLVA	120856	1/40

Technical information p. 197

SG11907



Technical information p. 198

Astronomical, Digital Timer SA-TD/1W

- Digital timers with quartz control
- Automatic or manual control
- Automatic change summer/winter time
- Automatic leap year adjustment
- Daily program
- 1 channel, 1 CO contact
- Power reserve (Li battery, lifetime 10 years)
- Rated current 16 A (AC-1)
- Terminal capacity 1-4 mm²

Description	Type Designation	Article No.	Units per package
Timer	SA-TD/1W	111450	1/40

SG12107



SU-TQ/1W-TA

SG12407



SU-TQ/TA

Technical information p. 199

Timers analogue SU-T

- Synchronous drive with accuracy of frequency of net system, without power reserve
- System Quartz with quartz accuracy, with power reserve
- Rated current 16 A (AC-1)
- Terminal capacity 1-4 mm²

Drive	Programme	Channels/ /contacts	Type Designation	Article No.	Units per package
Synchron.	Day	1 / 1 NO	SU-TS/TA	111442	1/120
Synchron.	Day	1 / 1 CO	SU-TS/1W-TA	111443	1/40
Synchron.	Week	1 / 1 NO	SU-TS/WO	111444	1/40
Quartz	Day	1 / 1 NO	SU-TQ/TA	111445	1/120
Quartz	Day	1 / 1 CO	SU-TQ/1W-TA	111446	1/40
Quartz	Week	1 / 1 CO	SU-TQ/1W-WO	111447	1/40
Quartz	Week	2 / 2 CO	SU-TQ/2W-TW	111448	1/40

Digital Timers Z-SDM

- Digital timer with quartz control
- Automatic or manual control
- Automatic change summer/winter time
- Automatic leap year adjustment
- Single channel
- Power reserve (NiMH battery, EEPROM memory)
- Rated current 16 A (AC-1)
- Terminal capacity 1,5-4 mm²

Programme	Contacts	Type Designation	Article No.	Units per package
Day	1 CO	Z-SDM/1K-TA	248210	1
Week	1 CO	Z-SDM/1K-WO	248211	1
Week	2 CO	Z-SDM/2K-WO	248212	1

Accessories

Description	Type Designation	Article No.	Units per package
Terminal cover 2MU	Z7-SDM/AK-2TE	850000317	6
Mounting plate 2MU	Z7-SDM/MP-2TE	850000318	24



Technical information p. 200

Measuring Instruments Z-MG

• For measuring of 1-phase voltage and current

SG2802



Technical information p. 201

Analogue Ammeter and Voltmeter

Analogue instruments Z-MG/AA; Z-MG/VA

• Accuracy class 1.5
• Measuring range for direct measuring up to 40 A

• Type Z-MG/AA5-WS with exchangeable scale for indirect measuring up to 600 A
• Terminal capacity 4 mm² or 8 mm² for Z-MG/AA-40

Function	Range	Type Designation	Article No.	Units per package
Ammeter	0–10 A	Z-MG/AA-10	248228	1
Ammeter	0–40 A	Z-MG/AA-40	248229	1
Ammeter with exchangeable dial	0–600/5 A	Z-MG/AA5-WS	248227	1
Voltmeter	0–250 V	Z-MG/VA-250	248223	1
Voltmeter	0–500 V	Z-MG/VA-500	248224	1

Digital Ammeter and Voltmeter

Digital instruments Z-MG/AD; Z-MG/VD

• Accuracy class 1; + 1 digit
• Measuring range for direct measuring up to 20 A

• Type Z-MG/AD-999 for indirect measuring up to 1000 A
• Terminal capacity 4 mm²

SG11402



Technical information p. 202

Function	Range	Type Designation	Article No.	Units per package
Ammeter	0–20 A	Z-MG/AD-20	248225	1
Ammeter	0–999/5 A	Z-MG/AD-999	248226	1
Voltmeter	0–600 V	Z-MG/VD-600	248222	1
Ammeter + Voltmeter	0–8 kA / 5 A	Z-MG/VD+AD	263140	1
	0–600 V			
Ammeter + Voltmeter with 2 programmable contacts	0–8 kA / 5 A 0–600 V	Z-MG/VD+AD+S	263141	1

Accessories

Measuring current transformers Z-MG/WAS., Z-MG/WAK.; Exchangeable scales Z7-MG/WS. for Z-MG/AA5-WS

Exchangeable Scales for Z-MG/AA5-WS

SG8897



Exchangeable scales / 0-50	Z7-MG/WS-50	850001066	1
Exchangeable scales / 0-60	Z7-MG/WS-60	850001086	1
Exchangeable scales / 0-80	Z7-MG/WS-80	850001087	1
Exchangeable scales / 0-100	Z7-MG/WS-100	850001067	1
Exchangeable scales / 0-150	Z7-MG/WS-150	850001068	1
Exchangeable scales / 0-200	Z7-MG/WS-200	850001069	1
Exchangeable scales / 0-250	Z7-MG/WS-250	850001070	1
Exchangeable scales / 0-300	Z7-MG/WS-300	850001088	1
Exchangeable scales / 0-400	Z7-MG/WS-400	850001089	1
Exchangeable scales / 0-500	Z7-MG/WS-500	850001092	1
Exchangeable scales / 0-600	Z7-MG/WS-600	850001093	1

Current Transformers Z-MG/WA

• Current transformers with ratio x/5 A intended e.g. for measuring devices of line Z-MG
• Z-MG/WAK for cable with max. diameter 21 mm

• Z-MG/WAS for busbars up to 30 x 10 mm, 40 x 10 mm, 50 x 12 mm or cable with max. diameter 23/30 mm, acc. to type
• Without possibility of calibration

SG8797

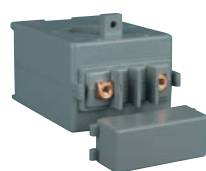

Technical information p. 203

For / Measuring range	Type Designation	Article No.	Units per package
Cable Ø 21 mm / 40/5	Z-MG/WAK-40	101619	1
Cable Ø 21 mm / 50/5	Z-MG/WAK-50	101620	1
Cable Ø 21 mm / 60/5	Z-MG/WAK-60	101621	1
Cable Ø 21 mm / 80/5	Z-MG/WAK-80	101622	1
Busbar 30 x 10 mm, cable Ø 21 mm / 100/5	Z-MG/WAS-100	101623	1
Busbar 30 x 10 mm, cable Ø 21 mm / 150/5	Z-MG/WAS-150	101625	1
Busbar 30 x 10 mm, cable Ø 21 mm / 200/5	Z-MG/WAS-200	101626	1
Busbar 30 x 10 mm, cable Ø 21 mm / 250/5	Z-MG/WAS-250	101627	1
Busbar 30 x 10 mm, cable Ø 21 mm / 300/5	Z-MG/WAS-300	101628	1
Busbar 30 x 10 mm, cable Ø 21 mm / 400/5	Z-MG/WAS-400	101629	1
Busbar 40 x 10 mm, cable Ø 30 mm / 500/5	Z-MG/WAS-500	101630	1
Busbar 40 x 10 mm, cable Ø 30 mm / 600/5	Z-MG/WAS-600	101631	1
Busbar 50 x 12 mm / 800/5	Z-MG/WAS-800	101632	1
Busbar 50 x 12 mm / 1000/5	Z-MG/WAS-1000	101624	1



Technical information p. 204

1-phase Power Meters KWZ-230, without calibration

- Power meter for measuring of active energy
- With electromechanic counter
- 1-phase power meter for direct measuring
- Maximum current 40 A
- Rated voltage 230 V
- Resolution 0.1 kWh
- Accuracy class 1
- Power meter according EN 61036 for sub-measurement
- Device cannot be calibrated

Range [digit]	Rated / max. current [A]	Type Designation	Article No.	Units per package
5+1	10 / 40	KWZ-230	286839	1/60

SG10007



KWZ-3PH-63

Technical information p. 205

3-phase Power Meters KWZ-3PH, without calibration

- Power meters for measuring of active energy
- With digital display
- 3-phase
- Rated voltage 230/400 V
- Accuracy class 1
- Programmable impulse output S0 (110 V / 50 mA)
- Power meter acc. to EN 62053 for sub-measurement
- Device cannot be calibrated

Measuring	Rated / max. current [A]	Type Designation	Article No.	Units per package
Semidirect	5 / 6	KWZ-3PH	110825	1/30
Direct	10 / 63	KWZ-3PH-63	110826	1/30

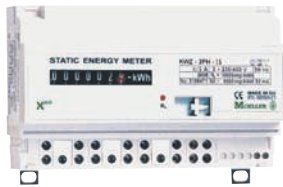
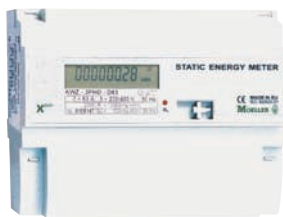

3-phase Power Meters KWZ-3PH., calibrated

- Power meters for measuring of active energy EN 62053-21
- KWZ-3PH with electromechanical counter
- KWZ-3PHD with digital display
- KWZ-3PH(D)-D63 for direct measuring up to 63 A, accuracy class 2
- Verze KWZ-3PH(D)-I5 for semidirect measuring with ratio X/5 A, accuracy class 1
- S0 test input as a standard for all types
- Digital version KWZ-3PHD in 1-tariff up to 4-tariff configuration
 - version -R with relay output,
 - version -C with communication module RS-485 (MODBUS RTU)
 - version -M with communication module M-BUS
- Type approval and calibration for Czech Rep.

Measuring / tariffs	Rated / max. current [A]	Output	Type Designation	Article No.	Units per package
---------------------	--------------------------	--------	------------------	-------------	-------------------

With electromechanical counter

Direct / 1	5 / 63	S0	KWZ-3PH-D63	999201153	1
Semidirect / 1	5 / 6	S0	KWZ-3PH-I5	999201156	1

With digital display, 1-tariff version

Direct / 1	5 / 63	S0	KWZ-3PHD-D63	999201172	1
Semidirect / 1	5 / 6	S0	KWZ-3PHD-I5	999201175	1
Direct / 1	5 / 63	relay	KWZ-3PHD-D63-R	999201414	1
Semidirect / 1	5 / 6	relay	KWZ-3PHD-I5-R	999201415	1
Direct / 1	5 / 63	RS-485	KWZ-3PHD-D63-C	999201417	1
Semidirect / 1	5 / 6	RS-485	KWZ-3PHD-I5-C	999201418	1
Direct / 1	5 / 63	M-BUS	KWZ-3PHD-D63-M	999201694	1
Semidirect / 1	5 / 6	M-BUS	KWZ-3PHD-I5-M	999201695	1

With digital display, 2-tariff version

Direct / 2	5 / 63	S0	KWZ-3PHD-D63-D	999201420	1
Semidirect / 2	5 / 6	S0	KWZ-3PHD-I5-D	999201421	1
Direct / 2	5 / 63	relay	KWZ-3PHD-D63-DR	999201423	1
Semidirect / 2	5 / 6	relay	KWZ-3PHD-I5-DR	999201424	1
Direct / 2	5 / 63	RS-485	KWZ-3PHD-D63-DC	999201426	1
Semidirect / 2	5 / 6	RS-485	KWZ-3PHD-I5-DC	999201427	1
Direct / 2	5 / 63	M-BUS	KWZ-3PHD-D63-DM	999201696	1
Semidirect / 2	5 / 6	M-BUS	KWZ-3PHD-I5-DM	999201697	1

Terminal cover KWZ-SCOV

- For power meters KWZ-3PH(D)-D63(I5)
- Can be sealed

Description	Type Designation	Article No.	Units per package
Sealable terminal cover	KWZ-SCOV	999201447	2

Technical information p. 207

Measuring modules NZM-XMC

- Measuring modules for net analysis
- Possibility of direct mounting onto NZM circuit breaker cables or onto mounting panel
- Versions – MB: possibility to display data at NZM-XMC-DISP or via MODBUS at other device (e.g. touch panels XV100)
- Display NZM-XMC-DISP with standard frame 96x96 mm
- Version with S0 output, or with MODBUS (one slot for external communication, the other for connection of NZM-XMC-DISP)
- Voltage measurement up to 690 V, accuracy 0,5 %
- Current measurement up to 500 A, accuracy 0,5 %
- Active and inductive reactive energy measurement including component analysis, accuracy 1 % and 2 %, respectively
- Temperature measurement
- Extension cards (measurement of residual currents, analogue output, digital I/O), in preparation
- Version NZM2-... with distance for cables connected to NZM2 circuit breaker
- Version NZM3-... with distance for cables connected to NZM3 circuit breaker
- All MODBUS versions can operate as a slave on PROFIBUS-DP via adapter

NZM-XMC-DISP_HPL-2



NZM-XMC-DISP

NZM2-XMC-MB



NZM2-XMC-MB

Description	Number of poles	Rated current [A]	Type Designation	Article No.	Units per package
Module with 1 output S0	3	300	NZM2-XMC-S0	129839	1
Module with 1 output S0	3	500	NZM3-XMC-S0	129960	1
Module with MODBUS, bus for DISP and 2 x S0	3	300	NZM2-XMC-MB	129961	1
Module with MODBUS, bus for DISP and 2 x S0	3	500	NZM3-XMC-MB	129962	1
Module with output S0	4	300	NZM2-4-XMC-S0	129963	1
Module with output S0	4	500	NZM3-4-XMC-S0	129964	1
Module with MODBUS, bus for DISP and 2 x S0	4	300	NZM2-4-XMC-MB	129965	1
Module with MODBUS, bus for DISP and 2 x S0	4	500	NZM3-4-XMC-MB	129966	1
Display for versions - MB	-	-	NZM-XMC-DISP	129967	1
Power supply	-	-	NZM-XMC-AC	129968	1

Current Transformers MAK

- Current transformers for cables and busbars
- Versions "cej" with type approval and calibration for Czech Rep.
- Other types see Pricelist



MAK 45/21



MAK 62/30



MAK 62/40



MAK 62/WS



MAK 62/R



MAK 74/40



MAK 74/50

Description (Max. busbar dimensions)	Type Designation	Article No.	Units per pack.
For cable max. \varnothing 20 mm	MAK 45/21 50/5A 1VA 1%	999201706	1
	MAK 45/21 100/5A 2,5VA 1%	999201060	1
	MAK 45/21 150/5A 2,5VA 1%	999201061	1
	MAK 45/21 250/5A 5VA 1%	999201062	1
	MAK 45/21 400/5A 5VA 1%	999201063	1
For busbar 20 x 10 mm	MAK 62/20 100/5A 5VA 1%	999201064	1
	MAK 62/20 150/5A 7,5VA 1%	999201066	1
	MAK 62/20 200/5A 10VA 1%	999201068	1
For busbar 30 x 10 mm	MAK 62/30 50/5A 1,5VA 1%	999201306	1
	MAK 62/30 75/5A 1,5VA 1%	999201307	1
	MAK 62/30 100/5A 2,5VA 1%	999201072	1
	MAK 62/30 150/5A 5VA 1%	999201073	1
	MAK 62/30 200/5A 5VA 0,5%	999201074	1
	MAK 62/30 250/5A 5VA 0,5%	999201076	1
	MAK 62/30 300/5A 10VA 1%	999201078	1
	MAK 62/30 300/5A 5VA 0,5%	999201080	1
	MAK 62/30 300/5A 5VA 0,5% cej.	999201081	1
	MAK 62/30 400/5A 5VA 0,5%	999201084	1
	MAK 62/30 600/5A 5VA 0,5%	999201092	1
	MAK 62/30 600/5A 10VA 1%	999201090	1
	For busbar 40 x 10 mm	MAK 62/40 200/5A 3,75VA 1%	999201095
MAK 62/40 250/5A 2,5VA 0,5%		999201096	1
MAK 62/40 250/5A 5VA 1%		999201310	1
MAK 62/40 300/5A 5VA 0,5%		999201097	1
MAK 62/40 300/5A 5VA 1%		999201099	1
MAK 62/40 400/5A 5VA 0,5%		999201100	1
MAK 62/40 400/5A 5VA 1%		999201102	1
MAK 62/40 500/5A 7,5VA 1%		999201103	1
MAK 62/40 500/5A 5VA 0,5%		999201104	1
MAK 62/40 600/5A 5VA 0,5%		999201105	1
With primary winding, connection M8	MAK 62/WS 75/5A 5VA 0,5%	999201109	1
	MAK 62/WS 75/5A 5VA 0,5% cej.	999201110	1
	MAK 62/WS 100/5A 5VA 0,5% cej.	999201112	1
	MAK 62/WS 125/5A 5VA 0,5% cej.	999201114	1
	MAK 62/WS 150/5A 5VA 0,5% cej.	999201116	1
For cable max. \varnothing 22 mm	MAK 62/R 150/5A 5VA 1%	999201311	1
	MAK 62/R 250/5A 5VA 1%	999201117	1
	MAK 62/R 400/5A 5VA 1%	999201118	1
	MAK 62/R 600/5A 5VA 1%	999201119	1
For busbar 40 x 12 mm	MAK 74/40 200/5A 5VA 0,5%	999201120	1
	MAK 74/40 300/5A 5VA 0,5%	999201121	1
	MAK 74/40 400/5A 5VA 0,5%	999201122	1
For busbar 50 x 12 mm	MAK 74/50 400/5A 5VA 0,5%	999201126	1
	MAK 74/50 600/5A 5VA 0,5%	999201127	1
	MAK 74/50 1000/5A 5VA 0,5%	999201129	1

Current Transformers - continuation



MAK 86/50



MAK 86/60



MAK 104/80



MAK 140/100/H

Busbar dimensions	Type Designation	Article No.	Units per pack.
For busbar 40 x 10 mm	MAK 86/40 300/5A 10VA 0,5%	999201133	1
	MAK 86/40 400/5A 10VA 0,5%	999201134	1
For busbar 50 x 12 mm	MAK 86/50 400/5A 10VA 0,5%	999201135	1
	MAK 86/50 500/5A 10VA 0,5%	999201136	1
	MAK 86/50 600/5A 10VA 0,5%	999201137	1
	MAK 86/50 600/5A 15VA 0,5%	999201138	1
	MAK 86/50 800/5A 15VA 0,5%	999201139	1
	MAK 86/50 1000/5A 10VA 0,5%	999201140	1
	MAK 86/50 1000/5A 15VA 0,5%	999201141	1
For busbar 60 x 12 mm	MAK 86/60 600/5A 10VA 0,5%	999201142	1
	MAK 86/60 600/5A 15VA 1%	999201143	1
	MAK 86/60 1000/5A 15VA 0,5%	999201144	1
For busbar 80 x 12 mm	MAK 104/80 1500/5A 30VA 1%	999201145	1
For busbar 100 x 30 mm	MAK 140/100/H 1500/5A 45VA 0,5%	999201146	1
	MAK 140/100/H 1500/5A 45VA 1%	999201147	1
	MAK 140/100/V 1500/5 0,5%	999201711	1
	MAK 140/100/V 1500/5 1%	999201712	1
	MAK 140/100/H 1600/5A 15VA 1%	999201148	1
	MAK 140/100H 2000/5 1%	999201198	1

Technical information p. 210

Operating Hours Counter BSZ, Pulse Counter Z-IMZ

- For gathering operating time data of machines
- Terminal capacity 0.14–4 mm²
- Rated voltage 230 V or 24 V, 50 Hz
- With electromechanical counter without possibility of zeroing

SG15805



Range [digit]	Rated voltage (AC)	Type Designation	Article No.	Units per package
5+2	230 V	BSZ/230	276309	1/60
5+2	24 V	BSZ/24	276308	1/60
7	230 V	Z-IMZ/230	248206	1/60
7	24 V	Z-IMZ/24	248207	1/60

Technical information p. 212

Buzzer Z-SUM, Bell Z-GLO

- Without sparking
- Degree of protection IP20
- Terminal capacity max. 10 mm²

SG1902



Function	Rated voltage AC	Type Designation	Article No.	Units per package
Buzzer	230 V	Z-SUM230	270584	2/120
Buzzer	24 V	Z-SUM24	270583	2/120
Buzzer	12 V	Z-SUM12	271087	2/120
Bell	230 V	Z-GLO230	270586	2/120
Bell	24 V	Z-GLO24	270585	2/120
Bell	12 V	Z-GLO12	271088	2/120

Technical information p. 212

Manual Motor Starters Z-MS

- Reliable protection in case of thermal overload and short circuit
- Magnetic short-circuit tripping fixed
- Thermal overload tripping adjustable
- Suitable for small distribution boxes
- Contact position indicator red-green
- Busbar positioning optionally above or below
- Main application fields: switching and protection of 3-phase motors up to 15 kW (380/400 V) or other consumers up to 40 A
- Also suitable as main switch
- Isolating characteristics according to EN 60947
- Accessories compatible with PL7, PL6 etc.

SG17802



SG17902



Num. of poles	Range [A]	Type Designation	Article No.	Units per package
2	0.10–0.16	Z-MS-0,16/2	248389	1/60
2	0.16–0.25	Z-MS-0,25/2	248390	1/60
2	0.25–0.40	Z-MS-0,40/2	248391	1/60
2	0.40–0.63	Z-MS-0,63/2	248392	1/60
2	0.63–1.00	Z-MS-1,0/2	248393	1/60
2	1.00–1.60	Z-MS-1,6/2	248394	1/60
2	1.60–2.50	Z-MS-2,5/2	248395	1/60
2	2.50–4.00	Z-MS-4,0/2	248396	1/60
2	4.00–6.30	Z-MS-6,3/2	248397	1/60
2	6.30–10.0	Z-MS-10/2	248398	1/60
2	10.0–16.0	Z-MS-16/2	248399	1/60
2	16.0–25.0	Z-MS-25/2	248400	1/60
2	25.0–40.0	Z-MS-40/2	248401	1/60
3	0.10–0.16	Z-MS-0,16/3	248402	1/40
3	0.16–0.25	Z-MS-0,25/3	248403	1/40
3	0.25–0.40	Z-MS-0,40/3	248404	1/40
3	0.40–0.63	Z-MS-0,63/3	248405	1/40
3	0.63–1.00	Z-MS-1,0/3	248406	1/40
3	1.00–1.60	Z-MS-1,6/3	248407	1/40
3	1.60–2.50	Z-MS-2,5/3	248408	1/40
3	2.50–4.00	Z-MS-4,0/3	248409	1/40
3	4.00–6.30	Z-MS-6,3/3	248410	1/40
3	6.30–10.0	Z-MS-10/3	248411	1/40
3	10.0–16.0	Z-MS-16/3	248412	1/40
3	16.0–25.0	Z-MS-25/3	248413	1/40
3	25.0–40.0	Z-MS-40/3	248414	1/40

Accessories

Function	Type Designation	Article No.	Units per package
Shunt trip release 24 V	ZP-ASA/24	248438	6/60
Shunt trip release 230 V	ZP-ASA/230	248439	6/60
Undervoltage release 230 V	Z-USA/230	248289	6/60
Undervoltage release 400 V	Z-USA/400	248290	6/60
Delayed undervoltage release 230 V	Z-USD/230	248291	6/60
Auxiliary switch	ZP-IHK	286052	4/120
Aux. and tripping sig. switch	ZP-NHK	248437	4/120
Remote control switching dev.	Z-FW-LP	248296	1/20
Moisture-proof enclosure	Z-MFG	248383	1
Moisture-proof encl. N-cond.	Z-MFG/NL	248384	1
Moisture-proof encl. EM.-OFF	Z-MFG/NOT	248385	1
Additional terminal 35 mm ²	Z-HA-EK/35	263960	12/720
Switching interlock without lock	Z-IS/SPE-1TE	274418	5/30

Technical information p. 213

Moisture-Proof Enclosure Z-MFG, IP 54

- Design according to EN 50298
- Suitable for motor starters Z-MS, e.g. 3-pole (+Z-USA), MCBs, switches etc.
- Earth conductor connection integrated in all types
- Delivered with 4 grommets PG 16
- Enclosure cover can be sealed with leads in 2 locations
- Scope of delivery for Z-MFG/NOT: 4 entry bushes, 1 mushroom-shaped pushbutton (red) + 1 NC contact for undervoltage release
- Turning handle, can be locked in the OFF-position by means of 3 padlocks, max. ø 6 mm

SG0600



Function	Type Designation	Article No.	Units per package
ON/OFF	Z-MFG	248383	1
ON/OFF N-terminal	Z-MFG/NL	248384	1
ON/OFF + EMERGENCY OFF + N-terminal	Z-MFG/NOT	248385	1

Note: Designed for MCBs, switches and motor starters Moeller

Technical information p. 216

VT4900



Compact Enclosure KLV-TC

- Degree of protection IP30
- Without door
- For 45 mm devices for modular installation
- Can be sealed

Width MU	Type Designation	Article No.	Units per package
1+1 Enclosure without terminal	KLV-TC-2	276240	1
3+1 Enclosure without terminal	KLV-TC-4	276241	1
6+2 Enclosure without terminal	KLV-TC-8	276242	1
3+1 Enclosure with terminal	KLV-TC-4-TB	276243	1
6+2 Enclosure with terminal	KLV-TC-8-TB1	276244	1
6+2 Enclosure with double-length terminal	KLV-TC-8-TB2	276245	1
Terminal for KLV-TC-4	KLV-TC-TB-4/4	276246	1
Terminal for KLV-TC-8	KLV-TC-TBC-4/4	276247	1
Double-length terminal for KLV-TC-8	KLV-TC-TBC-4/4+4	276248	1

Technical information p. 217

1442



Enclosure ISO

- Plastic enclosure with terminal and busbar
- 1-row
- 45 mm device cut-out
- Terminal included
- ISO 0 - KL7 (7 x 16 mm²)
- ISO 1 - KL15 (15 x 16 mm²)

Width MU	Type Designation	Article No.	Units per package
7	ISO 0	770502401	1
15	ISO 1	770502402	1

Technical information p. 217

1434



Universal Enclosure

- For devices with frame size 45 mm
- Side boards and profiled strips are connected with glue
- KLV-LV-SP-45 – side boards
- KLV-LV-PL-45 – profiled strips 2 m

Description	Type Designation	Article No.	Units per package
Side board	KLV-LV-SP-45	279265	2
Profiled strip 2 m	KLV-LV-PL-45	279266	1

373703



Marking Tables GR

- Sticky labels for clear assign accessories of devices to circuits
- Pre-printed marks for usual circuits

Num. of labels / Dimension	Type Designation	Article No.	Units per package
30 210x120 mm	GR-2	138103900	1
90 210x300 mm	GR-3	138104100	1

SG01006



Plastic Box Z-BOX

- Empty boxes for mounting onto device rail
- Dimensions 45 x 54 x 75 mm
- For frontplates with device cutout 45 mm
- Draw-out design
- Suitable for spare parts (e.g. fuse links)

Colour	Type Designation	Article No.	Units per package
violet	Z-BOX/VIO	286056	12/120
pink	Z-BOX/ROS	286057	12/120
brown	Z-BOX/BRA	286058	12/120
green	Z-BOX/GRU	286059	12/120
red	Z-BOX/ROT	286060	12/120
grey	Z-BOX/GRA	286061	12/120
blue	Z-BOX/BLA	286062	12/120
yellow	Z-BOX/GEL	286063	12/120
black	Z-BOX/SCH	286064	12/120
white	Z-BOX/WEI	286065	12/120
copper	Z-BOX/KUP	286066	12/120

Busbar Systems

- For simple connection of Moeller devices
- Easy mounting
- Rated cross-section 10, 16, 35 mm²

SG7997

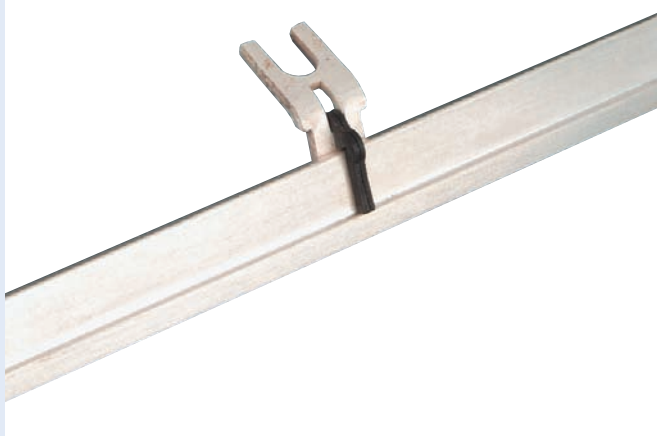

SG4700

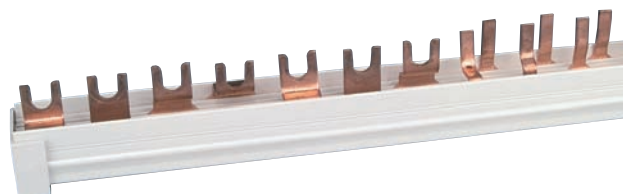

Universal busbar system ZV

- Universal busbar system
- For installation devices series Moeller line Xpole (PL7, PL6, PF7, PF6, PHF7, dRCM, PFL7, PFL6, PFR,...)
- Rated current 50 and 80 A
- Optional placing of connection points of particular phases, arbitrary combinations can be created
- Connection modules Z-D63 and Z-D80 can be used for power supply

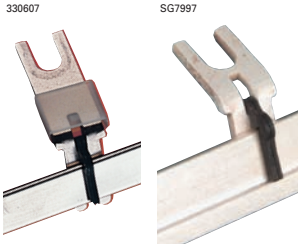

Technical information p. 218

Description	Current	Type Designation	Article No.	Units per package
Conn. angle L1, N	50 A	ZV-L1/N-10	263941	10/600
Conn. angle L2, L3	50 A	ZV-L2/L3-10	263944	10/600
Conn. angle N (0.5 MU)	50 A	ZV-N-05TE-10	263947	10/600
Busbar 1 m	50 A	ZV-SS	263956	1/10
Conn. angle L1, N	80 A	ZV-L1/N-80A-10	263950	10/600
Conn. angle L2, L3	80 A	ZV-L2/L3-80A-10	263953	10/600
Busbar 1 m	80 A	ZV-SS-80A	263957	1/10
Cover section 1 m	50+80 A	ZV-ADP	263958	1/10
End caps for busbar cover		ZV-AEK	263959	1/600

Busbar Block Z-GV general length

- Busbar system with fixed spacing and position of terminals
- For installation devices series Moeller line Xpole (PL7, PL6, PF7, PF6, PHF7, dRCM, PFL7, PFL6, PFR,...), without auxiliary contacts
- Cross section 10 and 16 mm² for rated currents 63 A and 80 A, respectively
- Connection modules Z-D63 and Z-D80 can be used for power supply
- Length 1 m
- End caps must be ordered separately
- Version with step 1.5 MU and 3x1+0.5 MU can be used for devices equipped with auxiliary contact (not connected to busbar)
- Terminal shape - pin

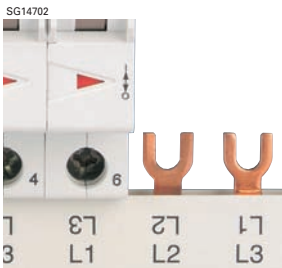

Technical information p. 219

Description	Rated Current [A]	Type Designation	Article No.	Units per package
10 mm²				
Busbar 1p, 1 MU	63	Z-GV-10/1P-1TE	270339	50
Busbar 3p, 3x1 MU	63	Z-GV-10/3P-3TE	271060	20
End cap 1p	-	Z-V-AK/1P	104905	10/600
End cap 3p	-	Z-AK-10/2+3P	271069	10/600
16 mm²				
Busbar 1p, 1 MU	80	Z-GV-16/1P-1TE	271061	50
Busbar 1p, 1,5 MU	80	Z-GV-16/1P+HS	271062	50
Busbar 2p, 2x1 MU	80	Z-GV-16/1P+N-2TE	271063	20
Busbar 3p, 3x1 MU	80	Z-GV-16/3P-3TE	271064	20
Busbar 3p, 3x1+0,5 MU	80	Z-GV-16/3P+HS	271065	20
Busbar 4p, 4x1 TMUE	80	Z-GV-16/3P+N-4TE	271066	15
Busbar 4p (3p+3N), 3x(1+1) MU	80	Z-GV-16/3P+3N-6TE	263142	15
End cap 1p	-	Z-V-AK/1P	104905	10/600
End cap 2 a 3p	-	Z-AK-16/2+3P	271070	10/600
End cap 4p	-	Z-AK-16/4P	271071	10/600

Busbar Block Z-GV shortened

- Busbar system with fixed spacing and position of terminals
- For installation devices series Moeller line Xpole (PL7, PL6, PF7, PF6, PHF7, dRCM, PFL7, PFL6, PFR,...), without auxiliary contacts
- Cross section 16 mm² for rated current 80 A
- Connection modules Z-D80 can be used for power supply
- Including end caps
- Terminal shape - fork

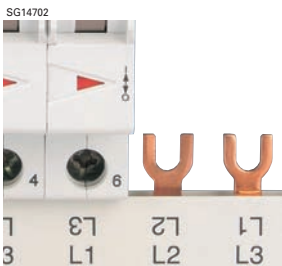

Technical information p. 219

Description	Total length	Rated Current [A]	Type Designation	Article No.	Units per package
16 mm²					
Busbar 1p, 16 x (1 MU)	16 MU	80	Z-GV-16/1P-1TE/16	271074	50
Busbar 2p, 16 x (2x1 MU)	16 MU	80	Z-GV-16/1P+N-2TE/16	271075	20
Busbar 3p, 2 x (3x1 MU)	8 MU	80	Z-GV-16/3P-3TE/8	271073	40
Busbar 3p, 5 x (3x1 MU)	16 MU	80	Z-GV-16/3P-3TE/16	271076	20
Busbar 4p, 4 x (4x1 MU)	16 MU	80	Z-GV-16/3P+N-4TE/16	271078	15

SG05705

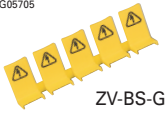

ZV-BS-G

Busbar Tag Shrouds ZV-BS-G

- For shrouding of unused terminals Z-GV-1TE
- 1 pc = 5-shroud set

Description	Type Designation	Article No.	Units per package
Busbar Tag Shrouds	ZV-BS-G	104903	10/600

SG14602

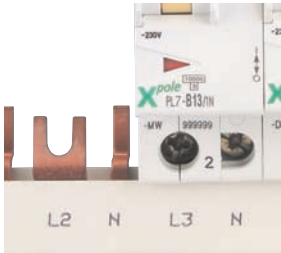

Busbar Block Z-GSV general length

- Busbar system with fixed spacing and position of terminals
- For 1+N-pole circuit breakers PL7 (1.5 MU), without auxiliary contacts
- Versions for combination with other devices of series Moeller Xpole (PL7, PL6, PF7, PF6, PHF7, dRCM, PFL7, PFL6, PFR,...)
- Cross section 16 mm² for rated current 80 A
- Connection modules Z-D80 can be used for power supply
- Length 1 m
- End caps must be ordered separately
- Terminal shape – fork (phase, N-pole 1 MU), pin (N-pole 0.5 MU)

Description	Rated Current [A]	Type Designation	Article No.	Units per package
16 mm²				
Busbar 2p (1p+N), 1+0,5 MU	80	Z-GSV-16/1P+N	271067	10
Busbar 4p (3p+3N), 3x(1+0,5) MU	80	Z-GSV-16/3P+3N	271068	10
Busbar 3x4p + 30x2p (1p+N), 3x(4x1)+30x(1+0,5) MU	80	Z-GSV-16/FI-EH+KR+30XLS1N	113137	7
End cap 2p	-	Z-AK-16/2+3P	271070	10/600
End cap 4p	-	Z-AK-16/4P	271071	10/600
End cap (4p+2p)	-	Z-V-AK/4P	264931	10/600

Technical information p. 220

SG14602

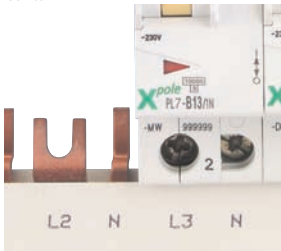

Busbar Block Z-GSV shortened

- Busbar system with fixed spacing and position of terminals
- For 1+N-pole circuit breakers PL7 (1.5 MU), without auxiliary contacts
- Versions for combination with other devices of series Moeller Xpole (PL7, PL6, PF7, PF6, PHF7, dRCM, PFL7, PFL6, PFR,...)
- Cross section 10 and 16 mm² for rated currents 63 and 80 A, respectively
- Connection modules Z-D63 and Z-D80 can be used for power supply
- Including end caps
- Terminal shape – fork (phase), pin (N-pole 0.5 MU)

Description	Rated Current [A]	Type Designation	Article No.	Units per package
10 mm²				
Busbar 2x4p + 2x2p (1p+N), 2x(4x1)+2x(1+0,5) MU	63	Z-GSV-10/FI+EH+2XLS1N	113138	10
Busbar 2x4p + 4x2p (1p+N), 2x(4x1)+4x(1+0,5) MU	63	Z-GSV-10/FI+EH+4XLS1N	113139	10
16 mm²				
Busbar 2p (1p+N), 9 x (1+0,5) MU	80	Z-GSV-16/1P+N/9	271077	15
Busbar 4p (3p+3N), 3 x (3x(1+0,5)) MU	80	Z-GSV-16/3P+3N/9	271079	15

Technical information p. 220

Busbar Block Z-SV...-SD for device rail mounted sockets

- Special busbars for sockets Z-SD... (placing of sockets one besides the other)
- Cross section 10 mm² for rated current 50 A
- Length 1 m

Description	Rated Current [A]	Type Designation	Article No.	Units per package
10 mm²				
Busbar 2p (1p+N)	50	Z-SV-10/1P+N-SD	269526	10
End cap	-	Z-V-AK/2+3P	264930	10/600

Technical information p. 221

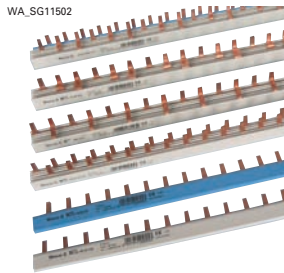

Busbar Block Z-SV (1.5 MU)

- Busbar system with fixed spacing and position of terminals
- For circuit breakers PLHT, fuse switch disconnectors and fuse bases Z-SLS, D0.-SO/..
- Cross section 16 and 35 mm² for rated currents 80 and 110 A, respectively
- Length 1 m
- End caps must be ordered separately (type Z-SV-35/3P+N-6TE delivered with end caps)
- Terminal shape – pin

Description	Rated Current [A]	Type Designation	Article No.	Units per package
16 mm²				
Busbar 3p, 3x1,5 MU	80	Z-SV-16/3P	271072	20
End cap	-	Z-AK-16/2+3P	271070	10/600
35 mm²				
Busbar 1p, 1,5 MU	110	Z-SV-35/1P	113135	1
Busbar 3p, 3x1,5 MU	110	Z-SV-35/3P	264938	4
Busbar 3p, 3x1,5 MU	110	Z-SV-35/PLHT-V	264939	4
Busbar 4p (3p+N), 4x1,5 MU	110	Z-SV-35/3P+N-6TE	263110	4
End cap	-	Z-V-35/AK/3P	264932	10/600

Extension terminal Z-EK

- Z-EK/50 for conductors 6-50 mm²
- Z-EK/95 for solid and multi wired conductors 25-70 mm² and fine wired conductors with ferrule 16-70 mm²
- For possible configuration see e.g. p. 248



For device on rail	Type Designation	Article No.	Units per package
Z-SV-16/3P	Z-EK/50	264934	3/180
Z-SV-35/1P	Z-EK/95-1	113136	3/90
Z-SV-... 3P	Z-EK/95	264933	3/90
Z-SV-35/3P+N	Z-EK/95-3N	264911	4/120

Euro-Vario-Busbar EVG

- Busbar system with fixed spacing and position of terminals
- For installation devices series Moeller line Xpole (PL7, PL6, PF7, PF6, PHF7, dRCM, PFL7, PFL6, PFR,...)
- Versions for device without or with auxiliary contact (not connected to busbar)
- 3-pole version for combination with 4-pole RCD when N-conductor is not connected to busbar
- Connection modules Z-D63 and Z-D80 can be used for power supply
- Various length, cannot be cut
- End-cap-less design
- Terminal shape – fork

Version for devices with 1 MU step without auxiliary contacts

WA_SG02902



Description	Total length	Rated Current [A]	Type Designation	Article No.	Units per package
10 mm²					
Busbar 1p, 1 MU	2 MU	63	EVG-1PHAS/2MODUL	215646	40/800
Busbar 1p, 1 MU	6 MU	63	EVG-1PHAS/6MODUL	215638	40/800
Busbar 1p, 1 MU	12 MU	63	EVG-1PHAS/12MODUL	215637	40/400
Busbar 2p (1p+N), 2x1 MU	4 MU	63	EVG-2PHAS/4MODUL	268220	20/400
Busbar 2p (1p+N), 2x1 MU	6 MU	63	EVG-2PHAS/6MODUL	215642	20/400
Busbar 2p (1p+N), 2x1 MU	12 MU	63	EVG-2PHAS/12MODUL	215641	20/200
Busbar 3p, 3x1 MU	6 MU	63	EVG-3PHAS/6MODUL	215640	20/400
Busbar 3p, 3x1 MU	9 MU	63	EVG-3PHAS/9MODUL	215645	20/200
Busbar 3p, 3x1 MU	12 MU	63	EVG-3PHAS/12MODUL	215639	20/200
Busbar 3p, 3x1 MU	16 MU	63	EVG-3PHAS/16MODUL	285381	20
Busbar 3p, 3x1 MU	20 MU	63	EVG-3PHAS/20MODUL	285383	20/180
Busbar 4p (3p+3N), 3x(1+1) MU	16 MU	63	EVG-3P+3N/16MODUL	105215	20
Busbar 4p (3p+3N), 3x(1+1) MU	18 MU	63	EVG-3P+3N/18MODUL	274161	20
Busbar 4p (3p+N), 4x1 MU	8 MU	63	EVG-4PHAS/8MODUL	215644	10/100
Busbar 4p (3p+N), 4x1 MU	12 MU	63	EVG-4PHAS/12MODUL	215643	10/100
16 mm²					
Busbar 1p, 1 MU	2 MU	80	EVG-16/1PHAS/2MODUL	291464	40/800
Busbar 1p, 1 MU	6 MU	80	EVG-16/1PHAS/6MODUL	291465	40/800
Busbar 1p, 1 MU	12 MU	80	EVG-16/1PHAS/12MODUL	291466	40/400
Busbar 2p (1p+N), 2x1 MU	4 MU	80	EVG-16/2PHAS/4MODUL	291467	20/400
Busbar 2p (1p+N), 2x1 MU	6 MU	80	EVG-16/2PHAS/6MODUL	291468	20/400
Busbar 2p (1p+N), 2x1 MU	12 MU	80	EVG-16/2PHAS/12MODUL	291469	20/200
Busbar 3p, 3x1 MU	6 MU	80	EVG-16/3PHAS/6MODUL	291470	20/400
Busbar 3p, 3x1 MU	9 MU	80	EVG-16/3PHAS/9MODUL	291471	20/200
Busbar 3p, 3x1 MU	12 MU	80	EVG-16/3PHAS/12MODUL	291472	20/200
Busbar 3p, 3x1 MU	16 MU	80	EVG-16/3PHAS/16MODUL	291473	20/80
Busbar 3p, 3x1 MU	20 MU	80	EVG-16/3PHAS/20MODUL	291474	10/100
Busbar 4p (3p+N), 4x1 MU	8 MU	80	EVG-16/4PHAS/8MODUL	291475	10/100
Busbar 4p (3p+N), 4x1 MU	12 MU	80	EVG-16/4PHAS/12MODUL	291476	10/100

Version for devices with 1 MU step without auxiliary contacts in combination with 4-pole RCD when N-conductor is not connected to busbar

Description	Total length	Rated Current [A]	Type Designation	Article No.	Units per package
10 mm²					
Busbar 3p, (3+1) + 5x1 MU	9 MU	63	EVG-3PHAS/N/5MODUL/LS	215659	20/200
Busbar 3p, (3+1) + 8x1 MU	12 MU	63	EVG-3PHAS/N/8MODUL/LS	215660	20/200
16 mm²					
Busbar 3p, (3+1) + 5x1 MU	9 MU	80	EVG-16/3PHAS/N/5MODUL/LS	291477	20/200
Busbar 3p, (3+1) + 8x1 MU	12 MU	80	EVG-16/3PHAS/N/8MODUL/LS	291478	20/200

Version for devices with 1 MU step with auxiliary contact (not connected to busbar)

Description	Total length	Rated Current [A]	Type Designation	Article No.	Units per package
10 mm²					
Busbar 1p, 2x(1+0,5) MU	2,5 MU	63	EVG-1PHAS/2MODUL/HI	215655	40/200
Busbar 1p, 9x(1+0,5) MU	13 MU	63	EVG-1PHAS/9MODUL/HI	215656	40
Busbar 2p (1p+N), 2x(1+1+0,5) MU	4,5 MU	63	EVG-2PHAS/4MODUL/HI	219573	20/400
Busbar 2p (1p+N), 5x(1+1+0,5) MU	12 MU	63	EVG-2PHAS/10MODUL/HI	215657	20
Busbar 3p, 2x(3x1+0,5) MU	6,5 MU	63	EVG-3PHAS/6MODUL/HI	216411	20/200
Busbar 3p, 4x(3x1+0,5) MU	13,5 MU	63	EVG-3PHAS/12MODUL/HI	215658	20
16 mm²					
Busbar 1p, 2x(1+0,5) MU	2,5 MU	80	EVG-16/1PHAS/2MODUL/HI	291479	40/800
Busbar 1p, 6x(1+0,5) MU	8,5 MU	80	EVG-16/1PHAS/6MODUL/HI	291480	40/400
Busbar 1p, 9x(1+0,5) MU	13 MU	80	EVG-16/1PHAS/9MODUL/HI	291481	40/160
Busbar 2p (1p+N), 2x(1+1+0,5) MU	4,5 MU	80	EVG-16/2PHAS/4MODUL/HI	291482	20/400
Busbar 2p (1p+N), 3x(1+1+0,5) MU	7 MU	80	EVG-16/2PHAS/6MODUL/HI	291483	20/200
Busbar 2p (1p+N), 5x(1+1+0,5) MU	12 MU	80	EVG-16/2PHAS/10MODUL/HI	291484	20/200
Busbar 3p, 2x(3x1+0,5) MU	6,5 MU	80	EVG-16/3PHAS/6MODUL/HI	291485	20/200
Busbar 3p, 4x(3x1+0,5) MU	13,5 MU	80	EVG-16/3PHAS/12MODUL/HI	291486	20/80
Busbar 3p, 2x3x(1+0,5) MU	8,5 MU	80	EVG-16/3x1PHAS/6MODUL/HI	291487	20/200
Busbar 3p, (2+2/3)x3x(1+0,5) MU	11,5 MU	80	EVG-16/3x1PHAS/8MODUL/HI	291488	20/200
Busbar 3p, 3x3x(1+0,5) MU	13 MU	80	EVG-16/3x1PHAS/9MODUL/HI	291489	20/80

Fuse-links and Fuse Disconnectors

- Fuse-links D II, D III, D IV up to 100 A and accessories
- Fuse disconnectors VLC for cylindrical fuse-links up to 100 A
- Cylindrical fuse-links up to 100 A
- Fuse disconnectors for cylindrical fuse links for photovoltaic applications
- Fuse systems and fuse links D0
- NH fuse links
- Fuse systems for NH fuse links



Fuse-links D II, D III, D IV

- Design according to EN 60269-1, EN 60269-3
- For fuse bases DII-SO..., DIII-SO...
- Delayed fuse links gG (gL)
- Standard fuse links DZ
- Rated voltage of fuse links DII, DIII 500 V AC / 400 V DC
- Rated voltage of fuse links DIV 500 V AC

SG19007



SG19107



Type	Characteristic	Rated current [A]	Type Designation	Article No.	Units per package
DII E27	delayed gG	2	Z-DII/SE-2A/GG	112125	5/500
DII E27	delayed gG	4	Z-DII/SE-4A/GG	112126	5/500
DII E27	delayed gG	6	Z-DII/SE-6A/GG	112127	5/500
DII E27	delayed gG	10	Z-DII/SE-10A/GG	112128	5/500
DII E27	delayed gG	16	Z-DII/SE-16A/GG	112129	5/500
DII E27	delayed gG	20	Z-DII/SE-20A/GG	112130	5/500
DII E27	delayed gG	25	Z-DII/SE-25A/GG	112131	5/500
DII E27	standard DZ	2	Z-DII/SE-2A/DZ	112028	5/500
DII E27	standard DZ	4	Z-DII/SE-4A/DZ	112029	5/500
DII E27	standard DZ	6	Z-DII/SE-6A/DZ	112120	5/500
DII E27	standard DZ	10	Z-DII/SE-10A/DZ	112121	5/500
DII E27	standard DZ	16	Z-DII/SE-16A/DZ	112122	5/500
DII E27	standard DZ	20	Z-DII/SE-20A/DZ	112123	5/500
DII E27	standard DZ	25	Z-DII/SE-25A/DZ	112124	5/500
DIII E33	delayed gG	35	Z-DIII/SE-35A/GG	112135	5/500
DIII E33	delayed gG	50	Z-DIII/SE-50A/GG	112136	5/500
DIII E33	delayed gG	63	Z-DIII/SE-63A/GG	112137	5/500
DIII E33	standard DZ	35	Z-DIII/SE-35A/DZ	112132	5/500
DIII E33	standard DZ	50	Z-DIII/SE-50A/DZ	112133	5/500
DIII E33	standard DZ	63	Z-DIII/SE-63A/DZ	112134	5/500
DIV	delayed gG	80	D IV-80 A gG	852314401	25/500
DIV	delayed gG	100	D IV-100 A gG	852314402	25/500
DIV	standard	80	D IV-80 A	852314101	25/500
DIV	standard	100	D IV-100 A	852314102	25/500

Technical information p. 224

Screw-in Gauge Ring Z-DII./PS

For size	Rated current [A]	Type Designation	Article No.	Units per package
DII E27	2	Z-DII/PS-2A	112138	25/1500
DII E27	4	Z-DII/PS-4A	112139	25/1500
DII E27	6	Z-DII/PS-6A	112140	25/1500
DII E27	10	Z-DII/PS-10A	112141	25/1500
DII E27	16	Z-DII/PS-16A	112142	25/1500
DII E27	20	Z-DII/PS-20A	112143	25/1500
DII E27	25	Z-DII/PS-25A	112144	25/1500
DIII E33	35	Z-DIII/PS-35A	112145	25/850
DIII E33	50	Z-DIII/PS-50A	112146	25/850
DIII E33	63	Z-DIII/PS-63A	112147	25/850

SG19207



Gauge Ring Z-DII./PE

For size	Rated current [A]	Type Designation	Article No.	Units per package
DII E27	2	Z-DII/PE-2A	110396	50
DII E27	4	Z-DII/PE-4A	110397	50
DII E27	6	Z-DII/PE-6A	110398	50
DII E27	10	Z-DII/PE-10A	110399	50
DII E27	16	Z-DII/PE-16A	110790	50
DII E27	20	Z-DII/PE-20A	110791	50
DIII E33	2	Z-DIII/PE-2A	110792	50
DIII E33	4	Z-DIII/PE-4A	110793	50
DIII E33	6	Z-DIII/PE-6A	110794	50
DIII E33	10	Z-DIII/PE-10A	110795	50
DIII E33	16	Z-DIII/PE-16A	110796	50
DIII E33	20	Z-DIII/PE-20A	110797	50
DIII E33	25	Z-DIII/PE-25A	110798	50
DIII E33	35	Z-DIII/PE-35A	110799	50
DIII E33	50	Z-DIII/PE-50A	110800	50

wa_sg05908



Technical information p. 226

Screw Caps Z-DII./SK

SG07608



For size	Rated voltage AC [V]	Type Designation	Article No.	Units per package
DII E27	500	Z-DII/SK	112148	50/600
DIII E33	500	Z-DIII/SK	112149	30/360
DIII E33	690	Z-DIII/SK-690	118904	3

Technical information p. 226

Fuse Bases for standard mounting

- Fuse bases for fuse links DII and with thread E27 to 25 A
- Fuse bases for fuse links DIII and with thread E33 to 63 A
- For mounting onto device rail,, types ..-MP for mounting onto panel
- Delivered without screw caps



Poles / mounting	Rated current [A]	Type Designation	Article No.	Units per package
Size DII E27				
1 / On DIN rail	25	DII-SO/25/1	112151	1
1 / On panel	25	DII-SO/25/1-MP	112150	1
3 / On DIN rail	25	DII-SO/25/3	112154	1



Size DIII E33				
1 / On DIN rail	63	DIII-SO/63/1	112153	1
1 / On panel	63	DIII-SO/63/1-MP	112152	1
3 / On DIN rail	63	DIII-SO/63/3	112155	1

Technical information p. 227

Fuse Bases for direct mounting onto busbars

- Fuse bases for fuse links DII and with thread E27 to 25 A
- Fuse bases for fuse links DIII and with thread E33 to 63 A
- For mounting onto 60 mm busbar systems e.g. SASY 60i
- Suitable for busbars 12 x 5/10, 20 x 5/10, 25 x 5/10, 30 x 5/10, with double T profile
- Including shock hazard protection cover, front and bottom plate and description label
- Delivered empty without screw caps
- 3-pole
- Width 45 mm (DII) and 54 mm (DIII)
- Version -R for gauge rings Z-DII./PE
- Version -R-PS for screw/in gauge rings Z-DII./PS

SG12506



Rated current [A] / Size	Rated voltage U _g AC [V]	Type Designation	Article No.	Units per package
25 / DII E27	500	DII-SO/25/3-R	107965	10
25 / DII E27	500	DII-SO/25/3-R-PS	110394	10
63 / DIII E33	690	DIII-SO/63/3-R	107966	10
63 / DIII E33	690	DIII-SO/63/3-R-PS	110395	10

SG12606



Cover

- Side cover for DII-SO...3-R and DIII-SO...3-R

SG04407



Description	Type Designation	Article No.	Units per package
Side cover	SBS-RS60	60541	10

Technical information p. 228

Cylindrical Fuse-links Z-C10, Z-C14, Z-C22

- Fuse-links suitable for fuse disconnectors C10-SLS, VLC14 a VLC22
- Rated voltage 690, 500, 400 V, 50 Hz (according to I_n)
- High breaking capacity 100 kA
- Low let-through energy
- Characteristic gG suitable for protection of electrical lines, cables
- Characteristic AM suitable for protection of circuits with motors

SG20607



SG20507



SG20407



SG20607



SG20507



Type size	Rated current [A]	Rated voltage AC [V]	Type Designation	Article No.	Units per package
Characteristic gG (gL)					
10x38	1	500	Z-C10/SE-1A/GG	112156	10/500
10x38	2	500	Z-C10/SE-2A/GG	112157	10/500
10x38	4	500	Z-C10/SE-4A/GG	112158	10/500
10x38	6	500	Z-C10/SE-6A/GG	112159	10/500
10x38	8	500	Z-C10/SE-8A/GG	112160	10/500
10x38	10	500	Z-C10/SE-10A/GG	112161	10/500
10x38	12	500	Z-C10/SE-12A/GG	112162	10/500
10x38	16	500	Z-C10/SE-16A/GG	112163	10/500
10x38	20	500	Z-C10/SE-20A/GG	112164	10/500
10x38	25	500	Z-C10/SE-25A/GG	112165	10/500
10x38	32	400	Z-C10/SE-32A/GG	112166	10/500
14x51	2	690	Z-C14/SE-2A/GG	112167	10/200
14x51	4	690	Z-C14/SE-4A/GG	112168	10/200
14x51	6	690	Z-C14/SE-6A/GG	112169	10/200
14x51	8	690	Z-C14/SE-8A/GG	112170	10/200
14x51	10	690	Z-C14/SE-10A/GG	112171	10/200
14x51	12	690	Z-C14/SE-12A/GG	112172	10/200
14x51	16	690	Z-C14/SE-16A/GG	112173	10/200
14x51	20	690	Z-C14/SE-20A/GG	112174	10/200
14x51	25	690	Z-C14/SE-25A/GG	112175	10/200
14x51	32	690	Z-C14/SE-32A/GG	112176	10/200
14x51	40	500	Z-C14/SE-40A/GG	112177	10/200
14x51	50	500	Z-C14/SE-50A/GG	112178	10/200
22x58	16	690	Z-C22/SE-16A/GG	112179	10/480
22x58	20	690	Z-C22/SE-20A/GG	112180	10/480
22x58	25	690	Z-C22/SE-25A/GG	112181	10/480
22x58	32	690	Z-C22/SE-32A/GG	112182	10/480
22x58	40	690	Z-C22/SE-40A/GG	112183	10/480
22x58	50	500	Z-C22/SE-50A/GG	112184	10/480
22x58	63	500	Z-C22/SE-63A/GG	112185	10/480
22x58	80	500	Z-C22/SE-80A/GG	112186	10/480
22x58	100	500	Z-C22/SE-100A/GG	112187	10/480
Characteristic aM					
10x38	1	500	Z-C10/SE-1A/AM	112188	10/500
10x38	2	500	Z-C10/SE-2A/AM	112189	10/500
10x38	4	500	Z-C10/SE-4A/AM	112190	10/500
10x38	6	500	Z-C10/SE-6A/AM	112191	10/500
10x38	8	500	Z-C10/SE-8A/AM	112192	10/500
10x38	10	500	Z-C10/SE-10A/AM	112193	10/500
10x38	12	500	Z-C10/SE-12A/AM	112194	10/500
10x38	16	500	Z-C10/SE-16A/AM	112195	10/500
10x38	20	400	Z-C10/SE-20A/AM	112196	10/500
10x38	25	400	Z-C10/SE-25A/AM	112197	10/500
10x38	32	400	Z-C10/SE-32A/AM	112198	10/500
14x51	2	690	Z-C14/SE-2A/AM	112199	10/200
14x51	4	690	Z-C14/SE-4A/AM	112200	10/200
14x51	6	690	Z-C14/SE-6A/AM	112201	10/200
14x51	8	690	Z-C14/SE-8A/AM	112202	10/200
14x51	10	690	Z-C14/SE-10A/AM	112203	10/200
14x51	12	690	Z-C14/SE-12A/AM	112204	10/200
14x51	16	690	Z-C14/SE-16A/AM	112205	10/200
14x51	20	690	Z-C14/SE-20A/AM	112206	10/200
14x51	25	690	Z-C14/SE-25A/AM	112207	10/200
14x51	32	500	Z-C14/SE-32A/AM	112208	10/200
14x51	40	500	Z-C14/SE-40A/AM	112209	10/200
14x51	50	500	Z-C14/SE-50A/AM	112210	10/200

SG20407



Type size	Rated current [A]	Rated voltage AC [V]	Type Designation	Article No.	Units per package
22x58	16	690	Z-C22/SE-16A/AM	112211	10/480
22x58	20	690	Z-C22/SE-20A/AM	112212	10/480
22x58	25	690	Z-C22/SE-25A/AM	112213	10/480
22x58	32	690	Z-C22/SE-32A/AM	112214	10/480
22x58	40	690	Z-C22/SE-40A/AM	112215	10/480
22x58	50	690	Z-C22/SE-50A/AM	112216	10/480
22x58	63	500	Z-C22/SE-63A/AM	112217	10/480
22x58	80	500	Z-C22/SE-80A/AM	112218	10/480
22x58	100	500	Z-C22/SE-100A/AM	112219	10/480

Technical information p. 229

Fuse Disconnectors C10-SLS, VLC

- For cylindrical fuse-links Z-C10, 14, 22
- Mainly for industrial distributions
- Meets requirements EN 60947-3
- Rated voltage 690 V, 50 Hz
- Utilization category AC-22B (C10-SLS, VLC14), AC-21B (VLC22)
- Design ...L with lighting indication of tripping of fuse-links
- Sealable

Fuse Disconnectors 10x38 C10-SLS up to 32 A

- For cylindrical fuse-links Z-C10

SG06508



Num. of poles	For fuse-link	Type Designation	Article No.	Units per package
without Visual Tripping Indicator				
1	10x38	C10-SLS/32/1	112220	12/108
1+N	10x38	C10-SLS/32/1N	112221	12/108
2	10x38	C10-SLS/32/2	112222	6/54
3	10x38	C10-SLS/32/3	112223	4/36
3+N	10x38	C10-SLS/32/3N	112224	4/36
with Visual Tripping Indicator				
1	10x38	C10-SLS/32/1-L	112225	12/108
1+N	10x38	C10-SLS/32/1N-L	112226	12/108
2	10x38	C10-SLS/32/2-L	112227	6/54
3	10x38	C10-SLS/32/3-L	112228	4/36
3+N	10x38	C10-SLS/32/3N-L	112229	4/36

Fuse Disconnectors 14x51 VLC14 up to 50 A

- For cylindrical fuse-links Z-C14

SG00205



Num. of poles	For fuse-link	Type Designation	Article No.	Units per package
without Visual Tripping Indicator				
1	14x51	VLC14-1P	285361	12/96
1+N	14x51	VLC14-1P+N	285362	6/48
2	14x51	VLC14-2P	285363	6/48
3	14x51	VLC14-3P	285364	4/32
3+N	14x51	VLC14-3P+N	285365	3/24
with Visual Tripping Indicator				
1	14x51	VLC14-1P/L	285371	12/96
1+N	14x51	VLC14-1P+N/L	285372	6/48
2	14x51	VLC14-2P/L	285373	6/48
3	14x51	VLC14-3P/L	285374	4/32
3+N	14x51	VLC14-3P+N/L	285375	3/24

Fuse Disconnectors 22x58 VLC22 up to 100 A

- For cylindrical fuse-links Z-C22

SG00105



Num. of poles	For fuse-link	Type Designation	Article No.	Units per package
without Visual Tripping Indicator				
1	22x58	VLC22-1P	285366	3/105
1+N	22x58	VLC22-1P+N	285367	2/48
2	22x58	VLC22-2P	285368	2/48
3	22x58	VLC22-3P	285369	1/35
3+N	22x58	VLC22-3P+N	285370	1/24
with Visual Tripping Indicator				
1	22x58	VLC22-1P/L	285376	3/105
1+N	22x58	VLC22-1P+N/L	285377	2/48
2	22x58	VLC22-2P/L	285378	2/48
3	22x58	VLC22-3P/L	285379	1/35
3+N	22x58	VLC22-3P+N/L	285380	1/24

Technical information p. 234

Fuse-Links Z-C10../PV Photovoltaic application

- Fuse links for fuse disconnectors FCFDC10DI...-SOL
- For photovoltaic and similar DC applications
- Rated voltage 1000, 900 V DC (acc. to rated current)
- Maximum DC Operating voltage of the fuse-link must be 1,2 multiple of U_{oc} of string
- Rated current I_n of the fuse-link must be higher or equal than 1,5 multiple of short circuit current I_{sc} of a PV panel

SG11008



Type size	Rated current [A]	Rated voltage AC [V]	Type Designation	Article No.	Units per package
10x38	2	1000	Z-C10/SE-2A/PV	131700	10/500
10x38	4	1000	Z-C10/SE-4A/PV	131701	10/500
10x38	6	1000	Z-C10/SE-6A/PV	122009	10/500
10x38	8	1000	Z-C10/SE-8A/PV	122070	10/500
10x38	10	1000	Z-C10/SE-10A/PV	122071	10/500
10x38	12	1000	Z-C10/SE-12A/PV	131702	10/500
10x38	16	1000	Z-C10/SE-16A/PV	122072	10/500
10x38	20	1000	Z-C10/SE-20A/PV	122073	10/500
10x38	25	900	Z-C10/SE-25A/PV	131703	10/500

Technical information p. 235

Fuse disconnectors FCFDC10DI...-SOL for photovoltaic applications

- Fuse disconnectors for PV strings
- For use with fuse links Z-C10/SE..PV
- Rated operational voltage 1000 V DC
- Rated current 25 A DC
- Utilization category DC-20B
- Version with visual tripping indicator:
 - 50-400 V flashing
 - 400-1000 V permanent light
- Sealable

wa_sg06209



Poles	For fuse links	Type Designation	Article No.	Units per package
without Visual Tripping Indicator				
1	10x38	FCFDC10DI-1-SOL	137256	12/108
2	10x38	FCFDC10DI-2-SOL	137257	6/54
with Visual Tripping Indicator				
1	10x38	FCFDC10DI-1L-SOL	137258	12/108
2	10x38	FCFDC10DI-2L-SOL	137259	6/54

Technical information p. 236

Fuse-Links D0, Z-D0../SE

SG02905



- Fuse links for systems D01 and D02
- Rated voltage 400 V AC, 220 V DC
- Rated short-circuit breaking capacity 50 kA AC, 8 kA DC

- Characteristic gG
- Supplied in a box for mounting onto device rail, colour acc. to rated current

Size	Rated current [A]	Type Designation	Article No.	Units per package
D01	2	Z-D01/SE-2	288934	12/288
D01	4	Z-D01/SE-4	288935	12/288
D01	6	Z-D01/SE-6	288936	12/288
D01	10	Z-D01/SE-10	288937	12/288
D01	13	Z-D01/SE-13	288938	12/288
D01	16	Z-D01/SE-16	288939	12/288
D02	20	Z-D02/SE-20	288940	12/144
D02	25	Z-D02/SE-25	288941	12/144
D02	32	Z-D02/SE-32	288942	12/144
D02	35	Z-D02/SE-35	288943	12/144
D02	40	Z-D02/SE-40	288944	12/144
D02	50	Z-D02/SE-50	288945	12/144
D02	63	Z-D02/SE-63	288946	12/144

SG02905



Cartridge-Ring Adapter Insert Z-D0../PE

SG03105



- Cartridge ring adapter inserts for rated current coding
- For fuse links Z-D01/SE and Z-D02/SE

- Supplied in a box for mounting onto device rail, colour acc. to rated current

Size	For rated current [A]	Type Designation	Article No.	Units per package
D01	2	Z-D01/PE-2	288909	12/288
D01	4	Z-D01/PE-4	288910	12/288
D01	6	Z-D01/PE-6	288911	12/288
D01	10, 13	Z-D01/PE-10	288912	12/288
D02	20	Z-D02/PE-20	288913	12/288
D02	25	Z-D02/PE-25	288914	12/288
D02	35, 32	Z-D02/PE-35	288915	12/288
D02	40	Z-D02/PE-40	288916	12/288
D02	50	Z-D02/PE-50	288917	12/288

Cartridge-Ring Adapter Insert Z-D02-D01/PE

SG03005



- D01 for Fuse-Base D02 and Fuse-Switch-Disconnecter D02

- In practical plastic box in the color of the visual tripping indicator - to snap on DIN-rail

Size	For rated current [A]	Type Designation	Article No.	Units per package
D02-D01	2	Z-D02-D01/PE-2	263112	12/288
D02-D01	4	Z-D02-D01/PE-4	263113	12/288
D02-D01	6	Z-D02-D01/PE-6	263150	12/288
D02-D01	10, 13	Z-D02-D01/PE-10	263151	12/288
D02-D01	16	Z-D02-D01/PE-16	263152	12/288

Cartridge-Ring Adapter Insert Plier Z-D0-PE-Z

SG19707



- For easy mounting of cartridge ring adapter inserts

Size	Type Designation	Article No.	Units per package
Cartridge-Ring Adapter Insert Plier	Z-D0-PE-Z	114324	1/10

SG11205



Technical information p. 238

Screw Caps Z-D0./SK

- Screw caps for systems D01 and D02

Size	For rated current [A]	Type Designation	Article No.	Units per package
D01	max. 16	Z-D01/SK	100650	20
D02	max. 63	Z-D02/SK	100651	20

WA_SG02502



Adapter Spring

- Enable use of fuse links of size D01 in crew caps of size D02

Size	Type Designation	Article No.	Units per package
D02-D01	Z-D02/SIKA-HF	263149	50/3000

SG11605



SG11505



Technical information p. 239

Fuse-Base D01 and D02 for mounting onto device rail

- Fuse bases for systems D01 and D02
- Delivered empty, without screw caps

Size	Poles / Width	Rated current [A]	Type Designation	Article No.	Units per package
D01	1 / 27 mm	16	D01-SO/16/1	102752	9/216
D01	3 / 81 mm	16	D01-SO/16/3	102674	3/72
D02	1 / 27 mm	63	D02-SO/63/1	102675	9/216
D02	3 / 81 mm	63	D02-SO/63/3	102676	3/72

SG15007



Slide Fuse-Base D02 (+D01) for direct mounting onto busbars

- Fuse bases for fuse links Z-D02/SE (Z-D01/SE with reduction)
- For mounting onto 60 mm busbar systems e.g. SASY 60i
- Suitable for busbars 12 x 5/10, 20 x 5/10, 25 x 5/10, 30 x 5/10, with double T profile
- Including shock hazard protection cover, front and bottom plate and description label
- Delivered empty without screw caps
- 3-pole
- Rated current 63 A
- Rated voltage U_e 400 V AC

Size	Width [mm]	Type Designation	Article No.	Units per package
D02	27	D02-SO/63/3-R-27	114315	10
D02	36	Z-D02/R/3-36	100663	60
D02	54	Z-D02/R/3-54	100664	40

SG15205



Technical information p. 240

Cover

- For covering busbar support
- Suitable for D02-SO/63/3-R-27
- Set

Size	Width [mm]	Type Designation	Article No.	Units per package
D02	36	Z-D02-S-AB-SET	100662	10

SG18705



Switch-Disconnecter-Fuse D02-S for direct mounting onto busbars

- Switch disconnectors with fuses
- For fuse links Z-D02/SE and Z-D01/SE (with cartridge-ring adapter insert Z-D02-D01/PE... and adapter spring Z-D02/SIKA-HF)
- For mounting onto 60 mm busbar systems e.g. SASY 60i
- Suitable for busbars 20 x 5/10, 30 x 5/10, with double T profile
- Rated current 63 A
- Rated operational voltage 400 V AC
- Utilization category AC-23B
- Including shock hazard protection cover, front and bottom plate and description label
- Delivered empty without screw caps
- 3-pole
- Width 36 mm

Num. of poles	Rated current [A]	Type Designation	Article No.	Units per package
3	63	D02-S/63/3-RS	284649	10

Technical information p. 241

SG16007



SG15107



Switch-Disconnecter-Fuse D02-LTS for direct mounting onto busbars

- Switch disconnectors with fuses
- For fuse links Z-D02/SE and Z-D01/SE (with cartridge-ring adapter insert Z-D02-D01/PE... and adapter spring Z-D02/SIKA-HF) and cylindrical fuse links Z-C10/SE (with adapter Z-D02-LTS-HF)
- For mounting onto 60 mm busbar systems e.g. SASY 60i
- Suitable for busbars 12 x 5/10, 15 x 5/10, 20 x 5/10, 25 x 5/10, 30 x 5/10, with double T profile
- Rated current 63 A
- Rated operational voltage 400 V AC
- Utilization category AC-22B
- Visual tripping indicator (flashing)
- Contact position indicator red - green
- Delivered empty
- Including adapter Z-D02-LTS-HF
- 3-pole
- Width 27 mm
- Version -HK with auxiliary contact
- Can be sealed with leads, lockable

Num. of poles	Rated current [A]	Type Designation	Article No.	Units per package
3	63	D02-LTS/63/3-R	114316	3
3	63	D02-LTS/63/3-R-HK	114318	3
3+N	63	D02-LTS/63/3N-R	114317	3
3+N	63	D02-LTS/63/3N-R-HK	114319	3

Technical information p. 242

SG18907



Adapter Spring Z-D02-LTS-HF

- For use of fuse links D01 and cylindrical fuse links Z-C10 in fuse switch disconnectors D02-LTS

For fuse links	Type Designation	Article No.	Units per package
D01, Z-C10	Z-D02-LTS-HF	114323	12/288

WA_SG03202



Switch-Disconnecter-Fuse Z-SLS/D01

- Switch-Disconnecter-Fuse for fuse links Z-D01/SE
- Visual tripping indicator
- Delivered without fuse links
- Rated current 16 A
- Rated operational voltage 230/400 V AC, 60 V DC (1-pole), 110 V DC (2-pole)
- Utilization category AC-22B, DC-21B
- Mechanical current coding is integrated
- Can be sealed
- Supply side from top or bottom

Num. of poles	Rated current [A]	Type Designation	Article No.	Units per package
1	16	Z-SLS/D01/1	263155	18/180
1+N	16	Z-SLS/D01/1+N	263158	9/90
2	16	Z-SLS/D01/2	263156	9/90
3	16	Z-SLS/D01/3	263157	6/60
3+N	16	Z-SLS/D01/3+N	263159	4/40

Technical information p. 243

SG3302



Fuse-Switch-Disconnectors Z-SLS/NEOZ

- Fuse switch disconnector for fuse links size D01 and D02
- Empty
- Rated current 63 A
- Rated operational voltage 230/400 V AC, 110 V DC (1-pole), 220 V DC (2-pole)
- Utilization category AC-22B, DC-21B
- Mechanical current coding with Fuse-link set
- Can be sealed
- Supply side from top or bottom

Num. of poles	Rated current [A]	Type Designation	Article No.	Units per package
1	63	Z-SLS/NEOZ/1	248235	12/120
1+N	63	Z-SLS/NEOZ/1+N	248237	6/60
2	63	Z-SLS/NEOZ/2	248233	6/60
3	63	Z-SLS/NEOZ/3	248234	4/40
3+N	63	Z-SLS/NEOZ/3+N	248236	3/30

Technical information p. 244

Fuse-Switch-Disconnectors Z-SLS/CEK

- Fuse switch disconnector for fuse links size D01 and D02
- Integrated mechanical current coding
- Rated current up to 63 A acc. to mech. coding
- Rated operational voltage 60-230 V AC (1-pole); 60-400 V AC (1+N, 2, 3, 3+N pole)
- Utilization category AC-22B
- Mechanical current coding by means of fuse link set
- Can be sealed
- Supply side from top or bottom
- Version Z-SLS/CEK without visual tripping indicator
- Version Z-SLS/CEK...-SP with visual tripping indicator, with neutral lead through terminal, and with Integrated switch-locking

Num. of poles	Rated current [A]	Type Designation	Article No.	Units per package
---------------	-------------------	------------------	-------------	-------------------

without Visual Tripping Indicator

1	10	Z-SLS/CEK10/1	272587	12/120
1	16	Z-SLS/CEK16/1	263135	12/120
1	25	Z-SLS/CEK25/1	263136	12/120
3	16	Z-SLS/CEK16/3	248243	4/40
3	25	Z-SLS/CEK25/3	248244	4/40
3	35	Z-SLS/CEK35/3	248245	4/40
3	50	Z-SLS/CEK50/3	248246	4/40
3	63	Z-SLS/CEK63/3	263160	4/40

with Visual Tripping Indicator

1+N	10 A	Z-SLS/CEK10/1-SP	100652	6/60
1+N	16 A	Z-SLS/CEK16/1-SP	100653	6/60
1+N	25 A	Z-SLS/CEK25/1-SP	100654	6/60
3+N	16 A	Z-SLS/CEK16/3-SP	100655	3/30
3+N	25 A	Z-SLS/CEK25/3-SP	100656	3/30
3+N	35 A	Z-SLS/CEK35/3-SP	100657	3/30
3+N	50 A	Z-SLS/CEK50/3-SP	100658	3/30
3+N	63 A	Z-SLS/CEK63/3-SP	100659	3/30

SG00709



SG08705



Technical information p. 245

Fuse switch disconnectors Z-SLK with electronic fuse monitoring

- Fuse switch disconnectors for fuse links size D01 and D02
- With fuse monitoring (HS)
- Rated current 63 A
- Utilization category AC-22B, DC-21B
- Mechanical current coding with fuse-link set
- Can be sealed
- Supply side from top or bottom
- Version Z-SLK/NEOZ for rated operational voltage 60-230 V AC, 60-110 V DC (1-pole); 60-400 V AC, 60-220 V DC (2-pole); 60-400 V AC (1+N, 3, 3+N-pole)
- Version Z-SLK/D0 for rated operational voltage 24-60 V AC/DC (1, 2-pole); 24-60 V AC (3-pole)

Number of poles	Rated oper. voltage AC/DC [V]	Rated current [A]	Type Designation	Article No.	Units per package
-----------------	-------------------------------	-------------------	------------------	-------------	-------------------

1+HS	63	60-230/60-110	Z-SLK/NEOZ/1	248238	6/60
1+N+HS	63	60-400/-	Z-SLK/NEOZ/1+N	248242	4/40
2+HS	63	60-400/60-220	Z-SLK/NEOZ/2	248239	4/40
3+HS	63	60-400/-	Z-SLK/NEOZ/3	248240	3/30
3+N+HS	63	60-400/-	Z-SLK/NEOZ/3+N	248241	2/20
1+HS	63	24-60/24-60	Z-SLK/D0/1	114325	6/60
2+HS	63	24-60/24-60	Z-SLK/D0/2	114326	4/40
3+HS	63	24-60/-	Z-SLK/D0/3	114327	3/30

SG3402



Technical information p. 246

Fuse-link sets complete

- 1 set consists of 3 fuse-links, 3 gauge-pieces, 1 plastic box in the color of the visual tripping indicator - to snap on DIN-rail
- For Z-SLS/NEOZ, Z-SLS/CEK, Z-SLK/NEOZ, Z-SLK/D0

SG01105



Rated Current [A]	Type Designation	Article No.	Units per package
With visual tripping indicator, rated operational voltage 60-400 V AC / 60-220 V DC			
1	Z-SLS/B-1A	268983	1/12/120
2	Z-SLS/B-2A	268984	1/12/120
4	Z-SLS/B-4A	268985	1/12/120
6	Z-SLS/B-6A	268986	1/12/120
10	Z-SLS/B-10A	268987	1/12/120
13	Z-SLS/B-13A	289972	1/12/120
16	Z-SLS/B-16A	268988	1/12/120
20	Z-SLS/B-20A	268989	1/12/120
25	Z-SLS/B-25A	268990	1/12/120
32	Z-SLS/B-32A	289973	1/12/120
35	Z-SLS/B-35A	268991	1/12/120
40	Z-SLS/B-40A	289974	1/12/120
50	Z-SLS/B-50A	268992	1/12/120
63	Z-SLS/B-63A	268993	1/12/120
With visual tripping indicator, rated operational voltage 24-60 V AC / DC			
1	Z-SLS/B/24-1A	268994	1/12/120
2	Z-SLS/B/24-2A	268995	1/12/120
4	Z-SLS/B/24-4A	268996	1/12/120
6	Z-SLS/B/24-6A	268997	1/12/120
10	Z-SLS/B/24-10A	268998	1/12/120
13	Z-SLS/B/24-13A	289975	1/12/120
16	Z-SLS/B/24-16A	268999	1/12/120
20	Z-SLS/B/24-20A	269000	1/12/120
25	Z-SLS/B/24-25A	269001	1/12/120
32	Z-SLS/B/24-32A	289976	1/12/120
35	Z-SLS/B/24-35A	269002	1/12/120
40	Z-SLS/B/24-40A	289977	1/12/120
50	Z-SLS/B/24-50A	269003	1/12/120
63	Z-SLS/B/24-63A	269004	1/12/120
Without visual tripping indicator, rated operational voltage 400 V AC / 220 V DC			
2	Z-SLS/E-2A	263147	1/12/120
4	Z-SLS/E-4A	263148	1/12/120
6	Z-SLS/E-6A	269005	1/12/120
10	Z-SLS/E-10A	269006	1/12/120
13	Z-SLS/E-13A	289978	1/12/120
16	Z-SLS/E-16A	269007	1/12/120
20	Z-SLS/E-20A	269008	1/12/120
25	Z-SLS/E-25A	269009	1/12/120
32	Z-SLS/E-32A	289979	1/12/120
35	Z-SLS/E-35A	269010	1/12/120
40	Z-SLS/E-40A	289990	1/12/120
50	Z-SLS/E-50A	269011	1/12/120
63	Z-SLS/E-63A	269012	1/12/120

Solid-link Set complete

- 1 set consists of 3 solid-link inserts, 3 gauge-pieces, 1 plastic box to be snapped onto DIN rail
- For Z-SLS/NEOZ, Z-SLS/CEK, Z-SLK/NEOZ, Z-SLK/D0

SG01105



Rated Current [A]	Type Designation	Article No.	Units per package
63	Z-SLS/TR-SET	100660	1/12/120

SG9197

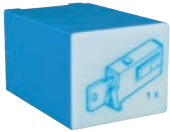

Switch-on-locking

- Only one lock per device required
- For Z-SLS/NEOZ, Z-SLS/CEK, Z-SLK/NEOZ, Z-SLK/D0

Description	Type Designation	Article No.	Units per package
Metal lock	Z-SLZ/SC	268980	1/12/120
Plastic lock	Z-SLZ/SP	268981	1/12/120

SG3102



Fuse-Switch-Disconnecter Z-SLS/CB

- For fuse links Z-D01/SE and Z-D02/SE
- Installation of fuse links D01 by means of cartridge ring adapter insert Z-D02-D01/PE and adapter Z-SLS/CB-HF
- Installation of fuse links D02 by means of cartridge ring adapter insert D02 Z-D02/PE
- With visual tripping indicator
- Rated current up to 63 A acc. to cartridge ring insert
- Rated operational voltage 400 V AC, 110 V DC (1-pole), 220 V DC (2-pole)
- Utilization category AC-22B
- Can be sealed

Num. of poles	Rated current [A]	Type Designation	Article No.	Units per package
1	63	Z-SLS/CB/1	248247	12/120
2	63	Z-SLS/CB/2	248248	6/60
3	63	Z-SLS/CB/3	248249	4/40

Technical information p. 248

WA_SG02602



Adapter Spring Z-SLS/CB-HF

- For Z-SLS/CB/ for the use of fuse-links size D01

Size	Type Designation	Article No.	Units per package
D01	Z-SLS/CB-HF	263154	12/288

46383A



Double Terminal Z-SLS/KL

- Adapter for doubling of terminals
- For Z-SLS/NEOZ, Z-SLS/CEK, Z-SLK/NEOZ, Z-SLK/D0, Z-SLS/CB
- Connection cross section 2 x 3 x 35 mm²
- 3-pole

Description	Type Designation	Article No.	Units per package
Double Terminal	Z-SLZ/KL	268982	15/150

SG00809



Switch-Disconnecter-Fuse with visual tripping indicator and thermal monitoring D02-LTS

- For Z-D01/SE and Z-D02/SE
- Thermal monitoring with integrated thermo switch
- Installation of fuse links D01 by means of cartridge-ring adapter insert Z-D02-D01/PE... and adapter spring Z-D02-LTS-HF
- Installation of fuse links D02 by means of cartridge-ring adapter insert Z-D02/PE
- Installation of cylindrical fuse links Z-C10/SE by means of adapter Z-D02-LTS -HF
- With visual tripping indicator
- Rated current up to 63 A acc. to cartridge ring insert
- Rated operational voltage 400 V AC
- Utilization category AC-22B
- Can be sealed
- Version D02-LTS/63-3-HK with integrated auxiliary contact
- Including adapter Z-D02-LTS -HF for fuse links D01 or cylindrical fuse links Z-C10/S
- Delivered without fuse links

Num. of poles	Rated current [A]	Type Designation	Article No.	Units per package
3	63	D02-LTS/63-3	114320	3/30
3	63	D02-LTS/63-3-HK	114322	3/30
3N	63	D02-LTS/63-3N	114321	3/30

Technical information p. 249

SG18907



Adapter Spring Z-D02-LTS-HF

- For use of fuse links D01 and cylindrical fuse links Z-C10 in disconnectors D02-LTS

Size	Type Designation	Article No.	Units per package
D01, Z-C10	Z-D02-LTS-HF	114323	12/288

Technical information p. 194

NH-Fuse-Links

- System of NH fuse links
- Type sizes 00, 1, 2, 3, 4a
- Rated voltage 500 V, 50 Hz

- Characteristic gG suitable for cables

370096



371325



372240



373063



374216



Size	Rated Current [A]	Type Designation	Article No.	Units per package
00	6	NH-00/6	850000760	3
00	10	NH-00/10	850000761	3
00	16	NH-00/16	850000762	3
00	20	NH-00/20	850000763	3
00	25	NH-00/25	850000660	3
00	32	NH-00/32	850000764	3
00	35	NH-00/35	850000661	3
00	40	NH-00/40	850000765	3
00	50	NH-00/50	850000662	3
00	63	NH-00/63	850000663	3
00	80	NH-00/80	850000664	3
00	100	NH-00/100	850000665	3
00	125	NH-00/125	850000666	3
00	145	NH-00/145	999201402	3
00	160	NH-00/160	850000667	3
1	32	NH-1/32	850000769	3
1	35	NH-1/35	850000770	3
1	40	NH-1/40	850000771	3
1	50	NH-1/50	850000670	3
1	63	NH-1/63	850000671	3
1	80	NH-1/80	850000672	3
1	100	NH-1/100	850000673	3
1	125	NH-1/125	850000674	3
1	160	NH-1/160	850000675	3
1	200	NH-1/200	850000677	3
1	224	NH-1/224	850000766	3
1	250	NH-1/250	850000678	3
2	35	NH-2/35	850000772	3
2	50	NH-2/50	850000774	3
2	63	NH-2/63	850000775	3
2	80	NH-2/80	850000778	3
2	100	NH-2/100	850000695	3
2	125	NH-2/125	850000696	3
2	160	NH-2/160	850000682	3
2	200	NH-2/200	850000683	3
2	224	NH-2/224	850000767	3
2	250	NH-2-250	850000684	3
2	300	NH-2-300	999201403	3
2	315	NH-2/315	850000685	3
2	355	NH-2/355	850000768	3
2	400	NH-2/400	850000686	3
3	100	NH-3/100	999201404	3
3	125	NH-3/125	999201405	3
3	160	NH-3/160	999201406	3
3	200	NH-3/200	850000776	3
3	224	NH-3/224	999201407	3
3	250	NH-3/250	850000777	3
3	300	NH-3/300	999201408	3
3	315	NH-3/315	850000691	3
3	355	NH-3/355	999201409	3
3	400	NH-3/400	850000692	3
3	425	NH-3/425	999201410	3
3	500	NH-3/500	850000693	3
3	630	NH-3/630	850000694	3
4a	800	NH-4a/800	999201698	3
4a	1000	NH-4a/1000	999201703	3
4a	1250	NH-4a/1250	999201052	3
4a	1600	NH-4a/1600	999201053	3

WA_SG02402



Solid-Links Z-NH-../TR

- Solid links for NH fuse disconnectors
- Convert fuse switch disconnector to switch disconnector

Size	Type Designation	Article No.	Units per package
00	Z-NH-00/TR	263114	3/180
1	Z-NH-1/TR	263115	6/60
2	Z-NH-2/TR	263116	6/60
3	Z-NH-3/TR	263117	3/30

wa_sg09203



Fuse Disconnectors LTS

- For power fuse-links of type sizes NH 00, 1, 2 and 3
- Delivered without NH fuse-links
- Version LTS intended for mounting onto panel or onto 100 mm busbar systems (with adapter Z-LTS...SAD/100-KR), connection with screws M8 (size 00), lift terminals (size 00 version .../3E), M10 (size 1, 2), M12 (size 3)
- Version LTS...R for direct mounting onto 60 mm busbar systems
 - Size 000 for busbars 20 x 5/10, 30 x 5/10, double T
 - Size 00 for busbars 12 x 5/10, 15 x 5/10, 20 x 5/10, 25 x 5/10, 30 x 5/10, double T
- Size 1 and 2 for busbars 20 x 5/10, 25 x 5/10, 30 x 5/10
- Version LTS...ES with electronic signalisation of fuse-link status, for mounting onto panel or 100 mm busbar systems (with adapter Z-LTS...SAD/100-KR), connection with screws M8 (size 00), M10 (size 1, 2), M12 (size 3)
- Meets requirements of EN 60947-3
- Whole cover can be demounted at off state
- Hinged windows for measuring of fuse-links voltage

Size	Rated current [A] max. fuse link 500 V/ max. fuse link 690 V	Num. of poles	Type Designation	Article No.	Units per package
------	--	---------------	------------------	-------------	-------------------

Mounting on panel

00	160 / 160 / 125	1	LTS-160/00/1	263120	1/14
00	160 / 160 / 125	3	LTS-160/00/3E	120602	1/6
1	250 / 250 / 200	3	LTS-250/1/3	269140	1/42
2	400 / 400 / 315	3	LTS-400/2/3	284647	1/25
3	630 / 630 / 500	3	LTS-630/3/3	284691	1/20

Mounting on 60 mm busbar system

000	100 / 100 / -	3	LTS-100/C00/3-R	284690	1
00	160 / 160 / 100	3	LTS-160/00/3E-R	120603	1/3
1	250 / 250 / 200	3	LTS-250/1/3-R	269348	1/32
2	400 / 400 / 315	3	LTS-400/2/3-R	284648	1/20

With electronic signalisation, mounting onto panel

00	160 / 160 / 125	3	LTS-160/00/3-ES	999201395	1
1	250 / 250 / 200	3	LTS-250/1/3-ES	999201396	1
2	400 / 400 / 315	3	LTS-400/2/3-ES	999201448	1
3	630 / 630 / 500	3	LTS-630/3/3-ES	999201449	1

Z-LTS-160/00/1

wa_sg09003



Z-LTS-160/00/3

Technical information p. 253, 260

SG07808



Busbar Adapter 3-pole, Z-LTS-...-SAD/100-KR

- Enable mounting of LTS disconnectors onto 100 mm busbar systems
- For busbars 15 x 5/10, 20 x 5/10, 25 x 5/10, 30 x 5/10, 40 x 5/10, 50 x 5/10, 60 x 5/10
- Connection top or bottom
- Drill-less mounting onto busbars
- 3-pole

For disconnector	Type Designation	Article No.	Units per package
LTS-250/1/3	Z-LTS-250-SAD/100-KR	120604	1
LTS-400/2/3	Z-LTS-400-SAD/100-KR	120605	1
LTS-630/3/3	Z-LTS-630-SAD/100-KR	120606	1

Technical information p. 264



Accessories for Fuse Disconnectors LTS

Description	Type Designation	Article No.	Units per package
Size 00			
Terminal covers, 1-pole	Z-LTS-00/1-KA	263125	2/120
Terminal cover, 3-pole	Z-LTS-00/3-KA	263126	4/80
Shock Hazard Protection Set, 3-pole	Z-LTS-00/3-R-AB	263124	2/30
Screws M8, 16-70 mm ² Cu, 16-95 mm ² Al	Z-LTS-SC	263119	3/180
Front Frame for 3p disconnector	Z-LTS-00/3-R-FR	263123	1/200
Busbar for 3 3p disconnectors, 35 mm ² Cu	Z-LTS-00/3-SV	264929	4
Extension Terminal 25-95 mm ² Cu	Z-LTS-EK/95	269522	3/90
Cu Clamp Straps 4-70 mm ²	Z-LTS-160-BK	286812	3/180
V-shaped terminal lug	Z-LTS-00-V-LA	263130	3/180
V-shaped terminal 70 mm ² Sm, 95 mm ² Se	Z-LTS-00-V-KL	263128	3/180
V-cover cap	Z-LTS-00-V-KLA	263132	3/180
Cover level to Cu-front distance: 70 mm (2 per device)	Z-LTS-160-AB/70	288901	1
Cover level to Cu-front distance: 90 mm (2 per device)	Z-LTS-160-AB/90	288904	2
Size 1			
Al/Cu Clamp Straps 70-150 mm ² Al/Cu, 18x10 mm Cu	Z-LTS-250-BK	286813	3/180
Cover level to Cu-front distance: 70 mm (2 per device)	Z-LTS-250-AB/70	288902	2
Cover level to Cu-front distance: 90 mm (2 per device)	Z-LTS-250-AB/90	288905	2
Size 2			
Cover level to Cu-front distance: 70 mm (2 per device)	Z-LTS-400-AB/70	288903	2
Cover level to Cu-front distance: 90 mm (2 per device)	Z-LTS-400-AB/90	288906	2
Size 3			
Cover level to Cu-front distance: 90 mm (2 per device)	Z-LTS-630-AB/90	288907	2
Size 1, 2, 3			
V-shaped terminal lug, max. 500A	Z-LTS-V-LA	263129	3/180
V-shaped terminal 185 mm ² Sm, 240 mm ² Se, max. 500A	Z-LTS-V-KL	263127	3/180
V-shaped terminal 240 mm ² Sm, 240 mm ² Se, max. 500A	Z-LTS-VV-KL	999201714	3/180
V-cover cap	Z-LTS-V-KLA	263131	3/180
Size 00, 1, 2, 3			
In connection with the compensation covers they serve as support for the front plate, as well as electric shock protection	Z-LTS-SAB/70-90	288908	2

Vertical Fuse Disconnectors LTS-L.

- For power fuse-links of type sizes NH 00, 1, 2 and 3
- Delivered without NH fuse-links
- Size 00, version 160/00 for mounting onto busbar systems with spacing 100 mm, or 185 mm, version 160/00-60-10-R for mounting onto busbar systems with spacing 60 mm (20x10, 25x10, 30x10)
- Sizes 1, 2, 3 and 4a for mounting onto busbar systems with spacing 185 mm
- Version –ES.. with electronic signalisation of fuse-link status

Description	Rated current [A] max. fuse link 500 V/ max. fuse link 690 V	Type Designation	Article No.	Units per package
-------------	--	------------------	-------------	-------------------

Size 00

3 screws M8 with cover

+ terminal clips,
for 100 mm busbars

160/160/160	LTS-L/160/00	269349	1/100
-------------	--------------	--------	-------

3 lift terminals,
for 100 mm busbars

160/160/160	LTS-L/160/00/3-L	120600	1/100
-------------	------------------	--------	-------

3 Al/Cu clamps
with cover,
for 100 mm busbars

160/160/160	LTS-LG 160/00-E1	872002052	1/100
-------------	------------------	-----------	-------

3 screws M8,
for 60 mm busbars

160/160/100	LTS-L/160/00-60-10-R	289997	1/100
-------------	----------------------	--------	-------

3 screws M8,
for 185 mm busbars

160/160/160	LTS-L/160/00-2N1	999201374	1/100
-------------	------------------	-----------	-------

3 screws M8,
for 100 mm busbars,
el. signalisation

160/160/160	LTS-L/160/00-ES11	999201462	1
-------------	-------------------	-----------	---

3 screws M8,
for 185 mm busbars,
el. signalisation

160/160/160	LTS-L/160/00-ES1	999201463	1
-------------	------------------	-----------	---

Size 1

M10 screw connection,
3-pole control
(parallel)

250/250/200	LTS-L/250/1	269350	1
-------------	-------------	--------	---

V-shaped busbar, 3-pole
control (parallel)

250/250/200	LTS-LG 250/1-V11	999201032	1
-------------	------------------	-----------	---

M10 screw connection,
3-pole control
(parallel),
el. signalisation

250/250/200	LTS-L/250/1-ES11	999201666	1
-------------	------------------	-----------	---

Size 2

M12 screw connection,
3-pole control
(parallel)

400/400/315	LTS-L/400/2	269351	1
-------------	-------------	--------	---

V-shaped busbar
(35 – 240 mm²),
fixed handle, 3x1-pole
control

400/400/315	LTS-LG 400/2-V1	872005100	1
-------------	-----------------	-----------	---

V-shaped busbar
(35 – 240 mm²),
3-pole control
(parallel)

400/400/315	LTS-LG 400/2-V11	872005800	1
-------------	------------------	-----------	---

M12 screw connection,
3-pole control
(parallel),
el. signalisation

400/400/315	LTS-L/400/2-ES11	999201667	1
-------------	------------------	-----------	---

Double parallel
disconnecter,
M12 screw connection

2 x 400/400/315	LTS-LG 800/2	999201041	1
-----------------	--------------	-----------	---

wa_sg02705



SG11108



Vertical Fuse Disconnectors LTS-L. - continued

Description	Rated current [A] max. fuse link 500 V/ max. fuse link 690 V	Type Designation	Article No.	Units per package
-------------	--	------------------	-------------	-------------------

Size 3

M12 screw connection, 3-pole control (parallel) V-shaped busbar (35 – 240 mm ²), 3-pole control (parallel)	630/630/500	LTS-L/630/3	269352	1
	500/500/500	LTS-LG 630/3-V11	999201033	1

M12 screw connection, 3-pole control (parallel), el. signalisation	630/630/500	LTS-L/630/3-ES11	999201668	1
---	-------------	------------------	-----------	---

Double parallel disconnecter, M12 screw connection	2 x 630/630/500	LTS-LG 1260/3	999201042	1
--	-----------------	---------------	-----------	---

Size 4a

Bottom connection with screws M16	1250/1250	LTS-LG 1250/4a-B	999201043	1
--------------------------------------	-----------	------------------	-----------	---

Top connection with screws M16	1250/1250	LTS-LG 1250/4a-T	999201044	1
-----------------------------------	-----------	------------------	-----------	---

Bottom connection with screws 2xM16	1600/1600	LTS-LG 1600/4a-B	999201045	1
--	-----------	------------------	-----------	---

Top connection with screws 2xM16	1600/1600	LTS-LG 1600/4a-T	999201046	1
-------------------------------------	-----------	------------------	-----------	---

1 000 095



Technical information p. 266, 271

Vertical Fuse Disconnectors for Busbars Splitting

Size 2 and 3, rated current 400 A and 630, busbar separation 185 mm

Design	Type Designation	Article No.	Units per package
--------	------------------	-------------	-------------------

Vertical disconnector to 400 A, hinged handle, size 2	LTS-LG 400/2-S2	872002057	1
--	-----------------	-----------	---

Vertical disconnector to 630 A, fixed handle, size 3	LTS-LG 630/3-S1	872006000	1
---	-----------------	-----------	---



Technical information p. 272

Accessories for Vertical Fuse Disconnectors LTS-L

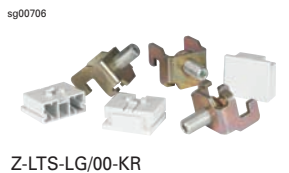

Description	Type Designation	Article No.	Units per package
Size 00			
Connection screws M8, 16-70 mm ² Cu, 16-95 mm ² Al, suitable also for mounting onto Z-LTS-L...-SAD..	Z-LTS-SC	263119	3/180
Cu Clamp Straps 4-70 mm ²	Z-LTS-160-BK	286812	3/180
Terminal clips, 3 pcs	Z-LTS-LG/00-KR	263153	3/180
Signal switch 5 A, 250 V (1 NO / 1 NC)	ZLTS-M/DOHD	872002054	1
Adapter 100/185 mm	Z-LTS-LG/00-SAD	263118	1
Double adapter for conversion from busbars 100 to 185 mm	Z-LTS-L/160-SADD	286815	1
Adapter for conversion from busbars 100 to 185 mm, drill-less mounting	Z-LTS-L/160-SAD-KR	286814	1
Double adapter for conversion from busbars 100 to 185 mm, drill-less mounting	Z-LTS-L/160-SADD-KR	286816	1
Current transformer:			
- 3-phase measuring to 100 A	ZLTS-MO/SW100	872002055	1 set *)
- 3-phase measuring to 150 A	ZLTS-MO/SW150	872002056	1 set *)
Al/Cu clamps 4-70 mm ²	Z-LTS-160-BK	286812	3/180
V-shaped busbar	Z-LTS-00-V-LA	263130	3/180
V-shaped clamp 70 mm ² Sm, 95 mm ² Se	Z-LTS-00-V-KL	263128	3/180
Cover for V-shaped clamp	Z-LTS-00-V-KLA	263132	3/180
Cover level to Cu-front distance: 70 mm (2 per device)	Z-LTS-L/160-AB/70-SET	289995	1
Cover level to Cu-front distance: 90 mm (2 per device)	Z-LTS-L/160-AB/90-SET	289996	1
Terminal cover/size compensation for disconnectors size 1, 2, 3	Z-LTS-L-KA	286817	2/40
Size 1			
Al/Cu clamps 70-150 mm ² Al/Cu, 18x10 mm Cu	Z-LTS-250-BK	286813	3/180
Cover level to Cu-front distance: 70 mm (2 per device)	Z-LTS-250-AB/70	288902	2
Cover level to Cu-front distance: 90 mm (2 per device)	Z-LTS-250-AB/90	288905	2
Current transformer for 3-phase measuring to 250 A for size 1	ZLTS-M3/W250	872006700	1 set *)
Size 2			
Cover level to Cu-front distance: 70 mm (2 per device)	Z-LTS-400-AB/70	288903	2
Cover level to Cu-front distance: 90 mm (2 per device)	Z-LTS-400-AB/90	288906	2
Current transformer for 3-phase measuring to 400 A for size 2	ZLTS-M3/W400	872006900	1 set *)
Size 3			
Cover level to Cu-front distance: 90 mm (2 per device)	Z-LTS-630-AB/90	288907	2
Current transformer for 3-phase measuring to 600 A for size 3	ZLTS-M3/W600	872007100	1 set *)
Size 1, 2, 3			
Terminal clips	Z-LTS-L-KR	269353	3/90
Extension for mounting of 2 cable lugs 240 mm ² phase L3	Z-NH-AE	120601	1
V-shaped busbar, max. 500 A	Z-LTS-V-LA	263129	3/180
V-shaped clamp 185 mm ² Sm, 240 mm ² Se, max. 500A	Z-LTS-V-KL	263127	3/180
V-shaped clamp 240 mm ² Sm, 240 mm ² Se, max. 500A	Z-LTS-VV-KL	999201714	3/180
Cover for V-shaped clamp	Z-LTS-V-KLA	263131	3/180
Terminal cover bottom, length 190 mm	ZLTS-M/KHO	872006400	1
Terminal cover top, length 145 mm	ZLTS-M/KHU	872006500	1
Size 00, 1, 2, 3			
In connection with the compensation covers they serve as support for the front plate, as well as electric shock protection	Z-LTS-SAB/70-90	288908	2
*) 1 set = 3 pcs			

Circuit Breakers LZM and Switch Disconnectors LN

- Economic line of moulded case circuit breakers and disconnectors for rated currents 63 to 1600 A
 - Rated breaking capacity I_{cu} kA 36 kA (LZM1, LZM2) and 50 kA (LZM3 and LZM4) (415 V 50/60 Hz)
 - Rated operating voltage U_e 415 V AC
 - Circuit breakers for protection of cables and circuits
 - 3-pole versions
 - Fixed design
 - Compatible with basic accessories of circuit breakers NZM
 - Sets for easy mounting into distribution boards
- Moeller / Eaton



Circuit Breakers LZM1

• Rated breaking capacity I_{cu} 36 kA (415 V 50/60 Hz) • Thermo-magnetic releases



Rated current $I_n = I_u$ [A]	Overcurrent release I_r [A]	Short circuit current release I_i [A]	Type Designation	Article No.	Units per package
20	15-20	350	LZMC1-A20-I	111888	1
25	20-25	350	LZMC1-A25-I	111889	1
32	25-32	350	LZMC1-A32-I	111890	1
40	32-40	320-400	LZMC1-A40-I	111891	1
50	40-50	300-500	LZMC1-A50-I	111892	1
63	50-63	380-630	LZMC1-A63-I	111893	1
80	63-80	480-800	LZMC1-A80-I	111894	1
100	80-100	600-1000	LZMC1-A100-I	111895	1
125	100-125	750-1250	LZMC1-A125-I	111896	1
160	125-160	1280	LZMC1-A160-I	111897	1

Switch Disconnectors LN1



Rated current $I_n = I_u$ [A]	Type Designation	Article No.	Units per package
63	LN1-63-I	111994	1
100	LN1-100-I	111995	1
125	LN1-125-I	111996	1
160	LN1-160-I	111997	1

Accessories of Circuit Breakers LZM1 and Switch Disconnectors LN1

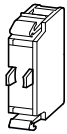

M22-K10

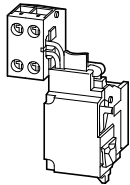

NZM1-XHIV



NZM1-XDV



NZM1-XTVDVR

Description	Type Designation	Article No.	Units per package
Auxiliary contacts 10	M22-K10	216376	1
Auxiliary contacts 01	M22-K01	216378	1
Early-make auxiliary contacts (with clamp terminal)	NZM1-XHIV	259426	1
Undervoltage release 24 V AC	NZM1-XU24AC	259434	1
Undervoltage release 240 V AC	NZM1-XU208-240AC	259442	1
Undervoltage release 440 V AC	NZM1-XU380-440AC	259444	1
Undervoltage release with two early-make auxiliary contacts 24 V AC	NZM1-XUHIV24AC	259531	1
Shunt trip release with auxiliary contact 240 V AC / DC	NZM1-XUHIV208-240AC	259539	1
Shunt trip release with auxiliary contact 440 V AC / DC	NZM1-XUHIV380-440AC	259541	1
Shunt trip release 24 V AC / DC	NZM1-XA24AC/DC	259708	1
Shunt trip release 250 V AC / DC	NZM1-XA208-250AC/DC	259726	1
Shunt trip release 440 V AC / DC	NZM1-XA380-440AC/DC	259728	1
Shunt trip release with auxiliary contact 24 V AC / DC	NZM1-XAHIV24AC/DC	259774	1
Shunt trip release with auxiliary contact 250 V AC / DC	NZM1-XAHIV208-250AC/DC	259782	1
Shunt trip release with auxiliary contact 440 V AC / DC	NZM1-XAHIV380-440AC/DC	259784	1
Lockable rotary drive with rotary handle, black colour	NZM1-XDV	260125	1
Lockable rotary drive with rotary handle, red/yellow colour	NZM1-XDVR	260135	1
Lockable door coupling rotary handle, black colour	NZM1-XTVD	260166	1
Lockable rotary drive with rotary handle, red/yellow colour	NZM1-XTVDVR	260178	1
Extension shaft for mounting depth 400 mm	NZM1/2-XV4	261232	1
Extension shaft for mounting depth 600 mm	NZM1/2-XV6	260191	1
Insulating surround	NZM1-XBR	260195	1
Toggle lever locking device	NZM1-XKAV	260199	1
Spacer (height 17.5 mm)	NZM1/2-XAB	260203	1
Clip plate for mounting onto DIN rail	NZM1-XC35	260213	1
Exchangeable tunnel (lift) terminal	NZM1-XKC	260015	1
Terminal clip for screw connection	NZM1-XKS	260019	1
Terminal cover	NZM1-XKSA	260021	1

Technical information p. 273

Circuit Breakers LZM2

• Rated breaking capacity I_{cu} 36 kA (415 V 50/60 Hz) • Thermo-magnetic releases



Rated current $I_n = I_u$ [A]	Overcurrent release I_r [A]	Short circuit current release I_i [A]	Type Designation	Article No.	Units per package
160	125-160	960-1600	LZMC2-A160-I	111938	1
200	160-200	1200-2000	LZMC2-A200-I	111939	1
250	200-250	1500-2500	LZMC2-A250-I	111940	1
300	240-300	1500-2500	LZMC2-A300-I	111941	1

Switch Disconnectors LN2



Rated current $I_n = I_u$ [A]	Max. back-up protection (short circuit) fuse gG/gL [A]	Type Designation	Article No.	Units per package
160	250	LN2-160-I	112002	1
200	250	LN2-200-I	112003	1
250	250	LN2-250-I	112004	1

Accessories of Circuit Breakers LZM2 and Switch Disconnectors LN2

Description	Type Designation	Article No.	Units per package
Auxiliary contacts 10	M22-K10	216376	1
Auxiliary contacts 01	M22-K01	216378	1
Early-make auxiliary contacts	NZM2/3-XHIV	259430	1
Undervoltage release 24 V AC	NZM2/3-XU24AC	259491	1
Undervoltage release 240 V AC	NZM2/3-XU208-240AC	259499	1
Undervoltage release 440 V AC	NZM2/3-XU380-440AC	259501	1
Undervoltage release with two early-make auxiliary contacts 24 V AC	NZM2/3-XUHIV24AC	259583	1
Undervoltage release with two early-make auxiliary contacts 240 V AC	NZM2/3-XUHIV208-240AC	259591	1
Undervoltage release with two early-make auxiliary contacts 440 V AC	NZM2/3-XUHIV380-440AC	259594	1
Shunt trip release 24 V AC / DC	NZM2/3-XA24AC/DC	259754	1
Shunt trip release 240 V AC / DC	NZM2/3-XA208-250AC/DC	259763	1
Shunt trip release 440 V AC / DC	NZM2/3-XA380-440AC/DC	259766	1
Shunt trip release with auxiliary contact 24 V AC / DC	NZM2/3-XAHIV24AC/DC	259810	1
Shunt trip release with auxiliary contact 250 V AC / DC	NZM2/3-XAHIV208-250AC/DC	259818	1
Shunt trip release with auxiliary contact 440 V AC / DC	NZM2/3-XAHIV380-440AC/DC	259820	1
Lockable rotary drive with rotary handle, black colour	NZM2-XDV	260127	1
Lockable rotary drive with rotary handle, red colour	NZM2-XDVR	260137	1
Lockable door coupling rotary handle, black colour	NZM2-XTVD	260168	1
Lockable door coupling rotary handle, red/yellow colour	NZM2-XTVDVR	260180	1
Extension shaft for mounting depth 400 mm	NZM1/2-XV4	261232	1
Extension shaft for mounting depth 600 mm	NZM1/2-XV6	260191	1
Insulating surround	NZM2-XBR	260197	1
Toggle lever locking device	NZM2/3-XKAV	260201	1
Spacer (height 17.5 mm)	NZM1/2-XAB	260203	1
Clip plate for mounting onto DIN rail	NZM2-XC75	260215	1
Motor drive 240 V AC	NZM2-XR208-240AC	259832	1
Motor drive 24 V DC	NZM2-XR24-30DC	259836	1
Exchangeable tunnel (lift) terminal	NZM2-160-XKC	262240	1
Terminal clip for screw connection	NZM2-XKS	260030	1
Terminal cover	NZM2-XKSA	260038	1

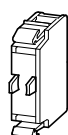

M22-K10

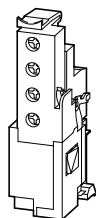

NZM2/3-XHIV

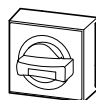

NZM2-XDV



NZM2-XTVDVR



Circuit Breakers LZM3

- Rated breaking capacity I_{cu} 50 kA (415 V 50/60 Hz)
- Thermo-magnetic releases, for $I_n = 630$ A electronic releases

Rated current $I_n = I_u$ [A]	Overcurrent release I_r [A]	Short circuit current release I_i [A]	Type Designation	Article No.	Units per package
320	250-320	1920-3200	LZMN3-A320-I	111966	1
400	320-400	2400-4000	LZMN3-A400-I	111967	1
500	400-500	3000-5000	LZMN3-A500-I	111968	1
630	315-630	1260-5040	LZMN3-AE630-I	111969	1



Switch Disconnectors LN3

Rated current $I_n = I_u$ [A]	Max. back-up protection (short circuit) fuse gG/gL [A]	Type Designation	Article No.	Units per package
400	630	LN3-400-I	112008	1
630	630	LN3-630-I	112009	1

Accessories of Circuit Breakers LZM3 and Switch Disconnectors LN3

Description	Type Designation	Article No.	Units per package
Auxiliary contacts 10	M22-K10	216376	1
Auxiliary contacts 01	M22-K01	216378	1
Early-make auxiliary contacts	NZM2/3-XHIV	259430	1
Undervoltage release 24 V AC	NZM2/3-XU24AC	259491	1
Undervoltage release 240 V AC	NZM2/3-XU208-240AC	259499	1
Undervoltage release 440 V AC	NZM2/3-XU380-440AC	259501	1
Undervoltage release with two early-make auxiliary contacts 24 V AC	NZM2/3-XUHIV24AC	259583	1
Undervoltage release with two early-make auxiliary contacts 240 V AC	NZM2/3-XUHIV208-240AC	259591	1
Undervoltage release with two early-make auxiliary contacts 440 V AC	NZM2/3-XUHIV380-440AC	259594	1
Shunt trip release 24 V AC / DC	NZM2/3-XA24AC/DC	259754	1
Shunt trip release 240 V AC / DC	NZM2/3-XA208-250AC/DC	259763	1
Shunt trip release 440 V AC / DC	NZM2/3-XA380-440AC/DC	259766	1
Shunt trip release with auxiliary contact 24 V AC / DC	NZM2/3-XAHIV24AC/DC	259810	1
Shunt trip release with auxiliary contact 250 V AC / DC	NZM2/3-XAHIV208-250AC/DC	259818	1
Shunt trip release with auxiliary contact 440 V AC / DC	NZM2/3-XAHIV380-440AC/DC	259820	1
Lockable rotary drive with rotary handle, black colour	NZM3-XDV	260129	1
Lockable rotary drive with rotary handle, red colour	NZM3-XDVR	260140	1
Lockable door coupling rotary handle, black colour	NZM3-XTVD	260170	1
Lockable door coupling rotary handle, red/yellow colour	NZM3-XTVDVR	260182	1
Extension shaft for mounting depth 400 mm	NZM3/4-XV4	261234	1
Extension shaft for mounting depth 600 mm	NZM3/4-XV6	260193	1
Toggle lever locking device	NZM2/3-XKAV	260201	1
Motor drive 240 V AC	NZM3-XR208-240AC	259850	1
Motor drive 24 V DC	NZM3-XR24-30DC	259854	1
Exchangeable tunnel (lift) terminal	NZM3-XKC	260042	1
Terminal clip for screw connection	NZM3-XKS	260039	1
Terminal cover	NZM3-XKSA	260045	1

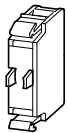

M22-K10

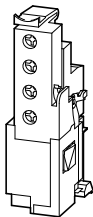

NZM2/3-XHIV



NZM3-XDV



NZM3-XTVDVR

Circuit Breakers LZM4

• Rated breaking capacity I_{cu} 50kA (415 V 50/60 Hz) • Electronic releases



Rated current $I_n = I_u$ [A]	Overcurrent release I_r [A]	Short circuit current release I_i [A]	Type Designation	Article No.	Units per package
800	400-800	1600-9600	LZMN4-AE800-I	111978	1
1000	500-1000	2000-12000	LZMN4-AE1000-I	111979	1
1250	630-1250	2500-15000	LZMN4-AE1250-I	111980	1
1600	800-1600	3200-19200	LZMN4-AE1600-I	111981	1

Switch Disconnectors LN4



Rated current $I_n = I_u$ [A]	Max. back-up protection (short circuit) fuse gG/gL [A]	Type Designation	Article No.	Units per package
800	1600	LN4-800-I	112012	1
1000	1600	LN4-1000-I	112013	1
1250	1600	LN4-1250-I	112014	1
1600	1600	LN4-1600-I	112015	1

Accessories of Circuit Breakers LZM4 and Switch Disconnectors LN4

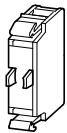

M22-K10

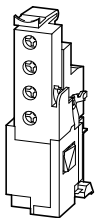

NZM4-XHIV

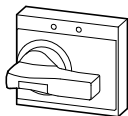

NZM4-XDV



NZM4-XTVDVR

Description	Type Designation	Article No.	Units per package
Auxiliary contacts 10	M22-K10	216376	1
Auxiliary contacts 01	M22-K01	216378	1
Early-make auxiliary contacts	NZM4-XHIV	266172	1
Undervoltage release 24 V AC	NZM4-XU24AC	266189	1
Undervoltage release 240 V AC	NZM4-XU208-240AC	266193	1
Undervoltage release 440 V AC	NZM4-XU380-440AC	266194	1
Undervoltage release with two early-make auxiliary contacts 240 V AC	NZM4-XUHIV208-240AC	266221	1
Undervoltage release with two early-make auxiliary contacts 240 V AC	NZM4-XUHIV20208-240AC	266248	1
Shunt trip release 24 V AC / DC	NZM4-XA24AC/DC	266447	1
Shunt trip release 250 V AC / DC	NZM4-XA208-250AC/DC	266451	1
Shunt trip release 440 V AC / DC	NZM4-XA380-440AC/DC	266452	1
Lockable rotary drive with rotary handle, red colour	NZM4-XDVR	266610	1
Lockable rotary drive with rotary handle, red colour	NZM4-XTVDVR	266618	1
Extension shaft for mounting depth 400 mm	NZM3/4-XV4	261234	1
Extension shaft for mounting depth 600 mm	NZM3/4-XV6	260193	1
Motor drive 240 V AC	NZM4-XR208-240AC	266685	1
Motor drive 24 V DC	NZM4-XR24-30DC	266691	1
Module plate	NZM4-XKM2	266820	1
Flat cable terminal	NZM4-XKB	266829	1
Tunnel (lift) terminal	NZM4-XKA	266836	1
Terminal for back connection	NZM4-XKR	266842	1
Terminal cover	NZM4-XKSA	266846	1

Surge Protection

- Protection of low-voltage installations against direct or near strokes of lighting or against surges from switching of consumers
- Surge protection devices class T1 (I, B) as capsulated version
- Surge arresters class T2 (II, C) and T3 (III, D) protection of sensitive electronic devices
- Easy function check of arresters class T2 (II, C) and T3 (III, D) – fault indication
- Reliable protection against overvoltage in case of use of a complete cascade of three classes (T1, T2, T3)
- Surge protection devices for photovoltaic applications

U1202



Surge Arresters class T1 (I, B)

- For the protection of low voltage distribution systems against direct lightning stroke into the overhead power supply line or devices
- Capsulated version - during the discharge process, the device does not issue any hot ionised gases. Therefore, there is no need for keeping a safety distance to flammable materials.

Lighting Current Arresters SPI

- For coordination of arresters class T1 (I, B) (SPI series) and arresters class T2 (II, C) it is necessary to keep recommended length of electric line min. 10 m between arresters or to use arrester class T2 (II, C) with a maximum continuous operating voltage U_c of 460 V AC with higher protection level
- Voltage protection level 1.5 kV
- Surge arrester SPI-35/440 is phase arrester for connection between L and N (PE)
- Surge arresters SPI-.../NPE are sum spark gaps for connection between N and PE e.g. in connection 3+1 for TN-S system

SG13005



SPI-35/440

SG14605



SPI-3+1

Imp. current I_{imp} (10/350) μ s	Type Designation	Article No.	Units per package
35 kA capsulated	SPI-35/440	263137	6/120
50 kA capsulated	SPI-50/NPE	263138	2/120
100 kA capsulated	SPI-100/NPE	263139	1/60
Surge arrester set for TN-C	SPI-35/440/3	267487	1/40
Surge arrester set for TN-S, TT	SPI-3+1	267488	1/20

Technical information p. 276

U0302



Lead-through Terminal for T1 (I, B) class arresters, SPB-D-125

Rated Current	Type Designation	Article No.	Units per package
125 A	SPB-D-125	248145	2

Technical information p. 277

Busbars Z-GV-U for SPB, SPI, SP-B+C

Num. of poles	Type Designation	Article No.	Units per package
2	Z-GV-U/2	272588	20/1200
3	Z-GV-U/3	272589	20/1200
4	Z-GV-U/4	274080	20/1200
5	Z-GV-U/5	274081	20/1200
6	Z-GV-U/6	274082	20/400
8	Z-GV-U/8	274083	20/200
9	Z-GV-U/9	274084	20/200



Z-GV-U/9

Technical information p. 277

SG01804



SPB-12/280/3

SPD class T1+T2 (I+II, B+C), SPB-12/280

- Big saving of space inside a distribution board
 - two classes of SPD integrated in a single module
- Recommended for buildings supplied with underground cable

Version	Type Designation	Article No.	Units per package
SPD class T1+T2 (I+II, B+C)	SPB-12/280	284698	12/120
Lightning current arrester 100 kA	SPB-100/NPE	105194	1/60
2-pole set 1+1 for TN-S/TT net	SPB-1+1	105196	1/40
2-pole set for TN-S net	SPB-12/280/2	285081	1/60
3-pole set for TN-C net	SPB-12/280/3	284699	1/40
4-pole set for TN-S net	SPB-12/280/4	285082	1/30
4-pole set 3+1 for TN-S/TT net	SPB-3+1	105195	1/24
2-pole set 1+1 for TN-S/TT net with aux. switch	SPB-1+1-HK	112373	1/30
3-pole set for TN-C net with aux. switch	SPB-12/280/3-HK	285083	1/24
4-pole set for TN-S net with aux. switch	SPB-12/280/4-HK	285084	1/20
4-pole set 3+1 for TN-S/TT net with aux. switch	SPB-3+1-HK	112376	1

Accessories

Auxiliary switch	SPB-HK-W	105197	4/120
Busbar	ZV-KSBI		

Note:

Max. impulse current SPD class T1 (I, B) is 12.5 kA (10/350) μ s. Maximum discharge current of T2 (II, C) class SPD is 25 kA (8/20) μ s.

Technical information p. 280

WA_SG01203



SP-B+C/3

Pre-mounted Set SPD class T1+T2 (I+II, B+C), SP-B+C/3

- Complete set SPD class T1 (I, B) of type SPI and SPD class T2 (II, C) of type SPC-S-20/460/3
 - it is not necessary to use decoupling coil
- Saving of space inside distribution board

Version	Type Designation	Article No.	Units per package
For TN-C nets	SP-B+C/3	267489	1
For TN-S, TT nets	SP-B+C/3+1	267510	1
Auxiliary switch	SPC-S-HK	248203	8/80

Note:

For type SP-B+C/3 surge protection devices class T1 (I, B) of type SPI are capsulated with impulse current 35 kA (10/350) μ s. For type SP-B+C/3+1 surge protection devices class T1 (I, B) of type SPI are capsulated with impulse current 35 kA (10/350) μ s; as a sum spark gap type SPI-100/NPE with impulse current 100 kA (10/350) μ s is used. There is used type SPC-S-20/460/3 as T2 (II, C) class SPD for both SP-B+C/3 and SP-B+C/3+1.

Technical information p. 281

SPD class T2 (II, C)

• For protection of consumers against overvoltage or switching processes caused by distant lightning strokes

U1302



SPC-E-280

Technical information p. 282

Surge arresters class T2 (II, C), SPC-E

Max. cont. op. volt. U_c	I_n (8/20) μ s	Type Designation	Article No.	Units per package
280 V AC	20 kA	SPC-E-280	248150	12/120
N-PE 260 V AC	20 kA	SPC-E-N/PE	248157	12/120

Note: Type SPC-E-N/PE is intended as a sum spark gap for connection 1+1 or 3+1.

SG14902



SPC-S-20/280

Plug-in surge arrester class T2 (II, C), SPC-S

Max. cont. op. volt. U_c	I_n (8/20) μ s	Type Designation	Article No.	Units per package
----------------------------	----------------------	------------------	-------------	-------------------

Insert 1 MU

Insert 280 V AC	20 kA	SPC-S-20/280	248161	4/120
Insert 460 V AC *)	20 kA	SPC-S-20/460	248164	4/120
Insert N-PE 260 V AC	30 kA	SPC-S-N/PE	248166	4/120

*) Spare insert for SP-B+C/3

Inserts 1 MU for special voltage

Insert 75 V AC	15 kA	SPC-S-15/75	248158	4/120
Insert 130 V AC	20 kA	SPC-S-20/130	248159	4/120
Insert 175 V AC	20 kA	SPC-S-20/175	248160	4/120
Insert 335 V AC	20 kA	SPC-S-20/335	248162	4/120
Insert 385 V AC	20 kA	SPC-S-20/385	248163	4/120
Insert 580 V AC	20 kA	SPC-S-20/580	248165	4/120

Base 1- to 4-pole

Base 1-pole	SPC-S-S1	248167	12/120
Base 1+1, 2-pole	SPC-S-S2-1+1	248201	6/60
Base 2-pole	SPC-S-S2	248168	6/60
Base 3-pole	SPC-S-S3	248169	4/40
Base 4-pole	SPC-S-S4	248170	3/30
Base 3+1, 4-pole	SPC-S-S4-3+1	248171	3/30

Complete 1- to 4-pole

• base, insert, and busbar

1-pole	280 V AC 1x20 kA	SPC-S-20/280/1	248172	12/120
2-pole	280 V AC 2x20 kA	SPC-S-20/280/2	248173	1/60
3-pole	280 V AC 3x20 kA	SPC-S-20/280/3	248174	1/40
4-pole	280 V AC 4x20 kA	SPC-S-20/280/4	248175	1/30

4-pole, 3+1	280 V AC 3x20+1x30 kA	SPC-S-3+N/PE	115795	1/30
-------------	-----------------------	--------------	--------	------

1-pole	460 V AC 1x20 kA	SPC-S-20/460/1	248184	12/120
2-pole	460 V AC 2x20 kA	SPC-S-20/460/2	248185	1/60
3-pole	460 V AC 3x20 kA	SPC-S-20/460/3	248186	1/40
4-pole	460 V AC 4x20 kA	SPC-S-20/460/4	248187	1/30

Complete 1- to 4-pole for special voltage

1-pole	130 V AC 1x20 kA	SPC-S-20/130/1	248188	12/120
1-pole	175 V AC 1x20 kA	SPC-S-20/175/1	248189	12/120
2-pole	175 V AC 2x20 kA	SPC-S-20/175/2	248190	1/60
1-pole	335 V AC 1x20 kA	SPC-S-20/335/1	248176	12/120
2-pole	335 V AC 2x20 kA	SPC-S-20/335/2	248177	1/60
3-pole	335 V AC 3x20 kA	SPC-S-20/335/3	248178	1/40
4-pole	335 V AC 4x20 kA	SPC-S-20/335/4	248179	1/30
1-pole	385 V AC 1x20 kA	SPC-S-20/385/1	248180	12/120
2-pole	385 V AC 2x20 kA	SPC-S-20/385/2	248181	1/60
3-pole	385 V AC 3x20 kA	SPC-S-20/385/3	248182	1/40
4-pole	385 V AC 4x20 kA	SPC-S-20/385/4	248183	1/30
1-pole	580 V AC 1x20 kA	SPC-S-20/580/1	248191	12/120

Auxiliary switch

SPC-S-HK	248203	8/80
----------	--------	------

Utilization: Remote signalisation of malfunction of SPD of series SPC-S and SPD-S (light or acoustic warning).

SG14802



SPC-S-S3

U1202



SPC-S-HK

U1402



Technical information p. 283, 284

U1002



Lead-through Terminal for SPD class T2 (II, C), Z-D63

Rated Current	Type Designation	Article No.	Units per package
63 A	Z-D63	248267	12/120

Technical information p. 286

Busbars for SPC ZV-KSBI

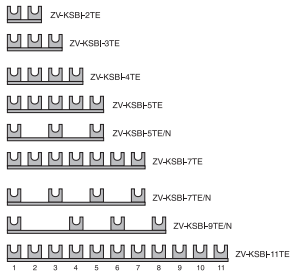

	Type Designation	Article No.	Units per package
2 MU	ZV-KSBI-2TE	263961	10/600
3 MU	ZV-KSBI-3TE	263962	10/600
4 MU	ZV-KSBI-4TE	263964	10/600
5 MU	ZV-KSBI-5TE	263965	10/200
5 MU	ZV-KSBI-5TE/N	263966	10/200
7 MU	ZV-KSBI-7TE	263967	50/500
7 MU	ZV-KSBI-7TE/N	263969	10/100
9 MU	ZV-KSBI-9TE/N	266874	50/500
11 MU	ZV-KSBI-11TE	263970	50/500

Technical information p. 286

SPD Class T3 (III, D)

- Surge arresters for protection of consumers against overvoltage
- Effectiveness of surge arrester up to 5 m of cable to both sides; for longer distances it is necessary to use another surge arrester class T3 (III, D)

U1602



SPD-S-1+1

Technical information p. 287

Overvoltage protection for installing into distribution board SPD-S

Version	Type Designation	Article No.	Units per package
Complete	SPD-S-1+1	248202	1/60
Base 1+1, 2-pole	SPC-S-S2-1+1	248201	6/60
Insert N-PE	SPD-S-N/PE	248199	4/120
Insert L-N	SPD-S-L/N	248200	4/120
Auxiliary switch	SPC-S-HK	248203	8/80

Surge protective device for IT-, TT-systems (3-phase 3-wire)

Version	Type Designation	Article No.	Units per package
Complete	SPD-S-280/2	269088	1/60
Insert	SPD-S-280	269087	4/120
Base, 2-pole	SPC-S-S2	248168	6/60
Auxiliary switch	SPC-S-HK	248203	8/80

Sockets with surge protection for designs Original, Intense, Pure

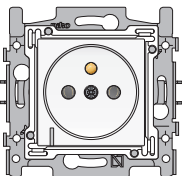

Version	Type Designation	Article No.	Units per package
Single socket 10/16 A 250 V with cover			
Colour:			
cream	100-66604	117106	6
white	101-66604	117282	6
silver	121-66604	117772	6
Frame			
Colour:			
cream Original	100-76100	117141	50
white Original	101-76100	117322	50
white Intense	120-76100	117685	1
silver Intense	121-76100	117789	1

Surge Protection module for installation in flush box VDK 280

- Clustered surge protection for a few sockets for distances up to 5 m
- Can be combined with arbitrary standard system of covers

U0797



VDK 280 ES

Version	Type Designation	Article No.	Units per package
Complete, without frame and cover	VDK280ES	215893	1

Technical information p. 288

SG00306



Plug-in Surge Arrester SPD-STC

- Rated voltage 230 V AC
- Rated current 16 A
- Signalisation function / malfunction with LED
- Maximum back-up fuse 16 A gL/gG

Version	Type Designation	Article No.	Units per package
SPD without filter, FR version	SPD-STC	105949	1/20
SPD without filter, „Schuko“	SPD-ST	105948	1/20

Technical information p. 289

SG00306

SG00106



Plug-in Surge Arrester with ISDN S0 Protection SPD-STC/ISDN

- Rated voltage 230 V AC
- Rated current 16 A
- Signalisation function / malfunction with LED
- Maximum back-up fuse 16 A gL/gG

Version	Type Designation	Article No.	Units per package
Mains + ISDN-S0, FR version	SPD-STC/ISDN	294124	1/20
Mains + ISDN-S0, „Schuko“	SPD-ST/ISDN	294121	1/20

Technical information p. 290

SG00306

SG00206



Plug-in Surge Arrester with TV Protection SPD-STC/TV-SAT

- Rated voltage 230 V AC
- Rated current 16 A
- Signalisation function / malfunction with LED
- Maximum back-up fuse 16 A gL/gG

Version	Type Designation	Article No.	Units per package
Mains + TV or SAT, FR version	SPD-STC/TV-SAT	294126	1/20
Mains + TV or SAT, „Schuko“	SPD-ST/TV-SAT	294123	1/20

Technical information p. 291

N01104



Multiple Socket Ledges 19" with SPD

- Design for 19" enclosures
- Rated current 16 A
- Signalisation function / malfunction with LED
- Maximum back-up fuse 16 A gL/gG

Version	Type Designation	Article No.	Units per package
Without filter, 7 outlets, with switch, FR version	SPD-STL/19/7F-S/BL/UTE	290032	1
Without filter, 7 outlets, with switch, „Schuko“	SPD-STL/19/7F-S/BL	283449	1

Technical information p. 292

SG06706



Surge Protective Device SP-MS/SAT

- Protection for antenna distributors/multi-switches
- Suitable for analog or digital satellite receiving facilities as well as for terrestrial TV and radio antennas
- Protection of 5 independent channels
- Design according to EN 61643-21

Description	Type Designation	Article No.	Units per package
For 5 antenna lines	SP-MS/SAT	107500	1/20

Technical information p. 293

Surge arresters for photovoltaic applications

SG11009



SG11309



Surge arresters class T2 (II, C)

- Special line of arresters for photovoltaic and other DC applications
- For voltage systems up to 600 or 1000 V DC
- With exchangeable inserts
- For earthed and unearthed systems
- Rated discharge current 15 kA (8/20 μs)

Max. continuous operating voltage UC	Type Designation	Article No.	Units per package
--------------------------------------	------------------	-------------	-------------------

For unearthed systems

600 V DC	SPPT2PA-600-2PE	132663	1/60
1000 V DC	SPPT2PA-1000-2PE	132664	1/60
1000 V DC, with auxiliary contact	SPPT2PA-1000-2PE-AX	132666	1/60

For unearthed systems

600 V DC	SPPT2PA-600-2+1PE	132661	1/40
1000 V DC	SPPT2PA-1000-2+1PE	132662	1/40
1000 V DC, with auxiliary contact	SPPT2PA-1000-2+1PE-AX	132665	1/40

Technical information p. 294, 295

Inserts

Description	Type Designation	Article No.	Units per package
For version 600 V DC	SPPT2PA-600	132667	1
For version 1000 V DC	SPPT2PA-1000	132668	1
Sum spark gap for unearthed systems, 1100 V DC	SPPT2PA-1100	132669	1

General accessories for surge protection

SG07306



Equipotential Bonding Bar PAS

- For main equipotential bonding
- Cross section of connected conductors 7 x 2.5 – 16 mm²
- Earthing strip up to 30 x 3.5 / Round conductor 7 - 10 mm
- With plastic cover

Description	Type Designation	Article No.	Units per package
Equipotential Bonding Bar	PAS-7x16	107945	10/50

SG07206



Earthing Bar for Antenna Lines PAS-HF

- Earthing equipotential bar
- Suitable e.g. for antenna systems (for connection of surge protection)
- For 6 HF-cable shields
- Earthing conductor 6 – 25 mm²

Description	Type Designation	Article No.	Units per package
Earthing Bar for Antenna Lines	PAS-HF-6	107946	10/100

SG07406



Earth Clips EBS

- For copper and galvanized steel/stainless steel tubes
- Cross-section for connection 1 x 2.5 mm² to 2 x 16 mm²
- Two sizes acc. to pipeline diameter

For pipeline diameter	Type Designation	Article No.	Units per package
1/8" - 1½"	EBS-210mm	107947	20/80
1/8" - 4"	EBS-430mm	107948	20/80

Technical information p. 296

Photovoltaic - Inverter

- Inverters for household photovoltaic systems
- Single phase design
- Output AC power 1500 to 4600 W
- Transformerless design
- Without fans – quiet cooling
- High efficiency
- Indoor line with degree of protection IP43
- Outdoor line with degree of protection IP65, inverter must not be exposed to rain (necessary to place e.g. under a roof)

wa_sg00709



wa_sg00709



PV-Inverter Grid connected ISG

- Equipped with MC3 plugs
- LCD display
- With integrated protection against earth residual current
- Works with monitoring software
- Two independent main monitoring units with all-pole disconnecter (ENS) acc. to VDE 0126-1-1

AC Output [W]	MC3	Type Designation	Article No.	Units per package
IP43				
1500 W	1 pair	ISG1I-1500/1	134753	1/14
2000 W	1 pair	ISG1I-2000/1	134754	1/14
2800 W	1 pair	ISG1I-2800/1	134755	1/12
3300 W	2 pairs	ISG1I-3300/1	135522	1/12
4000 W	2 pairs	ISG1I-4000/1	134756	1/12
IP65				
4000 W	3 pairs	ISG1O-4000/1	134757	1/12
4600 W	3 pairs	ISG3O-4600/1	134758	1/6

Control Relays EASY

- Enable simple controlling of lighting systems, heating etc.
- Front dimension for installation into installation distribution board
- Programming by means of pushbuttons and LCD or with help of Software (PC)
- 12-language menu
- 128/256 current paths
- 3/4 NC or NO contact in serial connection plus 1 coil per a row of program
- Complete information can be found in Catalogue "Elektronická a řídicí relé" (in Czech) or in or "Main Catalogue Industrial Switchgear"



Control Relays EASY

- Wide range of temperatures -25 °C – +55 °C
- Front dimension for installation into installation distribution board, width in multiples of 18 mm
- Programming by means of pushbuttons and LCD or with PC software
- Intern and extern program back-up in EEPROM memories
- 3 contacts (EASY500, EASY700), 4 contacts (EASY800, MFD-Titan) (NC or NO) in serial plus 1 coil per a row of program (current line)
- Serial and parallel connection
- 128 current lines (EASY500, EASY700)
- 256 current lines (EASY800, MFD)
- Integrated protection by means of password for switching diagram, function relay and actual values of relays
- Representation of current flow for checking of program (types with LCD)
- Menu in 12 languages: D, GB, F, I, E, P, NL, S, PL, TR, CZ, H
- Possibility to store program on memory card for types with LCD (X version: read only)
- 8 / 12 digital inputs, 2 / 4 can be used as analogous



24 V AC

Dig. inputs	Outputs	Type Designation	Article No.	Units per package
8 (2)	4 relay (8 A)	EASY512-AB-RC	274101	1
12 (4)	6 relay (8 A)	EASY719-AB-RC	274113	1

115/230 V AC

Dig. inputs	Outputs	Type Designation	Article No.	Units per package
8	4 relay (8 A)	EASY512-AC-RC	274104	1
12	6 relay (8 A)	EASY719-AC-RC	274115	1
12	6 relay (8 A)	EASY819-AC-RC	256267	1

12 V AC

Dig. inputs	Outputs	Type Designation	Article No.	Units per package
8 (2)	4 relay (8 A)	EASY512-DA-RC	274106	1
12 (4)	6 relay (8 A)	EASY719-DA-RC	274117	1

24 V DC

Dig. inputs	Outputs	Type Designation	Article No.	Units per package
8 (2)	4 relay (8 A)	EASY512-DC-RC	274109	1
8 (2)	4 transistor (0.5 A)	EASY512-DC-TC	274111	1
12 (4)	6 relay (8 A)	EASY719-DC-RC	274119	1
12 (4)	8 transistor (0.5 A)	EASY721-DC-TC	274121	1
12 (4)	6 relay (8 A)	EASY819-DC-RC	256269	1
12 (4)	8 transistor (0.5 A)	EASY821-DC-TC	256273	1
12 (4)	6 relay (8 A)	EASY820-DC-RC	256271	1
12 (4)	8 transistor (0.5 A)	EASY822-DC-TC	256276	1

Expansion units



Inputs	Outputs	Type Designation	Article No.	Units per package
12 (115/230 V AC)	6 relay (8 A)	EASY618-AC-RE	212314	1
12 (24 V DC)	6 relay (8 A)	EASY618-DC-RE	232112	1
12 (24 V DC)	8 transistor (0.5 A)	EASY620-DC-TE	212313	1
6 (24 V DC)	4 relay (8 A)	EASY410-DC-RE	114293	1
6 (24 V DC)	4 transistor (0.5 A)	EASY410-DC-TE	114294	1
0 (without supply)	2 relay (8 A)	EASY202-RE	232186	1

Programming software

Suitable for	Type Designation	Article No.	Units per package
EASY500/700	EASY-SOFT-BASIC	284545	1
EASY500/700/800 and MFD-Titan	EASY-SOFT-PRO	266040	1

Programming cables

Suitable for	Type Designation	Article No.	Units per package
EASY500/700	EASY-USB-CAB	107926	1
EASY800 and MFD-Titan	EASY800-USB-CAB	106408	1

Technical Data

Types and Characteristics of Residual Current Devices

Number of poles:

- 2-pole for 1-phase circuits
- 4-pole for 3-phase circuits

Release time-dependence:

- \square non-delayed release – for general use
- G with inactivity period of min. 10 ms – with increased resistance against unwanted tripping
- S selective, with inactivity period of min. 40 ms

Sensitivity to various current types:

- AC-type – sensitive to residual AC
- A-type – sensitive to residual AC and residual pulsating DC

Note: Besides the AC and A-types, there is also a B-type, which is sensitive to residual pulsating DC and residual smooth DC. Due to very limited number of applications and therefore a high price, this type is not in basic Eaton / Moeller offer.

Overload protection:

- without overload protection (according to EN 61008)
- with integrated overload protection (according to EN 61009) – PFL6 and PFL7 types with integrated circuit breaker in offer

Way of tripping in case of emergence of residual current:

- direct tripping – compact version (usual types)
- indirect tripping – combination of independent devices (residual current relay, core balanced transformer, power switchgear)

Tripping characteristics and selectivity of RCDs types \square , G a S

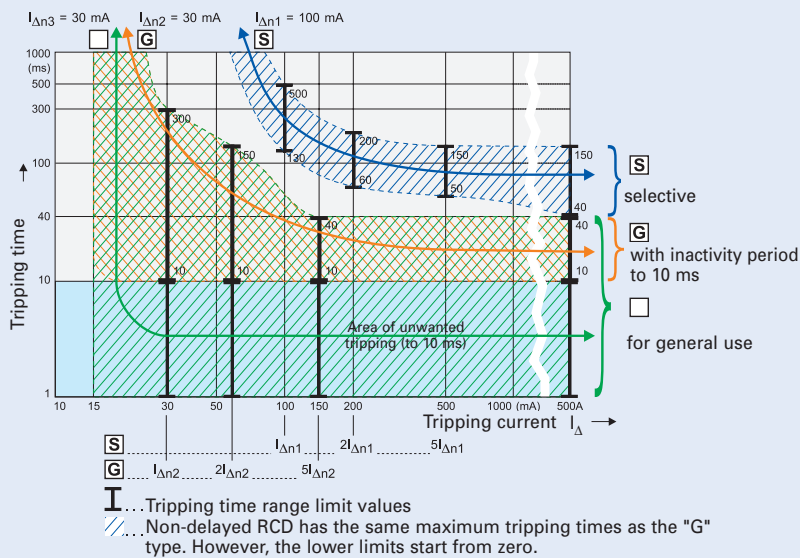

Conditions for RCD selective sequencing

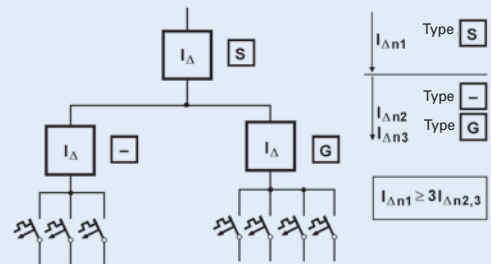

To meet selectivity requirement, the rated residual current of the selective RCD must be at least 3-multiple of the rated residual current of downstream placed RCDs of \square or G type.

Measurement of Residual Current Devices

RCDs with "G" and "S" tripping characteristics must be measured with instruments, which are designed for these RCD types. Tripping time measurement is carried out at I_{Dn} value. An instrument with sufficiently long measurement period (see upper tripping time limits) must be used for this measurement. Measurement at the constant value of the residual current ($I_{\Delta n}$, $2I_{\Delta n}$, $5I_{\Delta n}$) enables to find out the tripping times, which must not exceed the limits given in the picture. Value of the actual minimum RCD's release current ranges from 50 to 100 % $I_{\Delta n}$. Commercially available measurement instruments use different characteristics of the current rise (continuous, stepped). Therefore the observed results can slightly differ from the results obtained in the laboratory according to EN 61008 measurement methodology. Measurement at $I_{\Delta n}$ together with the tripping time measurement verifies RCD functionality. Measurement at $5I_{\Delta n}$ (mandatory for RCDs with $I_{\Delta n} \leq 30$ mA) simulates condition of the contact with a live part.









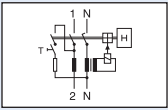
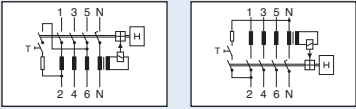

Note:

Tripping time limits (see the picture) are given for the particular residual current values ($I_{\Delta n}$, $2I_{\Delta n}$, $5I_{\Delta n}$), which are listed in the RCD standards (EN 61008, etc.). Tripping times given in HD 60364-4-41 (0.2 sec., 0.4 sec., and 5 sec.) are related to a fault, when the fault current is a multiple of the rated residual current! Mandatory requirements on RCDs can differ in each country, national standards and regulations must be fulfilled!

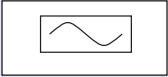
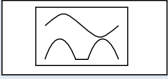
Surge current-proof

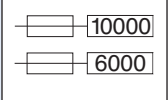
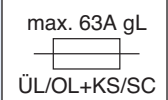
Surge current during switching processes can cause release of RCD although the residual current has not arisen. The reason is that a certain wire asymmetry in the summary transformer exists, which at peak current actuates the magnetic flow in the transformer. Higher resistance can be achieved by means of delay components (delayed RCDs). Release resistance is tested by means of the $3/20 \mu\text{s}$ impulse. In the special cases $0.5 \mu\text{s}/100$ kHz sinusoidal damped wave is used (for characteristics see e.g. EN 61008).

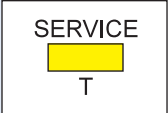
Symbols on RCDs

Symbol	Description
	2-pole device for 1-phase circuits.
	4-pole device for 3-phase circuits. Internal connection of the residual current devices can vary, therefore be aware of correct connection of the service key in circuits with incomplete number of conductors (e.g. asynchronous motors). To ensure the faultless functioning, connection of the whole number of the working conductors on the RCD input is recommended.
	Non-delayed RCD, conditionally surge current-proof up to 250 A (8/20 μs). For general use. The most often used types.
	RCD with delayed tripping (inactivity period of min. 10 ms) and high surge current-proof (up to 3 kA). The maximum tripping times are coincident with the times of RCDs for general use. It eets conditions of additional protection by means of $I_{\Delta n} = 30$ mA RCD in case of direct contact with a live part. It is also suitable for devices with high induction and capacity to earth. 4-pole version is even sensitive to the residual pulsating DC.
	Selective RCD with delayed tripping (inactivity period of min. 40 ms), with high surge current-proof (usually up to 5 kA). Particularly suitable as the main RCD and for combination with surge arrester devices.
	RCD of AC-type for circuits with residual AC. The most usual type.
	RCD of A-type for circuits with possibility of occurrence of pulsating residual DC. Utilisation in industrial installations with power switches (thyristors), in TT or IT systems (not necessary for protection of exposed conductive parts in TN systems).
	Decreases the number of unwanted releases caused by frequency converters (influence of leakage currents of filters).
	Frost-proof (up to -25 °C). Suitable for outdoor installation – in appropriate cover. Standard for all Moeller RCDs.
	Conditional short circuit strength 10 kA (6 kA) with pre-described back-up fuse. For example, the combination of the 63 A fuse and PF7 RCD can be used in a circuit with expected short-circuit current of 10 kA. This 63 A fuse can be placed anywhere in the installation. Instead of fuses, installation circuit breakers can be used in conventional installations.
	Integrated overload protection ensures overload protection of the contacts of PHF7 RCDs. UL/OL = Overload protected KS/SC = Short Current protected
	
	Service key serves for verification of the PHF7 RCD functionality only when put into operation and then once a year. It is not necessary to carry out the regular verification of the PHF7 RCD functionality, unless certain verification period is laid down in the relevant local operational regulations (construction industry, health service).
	

Selection of selectivity of RCD

$I_{\Delta n} \leq 30$ mA

Additional protection of live parts according to HD 60364-4-41. It protects even in case of direct contact with the live part. Till sconnection, the entire body current flows through the human body. However, the RCD tripping becomes before the fatal accident can occur (obligation of tripping time measurement). Sensitivity of 10 mA does not bring significant safety enhancement, problems with leakage currents of electric appliances arise.

$I_{\Delta n} > 30$ mA (100, 300 mA, 1 A)

Protection against dangerous contact with exposed conductive parts, protection in case of failure according to HD 60364-4-41. During the failure, the fault current flows through the protective earth conductor to the source and contact voltage originates on the appliance. In TN systems, the RCD sensitivity is not critical, because the contact voltage is small. The most used value is $I_{\Delta n} = 300$ mA.

$I_{\Delta n} = 300$ mA

Fire protection according to HD 60364-4-482 a HD 60364-7-... Sensitivity of 300 mA is prescribed in all cases, where a fire danger caused by crawl currents exists (warehouse, agricultural complex, wood structure, loft, museum, gallery, etc.).

RCDs for Circuits with Frequency Converters – U-version

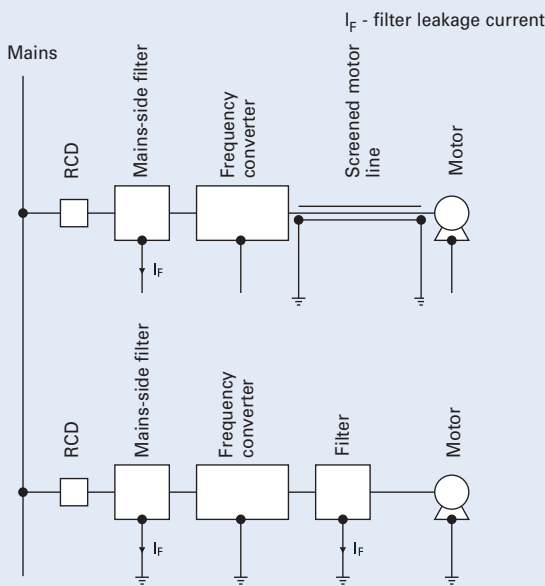

Tripping characteristic

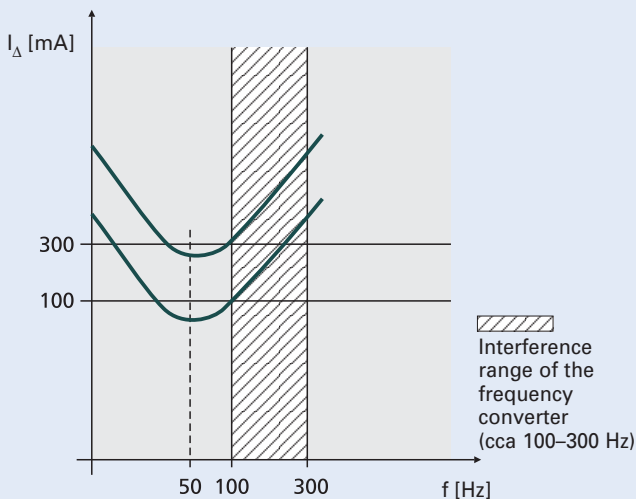

Frequency converters are used in a wide variety of systems and equipment requiring variable speed, such as lifts, escalators, conveyor belts, and large washing machines. Using RCDs for protection of exposed conductive parts causes frequent problems with unwanted tripping. Using U-version, both operational reliability and high safety can be ensured.

Why it is necessary to use U-type RCDs?

Earth discharge currents I_f flowing off through the filter into the earth conductor cause that the sum of current vectors in the working conductors is not exactly zero. Therefore, unwanted tripping of the RCD can occur.

The technical root of the above described phenomenon can be derived from the pictures on this page. Fast switching operations of semiconductor switching devices (thyristors, transistors) involving high voltages cause high interference levels which propagate through the lines on the one hand, and in the form of interfering radiation on the other. In order to eliminate this problem, a mains-side filter (also referred to as input filter or EMC-filter) is connected between the RCD and motor. The antiinterference capacitors in the filters produce discharge currents against earth which may cause unwanted tripping of the RCD due to the apparent residual currents. Since the conventional RCDs are designed for relatively wide frequency range (from tens up to hundreds of Hz), satisfactory operation without unwanted tripping in wide range of revolution regulation cannot be ensured.

Tripping characteristic of the U-type RCD in the usual frequency range of 50 – 300 Hz explains the main advantage of this type. RCDs with sensitivity of 100 or 300 mA show the rated sensitivity at 50 Hz. In case of higher frequency (see dashed 100–300 Hz range in the picture), the RCD sensitivity decreases.

Regarding the type classification, G-type is a selective type in combination with A-type (sensitivity also to pulsating residual DC).

RCDs for Circuits with X-ray Equipment – R-version

Why it is necessary to use R-version RCDs?

Utilisation of sensitive RCDs ($I_{\Delta n} \leq 30$ mA) in circuits with X-rays is prescribed in standards. When the X-ray is switched on, big peak currents originate and cause unwanted tripping of conventional RCDs (surge current-proof up to 250 A). To ensure high operational reliability, it is necessary to install at least G-type (surge current-proof up to 3 kA). However, the best solution is to use R-version, which is derived from G-type, and has been developed especially for the circuits with X-ray equipment. The practice proves that using R-version RCDs has totally eliminated unwanted tripping problem.

Note: The problem of unwanted tripping of X-ray equipment circuits must not be underestimated, since if the RCD causes the X-ray equipment tripping, the examination will have to be postponed because of limitation of the patient exposure to the X-ray.

Residual Current Device PF7

- Twin-purpose terminal (lift/open-mouthed) above and below
- Free terminal space despite installed busbar
- Busbar positioning optionally above or below
- Auxiliary switch and tripping signal contact Z-NHK can be mounted subsequently
- Auxiliary switch Z-HK can be mounted subsequently
- Contact position indicator red - green
- Delayed types suitable for being used with standard fluorescent tubes with or without electrical ballast (30mA-RCD: 30 units per phase conductor, 100mA-RCD: 90 units per phase conductor)
- The device functions irrespective of the position of installation
- Mains connection at either side
- Can be used as additional protection of live parts against dangerous contact
- Types with 80 a 100 A permissible short-circuit back-up fuse (PF7-80, PF7-100): Take into account overload protection
- The 4-pole device can also be used for 3-pole connection. For this purpose use terminals 1-2, 3-4, and 5-6 (+ cable link).
- The 4-pole device can also be used for 2-pole connection. For this purpose use terminals 5-6 and N-N.
- **The test key "T" must be pressed every month. The system operator must be informed of this obligation and his responsibility in a way that can be proven (self-adhesive RCD-label enclosed).**
- **It is recommended to use notification label Z-HWS, warn about a necessity of regular testing**
- Pressing the test key "T" serves the only purpose of function testing the residual current device (RCD). This test does not make earthing resistance measurement (RE), or proper checking of the earth conductor condition redundant, which must be performed separately.
- **Type -A:** Protects against special forms of residual pulsating DC which have not been smoothed
- **Type -G:** High reliability against unwanted tripping. Compulsory for any circuit where personal injury or damage to property may occur in case of unwanted tripping (ÖVE E 8601).

- **Type -G/A:** Additionally protects against special forms of residual pulsating DC which have not been smoothed.
- **Type -R:** Special types for X-ray application
- **Type -S:** Selective residual current device sensitive to AC, type -S
- **Type -S/A:** Additionally protects against special forms of residual pulsating DC which have not been smoothed. Mandatory for instruments with surge arresters installed downstream to RCD.
- **Type -U:** Suitable for speed-controlled drives with frequency converters in household, trade, and industry. Unwanted tripping is avoided thanks to a tripping characteristic designed particularly for frequency converters. See also explanation "Why it is necessary to use U-type RCDs?"

Accessories:

Auxiliary switch for subsequent installation to the left	Z-HK	248432
Tripping signal contact for subsequent installation to the right	Z-NHK	248434
Remote control and automatic switching device	Z-FW-LP	248296
Compact enclosure	KLV-TC-2	276240
	KLV-TC-4	276241
Notification label	Z-HWS-FI	236980
Sealing cover set	Z-RC/AK-2TE	285385
	Z-RC/AK-4TE	101062
Switching interlock	IS/SPE-1TE	101911

Connection diagrams

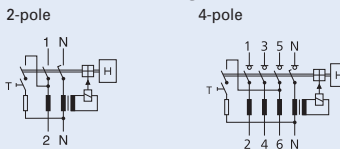

Technical Data:

Electrical:

Design according to	EN 61008 Type G acc. to ÖVE E 8001-1	
Current test marks as printed onto the device Tripping -	instantaneous	
Type G, R	10 ms delay	
Type S, U	40 ms delay with selective disconnecting function	
Rated voltage U_n	230/400 V, 50 Hz	
Rated tripping current $I_{\Delta n}$	10, 30, 100, 300, 500 mA	
Sensitivity	AC and pulsating DC	
Rated short circuit strength I_{nc}	10 kA	
Rated insulation voltage U_i	440 V	
Rated impulse withstand voltage U_{imp}	4 kV	
Maximum back-up fuse	Overload	Short circuit
$I_n = 25-40$ A	25 A gG/gL	63 A gG/gL
$I_n = 63$ A	40 A gG/gL	63 A gG/gL
$I_n = 80$ A	50 A gG/gL	80 A gG/gL
$I_n = 100$ A	63 A gG/gL	100 A gG/gL
Voltage range of test button	184 - 250 V AC (2-pole) 184 - 440 V AC (4-pole)	

Rated breaking capacity I_m or	Rated fault breaking capacity $I_{\Delta m}$	
$I_n = 16-40$ A	500 A	
$I_n = 63$ A	630 A	
$I_n = 80$ A	800 A	
$I_n = 100$ A	1000 A	
Endurance	electrical comp.	≥ 4.000 operating cycles
	mechanical comp.	≥ 20.000 operating cycles

Mechanical:

Frame size	45 mm
Device height	80 mm
Device width	35 mm (2 MU), 70 mm (4 MU)
Mounting	na přístrojovou lištu EN 60715
Terminals	open mouthed/lift terminals
Terminal protection	finger and hand touch safe
Terminal capacity	1 x (1,5-35) mm ² 2 x (1,5-16) mm ²
Busbar thickness	0,8 to 2 mm
Tripping temperature	-25 °C to +40 °C
Resistance to climatic conditions	acc. to EN 61008

Note: Instead of pre-described back-up fuses standard installation circuit breakers can be used (limiting circuit breakers PL7, PLHT, PL6).

Dimensions [mm]

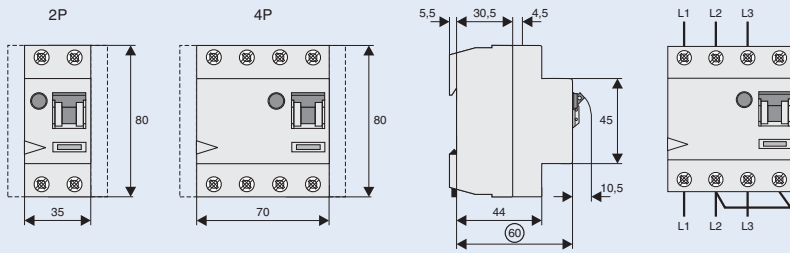

RCD PF7 in a 3-Phase AC Network without Neutral Conductor

The N-terminal must be connected by a cable link with the phase L2 (or L1), so that the test loop is supplied with current and the RCD is tested correctly.

Influence of the ambient temperature to the maximum continuous current [A]

Ambient temperature	16 A		25 A		40 A		63 A		80 A		100 A	
	2p	2p	4p	2p	4p	2p	4p	4p	4p	4p	4p	
40°	16	25	25	40	40	63	63	80	100			
45°	14	21	22	37	37	59	59	76	95			
50°	11	18	19	33	34	55	55	72	90			
55°	9	14	16	30	31	50	50	68	85			
60°	– *)	– *)	– *)	26	27	45	45	64	80			

Annotation: It has to be ensured that the values in the table are not exceeded and the back-up fuse/thermal protection works properly.

*) not applicable

Residual Current Devices dRCM - digital

- Residual current breakers with voltage independent protection functions and supplementary digital functions with rated current up to 80 A
- Conditional short circuit strength 10 kA
- System monitoring – pre-warning functions in case of residual current – local signalisation of actual level of residual currents by means of three LEDs
 - remote signalization with auxiliary contact
- A new technology enables reduction of unwanted tripping
- Regular testing recommended once a year
- Transparent window for marking labels
- Accessories can be mounted subsequently
- Shape compatible with other devices of P-line Moeller, easy connect by means of busbars
- Twin-purpose terminal (lift/open-mouthed) above and below
- Free terminal space despite installed busbar
- Busbar positioning optionally above or below
- Integrated overload protection
- Auxiliary switch and tripping signal contact Z-NHK can be mounted subsequently
- Auxiliary switch Z-HK can be mounted subsequently
- Contact position indicator red - green
- Tripping indicator white - blue
- Additional Safety
 - possibility to seal
 - possibility to lock in ON and OFF position
- Delayed types suitable for being used with standard fluorescent tubes with or without electrical ballast (30mA-RCD: 30 units per phase conductor, 100mA-RCD: 90 units per phase conductor)
- The device functions irrespective of the position of installation
- Tripping is line voltage-independent
- Mains connection at either side
- The 4-pole device can also be used for 3-pole connection: See connection possibilities.
- The 4-pole device can also be used for 2-pole connection: See connection possibilities.
- The test key "T" must be pressed every year. The system operator must be informed of this obligation and his responsibility in a way that can be proven. The yearly test interval is only valid for residential and similar applications. Under all other conditions (e.g. damply or dusty environment), it's recommended to test in shorter intervals (e.g. monthly).
- A test is further needed if red and yellow LED are on together.
- Pressing the test key "T" serves the only purpose of function testing the residual current device (RCD). This test does not make earthing resistance

- measurement (RE), or proper checking of the earth conductor condition redundant, which must be performed separately.
- Functioning
 - The green LED becomes active at 0-30 % $I_{\Delta n}$
 - The yellow LED becomes active at 30-50 % $I_{\Delta n}$
 - The red LED becomes active at > 50 % $I_{\Delta n}$
- Potential-free relay (NO contact, in parallel with the yellow LED, up to 1 A ohmic load / 230 V~) for external prewarning function. Bistable, means the warning stays on also when the breaker trips, until reset.
- Type -A:** Protects against special forms of residual pulsating DC which have not been smoothed
- Type -G:** High reliability against unwanted tripping. Compulsory for any circuit where personal injury or damage to property may occur in case of unwanted tripping (ÖVE/ÖNORM E 8001-1 § 12.1.6).
- Type -G/A:** Additionally protects against special forms of residual pulsating DC which have not been smoothed
- Type -R:** To avoid unwanted tripping due to X-ray devices
- Type -S:** Selective residual current device sensitive to AC, type -S.
- Type -S/A:** Additionally protects against special forms of residual pulsating DC which have not been smoothed.
- Type -U:** Suitable for speed-controlled drives with frequency converters in household, trade, and industry. Unwanted tripping is avoided thanks to a tripping characteristic designed particularly for frequency converters. See also explanation "Frequency Converter-Proof RCDs - What for?"

Accessories:

Auxiliary switch for subsequent installation to the left	Z-HK	248432
Tripping signal contact for subsequent installation to the right	Z-NHK	248434
Remote control and automatic switching device	Z-FW-LP	248296
Compact enclosure	KLV-TC-4	276241
Sealing cover set	Z-RC/AK-4TE	101062
Switching interlock	IS/SPE-1TE	101911

Connection diagram

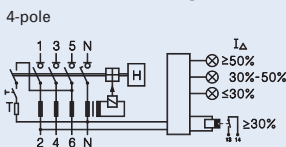

Technical Data:

Electrical:

Design according to	EN 61008, type G acc. to ÖVE E 8601
Current test marks as printed onto the device	
Tripping	instantaneous
G, R	10 ms delay
S	40 ms delay - with selective disconnecting function
U (30 mA)	10 ms delay
U (300 mA)	40 ms delay - with selective disconnecting function
Rated voltage U_n	230/400 a 240/415 V AC, 50 Hz
Operation voltage protection functions	voltage independent
electronic	50 – 254 V AC
test circuit	184 – 440 V AC
Rated tripping current $I_{\Delta n}$	30, 300 mA
Sensitivity	AC and pulsating DC
Rated short circuit capacity I_{nc}	10 kA
Rated insulation voltage U_i	440 V
Rated impulse withstand voltage U_{imp}	4 kV (1,2/50 μ s)
Peak withstand current	
Type G/A, R, U (30 mA)	3 kA (8/20 μ s)
Type S/A, U (300 mA)	5 kA (8/20 μ s)
Electrical isolation	> 4 mm
Maximum back-up fuse	Short circuit and overload protection
$I_n = 16-63$ A	63 A gG/gL
$I_n = 80$ A	80 A gG/gL

Endurance

electrical comp.	$\geq 4,000$ operating cycles
mechanical comp.	$\geq 20,000$ operating cycles

Mechanical:

Frame size	45 mm
Device height	80 mm
Device width	70 mm (4 MU)
Mounting	quick fastening with 2 lock-in positions on DIN rail EN 60715
Degree of protection, built-in	IP40
Upper and lower terminals	open mouthed/lift terminals
Terminal protection	finger and hand touch safe,
Terminal capacity	1 x (1.5 – 35) mm ² 2 x (1.5 – 16) mm ²
Terminal screw	M5 (Pozidriv PZ2)
Terminal torque	2 – 2.4 Nm
Terminal capacity warning contact > 30 %	0.25 – 1.5 mm ² (plug in terminals)
Busbar thickness	0,8 – 2 mm
Tripping temperature	-25 °C to +40 °C
Resistance to climatic conditions	acc. to EN 61008
Contact position indicator	red / green
Tripping indicator	white / blue

For types and art. numbers see page 10

Local Indication RCCB

Status indication LED

Permanent light green



red / yellow / green

Normal operation

Permanent light yellow



The measured residual current is bigger than 30% of the nominal tripping value.

Permanent light red



The measured residual current is bigger than 50% of the nominal tripping value.

Remote Indication

Signalisation contact:

1 contact NO up to 230V AC, 2 terminals, 1 A ohmic load

Terminal capacity of contacts:

0.25 – 1.5 mm² (screw-less spring terminals)

Dimensions [mm]

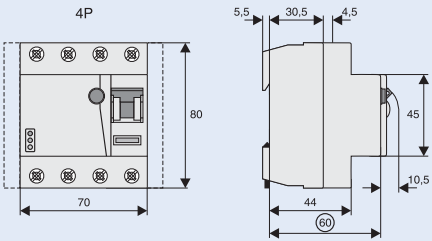

Correct connection

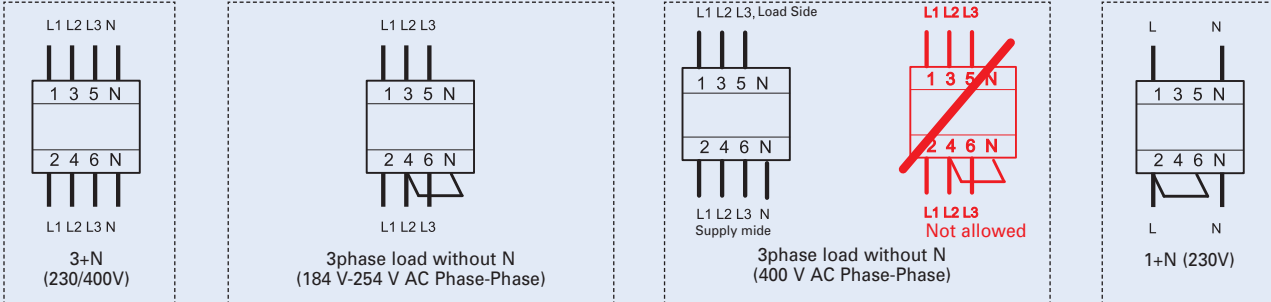

Test button works within 184 – 440 V AC. Electronic works within 50 – 254 V AC. Protection functions voltage independent.

Residual Current Relays PFR, Core Balance Transformers Z-WFR

- Identical type of auxiliary and tripping signal switch Z-NHK for PF7, PHF7
- Auxiliary switch Z-HK can be mounted subsequently
- Contact position indicator red-green
- 2 NO (breaking) contacts
- Delayed types suitable for being used with standard fluorescent tubes with or without electrical ballast (30 mA-RCD: 30 units per phase conductor, 100 mA-RCD: 90 units per phase conductor)
- **Type -U:** Suitable for speed-controlled drives with frequency converters in household, trade, and industry. Unwanted tripping is avoided thanks to a tripping characteristic designed particularly for frequency converters. See also explanation "Frequency Converter-Proof RCDs - What for?"
- **Type -S/A:** selective, sensitive to residual AC and residual pulsating DC

Accessories:

Auxiliary switch for subsequent installation to the left	Z-HK	248432
Tripping signal contact for subsequent installation to the right	Z-NHK	248434
Compact enclosure	KLV-TC-4	276241
Notification label	Z-HWS-FI	236980
Sealing Cover Set	Z-RC/AK-4TE	101062
Switching interlock	IS/SPE-1TE	101911

Connection diagrams

Relay

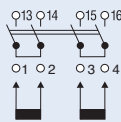

Core balance transformer



Terminals 1, 2: secondary winding
Terminals 3, 4: test circuit (actuating winding)

Technical Data

Electrical:

Design according to	EN 61008
Tripping	40 ms delay with selective disconnecting function
Rated voltage U_n	230/400 V; 50 Hz
Rated tripping current $I_{\Delta n}$	(0.1)*, 0.3 and 1 A
Rated current of relay contacts	25 A / 400 V~, 16 A / 230 V AC-15
Maximum nominal current	400 A
Sensitivity	residual AC and residual pulsating DC
Rated peak withstand voltage U_{imp}	4 kV (1.2/50 μ s)
Voltage range of test button	184–440 V AC
Endurance	electrical comp. \geq 4,000 operating cycles mechanical comp. \geq 20,000 operating cycles

Mechanical:

Frame size	45 mm
Device height	80 mm
Device width	70 mm (4 MU)
Mounting	quick fastening with 2 lock-in positions on DIN rail EN 60715
Upper and lower terminals	open mouthed/lift terminals
Terminal protection	finger and hand touch safe
Terminal capacity	1 x (1.5–35) mm ² 2 x (1.5–16) mm ²
Busbar thickness	0.8–2 mm
Control line	1.5–2.5 mm ²
Tripping temperature	-25 °C to +40 °C
Resistance to climatic conditions	acc. to EN 61008

*) see Important Information for Installation

Dimensions [mm]

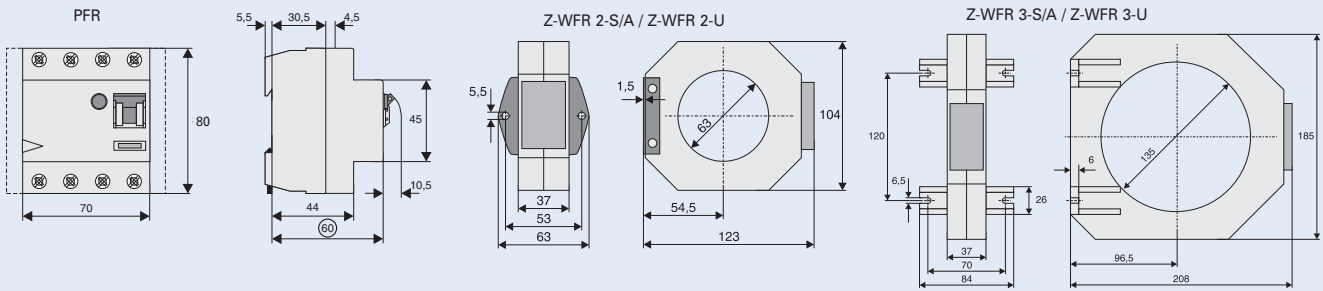

Important Information for Installation

All lines required for operation, L1, L2, and L3 including neutral N, must be routed through the transformer as follows:

Insulated lines must be laid bunched

Copper rails - Maximum distance d between copper rails 1 cm

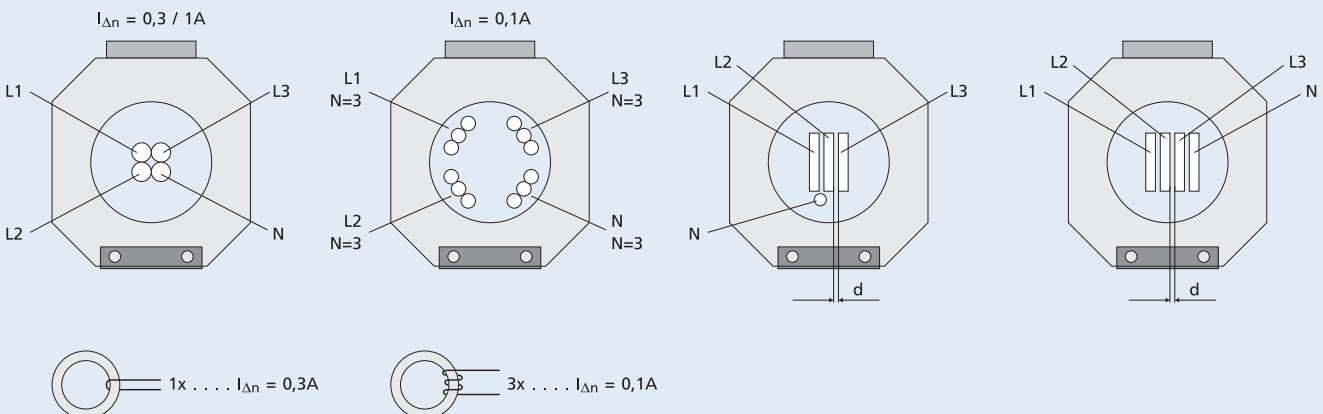

For types and art. numbers see page 12

Impulse Contact Control

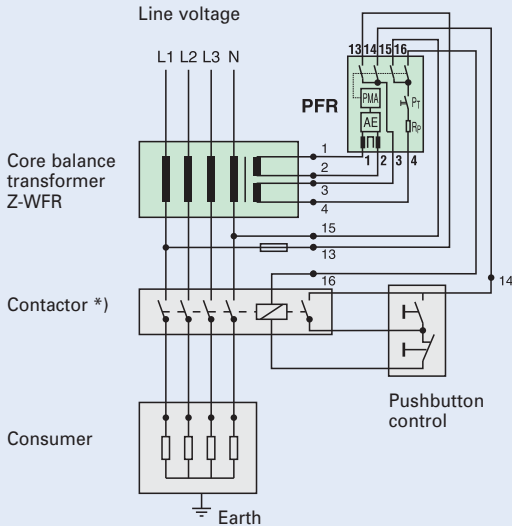

Continuous Contact Control

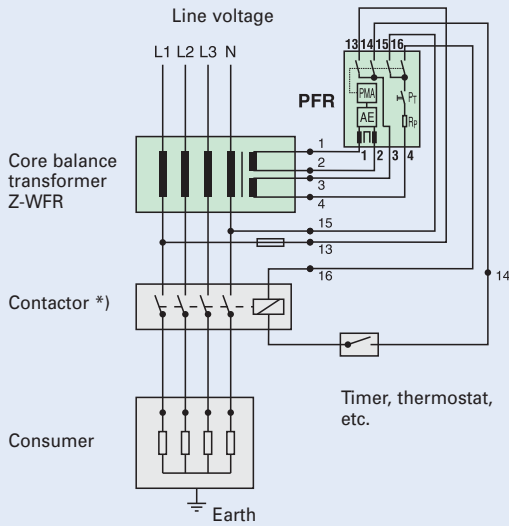

*) contactor, circuit breaker or switch with undervoltage release

Similar in TN and IT systems – there is difference in connection of PE conductor.

- Upozornění:**
- Connect terminals 1-4 of the relay to the terminals 1-4 of the transformer (see switching examples)!
 - 1+2: secondary winding; 3+4: test winding
 - Supply terminals 13 and 15 as shown, so that the test circuit can work correct!

Rated Tripping Current Matching

Matching of the rated tripping current, 0.1 or 0.3 A, is achieved by the number of turns in the primary winding of the transformer (in PFR2-03-S/A, PFR3-03-S/A, PFR2-03-U and PFR3-03-U).

Residual Current Relay	Transformer	Rated tripping current $I_{\Delta n}$ [A]	Number of primary turns	Maximum cable diameter [mm]	Maximum primary current [A]
PFR2-03-U (S/A)	Z-WFR2	0.1	3	60	150
		0.3	1	60	400
PFR3-03-U (S/A)	Z-WFR3	0.1	3	130	65
		0.3	1	130	400
PFR2-1-U (S/A)	Z-WFR2	1.0	1	60	400
PFR3-1-U (S/A)	Z-WFR3	1.0	1	130	400

Residual Current Device PHF7

- **Integrated overload protection O. L. P.**
- **Service key, need not be pressed every month**
- Twin-purpose terminal (lift/open-mouthed) above and below
- Free terminal space despite installed busbar
- Busbar positioning optionally above or below
- Identical type of auxiliary and tripping signal switch Z-NHK for PF7, PFR
- Auxiliary switch Z-HK can be mounted subsequently
- Remote switch-off (2p) by means of Z-ASA
- Contact position indicator red-green
- The device functions irrespective of the position of installation
- **Type -A:** Protects against special forms of residual pulsating DC which have not been smoothed
- **Type -G:** High reliability against unwanted tripping
- **Type -S:** Selective residual current device



Accessories:

Auxiliary switch for		
subsequent installation to the left (2p)	Z-AHK	248433
subsequent installation to the left (4p)	Z-HK	248432
Tripping signal contact for		
subsequent installation to the right	Z-NHK	248434
Remote control	Z-FW-LP	248296
Compact enclosure	KLV-TC-2	276240
	KLV-TC-4	276241
Additional terminal 35 mm ² (2 units)	Z-HA-EK/35	263960
Remote tripping module		
for PHF7-4p	Z-FAM	248293
for PHF7-2p	Z-KAM	248294
Sealing Cover Set	Z-RC/AK-4TE	101062
Switching interlock	IS/SPE-1TE	101911

Connection diagrams

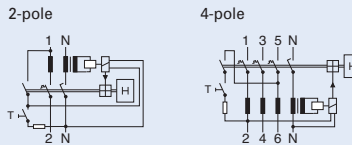

Technical Data

Electrical:

Design according to		EN 61008
		Type G acc. to ÖVE E 8601
Tripping	G, R	10 ms delay
	S	40 ms delay - with selective disconnecting function
Rated voltage U_n		230/400 V; 50 Hz
Rated tripping current $I_{\Delta n}$		30, 100, 300 mA
Sensitivity		AC and pulsating DC
Rated short circuit strength I_{nc}		10 kA
Maximum back-up fuse for overload and short circuit protection		63 A gG/gL
Rated breaking capacity I_m or		
Rated fault breaking capacity $I_{\Delta m}$		
$I_n = 25-40$ A		500 A
$I_n = 63$ A		630 A
Voltage range of test button		195.5-253 V AC
Endurance	electrical comp.	$\geq 4,000$ operating cycles
	mechanical comp.	$\geq 20,000$ operating cycles

Mechanical:

Frame size	45 mm
Device height	80 mm
Device width	35 mm (2 MU), 70 mm (4 MU)
Mounting	quick fastening with 2 lock-in positions on DIN rail EN 60715
Degree of protection, built-in	IP20
Upper and lower terminals	open mouthed/lift terminals
Terminal capacity	2p: 1-25 mm ² 4p: 1.5-35 mm ²
Busbar thickness	0.8-2 mm
Resistance to climatic conditions	acc. to EN 61008

Note: Instead of pre-described back-up fuses standard installation circuit breakers with similar let-through energy I^2t can be used without any significant change (limiting circuit breakers PL7, PLHT, PL6).

Dimensions [mm]

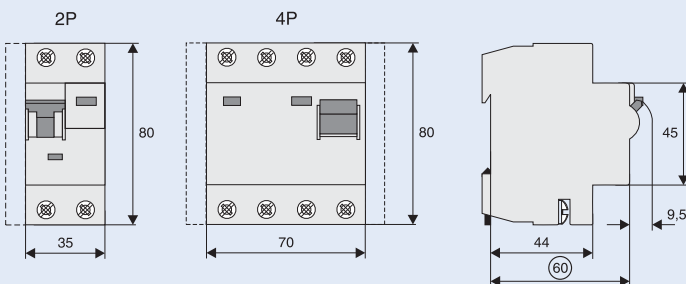

For types and art. numbers see page 14

Overload Tripping Characteristics

Typical example

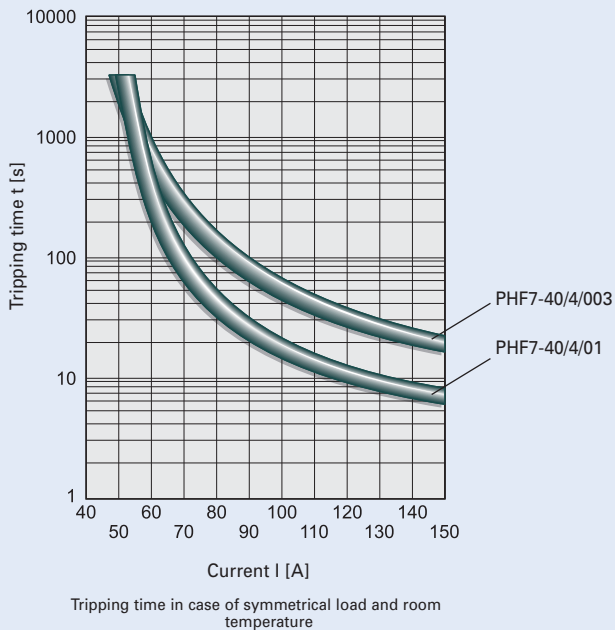

Each PHF7 RCD is protected against contact overload by means of integrated thermal protection. Regarding the PHF7 RCDs, protection from short-circuit is only required, e.g. with a fuse or restrictive circuit breaker of rated value.

Note to the overload protection

Contacts of switching devices (e.g. circuit breaker, contactor, relay, RCD) are tested according to corresponding standards for their rated current I_n . If long-lasting contact overload is expected, this possibility must be guaranteed by the device manufacturer – e.g. by means of permanent overload with certain multiple of the rated current. The rated current of the contacts is the value of current, which must be transmitted by these contacts during the continuous operation. However, in all common events it is necessary to take into account the possibility of overload (unless the circuit guarantees that the overload is impossible – resistance device, furnace, etc.).

Protection of RCDs without built-in overload protection must ensure that the current in the circuit downstream to the RCD will not exceed the value of the rated current of the contact. When using an overload protection device (fuse, circuit breaker), one must take into account that even current higher than rated current of the fuse/circuit breaker can flow through the circuit for some time.

Therefore concerning the circuit breakers, we have to consider value of the conventional non-tripping current (for circuit breakers $1.13 I_n$) and conventional tripping current (for circuit breakers of B, C, and D type up to $1.45 \times I_n$, for gG/gL fuse $1.6 \times I_n$). For this reason it is necessary to ensure timely overload disconnection by means of either pre-placed circuit breaker with smaller value of the rated current or to use RCD with protection against contact overload (PHF7, PFL7) instead.

Matching of the circuit breakers to the RCDs in the rated current ratio of 1:1 is only possible when this arrangement is required by the manufacturer (higher rated currents) or when the coincidence of the current consumption is not high and longer overload of contact is not imminent (short-period overload by switch peak currents is tolerated).

Residual Current Device PFDM

- Can be used as additional protection of live parts against dangerous contact
- Twin-purpose terminal (lift/open-mouthed) above and below
- Busbar positioning optionally above or below
- Free terminal space despite installed busbar
- Auxiliary switch Z-HD can be mounted subsequently
- Contact position indicator red-green
- The device functions irrespective of the position of installation
- **Type AC:** Sensitive to residual AC
- **Type -A:** Additionally protects against special forms of residual pulsating DC which have not been smoothed
- **Type S/A:** for protection in case of extraordinary non-damped DC. Mandatory for applications with surge protection devices downstream to RCDs.

Accessories:

Auxiliary switch for subsequent installation to the left Z-HD 265620

Connection diagram

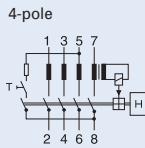

Technical Data

Electrical:

Design according to	EN 61008
Tripping	- instantaneous
	S/A 40 ms delay - with selective disconnecting function
Rated voltage U_n	230/400 V; 50 Hz
Rated current I_n	125 A
Rated tripping current $I_{\Delta n}$	30, 100, 300, 500 mA
Surge current-proof non-delayed version	> 200 A (test with damped sinusoidal wave 0.5 μ s/100 kHz)
version S/A	> 3000 A
Sensitivity	AC and pulsating DC
Rated short circuit strength I_{nc}	10 kA
Rated breaking capacity I_m or Rated fault breaking capacity $I_{\Delta m}$	1250 A
Maximum back-up fuse	Overload Short circuit 80 A gG/gL 125 A gG/gL
Voltage range of test button	185–440 V AC
Endurance	electrical comp. \geq 4,000 operating cycles mechanical comp. \geq 20,000 operating cycles

Mechanical:

Frame size	45 mm
Device height	85 mm
Device width	35 mm (2 MU), 70 mm (4 MU)
Mounting	quick fastening on DIN rail EN 60715
Degree of protection, built-in	IP20
Upper and lower terminals	open mouthed/lift terminals
Terminal capacity	1.5–50 mm ²
Busbar thickness	0.8–2 mm
Tripping temperature	-25 °C to +40 °C
Resistance to climatic conditions	acc. to EN 61008

Auxiliary Switch Z-HD

- Subsequent mounting onto RCD PFDM with screws
- Function selector

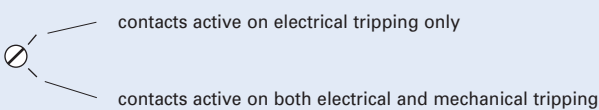

Connection diagram

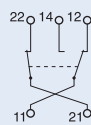

Technical Data

Electrical:

Contacts	1CO + 1NC
Load rating	
AC-11	6 A / 230 V AC
DC-11	1 A / 230 V DC

Mechanical:

Terminal capacity	2.5 mm ²
-------------------	---------------------

Dimensions [mm]

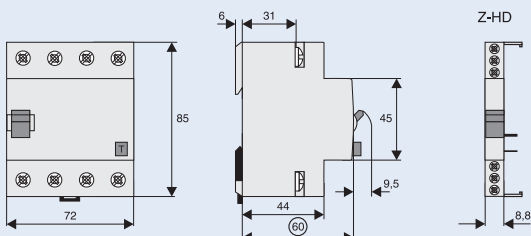

For types and art. numbers see page 16

Residual Current Device PF6

- Twin-purpose terminal (lift/open-mouthed) above and below
- Free terminal space despite installed busbar
- Busbar positioning optionally above or below
- Possibility to use auxiliary and tripping signal switch Z-NHK
- Auxiliary switch Z-HK can be mounted subsequently
- Contact position indicator red - green
- Suitable for being used with standard fluorescent tubes with or without electronical ballast (typically up to 20 units per phase conductor)
- The device functions irrespective of the position of installation
- Mains connection at either side
- Can be used as additional protection of live parts against dangerous contact
- The 4-pole device can also be used for 3-pole connection. For this purpose use terminals 1-2, 3-4, and 5-6 (+ cable link).
- The 4-pole device can also be used for 2-pole connection. For this purpose use terminals 5-6 and N-N.
- The test key "T" must be pressed every month. The system operator must be informed of this obligation and his responsibility in a way that can be proven (self-adhesive RCD-label enclosed)
- It is recommended to use notification label Z-HWS, warn about a necessity of regular testing
- Pressing the test key "T" serves the only purpose of function testing the residual current device (RCD). This test does not make earthing resistance measurement (RE), or proper checking of the earth conductor condition redundant, which must be performed separately.

Accessories:

Auxiliary switch for subsequent installation to the left	Z-HK	248432
Tripping signal contact for subsequent installation to the right	Z-NHK	248434
Remote control	Z-FW-LP	248296
Compact enclosure	KLV-TC-2	276240
	KLV-TC-4	276241
Notification label	Z-HWS-FI	236980
Tripping module	Z-FAM	248293
Tripping module	Z-KAM	248294
Switching interlock without lock	IS/SPE-1TE	101911

Connection diagrams

2-pole

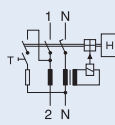

4-pole

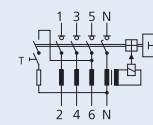

Technical Data:

Electrical:

Design according to	EN 61008	
Tripping	instantaneous	
Rated voltage U_n	230/400 V, 50 Hz	
Rated tripping current $I_{\Delta n}$	30, 300 mA	
Sensitivity	AC and pulsating DC	
Rated insulation voltage U_i	440 V	
Rated impulse withstand voltage U_{imp}	4 kV (1.2/50 μ s)	
Rated short circuit strength I_{nc}	6 kA	
Maximum back-up fuse	overload	short-circuit
$I_n = 25-40$ A	25 A gG/gL	63 A gG/gL
$I_n = 63$ A	40 A gG/gL	63 A gG/gL
Rated breaking capacity I_m or		
Rated fault breaking capacity $I_{\Delta m}$		
$I_n = 16-40$ A	500 A	
$I_n = 63$ A	630 A	
Voltage range of test button	184-250 V AC (2-pole) 184-440 V AC (4-pole)	
Endurance	electrical comp.	$\geq 4,000$ operating cycles
	mechanical comp.	$\geq 20,000$ operating cycles

Mechanical:

Frame size	45 mm
Device height	80 mm
Device width	35 mm (2 MU), 70 mm (4 MU)
Mounting	quick fastening with 2 lock-in positions on DIN rail EN 60715
Lower terminals	open-mouthed/lift terminals
Terminal protection	finger and hand touch safe
Terminal capacity	1 x (1.5-35) mm ² 2 x (1.5-16) mm ²
Busbar thickness	0.8 - 2 mm
Tripping temperature	-25 °C to +40 °C
Resistance to climatic conditions	acc. to EN 61008

Note: Instead of pre-described back-up fuses standard installation circuit breakers can be used (limiting circuit breakers PL7, PLHT, PL6).

Dimensions [mm]

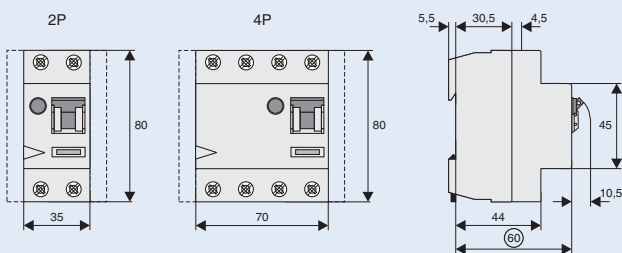

RCD PF6 in a Three-Phase AC Network without Neutral Conductor

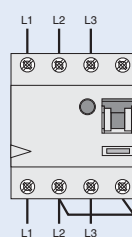

The N-terminal must be connected by a cable link with the phase L2 (or L1), so that the test loop is supplied with current and the RCD is tested correctly.

Influence of the ambient temperature to the maximum continuous current [A]

Ambient temperature	25 A		40 A		63 A
	2p	4p	2p	4p	4p
40°	25	25	40	40	63
45°	21	22	37	37	59
50°	18	19	33	34	55
55°	14	16	30	31	50
60°	– *)	– *)	26	27	45

Annotation: It has to be ensured that the values in the table are not exceeded and the back-up fuse/thermal protection works properly.

*) not applicable

Leakage current monitor PDIM

- Without main contacts
- Conditional short circuit strength 10 kA
- Rated residual current adjustable in step 30, 100, 300, 500 and 1000 mA
- Version A – Sensitive to special forms of residual pulsating DC which have not been smoothed
- Tripping behaviour adjustable: instantaneous – delayed G type – selective S type
- Local signalisation of level of residual current by means of LEDs
- Remote signalisation of level of residual current with two potential-free auxiliary contacts 10 A / 230 V AC
- Mains connection at either side
- The device works irrespective of the position of installation
- Twin-purpose terminal (lift/open-mouthed) above and below
- Free terminal space despite installed busbar

Connection diagram

4-pole

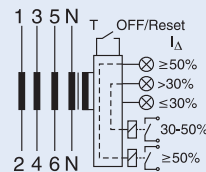

Technical Data:

Electrical:

Design similar to	EN 62020
Current test marks as printed onto the device	
Tripping behaviour (adjustable)	instantaneous
Type G	10 ms delay
Type S	40 ms delay - selective
Rated voltage U_n	230/400 V, 50/60 Hz, 240/415 V, 50/60 Hz
Rated current I_n	nastavitelný 30, 100, 300, 500, 1000 mA
Sensitivity	AC and pulsating DC
Rated insulation voltage U_i	440 V
Rated short circuit resistance I_{nc}	10 kA
Max. back-up fuse admitted	Short-circuit Overload
$I_n = 40$ A	40 A gG/gL 63 A gG/gL
$I_n = 100$ A	63 A gG/gL 100 A gG/gL
Endurance electrical comp.	≥ 4,000 operating cycles
mechanical comp.	≥ 20,000 operating cycles

Mechanical:

Frame size	45 mm
Device height	80 mm
Device width	70 mm (4 MU)
Mounting	Quick fastening with 2 lock-in positions on DIN rail EN 50022
Upper and lower terminals	Open-mouthed/lift terminals
Degree of protection of terminals	IP20
Cross section of connected conductor (main terminals)	1 x (1.5–35) mm ² , solid conductor 2 x (1.5–16) mm ² , multi-wired conductor
Cross section of connected conductor (contacts)	0,25 -1,5 mm ²
Busbar thickness	0.8 – 2 mm
Admitted ambient temperature range	-25 °C to +40 °C
Resistance to climatic conditions	podle EN 61008

Dimensions [mm]

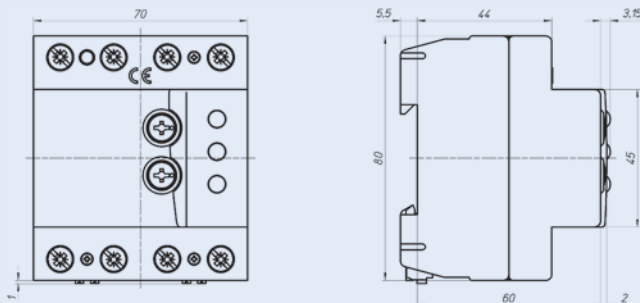

Add-on Residual Current Protection Unit PBHT

- By combination with miniature circuit breaker PLHT
- Add-on residual current unit (screw connection) for 80 or 125 A
- High flexibility and ease of installation thanks to variable wiring (400 mm flexible connection wires included in the set)
- Free selection of main power supply
- Auxiliary switch 1 NO included as standard in all PBHT versions
- For subsequent mounting onto 3, 3+N-miniature circuit breakers PLHT
- Toggle (serves as switch position- and tripping indicator)
- The screw connection to the PLHT-device can be unscrewed at any time. Consequently, in case of modifications of the systems to be protected, the installation can be adapted to new requirements at any time.

Accessories:

Flexible connection wires (connection to PLHT) are included in the standard set:

4-pole 80 A	4 x 16 mm ² (400 mm each)
4-pole 125 A	4 x 35 mm ² (400 mm each)
Switching interlock	IS/SPE-1TE 101911

Connection diagram

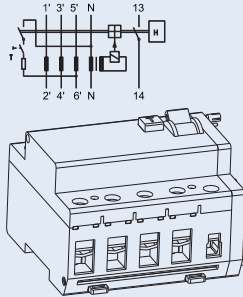

Technical Data:

Electrical:

Design according to	EN 60947-2
Current flow paths	
Rated voltage U_e	230/400 V AC
Operational voltage range	196–440 V
Rated frequency	50 Hz
Rated current I_n	80 A, 125 A
Rated tripping current $I_{\Delta n}$	30, 300, 500, 1000 mA
Rated non-tripping current $I_{\Delta no}$	$0.5 I_{\Delta n}$
Sensitivity	AC and pulsating DC
Tripping characteristic	instantaneous
	Type S 40 ms with selective disconnecting function
Rated service short circuit breaking capacity I_{cn}	same as connected PLHT
Rated ultimate circuit breaking capacity I_{cu}	same as connected PLHT
Rated fault short circuit breaking capacity $I_{\Delta in} = I_{cu}$	
Rated peak withstand voltage U_{imp}	4 kV (1.2/50 μ s)
Endurance mechanical comp.	
PBHT-80	>10000 operating cycles
PBHT-125	>8000 operating cycles
Endurance electrical comp.	
PBHT-80	>1500 operating cycles
PBHT-125	>1000 operating cycles

Auxiliary Contact

Utilisation category AC15	
Rated voltage U_e	250 V AC
Rated operational current I_e	16 A AC

Mechanical:

Frame size	45 mm
Device height	90 mm
Device width	95 mm (5.5 MU)
Mounting	screwed onto PLHT
	3-, 4-pole
Upper and lower terminals	třmenové
Ochrana svorek	finger and hand touch safe
Terminal capacity	
Main conductor	2.5–50 mm ²
Auxiliary switch	1–25 mm ²
Degree of protection, built-in	IP40
Permissible ambient temperature range	-25 °C to +40 °C
Resistance to climatic conditions	acc. to IEC 60068-2 (25...55 °C/90...95 % relative humidity)

Dimensions [mm]

PBHT + PLHT/3p+N

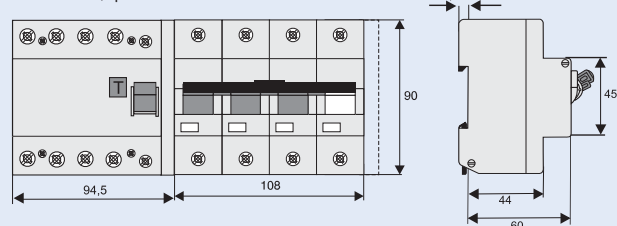

PBHT + PLHT/3p

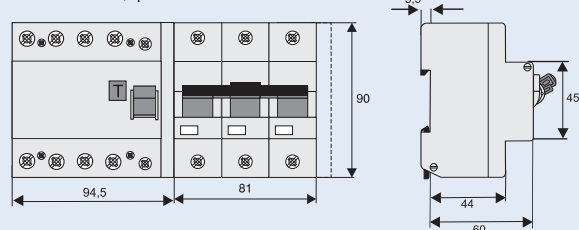

Wiring options

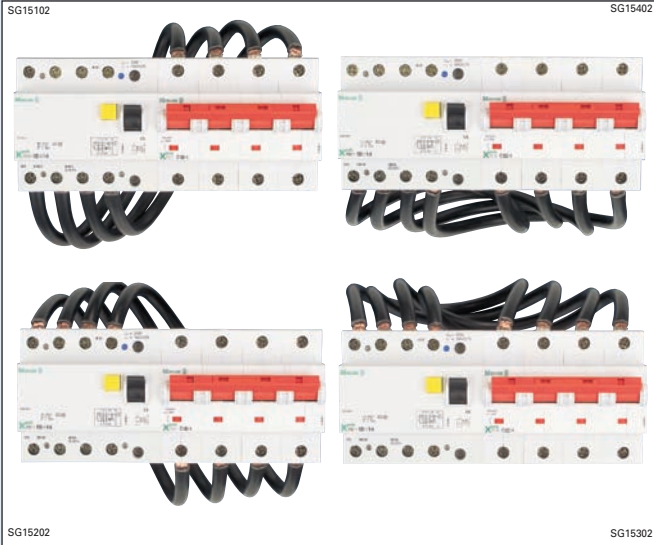

Mounting PBHT + PLHT

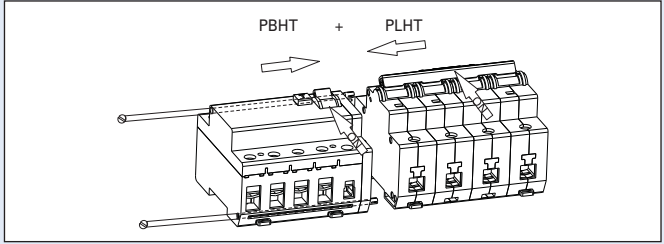

Connection PBHT/4p + PLHT/3p

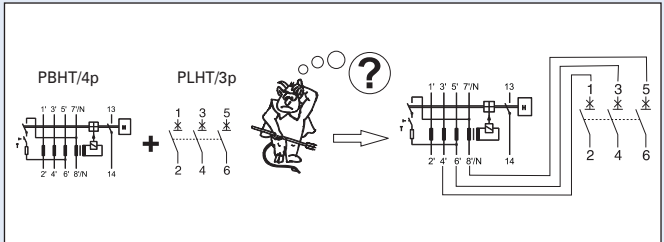

Mounting arrangement residual current protection unit - shunt trip release - miniature circuit breaker - auxiliary contact

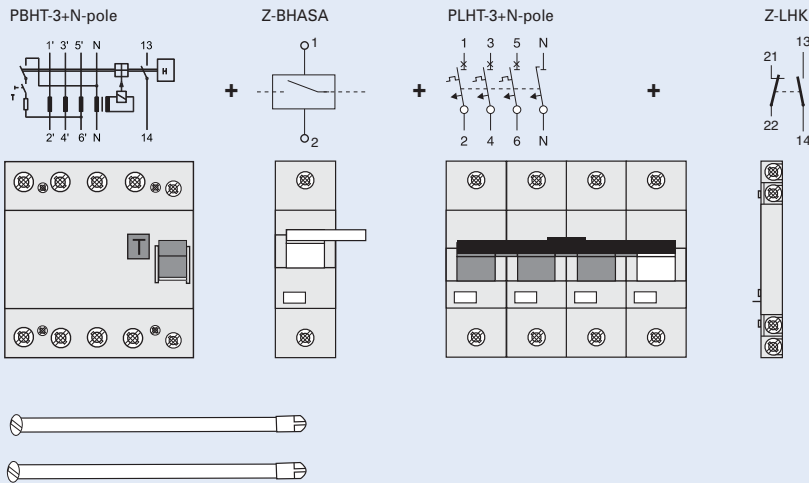

Accessories for PBHT

Shunt Trip Release Z-BHASA

- Can be mounted subsequently
- Contact position indicator red-green
- Marking labels can be fitted
- Wide operational voltage range
- Sufficient power of extra low voltage source must be ensured
Z-BHASA/24: min. 90 VA
- Screws for mounting included PBHT (PBHT => Z-BHASA => PLHT)

Connection diagram

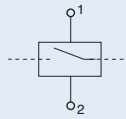

Technical Data

	Z-BHASA/24	Z-BHASA/230
Electrical:		
Minimum pulse duration	15 ms	10 ms
Internal resistance	2 Ω	130 Ω
Duty	100 %	100 %
Tripping time	< 20 ms	< 20 ms
Peak withstand voltage (1.2/50 μs)	2 kV	2 kV
Endurance	> 4000 operating cycles	> 4000 operating cycles
AC voltage range:		
Responding limit	8 V	70 V
Operational voltage range	12–60 V	110–415 V
Maximum current consumption during switch-on	1.4–7 A	3.4 A (at 230 V)
Current flow time at max. current consumption	4.0 ms	4.5 ms
DC voltage range:		
Responding limit	11 V	90 V
Operational voltage range	12–60 V	110–230 V
Maximum current consumption during switch-on	1,7 A typ.	1,7 A typ.
Current flow time at max. current consumption	2 ms	4 ms
Mechanical:		
Frame size	45 mm	45 mm
Device height	90 mm	90 mm
Device width	27 mm	27 mm
Mounting	quick fastening on DIN rail EN 60715	
Degree of protection, built-in	IP40	IP40
Upper and lower terminal screws	lift terminals	lift terminals
Terminal capacity	2.5–30 mm ²	2.5–30 mm ²
Fastening torque of terminal screws	4 Nm	4 Nm

Dimensions [mm]

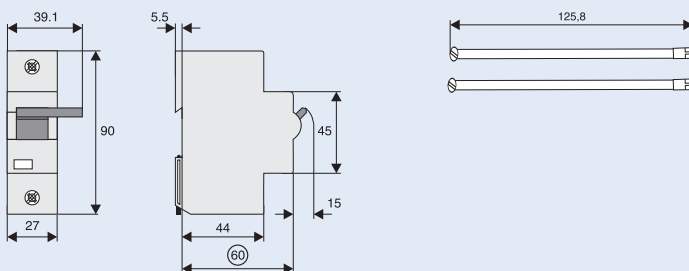

Combined RCD/MCB Devices PFL7, 1+N-pole

- Can be used as additional protection of live parts against dangerous contact
- Twin-purpose terminal (lift/open-mouthed) above and below
- Free terminal space despite installed busbar
- Busbar positioning optionally above or below
- Guide for secure terminal connection
- Switching toggle (MCB component) in colour designating the rated current
- Contact position indicator red - green
- Comprehensive range of accessories suitable for subsequent installation
- **Type -A:** Protects against special forms of residual pulsating DC which have not been smoothed
- **Type -G:** 10 ms time delay in order to avoid unwanted tripping (e.g. during thunderstorms).
- **The test key "T" must be pressed every month**

Accessories:

Auxiliary switch for subsequent installation	ZP-IHK	286052
	ZP-WHK	286053
Tripping signal switch for subsequent installation	ZP-NHK	248437
Shunt trip release	ZP-ASA/..	248438, 248439
Tripping module	Z-KAM	248294
Terminal cover cap	KLV-TC-2	276240
Additional terminal 35 mm ² (2 units)	Z-HA-EK/35	263960
Notification label	Z-HWS-FI	236980
Switching interlock	IS/SPE-1TE	101911

Connection diagram

1+N-pole

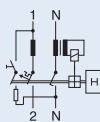

Technical Data

Electrical:

Design according to	EN 61009
Tripping	- instantaneous 250 A (8/20 μs) (surge current-proof); G 10 ms delay 3kA (8/20 μs) surge current-proof
Rated voltage U_e	230 V; 50 Hz
Operational voltage range	196–253 V
Rated tripping current $I_{\Delta n}$	30 mA
Rated non-tripping current $I_{\Delta no}$	0.5 $I_{\Delta n}$
Sensitivity	AC and pulsating DC
Selectivity class	3
Rated breaking capacity	10 kA
Rated current	6 – 40 A
Rated peak withstand voltage U_{imp}	6 kV (1.2/50 μs)
Characteristic	B, C
Maximum back-up fuse (short circuit)	100 A gL (>10 kA)
Endurance	electrical comp. ≥ 4,000 operating cycles mechanical comp. ≥ 20,000 operating cycles

Mechanical:

Frame size	45 mm
Device height	80 mm
Device width	35 mm (2 MU)
Mounting	quick fastening on DIN rail EN 60715
Upper and lower terminals	open mouthed/lift terminals
Terminal capacity	1–25 mm ²
Busbar thickness	0.8–2 mm
Degree of protection switch	IP20
Tripping temperature	-25 °C to +40 °C
Resistance to climatic conditions	acc. to EN 61009

Dimensions [mm]

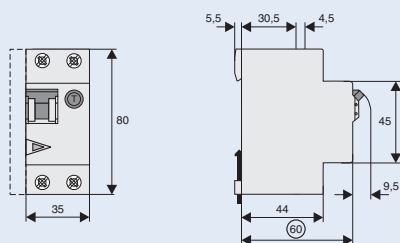

Load Capacity PFL7../1N/

Effect of ambient temperature (MCB component)

I _n [A]	Ambient temperature T [°C]								
	-25	-20	-10	0	10	20	30	35	40
6	7,4	7,2	7,0	6,7	6,5	6,3	6,0	5,9	5,8
10	12	12	12	11	11	10	10	9,9	9,7
13	16	16	15	15	14	14	13	13	13
16	20	19	19	18	17	17	16	16	15
20	25	24	23	22	22	21	20	20	19
25	31	30	29	28	27	26	25	25	24
32	40	38	37	36	35	33	32	32	31
40	49	48	47	45	43	42	40	39	39

Tripping Characteristic PFL7../1N/, Characteristics B and C

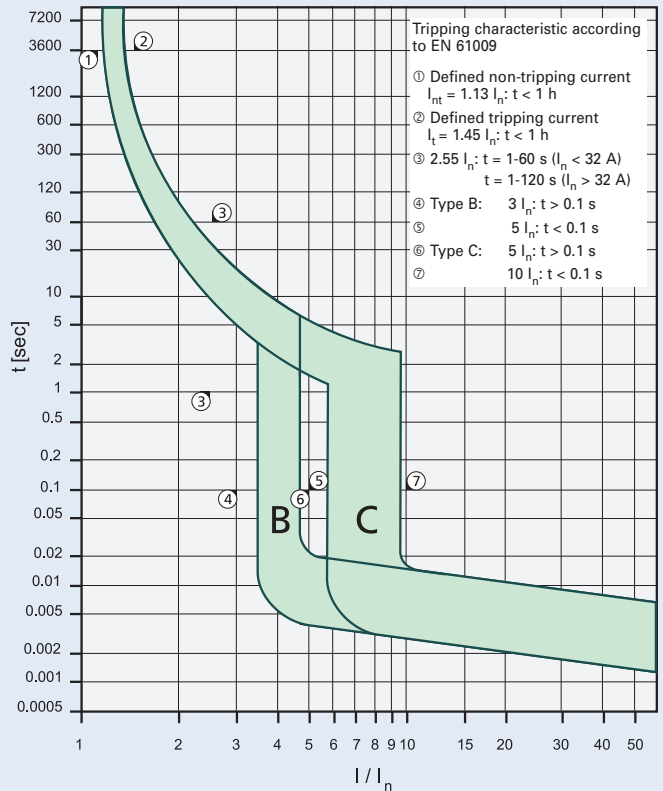

Short Circuit Selectivity PFL7... towards DIAZED

In case of short circuit, there is selectivity between the combined RCD/MCB devices PFL7../1N/ and the upstream fuses up to the specified values of the selectivity limit current I_s [kA] (i. e. in case of short-circuit currents I_{ks} under I_s, only the MCB will trip, in case of short circuit currents above this value both protective devices will respond).

*) basically in accordance with EN 60898 D.5.2.b

Short circuit selectivity **characteristic B** towards fuse link **DIAZED*** [kA]

PFL7	DIAZED DII-DIV gL/gG								
I _n [A]	10	16	20	25	35	50	63	80	100
6		<0.5 ¹⁾	0.7	1.0	2.9	6.9	10.0 ²⁾	10.0 ²⁾	10.0 ²⁾
10			0.6	0.9	1.9	3.3	7.0	10.0 ²⁾	10.0 ²⁾
13			0.5	0.7	1.6	2.8	5.7	9.0	10.0 ²⁾
16				0.7	1.4	2.4	4.4	7.0	10.0 ²⁾
20					1.3	2.2	4.0	6.3	10.0 ²⁾
25					1.3	2.1	3.8	5.8	10.0 ²⁾
32						2.0	3.5	5.2	9.5
40							3.1	4.5	8.1

Short circuit selectivity **characteristic C** towards fuse link **DIAZED*** [kA]

PFL7	DIAZED DII-DIV gL/gG								
I _n [A]	10	16	20	25	35	50	63	80	100
6		<0.5 ¹⁾	0.6	1.0	2.9	5.8	10.0 ²⁾	10.0 ²⁾	10.0 ²⁾
10			<0.5	0.7	1.5	2.6	5.3	9.0	10.0 ²⁾
13					1.4	2.3	4.6	7.6	10.0 ²⁾
16					1.2	1.8	3.4	5.5	10.0 ²⁾
20					1.2	1.7	3.1	5.0	10.0 ²⁾
25						1.6	2.9	4.6	10.0 ²⁾
32							2.3	3.4	7.7
40								2.9	6.2

¹⁾ Selectivity limit current I_s under 0.5 kA

²⁾ Selectivity limit current I_s = rated breaking capacity I_{cn} of the RCD/MCB device

Darker areas: no selectivity



Short Circuit Selectivity PFL7../1N/ towards NEOZED

In case of short circuit, there is selectivity between the combined RCD/MCB devices PFL7../1N/ and the upstream fuses up to the specified values of the selectivity limit current I_s [kA] (i. e. in case of short-circuit currents I_{ks} under I_s , only the MCB will trip, in case of short circuit currents above this value both protective devices will respond).

*) basically in accordance with EN 60898 D.5.2.b

Short circuit selectivity **characteristic B** towards fuse link **NEOZED*** [kA]

PFL7	NEOZED D01-D03 gL/gG									
I_n [A]	10	16	20	25	35	50	63	80	100	
6		<0.5 ¹⁾	0.5	0.8	2.4	8.2	10.0 ²⁾	10.0 ²⁾	10.0 ²⁾	
10			0.5	0.8	1.6	3.7	6.0	10.0 ²⁾	10.0 ²⁾	
13			0.6	0.7	1.4	3.0	4.7	9.0	10.0 ²⁾	
16				0.6	1.2	2.6	3.9	7.0	10.0 ²⁾	
20					1.2	2.5	3.6	6.2	10.0 ²⁾	
25					1.2	2.3	3.3	5.7	10.0 ²⁾	
32						2.3	3.1	5.1	10.0 ²⁾	
40							2.8	4.5	9.5	

Short circuit selectivity **characteristic C** towards fuse link **NEOZED*** [kA]

PFL7	NEOZED D01-D03 gL/gG									
I_n [A]	10	16	20	25	35	50	63	80	100	
6		<0.5 ¹⁾	<0.5 ¹⁾	0.8	2.3	6.5	10.0 ²⁾	10.0 ²⁾	10.0 ²⁾	
10			<0.5	0.6	1.3	2.9	4.5	8.9	10.0 ²⁾	
13					1.2	2.5	3.9	7.6	10.0 ²⁾	
16					1.0	2.1	3.0	5.5	10.0 ²⁾	
20					1.0	2.0	2.7	5.0	10.0 ²⁾	
25						1.9	2.6	4.5	10.0 ²⁾	
32							2.1	3.4	10.0 ²⁾	
40								3.0	8.7	

Short Circuit Selectivity PFL7../1N/ towards NH-00

In case of short circuit, there is selectivity between the combined RCD/MCB devices PFL7../1N/ and the upstream fuses up to the specified values of the selectivity limit current I_s [kA] (i. e. in case of short-circuit currents I_{ks} under I_s , only the MCB will trip, in case of short circuit currents above this value both protective devices will respond).

*) basically in accordance with EN 60898 D.5.2.b

Short circuit selectivity **characteristic B** towards fuse link **NH-00*** [kA]

PFL7	NH-00 gL/gG												
I_n [A]	16	20	25	32	35	40	50	63	80	100	125	160	
6	<0.5 ¹⁾	0.5	0.8	1.4	2.2	3.3	7.0	10.0 ²⁾	10.0 ²⁾	10.0 ²⁾	10.0 ²⁾	10.0 ²⁾	
10		<0.5 ¹⁾	0.7	0.9	1.5	2.1	3.4	4.3	7.3	10.0 ²⁾	10.0 ²⁾	10.0 ²⁾	
13			<0.5 ¹⁾	0.6	0.8	1.4	1.8	2.8	3.6	5.7	10.0 ²⁾	10.0 ²⁾	10.0 ²⁾
16				0.6	0.7	1.2	1.5	2.4	3.0	4.5	10.0 ²⁾	10.0 ²⁾	10.0 ²⁾
20					0.7	1.1	1.5	2.2	2.8	4.2	9.2	10.0 ²⁾	10.0 ²⁾
25					0.7	1.1	1.4	2.1	2.6	4.0	8.2	10.0 ²⁾	10.0 ²⁾
32						1.0	1.4	2.0	2.5	3.7	7.1	10.0 ²⁾	10.0 ²⁾
40								2.3	3.4	6.2	8.8	10.0 ²⁾	

Short circuit selectivity **characteristic C** towards fuse link **NH-00*** [kA]

PFL7	NH-00 gL/gG												
I_n [A]	16	20	25	32	35	40	50	63	80	100	125	160	
6	<0.5 ¹⁾	<0.5 ¹⁾	0.7	1.3	2.2	3.3	5.9	8.0	10.0 ²⁾	10.0 ²⁾	10.0 ²⁾	10.0 ²⁾	
10			0.5	0.8	1.2	1.7	2.7	3.4	5.5	10.0 ²⁾	10.0 ²⁾	10.0 ²⁾	
13					1.1	1.5	2.3	2.9	4.7	10.0 ²⁾	10.0 ²⁾	10.0 ²⁾	
16					1.0	1.3	1.8	2.3	3.7	8.7	10.0 ²⁾	10.0 ²⁾	
20					0.9	1.1	1.7	2.2	3.4	8.0	10.0 ²⁾	10.0 ²⁾	
25						1.6	2.1	3.2	7.2	10.0 ²⁾	10.0 ²⁾		
32							1.7	2.6	5.3	9.0	10.0 ²⁾		
40								2.4	4.5	7.5	10.0		

¹⁾ Selectivity limit current I_s under 0.5 kA

²⁾ Selectivity limit current I_s = rated breaking capacity I_{cn} of the RCD/MCB device

Darker areas: no selectivity

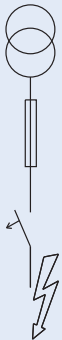

Let-through Energy I^2t PFL7

Let-through energy I^2t PFL7, characteristic B, 1+N-pole

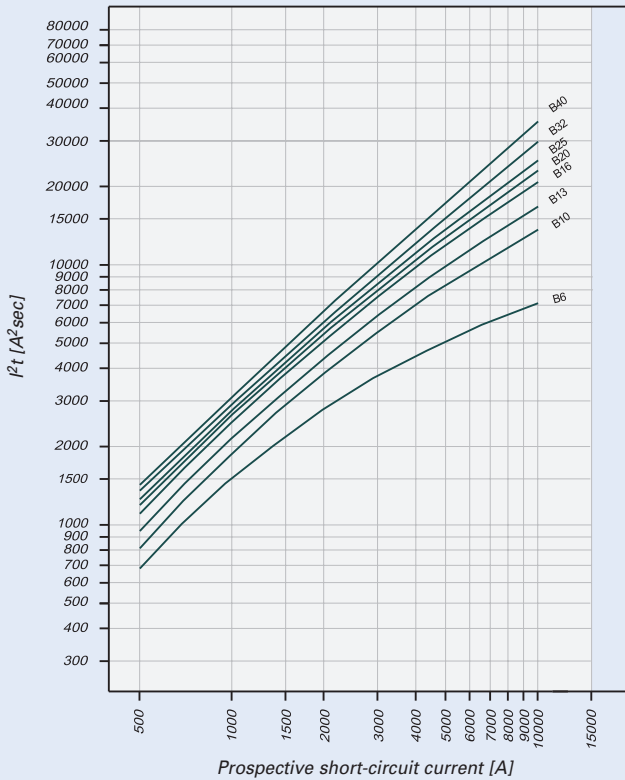

Let-through energy I^2t PFL7, characteristic C, 1+N-pole

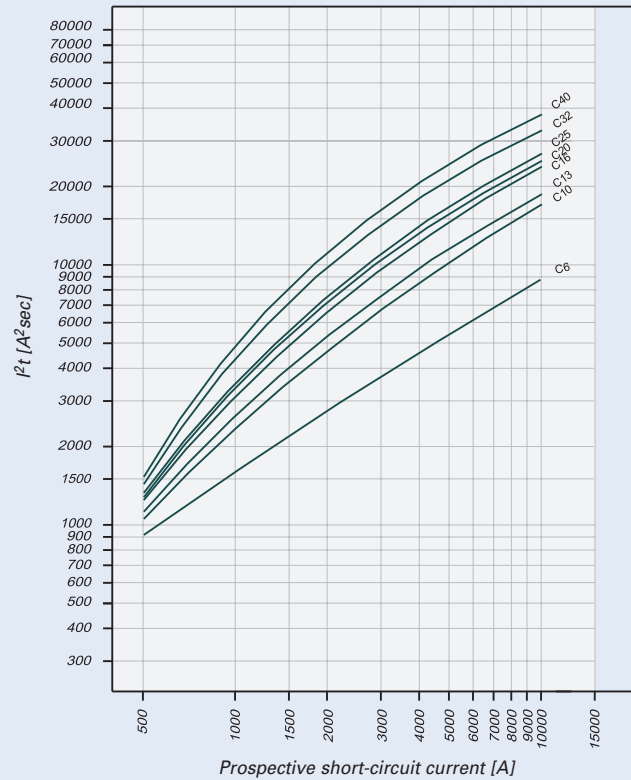

Cascading of PFL7 and NZM circuit breakers

- Cascading ensures proper function of downstream circuit breaker in circuits where prospective short circuit current exceeds breaking capacity of this breaker
- Effective system-based solution
- Cost and space saving
- Conditional breaking capacity acc. to EN 60947-2
- Values for 400 V AC

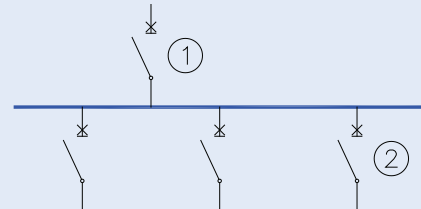

Downstream breaker PFL7 characteristics B and C ②	Upstream breaker ①						
	I_n [A]	≤ 160			≤ 250		
	Type	NZMB1-A	NZMN1-A	NZMH1-A	NZMB2-A	NZMN2-A	NZMH2-A
	I_{cu} [kA] 415 V AC	25	50	100	25	50	150
$I_n \leq 16$ A	Conditional breaking capacity of PFL7 [kA]	25	35	35	25	50	50
$I_n > 16$ A	Conditional breaking capacity of PFL7 [kA]	25	35	35	25	30	50

Combined RCD/MCB Devices PFL6, 1+N-pole

- Can be used as additional protection of live parts against dangerous contact
- Twin-purpose terminal (lift/open-mouthed) above and below
- Free terminal space despite installed busbar
- Busbar positioning optionally above or below
- Guide for secure terminal connection
- Contact position indicator red-green
- Comprehensive range of accessories suitable for subsequent installation
- **The test key "T" must be pressed every month**

Accessories:

Auxiliary switch for subsequent installation	ZP-IHK	286052
	ZP-WHK	286053
Tripping signal switch for subsequent installation	ZP-NHK	248437
Shunt trip release	ZP-ASA/..	248438, 248439
Tripping module	Z-KAM	248294
Terminal cover cap	KLV-TC-2	276240
Additional terminal 35 mm ² (2 units)	Z-HA-EK/35	263960
Notification label	Z-HWS-FI	236980
Switching interlock	IS/SPE-1TE	101911

Connection diagram

1+N-pole

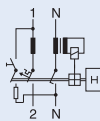

Technical Data

Electrical:

Design according to	EN 61009
Tripping	- instantaneous 250 A (8/20 μ s) (surge current-proof)
Rated voltage U_e	230 V; 50 Hz
Operational voltage range	196–253 V
Rated tripping current $I_{\Delta n}$	30 mA
Rated non-tripping current $I_{\Delta no}$	0.5 $I_{\Delta n}$
Sensitivity	residual AC
Selectivity class	3
Rated breaking capacity	6 kA
Rated current	6–25 A
Rated peak withstand voltage U_{imp}	4 kV (1.2/50 μ s)
Characteristic	B, C
Maximum back-up fuse (short circuit)	100 A gL (>6 kA)
Endurance	electrical comp. \geq 4,000 operating cycles mechanical comp. \geq 20,000 operating cycles

Mechanical:

Frame size	45 mm
Device height	80 mm
Device width	35 mm (2 MU)
Mounting	quick fastening on DIN rail EN 60715
Upper and lower terminals	open mouthed/lift terminals
Terminal capacity	1–25 mm ²
Busbar thickness	0.8–2 mm
Degree of protection switch	IP20
Tripping temperature	-25 °C to +40 °C
Resistance to climatic conditions	acc. to EN 61009

Dimensions [mm]

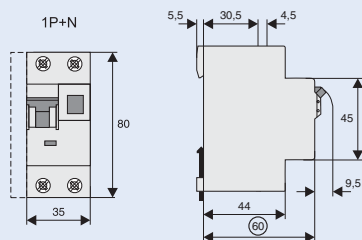

Load Capacity PFL6../1N/

Effect of ambient temperature (MCB component)

I _n [A]	Ambient temperature T [°C]								
	-25	-20	-10	0	10	20	30	35	40
6	7,4	7,2	7,0	6,7	6,5	6,3	6,0	5,9	5,8
10	12	12	12	11	11	10	10	9,9	9,7
13	16	16	15	15	14	14	13	13	13
16	20	19	19	18	17	17	16	16	15
20	25	24	23	22	22	21	20	20	19
25	31	30	29	28	27	26	25	25	24

Tripping Characteristic PFL6../1N/, Characteristics B and C

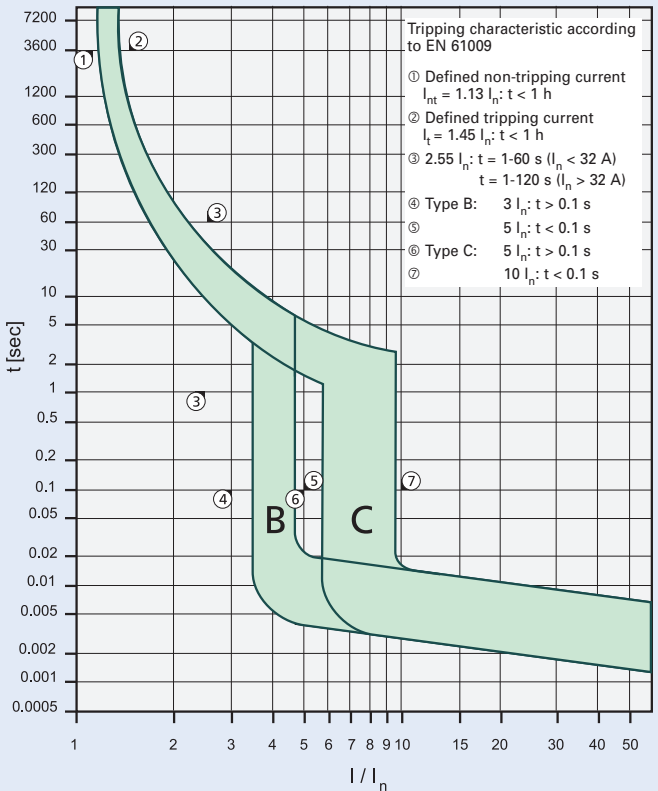

Short Circuit Selectivity PFL6../1N/ towards DIAZED

In case of short circuit, there is selectivity between the combined RCD/MCB devices PFL6../1N/ and the upstream fuses up to the specified values of the selectivity limit current I_s [kA] (i. e. in case of short-circuit currents I_{ks} under I_s, only the MCB will trip, in case of short circuit currents above this value both protective devices will respond).

*) basically in accordance with EN 60898 D.5.2.b

Short circuit selectivity **characteristic B** towards fuse link **DIAZED*** [kA]

PFL6	DIAZED DII-DIV gL/gG								
I _n [A]	10	16	20	25	35	50	63	80	100
6		<0.5 ¹⁾	0.7	1.0	2.9	6.0 ²⁾	6.0 ²⁾	6.0 ²⁾	6.0 ²⁾
10			0.6	0.9	1.9	3.3	6.0 ²⁾	6.0 ²⁾	6.0 ²⁾
13			0.5	0.7	1.6	2.8	5.7	6.0 ²⁾	6.0 ²⁾
16				0.7	1.4	2.4	4.4	6.0 ²⁾	6.0 ²⁾
20					1.3	2.2	4.0	6.0 ²⁾	6.0 ²⁾
25					1.3	2.1	3.8	5.8	6.0 ²⁾

Short circuit selectivity **characteristic C** towards fuse link **DIAZED*** [kA]

PFL6	DIAZED DII-DIV gL/gG								
I _n [A]	10	16	20	25	35	50	63	80	100
6		<0.5 ¹⁾	0.6	1.0	2.9	5.8	6.0 ²⁾	6.0 ²⁾	6.0 ²⁾
10			<0.5	0.7	1.5	2.6	5.3	6.0 ²⁾	6.0 ²⁾
13					1.4	2.3	4.6	6.0 ²⁾	6.0 ²⁾
16					1.2	1.8	3.4	5.5	6.0 ²⁾
20					1.2	1.7	3.1	5.0	6.0 ²⁾
25						1.6	2.9	4.6	6.0 ²⁾

¹⁾ Selectivity limit current I_s under 0.5 kA

²⁾ Selectivity limit current I_s = rated breaking capacity I_{cn} of the RCD/MCB device

Darker areas: no selectivity

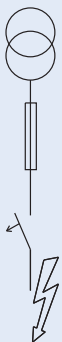

For types and art. numbers see page 28

Short Circuit Selectivity PFL6../1N/ towards NEOZED

In case of short circuit, there is selectivity between the combined RCD/MCB devices PFL6../1N/ and the upstream fuses up to the specified values of the selectivity limit current I_s [kA] (i. e. in case of short-circuit currents I_{ks} under I_s , only the MCB will trip, in case of short circuit currents above this value both protective devices will respond).

*) basically in accordance with EN 60898 D.5.2.b

Short circuit selectivity **characteristic B** towards fuse link **NEOZED*** [kA]

PFL6	NEOZED D01-D03 gL/gG								
I_n [A]	10	16	20	25	35	50	63	80	100
6		<0.5 ¹⁾	0.5	0.8	2.4	6.0 ²⁾	6.0 ²⁾	6.0 ²⁾	6.0 ²⁾
10			0.5	0.8	1.6	3.7	6.0 ²⁾	6.0 ²⁾	6.0 ²⁾
13			0.6	0.7	1.4	3.0	4.7	6.0 ²⁾	6.0 ²⁾
16				0.6	1.2	2.6	3.9	6.0 ²⁾	6.0 ²⁾
20					1.2	2.5	3.6	6.0 ²⁾	6.0 ²⁾
25					1.2	2.3	3.3	5.7	6.0 ²⁾

Short circuit selectivity **characteristic C** towards fuse link **NEOZED*** [kA]

PFL6	NEOZED D01-D03 gL/gG								
I_n [A]	10	16	20	25	35	50	63	80	100
6		<0.5 ¹⁾	<0.5 ¹⁾	0.8	2.3	6.0 ²⁾	6.0 ²⁾	6.0 ²⁾	6.0 ²⁾
10			<0.5	0.6	1.3	2.9	4.5	6.0 ²⁾	6.0 ²⁾
13					1.2	2.5	3.9	6.0 ²⁾	6.0 ²⁾
16					1.0	2.1	3.0	5.5	6.0 ²⁾
20					1.0	2.0	2.7	5.0	6.0 ²⁾
25						1.9	2.6	4.5	6.0 ²⁾

Short Circuit Selectivity PFL6../1N/ towards NH-00

In case of short circuit, there is selectivity between the combined RCD/MCB devices PFL6../1N/ and the upstream fuses up to the specified values of the selectivity limit current I_s [kA] (i. e. in case of short-circuit currents I_{ks} under I_s , only the MCB will trip, in case of short circuit currents above this value both protective devices will respond).

*) basically in accordance with EN 60898 D.5.2.b

Short circuit selectivity **characteristic B** towards fuse link **NH-00*** [kA]

PFL6	NH-00 gL/gG											
I_n [A]	16	20	25	32	35	40	50	63	80	100	125	160
6	<0.5 ¹⁾	0.5	0.8	1.4	2.2	3.3	6.0 ²⁾	6.0 ²⁾	6.0 ²⁾	6.0 ²⁾	6.0 ²⁾	6.0 ²⁾
10		<0.5 ¹⁾	0.7	0.9	1.5	2.1	3.4	4.3	6.0 ²⁾	6.0 ²⁾	6.0 ²⁾	6.0 ²⁾
13			<0.5 ¹⁾	0.6	0.8	1.4	1.8	2.8	3.6	5.7	6.0 ²⁾	6.0 ²⁾
16				0.6	0.7	1.2	1.5	2.4	3.0	4.5	6.0 ²⁾	6.0 ²⁾
20					0.7	1.1	1.5	2.2	2.8	4.2	6.0 ²⁾	6.0 ²⁾
25					0.7	1.1	1.4	2.1	2.6	4.0	6.0 ²⁾	6.0 ²⁾

Short circuit selectivity **characteristic C** towards fuse link **NH-00*** [kA]

PFL6	NH-00 gL/gG											
I_n [A]	16	20	25	32	35	40	50	63	80	100	125	160
6	<0.5 ¹⁾	<0.5 ¹⁾	0.7	1.3	2.2	3.3	5.9	6.0 ²⁾	6.0 ²⁾	6.0 ²⁾	6.0 ²⁾	6.0 ²⁾
10			0.5	0.8	1.2	1.7	2.7	3.4	5.5	6.0 ²⁾	6.0 ²⁾	6.0 ²⁾
13					1.1	1.5	2.3	2.9	4.7	6.0 ²⁾	6.0 ²⁾	6.0 ²⁾
16					1.0	1.3	1.8	2.3	3.7	6.0 ²⁾	6.0 ²⁾	6.0 ²⁾
20					0.9	1.1	1.7	2.2	3.4	6.0 ²⁾	6.0 ²⁾	6.0 ²⁾
25						1.6	2.1	3.2	6.0 ²⁾	6.0 ²⁾	6.0 ²⁾	6.0 ²⁾

¹⁾ Selectivity limit current I_s under 0.5 kA

²⁾ Selectivity limit current I_s = rated breaking capacity I_{cn} of the RCD/MCB device

Darker areas: no selectivity



Let-through Energy I^2t PFL6

Let-through energy I^2t PFL6, characteristic B, 1+N-pole

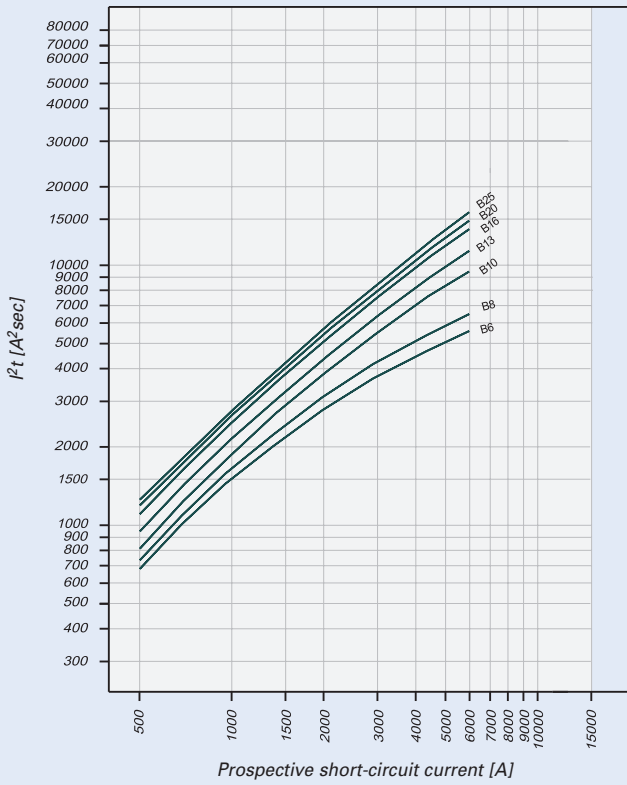

Let-through energy I^2t PFL6, characteristic C, 1+N-pole

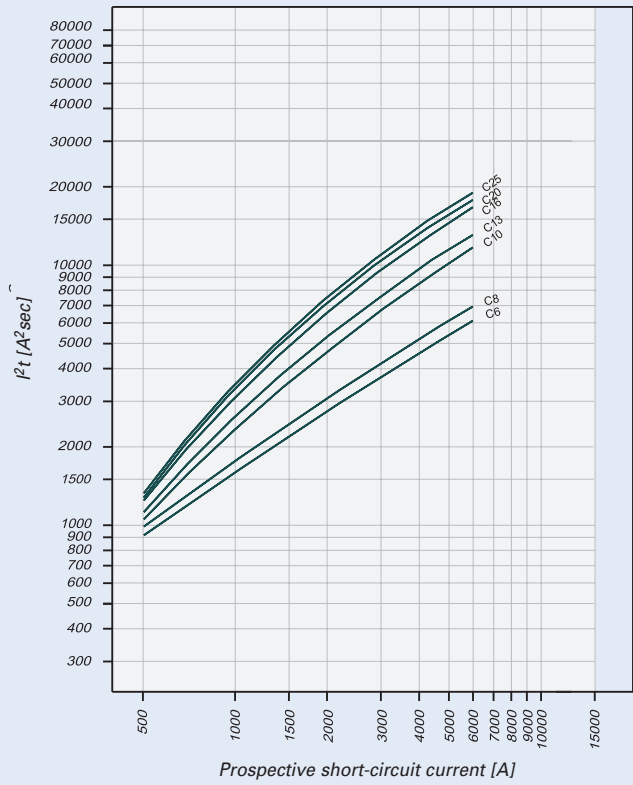

Combined RCD/MCB Devices mRB6, 3+N-pole

- Combined RCD/MCB device
- Line voltage-independent tripping
- Compatible with standard busbar
- Twin-purpose terminal (lift/open-mouthed) above and below
- Busbar positioning optionally above or below
- Free terminal space despite installed busbar
- Guide for secure terminal connection
- Switching toggle (MCB component) in colour designating the rated current
- Contact position indicator red - green
- Fault current tripping indicator white - blue
- Type -A: Protects against special forms of residual pulsating DC which have not been smoothed
- Tripping characteristic of circuit breaker B, C, D
- Breaking capacity 6 kA
- Rated current to 16 A

Accessories:

Auxiliary switch for subsequent installation	ZP-IHK	286052
	ZP-NHK	248437
	ZP-WHK	286053
Shunt trip release	ZP-ASA/..	248438, 248439
Switching interlock	IS/SPE-1TE	101911

Connection diagram

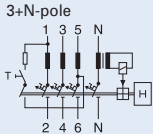

Technical Data

Electrical:

Design according to	EN 61009
Tripping	line voltage-independent instantaneous 250 A (8/20 μ s) surge current-proof
Operating voltage range	196 – 253 V
Rated voltage U_e	230/400 V; 50 Hz
Rated tripping current $I_{\Delta n}$	30, 100, 300 mA
Rated non-tripping current $I_{\Delta no}$	0.5 $I_{\Delta n}$
Sensitivity	AC and pulsating DC
Selectivity class	3
Rated breaking capacity	6 kA
Rated current	6 – 16 A
Rated peak withstand voltage U_{imp}	4 kV (1,2/50 μ s)
Characteristic	B, C, D
Maximum back-up fuse (short circuit)	100 A gL
Endurance electrical comp.	$\geq 4,000$ operating cycles
mechanical comp.	$\geq 20,000$ operating cycles

Mechanical:

Frame size	45 mm
Device height	80 mm
Device width	70 mm (4 MU)
Mounting	onto device rail acc. to EN 60715
Upper and lower terminals	open mouthed/lift terminals
Terminal capacity	1 – 25 mm ²
Busbar thickness	0.8 – 2 mm
Degree of protection switch	IP20 (built-in IP40)
Tripping temperature	-25 °C to +40 °C
Resistance to climatic conditions	acc. to IEC 68-2 (25 – 55 °C / 90 – 95 % RH)

Dimensions [mm]

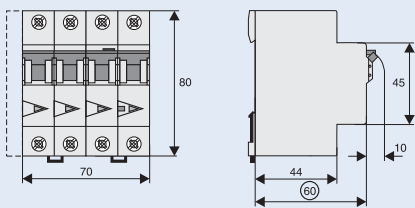

Tripping Characteristic mRB6, Characteristics B, C and D

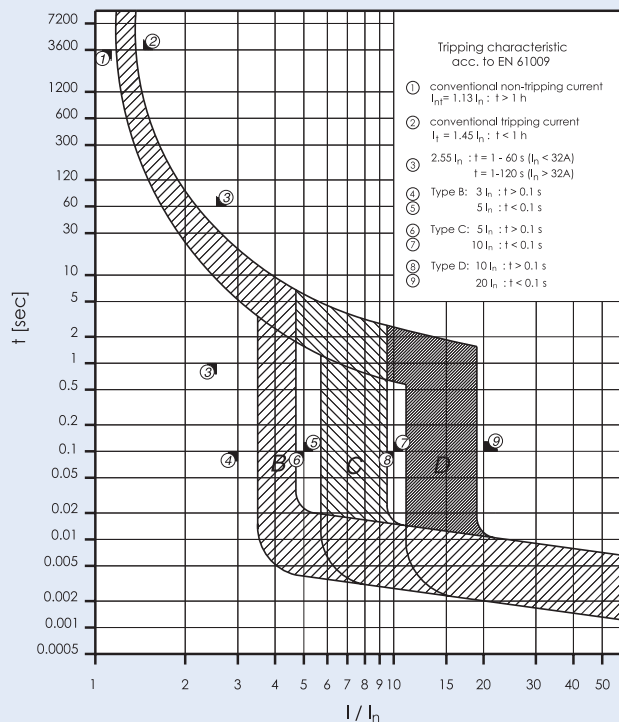

For types and art. numbers see page 30

Circuit Breakers PL7...

- High selectivity between MCB and back-up fuse due to low let-through energy
- Twin-purpose terminal (lift/open-mouthed) above and below
- Busbar positioning optionally above or below
- Meets the requirements of insulation co-ordination, distance between contacts 4 mm, for secure isolation
- Suitable for applications up to 48 V DC (use PL7-DC for higher DC voltages)
- PL7-DC: Rated breaking capacity 10 kA according to EN 60947-2
Rated voltage 250 V (per pole), t = 4 ms
Take into account polarity!

Accessories:

Auxiliary switch for subsequent installation	ZP-IHK	286052
	ZP-WHK	286053
Tripping signal contact for subsequent installation	ZP-NHK	248437
Remote control	Z-FW-LP	248296
Shunt trip release	ZP-ASA/..	248438, 248439
Undervoltage release	Z-USA/..	248289, 248291
Compact enclosure	KLV-TC-2	276240
	KLV-TC-4	276241
Additional terminal 35 mm ² (2 units)	Z-HA-EK/35	263960
Switching interlock without lock	Z-IS/SPE-1TE	274418

Connection diagrams

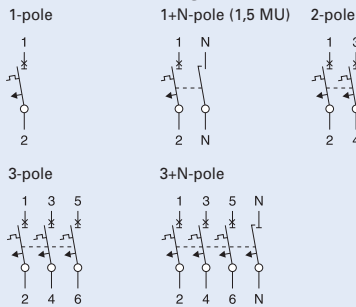

Technical Data

Electrical:

Design according to	EN 60898 (PL7) EN 60947-2 (PL7-DC)
Rated voltage	
PL7	AC: 230/400 V
PL7	DC: 48 V (per pole)
PL7-DC	DC: 250 V (per pole)
Rated frequency	50/60 Hz
Rated breaking capacity	
PL7 (EN 60898)	10 kA
PL7-DC (EN 60947-2)	10 kA
Characteristic	B, C, D
Back-up fuse	max. 125 A gL
Selectivity class	3
Rated peak withstand voltage U_{imp}	4 kV (1.2/50 μ s)
Endurance	electrical comp. \geq 4,000 operating cycles mechanical comp. \geq 20,000 operating cycles
Line voltage connection	optional (above/below)

Mechanical:

Frame size	45 mm
Device height	80 mm
Device width	17.5 mm per pole (1 MU) 26.3 mm: device 1P+N (1,5 MU)
Mounting	quick fastening with 3 lock-in positions on DIN rail EN 60715
Degree of protection	IP20
Upper and lower terminals	open mouthed/lift terminals
Terminal protection	finger and hand touch safe
Terminal capacity (1p, 2p, 3p,3+N)	1–25 mm ²
(1p+N, 1,5 TE)	1–25 mm ² / 1–2x10 mm ² (N)
Terminal fastening torque (1p+N, 1,5 TE)	2–2.4 Nm
(1p+N, 1,5 TE)	2–2.4 Nm / 1.2–1.5 Nm (N)
Busbar thickness	0.8–2 mm
Mounting	independent of position

Dimensions [mm]

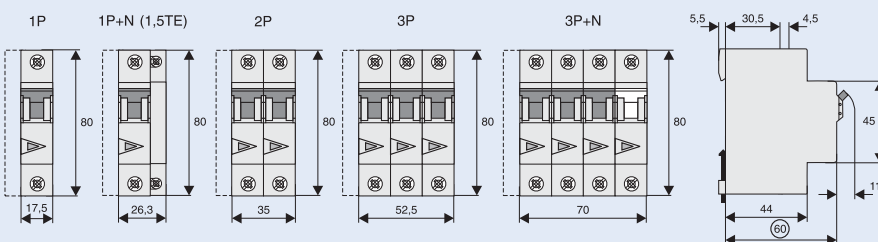

For types and art. numbers see page 32

Tripping Characteristics (EN 60898)

Tripping characteristic B (short circ. release 3–5 I_n) Tripping characteristic C (short circ. release 5–10 I_n) Tripping characteristic D (short circ. release 10–20 I_n)

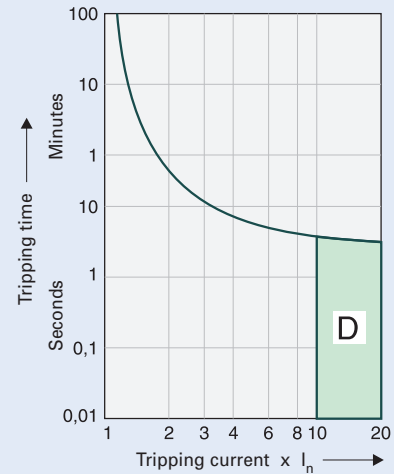
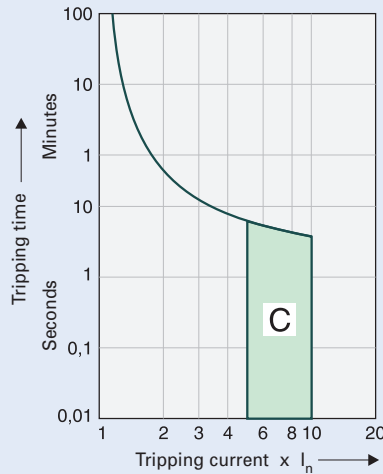
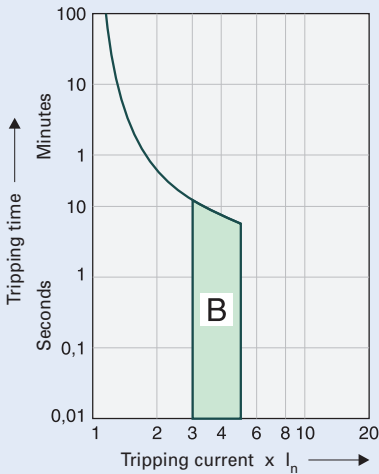

For electric lines (B), for circuits with motors (C) and for circuit with high surge currents, e.g. transformers (D).

Effect of the Ambient Temperature on Thermal Tripping Behaviour

Reference temperature according to EN 60898 is 30 °C.
Revised values of rated current as a dependence on ambient temperature.

I_n [A]	Ambient temperature T [°C]															
	-25	-20	-10	0	10	20	30	35	40	45	50	55	60	65	70	75
0.16	0.20	0.19	0.19	0.18	0.17	0.17	0.16	0.16	0.15	0.15	0.15	0.14	0.14	0.14	0.14	0.13
0.25	0.31	0.30	0.29	0.28	0.27	0.26	0.25	0.25	0.24	0.24	0.23	0.23	0.22	0.22	0.21	0.21
0.5	0.61	0.60	0.58	0.56	0.54	0.52	0.50	0.49	0.48	0.47	0.46	0.45	0.44	0.43	0.42	0.41
0.75	0.92	0.90	0.87	0.84	0.81	0.78	0.75	0.74	0.73	0.71	0.69	0.68	0.66	0.65	0.64	0.62
1	1.2	1.2	1.2	1.1	1.1	1.0	1.0	0.99	0.97	0.95	0.93	0.90	0.89	0.87	0.85	0.83
1.6	2.0	1.9	1.9	1.8	1.7	1.7	1.6	1.6	1.5	1.5	1.5	1.4	1.4	1.4	1.4	1.3
2	2.4	2.4	2.3	2.2	2.2	2.1	2.0	2.0	1.9	1.9	1.9	1.8	1.8	1.7	1.7	1.7
4	4.9	4.8	4.7	4.5	4.3	4.2	4.0	3.9	3.9	3.8	3.7	3.6	3.5	3.5	3.4	3.4
6	7.3	7.2	7.0	6.7	6.5	6.3	6.0	5.9	5.8	5.7	5.6	5.4	5.3	5.2	5.1	5.0
10	12	12	12	11	11	10	10	9.9	9.7	9.5	9.3	9.0	8.9	8.7	8.5	8.3
13	16	16	15	15	14	14	13	13	13	12	12	12	12	11	11	11
16	20	19	19	18	17	17	16	16	15	15	15	14	14	14	14	13
20	24	24	23	22	22	21	20	20	19	19	19	18	18	17	17	17
25	31	30	29	28	27	26	25	25	24	24	23	23	22	22	21	21
32	39	38	37	36	35	33	32	32	31	30	30	29	28	28	27	26
40	49	48	47	45	43	42	40	39	39	38	37	36	35	35	34	33
50	61	60	58	56	54	52	50	49	48	47	46	45	44	43	42	41
63	77	76	73	71	68	66	63	62	61	60	58	57	56	55	53	52

Load Capacity of Series Connected Miniature Circuit Breakers

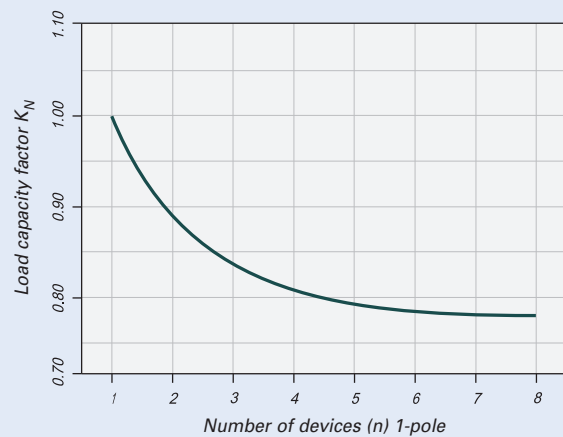

Effect of Power Frequency

Effect of power frequency on the tripping behaviour I_{MA} of the quick release

$I_{MA}(f)/I_{MA}(50\text{Hz})$ [%]	Power frequency f [Hz]						
	$16^{2/3}$	50	60	100	200	300	400
	91	100	101	106	115	134	141

There is no significant impact of change of temperature on tripping current of thermal release.

Let-through Energy I^2t PL7

Let-through energy I^2t , characteristic B, 1-pole

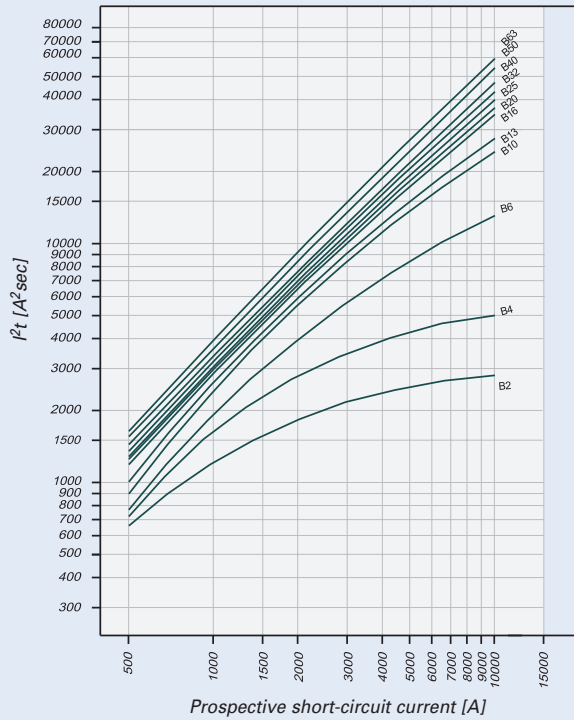

Let-through energy I^2t , characteristic C, 1-pole

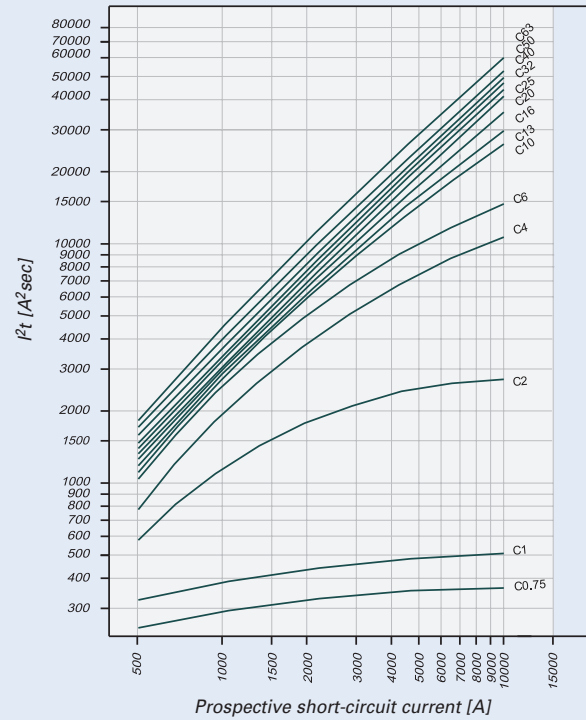

Let-through energy I^2t , characteristic D, 1-pole

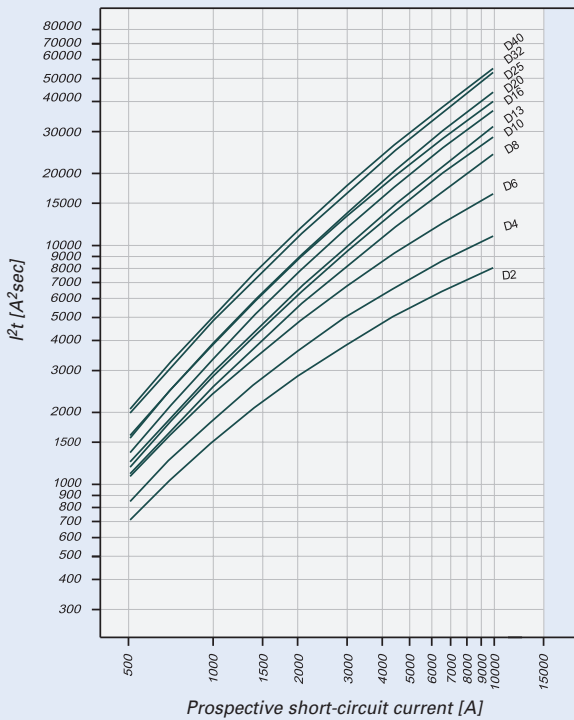

Short Circuit Selectivity PL7 towards DIAZED Fuses

In case of short circuit, there is selectivity between the miniature circuit breakers PL7 and the upstream fuses up to the specified values of the selectivity limit current I_s [kA] (i. e. in case of short-circuit currents I_{ks} under I_s , only the MCB will trip, in case of short circuit currents above this value both protective devices will respond).

*) basically in accordance with EN 60898 D.5.2.b

Short circuit selectivity **characteristic B** towards fuse link **DIAZED*** [kA]

PL7	DIAZED DII-DIV gL/gG										
I_n [A]	10	16	20	25	35	50	63	80	100		
2	<0.5 ¹⁾	<0.5 ¹⁾	0.8	1.6	10.0 ²⁾	10.0 ²⁾	10.0 ²⁾	10.0 ²⁾	10.0 ²⁾	10.0 ²⁾	
4	<0.5 ¹⁾	<0.5 ¹⁾	0.6	1.0	3.6	10.0 ²⁾	10.0 ²⁾	10.0 ²⁾	10.0 ²⁾	10.0 ²⁾	
6		<0.5 ¹⁾	0.6	0.9	1.8	3.2	7.4	10.0 ²⁾	10.0 ²⁾		
10			0.5	0.8	1.4	2.2	3.9	6.0	10.0 ²⁾		
13			0.5	0.7	1.3	2.0	3.6	5.4	10.0 ²⁾		
16				0.6	1.2	1.9	3.2	4.6	8.4		
20					1.2	1.8	3.1	4.4	7.8		
25						1.2	1.8	3.0	4.2	7.3	
32							1.7	2.8	3.9	6.8	
40								2.7	3.8	6.5	
50									2.5	3.5	5.7
63											5.3

Short circuit selectivity **characteristic C** towards fuse link **DIAZED*** [kA]

PL7	DIAZED DII-DIV gL/gG									
I_n [A]	10	16	20	25	35	50	63	80	100	
0.75	1.0	10.0 ²⁾	10.0 ²⁾	10.0 ²⁾	10.0 ²⁾	10.0 ²⁾	10.0 ²⁾	10.0 ²⁾	10.0 ²⁾	10.0 ²⁾
1.0	<0.5 ¹⁾	1.2	10.0 ²⁾	10.0 ²⁾	10.0 ²⁾	10.0 ²⁾	10.0 ²⁾	10.0 ²⁾	10.0 ²⁾	10.0 ²⁾
1.6	<0.5 ¹⁾	<0.5 ¹⁾	1.0	2.2	10.0 ²⁾	10.0 ²⁾	10.0 ²⁾	10.0 ²⁾	10.0 ²⁾	10.0 ²⁾
2	<0.5 ¹⁾	<0.5 ¹⁾	0.8	1.6	10.0 ²⁾	10.0 ²⁾	10.0 ²⁾	10.0 ²⁾	10.0 ²⁾	10.0 ²⁾
4	<0.5 ¹⁾	<0.5 ¹⁾	0.6	0.8	1.8	3.6	9.7	10.0 ²⁾	10.0 ²⁾	
6		<0.5 ¹⁾	0.5	0.6	1.4	2.4	5.5	10.0 ²⁾	10.0 ²⁾	
10			<0.5 ¹⁾	0.6	1.3	2.0	3.6	5.4	10.0 ²⁾	
13										9.4
16										8.0
20										7.0
25										6.5
32										6.2
40										5.9
50										5.5
63										

Short circuit selectivity **characteristic D** towards fuse link **DIAZED*** [kA]

PL7	DIAZED DII-DIV gL/gG									
I_n [A]	10	16	20	25	35	50	63	80	100	
2.0	<0.5 ¹⁾	<0.5 ¹⁾	0.6	1.0	2.8	5.8	10.0 ²⁾	10.0 ²⁾	10.0 ²⁾	
4		<0.5 ¹⁾	0.6	0.9	2.0	3.8	9.5	10.0 ²⁾	10.0 ²⁾	
6			0.5	0.7	1.5	2.6	5.3	9.1	10.0 ²⁾	
10				0.7	1.2	1.9	3.4	5.0	9.5	
13					1.2	1.8	3.2	4.6	8.6	
16						1.6	2.7	4.0	7.4	
20							1.5	2.5	3.5	6.7
25								2.4	3.4	6.2
32									2.8	5.0
40										4.8



¹⁾ Selectivity limit current I_s under 0.5 kA.

²⁾ Selectivity limit current I_s = rated breaking capacity I_{cn} of the MCB

no selectivity

*) DIAZED fuse-links: DII (E27)
DIII (E33)
DIV (G1^{1/4})

Short Circuit Selectivity PL7 towards NEOZED Fuses

In case of short circuit, there is selectivity between the miniature circuit breakers PL7 and the upstream fuses up to the specified values of the selectivity limit current I_s [kA] (i. e. in case of short-circuit currents I_{ks} under I_s , only the MCB will trip, in case of short circuit currents above this value both protective devices will respond).

*) basically in accordance with EN 60898 D.5.2.b

Short circuit selectivity **characteristic B** towards fuse link **NEOZED*** [kA]

PL7	NEOZED D01-D03 gL/gG									
I_n [A]	10	16	20	25	35	50	63	80	100	
2	<0.5 ¹⁾	<0.5 ¹⁾	0.6	1.0	10.0 ²⁾	10.0 ²⁾	10.0 ²⁾	10.0 ²⁾	10.0 ²⁾	
4	<0.5 ¹⁾	<0.5 ¹⁾	0.5	0.9	2.5	10.0 ²⁾	10.0 ²⁾	10.0 ²⁾	10.0 ²⁾	
6		<0.5 ¹⁾	0.5	0.8	1.6	3.6	6.0	10.0 ²⁾	10.0 ²⁾	
10			0.5	0.7	1.3	2.4	3.4	6.0	10.0 ²⁾	
13			<0.5 ¹⁾	0.7	1.2	2.3	3.2	5.3	10.0 ²⁾	
16				0.6	1.1	2.2	2.9	4.6	10.0	
20					1.1	2.1	2.8	4.4	9.3	
25					1.1	2.0	2.7	4.2	8.7	
32						2.0	2.6	4.0	8.0	
40							2.5	3.8	7.5	
50							2.3	3.4	6.7	
63									6.2	

Short circuit selectivity **characteristic C** towards fuse link **NEOZED*** [kA]

PL7	NEOZED D01-D03 gL/gG									
I_n [A]	10	16	20	25	35	50	63	80	100	
0,75	<0.5 ¹⁾	10.0 ²⁾	10.0 ²⁾	10.0 ²⁾	10.0 ²⁾	10.0 ²⁾	10.0 ²⁾	10.0 ²⁾	10.0 ²⁾	10.0 ²⁾
1,0	<0.5 ¹⁾	10.0 ²⁾	10.0 ²⁾	10.0 ²⁾	10.0 ²⁾	10.0 ²⁾	10.0 ²⁾	10.0 ²⁾	10.0 ²⁾	10.0 ²⁾
1,6	<0.5 ¹⁾	0.5	0.6	0.9	10.0 ²⁾	10.0 ²⁾	10.0 ²⁾	10.0 ²⁾	10.0 ²⁾	10.0 ²⁾
2	<0.5 ¹⁾	<0.5 ¹⁾	0.5	0.7	10.0 ²⁾	10.0 ²⁾	10.0 ²⁾	10.0 ²⁾	10.0 ²⁾	10.0 ²⁾
4	<0.5 ¹⁾	<0.5 ¹⁾	<0.5 ¹⁾	0.6	1.6	4.0	7.6	10.0 ²⁾	10.0 ²⁾	
6		<0.5 ¹⁾	<0.5 ¹⁾	<0.5 ¹⁾	1.2	2.7	4.5	10.0 ²⁾	10.0 ²⁾	
10			<0.5 ¹⁾	<0.5 ¹⁾	1.2	2.3	3.1	5.4	10.0 ²⁾	
13					1.1	2.2	3.0	4.9	10.0 ²⁾	
16						1.1	2.1	2.8	4,4	9.5
20						1.0	2.0	2.6	4.0	8.3
25							1.9	2.5	3.8	7.8
32								2.5	3.7	7.3
40									3.5	7.0
50										6.5
63										

Short circuit selectivity **characteristic D** towards fuse link **NEOZED*** [kA]

PL7	NEOZED D01-D03 gL/gG									
I_n [A]	10	16	20	25	35	50	63	80	100	
4		<0.5 ¹⁾	0.5	0.7	1.7	4.6	7.7	10.0 ²⁾	10.0 ²⁾	
6			<0.5 ¹⁾	0.5	1.3	2.9	4.5	9.0	10.0 ²⁾	
10				0.5	1.1	2.2	3.0	5.0	10.0 ²⁾	
13					1.1	2.1	2.9	4.6	10.0 ²⁾	
16						1.9	2.6	3.9	9.0	
20						1.7	2.3	3.5	8.0	
25							2.2	3.4	7.5	
32								2.9	6.0	
40									5.7	



1) Selectivity limit current I_s under 0.5 kA.

2) Selectivity limit current I_s = rated breaking capacity I_{cn} of the MCB

no selectivity

*) NEOZED fuse-links: D01 (E14)
D02 (E18)
D03 (M30x2)

Short Circuit Selectivity PL7 towards NH-00 Fuses

In case of short circuit, there is selectivity between the miniature circuit breakers PL7 and the upstream fuses up to the specified values of the selectivity limit current I_s [kA] (i. e. in case of short-circuit currents I_{ks} under I_s , only the MCB will trip, in case of short circuit currents above this value both protective devices will respond).

*) basically in accordance with EN 60898 D.5.2.b

Short circuit selectivity **characteristic B** towards fuse link **NH-00*** [kA]

PL7	NH-00 gL/gG											
I_n [A]	16	20	25	32	35	40	50	63	80	100	125	160
2	<0.5 ¹⁾	0.5	1.0	2.5	10.0 ²⁾	10.0 ²⁾	10.0 ²⁾	10.0 ²⁾	10.0 ²⁾	10.0 ²⁾	10.0 ²⁾	10.0 ²⁾
4	<0.5 ¹⁾	<0.5 ¹⁾	0.8	1.3	2.3	4.3	10.0 ²⁾	10.0 ²⁾	10.0 ²⁾	10.0 ²⁾	10.0 ²⁾	10.0 ²⁾
6	<0.5 ¹⁾	<0.5 ¹⁾	0.7	1.1	1.5	2.0	3.3	4.3	7.6	10.0 ²⁾	10.0 ²⁾	10.0 ²⁾
10		<0.5 ¹⁾	0.6	0.9	1.2	1.5	2.2	2.7	4.0	9.0	10.0 ²⁾	10.0 ²⁾
13		<0.5 ¹⁾	0.6	0.8	1.1	1.4	2.1	2.6	3.8	7.9	10.0 ²⁾	10.0 ²⁾
16			0.5	0.7	1.0	1.3	1.9	2.4	3.4	6.4	9.3	10.0 ²⁾
20				0.7	1.0	1.3	1.9	2.4	3.3	6.0	8.7	10.0 ²⁾
25				0.7	1.0	1.3	1.8	2.3	3.2	5.7	8.0	10.0 ²⁾
32					0.9	1.2	1.7	2.2	3.1	5.4	7.6	10.0 ²⁾
40								2.1	3.0	5.1	7.2	10.0 ²⁾
50								1.9	2.8	4.7	6.6	9.5
63										4.4	6.3	8.6

Short circuit selectivity **characteristic C** towards fuse link **NH-00*** [kA]

PL7	NH-00 gL/gG											
I_n [A]	16	20	25	32	35	40	50	63	80	100	125	160
0,75	10.0 ²⁾	10.0 ²⁾	10.0 ²⁾	10.0 ²⁾	10.0 ²⁾	10.0 ²⁾	10.0 ²⁾	10.0 ²⁾	10.0 ²⁾	10.0 ²⁾	10.0 ²⁾	10.0 ²⁾
1,0	0.9	10.0 ²⁾	10.0 ²⁾	10.0 ²⁾	10.0 ²⁾	10.0 ²⁾	10.0 ²⁾	10.0 ²⁾	10.0 ²⁾	10.0 ²⁾	10.0 ²⁾	10.0 ²⁾
1,6	<0.5 ¹⁾	0.6	1.3	4.2	10.0 ²⁾	10.0 ²⁾	10.0 ²⁾	10.0 ²⁾	10.0 ²⁾	10.0 ²⁾	10.0 ²⁾	10.0 ²⁾
2	<0.5 ¹⁾	0.6	1.0	2.5	10.0 ²⁾	10.0 ²⁾	10.0 ²⁾	10.0 ²⁾	10.0 ²⁾	10.0 ²⁾	10.0 ²⁾	10.0 ²⁾
4	<0.5 ¹⁾	<0.5 ¹⁾	0.7	1.0	1.5	2.1	3.6	5.0	10.0	10.0 ²⁾	10.0 ²⁾	10.0 ²⁾
6	<0.5 ¹⁾	<0.5 ¹⁾	0.5	0.8	1.2	1.5	2.5	3.3	5.7	10.0 ²⁾	10.0 ²⁾	10.0 ²⁾
10			0.5	0.7	1.0	1.4	2.0	2.5	3.8	8.0	10.0 ²⁾	10.0 ²⁾
13					1.0	1.3	1.9	2.4	3.6	7.0	10.0 ²⁾	10.0 ²⁾
16						1.0	1.3	1.8	2.3	3.3	6.0	8.8
20							1.0	1.2	1.7	2.2	3.2	5.5
25								1.6	2.1	3.0	5.2	7.3
32									2.1	2.9	5.0	7.0
40										2.8	4.8	6.7
50											4.5	6.3
63												5.9

Short circuit selectivity **characteristic D** towards fuse link **NH-00*** [kA]

PL7	NH-00 gL/gG											
I_n [A]	16	20	25	32	35	40	50	63	80	100	125	160
4	<0.5 ¹⁾	<0.5 ¹⁾	0.7	1.0	1.6	2.2	3.8	5.2	10.0	10.0 ²⁾	10.0 ²⁾	10.0 ²⁾
5		<0.5 ¹⁾	0.6	0.9	1.4	1.9	3.2	4.1	7.1	10.0 ²⁾	10.0 ²⁾	10.0 ²⁾
6		<0.5 ¹⁾	0.5	0.8	1.2	1.6	2.6	3.3	5.5	10.0 ²⁾	10.0 ²⁾	10.0 ²⁾
8			0.5	0.8	1.1	1.5	2.2	2.7	4.1	8.7	10.0 ²⁾	10.0 ²⁾
10			0.5	0.7	1.0	1.3	1.9	2.5	3.6	7.2	10.0 ²⁾	10.0 ²⁾
13					1.0	1.3	1.9	2.3	3.4	6.5	9.5	10.0 ²⁾
16						1.1	1.6	2.0	3.0	5.5	8.0	10.0 ²⁾
20							1.4	1.8	2.8	5.0	7.5	10.0 ²⁾
25								1.8	2.7	4.8	7.0	10.0 ²⁾
32									2.4	4.1	6.2	9.3
40										4.0	6.0	9.0

¹⁾ Selectivity limit current I_s under 0.5 kA

²⁾ Selectivity limit current I_s = rated breaking capacity I_{cn} of the MCB

no selectivity



Cascading of PL7 and NZM circuit breakers

- Cascading ensures proper function of downstream circuit breaker in circuits where prospective short circuit current exceeds breaking capacity of this breaker
- Effective system-based solution
- Cost and space saving
- Conditional breaking capacity acc. to EN 60947-2
- Values for 400 V AC

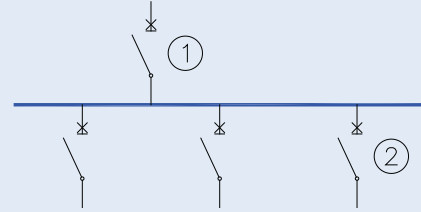

Downstream breaker PL7 characteristics B and C ②	Upstream breaker ①						
	I_n [A]	≤ 160			≤ 250		
	Type	NZMB1-A	NZMN1-A	NZMH1-A	NZMB2-A	NZMN2-A	NZMH2-A
	I_{cu} [kA] 415 V AC	25	50	100	25	50	150
$I_n = 0,16 - 10$ A	Conditional breaking capacity of PL7 [kA]	25	25	25	25	50	50
$I_n = 13 - 16$ A	Conditional breaking capacity of PL7 [kA]	25	25	25	20	30	30
$I_n = 20 - 32$ A	Conditional breaking capacity of PL7 [kA]	20	20	20	20	30	30
$I_n = 40$ A	Conditional breaking capacity of PL7 [kA]	20	20	20	15	20	20
$I_n = 50 - 63$ A	Conditional breaking capacity of PL7 [kA]	15	15	15	15	20	20

Miniature Circuit Breakers PL7-DC for AC/DC, Characteristic C

Connection example at 250 V=, 1-pole

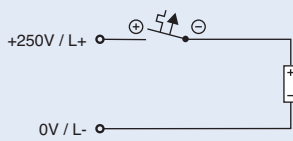

Connection example at 500 V=, 2-pole

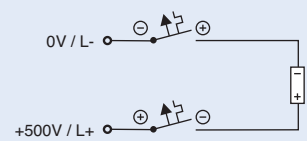
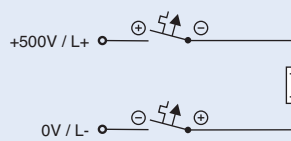
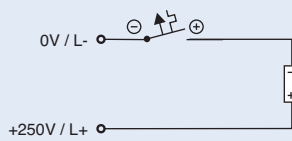

Connection diagrams PL7-DC

1-pole



2-pole

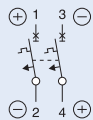

Note:

For proper function of MCBs PL7-DC it is necessary to connect terminals correctly with respect to polarity sign placed near terminals. A way of grounding of DC circuit (i.e. grounding of positive or negative pole) or its connection to another circuit has no effect of MCB functionality.

Circuit Breaker PL6...

- High selectivity between MCB and back-up fuse due to low let-through energy
 - Twin-purpose terminal (lift/open-mouthed) above and below
 - Busbar positioning optionally above or below
 - Meets the requirements of insulation co-ordination, distance between contacts 4 mm, for secure isolation
 - Distance between contacts more than 4 mm for safety electrical disconnection
- Suitable for applications up to 48 V DC

Accessories:

Auxiliary switch for subsequent installation	ZP-IHK	286052
	ZP-WHK	286053
Tripping signal contact for subsequent installation	ZP-NHK	248437
Remote control and automatic switching device	Z-FW-LP	248296
Shunt trip release	ZP-ASA/..	248438, 248439
Undervoltage release	Z-USA/..	248289-248291
Compact enclosure	KLV-TC-2	276240
	KLV-TC-4	276241
Additional terminal 35 mm ² (2 units)	Z-HA-EK/35	263960
Switching interlock without lock	Z-IS/SPE-1TE	274418

Connection diagrams

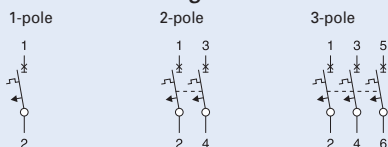

Technical Data

Electrical:

Design according to	EN 60898
Rated voltage	
PL6	AC: 230/400 V
PL6	DC: 48 V (per pole)
Rated frequency	50/60 Hz
Rated breaking capacity according to	EN 60898
PL6	6 kA
Characteristic	B, C, D
Back-up fuse	
> 6 kA	max. 100 A gL
Selectivity class	3
Rated peak withstand voltage U_{imp}	4 kV (1.2/50 μ s)
Endurance	
elektrická	$\geq 4,000$ operating cycles
mechanická	$\geq 20,000$ operating cycles
Line voltage connection	optional (above/below)
Min. voltage	12 V AC/DC

Mechanical:

Frame size	45 mm
Device height	80 mm
Device width	17.5 mm per pole (1 MU)
Mounting	quick fastening with 3 lock-in positions on DIN rail EN 60715
Degree of protection	IP20
Upper and lower terminals	open mouthed/lift terminals
Terminal protection	finger and hand touch safe
Terminal capacity (1p, 2p, 3p,)	1–25 mm ²
Terminal fastening torque	2–2.4 Nm
Busbar thickness	0.8–2 mm
Mounting	independent of position

Dimensions [mm]

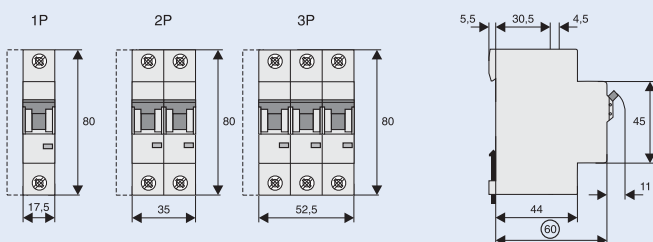

Tripping Characteristics (IEC/EN 60898)

Tripping characteristic B (short circ. release 3–5 I_n) Tripping characteristic C (short circ. release 5–10 I_n) Tripping characteristic D (short circ. release 10 - 20 I_n)

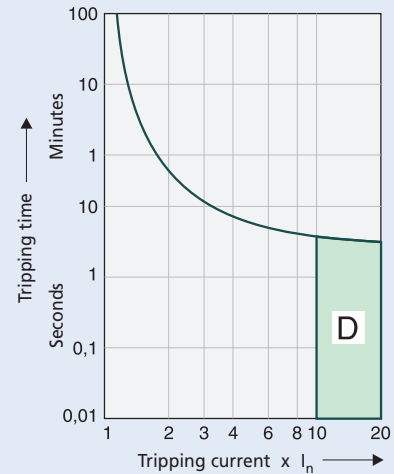
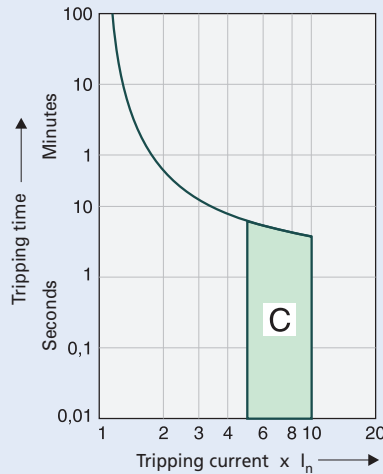
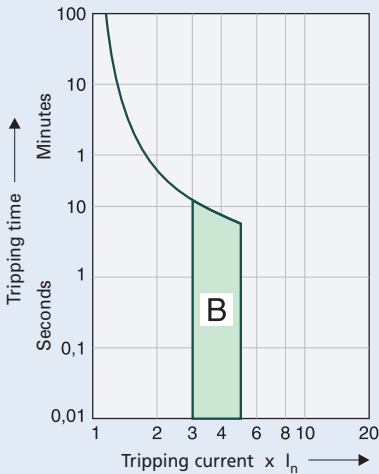

For electric lines (B), for circuits with motors (C) and for circuit with high surge currents, e.g. transformers (D).

Effect of the Ambient Temperature on Thermal Tripping Behaviour

Reference temperature according to EN 60898 is 30 °C.
Revised values of rated current as a dependence on ambient temperature.

I_n [A]	Ambient temperature T [°C]															
	-25	-20	-10	0	10	20	30	35	40	45	50	55	60	65	70	75
2	2,4	2,4	2,3	2,2	2,2	2,1	2,0	2,0	1,9	1,9	1,9	1,8	1,8	1,7	1,7	1,7
4	4,9	4,8	4,7	4,5	4,3	4,2	4,0	3,9	3,9	3,8	3,7	3,6	3,5	3,5	3,4	3,4
6	7,3	7,2	7,0	6,7	6,5	6,3	6,0	5,9	5,8	5,7	5,6	5,4	5,3	5,2	5,1	5,0
10	12	12	12	11	11	10	10	9,9	9,7	9,5	9,3	9,0	8,9	8,7	8,5	8,3
13	16	16	15	15	14	14	13	13	13	12	12	12	12	11	11	11
16	20	19	19	18	17	17	16	16	15	15	15	14	14	14	14	13
20	24	24	23	22	22	21	20	20	19	19	19	18	18	17	17	17
25	31	30	29	28	27	26	25	25	24	24	23	23	22	22	21	21
32	39	38	37	36	35	33	32	32	31	30	30	29	28	28	27	26
40	49	48	47	45	43	42	40	39	39	38	37	36	35	35	34	33
50	61	60	58	56	54	52	50	49	48	47	46	45	44	43	42	41
63	77	76	73	71	68	66	63	62	61	60	58	57	56	55	53	52

Load Capacity of Series Connected Miniature Circuit Breakers

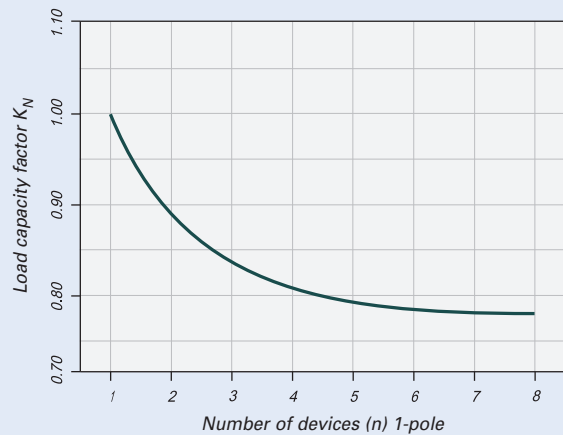

Effect of Power Frequency

Effect of power frequency on the tripping behaviour I_{MA} of the quick release

$I_{MA}(f)/I_{MA}(50\text{Hz})$ [%]	Power frequency f [Hz]						
	16 ² / ₃	50	60	100	200	300	400
	91	100	101	106	115	134	141

There is no significant impact of change of temperature on tripping current of thermal release.

Let-through Energy I^2t PL6

Let-through energy PL6, characteristic B, 1-pole

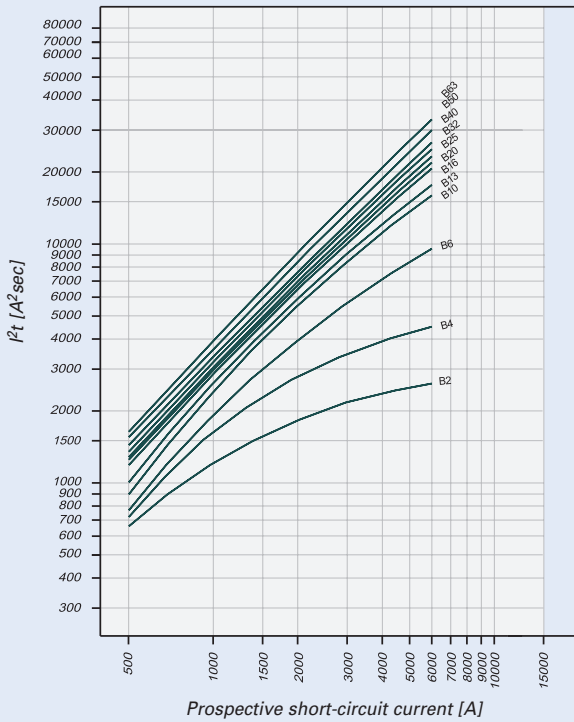

Let-through energy PL6, characteristic B, 1-pole

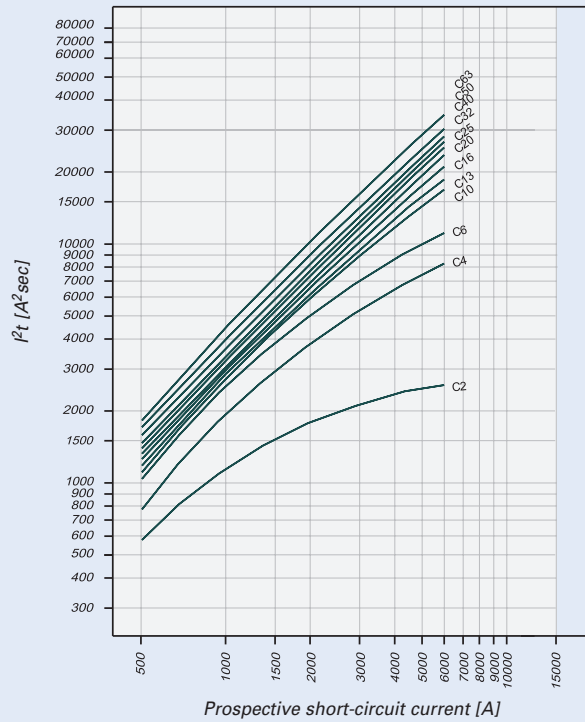

Let-through energy PL6, characteristic D, 1-pole

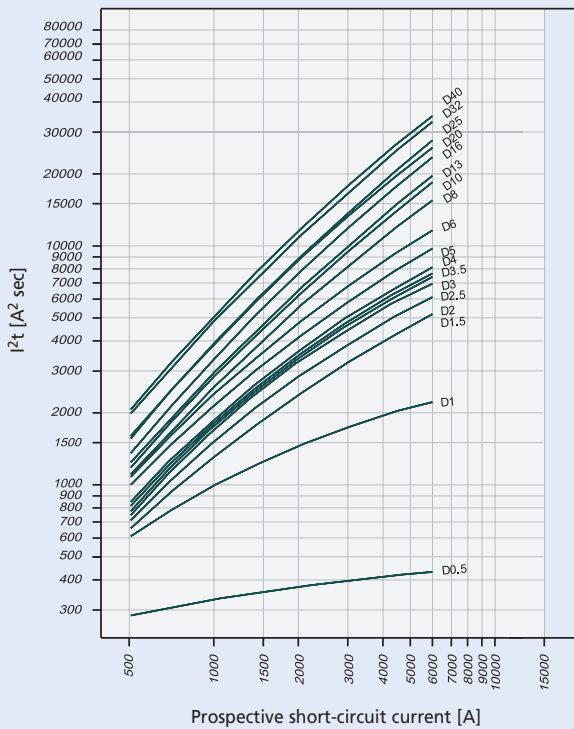

Short Circuit Selectivity PL6 towards DIAZED Fuses

In case of short circuit, there is selectivity between the miniature circuit breakers PL6 and the upstream fuses up to the specified values of the selectivity limit current I_s [kA] (i. e. in case of short-circuit currents I_{ks} under I_s , only the MCB will trip, in case of short circuit currents above this value both protective devices will respond).

*) basically in accordance with EN 60898 D.5.2.b

Short circuit selectivity **characteristic B** towards fuse link **DIAZED*** [kA]

PL6	DIAZED DII-DIV gL/gG								
I_n [A]	10	16	20	25	35	50	63	80	100
2	<0.5 ¹⁾	<0.5 ¹⁾	0.8	1.6	6.0 ²⁾	6.0 ²⁾	6.0 ²⁾	6.0 ²⁾	6.0 ²⁾
4	<0.5 ¹⁾	<0.5 ¹⁾	0.6	1.0	3.6	6.0 ²⁾	6.0 ²⁾	6.0 ²⁾	6.0 ²⁾
6		<0.5 ¹⁾	0.6	0.9	1.8	3.2	6.0 ²⁾	6.0 ²⁾	6.0 ²⁾
10			0.5	0.8	1.4	2.2	3.9	6.0 ²⁾	6.0 ²⁾
13			0.5	0.7	1.3	2.0	3.6	5.4	6.0 ²⁾
16				0.6	1.2	1.9	3.2	4.6	6.0 ²⁾
20					1.2	1.8	3.1	4.4	6.0 ²⁾
25						1.2	1.8	3.0	4.2
32							1.7	2.8	3.9
40								2.7	3.8
50								2.5	3.5
63									5.3

Short circuit selectivity **characteristic C** towards fuse link **DIAZED*** [kA]

PL6	DIAZED DII-DIV gL/gG								
I_n [A]	10	16	20	25	35	50	63	80	100
2	<0.5 ¹⁾	<0.5 ¹⁾	0.8	1.6	6.0 ²⁾	6.0 ²⁾	6.0 ²⁾	6.0 ²⁾	6.0 ²⁾
4	<0.5 ¹⁾	<0.5 ¹⁾	0.6	0.8	1.8	3.6	6.0 ²⁾	6.0 ²⁾	6.0 ²⁾
6		<0.5 ¹⁾	0.5	0.6	1.4	2.4	5.5	6.0 ²⁾	6.0 ²⁾
10			<0.5 ¹⁾	0.6	1.3	2.0	3.6	6.0 ²⁾	6.0 ²⁾
13					1.3	1.9	3.3	5.0	6.0 ²⁾
16						1.2	1.8	3.2	4.4
20							1.2	1.8	3.1
25								1.7	2.8
32									2.7
40									3.5
50									5.5

Short circuit selectivity **characteristic D** towards fuse link **DIAZED*** [kA]

PL6	DIAZED DII-DIV gL/gG								
I_n [A]	10	16	20	25	35	50	63	80	100
2	<0.5 ¹⁾	<0.5 ¹⁾	0.6	1.0	2.8	5.8	6.0 ²⁾	6.0 ²⁾	6.0 ²⁾
4		<0.5 ¹⁾	0.6	0.9	2.0	3.8	6.0 ²⁾	6.0 ²⁾	6.0 ²⁾
6			0.5	0.7	1.5	2.6	5.3	6.0 ²⁾	6.0 ²⁾
10				0.7	1.2	1.9	3.4	5.0	6.0 ²⁾
13					1.2	1.8	3.2	4.6	6.0 ²⁾
16						1.6	2.7	4.0	6.0 ²⁾
20							1.5	2.5	3.5
25								2.4	3.4
32									2.8
40									4.8



¹⁾ Selectivity limit current I_s under 0.5 kA

²⁾ Selectivity limit current I_s = rated breaking capacity I_{cn} of the MCB

no selectivity

*) DIAZED fuse-links: DII (E27)
DIII (E33)
DIV (G1^{1/4})

Short Circuit Selectivity PL6 towards NEOZED Fuses

In case of short circuit, there is selectivity between the miniature circuit breakers PL6 and the upstream fuses up to the specified values of the selectivity limit current I_s [kA] (i. e. in case of short-circuit currents I_{ks} under I_s , only the MCB will trip, in case of short circuit currents above this value both protective devices will respond).

*) basically in accordance with EN 60898 D.5.2.b

Short circuit selectivity **characteristic B** towards fuse link **NEOZED***) [kA]

PL6	NEOZED D01-D03 gL/gG									
I_n [A]	10	16	20	25	35	50	63	80	100	
2	<0.5 ¹⁾	<0.5 ¹⁾	0.6	1.0	6.0 ²⁾	6.0 ²⁾	6.0 ²⁾	6.0 ²⁾	6.0 ²⁾	6.0 ²⁾
4	<0.5 ¹⁾	<0.5 ¹⁾	0.5	0.9	2.5	6.0 ²⁾	6.0 ²⁾	6.0 ²⁾	6.0 ²⁾	6.0 ²⁾
6		<0.5 ¹⁾	0.5	0.8	1.6	3.6	6.0 ²⁾	6.0 ²⁾	6.0 ²⁾	6.0 ²⁾
10			0.5	0.7	1.3	2.4	3.4	6.0 ²⁾	6.0 ²⁾	6.0 ²⁾
13			<0.5 ¹⁾	0.7	1.2	2.3	3.2	5.3	6.0 ²⁾	6.0 ²⁾
16				0.6	1.1	2.2	2.9	4.6	6.0 ²⁾	6.0 ²⁾
20					1.1	2.1	2.8	4.4	6.0 ²⁾	6.0 ²⁾
25					1.1	2.0	2.7	4.2	6.0 ²⁾	6.0 ²⁾
32						2.0	2.6	4.0	6.0 ²⁾	6.0 ²⁾
40							2.5	3.8	6.0 ²⁾	6.0 ²⁾
50							2.3	3.4	6.0 ²⁾	6.0 ²⁾
63									6.0 ²⁾	6.0 ²⁾

Short circuit selectivity **characteristic C** towards fuse link **NEOZED***) [kA]

PL6	NEOZED D01-D03 gL/gG									
I_n [A]	10	16	20	25	35	50	63	80	100	
2	<0.5 ¹⁾	<0.5 ¹⁾	0.5	0.7	6.0 ²⁾	6.0 ²⁾	6.0 ²⁾	6.0 ²⁾	6.0 ²⁾	6.0 ²⁾
4	<0.5 ¹⁾	<0.5 ¹⁾	<0.5 ¹⁾	0.6	1.6	4.0	6.0 ²⁾	6.0 ²⁾	6.0 ²⁾	6.0 ²⁾
6		<0.5 ¹⁾	<0.5 ¹⁾	<0.5 ¹⁾	1.2	2.7	4.5	6.0 ²⁾	6.0 ²⁾	6.0 ²⁾
10			<0.5 ¹⁾	<0.5 ¹⁾	1.2	2.3	3.1	5.4	6.0 ²⁾	6.0 ²⁾
13					1.1	2.2	3.0	4.9	6.0 ²⁾	6.0 ²⁾
16					1.1	2.1	2.8	4.4	6.0 ²⁾	6.0 ²⁾
20					1.0	2.0	2.6	4.0	6.0 ²⁾	6.0 ²⁾
25						1.9	2.5	3.8	6.0 ²⁾	6.0 ²⁾
32							2.5	3.7	6.0 ²⁾	6.0 ²⁾
40								3.5	6.0 ²⁾	6.0 ²⁾
50									6.0 ²⁾	6.0 ²⁾

Short circuit selectivity **characteristic D** towards fuse link **NEOZED***) [kA]

PL6	NEOZED D01-D03 gL/gG									
I_n [A]	10	16	20	25	35	50	63	80	100	
2	<0.5 ¹⁾	<0.5 ¹⁾	0.6	0.8	2.2	6.0 ²⁾	6.0 ²⁾	6.0 ²⁾	6.0 ²⁾	6.0 ²⁾
4		<0.5 ¹⁾	0.5	0.7	1.7	4.6	6.0 ²⁾	6.0 ²⁾	6.0 ²⁾	6.0 ²⁾
6			<0.5 ¹⁾	0.5	1.3	2.9	4.5	6.0 ²⁾	6.0 ²⁾	6.0 ²⁾
10				0.5	1.1	2.2	3.0	5.0	6.0 ²⁾	6.0 ²⁾
13					1.1	2.1	2.9	4.6	6.0 ²⁾	6.0 ²⁾
16						1.9	2.6	3.9	6.0 ²⁾	6.0 ²⁾
20						1.7	2.3	3.5	6.0 ²⁾	6.0 ²⁾
25							2.2	3.4	6.0 ²⁾	6.0 ²⁾
32								2.9	6.0 ²⁾	6.0 ²⁾
40									5.7	6.0 ²⁾



¹⁾ Selectivity limit current I_s under 0.5 kA

²⁾ Selectivity limit current I_s = rated breaking capacity I_{cn} of the MCB

no selectivity

*) NEOZED fuse-links: D01 (E14)
D02 (E18)
D03 (M30x2)

Short Circuit Selectivity PL6 towards NH-00 Fuses

In case of short circuit, there is selectivity between the miniature circuit breakers PL6 and the upstream fuses up to the specified values of the selectivity limit current I_s [kA] (i. e. in case of short-circuit currents I_{ks} under I_s , only the MCB will trip, in case of short circuit currents above this value both protective devices will respond).

*) basically in accordance with EN 60898 D.5.2.b

Short circuit selectivity **characteristic B** towards fuse link **NH-00*** [kA]

PL6	NH-00 gL/gG											
I_n [A]	16	20	25	32	35	40	50	63	80	100	125	160
2	<0.5 ¹⁾	0.5	1.0	2.5	6.0 ²⁾	6.0 ²⁾	6.0 ²⁾	6.0 ²⁾	6.0 ²⁾	6.0 ²⁾	6.0 ²⁾	6.0 ²⁾
4	<0.5 ¹⁾	<0.5 ¹⁾	0.8	1.3	2.3	4.3	6.0 ²⁾	6.0 ²⁾	6.0 ²⁾	6.0 ²⁾	6.0 ²⁾	6.0 ²⁾
6	<0.5 ¹⁾	<0.5 ¹⁾	0.7	1.1	1.5	2.0	3.3	4.3	6.0 ²⁾	6.0 ²⁾	6.0 ²⁾	6.0 ²⁾
10		<0.5 ¹⁾	0.6	0.9	1.2	1.5	2.2	2.7	4.0	6.0 ²⁾	6.0 ²⁾	6.0 ²⁾
13		<0.5 ¹⁾	0.6	0.8	1.1	1.4	2.1	2.6	3.8	6.0 ²⁾	6.0 ²⁾	6.0 ²⁾
16			0.5	0.7	1.0	1.3	1.9	2.4	3.4	6.0 ²⁾	6.0 ²⁾	6.0 ²⁾
20				0.7	1.0	1.3	1.9	2.4	3.3	6.0 ²⁾	6.0 ²⁾	6.0 ²⁾
25				0.7	1.0	1.3	1.8	2.3	3.2	5.7	6.0 ²⁾	6.0 ²⁾
32					0.9	1.2	1.7	2.2	3.1	5.4	6.0 ²⁾	6.0 ²⁾
40								2.1	3.0	5.1	6.0 ²⁾	6.0 ²⁾
50								1.9	2.8	4.7	6.0 ²⁾	6.0 ²⁾
63									4.4	6.0 ²⁾	6.0 ²⁾	

Short circuit selectivity **characteristic C** towards fuse link **NH-00*** [kA]

PL6	NH-00 gL/gG													
I_n [A]	16	20	25	32	35	40	50	63	80	100	125	160		
2	<0.5 ¹⁾	0.6	1.0	2.5	6.0 ²⁾	6.0 ²⁾	6.0 ²⁾	6.0 ²⁾	6.0 ²⁾	6.0 ²⁾	6.0 ²⁾	6.0 ²⁾		
4	<0.5 ¹⁾	<0.5 ¹⁾	0.7	1.0	1.5	2.1	3.6	5.0	6.0 ²⁾	6.0 ²⁾	6.0 ²⁾	6.0 ²⁾		
6	<0.5 ¹⁾	<0.5 ¹⁾	0.5	0.8	1.2	1.5	2.5	3.3	5.7	6.0 ²⁾	6.0 ²⁾	6.0 ²⁾		
10			0.5	0.7	1.0	1.4	2.0	2.5	3.8	6.0 ²⁾	6.0 ²⁾	6.0 ²⁾		
13					1.0	1.3	1.9	2.4	3.6	6.0 ²⁾	6.0 ²⁾	6.0 ²⁾		
16						1.0	1.3	1.8	2.3	3.3	6.0 ²⁾	6.0 ²⁾		
20							1.0	1.2	1.7	2.2	3.2	5.5	6.0 ²⁾	6.0 ²⁾
25								1.6	2.1	3.0	5.2	6.0 ²⁾	6.0 ²⁾	
32									2.1	2.9	5.0	6.0 ²⁾	6.0 ²⁾	
40										2.8	4.8	6.0 ²⁾	6.0 ²⁾	
50											4.5	6.0 ²⁾	6.0 ²⁾	
63												5.9	6.0 ²⁾	

Short circuit selectivity **characteristic D** towards fuse link **NH-00*** [kA]

PL6	NH-00 gL/gG											
I_n [A]	16	20	25	32	35	40	50	63	80	100	125	160
2	<0.5 ¹⁾	<0.5 ¹⁾	0.8	1.3	2.1	3.1	6.0 ²⁾	6.0 ²⁾	6.0 ²⁾	6.0 ²⁾	6.0 ²⁾	6.0 ²⁾
4	<0.5 ¹⁾	<0.5 ¹⁾	0.7	1.0	1.6	2.2	3.8	5.2	6.0 ²⁾	6.0 ²⁾	6.0 ²⁾	6.0 ²⁾
6		<0.5 ¹⁾	0.5	0.8	1.2	1.6	2.6	3.3	5.5	6.0 ²⁾	6.0 ²⁾	6.0 ²⁾
10			0.5	0.7	1.0	1.3	1.9	2.5	3.6	6.0 ²⁾	6.0 ²⁾	6.0 ²⁾
13					1.0	1.3	1.9	2.3	3.4	6.0 ²⁾	6.0 ²⁾	6.0 ²⁾
16						1.1	1.6	2.0	3.0	5.5	6.0 ²⁾	6.0 ²⁾
20							1.4	1.8	2.8	5.0	6.0 ²⁾	6.0 ²⁾
25								1.8	2.7	4.8	6.0 ²⁾	6.0 ²⁾
32									2.4	4.1	6.0 ²⁾	6.0 ²⁾
40										4.0	6.0 ²⁾	6.0 ²⁾



¹⁾ Selectivity limit current I_s under 0.5 kA

²⁾ Selectivity limit current I_s = rated breaking capacity I_{cn} of the MCB

no selectivity

Miniature Circuit Breakers PLHT

- Miniature circuit breaker for higher rated current with high breaking capacity
- Double interruption of switching contact
- Very low let-through energy in case of short circuit
- With isolator function, meets the requirements of insulation co-ordination, distance between contacts ≥ 4 mm, for secure isolation

Accessories:

Auxiliary switch for subsequent installation (0.5 MU)	Z-LHK	248440
Shunt trip release for subsequent installation (1.5 MU)	Z-LHASA/230 Z-LHASA/24	248442 248441
Busbar 35 mm ² Rated current 110 A in case of back side connection of supply, 220 A in case of central feeding	Z-SV-35/PLHT-V	264939
End cap	Z-V-35/AK/3P	264333

Connection diagrams

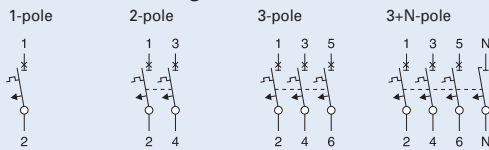

Technical Data

Electrical:

Design according to	EN 60947-2
Rated voltage	
AC	230/400 V
DC	60 V (per pole)

Ultimate short circuit breaking capacity acc. to EN 60947-2

Characteristics B,C	$I_n = 20-63$ A	25 kA
	$I_n = 80-100$ A	20 kA
Characteristic D	$I_n = 125$ A	15 kA
	$I_n = 20-63$ A	25 kA
	$I_n = 80$ A	20 kA
	$I_n = 100$ A	15 kA

Rated short circuit breaking capacity acc. to EN 60898-1

Characteristics B,C (1-, 2-, 3-, 3N-pole)	
$I_n = 20-63$ A	20 kA
$I_n = 80-100$ A	15 kA

Characteristic	B, C, D
Back-up fuse	max. 200 A gL
Rated insulation voltage	440 V
Peak withstand voltage U_{imp}	4 kV
Selectivity class	in acc. with class 3
Endurance	$\geq 20,000$ operating cycles

Mechanical:

Frame size	45 mm
Device height	90 mm
Device width	27 mm (1.5 MU) per pole
Mounting	quick fastening with 2 lock-in positions on lift terminals DIN rail EN 60715
Upper and lower terminals	lift terminals
Terminal protection	finger and hand touch safe
Degree of protection, built-in	IP40
Terminal capacity	2.5-50 mm ²

Dimensions [mm]

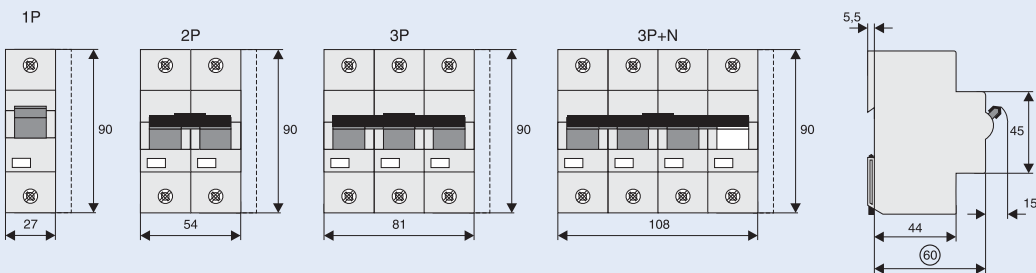

For types and art. numbers see page 42

Load Capacity

Load capacity in case of block installation

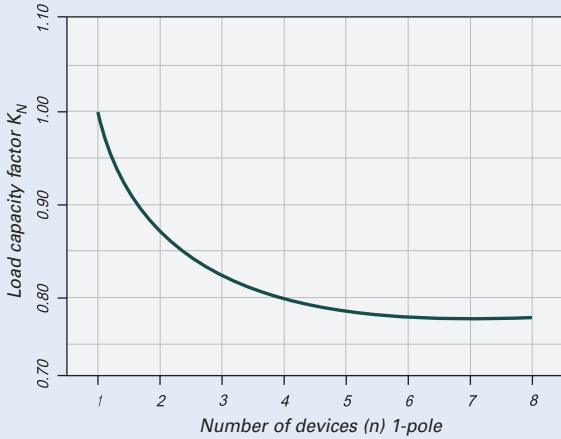

Effect of ambient temperature

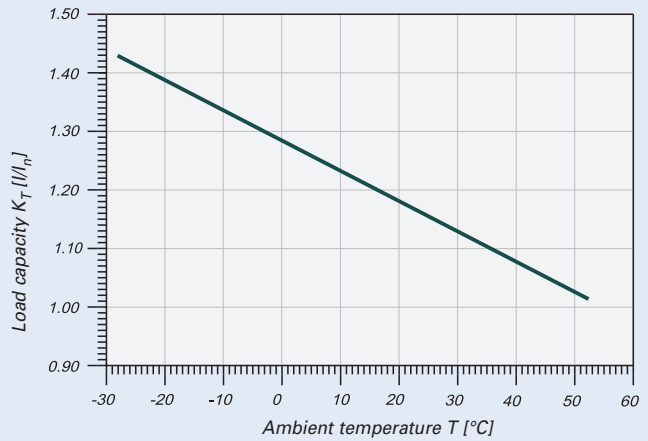

Non-tripping current of circuit breaker in case of N installed MCBs in one beside another and ambient temperature T: $I_{DL} = I_n \cdot K_T(T) \cdot K_N(N)$.
Note: Conventional non-tripping current of MCB according to EN 60898 is $1.13 I_n$ at reference temperature +30 °C.

Let-through Energy I^2t

Maximum let-through energy I^2t PLHT, characteristic C, 1-pole

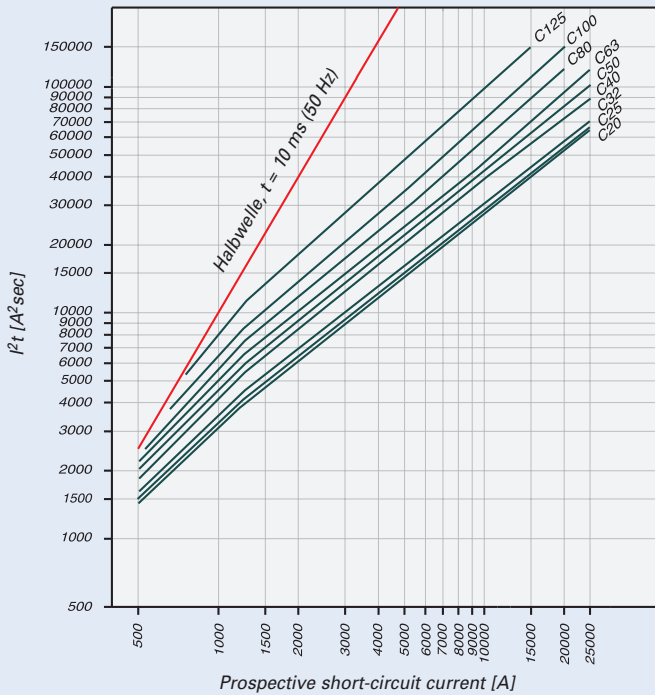

Maximum let-through energy I^2t PLHT, characteristic D, 1-pole

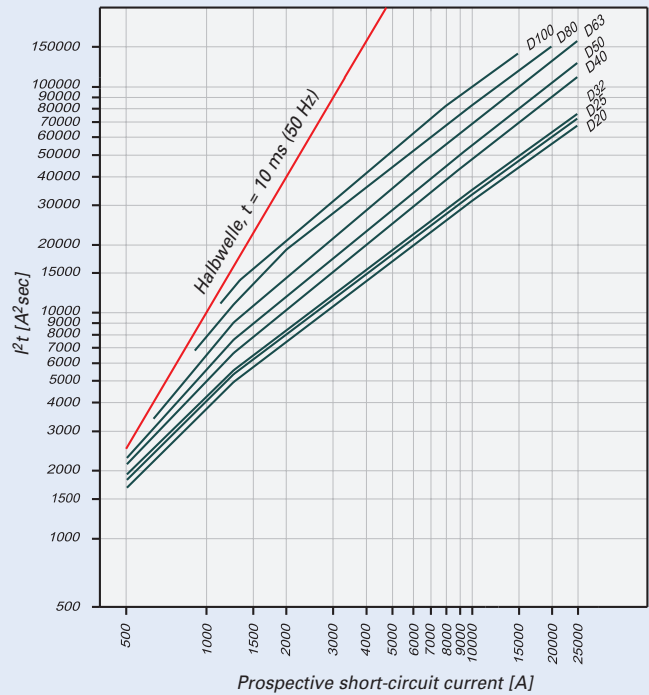

Determined according to EN 60898.

Short Circuit Selectivity PLHT

- Short circuit selectivity (in kA) between PLHT and upstream fuse D0 or NH, operating class gL/gG
- 1,4 . . . selectivity up to 1.4 kA; . . . no selectivity

Selectivity towards back-up fuses D01, D02, D03 [kA]

Rated current I_n PLHT [A]	Rated current of the back-up fuse [A]						
	25	35	50	63	80	100	
C-Characteristic	20	0.5	1.0	2.0	2.9	3.9	7.6
	25		1.0	1.9	2.8	3.8	7.3
	32		1.0	1.8	2.7	3.6	7.0
	40			1.6	2.2	3.0	5.6
	50				2.1	2.8	5.2
	63					2.7	4.8
	80						4.3
	100						
	125						
D-Characteristic	20	0.5	0.9	1.7	2.5	3.4	6.7
	25		0.9	1.6	2.3	3.2	6.2
	32		0.9	1.5	2.3	3.0	6.0
	40			1.4	2.0	2.6	4.7
	50				1.8	2.3	4.3
	63					2.1	3.7
	80						3.1
	100						

Selectivity towards back-up fuses NH Size 00 [kA]

Rated current I_n PLHT [A]	Rated current of the back-up fuse [A]										
	25	35	40	50	63	80	100	125	160	200	
C-Characteristic	20	0.5	1.0	1.3	1.9	2.7	3,7	6.7	17.0	25.0	25.0
	25		0.9	1.3	1.8	2.6	3,5	6.5	17.0	25.0	25.0
	32		0.9	1.2	1.7	2.4	3,3	6.0	15.0	23.0	25.0
	40				1.4	2.1	2.9	4.8	12.0	18.0	25.0
	50					1.9	2.7	4.5	11.0	17.0	25.0
	63							4.2	10.0	15.0	25.0
	80							3.8	8.5	12,0	25.0
	100								7.0	10.0	25.0
	125									7.5	25.0
D-Characteristic	20	<0.5	0.8	1.1	1.5	2.3	3.1	5.6	16.0	25.0	25.0
	25		0.7	1.0	1.4	2,1	3.0	5.3	14.0	23.0	25.0
	32		0.7	1.0	1.3	2.1	2.9	5.0	13.0	22.0	25.0
	40				1.1	1.8	2.5	4.2	10.0	15.0	25.0
	50					1.6	2.3	3.8	8.5	13.0	22.0
	63						2.1	3.2	7.0	10.5	18.0
	80							2.8	5.5	8.4	15.0
	100								4.8	7.5	12.5

For types and art. numbers see page 42

Short Circuit Selectivity PLHT towards NZM 1

In case of short circuit, there is selectivity between the miniature circuit breakers PLHT and the upstream NZM up to the specified values of the selectivity limit current I_s [kA] (i. e. in case of short-circuit currents I_{ks} under I_s , only the MCB will trip, in case of short circuit currents above this value both protective devices will respond). Overload and short-circuit release unit NZM at max. value.

*) basically in accordance with EN 60898 D.5.2.b

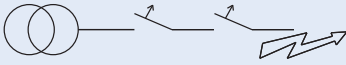

Short circuit selectivity **characteristic C** towards NZM*) [kA]

PLHT	NZM...1-A gL/gG					
I_n [A]	40	50	63	80	100	125
20	0.3	0.4	0.5	0.75	0.9	1.25
25	0.3	0.4	0.5	0.7	0.9	1.2
32		0.4	0.5	0.7	0.85	1.2
40			0.5	0.6	0.85	1.1
50				0.6	0.85	1.1
63					0.8	1
80						1
100						
125						

Short circuit selectivity **characteristic D** towards NZM*) [kA]

PLHT	NZM...1-A gL/gG					
I_n [A]	40	50	63	80	100	125
50						
63						
80						
100						

no selectivity

Short Circuit Selectivity PLHT towards NZM 2

In case of short circuit, there is selectivity between the miniature circuit breakers PLHT and the upstream NZM up to the specified values of the selectivity limit current I_s [kA] (i. e. in case of short-circuit currents I_{ks} under I_s , only the MCB will trip, in case of short circuit currents above this value both protective devices will respond). Overload and short-circuit release unit NZM at max. value.

*) basically in accordance with EN 60898 D.5.2.b

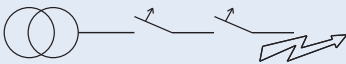

Short circuit selectivity **characteristic C** towards NZM*) [kA]

PLHT	NZM...2-A gL/gG								
I_n [A]	40	50	63	80	100	125	160	200	250
20	0.3	0.4	0.5	0.75	0.9	1.25	1.8	2.5	3.5
25	0.3	0.4	0.5	0.7	0.9	1.2	1.7	2.4	3.3
32		0.4	0.5	0.7	0.85	1.2	1.65	2.3	3.2
40			0.5	0.6	0.85	1.1	1.5	2.1	2.9
50				0.6	0.85	1.1	1.5	2	2.8
63				0.8	1	1.4	1.8	2.5	
80					1	1.4	1.8	2.4	
100						1.3	1.7	2.3	
125							1.6	2.1	

Short circuit selectivity **characteristic D** towards NZM*) [kA]

PLHT	NZM...2-A gL/gG								
I_n [A]	40	50	63	80	100	125	160	200	250
50							1	1.4	2.6
63							1	1.3	2.3
80									2.1
100									

no selectivity

Cascading of PLHT and NZM circuit breakers

- Cascading ensures proper function of downstream circuit breaker in circuits where prospective short circuit current exceeds breaking capacity of this breaker
- Effective system-based solution
- Cost and space saving
- Conditional breaking capacity acc. to EN 60947-2
- Values for 400 V AC

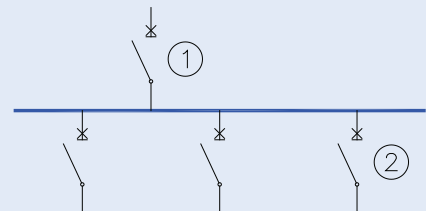

Downstream breaker PLHT characteristics B, C, D ②	Upstream breaker ①						
	I_n [A]	≤ 160			≤ 250		
	Type	NZMB1-A	NZMN1-A	NZMH1-A	NZMB2-A	NZMN2-A	NZMH2-A
	I_{cu} [kA] 415 V AC	25	50	100	25	50	150
$I_n = 20 - 125$ A	Conditional breaking capacity of PLHT [kA]	25	50	80	25	50	65

For types and art. numbers see page 42

Accessories for PLHT

Shunt Trip Release Z-LHASA

- Can be mounted subsequently onto MCB PLHT
- Contact position indicator red-green
- Marking labels can be fitted
- Wide range of operational voltage

Connection diagram

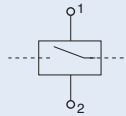

Technical Data

Electrical:

Operational voltage range	
Z-LHASA/230:	110–415 V~
Z-LHASA/24:	12–60 V~
Operational frequency	50–60 Hz
Max. current consumption at point of switching on at U_n	
Z-LHASA/230:	2 A
Z-LHASA/24:	18 A
Minimum power consumption for Z-LHASA/24	90 VA

Mechanical:

Frame size	45 mm
Device height	90 mm
Device width	27 mm
Mounting	quick fastening on DIN rail EN 60715
Upper and lower terminals	lift terminals

Dimensions [mm]

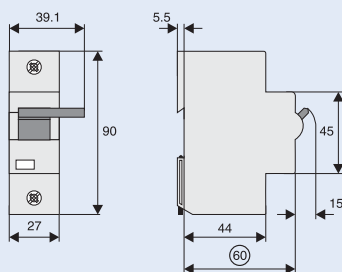

Note

Tripping release is equipped with auxiliary switch. The release is automatically disconnected from supply after tripping. That means that there can be continual voltage at the terminals 1 – 2 without risk of release damage.

Auxiliary Switch Z-LHK

- Auxiliary switch according to EN 60947-5-1
- Can be mounted subsequently

Connection diagram

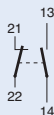

Technical Data

Electrical:

Rated operational current	(250 V~) 6 A/AC13
Minimum operational voltage	24 V each line
Rated thermal current I_{th}	8 A
Rated insulation voltage (50 Hz)	440 V~
Maximum back-up fuse	6 A gL or PL7-4./B-HS
Contacts	1 NO + 1 NC
Utilisation category AC-13	6 A/250 V AC 2 A/440 V AC
Utilisation category DC-13	4 A/60 V DC 2 A/110 V DC 0.5 A/230 V DC

Mechanical:

Frame size	45 mm
Device height	90 mm
Device width	9 mm
Mounting	mounted onto protective devices
Degree of protection, built-in	IP40
Upper and lower terminals	lift terminals
Terminal capacity	1 x 1mm ² to 2 x 2.5mm ²

Dimensions [mm]

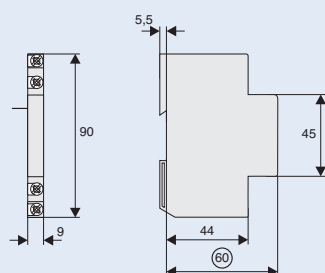

For types and art. numbers see page 44

Main Load Disconnecter Switch (Isolator) IS

- Can be used as a main switch of distribution boards

Connection diagram

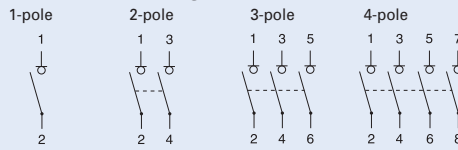

Technical Data

	IS-16	IS-20	IS-25	IS-32	IS-40	IS-63	IS-80	IS-100	IS-125
Electrical:									
Design according to	EN 60947-3								
Rated voltage U_n	240 / 415 V								
Frequency	50 / 60 Hz								
Rated insulation voltage U_i	690 V~								
Rated peak withstand voltage U_{imp}	6 kV								
Pollution degree	3								
Rated short-time withstand current I_{cw}	2 kA								
Rated short-circuit making capacity I_{cm}	2.8 kA								
Rated current I_n									
240/415 V, AC 21 B	16 A	20 A	25 A	32 A	40 A	63 A	80 A	100 A	125 A
240/415 V, AC 22 A	16 A	20 A	25 A	32 A	40 A	63 A	80 A	100 A	125 A
240/415 V, AC 23 A	16 A	20 A	25 A	32 A	40 A	63 A	80 A	100 A	125 A
Number of poles	1-, 2-, 3-, 4-pole								
Maximum back-up fuse	125 A gG								
Short circuit strength - with back-up fuse acc. to the applicable rules									
EN 60947-3	12.5 kA	12.5 kA	12.5 kA	12.5 kA	12.5 kA	12.5 kA	12.5 kA	6 kA	6 kA
Endurance									
electrical comp. op. cycles	≥ 3,000	≥ 3,000	≥ 3,000	≥ 3,000	≥ 3,000	≥ 3,000	≥ 3,000	≥ 3,000	≥ 2,000
mechanical comp. op. cycles	≥ 16,000	≥ 16,000	≥ 16,000	≥ 16,000	≥ 16,000	≥ 16,000	≥ 16,000	≥ 16,000	≥ 14,000

Mechanical:

Frame size	45 mm
Device height	80 mm
Device width	17.5 mm / pole
Mounting	quick fastening with 2 lock-in positions on DIN rail EN 60715
Degree of protection	IP10, with cover IP40
Terminals	Twin-purpose terminals
Terminal capacity	2.5–50 mm ²
Busbar thickness	0.8–1 mm
Fastening torque of terminal screws	2.5–5 Nm
Function	irrespective of the position of installation
Climatic endurance	IEC 60058

Dimensions [mm]

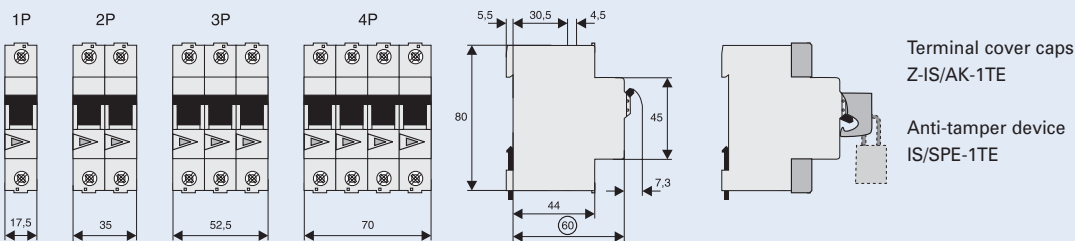

Switching interlock IS/SPE-1TE

- Without lock
- Also suitable for IS, PF7, PF6, PHF7, dRCM, PFL7, PFL6, mRB6, PFR

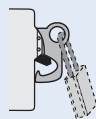

Terminal Cover Caps Z-IS/AK-1TE

- Can be sealed
- Modular design, width 1 MU

Switching interlock Z-IS/SPE-1TE

- Without lock
- Also suitable for PL7, PL6, Z-MS, ZP-A

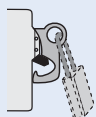

For types and art. numbers see page 46

Circuit Breaker ZP-A

- Design according to EN 60947-1, -3
- Number of poles: 1, 2, 3, 3N
- Rated current: 40 A, 63 A

Connection diagrams

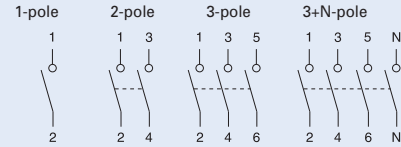

Accessories:

Auxiliary switch for subsequent installation	ZP-IHK	286052
	ZP-WHK	286053
Tripping signal contact for subsequent installation	ZP-NHK	248437
Shunt trip release	ZP-ASA/..	248438, 248439
Undervoltage release	Z-USA/..	248289-248291
Compact enclosure	KLV-TC-2	276240
	KLV-TC-4	276241
Additional terminal 35 mm ²	Z-HA-EK/35	263960
Switching interlock Z-IS/SPE-1TE	274418	

Technical Data

Electrical:

Rated operational voltage U_e	230/400 V AC
Rated frequency	50 Hz
Rated insulation voltage U_i	440 V AC
Rated peak withstand voltage U_{imp}	4 kV (1.2/50 μ s)
Conventional thermal current I_{th}	
ZP-A40	40 A
ZP-A63	63 A
Utilisation category AC-22A	
Rated operational current I_e	40 A AC, 63 A AC
Utilisation category AC-23A	
Rated operational current I_e	16 A AC
Short circuit strength	
with back-up fuse 63 A gL	3 kA (240 V, $\cos \varphi = 0,87$)
Endurance electrical comp.	$\geq 8,000$ operating cycles
mechanical comp.	$\geq 20,000$ operating cycles

Mechanical:

Frame size	45 mm
Device height	80 mm
Device width	17.5 mm (1 MU)
Mounting	quick fastening on DIN rail EN 60715
Degree of protection	IP20
Terminals	lift
Terminal protection	finger and hand touch safe
Terminal capacity	1.5–25 mm ²
Terminal screws	M5 (Pozidrive) Z2
Tightening torque of terminal screws	max. 2.4 Nm

Dimensions [mm]

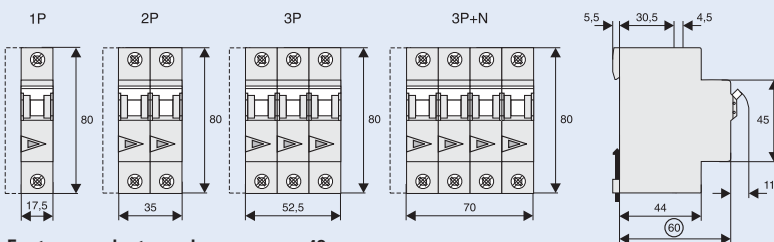

For types and art. numbers see page 42

Neutral Terminal, Feder Block Z-D..

- Compatible with all installation devices

Technical Data

Electrical:

	Z-D63	Z-D63/P	Z-D80
Rated current	63 A	63 A	80A
Frequency	50–60 Hz	50–60 Hz	50–60 Hz
N-conductor test bush	-	10 A, \varnothing 4 mm	-

Mechanical:

Frame size	45 mm
Device height	80 mm
Device width	17.5 mm (1 MU)
Mounting	quick fastening with 2 lock-in positions on DIN rail EN 60715
Degree of protection, built-in	IP40
Terminals	Twin-purpose (lift/open-mouthed)
Terminal capacity	
above	1–25 mm ²
below	1–25 mm ²
Terminal protection	finger and hand touch safe
Busbar thickness	0.8–2 mm

Connection diagrams

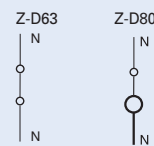

Dimensions [mm]

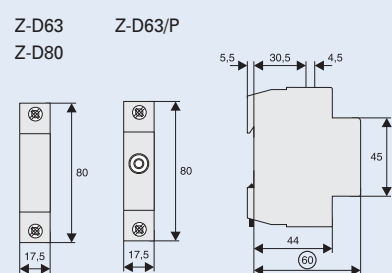

For types and art. numbers see page 46

MCB for Auxiliary Switch Circuits PL7-B4/-HS

- Design according to EN 60898
- Rated current 4 A, tripping characteristic B
- Very low let-through energy in order to prevent contact welding in auxiliary switches
- Suitable for auxiliary switches of all devices thermostats, control devices, timers, etc.
- Busbar connection to PL7, PL6, PF7, dRCM, PF6, PFL7, PFL6, mRB6

Connection diagram



Technical Data

PL7-B4/-HS

Electrical:

Number of poles	1-, 2-pole
Rated voltage	230/400 V
Frequency	50/60 Hz
Rated current	4 A
Rated breaking capacity	10 kA

Mechanical:

Frame size	45 mm
Device height	80 mm
Device width	17.5 mm (1 MU)
Mounting	quick fastening with 2 lock-in positions on DIN rail EN 60715
Degree of protection, built-in	IP40
Terminal protection	finger and hand touch safe
Terminals	Twin-purpose terminals
Terminal capacity	1–25 mm ²
Terminal screws	M3 (Pozidrive)
Fastening torque of terminal screws	0.8 – 1.0 Nm
Busbar thickness	0.8 – 2 mm

Dimensions [mm]

PL7-B4/-HS

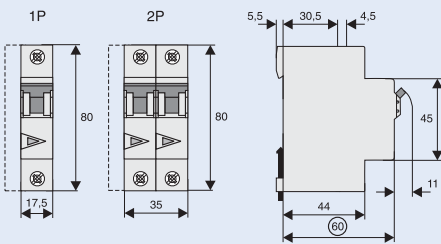

Let-through Energy PL7-B4-HS

Characteristic B, 1-pole

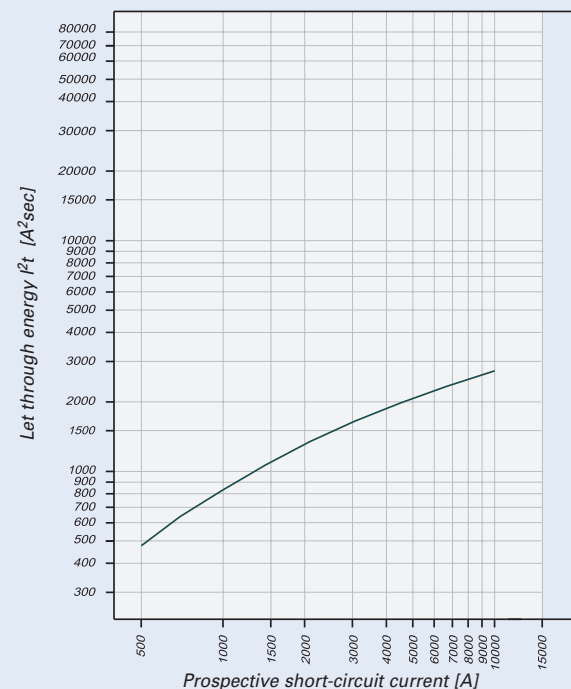

For types and art. numbers see page 47

Note

MCB PL7-B4-HS is designed for protection of contacts of auxiliary switches and auxiliary circuits that must not be damaged with overloads. With respect to requirements of EN 60947-5, protection of auxiliary circuit must be ensured in order to prevent short circuit currents to be up 1000 A.

Suitable for:

- protection of auxiliary contacts of contactors
- protection of signaling circuits
- protection of electrical tripping contacts of power protective and switching devices

Auxiliary Switch Z-HK, Z-AHK; Tripping Signal Switch Z-NHK

- Design according to EN 60947-5-1, EN 62019
- Can be mounted subsequently (screws)
- The specified minimum voltages are per contact
Take into account particularly in case of series connection!
- **Z-AHK, Z-NHK:** Contact function with relative movement (self-cleaning contacts)
- Contact material and design particularly suitable for extra low voltage
- **Z-HK:** only for PF7, PFR, PHF7-4p, PF6 series
- **Z-AHK:** for devices PHF7-2p
- **Z-NHK:** Universal design for PHF7, PFR, PF7, PF6, dRCM
The function of one of the two change-over contacts (25/21, 26/22, 28/24) can be switched from "auxiliary switch" to "tripping signal switch" by means of SEL driver.
- Auxiliary switch (11, 12, 14; 21, 22, 24) is active with both electrical and mechanical tripping
- Tripping signal switch (25, 26, 28) is active with electrical tripping only
- Test key for check of proper function of tripping signal contacts
- Contact position indicator blue-white

Connection diagrams

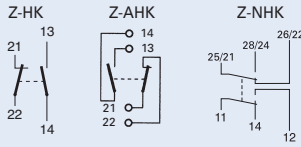

Technical Data

	Z-HK	Z-AHK	Z-NHK
Electrical:			
Can be mounted from the left onto	PF7, PF6, PFR, PFH7-4p, dRCM	PHF7-2p	–
Can be mounted from the right onto	–	–	PF7, PF6, PFR, PHF7, dRCM
Contact function	11	11	2 CO
Rated voltage	250 V	250 V	250 V
Frequency	50/60 Hz	50/60 Hz	50/60 Hz
Rated current	8 A	4 A	4 A
Rated thermal current I_{th}	8 A	4 A	4 A
Utilisation category AC-13			
Rated operational current I_e	6 A/250 V AC 2 A/440 V AC	3 A/250 V AC –	3 A/250 V AC –
Utilisation category AC-15			
Rated operational current I_e	–	2 A/250 V AC	2 A/250 V AC
Utilisation category DC-12			
Rated operational current I_e	–	0.5 A/110 V DC	0.5 A/110 V DC
Utilisation category DC-13			
Rated operational current I_e	0.5 A/230 V DC 2 A/110 V DC 4 A/60 V DC	– – –	– – –
Rated insulation voltage U_i	250 V AC	250 V AC	250 V AC
Minimum operational voltage per contact U_{min}	24 V AC/DC	5 V DC	5 V DC
Minimum operational current I_{min}	50 mA AC/DC	10 mA DC	10 mA DC
Rated peak withstand voltage U_{imp} (1,2/50µs)	2.5 kV	2.5 kV	2.5 kV
Conditional short circuit current I_k			
with back-up fuse 6 A or PL7-B4-HS	–	1 kA	1 kA
Max. back-up fuse, overload and short circuit	8 A gL / PL7../B-HS	6 A gL / PL7../B-HS	6 A gL / PL7../B-HS
Mechanical:			
Tripping indicator "electrical tripping"	–	–	blue/white
Frame size	45 mm	45 mm	45 mm
Device height	80 mm	80 mm	80 mm
Device width	8.8 mm (0.5 MU)	8.8 mm (0.5 MU)	8.8 mm (0.5 MU)
Mounting	onto switching dev. onto switching dev. onto switching dev.		
Degree of protection, built-in	IP40	IP40	IP40
Terminal protection	finger and hand touch safe		
Terminals	lift terminals	lift terminals	lift terminals
Terminal capacity	0.5–2.5 mm ²	0.5–2.5 mm ²	0.5–2.5 mm ²
Terminal screws	M3 (Pozidrive Z0)	M3 (Pozidrive Z0)	M3 (Pozidrive Z0)
Fastening torque of terminal screws	max. 0.8–1.0 Nm	max. 0.8–1.0 Nm	max. 0.8–1.0 Nm

Dimensions [mm]

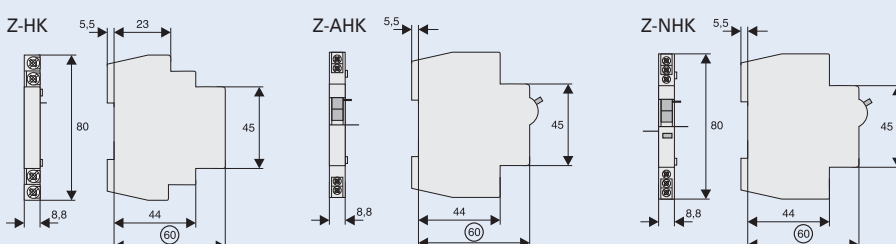

For types and art. numbers see page 47

Example: Z-HK + PF7

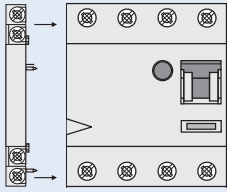

1+1 24 V 50 mA min.

Example: PF7 + Z-NHK

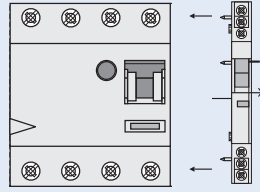

Auxiliary Switch ZP-IHK, ZP-WHK, Tripping Signal Switch ZP-NHK

- Design according to EN 62019
- Snap-on mounting, can be mounted onto PL7, PFL7, PL6, PFL6 and mRB6 subsequently
- The specified minimum voltages are per contact. Take into account particularly in case of series connection!
- **ZP-NHK:** Contact function with relative movement (self-cleaning contacts)
- Contact material and design particularly suitable for extra low voltage
- **ZP-IHK, ZP-WHK:** 2 switches can be mounted onto itself thanks to mechanical design (2 x ZP-IHK, 2 x ZP-WHK or 1 x ZP-IHK + 1xZP-WHK)
- **ZP-NHK:** Universal design for PL7, PFL7, PL6, PFL6 and mRB6. The function of one of the two change-over contacts (21/25, 22/26, 24/28) can be switched from "auxiliary switch" to "tripping signal switch" by means of SEL driver.
- Auxiliary switch (11, 12, 14; 21, 22, 24) is active with both electrical and mechanical tripping
- Tripping signal switch (25, 26, 28) is active with electrical tripping only
- Test key for check of proper function of tripping signal contacts

Connection diagrams

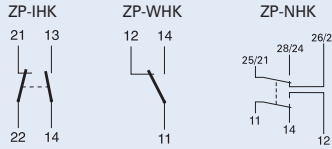

Technical Data

	ZP-IHK	ZP-WHK	ZP-NHK
Electrical:			
Can be mounted from the left onto	PFL7, PFL6, PL7, PL6, mRB6 ZP-A.., ZP-ASA, Z-MS 1xZP-IHK, 1xZP-WHK	PFL7, PFL6, PL7, PL6, mRB6 ZP-A.., ZP-ASA, Z-MS 1xZP-IHK, 1xZP-WHK	PL7, PFL7, PL6, PFL6, mRB6, ZP-A.., ZP-ASA Z-MS, 1xZP-IHK, 1xZP-WHK
Contact function	1 NO + 1 NC	1 CO	2 CO
Rated voltage	250 V	250 V	250 V
Frequency	50/60 Hz	50/60 Hz	50/60 Hz
Rated current	6 A	6 A	4 A
Rated thermal current I_{th}	6 A	6 A	4 A
Utilisation category AC-13			
Rated operational current I_e	3 A/250 V AC	3 A/250 V AC	3 A/250 V AC
Utilisation category AC-15			
Rated operational current I_e	2 A/250 V AC	2 A/250 V AC	2 A/250 V AC
Utilisation category DC-12			
Rated operational current I_e	0.5 A/110 V DC	0.5 A/110 V DC	0.5 A/110 V DC
Rated insulation voltage U_i	250 V AC	250 V AC	250 V AC
Minimum operational voltage per contact U_{min}	5 V DC	5 V DC	5 V DC
Minimum operational current I_{min}	10 mA DC	10 mA DC	10 mA DC
Rated peak withstand voltage U_{imp} (1,2/50 μ s)	2.5 kV	2.5 kV	2.5 kV
Conditional short circuit current I_k with back-up fuse 6A or PL7-B4-HS	1 kA	1 kA	1 kA
Max. back-up fuse, overload and short circuit	6 A gL / PL7-B4-HS	6 A gL / PL7-B4-HS	6 A gL / PL7-B4-HS
Mechanical:			
Tripping indicator "electrical tripping"	-	-	blue/white
Frame size	45 mm	45 mm	45 mm
Device height	80 mm	80 mm	80 mm
Device width	8,8 mm (0.5 MU)	8,8 mm (0.5 MU)	8.8 mm (0.5 MU)
Mounting	onto DIN rail EN 60715		
Degree of protection, built-in	IP40	IP40	IP40
Terminal protection	finger and hand touch safe		
Terminals	lift terminals	lift terminals	lift terminals
Terminal capacity	0.5–2.5 mm ²	0.5–2.5 mm ²	0.5–2.5 mm ²
Terminal screws	M4 (Pozidrive Z2)	M4 (Pozidrive Z2)	M3 (Pozidrive Z2)
Fastening torque of terminal screws	max. 1.2 Nm	max. 1.2 Nm	max. 0.8–1.0 Nm

Dimensions [mm]

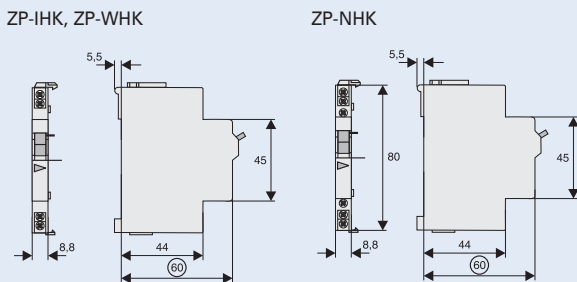

Example: ZP-IHK (ZP-WHK) + PL7

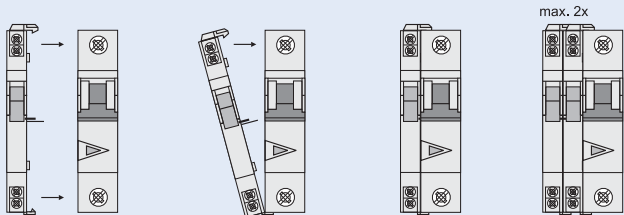

Example: ZP-NHK + PL7

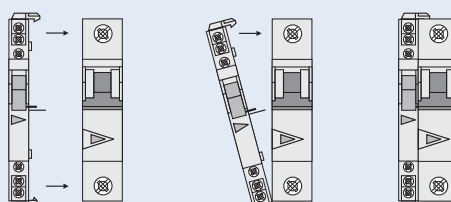

For types and art. numbers see page 48

Shunt Trip Release ZP-ASA

- Remote release for subsequent mounting onto PL7, PFL7, PL6, PFL6, mRB6, ZP-A40, ZP-A63, Z-MS
- Module width 1 MU
- Additional installation of standard auxiliary switch is possible
- Tripping release is equipped with auxiliary switch. The release is automatically disconnected from supply after tripping. That means that there can be continual voltage at the terminals 1 – 2 without risk of release damage.

- Position indicator red - green
- Type ZP-ASA for snap-on mounting

Connection diagram

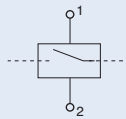

Technical Data

	ZP-ASA/24	ZP-ASA/230
Electrical:		
Can be mounted onto:	PL7, PFL7, PL6, PFL6, mRB6 ZP-A., Z-MS	PL7, PFL7, PL6, PFL6, mRB6 ZP-A., Z-MS
Operational voltage range	12–110 V AC 12–60 V DC	110–415 V AC 110–220 V DC
Frequency	50/60 Hz	50/60 Hz
Tripping time	< 20 ms	< 20 ms
Min. length of pulse	15 ms	10 ms
Internal resistance	2.2 Ω	215 Ω
Max. back-up fuse	16 A gL	16 A gL
Max. tripping current AC / DC [A]	15 / 21	2.1 / 1
Possible standard auxiliary switch	ZP-NHK	ZP-NHK
Mechanical:		
Frame size	45 mm	45 mm
Device height	80 mm	80 mm
Device width	17.5 mm (1 MU)	17.5 mm (1 MU)
Mounting	quick fastening with 2 lock-in positions	on DIN rail EN 60715
Degree of protection, built-in	IP40	IP40
Terminal protection	finger and hand touch safe	
Terminals	open mouthed/lift + guide	open mouthed/lift + guide
Terminal capacity	1–25 mm ²	1–25 mm ²

Dimensions [mm]

ZP-ASA

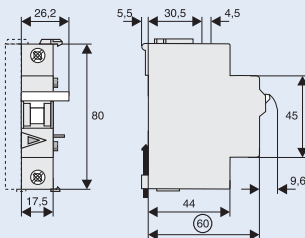

Connection Example 230 V

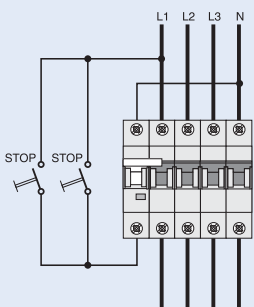

Connection Example 24 V

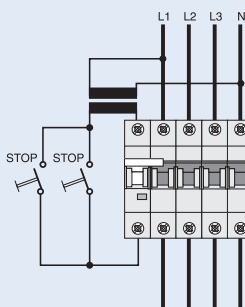

Example: ZP-ASA + PL7

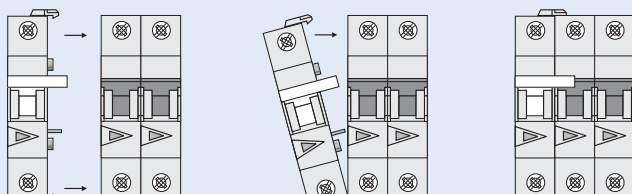

For types and art. numbers see page 48

Undervoltage Release Z-USA, Z-USD

- Tripping:
 - Instantaneous Z-USA
 - Delayed Z-USD typ. 0.4 s
- Voltage control indicator blue/white
- Service key for zero voltage switch-on for testing purposes
- Can be used with PL7, ZP-A40, Z-MS and PL6
- Screw mounting

Connection diagram

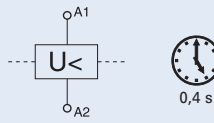

Technical Data

	Z-US./115	Z-US./230	Z-US./400
Electrical:			
Rated voltage U_n	115 V AC	230 V AC	400 V AC
Frequency	50–60 Hz	50–60 Hz	50–60 Hz
Making threshold	80 % of U_n	80 % of U_n	80 % of U_n
Tripping threshold	50 % of U_n	50 % of U_n	50 % of U_n
Mechanical:			
Frame size	45 mm	45 mm	45 mm
Device height	80 mm	80 mm	80 mm
Device width	17.5 mm (1 MU)	17.5 mm (1 MU)	17.5 mm (1 MU)
Mounting	quick fastening on DIN rail EN 60715		
Degree of protection, built-in	IP40	IP40	IP40
Terminals	open mouthed/lift	open mouthed/lift	open mouthed/lift
Terminal capacity	1–2x2.5 mm ²	1–2x2.5 mm ²	1 - 2x2.5 mm ²
Terminal protection	finger and hand touch safe		

Dimensions [mm]

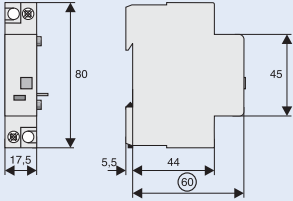

Connection Example Release

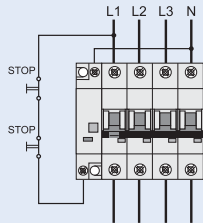

Connection Examples 400 V and 230 V

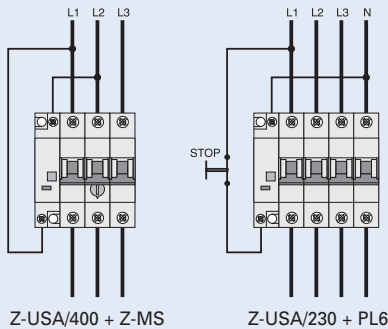

Undervoltage Relay Z-UR/400

- When the connection to the three phases and neutral is made the relay picks up in case there is no fault and the LED lights. If the monitored nominal voltage U_n drops under the release value U_s , in one, two or all three phases the relay reverts to its open position. The LED extinguishes.
- Single-phase operation: bridge L1-L2-L3.

Connection diagram

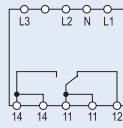

Technical Data

Electrical:

Rated operational voltage	230/400 V AC
Rated frequency	50–60 Hz
Switching voltage U_s (fixed)	$U_n \times 0.85$ (for $U_n = 230$ V)
Power consumption	< 3 VA
Power loss	0.5 W
Operational again after	approx. 200 ms
Responding delay	approx. 400 ms
Switching contact	1 CO
Rated insulation voltage U_i	250 V AC
Rated current I_e	5 A, AC-11, AC-12
Switching capacity	2000 VA
Rated impulse withstand voltage	4 kV
Duty	100 %
Overvoltage category	III
Test voltage	
Feed - relay (1.2/50) μ s	4 kV
Relay - relay (1.2/50) μ s	2.5 kV

Mechanical:

Frame size	45 mm
Device height	88 mm
Device width	27 mm
Weight	95 g
Mounting	quick fastening on DIN rail EN 60715
Degree of protection	IP40
Upper and lower terminals	lift terminals
Terminal capacity	
rigid	0.14–4 mm ²
flexible	0.14–2.5 mm ²
Tightening torque of terminal screws	0.5–0.7 Nm
Resistance to climatic conditions	F/DIN 40040
Perm. ambient temperature range	-25 to +60 °C
Flame class	V0, glow wire 960 °C
Pollution degree (EN 60947)	2

Dimensions [mm]

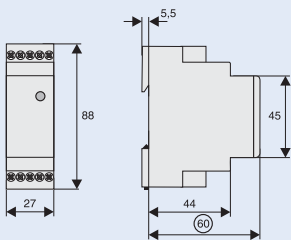

Connection Example

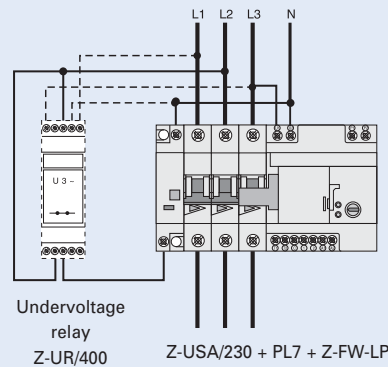

Switching Status Diagramm

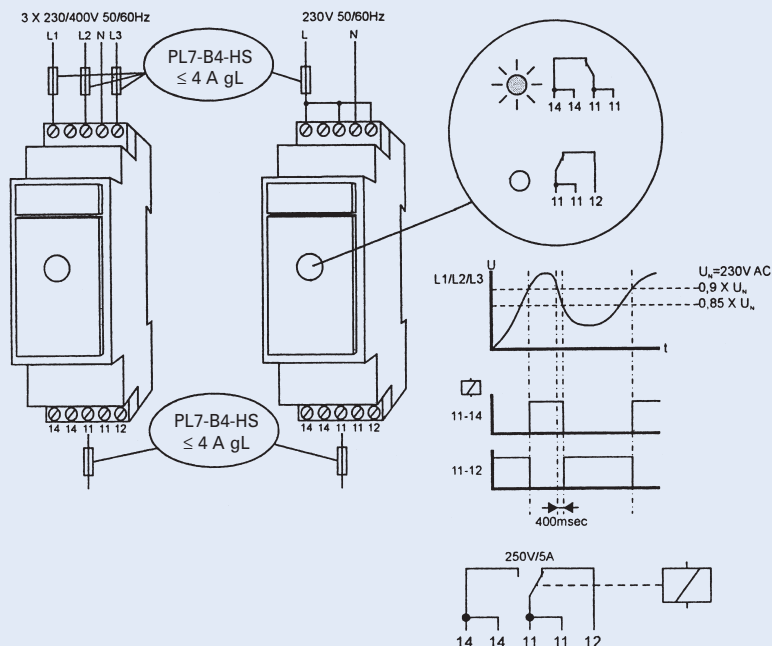

For types and art. numbers see page 49

RCD Tripping Module Z-FAM, Z-KAM

- For remote switch-off of RCDs, standard and electronic combined RCD/MCB devices
- Remote switch-off by one or several parallel potential-free contacts, e.g. pushbutton max. rated current 3 A at 250 V
- Can be mounted subsequently
- No undesired voltage rise in the consumer system during remote switch-off thanks to integrated breaker contact K1-K2

Connection diagram

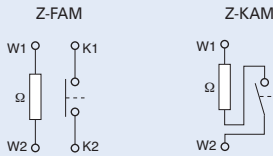

Technical Data

	Z-FAM	Z-KAM
Electrical:		
Tripping module for	PF6, PF7, PHF7-4p	PFL6, PFL7, PHF7-2p
Rated voltage	230 (400) V AC	230 (400) V AC
Frequency	50–60 Hz	50–60 Hz
Rated tripping current $I_{\Delta n}$	0.01–0.3 A	0.01–0.3 A
Function	1 NO	1 NO
Mechanical:		
Frame size	45 mm	45 mm
Device height	80 mm	80 mm
Device width	8.8 mm (0.5 MU)	8.8 mm (0.5 MU)
Degree of protection, built-in	IP40	IP40
Terminal capacity	1–2x2.5 mm ²	1–2x2.5 mm ²
Terminal protection	finger and hand touch safe	

Dimensions (mm)

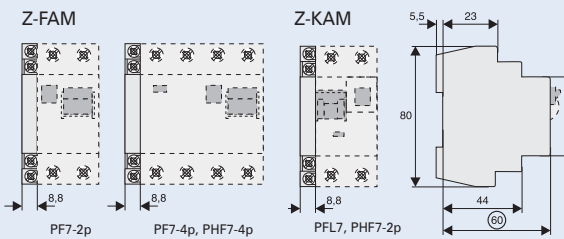

Connection examples: Lay lines to the switching devices with double insulation and overload protection, e.g. 4A gL or CLS6-4...HS

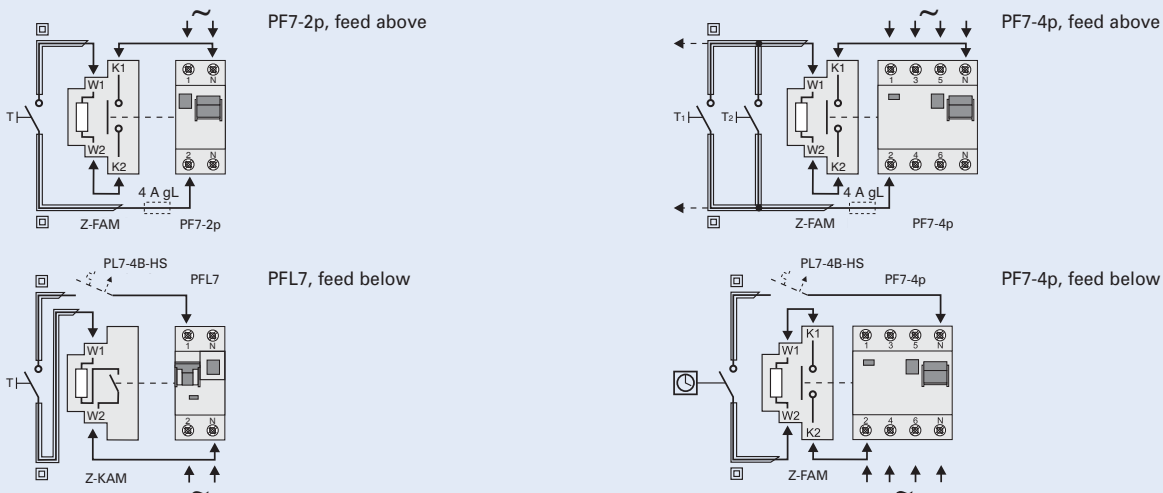

Automatic Switching Device Z-FW-LP, Z-FW-LPD, Remote Control Module Z-FW-MO

- Shape compatible switching device suitable for subsequent installation for automatic re-setting and remote control of PL6, PF6, PL7, PF7, PHF7-4p, ZP-A40, ZP-A63, PFR, Z-MS, dRCM and mRB6
- **Z-FW-LP, Z-FW-LPD** for automatic repeated switching
- Mechanical interlock, can be sealed with leads
- Mechanical switching capability up to max. PF7-100/4p, PL7-63/3p+N, PL6-63/3p
- Operating and alarm display by green and red LED
- **Z-FW-MO**: remote control module for automatic switching device. Enables also remote testing of RCDs.
- **Z-FW-MO**: supplied as pre-mounted sets with Z-FW-LP(D)

Connection diagrams

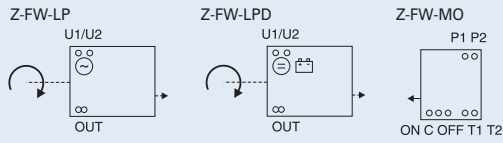

Technical Data

	Z-FW-LP	Z-FW-LPD	Z-FW-MO
Electrical:			
Possible operating voltages	220–240 V AC	24–48 V DC	–
Frequency	50/60 Hz	–	–
Control voltage for remote control	–	–	24–230 V AC/DC
Relay output for tripping test with Z-FW	–	–	400 V AC max.
Relay output for alarm, potential-free	5 A/250 V AC	5 A/250 V AC	–
Functions	automatic restarting	automatic restarting	+ON/OFF/TEST
Function selector	Automatic 5x OFF/RESET	Automatic 5x OFF/RESET	ON, OFF/RESET
Min. pulse duration	1 s: 50 Hz, 3 s: < 50 Hz		
Resetting times	≤ 20 s; 30 s; 70 s; 10 min.; 1 hod		
Switching delay time after command	≤ 25 s		
Ready for receiving switching command	40 s after switching on power supply voltage		
Max. current consumption	35 mA ^{*)}	380 mA / 24 V ^{*)} 140 mA / 48 V ^{*)}	3,5 mA
Power consumption	3.5 W ^{*)}	0.8 W ^{*)}	17 mW
^{*)} In set with Z-FW-MO			
Mechanical:			
Frame size	45 mm	45 mm	45 mm
Device height	80 mm	80 mm	80 mm
Device width	70 mm	70 mm	35 mm
Mounting	quick fastening with 2 lock-in positions on DIN rail EN 60715		
Degree of protection, built-in	IP40	IP40	IP40
Terminal protection	finger and hand touch safe		
Terminals	lift terminals		
Terminal capacity	2 x 1.5 mm ² oder 1 x 2.5 mm ²		
Scope of delivery	–	–	Coupling plug
Range of operation temperatures	-25 to +40 °C	-25 to +40 °C	-25 to +40 °C

Dimensions [mm]

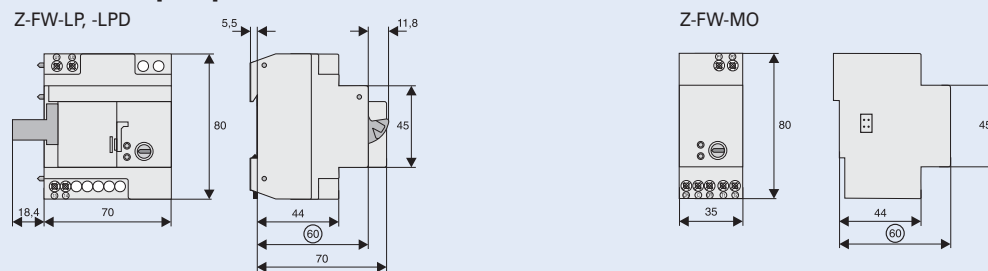

Connection examples

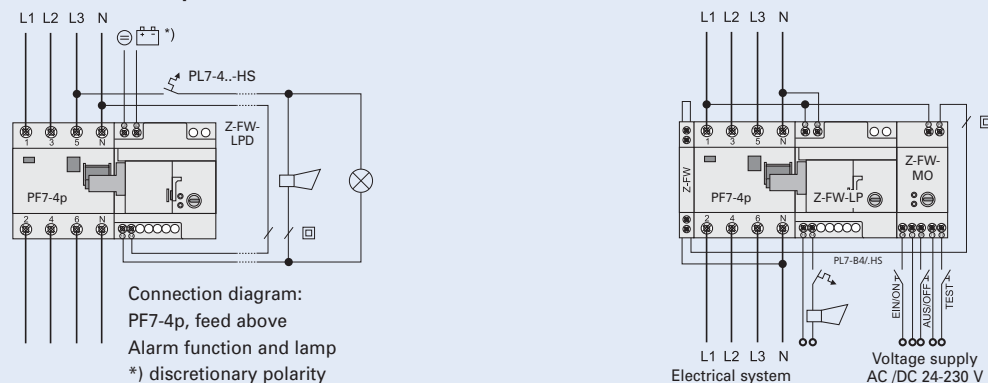

For types and art. numbers see page 50

Pre-mounted Sets

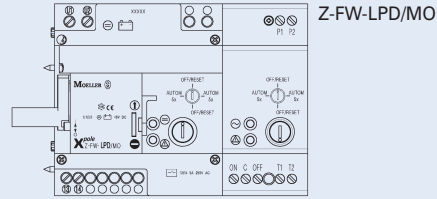
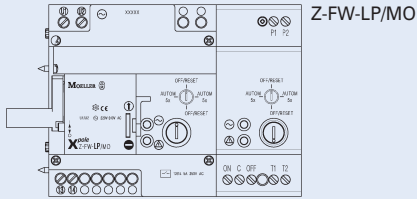

Remote Testing Module Z-FW (for Z-FW-LP)

- External testing module with testing resistor for RCDs
- Proper "external" test key function according to the applicable rules thanks to design adapted to the rated tripping current
- For remote testing with remote control and automatic switching device Z-FW-LP
- No undesired voltage rise in the consumer system during remote switch-off thanks to integrated breaker contact K1-K2
- Can also be used as a remote tripping module for PF, PHF7

Dimensions [mm]

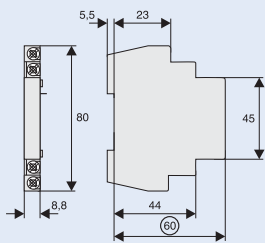

Connection examples

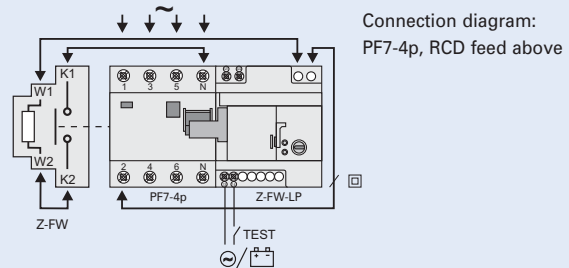
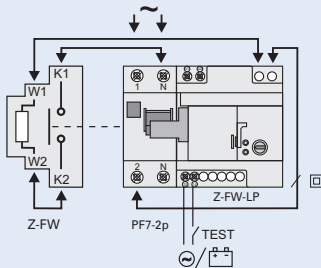

Communication Center Z-CC

- Compact remote monitoring and controlling unit
- The Communication Center keeps you informed for example, when the RCD has tripped or when the room temperature in your weekend cottage is too low.
- Connect your alarm lines from fire detectors or security systems to the Communication Center directly.
- Switch pumps, heating systems or other devices with your mobile phone by SMS.
- The device can be fully configured via SMS (optionally it can be configured via the Web-Browser of a connected PC)
- Integrated quad-band GSM modem
- 4 Digital inputs
- 2 Relay outputs
- Activated inputs triggers sending of SMS messages and e-mails up to 3 phone numbers and one e-mail address
- Controlling outputs via SMS
- The current status can be checked by SMS anytime
- Compatible with SIM cards of all common mobile communication providers (no SIM lock)
- It is also possible to check the current credit available on prepaid phone cards
- Connection to customer's network is possible
- Permanent intern control of the modem - functions are shown on the front LEDs

Accessories:

Power supply unit 24 V EASY200-POW	229424
Temperature sensor Z-CC/2CO-SE	119430
Cross-over patch cord	
CAT5e 2 m DNW-PX/0200/RJ45/RJ45/5E/CSUTP/GR/PV	237271

Technical Data

Electrical:		Mechanical:	
Power supply	12 – 24 V DC (min. 10 V DC up to a max. of 30 VDC)	Frame size	45 mm
Power consumption	1.5 W up to a max. of 6 W	Device height	97 mm
Temperature sensor	d = 15.8 mm, length 106mm, cable of 1.4 m length incl. 9-pole sub-D-plug for RS232 connector	Device width	105 mm
Measuring range	-10 °C to +50 °C	Mounting	Quick-fastening for DIN rail EN 60715
Accuracy	+/- 2 °C	Degree of protection, built-in	IP40
Outputs	2 potential-free relay outputs AC: 5 A at 250 V AC DC: 5 A up to 30 V DC, 0.3 A up to 110 V DC, 0.12 A up to 220 V DC Max. switching capacity AC15 at 230 V AC: 500 VA		
Inputs	4, max. 24 V DC galvanically separated (optical coupler)		
Ethernet interface	For parameterization via a PC (Web-Browser). Connection to the PC by means of a cross-over network cable (DNWPX/0200/RJ45/RJ45)		
RS232 interface	9-pole sub-D-plug; for connecting an external temperature sensor		
Green LED ON	Modem Status LED (LED flashes every 3 seconds during registration at the GSM-net)		
Red LED ON	Modem Activity LED (LED flashes when a SMS is sended or received)		

Dimensions [mm]

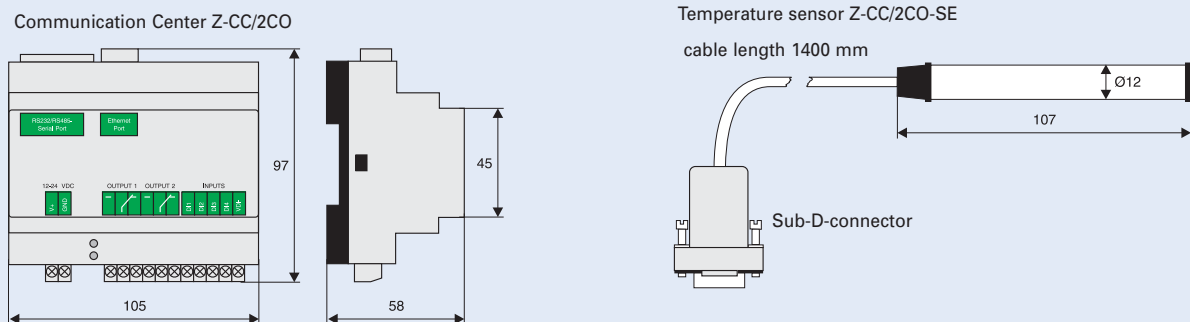

For types and art. numbers see page 50

Basic circuit

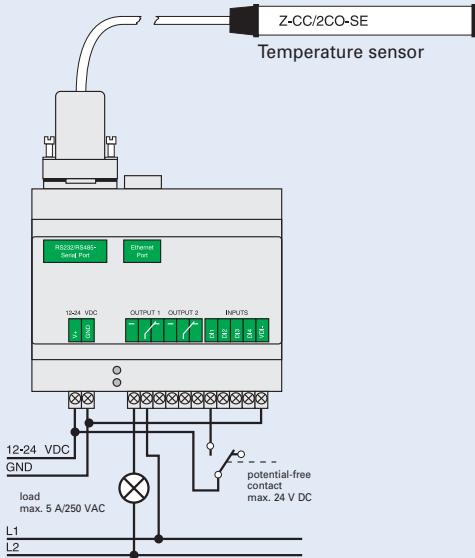

PC configuration

Message settings

Input 1 sends the following message:	RCD has tripped!
Input 2 sends the following message:	Smoke detector alert!
Input 3 sends the following message:	Door contact alert!
Input 4 sends the following message:	Water detector alert!

The above-listed messages will be sent to the following phone numbers, for example (max. 3):
+436501234567, +436761234567, +436641234567

The above-listed messages will be sent to the following e-mail address, for example:

john.smith@chello.at

Save

Application example

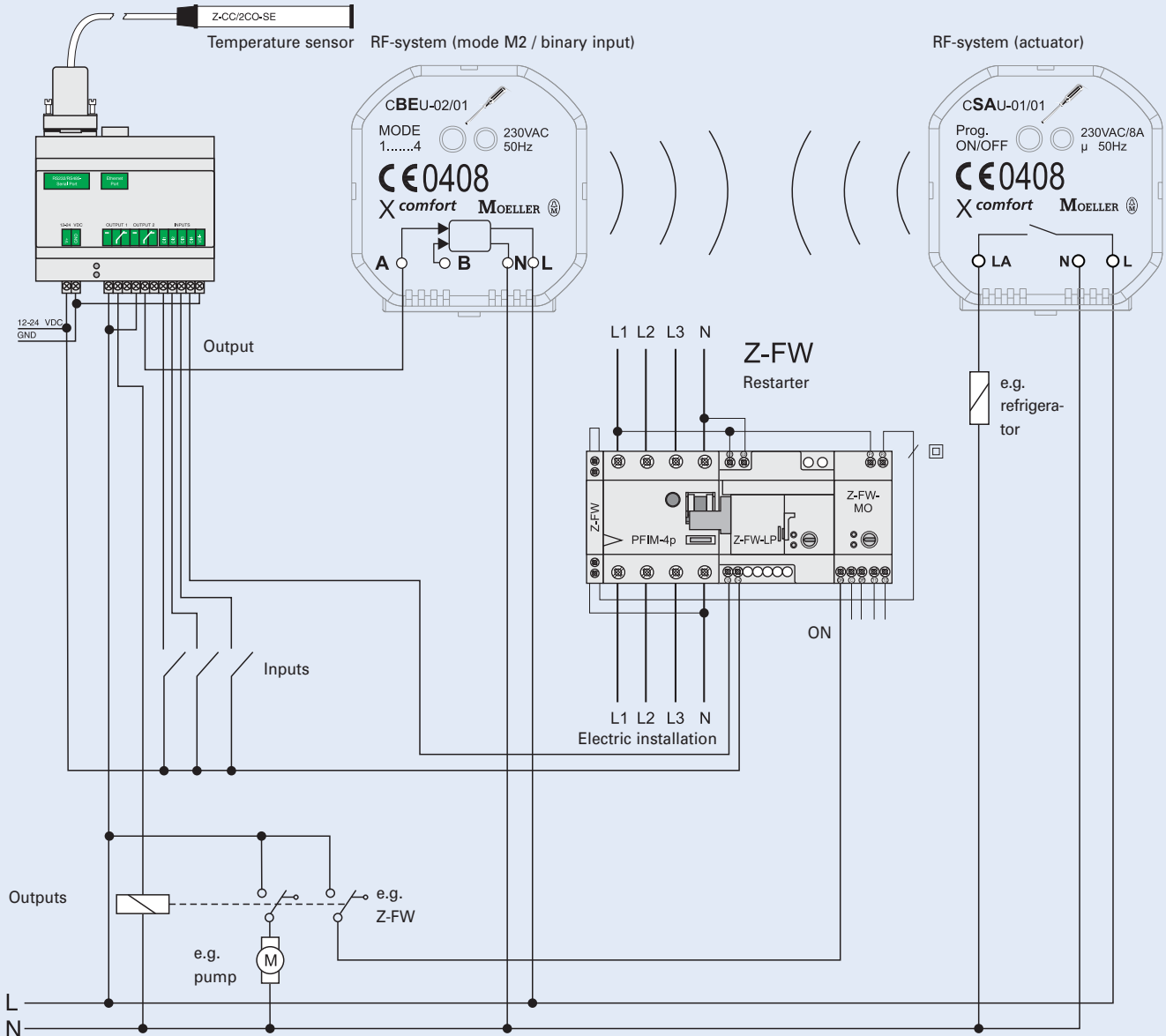

For types and art. numbers see page 50

Bioswitch FFS/16

- Line voltage LED
- AUTOMATIC ON/OFF switch
- All-pole disconnection
- 2 contacts NO
- Not suitable for consumers with electronic control

Connection diagram

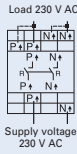

Technical Data

Electrical:

Rated voltage	230 V AC
Tolerance	-15% to +10%
Rated frequency	48 - 63 Hz
Rated consumption	11 VA (1.6 W)
Duration of operation	100%
Detecting voltage	200 - 250 mV DC
Current consumption	32 mA
Making current	5 - 200 mA
Breaking current	fix, approx. 70% of making current
Drop-out voltage	> 10% of the rated voltage
Tripping delay	fixed, approx. 6 s
Rise time	fixed, approx. 0.5 s
Base accuracy	±10% (of max. scale value)
Green LED ON	indication of supply voltage
Yellow LED ON	indication of relay output
Output circuit	2 potentialfree contacts NO
Switching capacity	4000 VA (16 A / 250 V AC)
Back-up fuse	16 A
Mechanical life	30 x 10 ⁶ operations
Electrical life	2 x 10 ⁵ operations at 1000 VA resistive load

Mechanical:

Frame size	45 mm
Device height	87 mm
Device width	35 mm
Mounting	quick fastening on DIN rail EN 60715
Degree of protection, built-in	IP40
Installation	in any position
Terminal protection	finger and hand touch safe
Torque	max. 1 Nm
Terminal capacity	1 x 0.5-4 mm ² 2 x 0.5-2.5 mm ²
Ambient temperature	-25 °C to +55 °C
Storage temperature	-25 °C to +70 °C
Relative humidity	15 % to 85 % acc. to IEC 721-3-3 class 3K3
Degree of pollution	2
If built-in	3 (acc. to IEC 664-1)

Switching frequency
 at 100 VA resistive load max. 60/min
 at 1000 VA resistive load max. 6/min
 (according to IEC 664-1)

Rated insulating voltage 250 V AC
 (according to IEC 664-1)

Rated surge voltage 4 kV

Overvoltage cat. III
 (according to IEC 664-1)

Base load resistor Z-NKA... if high-impedance consumers are connected to a "Bio-switch", the ZNKA... is needed. By pressing the button, the Z-NKA... is activated for 5 minutes. As long as any consumer is still switched on, the automatic deactivating of the Z-NKA... will have no effect.

Dimensions [mm]

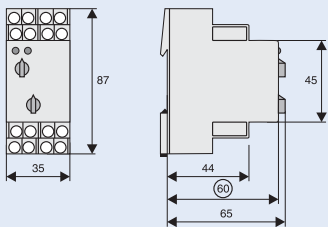

Connection Example

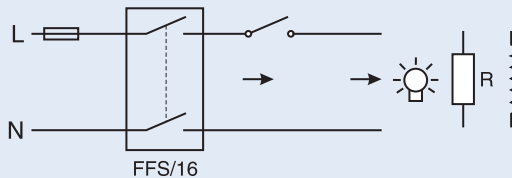

The Z-NKA... is only necessary for electronic loads with inrush currents below the adjusted I_{ON} of the FFS/16 (high-impedance consumers).
 Note: The base load resistor has to be connected in parallel to the load.

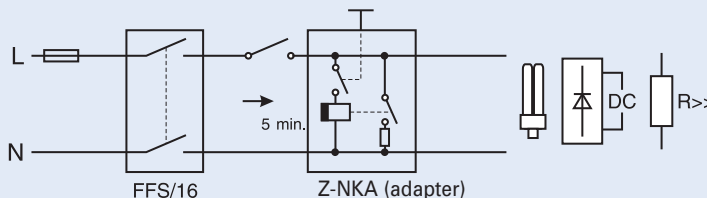

I_{ON} = 5 mA ... 200 mA ~ μ 230 V ~ 16 A ~
 I_{OFF} = 0,7 x I_{ON} max. 1000 W ☼

For types and art. numbers see page 50

Front Plate Tripping Device Z-MFPA

- Mechanical tripping device for PL6, PFL6, ZP-A40, ZP-A63, PL7, PFL7
- Responds when the front plate of a distribution box is removed
- Maximum tripping capacity: 4 + 4 poles symmetrically (4 left + 4 right)
- Can be interlocked by twisting when the tripping pin is in the pressed position (service works)
- Meets requirements of standards for automatic disconnection from power supply if front plate of distribution box is removed (see HD 60364-4-41, cl. 412.2.4, EN 60439-1, cl. 7.4.2.2.3b)

Function Diagram



Technical Data

Mechanical:

Frame size	45 mm
Device height	80 mm
Device width	17.5 mm
Mounting	quick fastening on DIN rail EN 60715
Degree of protection, built-in	IP40

Dimensions [mm]

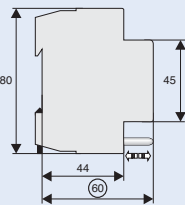
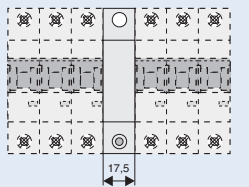

max. 4 poles max. 4 poles

Function

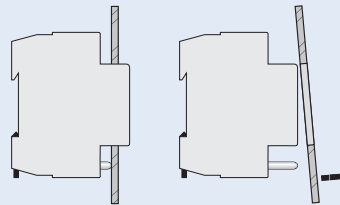

mechanical tripping of connected devices

Protective Earth Socket Z-SD230

- Design according to VDE, ÖVE, ČSN
- Screw fastening is possible
- Width 2.5 MU
- Model -BS with child protection device and earth pin

Connection diagram



Technical Data

Electrical:

Rated voltage	250 V AC
Rated current	10/16 A

Mechanical:

Frame size	45 mm
Device height	76 mm
Device width	44 mm
Mounting	quick fastening on DIN rail EN 60715
Degree of protection, built-in	IP40
Upper and lower terminals	lift terminals
Terminal capacity	1 to 2x2.5 mm ²

Dimensions [mm]

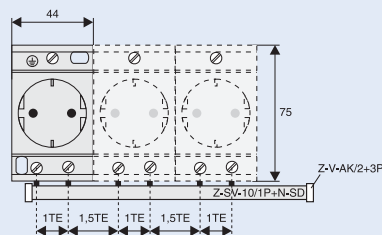
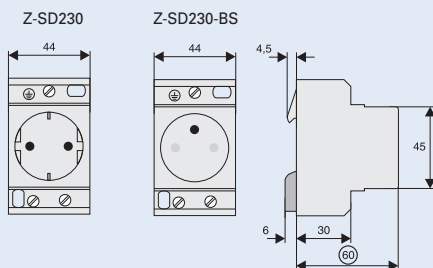

For types and art. numbers see page 51

Priority-(Current) Relay Z-LAR/

- For simple priority connection of important consumers
- For fast current increase
- Expensive peak loads are avoided efficiently (staggered heating)
- Integrated auxiliary switch, 1 NC or 1 NO or 1 CO contact
- NC and NO contact are potential free

Connection diagram

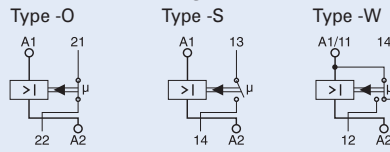

Technical Data

	Z-LAR/8	Z-LAR/16	Z-LAR/32
Electrical:			
Nominal thermal current I_{th}	8 A	16 A	32 A
Rated voltage U_n	250 V AC	250 V AC	250 V AC
Responding current I_{AN}	≥ 3 A	≥ 10 A	≥ 15 A
Release current I_A	≤ 1.8 A	≤ 4.2 A	≤ 7.4 A
Max. electrical switching frequency	3600/h	3600/h	3600/h
Rated insulation voltage U_i	440 V	440 V	440 V
Power loss at I_{th}			
Effective power	3.4 W	1.95 W	3,17 W
Apparent power	7.7 VA	4.66 VA	7.36 VA
Rated peak withstand voltage U_{imp}	4 kV	4 kV	4 kV
Back-up fuse line protection	max. 10 A	max. 16 A	max. 32 A
Switching contact			
Function NC, NO, CO			
Back-up fuse	max. 10 A gL	max. 16 A gL	max. 32 A gL
Contact gap ^{*)}	< 3 mm (μ)	< 3 mm (μ)	< 3 mm (μ)
Switching capacity	1 A/250 V~	1 A/250 V~	1 A/250 V~
Minimum switching capacity	300 mW	300 mW	300 mW
Minimum operational voltage	12 V	12 V	12 V
Electrical endurance	100,000 operating cycles		

^{*)} Distance between contacts less than 3 mm.

Mechanical:

Frame size	45 mm	45 mm	45 mm
Device height	80 mm	80 mm	80 mm
Device width	17.5 mm (1 MU)	17.5 mm (1 MU)	17.5 mm (1 MU)
Mounting	quick fastening on DIN rail EN 60715		
Degree of protection, built-in	IP40	IP40	IP40
Upper and lower terminals	lift terminals	lift terminals	lift terminals
Degree of protection of terminals	IP20	IP20	IP20
Terminal capacity			
Main circuit	2 x 10 mm ²	2 x 10 mm ²	2 x 10 mm ²
Auxiliary circuit	2 x 2.5 mm ²	2 x 2.5 mm ²	2 x 2.5 mm ²
Fastening torque of terminal screws			
Main circuit	max. 2.4 Nm	max. 2.4 Nm	max. 2.4 Nm
Auxiliary circuit	max. 1 Nm	max. 1 Nm	max. 1 Nm

Dimensions [mm]

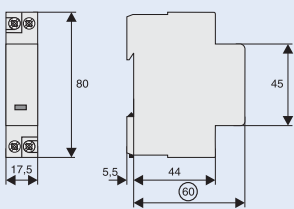

Connection Example - Operating Status

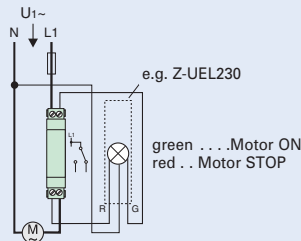

Connection Example - Priority for Pump

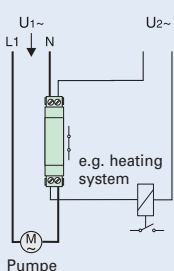

For types and art. numbers see page 51

Connection Example - "OR" Circuit, Extraction System

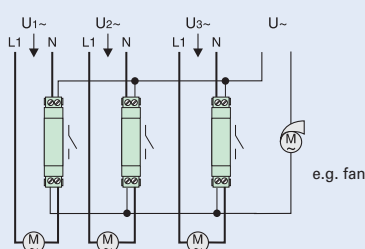

Signal Lamps Z-EL, Z-DL., Z-BEL; Pushbutton Units Z-PU.; Switches Z-SW.

- Long service life
- Colour of LED can be selected by alternative wiring
- Flash option by usage of different terminals only, changeover option, no additional relay necessary (Z-BEL)

Connection diagrams

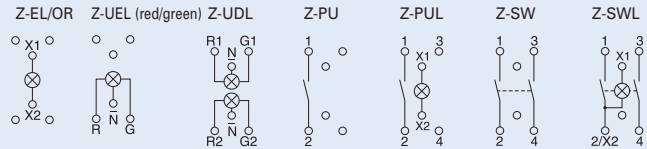

Technical Data

	Z-EL, Z-DLD, Z-BEL	Z-PU, Z-PUL	Z-SW, Z-SWL
Electrical:			
Rated voltage	-	250 V AC	250 V AC
Frequency	-	50 Hz	50 Hz
Rated current	-	16 A	16 A
LED			
Rated voltage	230 V AC/DC 24 V AC/DC	230 V AC/DC 24 V AC/DC	230 V AC/DC 24 V AC/DC
Range of operational voltage	(50 V) 110–240 V AC/DC (5 V) 12–24 V AC/DC	(50 V) 110–240 V AC/DC (5 V) 12–24 V AC/DC	(50 V) 110–240 V AC/DC (5 V) 12–24 V AC/DC
Luminosity	15 mcd	15 mcd	15 mcd
Power loss	2 W/LED	2 W	2 W
Switching contact	-	16 A/250 V~	16 A/250 V~
Contact function	-	1NO, 2NO, 1NO+1NC, 2NC	1NO, 2NO, 1NO+1NC
Flashing frequency	typ. 2 Hz (Z-BEL)	-	-
Maximum back-up fuse, short circuit	-	20 A gG	20 A gG
Mechanical:			
LED colour	red, green, red + green white + white, red / green orange, blue, white	orange	orange
Push-button colour	-	green - NO-contact red - NC-contact black - NO/NC-contact	black
Frame size	45 mm	45 mm	45 mm
Device height	90 mm	90 mm	90 mm
Device width	17.5 mm (1 MU)	17.5 mm (1 MU)	17.5 mm (1 MU)
Mounting	quick fastening with 2 lock-in positions on DIN rail EN 60715		
Degree of protection installed device	IP40	IP40	IP40
Terminals	lift terminals	lift terminals	lift terminals
Terminal capacity	1–10 mm ²	1–10 mm ²	1–10 mm ²
Resistance to climatic conditions	acc. to IEC/EN 60068	acc. to IEC/EN 60068	acc. to IEC/EN 60068

Dimensions [mm]

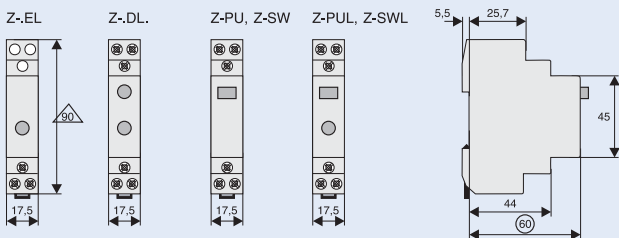

Connection example for LED red/green

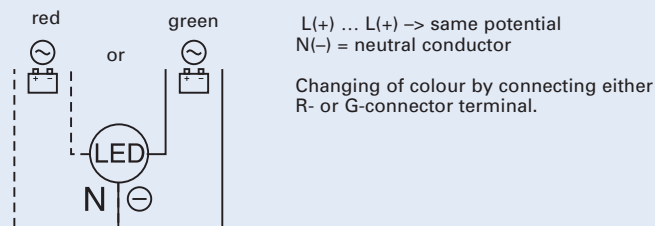

Connection example for flashing function

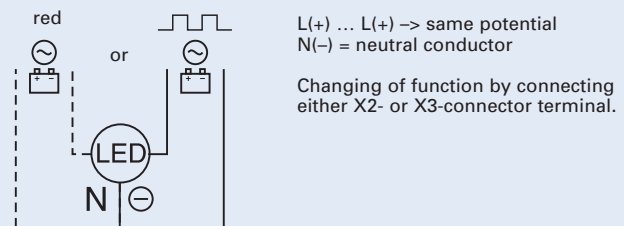

For types and art. numbers see page 52, 53

Pushbutton Z-T; Control Switch Z-S/, Z-S32/; Changeover Switch Z-S/.W

- Design according to EN 60669, VDE 0632
- Types Z-S/WM and /2WM with central position (0-position)

Connection diagrams

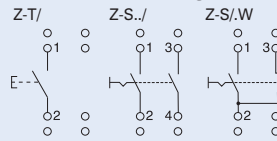

Technical Data

	Z-T/	Z-S./	Z-S/.W
Electrical:			
Rated voltage	230/400 V AC	230/400 V AC	230/400 V AC
Frequency	50 Hz	50 Hz	50 Hz
Rated current	16 A/230 V~	16, 32 A/230 V~	16 A/230 V~
Switching capacity	–	1.25 x I _n ; 1.1 x U _n	1.25 x I _n ; 1.1 x U _n
Short circuit strength	10 kA	10 kA	10 kA
Mechanical:			
Switching toggle	–	black	black
Pushbutton colour	green - NO black - NO/NC	–	–
Frame size	45 mm	45 mm	45 mm
Device height	80 mm	80 mm	80 mm
Device width	17.5 mm (1 MU)	17.5 mm (1 MU)	17.5 mm (1 MU)
Mounting	quick fastening with 2 lock-in positions on DIN rail EN 60715		
Degree of protection, built-in	IP40	IP40	IP40
Upper and lower terminals	lift terminals	lift terminals	lift terminals
Terminal capacity	1–10 mm ²	1–10 mm ²	1–10 mm ²
Resistance to climatic conditions	acc. to IEC/EN 60068	acc. to IEC/EN 60068	acc. to IEC/EN 60068

Dimensions [mm]

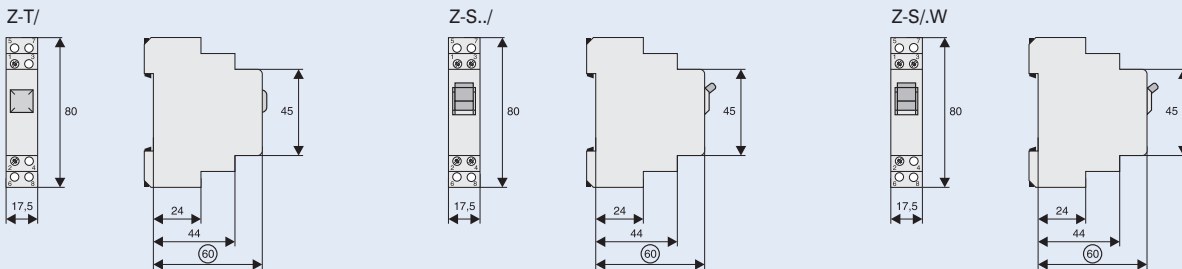

Rotary Switch Z-DS

- Rotary switches of series Z-DS are of a modular design:
The switch proper consists of the engaging work and the switching package. The switching cams (for which it is also called cam switch) are driven by a stable, torsion-proof aluminium shaft. The switching package consists of one or several switching cells with one or two independent contacts. Connections of adjoining switch terminals (necessary in case of voltmeter changeover switch Z-DSV) are contained in the pressed switch component. Consequently, there is no obstacle when connecting the connection lines.
- Application:
Suitable for virtually any application, e.g. motor switch, garage doors, fans, shutters, heating system control, lighting fixtures, instrument switches, different control purposes, etc.

Dimensions [mm]

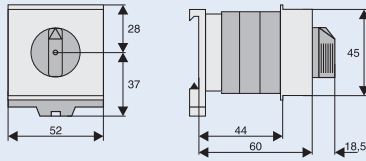

Connection diagrams

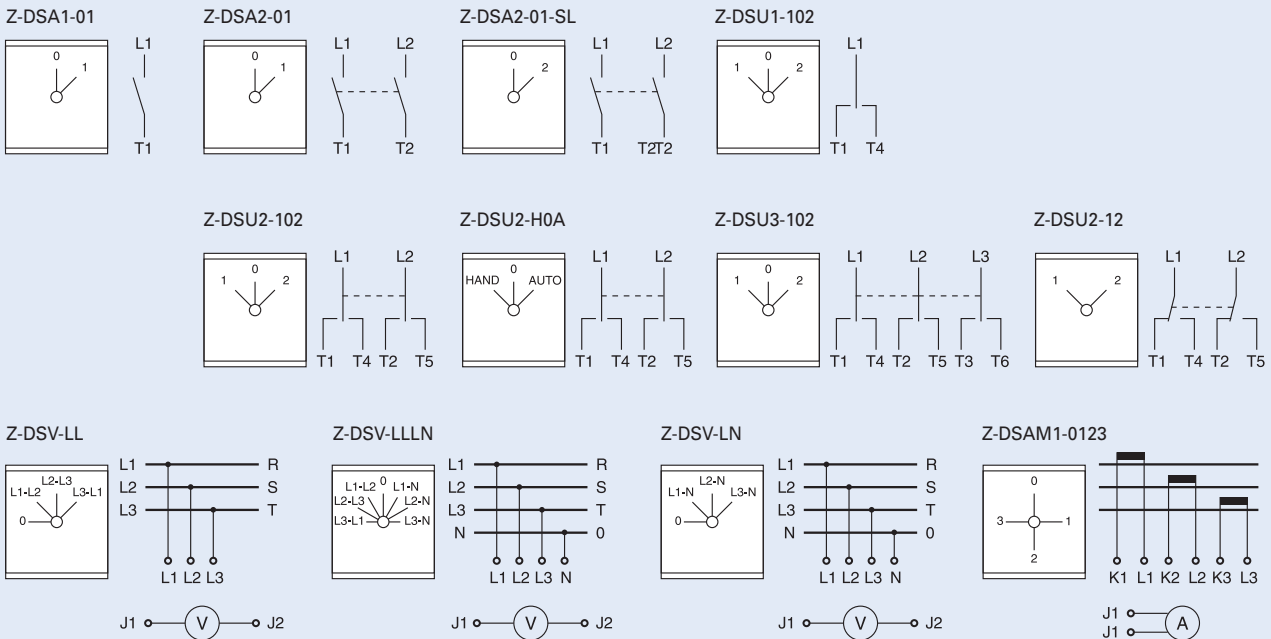

Technical Data

Data acc. to IEC 60947-3, IEC 60947-5-1, VDE 0660, EN 60947-3, SEV, CEE24			
Nominal thermal current I_{th} open	A	20	Utilisation category AC-15 Switching of electromagnetic drives, contactors, valves, pull-type electromagnets Nominal operational current I_n up to 240 V A 6 380-440 V A 4 500 V A 5
Nominal thermal current I_{thg} hermetically enclosed	A	20	
Nominal operational voltage U_e $U_{imp} = 6$ kV Disconnecter conditions acc. to ÖVE, IEC	V	690	
Circuit breaking capacity I_v 3 x 220-440 V 3 x 500 V 3 x 660-690 V	A	160	Utilisation category DC-21A, DC-21B Switching of resistive loads Time constant $L/R \leq 1$ ms Nominal operational current I_n 1-pole 30 V A 20 60 V A 4 110 V A 0.6 220 V A 0.3 440 V A -
	A	100	
	A	80	
Utilisation category AC-21A, AC-21B Switching resistive loads including low overloads Nominal operational current I_n	A	20	Utilisation category DC-3 - DC-5 Switching of shunt motors and series motors Time constant $L/R \leq 15$ ms Nominal operational current I_n 1-pole 30 V A 8 60 V A 1 110 V A 0.3
Utilisation category AC-23A, AC-23B Switching motors and other highly inductive loads Nominal operational current I_n 400 V	A	16	
Nominal power 220-240 V 3-phase, 3-pole 380-440 V 500 V 660-690 V	kW	4 7.5 7.5 7.5	
Star-delta starting switch for squirrel cage motors Nominal power 3-phase, 3-pole	kW	3.7 7.5	Terminal capacity one or several wires fine wires fine wires with wire end sleeve terminal screw number of conductors per terminal
220-240 V	kW	3.7	
380-415 V	kW	7.5	
Utilisation category AC3 Switching of 3-phase AC motors Nominal operational current I_n 400 V	A	12	Switching of capacitive load maximum making capacity up to 500 V A 140
Nominal power 220-240 V 3-phase, 3-pole 380-440 V 500 V 660-690 V	kW	3 5.5 5.5 5.5	
	kW	3 5.5 5.5 5.5	
Degree of protection from behind			IP20

For types and art. numbers see page 54

Short circuit protection				Short-time load capacity			
max. fuse	gL/gG	A	20	Load duration	3 s	A	100
Rated short-time withstand current (1 second current)		A	250		10 s	A	60
Conditional rated short circuit current		kA _{RMS}	10		30 s	A	35
					60 s	A	25

Rotary Switch Z-DS for Lighting Systems

				Z-DS...
Utilisation category AC-1	Rated operational current 60 °C	I_e AC-1	A	20
Utilisation category AC-5a	Rated operational power 220-240 V~	$\cos\phi = 0,5$ $\cos\phi = 0,9$ DUO	kW kW kW	1.1 0.4 3
Utilisation category AC-5b	Rated operational power 220-240 V~		kW	1.4



Incandescent Lamps

	Power	Current	Z-DS...
Utilisation category AC-5b	W	A	max. number of lamps per current path at 230 V, 50 Hz
Incandescent lamps AC-5b	60	0.27	22
	100	0.45	13
	200	0.91	7
	300	1.36	4
	500	2.27	3
	1000	4.5	1



Fluorescent Tubes, Mercury Arc Lamps

Utilisation category AC-5a	Power	Current	Capacitor	Z-DS...	
Lamp Types	W	A	μF	max. number of lamps per current path at 230 V, 50 Hz	
Fluorescent tubes without compensation or with series compensation	11	0.16	-	60	
	18	0.37	2.7	25	
	24	0.35	2.5	25	
	36	0.43	3.4	20	
	58	0.67	5.3	14	
	65	0.67	5.3	13	
	85	0.8	-	11	
	Fluorescent tubes, lead-lag circuit	11	0.07	-	2 x 100
		18	0.11	-	2 x 50
		24	0.14	-	2 x 40
		36	0.22	-	2 x 30
		58	0.35	-	2 x 20
		65	0.35	-	2 x 15
	Fluorescent tubes with parallel comp.	11	0.16	2.0	30
18		0.37	2.0	20	
24		0.35	3.0	15	
36		0.43	4.5	10	
58		0.67	7.0	6	
65		0.67	7.0	5	
Fluorescent tubes with electronic ballast	18	0.09	-	40	
	36	0.16	-	20	
	58	0.25	-	15	
	2 x 18	0.17	-	2 x 20	
	2 x 36	0.32	-	2 x 10	
	2 x 58	0.49	-	2 x 7	
Mercury arc lamps, high pressure without compensation e.g. HQL, HPL	50	0.61	-	16	
	80	0.8	-	12	
	125	1.15	-	8	
	250	2.15	-	4	
	400	3.25	-	3	
	700	5.4	-	1	
	1000	7.5	-	1	
	Mercury arc lamps, high pressure with compensation e.g. HQL, HPL	50	0.28	7	7
		80	0.41	8	5
		125	0.65	10	3
250		1.22	18	2	
400		1.95	25	1	
700		3.45	45	1	
1000		4.8	60	-	

Metal Halide Lamps

Lamp Types	Power	Current	Capacitor	Z-DS...
	W	A	µF	max. number of lamps per current path at 230 V, 50 Hz
Metal halide lamps without compensation, e.g. HQL, HPI	35	0.53	-	22
	70	1	-	12
	150	1.8	-	6
	250	3	-	4
	400	3.5	-	3
	1000	9.5	-	1
	2000	16.5	-	-
Metal halide lamps with compensation, e.g. HQL, HPI	35	0.25	6	8
	70	0.45	12	4
	150	0.75	20	2
	250	1.5	33	1
	400	2.1	35	1
	1000	5.8	95	-
	2000	11.5	148	-
Transformers for low-voltage halogen lamps	20	-	-	40
	50	-	-	20
	75	-	-	13
	100	-	-	10
	150	-	-	7
	200	-	-	5
	300	-	-	3

Sodium Vapour Lamps

	Power	Current	Capacitor	Z-DS...
	W	A	µF	max. number of lamps per current path at 230 V, 50 Hz
Sodium vapour lamps low-pressure without compensation	35	1.5	-	7
	55	1.5	-	7
	90	2.4	-	4
	135	3.5	-	3
	150	3.3	-	3
	180	3.3	-	3
	200	3.3	-	3
Sodium vapour lamps low-pressure with compensation	35	0.31	20	3
	55	0.42	20	2
	90	0.63	30	1
	135	0.94	45	1
	150	1	40	1
	180	1.16	40	1
	200	1.32	25	1
Sodium vapour lamps high-pressure without compensation	150	1.8	-	5
	250	3	-	4
	330	3.7	-	3
	400	4.7	-	2
	1000	10.3	-	1
Sodium vapour lamps high pressure with compensation	150	0.83	20	2
	250	1.5	33	2
	330	2	40	1
	400	2.4	48	1
	1000	6.3	106	-

Time Lag Relays ZR

Functions

- **ZRER/W**
 - E ON delay
 - R OFF delay
- **ZRMF1/W, ZRMF2/WW**
 - E ON delay
 - R OFF delay
 - Ws Single shot leading edge with control input
 - Wa Single shot trailing edge with control input
 - Es ON delay with control input
 - Wu Single shot leading edge voltage controlled
 - Bp Flasher pause first
- **ZRTAK/W**
 - lp Asymmetric flasher pause first
 - li Asymmetric flasher pulse first

Indicators:

ZRER/W, ZRMF1/W, ZRMF2/WW

- Green LED U/t ON: indication of supply voltage
- Green LED U/t flashes: indication of time period
- Yellow LED R ON/OFF: indication of output relay

ZRTAK/W

- Green LED U/t ON: indication of supply voltage
- Green LED U/t slow flashing: indication of time period t1
- Green LED U/t fast flashing: indication of time period t2
- Yellow LED R ON/OFF: indication of output relay

Connection diagram

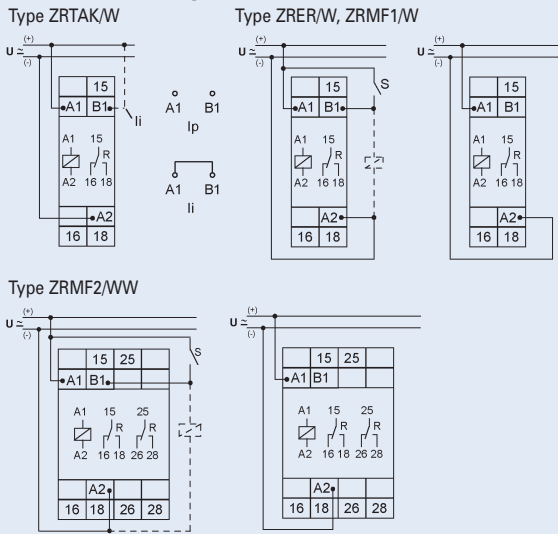

Time Ranges

Absolute time range	Setting range	
1 s	50 ms	1 s
10 s	500 ms	10 s
1 min	3 s	1 min
10 min	30 s	10 min
1 h	3 min	1 h
10 h	30 min	10 h
100 h	5 h	100 h

Dimensions [mm]

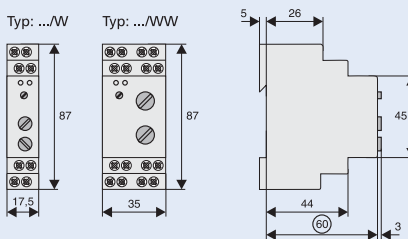

Technical Data

Electrical:

Design according to	EN 60669
Basic accuracy	± 1 % (of scale end value)
Setting accuracy	< 5 % (of scale end value)
Repeating accuracy	< 0.5 % or ± 5 ms
Effect of voltage	-
Effect of temperature	≥ 0.01 % / °C

Input circuit:

Feed voltage	
Terminals A1-A2	24 V to 240 V AC/DC 24 V / -15 % to 240 V / + 10 %
Nominal frequency	48 to 63 Hz
Nominal consumption	
Type: .../W	4 VA (1.5 W)
Type: .../WW	6 VA (2 W)

Duty	100 %
Operational again after	100 ms
Residual ripple in case of DC	10 %
Release voltage	>30 % of min. feed voltage

Output circuit:

Switching capacity	1 potential-free CO 2000 VA (8 A / 250 V AC)
Fuse protection	8 A
Mechanical endurance	20 x 10 ⁶ operating cycles
Electrical endurance	
at a resistive load of 1000 VA	2 x 10 ⁵ operating cycles
Switching frequency	
at a resistive load of 100 VA	max. 60/min
at a resistive load of 1000 VA (in acc. with IEC 947-5-1)	max. 6/min
Rated surge voltage	4 kV
Overvoltage category	III (in acc. with EN 60664-1)

Control contact

Input carrying potential	Terminals A1-B1
loadable	yes
Maximum line length	10 m
Minimum control pulse length	
DC	50 ms
AC	100 ms
Trigger level (sensitivity)	automatic adaption to supply voltage

Mechanical:

Frame size	45 mm
Device height	87 mm
Device width	17.5 (W) and 35 (WW) mm
Degree of protection, built-in	IP40
Position of installation	optional
Upper and lower terminals	bow terminal
Terminal protection	finger and hand touch safe
Terminal capacity	
1 x 0.5-2.5mm ²	
1 x 4 mm ²	
2 x 0.5-1.5 mm ²	
2 x 2.5 mm ²	
Tightening torque	
of terminal screws	max. 1 Nm
Permitted relative humidity	15% to 85%
in acc. with IEC 60721-3-3, Class 3K3	
Ambient temperature	-25 to +55%
in acc. with EN 60068-1	
Storage and transport temperature	-25 to + 70 °C
Pollution degree	2
When built in	3

For types and art. numbers see page 54

Description of Functions

• E - ON delay

When the supply voltage U is applied, the set interval t begins (green LED U/t flashes). After the interval t has expired (green LED U/t illuminated) the output relay R switches into on-position (yellow LED illuminated) This status remains until the supply voltage is interrupted. If the supply voltage is interrupted before the expiry of the interval t, the interval already expired is erased and is restarted when the supply voltage is next applied.

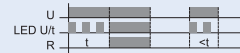

• R - OFF delay

The supply voltage U must be constantly applied to the device (green LED U/t illuminated) When the control contact S is closed, the output relay R switches into on-position (yellow LED illuminated). If the control contact is opened, the set interval t begins (green LED U/t flashes) After the interval t has expired (green LED U/t illuminated) the output relay switches into off-position (yellow LED not illuminated) If the control contact is closed again before the interval t has expired, the interval already expired is erased and is restarted.



• Ws - Single shot leading edge with control input

The supply voltage U must be constantly applied to the device (green LED U/t illuminated). When the control contact S is closed, the output relay R switches into on-position (green LED U/t illuminated) and the set interval t begins (green LED U/t flashes). After the interval t has expired (green LED U/t illuminated) the output relay switches into off-position (yellow LED not illuminated). During the interval, the control contact can be operated any number of times. A further cycle can only be started when the cycle run has been completed.

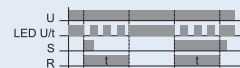

• Wa - Single shot trailing edge with control input

The supply voltage U must be constantly applied to the device (green LED U/t illuminated). Closing the control contact S has no influence on the condition of the output R. When the control contact is opened, the output relay switches into on-position (yellow LED illuminated) and the set interval t begins (green LED U/t flashes). After the interval t has expired (green LED U/t illuminated), the output relay switches into off-position (yellow LED not illuminated). During the interval, the control contact can be operated any number of times. A further cycle can only be started when the cycle run has been completed.



• Es - ON delay with control input

The supply voltage U must be constantly applied to the device (green LED U/t illuminated). When the control contact S is closed, the set interval t begins (green LED U/t flashes). After the interval t has expired (green LED U/t illuminated) the output relay R switches into on-position (yellow LED illuminated). This status remains until the control contact is opened again. If the control contact is opened before the interval t has expired, the interval already expired is erased and is restarted with the next cycle.

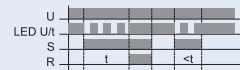

• Wu - Single shot leading edge voltage controlled

When the supply voltage U is applied, the output relay R switches into on-position (yellow LED illuminated) and the set interval t begins (green LED U/t flashes). After the interval t has expired (green LED U/t illuminated) the output relay switches into off-position (yellow LED not illuminated). This status remains until the supply voltage is interrupted. If the supply voltage is interrupted before the interval t has expired. The output relay switches into off-position. The interval already is erased and is restarted when the supply voltage is next applied.



• Bp - Flasher pause first

When the supply voltage U is applied, the set interval t begins (green LED U/t flashes). After the interval t has expired, the output relay R switches into onposition (yellow LED illuminated) and the set interval t begins again. After the interval t has expired. the output relay switches into off-position (yellow LED not illuminated). The output relay is triggered at a ratio of 1:1 until the supply voltage is interrupted.

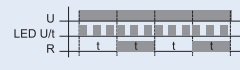

• Ip - Asymmetric flasher pause first

When the supply voltage U is applied, the set interval t1 begins (green LED U/t flashes slowly) After the interval t1 has expired. the output relay R switches into on-position (yellow LED illuminated) and the set interval t2 begins (green LED U/t flashes fast). After the interval t2 has expired, the output relay switches into off-position (yellow LED not illuminated). The output relay is triggered at the ratio of t1:t2 until the supply voltage is interrupted.

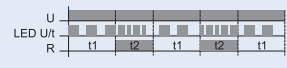

• li - Asymmetric flasher pulse first

When the supply voltage U is applied, the output relay R switches into on-position (yellow LED illuminated) and the set interval t1 begins (green LED U/t flashes slowly). After the interval t1 has expired, the output relay switches into off-position (yellow LED not illuminated) and the set interval t2 begins (green LED U/t flashes fast). After the interval t2 has expired, the output relay switches into on-position (yellow LED illuminated). The output relay is triggered at the ratio of t1:t2 until the supply voltage is interrupted.



Impulse Relay Z-S.

- Relay for switching electrical consumers in impulse operation
- According to EN 60669
- Size compatible with the other installation devices
- Glow lamps of illuminated pushbuttons connected parallel produce reactive currents which need to be compensated by a capacitor block Z-S/KO
- For max. number of parallel glow lamps see Technical Data

Security:

- Optional optical operating status display by means of LED
- Switching position indicated on the front side by manual operating key
- All terminals - coil and contacts - equipped with guide for secure terminal connection. Misplacement of wires impossible.
- Made of hardly flammable materials and plastics free from chlorine and halogens.

Advantages:

- Low switching noise
- Easy to connect thanks to large terminals which are supplied open
- Simple snap-on fastening on 35 mm DIN railm
- High degree of flexibility thanks to a variety of contact configurations

Connection diagrams

1TE Z-S./.

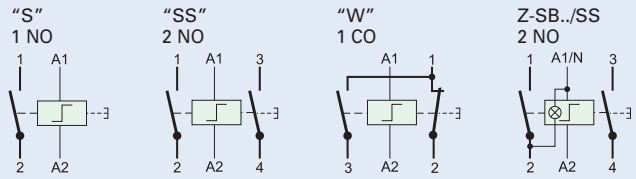

2TE Z-S./.

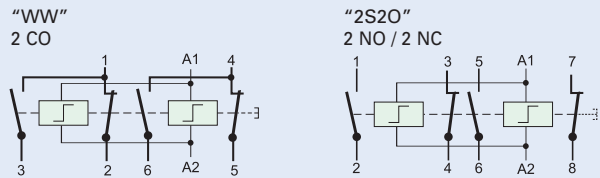

Technical Data

Electrical:

Design according to	EN 60669-2-2
Rated current (250 V AC)	16 A
Number of poles	1 to 3
Main contacts	
NO	1, 2, 3 and 4 (1 MU)
CO	1, 2 (1MU, 2 MU)
Control Circuit	
Rated control feed voltage U_s	12, 24, 48, 230 V AC 12, 24 V DC
Rated frequency	50 Hz
Operating range	0.9–1.1 x U_s
Pickup power of coils	12 VA / typ. 7 W
Max. number of parallel pushbutton units	unlimited
Max. number of parallel illuminated pushbutton units (230 V 0.6 mA typ.)	
without compensation	8 units (1 MU), 15 units (2 MU)
with compensation 1 x Z-SC/KO (Z-S/KO)	23 units (1 MU)
with compensation 2 x Z-SC/KO (Z-S/KO)	46 units (1 MU), 43 units (2 MU)
Command duration	
minimum	> 200 ms
recommended	< 1 min
maximum	~ 1 hod, < 100 %, with spacer Z-DST
Sensitivity to command impulse	
make	rise edge
break	fall edge
Rated peak withstand voltage U_{imp}	2 kV (1.2 / 50 μ s)
Load Circuit	
Rated operational voltage U_n	250 / 415 V AC
Minimum operational voltage U_{min}	24 V AC / DC (U_s 8-110 V)
Rated insulation voltage U_i	500 V
Rated peak withstand voltage U_{imp}	4 kV (1.2 / 50 μ s)
Conventional thermal current I_{th}	16 A AC
Rated operational current I_e	16 A AC

Rated constant current I_u	16 A AC
Rated current DC I_e	
24 V	16 A DC
48 V	12.5 A DC
230 V	1 A DC
Conditional rated short circuit current I_{sc}	10 kA (with 20 A gL/gG)
Duration of bouncing	< 10 ms (typ. < 5 ms)
Endurance	
electrical comp.	$\geq 40 \times 10^3$ operating cycles
mechanical comp.	$\geq 1 \times 10^6$ operating cycles

Mechanické

Frame size	45 mm
Device height	90 mm
Device width	17.5 mm (1 MU)
Mounting	quick fastening on DIN rail
Degree of protection installed device	IP20
Position of device in use	works in any position
Upper and lower terminals	lift terminals (captive)
Terminal capacity	
Contact and coil	0.5–10 mm ² one- or more wire 0.5–6 mm ² fine-wire with wire end sleeve
Temperature range	-20 °C to +45 °C
Total contact gap	> 5 mm / independent contacts
Contact material	does not contain cadmium

Accessories

Capacitor block Z-S/KO	1.5 μ F, 240 V AC
------------------------	-----------------------

Dimensions [mm]

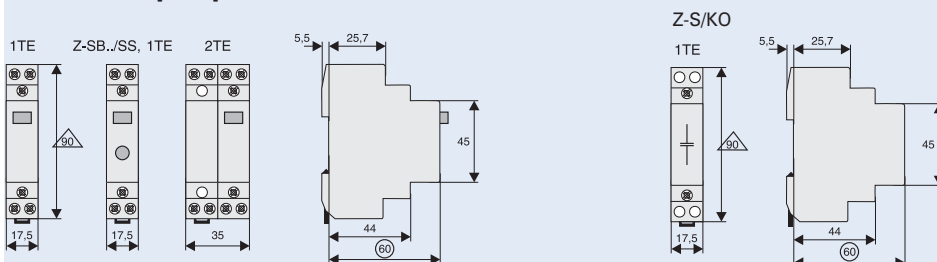

For types and art. numbers see page 55

Impulse Relay Z-SC with Central Control

- Relay for switching electrical consumers in impulse operation
- According to EN 60669
- Size compatible with the other installation devices
- Possibility of two-level control – local and central
- Glow lamps of illuminated pushbuttons connected parallel produce reactive currents which need to be compensated by a capacitor block Z-S/KO
- For max. number of parallel glow lamps see Technical Data
- Necessary not to exceed maximum value of rated voltage of control circuit - both local and central control must be fed from identical phase. Input without signal must not be connected to zero potential (otherwise inner blocking diode between inputs is destroyed)

Security:

- Switching position indicated on the front side by manual operating key
- All terminals - coil and contacts - equipped with guide for secure terminal connection. Misplacement of wires impossible.
- Made of hardly flammable materials and plastics free from chlorine and halogens.

Advantages:

- Low switching noise and no humming
- Easy to connect thanks to large terminals which are supplied open
- Simple snap-on fastening on 35 mm DIN rail
- High degree of flexibility thanks to a variety of contact configurations

Connection diagrams

1TE Z-SC./S

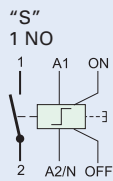

2TE Z-SC./.

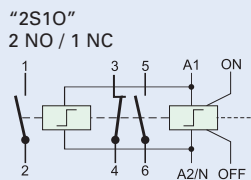

2TE Z-SC./.

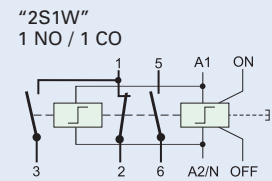

"3S" 3 NO

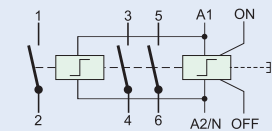

Technical Data

Electrical:

Design according to	EN 60669-2-2
Rated current (250 V AC)	16 A
Number of poles	3
Main contacts	
NO	1 (1 MU), 3 (2 MU)
NO + NC	2+1 (2 MU)
CO + NO	1+1 (2 MU)

Control Circuit

Rated control feed voltage U_s	24, 230 V AC
Rated frequency	50 Hz; 50–60 Hz 240 V
Operating range	0.9–1.1 x U_s
Maximum power of coils, pick-up	$U_s = 24 V$: 25 VA (15 W)
pick-up	$U_s = 230 V$: 32 VA (19 W)
Max. number of parallel pushbutton units	unlimited
Max. number of parallel illuminated pushbutton units (230 V 0.6 mA typ.)	
without compensation	8 units (1 MU), 15 units (2 MU)
with compensation 1 x Z-SC/KO (Z-S/KO)	23 units (1 MU)
with compensation 2 x Z-SC/KO (Z-S/KO)	46 units (1 MU), 43 units (2 MU)
Minimum command duration	> 200 ms
Rated peak withstand voltage U_{imp}	2 kV (1.2/50 μ s)
Duty	100 % (1 MU) < 100 %, 1 h max. with spacer Z-DST

Load Circuit

Rated operational voltage U_n	240 / 415 V AC
Minimum operational voltage U_{min}	24 V AC / DC (U_s 8-110 V)
Rated insulation voltage U_i	500 V
Rated peak withstand voltage U_{imp}	4 kV (1,2 / 50 μ s)
Conventional thermal current I_{th}	16 A AC
Rated operational current I_o	16 A AC

Rated constant current I_u	16 A AC
Rated current DC I_e	
24 V	16 A DC
48 V	12,5 A DC
230 V	1 A DC
Conditional rated short circuit current I_q	10 kA (with 20 A gL/gG)
Duration of bouncing	< 10 ms (typ. < 5 ms)
Endurance	
electrical comp.	$\geq 40 \times 10^3$ operating cycles
mechanical comp.	$\geq 1 \times 10^6$ operating cycles

Mechanical:

Frame size	45 mm
Device height	90 mm
Device width	17.5 mm (1 MU)
Mounting	quick fastening on DIN rail
Degree of protection installed device	IP20
Position of device in use	works in any position
Upper and lower terminals	lift terminals
Terminal capacity	
Contact and coil	0.5–10 mm ² one- or more wire 0.5–6 mm ² fine-wire with wire end sleeve
Temperature range	-20 °C to +45 °C
Total contact gap	> 5 mm / independent contacts
Contact material	does not contain cadmium

Accessories

Capacitor block Z-S/KO	1.5 μ F, 240 V AC
Group block Z-SC/GP	240 V AC

Dimensions [mm]

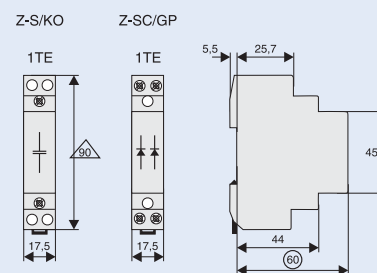
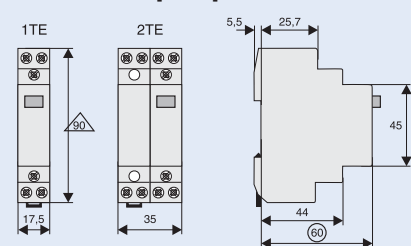

For types and art. numbers see page 55

Block Diagram for Central, Group, and Local Control

Example:

- Local control – room
- Group control - corridor
- Central control – whole building*)

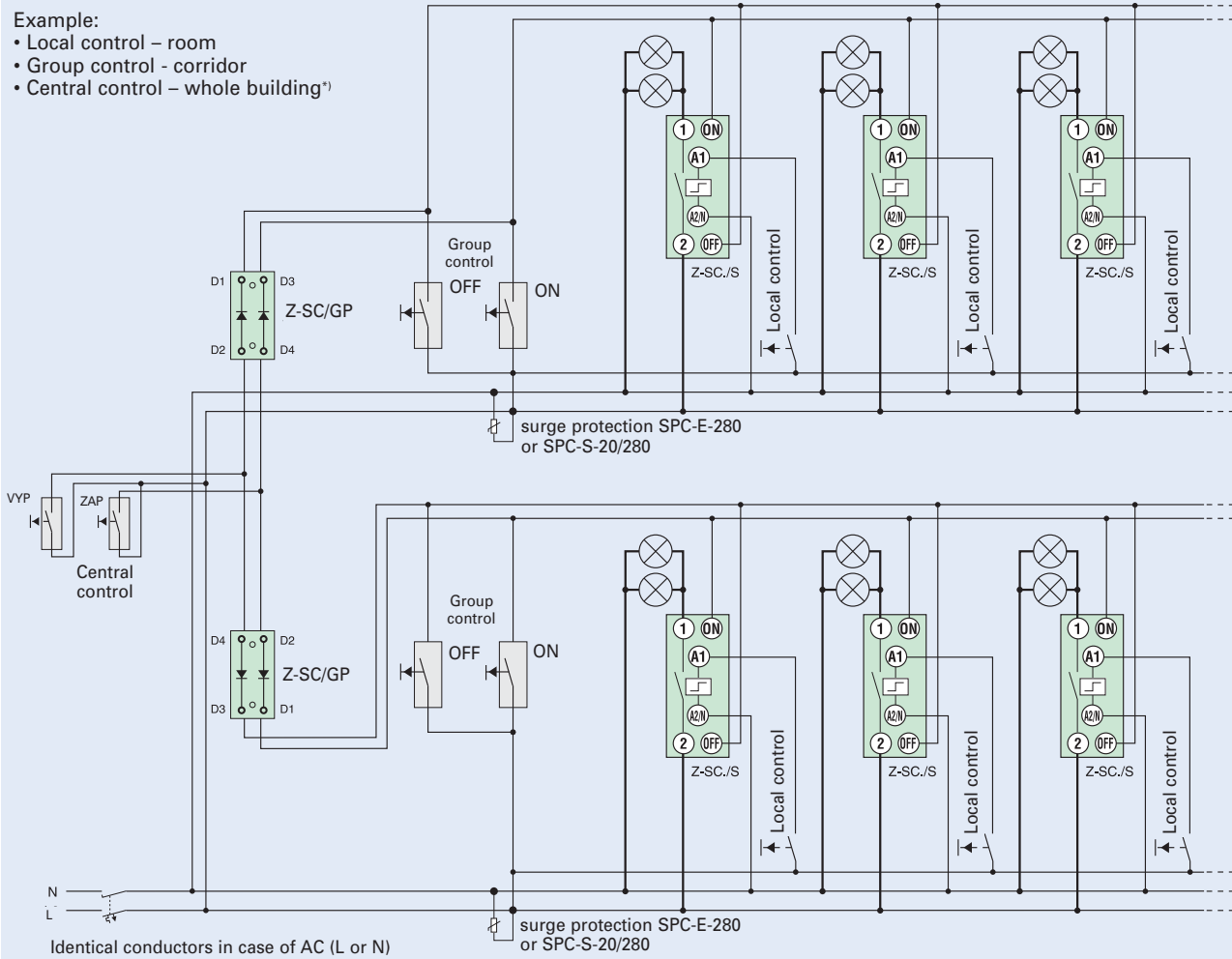

Identical conductors in case of AC (L or N)

*) Note:

Central control units Z-SC/GP are supplemented with diodes for preventing against mutual influence of particular groups (floors) among themselves.

Compensation by Means of Capacitor Block

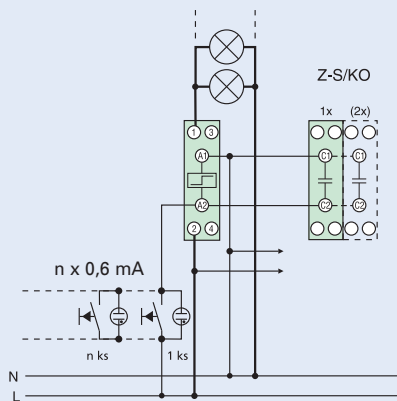

Note:

Glow lamps connected parallel to pushbuttons cause permanent current. This current can affect proper function of impulse relays negatively (break of contacts can not happen in case of more glow lamps connected). For this reason there can be compensator to lead-out unwanted current of glow lamps out from relay coil.

Impulse Relay with Switchable LED - application examples (1 to 4)

Signalisation LED Impulse relay Z-SB../SS Pushbutton ON/OFF Load

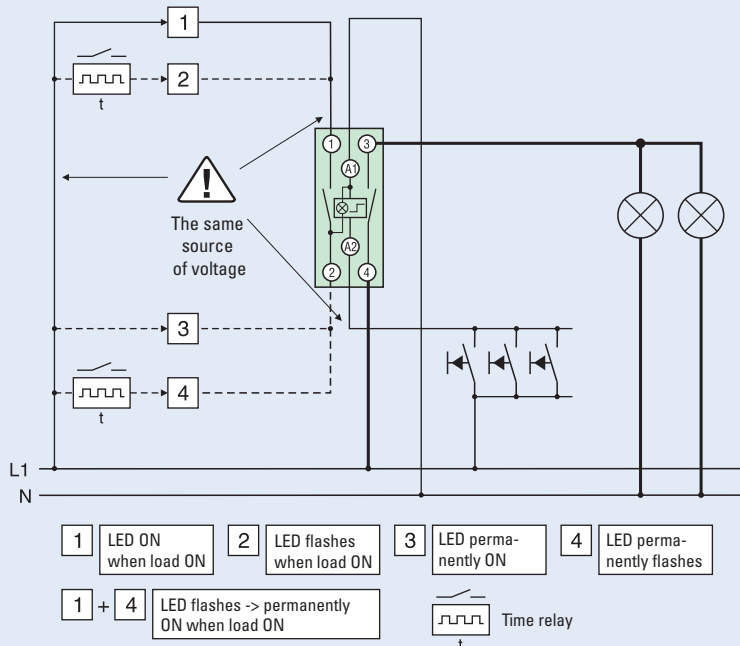

- 1 LED ON when load ON
- 2 LED flashes when load ON
- 3 LED permanently ON
- 4 LED permanently flashes

- 1 + 4 LED flashes -> permanently ON when load ON
- Time relay t

For types and art. numbers see page 55

Staircase Switch with switch-off warning and stop function TLE, TLK

- Automatic electronic staircase switch
- Switch-off warning can be switched off (type TLK)
- Subsequent switching is possible, programmable long-time function
- Power saving function, low switching noise
- Automatic 3-/4 wire circuit recognition
- Zero voltage safety thanks to memory function (type TLK)
- Central control function (type TLK)
- External voltage control input (type TLK)

Connection diagrams

e.g. 3 wire circuit TLE

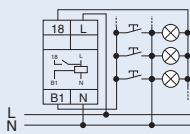

e.g. 4 wire circuit with attic lighting TLK

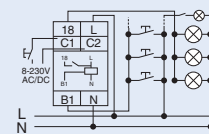

Technical Data

Electrical:

Feed voltage	230 VAC
Rated voltage tolerance	-15 %, +10 %
Power consumption	6 VA (0.8 W)
Rated frequency	48–63 Hz
Duty	100 %
Reset time	500 ms
Adjustment range	0.5–15 min.
Overvoltage category	III (in acc. with IEC 60664-1)
Rated surge voltage	4 kV

Output

Contact	1 NO (Terminals L-18)
Rated voltage	250 VAC
Constant current	16 A
Switch on peak current (20 ms)	80 A
Switching capacity AC	4000 VA / AC1, 384 W / DC
Maximum current	30 A / < 3s
Switching voltage	250 V AC1 / 24 V DC
Minimum switching capacity DC	500 mW
Output indication	yellow LED ()
Mechanical endurance	30 x 10 ⁶ switching operations
Electrical endurance (AC1)	10 x 10 ⁵ switching op. 16 A/250 V

Control input B1

Connection (carrying voltage)	Pushbutton T-N (3 wire circuit) Pushbutton T-L (4 wire circuit)
Glow lamps parallel to control keys	max. 100 mA
Overload protection	electronic

Control input C1-C2 (type TLK)

	8–230 V AC/DC
--	---------------

Mechanical:

Frame size	45 mm
Device height	87 mm
Device width	17.5 mm (1 MU)
Installation	quick fastening on DIN rail EN 60715
Protection class / Pollution degree	IP20 / 2
Terminal capacity	1x 0.5–4 mm ² 2x 0.5–2.5 mm ²
Tightening torque	max. 1 Nm
Temperature range	-25 °C to +55 °C
Operation position	any

Dimensions [mm]

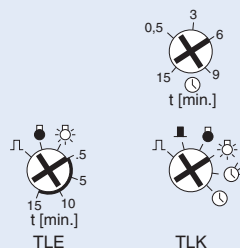
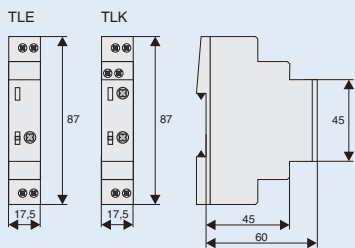

Mode

- Automatic timing
 - Automatic timing with switch-off warning
 - Permanent light
 - Off
 - Impulse relay
 - Impulse relay, zero-voltage proof
- 2000 W
 1000 W
 500 W
 max. 100 mA

Functional Description

Automatic timing

After pushing the button the output relay closes (terminals L-18) and the set time starts to run. If the button is pushed again before the time t has lapsed the time re-starts from zero (subsequent switching function in accordance with EN 60669-2-3). Repeated quick pressing of the pushbutton ("pumping") leads to the addition of 2, 3 or more time intervals up to 60 min. Pushing the button once for a long time (> 2 s) stops the running lighting period, and the relay switches off (power saving function).

In the function, the device generates short pulses (flickering) as a switch-off warning (according to DIN 18015-2), 15 s, 10 s, and 5 s prior to switching off.

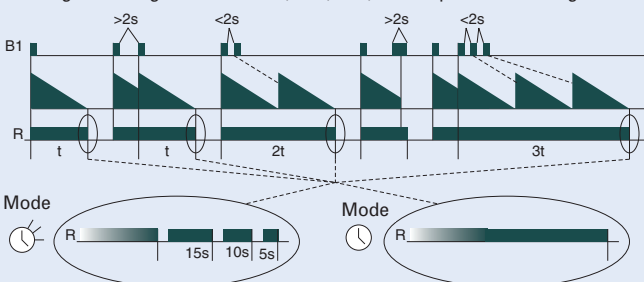

Impulse mode

In the impulse mode each push of the button makes the output relay switch over. In the function the output relay is always open after the feed voltage has been applied. In the function the relay immediately picks up when the feed voltage is applied provided that it was closed prior to the power failure. By applying a short voltage pulse (< 2 s) to the additional control input C1-C2 the relay R is switched on (central ON). A longer voltage pulse (> 2 s) causes the relay R to switch off (central OFF).

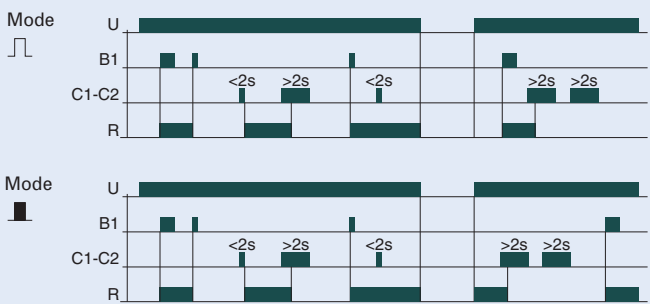

The additional control input permits activating the staircase switch e.g. from an intercom system by means of a voltage from 8 to 230 V AC/DC in the modes and . This input channel permits starting the lighting time, as well as subsequent switching. Switching off (power saving function) and programming of longer lighting periods ("pumping") is not possible via this input channel.

For types and art. numbers see page 56

Light Intensity Switch for support rail assembly, DS-TA, DS-TD

- Device for automatic control of lighting systems
- For outdoor installation
- Wall mounting IP55
- With integrated light sensor
- Brightness range infinitely adjustable
- Type DS-TA: can be combined with timers for time and light-dependent control
- Type DS-TA: with integrated timer
- With make and break-time delay
- Suitable for street lighting, yard or general outdoor lighting

Connection diagram

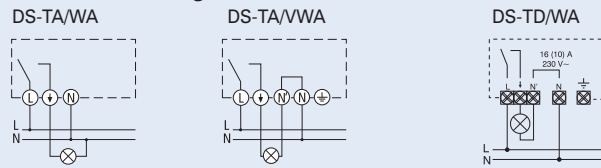

Technical Data

	DS-TA/WA	DS-TA/VWA	DS-TD/WA
General:			
Design according to	EN 60669-1, EN 60669-2-1		
Rated voltage	230 V AC/220V ~	230 V AC/220V ~	230 V AC/220V ~
Rated operating voltage tolerance	-10%...+10%	-10%...+10%	-10%...+10%
Rated frequency	50-60 Hz	50-60 Hz	50-60 Hz
Power consumption	3.5 VA	4.5 VA	2 VA
Brightness range	5 – 200 Lux	2 – 200 Lux	2 – 200 Lux, digital
Drive	-	-	Quartz
Power reserve at 20 °C	-	-	1,5 years
Type of battery	-	-	Lithium, replaceable
Operating cycles	40,000	40,000	40,000
Degree of protection	IP55	IP55	IP55
Ambient temperature	-35 °C...+55 °C	-35 °C...+55 °C	-35 °C...+55 °C
Storage temperature	-40 °C...+70 °C	-40 °C...+70 °C	-40 °C...+70 °C
Protection class - device	II	II	II
Switching contacts:			
Type of switching contact	1 x NO	1 x NO	1 x NO
Contact material	Ag Sn O ₂	Ag Sn O ₂	Ag Sn O ₂
Switching capacity at 250 V ~cosφ=1	10 A	16 A	16 A
Switching capacity at 250 V ~cosφ=0,6	6 A	10 A	10 A
Switching capacity with lamps			
Incandescent lamps	1000 W	2300 W	2300 W
Halogen lamps	1000 W	2300 W	2300 W
Fluorescent lamps			
Non-compensated	1000 VA	2300 VA	2300 VA
Compensated in parallel	120 VA (18 µF)	400 VA (42 µF)	400 VA (42 µF)
Lead-lag circuit - compensated in series	1000 W	2300 W	2300 W
Ballast - compensated	4 x 7W, 3 x 11W, 3 x 15W, 2 x 20W, 3 x 23W	9 x 7W, 7 x 11W, 7 x 15W, 7 x 20W, 7 x 23 W	9 x 7W, 7 x 11W, 7 x 15W, 7 x 20W, 7 x 23 W
Make-time delay	40 s	2-100 s	0-10 min, digital
Break-time delay	40 s	2-100 s	0-10 min, digital
Non-delayed switching status indication	LED	LED	LED
Programme features:			
Number of channels	1	1	1
Minimum switching time	-	-	1 min.
Programming via EEPROM or software	-	-	No
Automatic change of clock to summer/winter time	-	-	Yes
Random switching	-	-	No
LCD background light	-	-	No
Size & weight:			
Width	85 mm	85 mm	85 mm
Height	49.4 mm	49.4 mm	49.4 mm
Length	118.4 mm	118.4 mm	118.4 mm
Weight	202 g	247 g	320 g
Terminals:			
Terminal capacity - fine stranded wire	1...2.5 mm ²	1...2.5 mm ²	1...2.5 mm ²
Terminal capacity - solid wire	1...4 mm ²	1...4 mm ²	1...4 mm ²
Size of terminal screws	M3	M3	M3
Type of screw head	Slotted, size 1	Slotted, size 1	Slotted, size 1
Max. torque	0.5 Nm	0.5 Nm	0.5 Nm

For types and art. numbers see page 56

Dimensions (mm)

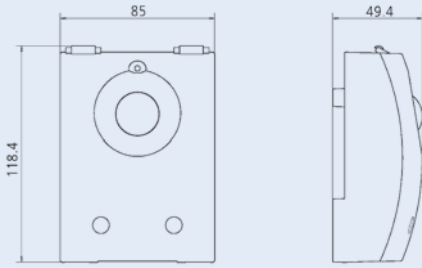

Light Intensity Switch for wall mounting, DS-TA, DS-TD

- Device for automatic control of lighting systems
- With external light sensor
- Brightness range infinitely adjustable
- Type DS-TA: can be combined with timers for time and light-dependent control
- Type DS-TD: with integrated timer for time and light-dependent control
- With make and break-time delay
- Supplied with light sensor IP65
- Spare sensors available

Connection diagrams

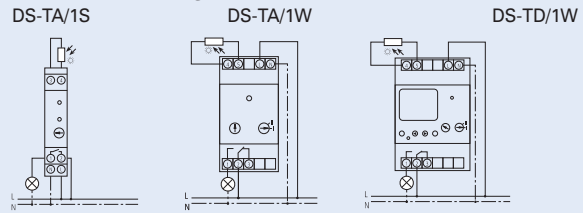

Technical Data

	DS-TA/1S	DS-TA/1W	DS-TD/1W
General:			
Design according to	EN 60669-1, EN 60669-2-1		
Rated voltage	220-240 V AC	230 V AC	230 V AC
Rated operating voltage tolerance	-15%...+10%	-10%...+10%	-10%...+10%
Rated frequency	50-60 Hz	50-60 Hz	50-60 Hz
Power consumption	approx. 6 VA	approx. 5 VA	approx. 5 VA
Brightness range	2 – 100 Lux	2 – 2000 Lux	2 – 2000 Lux, digital
Max. cable length for sensor	100 m	100 m	100 m
Drive	-	-	Quartz
Operating cycles	40,000	40,000	40,000
Degree of protection - control device	IP20	IP20	IP20
Degree of protection - sensor	IP54/IP65	IP54/IP65	IP54/IP65
Ambient temperature	-25 °C...+50 °C	-10 °C...+50 °C	-10 °C...+50 °C
Ambient temperature - sensor	-40 °C...+70 °C	-40 °C...+70 °C	-40 °C...+70 °C
Storage temperature	-25 °C...+50 °C	-25 °C...+50 °C	-25 °C...+50 °C
Storage temperature - sensor	-40 °C...+70 °C	-40 °C...+70 °C	-40 °C...+70 °C
Protection class - device	II	II	II
Protection class - sensor	II	III	III
Switching contacts:			
Type of switching contact	1 x NO	1 x CO	1 x CO
Contact material	Ag Sn O ₂	Ag Sn O ₂	Ag Sn O ₂
Switching capacity at 250 V~cosφ=1	16 A	10 A	10 A
Switching capacity at 250 V~cosφ=0,6	10 A	6 A	6 A
Switching capacity with lamps			
Incandescent lamps	2300 W	2300 W	2300 W
Halogen lamps	2300 W	2300 W	2300 W
Fluorescent lamps			
Non-compensated	2300 VA	2300 VA	2300 VA
Compensated in parallel	400 VA (42 µF)	400 VA (42 µF)	400 VA (42 µF)
Lead-lag circuit - compensated in series	2300 W	2300 W	2300 W
Ballast - compensated	4 x 7 W, 3 x 11 W, 3 x 15 W, 2 x 20 W, 3 x 23 W	9 x 7 W, 7 x 11 W, 7 x 15 W, 7 x 20 W, 7 x 23 W	9 x 7 W, 7 x 11 W, 7 x 15 W, 7 x 20 W, 7 x 23 W
Make-time delay	20 s	40 s	80 s
Break-time delay	80 s	40 s	80 s
Non-delayed switching status indication	LED	LED	LED
Programme features:			
Number of channels	1	1	1
Minimum switching time	-	-	1 min.
Max. programme steps in the memory	-	-	42
Programming via EEPROM or software	-	-	No
Automatic change of clock to summer/winter time	-	-	Yes
Random switching	-	-	Yes
LCD background light	-	-	No
Size & weight:			
Width	17.5 mm (1 MU)	52.5 mm (3 MU)	72 mm (4 MU)
Height	65.5 mm	65.5 mm	65.5 mm
Length	90 mm	90 mm	90 mm
Weight	172 g	330 g	330 g

For types and art. numbers see page 56

Technical Data

	DS-TA/1S	DS-TA/1W	DS-TD/1W
Terminals:			
Terminal capacity - fine stranded wire	1...2.5 mm ²	1...2.5 mm ²	1...2.5 mm ²
Terminal capacity - solid wire	1...4 mm ²	1...4 mm ²	1...4 mm ²
Size of terminal screws	M3	M3	M3
Type of screw head	PZ size 1	PZ size 1	PZ size 1
Max. torque	0.8 Nm	0.8 Nm	0.8 Nm

Dimensions (mm)

DS-TA/1S

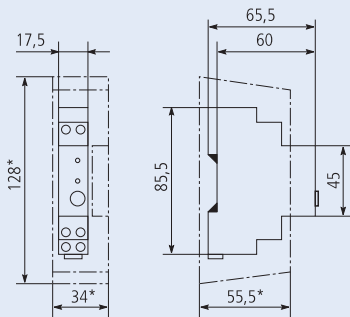

DS-TA/1W

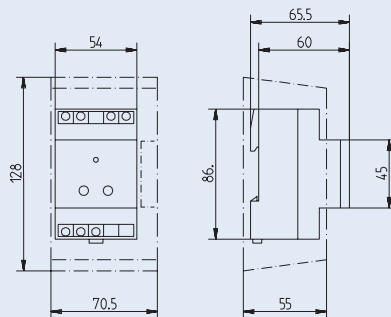

DS-TD/1W

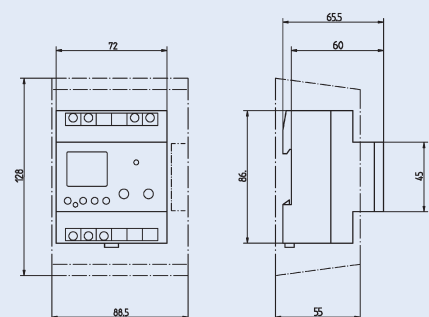

Bell Transformers TR-G

- Bell transformers with separate windings according to EN 61558
- Not for permanent duty

Connection diagrams

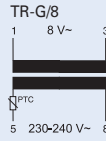

Technical Data

	TR-G/8	TR-G3/8	TR-G3/18	TR-G2/24
Electrical				
Rated output	8 VA	8 VA	18 VA	24 VA
Rated supply voltage range at terminals	230–240 V AC	230–240 V AC	230–240 V AC	230–240 V AC
Rated frequency	50 Hz	50 Hz	50 Hz	50 Hz
No-load current	25 mA	26 mA	36 mA	24 mA
Rated supply current	69 mA	58 mA	72/124/138 mA	155/160 mA
Primary resistance	616 Ω	667 Ω	229 Ω	616 Ω
Rated output voltage at terminals	8 V AC	4/8/12 V AC	4/8/12 V AC	12/24 V AC
No-load output voltage	13 V	4.9 / 12 / 16.8 V	5.9 / 12 / 17.8 V	16 / 31 V
Output voltage at rated output current	8.4 V	3.8 / 7.9 / 12.2 V	4.3 / 8.4 / 12.7 V	12.2 / 23.2 V
Secondary resistance	1 A	1–1–0.67 A	2–2–1.5 A	2–1 A
Power loss in no-load operation	2 Ω	0.9 / 1.9 / 2.8 Ω	0.4 / 1 / 1.3 Ω	1 / 3 Ω
Total power loss at nominal load	1.4 W	1.4 W	1.8 W	1.9 W
Short circuit proof	7.1 W	6.2 W	11.6 W	11.9 W
Test voltage (primary-secondary)	PTC	PTC	PTC	PTC
Pollution degree	5 kV	5 kV	5 kV	5 kV
	P2	P2	P2	P2
Mechanical				
Frame size	45 mm	45 mm	45 mm	45 mm
Device height	90 mm	90 mm	90 mm	90 mm
Device width	36 mm	36 mm	36 mm	54 mm
Weight	236 g	253 g	354 g	612 g
Mounting	quick fastening on DIN rail EN 60715			
Degree of protection, built-in	IP20	IP20	IP20	IP20
Upper and lower terminals	lift terminals	lift terminals	lift terminals	lift terminals
Terminal capacity	1 - 3 x 2.5 mm ²	1 - 3 x 2.5 mm ²	1 - 3 x 2.5 mm ²	1 - 3 x 2.5 mm ²
Tightening torque of terminal screws	0.5 Nm	0.5 Nm	0.5 Nm	0.5 Nm
Permitted relative humidity	< 95 %	< 95 %	< 95 %	< 95 %
Rated ambient temperature	40 °C	40 °C	40 °C	35 °C
Temperature rise at intermittent duty (20 x 1 min 100% a 5 min 20%)	24 K	24 K	26 K	31 K
Insulation class	E	E	E	E
Glow wire-test	850 °C	850 °C	850 °C	850 °C

Dimensions [mm]

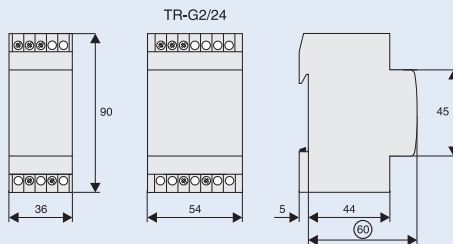

Practical Hint



Safety transformer



Bell transformer



Short circuit-proof transformer

For types and art. numbers see page 56



Safety Transformers TR-G./..-SF

- Safety transformers with separate windings according to EN 61558
- For permanent duty

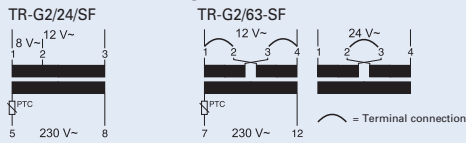
Connection diagrams



Technical Data

	TR-G2/24-SF	TR-G2/24-SF2	TR-G2/63-SF
Electrical:			
Rated output	24 VA	24 VA	63 VA
Rated supply voltage range at terminals	230–240 V AC 5–8	230–240 V AC 7–12	230–240 V AC 7–12
Rated frequency	50 Hz	50 Hz	50 Hz
No-load current	22 mA	58 mA	60 mA
Rated supply current	100/150 mA	140/135 mA	340 mA
Primary resistance	133 Ω	92 Ω	41 Ω
Rated output voltage at terminals	8/12 V AC 1–2/1–3	12/24 V AC 1–2/1–3	12/24 V AC 1–4/1–4
No-load output voltage	9.9/15.6 V	13.3/26.8 V	13.6/27.3 V
Output voltage at rated output current	8.2/12.3 V 2–2 A	11.6/23.8 V 2–1 A	12/24.1 V 5.2–2.6 A
Secondary resistance	0.5 / 0.75 Ω	0.45 / 0.95 Ω	0.15 / 0.6 Ω
Power loss in no-load operation	1.8 W	4.3 W	4.1 W
Total power loss at nominal load	10.4 W	6.3 W	19.6 W
Duty	100 %	100 %	100 %
Short circuit proof	PTC	PTC	PTC
Test voltage (primary-secondary)	5 kV	5 kV	5 kV
Pollution degree	P2	P2	P2
Mechanical:			
Frame size	45 mm	45 mm	45 mm
Device height	90 mm	90 mm	90 mm
Device width	54 mm	90 mm	90 mm
Weight	604 g	1087 g	1256 g
Mounting	quick fastening on DIN rail EN 60715		
Degree of protection, built-in	IP40	IP40	IP40
Upper and lower terminals	lift terminals	lift terminals	lift terminals
Terminal capacity	1–3 x 2.5 mm ²	1–3 x 2.5 mm ²	1–3 x 2.5 mm ²
Tightening torque of terminal screws	0.5 Nm	0.5 Nm	0.5 Nm
Permitted relative humidity	<95 %	<95 %	<95 %
Rated ambient temperature	25 °C	35 °C	25 °C
Temperature rise at uninterrupted duty	56 K	34 K	51 K
Insulation class	E	F	F
Glow wire-test	850 °C	850 °C	850 °C

Dimensions [mm]

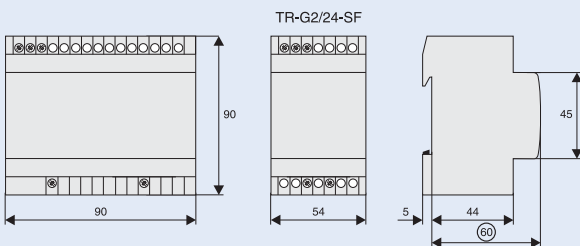

Practical Hint



Safety transformer



Bell transformer



Short circuit-proof transformer

For types and art. numbers see page 56

Installation Relays Z-R, Z-TN

Installation relays Z-R are suitable for switching 1-phase or 3-phase consumers in various applications:

- Switching lighting systems and electrical heating systems
 - Switching ventilation and air conditioning systems, fans
 - Switching heat pumps
 - Switching electrically controlled roller doors/gates, and blinds
- The installation relays of series Z-R meet the requirements of standards EN 60947. The installation relays of series Z-TN meet the requirements of standards EN 61095.

EN 60947 deals with "Electromagnetic contactors in electrical system manufacturing".
EN 61095 deals with "Electromechanical contactors for household and similar purposes." Compliance with this standard means meeting very high demands in terms of safety for humans and property.

Security:

- Optional optical operating status display by means of LED
- Switching position indicated on the front side by manual operating key
- All terminals - coil and contacts - equipped with guide for secure terminal connection. Misplacement of wires impossible.
- Made of hardly flammable materials and plastics free from chlorine and halogens
- Switching contacts with safe disconnection AC1 according to EN 0947-4-4 (Z-R, Z-RK)

Advantages:

- Available in three versions (Z-R, Z-RK, Z-RE)
 - Low switching noise, no humming
 - Easy to connect thanks to large terminals supplied open
 - Simple snap-on fastening on 35 mm DIN rail
 - High degree of flexibility thanks to a variety of contact configurations
 - Version with mechanical pre-selection of functions ON/AUTO/OFF (Z-TN)
- ON/permanently ON: Contact permanently ON until a control pulse is switched on and OFF again. Then, the relay reverts to the AUT position.
 AUT/AUTOMATIC: Standard relay function by control voltage at the coil. OFF/permanently OFF: Contacts permanently OFF, independently of the control voltage at the coil.

Connection diagrams

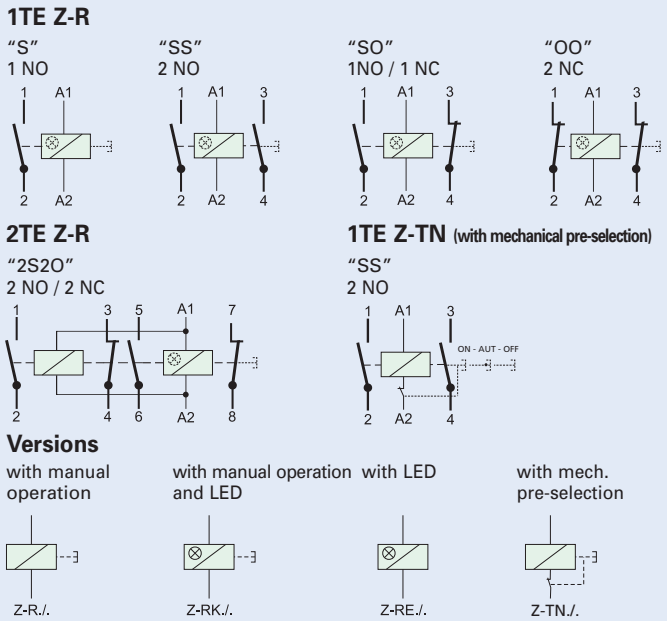

Permitted installation positions

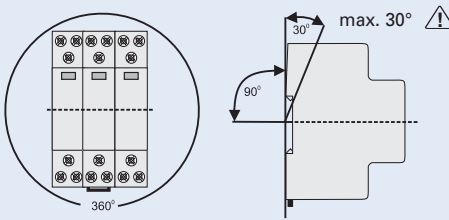

Packing density at full contact load

Z-R./ Z-TN./
 It is recommended to use spacer Z-DST (0.5 MU) in case of ambient temperature higher than 40 °C .

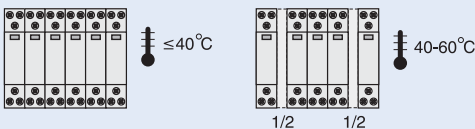

Technical Data:

Electrical:

Design according to	Z-R EN 60947 Z-TN EN 61095
Rated voltage	250 V, 240 / 415 V AC
Rated current	20 A, 250 V AC
Rated current AC1 I _e	20 A AC1 (Z-R, Z-RK)
Rated operational power P _e	4.6 kW 415 V
Number of poles	1 až 4
Main contacts	NO/NC
	1, 2 (1 MU) 3, 4 (2 MU)
EMR compatibility	B
Control Circuit	
Rated control feed voltage U _c	8, 12, 24, 230 V AC, 24 V DC
Rated frequency	50 Hz
Operating range	0.85–1.1 x U _c
Maximum power of coils	
pick-up	10–13 VA, 6–8 W
retaining	3.4–4.0 VA, 2.0–2.4 W
Minimum command duration	> 50 ms
Operating noise	no humming
Duty	100 %
Rated peak withstand voltage U _{imp}	2 kV (1.2/50 μs)

Load Circuit

Rated operational voltage U _n	250 V AC
Minimum operational voltage U _{min}	24 V AC / DC (U _c 8 - 110 V)
Rated insulation voltage U _i	500 V
Rated peak withstand voltage U _{imp}	4 kV (1.2/50 μs)
Conventional thermal current I _{th}	20 A AC
Rated operational current I _e	20 A AC
Rated constant current I _u	20 A AC
Rated current DC I _e	
24 V	16 A DC
48 V	12.5 A DC
230 V	1 A DC
Conditional rated short circuit current I _q	10 kA (with 20 A gL/gG)
Duration of bouncing	< 10 ms (typ. < 5 ms)

For types and art. numbers see page 57

Technical Data (continued)

UTILISATION CATEGORIES 1 MU (except 3S, 4S)

AC-1 $\square/\square/\square$ *)	
Rated operational voltage U_e	250 V AC
Rated operational current I_e	20 A AC
Rated operational power AC-1	4000 W ($\cos\varphi = 0.8$), 5000 VA
AC-3 \odot	
Rated operational voltage U_e	250 V AC
Rated operational current I_e	8 A AC
Rated operational power AC-3	900 W ($\cos\varphi = 0.45$), 2000 VA
AC-5a \otimes	
Rated operational voltage U_e	250 V AC
Rated operational current I_e	10 A AC
Rated operational power AC-5a	1125 W ($\cos\varphi = 0.45$), 2500 VA
AC-5b \otimes	
Rated operational voltage U_e	230 V AC
Rated operational current I_e	8.8 A AC
Rated operational power AC-5b	2024 W
AC-7a \blacksquare	
Rated operational voltage U_e	240 / 415 V AC
Rated operational current I_e	20 A AC
Rated operational power AC-7a	4000 W ($\cos\varphi = 0.8$), 5000 VA

UTILISATION CATEGORIES 2MU (3S, 4S)

AC-1 $\square/\square/\square$	
Rated operational voltage U_e	240/415 V AC
Rated operational current I_e	20 A AC
Rated operational power AC-1	4000 W ($\cos\varphi = 0.8$), 5000 VA
AC-3 \odot	
Rated operational voltage U_e	240/415 V AC
Rated operational current I_e	8 A AC
Rated operational power AC-3	900 W ($\cos\varphi = 0.45$), 2000 VA
AC-5a \otimes	
Rated operational voltage U_e	240/415 V AC
Rated operational current I_e	10 A AC
Rated operational power AC-5a	1125 W ($\cos\varphi = 0.45$), 2500 VA

AC-5b \otimes	
Rated operational voltage U_e	230/400 V AC
Rated operational current I_e	8.8 A AC
Rated operational power AC-5b	2024 W
AC-7a (dle EN 61095) \blacksquare	
Rated operational voltage U_e	240/415 V AC
Rated operational current I_e	20 A AC
Rated operational power AC-7a	4000 W ($\cos\varphi = 0.8$), 5000 VA
AC-7b (dle EN 61095) \odot	
Rated operational voltage U_e	240/415 V AC
Rated operational current I_e	10 A AC
Rated operational power AC-7b	1125 W ($\cos\varphi = 0.8$), 2500 VA

Endurance	electrical comp.	$\geq 40 \times 10^3$ operating cycles
	mechanical comp.	$\geq 1 \times 10^6$ operating cycles

Mechanical:

Frame size	45 mm
Device height	90 mm
Device width	17.5 mm (1 MU)
Mounting	quick fastening on DIN rail 35 mm
Degree of protection installed device	IP20
Mounting position	as required
Upper and lower terminals	lift terminals (captive)
Terminal capacity	
Contact and coil	0.5–10 mm ² one- or more wire 0.5–6 mm ² fine-wire with wire end sleeve
Temperature range	-20 °C to +45 °C
Total contact gap	> 5 mm / independent contacts
Contact material	does not contain cadmium

*)  Suitable for insulation, tested on AC-1

Dimensions [mm]

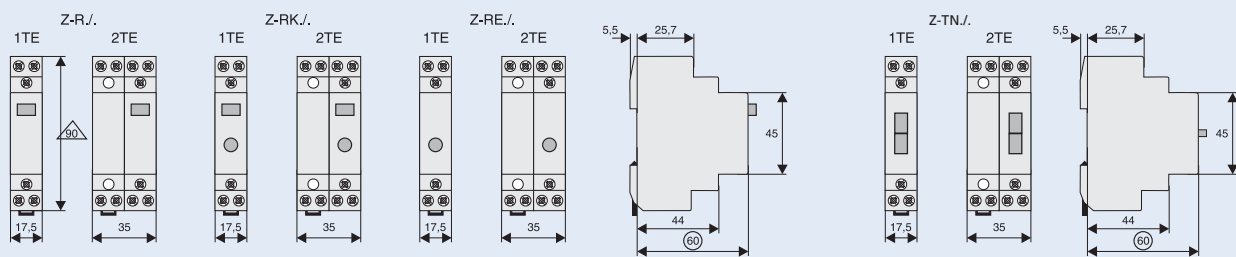

Installation Contactors Z-SCH

These switching devices have been designed and rated particularly for modular installation in modular distribution boxes for electrical installation or cabinets with device covers. The innovative technology of the electrical AC magnet system of these switching devices, permits reducing the switching noise and suppressing humming while ensuring reliability and high contact forces in modular devices requiring little space. Thanks to these characteristics, the application requirements on systems and equipment in offices and residential areas are fully met.

The installation contactors Z-SCH are suitable for switching 1-phase or 3-phase consumers up to 63 A. These devices for universal use in systems and installations for buildings permit implementation of the following applications and control functions:

- Switching of lighting systems
- Switching of electrical heating systems
- Switching of ventilation systems
- Switching of air conditioning systems and fans
- Switching of heat pumps
- Switching of electrically controlled (motor-operated) roller doors/gates, and blinds
- etc.

The installation contactors of series Z-SCH meet the requirements of standards EN 61095 and EN 60947.

EN 61 095 deals with "Electromechanical contactors for household and similar purposes." Compliance with this standard means meeting very high demands in terms of safety for humans and property.

EN 60 947 deals with "Electromagnetic contactors in electrical system manufacturing."

Safety:

- Finger and hand touch safe
- Front-side switch position indicator
- Hardly flammable materials and chlorine-free and halogen-free plastics are used

Advantages:

- Low switching noise
- No humming
- Easy to connect thanks to large terminals with captive connecting screws of type Pozidrive which are supplied open and equipped with a screwdriver guide for automatic wiring.
- Versions with different contacts configurations
- Simple snap-on fastening of 35 mm DIN rail EN 60715
- In devices with 25 ... 63 A, flexibility is further enhanced by clip-on auxiliary switch Z-SC (contacts 11), laterally to the right.
- Plenty of space and easy access for coil feed connection
- Power ratings of 25, 40, 63A AC1 to meet field requirements.

Connection diagrams Z-SCH

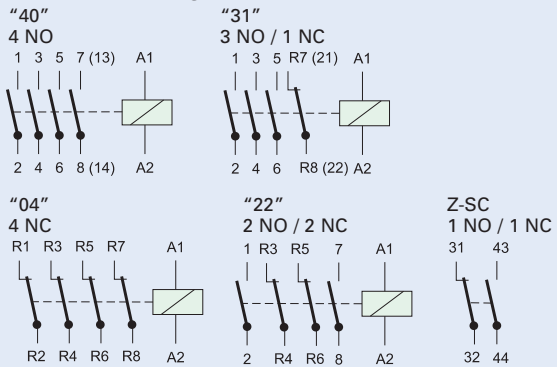

Permitted Installation Positions

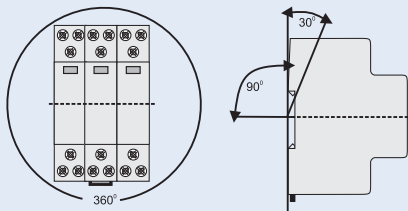

Packing Density at full contact load

Z-SCH

It is recommended to use spacer Z-DST (0.5 MU) in case of ambient temperature higher than 40 °C.

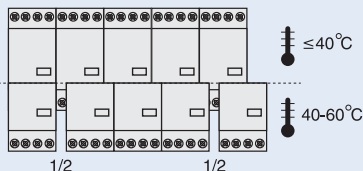

Dimensions [mm]

Z-SCH.../1/25 Z-SCH.../25 Z-SCH.../40, .../63

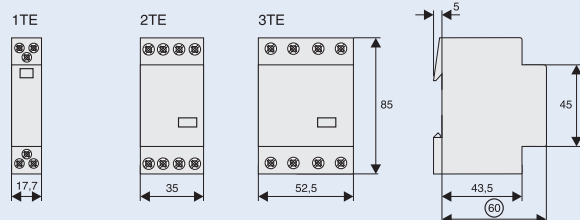

Z-SC

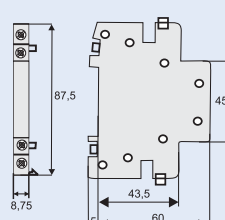

Technical Data of Installation Contactors Z-SCH

Values according to IEC 1095, EN 61095, VDE 0660, IEC 947-4-1, EN 60947-4-1, VDE			Z-SCH/25/..	Z-SCH/40/..	Z-SCH/63/..	Z-SC
Utilisation category AC-1 (e.g. heating system))						
Rated operational current $I_n (=I_{th})$ open	at 60 °C	A	25	40	63	-
Service life of switching element		$S \times 10^6$	0.1	0.1	0.1	-
Rated operational power AC-1	220–240 V	kW	9.5	16	25	-
	380–415 V	kW	17	27.5	43	-
Utilisation category AC-3 (Switching of 3-phase AC motors)						
Rated operational current I_n		A	9	27	30	-
Service life of switching element		$S \times 10^6$	0.15	0.15	0.15	-
Rated power of 3-phase AC motors 50-60 Hz	kW	2,2	7.5	8	-	-
	230–240 V	kW	2.5	8	8.5	-
	380–415 V	kW	4	12.5	15	-
Utilisation category DC-1 (Switching of resistive loads, $L/R \leq 15$ ms) values for make contacts						
1-pole	24 V DC	A	25	40	63	-
	48 V DC	A	22	25	26	-
	60 V DC	A	18	19	21	-
	110 V DC	A	5	7	8	-
	220 V DC	A	0.5	0.7	0.7	-
2-pole in series	24 V DC	A	25	40	63	-
	48 V DC	A	25	40	44	-
	60 V DC	A	25	33	36	-
	110 V DC	A	16	17	18	-
	220 V DC	A	4	5	6	-
3-pole in series	24 V DC	A	25	40	63	-
	48 V DC	A	25	40	63	-
	60 V DC	A	25	40	61	-
	110 V DC	A	25	31	34	-
	220 V DC	A	10	15	16	-
4-pole in series	24 V DC	A	25	40	63	-
	48 V DC	A	25	40	63	-
	60 V DC	A	25	40	63	-
	110 V DC	A	25	40	63	-
	220 V DC	A	15	20	21	-
Utilisation category DC-3 and DC-5 (Switching of inductive load, $L/R \leq 15$ ms) values for make contacts						
1-pole	24 V DC	A	15	23	25	-
	48 V DC	A	5	10	10	-
	60 V DC	A	4	5	5	-
	110 V DC	A	1	1.5	1.5	-
	220 V DC	A	0.1	0.3	0.3	-
2-pole in series	24 V DC	A	25	40	45	-
	48 V DC	A	17	23	25	-
	60 V DC	A	13	15	15	-
	110 V DC	A	5	5	5	-
	220 V DC	A	0.5	1	1	-
3-pole in series	24 V DC	A	25	40	63	-
	48 V DC	A	25	40	45	-
	60 V DC	A	25	30	30	-
	110 V DC	A	15	15	15	-
	220 V DC	A	3	4	4	-
4-pole in series	24 V DC	A	25	40	63	-
	48 V DC	A	25	40	63	-
	60 V DC	A	25	40	63	-
	110 V DC	A	25	40	45	-
	220 V DC	A	8	10	10	-
Main Switching Elements ($U_{imp} = 4$ kV)						
Rated insulation voltage U_i		V AC	440	440	440	440
Rated operational voltage U_e		V AC	440	440	440	440
Rated operational voltage	AC1, AC3	1 / h	300	600	600	600
Mechanical endurance		$S \times 10^6$	1	1	1	1
Auxiliary Switching Elements ($U_{imp} = 4$ kV)						
Rated insulation voltage U_i		V AC	440	440	440	440
Nominal thermal current = I_{th}	40 °C	A	25	40	63	10
	60 °C	A	25	40	63	6
Utilisation category AC-15 (Controlling of electromagnetic load)						
Rated operational current I_e	220–240 V	A	-	-	-	3
	380–415 V	A	-	-	-	2
	440 V	A	-	-	-	1.6
Utilisation category DC-13 (Controlling of electromagnetic load at DC)						
Rated operational current I_e per pole	24–60 V	A	-	-	-	2
	110 V	A	-	-	-	0.4
	220 V	A	-	-	-	0.1

For types and art. numbers see page 58

			Z-SCH/25/..	Z-SCH/40/..	Z-SCH/63/..	Z-SC	
Trip Coil Power 	Rated voltage of coils	V AC	24, 230	230	230	230	
	Switching on Holding	VA	14 - 18	33 - 45	33 - 45	-	
		VA	4.4 - 8.4	7	7	-	
		W	1.6 - 3.2	2.6	2.6	-	
	Operating range of trip coils						
	Coil voltage range (multiplication factor) U_g			0.85 - 1.1	0.85 - 1.1	0.85 - 1.1	-
	Pv Power loss per current path						
	Pvges. Power loss per device at nominal current load		W	2	3	7	0.5
		1-pole	W	5.2	5.6	5.6	-
		2-pole	W	7.2	8.6	16.6	-
3-pole		W	9.2	11.6	23.6	-	
	4-pole	W	11.2	14.6	30.6	-	
Switching noise (on and off) Typical mean values		dB	80	78	78	-	
Terminal capacity							
Main conductor	one or several wires	mm ²	1.5 - 10	2.5 - 25	2.5 - 25	0.5 - 2.5	
	fine wires	mm ²	1.5 - 6	2.5 - 16	2.5 - 16	0.5 - 2.5	
	fine wires with wire end	mm ²	1.5 - 6	2.5 - 16	2.5 - 16	0.5 - 1.5	
Coil	number of conductors per terminal		1	1	1	2	
	one or several wires	mm ²	0.75 - 2.5	0.75 - 2.5	0.75 - 2.5	-	
	fine wires	mm ²	0.5 - 2.5	0.5 - 2.5	0.5 - 2.5	-	
	fine wires with wire end sleeve	mm ²	0.5 - 1.5	0.5 - 1.5	0.5 - 1.5	-	
	number of conductors per terminal		1	1	1	-	
Weight		kg / unit	0.22	0.36	0.36	0.026	
Short circuit protection (main circuit) Maximum nominal current of fuse Co-ordination type 1		gL / gG	A	35	63	80	-
Short circuit protection (auxiliary circuit) Maximum nominal current of fuses Short-circuit current 1000 A, without fusing of contacts		gL / gG	A	-	-	-	10
Switching times at control voltage $U_g \pm 10\%$							
	Make delay	ms	9 - 15	11 - 15	11 - 15	-	
	Break delay	ms	4 - 8	6 - 13	6 - 13	-	
	Arc duration	ms	10 - 15	10 - 15	10 - 15	-	

Installation Contactors Z-SCH for Lighting Systems

The decisive factors are the type, connection and current consumption of lamps during switch-on and in permanent operation. Only 90 % of the continuous current of switching devices should be used in view of higher current consumption as a result of increases of voltage. The maximum number of lamps per phase that can be operated by a switching device is

dependent on the nominal current and making current of lamps on the one hand, and on the continuous current and making capacity of the switching devices on the other. Thus, e.g. in lead-lag circuits, the continuous current of contactors can be used, while this is not possible in fluorescent tubes with separate compensation.

			Z-SCH/25/..	Z-SCH/40/..	Z-SCH/63/..	Z-SC	
Utilisation category AC-1 resistive load	Rated operational current 60 °C	I_g for AC-1	A	25	40	63	-
	Making capacity:	Root mean square	A	200	360	480	-
		Peak value	A	280	510	680	-
Utilisation category AC-5a discharge lamps, fluorescent tubes	Rated operational power 220-240 V~ DUO	$\cos\varphi = 0,5$	kW	1.3	3.4	5.5	-
		$\cos\varphi = 0,9$	kW	1.2	3.1	5.1	-
			kW	3.7	6.3	10	-
Utilisation category AC-5b incandescent lamps 	Rated operational power 240 V~		kW	3	5,7	8	-

Incandescent Lamps

The incandescent lamp filament has a very low ohmic resistance when it is cold. Therefore, when switching on, there is a high peak current (up to $20 \times I_n$). When switching off, only the nominal current is switched off.

		Power	Current	Z-SCH/25/..	Z-SCH/40/..	Z-SCH/63/..	Z-SC
Utilisation category AC-5b		W	A	ks	ks	ks	
	Incandescent lamps	60	0.27	50	92	129	-
		100	0.45	30	55	77	-
		200	0.91	15	27	38	-
		300	1.36	10	19	26	-
		500	2.27	6	11	16	-
		1000	4.5	3	6	8	-
		Low voltage halogen lamps (12 ur 24 V) with transformer (with electronic transformer)	20	0,09	52	110	174
50	0.22		24	50	80	-	
75	0.33		16	35	54	-	
100	0.43		12	27	43	-	
150	0.65		9	19	29	-	
200	0.87		6	14	23	-	
300	1.30		4	9	14	-	

max. number of lamps per current path at 230 V, 50 Hz

Fluorescent Tubes, Mercury Arc Lamps

High- and low pressure discharge lamps with mercury vapour, with or without fluorescent-coated glass body are perfectly identical in their electrical behaviour.

In order to limit the operational current and pre-conduction current, and to achieve the initial peak voltage, reactance coils are used as ballast.

Capacitors are used for compensation of the resulting reactive current, which are either connected in series with the coil (lead-lag circuit) or parallel

to the mains (separate compensation, very rarely used now). The high making current in case of separate compensation (max. 30 x nominal current of the capacitor) which goes down quickly is usually attenuated considerably by the feed line.

Utilisation category AC-5a

Fluorescent tubes	Fluorescent lamps without comp. or with series comp.	$I = I_{eAC1} \times 0.5$
	Lead-lag circuit (2x..)	$I = I_{eAC1} \times 0.35$
	Fluorescent tubes parallelkomp	$I = I_{Peak} / 100$ (take into account compensation capacitor)
I / I_{Lampe} = number of connectable lamps per current path	Fluorescent tubes with electronic ballast	$I = I_{Peak} / 50$
	Mercury arc lamps,HD without compensation	$I = I_{eAC1} \times 0.5$
	Mercury arc lamps,HD with compensation	$I = I_{Peak} / 100$ (take into account compensation capacitor)

Utilisation category AC-5a

Lamp Types	Power W	Current A	Capacitor µF	max. number of lamps per current path at 230 V, 50 Hz				
				Z-SCH/25/..	Z-SCH/40/..	Z-SCH/63/..	Z-SC	
Fluorescent lamps without compensation or with series compensation	11	0.16	1.3	75	210	310	-	
	18	0.37	2.7	34	90	140	-	
	24	0.35	2.5	34	90	140	-	
	36	0.43	3.4	30	70	140	-	
	58	0.67	5.3	20	45	70	-	
	65	0.67	5.3	19	40	65	-	
	85	0.8	5.3	16	35	60	-	
	Fluorescent tubes lead-lag circuit	11	0.07	-	2 x 110	2 x 220	2 x 250	-
		18	0.11	-	2 x 55	2 x 130	2 x 200	-
		24	0.14	-	2 x 44	2 x 110	2 x 160	-
		36	0.22	-	2 x 33	2 x 70	2 x 100	-
		58	0.35	-	2 x 22	2 x 46	2 x 70	-
		65	0.35	-	2 x 16	2 x 40	2 x 60	-
	Fluorescent tubes with parallel comp.	85	0.47	-	2 x 11	2 x 30	2 x 40	-
		11	0.16	3.0	43	67	107	-
		18	0.37	4.0	32	50	80	-
		24	0.35	4.0	32	50	80	-
		36	0.43	4.0	32	50	80	-
58		0.67	7.0	18	36	46	-	
Fluorescent tubes with electronic ballast	65	0.67	7.0	18	36	46	-	
	85	0.8	8.0	16	33	44	-	
	18	0.09	-	40	100	150	-	
	36	0.16	-	20	50	75	-	
	58	0.25	-	15	30	55	-	
	80	0.4	-	10	20	30	-	
2 x 18	2 x 18	0.17	-	2 x 20	2 x 50	2 x 60	-	
	2 x 36	0.32	-	2 x 10	2 x 25	2 x 30	-	
	2 x 58	0.49	-	2 x 7	2 x 15	2 x 20	-	
Mercury arc lamps. high pressure without compensation e.g.: HQL, HPL	50	0.61	-	21	38	55	-	
	80	0.8	-	16	28	40	-	
	125	1.15	-	11	20	28	-	
	250	2.15	-	6	11	15	-	
	400	3.25	-	4	7	10	-	
	700	5.4	-	2	4	6	-	
	1000	7.5	-	1	3	4	-	
	Mercury arc lamps, high pressure with compensation e.g.: HQL, HPL	50	0.28	7	18	36	50	-
		80	0.41	8	16	31	44	-
		125	0.65	10	13	25	35	-
250		1.22	18	7	14	19	-	
400	1.95	25	5	10	14	-		
700	3.45	45	3	6	8	-		
1000	4.8	60	2	4	6	-		

Fluorescent lamps in DUO connection ($\cos \varphi = 1$)

Metal Halide Lamps

Metal halide lamps are a version of high-pressure mercury arc lamps with higher luminous efficiency and fidelity of colour (metalloids [halogens] added to the mercury fill up the Hg-spectrum with its many gaps). Ballast and ignition devices are necessary. Starting time 3 ... 5 minutes at $1.4 - 2 \times I_n$. After switching on, it is not possible to light the lamp again immediately (lamp extinguishes after a power cut-off

of only 1/2 period). Therefore, in many cases in important facilities ionisation of part of the lamps is maintained by switching over to 415 V, 500 Hz (e.g. to an emergency power supply). In this case, the lamp lights immediately after the mains voltage is on again. Otherwise, this would take several minutes. When using suitable ignition devices, the lamps can be lit again immediately.

I / I_{Lampe} = number of connectable lamps per current path	Metal halide lamps (HQI) without compensation	$I = I_{eAC1} \times 0,5$
	Metal halide lamps (HQI) with compensation	$I = I_{Peak} / 100$ (take into account compensation capacitor)
	Transformer for low voltage halogen lamps	$I = I_{Peak} / 50$

Lamp Types	Power W	Current A	Capacitor µF	max. number of lamps per current path at 230 V, 50 Hz			
				Z-SCH/25/..	Z-SCH/40/..	Z-SCH/63/..	Z-SC
Metal halide lamps without compensation e.g. HQI, HPI	35	0.53	-	28	57	-	-
	70	1	-	15	30	-	-
	150	1.8	-	8	17	-	-
	250	3	-	5	10	-	-
	400	3.5	-	4	8	-	-
	1000	9.5	-	1	3	-	-
	2000	16.5	-	-	2	-	-
	400 V per Pol	2000	10.5	-	-	2	-
		3500	18	-	-	1	-
Metal halide lamps with electronic ballast HQI	20	0.1	-	9	18	20	-
	35	0.2	-	6	11	13	-
	70	0.36	-	5	12	12	-
	150	0.7	-	4	10	10	-
Metal halide lamps with compensation e.g. HQI, HPI	35	0.25	6	21	42	58	-
	70	0.45	12	11	21	29	-
	150	0.75	20	4	13	18	-
	250	1.5	33	4	9	11	-
	400	2.1	35	1	9	10	-
	1000	5.8	95	-	3	4	-
	2000	11.5	148	-	2	2	-
	400 V per Pol	2000	6.6	58	-	3	4
		3500	11.6	100	-	2	3
Transformers for low-voltage halogen lamps	20	-	-	52	110	174	-
	50	-	-	24	50	80	-
	75	-	-	16	35	54	-
	100	-	-	12	27	43	-
	150	-	-	9	19	29	-
	200	-	-	5	14	23	-
	300	-	-	4	9	14	-

Sodium Vapour Lamps

For 200 W, 1200 mm high-pressure lamps and low-pressure lamps, reactance coils are used as ballast. For smaller lamps, stray field transformers can be used as ballast. Take into account, the long starting period.

Low pressure lamps:

Without compens.: Making curr. $1 \times X I_g$, $\cos\varphi = 0.3$; starting time 5 .. 10 min
Decisive for selection of device: 60 % continuous current
 $I = I_{eAC1} \times 0.6$

With compensation: Making curr.: $20 \times X I_g$, $\cos\varphi = 0.45$; starting time 5 .. 10 min
(at $1.6 \times I_n$), $I = I_{Peak} / 200$

High pressure lamps:

Without compens.: Making curr. $1.4 \times X I_g$, $\cos\varphi = 0.5$;
starting time 5 .. 10 min
Decisive for selection of device: 60 % continuous current
 $I = I_{eAC1} \times 0.6$

With compensation: Making curr.: $20 \times X I_g$, $\cos\varphi = 0.95$; starting time 5 .. 10 min
(at $1.6 \times I_n$)

Note: number of lamps

	Power W	Current A	Capacitor µF	max. number of lamps per current path at 230 V, 50 Hz			
				Z-SCH/25/..	Z-SCH/40/..	Z-SCH/63/..	Z-SC
Sodium vapour lamps low-pressure without compensation	35	1.5	-	9	22	30	-
	55	1.5	-	9	22	30	-
	90	2.4	-	6	13	19	-
	135	3.3	-	4	10	14	-
	150	3.3	-	4	10	14	-
	180	3.3	-	4	10	14	-
	200	3.3	-	4	10	14	-
Sodium vapour lamps low-pressure with compensation	35	0.31	20	6	15	18	-
	55	0.42	20	4	15	18	-
	90	0.63	30	4	10	12	-
	135	0.94	45	3	7	8	-
	150	1	40	3	8	9	-
	180	1.16	40	3	8	9	-
	200	1.32	30	-	10	12	-
Sodium vapour lamps high-pressure without compensation	150	1.8	-	8	15	22	-
	250	3	-	5	10	13	-
	330	3.7	-	4	8	10	-
	400	4.7	-	3	6	8	-
	1000	10.3	-	1	3	4	-
Sodium vapour lamps high pressure with compensation	150	0.83	20	7	20	25	-
	250	1.5	33	4	12	15	-
	330	2	40	3	10	13	-
	400	2.4	48	2	8	12	-
	1000	6.3	106	1	4	6	-

For types and art. numbers see page 58

Utilisation Categories of Contactors

Type of current	Utilisation category	Typical Applications I = Making current, I _c = Breaking current, I _e = Rated operational current, U = Voltage, U _e = Rated operational voltage U _r = Recovery voltage	Verification of electrical service life						Verification of switching capacity								
			Switching on			Switching off			Switching on			Switching off					
			$\frac{I}{I_e}$ [A]	$\frac{U}{U_e}$	cosφ	$\frac{I_c}{I_e}$	$\frac{U_r}{U_e}$	cosφ	$\frac{I}{I_e}$ [A]	$\frac{U}{U_e}$	cosφ	$\frac{I_c}{I_e}$	$\frac{U_r}{U_e}$	cosφ			
AC	AC-1	Non-inductive or slightly inductive load, Resistance furnaces	all values	1	1	0.95	1	1	0.95	all values	1.5	1.05	0.8	1.5	1.05	0.8	
	AC-2	Slip ring motors: starting, switching off	all values	2.5	1	0.65	2.5	1	0.65	all values	4	1.05	0.65	4	1.05	0.8	
	AC-3	Squirrel cage motors: starting, switching off, running motors ⁴⁾	$I_e \leq 17$ $I_e > 17$	6	1	0.65	1	0.17	0.65	$I_e \leq 100$ $I_e > 100$	10	1.05	0.45	8	1.05	0.45	
	AC-4	Squirrel cage motors: starting, plugging reversing, inching	$I_e \leq 17$ $I_e > 17$	6	1	0.65	6	1	0.65	$I_e \leq 100$ $I_e > 100$	12	1.05	0.45	10	1.05	0.45	
	AC-5a AC-5b	Switching of electric discharge lamp controls Switching of incandescent lamps								3.0 1.5 ²⁾	1.05	0.45	3.0 1.05 ²⁾	1.05	0.45	1.05 ²⁾	
	AC-6a ³⁾ AC-6b ³⁾	Switching of transformers Switching of capacitor banks															
	AC-7a	Slightly inductive loads in household appliances and similar applications	according to manufacturer specifications							1.5	1.05	0.8	1.5	1.05	0.8		
	AC-7b	Motor loads for household appliances								8.0	1.05	¹⁾	8.0	1.05	¹⁾		
	AC-8a	Switching of hermetically enclosed refrigerant compressor motors with manual reset of overload releases ⁵⁾								6.0	1.05	¹⁾	6.0	1.05	¹⁾		
	AC-8b	Switching of hermetically enclosed refrigerant compressor motors with automatic reset of overload releases ⁵⁾								6.0	1.05	¹⁾	6.0	1.05	¹⁾		
DC	DC-1	Non-inductive or slightly inductive load, Resistance furnaces	all values	1	1	1	1	1	1	all values	1.5	1.05	1	1.5	1.05	1	
	DC-3	Shunt motors: starting, plugging, reversing, inching, dynamic braking	all values	2.5	1	2	2.5	1	2	all values	4	1.05	2.5	4	1.05	2.5	
	DC-5	Series motors: starting, plugging, reversing, inching, dynamic braking	all values	2	1	7.5	2.5	1	7.5	all values	4	1.05	2.5	4	1.05	2.5	
	DC-6	Switching of incandescent lamps								1.5 ²⁾	1.05	²⁾	1.5 ²⁾	1.05	²⁾		

according to IEC 947-4-1, EN 60 947, VDE 0660 Part 102

¹⁾ cosφ = 0.45 for I_e ≤ 100 A; cosφ = 0.35 for I_e ≤ 100 A.

²⁾ The tests must be carried out with an incandescent lamp load connected.

³⁾ In this case, the test data must be derived from the test values for AC-3 or AC-4 according to a special table.

⁴⁾ Devices for utilisation category AC-3 may be used for occasional inching or plugging during a limited period, such as for setting up a machine. However, during this limited period of time, the number of operations must not exceed five per minute or ten in a ten minute period.

⁵⁾ Hermetically enclosed refrigerant compressor motor means a combination of a compressor and a motor both of which are housed in the same enclosure with no external shaft or shaft seals, the motor running in the refrigerant.

Utilisation Categories of Auxiliary Switches

Type of current	Utilisation category	Typical Applications I = Making current, I _c = Breaking current, I _e = Rated operational current, U = Voltage, U _e = Rated operational voltage U _r = Recovery voltage t _{0,95} = the time in ms until 95% of the stationary current has been reached P = U _e × I _e = Rated power in Wattsh	Normal conditions of use						Divergent conditions of use					
			Switching on			Switching off			Switching on			Switching off		
			$\frac{I}{I_e}$	$\frac{U}{U_e}$	cosφ	$\frac{I}{I_e}$	$\frac{U}{U_e}$	cosφ	$\frac{I}{I_e}$	$\frac{U}{U_e}$	cosφ	$\frac{I}{I_e}$	$\frac{U}{U_e}$	cosφ
AC	AC-12	Control of resistive and solid state loads in optocoupler input circuits	1	1	0.9	1	1	0.9	-	-	-	-	-	-
	AC-13	Control of solid state loads with transformerisolation	2	1	0.65	1	1	0.65	10	1.1	0.65	1.1	1.1	0.65
	AC-14	Control of small electromagnetic loads (max. 72 VA)	6	1	0.3	1	1	0.3	6	1.1	0.7	6	1.1	0.7
	AC-15	Control of electromagnetic loads (above 72 VA)	10	1	0.3	1	1	0.3	10	1.1	0.3	10	1.1	0.3
DC	DC-12	Control of resistive and solid state loads in optocoupler input circuits	1	1	1 ms	1	1	1 ms	-	-	-	-	-	-
	DC-13	Control of electromagnets	1	1	6xP ¹⁾	1	1	6xP ¹⁾	1.1	1.1	6xP ¹⁾	1.1	1.1	6xP ¹⁾
	DC-14	Control of electromagnetic loads with economy resistors in the circuit	10	1	15 ms	1	1	15 ms	10	1.1	15 ms	10	1.1	15 ms

according to IEC 947-4-1, EN 60 947, VDE 0660 Part 102

¹⁾ The value „6xP“ is the result of an empirical relationship which is found to represent most direct current magnetic loads up to an upper limit of P = 50 W with 6 [ms]/[W] = 200 [ms]. Loads with a rated power above 50 W are composed of small loads located parallel to each other. Therefore, 300 ms is an upper limit independent of the power rating.

Relay for low-level signals

The electronic relay is a universal switching device designed especially for transmitting small or low-level signals of electronic control systems. The **RELLVA** has been designed to switch low-level signals. The relay can be energized through analogue control signals of a roller-shutter or heating control, for example. The switching contact allows to switch a binary signal for digital inputs, for example of a programmable controller, of a control relay (e.g. EASY control relay) or of a Z-CC Communication Centre.

The **REHLVA** in turn can switch higher loads of up to 5 A 250 V AC1. It can be energized through a binary signal of a digital output, for example. The switching contact can switch electrical consumers of up to 5 A 250 V AC1, but it can also be used for energizing contactors, for example.

The **REMLVA** is a combination of the relays mentioned above. One relay is equipped with the switching contact for low-level signals, the other one with the switching contact for higher loads up to 5 A 250 V AC1.

The multi-functional coil, which can be energized in a range from 24 V to 250 V AC and DC, covers a wide variety of applications. In addition, all types have two relays for separate energizing in one enclosure of 1 MU width.

- Electronic switching relay
- 2 relays for separate energizing in one enclosure of 1 MU width
- Switching of very small signals from 10mV / 1µA
- Universal control voltage range from 24 to 230 V AC/DC
- Switching of higher loads of up to 5 A 250 V AC AC1
- 1 change-over contact for each relay with switch position indication by LED
- Railway service qualification tested

Connection diagram

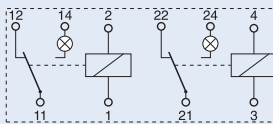

Technical Data

Electrical:

Standard according	EN 61810
Number of poles	2x1
EMC – Environment	EN 61000-4-2, 61000-4-4, 61000-4-5, 61810-5

Control circuit:

Rated voltage U_s	24-250 V AC/DC
Rated frequency	0-50 Hz
Operating range	0.90-1.1 x U_s
Minimum command duration	0.1 s
Rated peak withstand voltage U_{imp}	4 kV (1.2/50 µs)
Duty	100%
Trip coil power	
switching on	0.1/24V; 1/250V VA/W
holding	0.1/24V; 1/250V VA/W

Load Circuit, Main Contacts

Change over	2 (to be energized separately)
Rated operational voltage U_e / Rated operational current I_e	
RELLVA	30 V DC / 2 A 220 V DC / 0.3 A
REHLVA	250 V AC / 5 A 30 V DC / 5 A 300 V DC / 0.25 A

REMLVA	
Switching contact 11/12/14	30 V DC / 2 A 220 V DC / 0.3 A 250 V AC / 5 A
Switching contact 21/22/24	30 V DC / 5 A 300 V DC / 0.25 A

Minimum operational voltage U_{min} / Minimum operational current I_{min}	
RELLVA	10 mV / 10 µA
REHLVA	100 mV / 10 mA

REMLVA	
Switching contact 11/12/14	10 mV / 10 µA
Switching contact 21/22/24	100 mV / 10 mA
Rated insulation voltage U_i	500 V DC
Rated peak withstand voltage U_{imp}	1.5 kV between open contacts; 2.5 kV between contacts and coil

Mechanical:

Frame size	45 mm
Device height	70 mm
Device width	17.8 mm (1 MU)
Mounting	quick fastening on DIN rail EN 60715
Degree of protection installed device	IP20
Mounting position	as required
Shock resistance	max. 750 m/s ²
Terminal capacity	1x 2.5 mm ² (flexible) 1x 4 mm ² (rigid) 2x 1.5 mm ² (rigid)
Temperature range	-40 to +85 °C

Dimensions [mm]

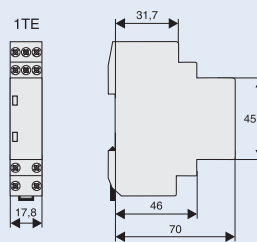

Examples

RELLVA

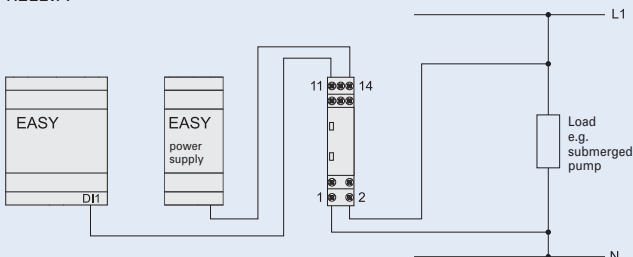

REHLVA

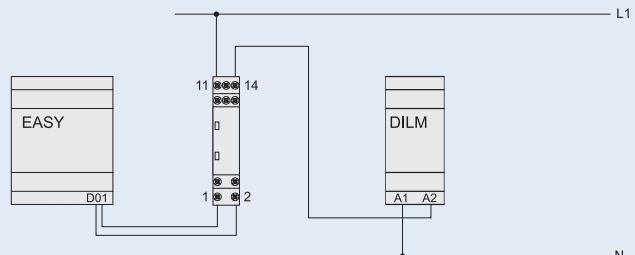

For types and art. numbers see page 58

Astronomical, digital Timer SA-TD/1W

- Digital timer in CMOS-technology
- Microprocessor and quartz control
- Programming by means of multi-function keys
- LCD display
- Programme data saved in case of power failure
- Optionally in each programme impulse time (switching interval 1-99 s) or fixed switching time (shortest switching interval 1 min) are possible
- Direct manual switching of relay ON/OFF
- Manual switching of relay to permanent operation ON/OFF (holiday operation)
- Automatic change to summer/winter time
- Automatic leap year adjustment
- Terminal covers which can be sealed with leads available as accessories

Block Diagram

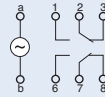

Technical Data

SA-TD/1W

General:

Design according to	EN 60730-1, EN 60730-2-7
Rated voltage	230-240 V AC
Rated voltage tolerance	-15%...+10%
Rated frequency	50-60 Hz
Power consumption	max. 6 VA
Drive	Quartz
Accuracy at 20 °C	1 s/day
Power reserve at 20 °C	10 years
Type of battery	Li
Operating cycles	> 40,000
Degree of protection	IP20
Ambient temperature	-30 °C...+55 °C
Storage temperature	-30 °C...+55 °C
Protection class (acc. to EN 60 730-1) upon installation	II

Switching contacts:

Type of switching contact	1 x change-over contact
Contact material	Ag Sn O ₂
Switching capacity at 250 V~cosφ=1	16 A
Switching capacity at 250 V~cosφ=0.6	10 A

Programme features:

Switching period	Week
Number of channels	1
Min. switching time	1 min.
Max. programme steps in the memory	732

Size & Weight:

Width	36 mm (2 MU)
Height	65.5 mm
Length	90 mm
Weight	170 g

Terminals:

Terminal capacity - fine stranded wire	1...2.5 mm ²
Terminal capacity - solid wire	1...4 mm ²
Size of terminal screw	M3.5
Type of screw head	PZ size 1
Max. torque	0.8 Nm

Dimensions [mm]

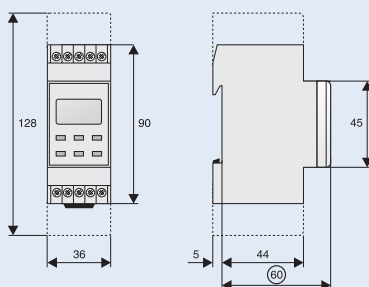

For types and art. numbers see page 59

Analogue Timers SU-T

- Programming by means of switching slides
- Synchronous drive with accuracy given by net system frequency accuracy, without power reserve
- Quartz system with accuracy of quartz oscillator, with power reserve

Block Diagram

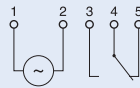

Technical Data

	SU-TS/TA	SU-TS/1W-TA	SU-TS/WO	SU-TQ/TA	SU-TQ/1W-TA, -WO	SU-TQ/2W-TW
General:						
Design according to	EN 60669-1, EN 60669-2-1					
Rated voltage	230 V AC ± 10%	230 V AC ± 10%	230 V AC ± 10%	230 V AC ± 10%	230 V AC ± 10%	230 V AC ± 10%
Rated frequency	50 Hz	50 Hz	50 Hz	50 Hz	50 Hz	50 Hz
Power consumption	max. 2.5 VA	max. 2.5 VA	max. 2.5 VA	max. 2.5 VA	max. 2.5 VA	max. 2.5 VA
Drive	Mains	Mains	Mains	Quartz	Quartz	Quartz
Accuracy at 20°C	-	-	-	≤ ± 1 s/day	≤ ± 1 s/day	≤ ± 1 s/day
Power reserve at 20°C	-	-	-	> 3 days	> 3 days	> 3 days
Type of battery	-	-	-	NiMH	NiMH	NiMH
Operating cycles	> 10 000	> 10 000	> 10 000	> 10 000	> 10 000	> 10 000
Degree of protection	IP20	IP20	IP20	IP20	IP20	IP20
Ambient temperature	-25 °C...+50 °C	-20 °C...+50 °C	-10 °C...+50 °C	-10 °C...+50 °C	-20 °C...+50 °C	-20 °C...+50 °C
Storage temperature	-25 °C...+50 °C	-20 °C...+50 °C	-10 °C...+50 °C	-10 °C...+50 °C	-20 °C...+50 °C	-20 °C...+50 °C
Protection class	II	II	II	II	II	II
Switching contacts:						
Type of switching cont.	1 x NO	1 x CO	1 x NO	1 x NO	1 x CO	1 x CO
Contact material	Solid silver	Solid silver	Solid silver	Solid silver	Solid silver	Solid silver
Switching capacity						
at 250 V~cosφ=1	16 A	16 A	16 A	16 A	16 A	16 A
at 250 V~cosφ=0,6	4 A	4 A	4 A	4 A	4 A	4 A
Programme features						
Switching period	Day	Day	Week	Day	Day, Week	Week
Number of channels	1	1	1	1	1	2
Shortest switching interval	15 min.	15 min.	30 min.	2 hours	15 min.	30 min., 4 hours
Max. programme steps						
- in the memory	96	48	84	96	48	32/day
Size & Weight:						
Width	17.5 mm (1 MU)	52.5 mm (3 MU)	17.5 mm (1 MU)	17.5 mm (1 MU)	52.5 mm (3 MU)	52.5 mm (3 MU)
Height	65.5 mm	65.5 mm	65.5 mm	65.5 mm	65.5 mm	66.5 mm
Length	90 mm	90 mm	90 mm	90 mm	90 mm	90 mm
Weight	80 g	164 g	90 g	80 g	170 g, 172 g	175 g
Terminals:						
Terminal capacity						
fine stranded wire	1...2.5 mm ²	1...2.5 mm ²	1...2.5 mm ²	1...2.5 mm ²	1...2.5 mm ²	1...2.5 mm ²
solid wire	1...4 mm ²	1...4 mm ²	1...4 mm ²	1...4 mm ²	1...4 mm ²	1...4 mm ²
Size of terminal screws	M3.5	M3.5	M3.5	M3.5	M3.5	M3.5
Type of screw head	PZ size 1	PZ size 1	PZ size 1	PZ size 1	PZ size 1	PZ size 1
Max. torque	2 Nm	2 Nm	2 Nm	2 Nm	2 Nm 2	Nm

Dimensions [mm]

SU-TS/TA, SU-TS/WO, SU-TQ/TA

SU-TS/1W-TA, SU-TQ/1W-TA, SU-TQ/1W-WO, SU-TQ/2W-TW

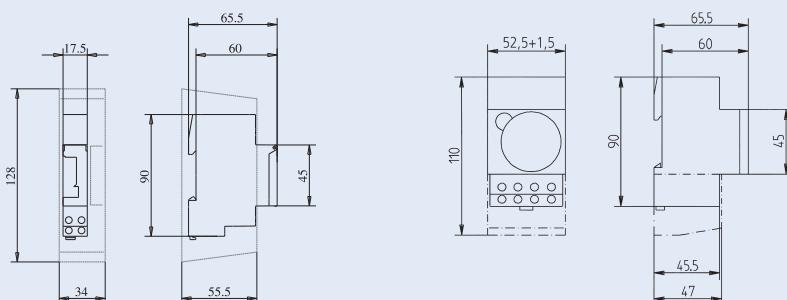

For types and art. numbers see page 59

Digital Timers Z-SDM

- Digital timers in CMOS-technology
- Microprocessor and quartz control
- Programming by means of multi-function keys
- LCD display
- Program data saved in case of power failure
- Optionally in each program impulse time (switching interval 1-99 s) or fixed switching time (shortest switching interval 1 min) are possible
- Direct manual switching of relay ON/OFF
- Manual switching of relay to permanent operation ON/OFF (holiday operation)
- Automatic change to summer/winter time
- Automatic leap year adjustment
- Design according to EN 60730

Block Diagram *)

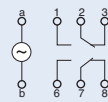

*) Actual connection diagram is given on each device.

Technical Data

	Z-SDM/1K-TA	Z-SDM/1K-WO	Z-SDM/2K-WO
Electrical:			
Rated voltage	230 V AC	230 V AC	230 V AC
Rated frequency	50/60 Hz	50/60 Hz	50/60 Hz
Current consumption	29 mA, $\cos \varphi = 0.13$	29 mA, $\cos \varphi = 0.13$	29 mA, $\cos \varphi = 0.13$
Apparent power	6.6 VA	6.6 VA	6.6 VA
Reactive power	-6.5 VAr	-6.5 VAr	-6.5 VAr
Power loss	0.9 W	0.9 W	0.9 W
Switching contact (potential-free)	1 CO	1 CO	2 CO
Rated insulation voltage	250 V	250 V	250 V
Switching capacity			
Rated current	16 A (μ *)	16 A (μ)	16 A (μ)
Resistive load	3000 W, $\cos \varphi = 1$	3000 W, $\cos \varphi = 1$	3000 W, $\cos \varphi = 1$
Incandescent lamp load	1000 W, $\cos \varphi = 1$	1000 W, $\cos \varphi = 1$	1000 W, $\cos \varphi = 1$
Inductive load	2 A/250 V AC $\cos \varphi = 0.6$	2 A/250 V AC $\cos \varphi = 0.6$	2 A/250 V AC $\cos \varphi = 0.6$
Power reserve	250 h	250 h	250 h
Power reserve storage	NiMH-Aku	NiMH-Aku	NiMH-Aku
Data saved by	EEPROM	EEPROM	EEPROM
Accuracy at 20 °C	approx. 1 s per day	approx. 1 s per day	approx. 1 s per day
Switching accuracy	1 s	1 s	1 s
Quartz frequency	32.768 MHz	32.768 MHz	32.768 MHz
Switching pairs freely programmable	20/day	20/week	20/week
Switching interval	1 min. or 1 s	1 min. or 1 s	1 min. or 1 s
Mechanical:			
Frame size	45 mm	45 mm	45 mm
Device height	90 mm	90 mm	90 mm
Device width	36 mm	36 mm	36 mm
Weight	170 g	170 g	200 g
Mounting	quick fastening on DIN rail EN 60715		
Degree of protection, built-in	IP20	IP20	IP20
Upper and lower terminals	lift terminals	lift terminals	lift terminals
Terminal capacity			
one-wire	1.5–4 mm ²	1.5–4 mm ²	1.5–4 mm ²
fine wire	1–2.5 mm ²	1–2.5 mm ²	1–2.5 mm ²
Tightening torque of terminal screws	0.8 Nm	0.8 Nm	0.8 Nm
Permitted relative humidity	< 95 %	< 95 %	< 95 %
Perm. ambient temperature range	0 to +55 °C	0 to +55 °C	0 to +55 °C
Flame class acc. to EN 60730	D	D	D

Dimensions [mm]

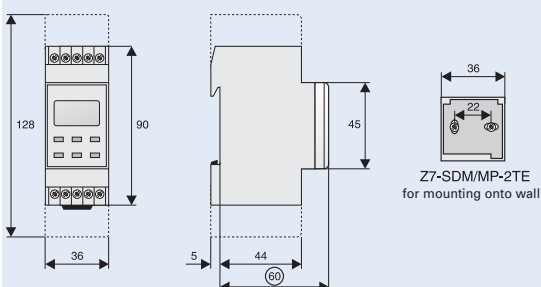

Note: symbols of switching devices

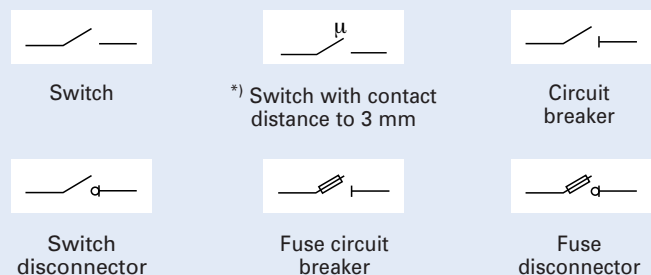

For types and art. numbers see page 59

Analogue Measuring Instruments Z-MG

- Analogue ammeters and voltmeters
- For measuring single-phase AC voltages and currents
- Direct measuring range up to 40 A (AC)
- Type Z-MG/AA5-WS with exchangeable dial for transducer operation up to 600 A
- Exchangeable dial (Z-MG/WS...)
- Moving iron measuring unit
- Accessories: Voltmeter changeover switch, see type Z-DSV

Block Diagram

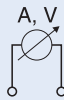

Technical Data

	Z-MG/AA-10	Z-MG/AA-40	Z-MG/AA5-WS	Z-MG/VA-250	Z-MG/VA-500
Electrical:					
Rated voltage U_n	–	–	–	250 V AC	500 V AC
Rated current I_n	10 A	40 A	5 A	–	–
Input signal	symmetric, sinusoidal, form factor 1.11				
Rated frequency	50 Hz	50 Hz	50 Hz	50 Hz	50 Hz
Operational frequency	45–65 Hz	45–65 Hz	45–65 Hz	45–65 Hz	45–65 Hz
Measuring accuracy class	1.5	1.5	1.5	1.5	1.5
Measuring range	0 - I_n	0 - I_n	0 - I_n	0 - U_n	0 - U_n
Power consumption	<1.1 VA	<1.1 VA	<1.1 VA	<3 VA	<3 VA
Exceeding of measuring range					
permanently	$1.2 \times I_n$	$1.2 \times I_n$	$1.2 \times I_n$	$1.2 \times U_n$	$1.2 \times U_n$
short time	$10 \times I_n/5 \text{ s}$	$10 \times I_n/5 \text{ s}$	$10 \times I_n/5 \text{ s}$	$2 \times U_n/5 \text{ s}$	$2 \times U_n/5 \text{ s}$
Rated insulation voltage	0.6 kV	0.6 kV	0.6 kV	0.6 kV	0.6 kV
Test voltage 50 Hz/1 min.	2 kV	2 kV	2 kV	2 kV	2 kV
Mechanical:					
Frame size	45 mm	45 mm	45 mm	45 mm	45 mm
Device height	89 mm	89 mm	89 mm	89 mm	89 mm
Device width	70 mm	70 mm	70 mm	70 mm	70 mm
Weight	130 g	130 g	130 g	130 g	130 g
Mounting	quick fastening on DIN rail EN 60715				
Degree of protection, built-in	IP50	IP50	IP50	IP50	IP50
Upper and lower terminals	lift terminals				
Terminal capacity	4 mm ²	8 mm ²	4 mm ²	4 mm ²	4 mm ²
Tightening torque of terminal screws	1 Nm	1,8 Nm	1 Nm	1 Nm	1 Nm
Permitted relative humidity	65 %	65 %	65 %	65 %	65 %
Perm. ambient temperature range	-25 to +50 °C	-25 to +50 °C	-25 to +50 °C	-25 to +50 °C	-25 to +50 °C
Flame class acc. to UL 94	V1	V1	V1	V1	V1

Dimensions [mm]

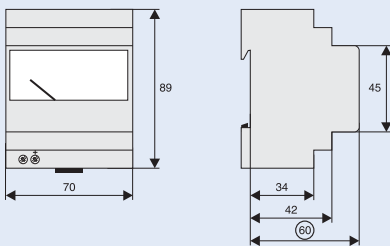

Digital Measuring Instruments Z-MG

- Digital ammeters and voltmeters
- For measuring single-phase AC voltages and currents
- 7 segment display, green LEDs
- LED overload display
- Direct measuring range up to 20 A (Z-MG/AD-20)
Via current transformer X/5A (Z-MG/AD-999) display up to 999 A.
- Type Z-MG/AD-999: Possible current transformer ratios 15/5, 20/5, 25/5, 40/5, 60/5, 100/5, 150/5, 200/5, 250/5, 400/5, 600/5, 1000/5 A adjustable
(For underlined ratios current transformers Z7-MG/WAK or Z7-MG/WAS can be used)
- Accessories: Voltmeter changeover switch, see type Z-DSV

Connection diagram

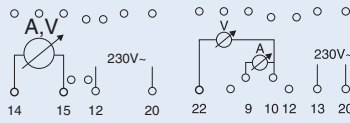

Technical Data

	Z-MG/AD-20	Z-MG/AD-999	Z-MG/VD-600	Z-MG/VD+AD	Z-MG/VD+AD+S
Electrical:					
Rated voltage U_n	–	–	600 V AC	500 V AC	500 V AC
Rated current I_n	20 A	5 A	–	5 A	5 A
Auxiliary voltage	230 V, 50 Hz	230 V, 50 Hz	230 V, 50 Hz	230 V, 50 Hz	230 V, 50 Hz
Power consumption auxiliary voltage	< 4.5 VA	< 4.5 VA	< 4.5 VA	< 2.5 VA	< 2.5 VA
Rated frequency	50 Hz	50 Hz	50 Hz	50 Hz	50 Hz
Operational frequency	45–65 Hz	45–65 Hz	45–65 Hz	47–63 Hz	47–63 Hz
Measuring accuracy	±1 % +1 digit	±1 % +1 digit	±1 % +1 digit	±1 % +1 digit	±1 % +1 digit
Resolution	1 digit	1 digit	1 digit	1 V / 0.01–10A	1 V / 0.01–10A
Number of measuring operations per second	3	3	3	0.67	0.67
Measuring range	0– I_n	0– I_n	0– U_n	0–600V/0.1–6A	0–600V/0.1–6A
Power consumption					
Voltage input	–	–	–	≤ 0.1 VA	≤ 0.1 VA
Current input	< 1.1 VA	< 1.1 VA	–	≤ 0.6 VA	≤ 0.6 VA
Input impedance	–	–	>1 MΩ	–	–
Exceeding of measuring range					
permanently	2 x I_n	2 x I_n	1.1 x U_n	1.2 x U_n / 1.2 x I_n	1.2 x U_n / 1.2 x I_n
short time	2.5 x I_n /5 s	10 x I_n /5 s	–	2 x I_n /5 s	2 x I_n /5 s
Rated insulation voltage	0.66 kV	0.66 kV	0.66 kV	0.66 kV	0.66 kV
Test voltage 50 Hz/1 min.	2 kV	2 kV	2 kV	3 kV	3 kV
Contact (alarms) 2 pcs.	–	–	–	–	programmable
Type	–	–	–	–	min. and/or max.
Set point	–	–	–	–	0-120 %
Hysteresis	–	–	–	–	0-set point
Delay	–	–	–	–	0-60 s (1 s steps)
Relay state	–	–	–	–	energised/de-energ.
Contacts range	–	–	–	–	5 A / 250 V AC
Mechanical:					
Frame size	45 mm	45 mm	45 mm	45 mm	45 mm
Device height	89.5 mm	89.5 mm	89.5 mm	89.5 mm	89.5 mm
Device width	71.2 mm	71.2 mm	71.2 mm	71.2 mm	71.2 mm
Maximum display reading	999	999	999	999	999
Height of figures	14 mm	14 mm	14 mm	14 mm	14 mm
Weight	300 g	300 g	300 g	250 g	270 g
Mounting	quick fastening on DIN rail EN 60715				
Degree of protection, built-in	IP20	IP20	IP20	IP20	IP20
Upper and lower terminals	lift terminals	lift terminals	lift terminals	lift terminals	lift terminals
Terminal capacity	4 mm ²	4 mm ²	4 mm ²	4 mm ²	4 mm ²
Tightening torque of terminal screws	0.6 Nm	0.6 Nm	0.6 Nm	0.6 Nm	0.6 Nm
Permitted relative humidity	95 %	95 %	95 %	20–80 %	20–80 %
Perm. ambient temperature range	-10 °C to +55 °C	-10 °C to +55 °C	-10 °C to +55 °C	-5 °C to +55 °C	-5 °C to +55 °C
Flame class acc. to UL 94	V1	V1	V1	V1	V1

Dimensions [mm]

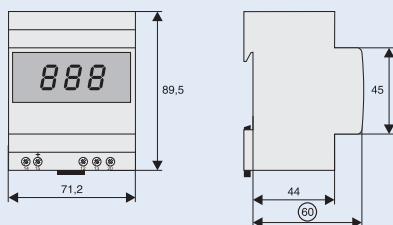

For types and art. numbers see page 60

Measuring range - resolution

Z-MG/VD+AD Z-MG/VD+AD+S	Range										5A 5.00 10mA		
	10A	15A	20A	25A	30A	40A	50A	60A	70A	75A	80A	50A	60A
Display	10.0	15.0	20.0	25.0	30.0	40.0	50.0	60.0	70.0	75.0	80.0	50.0	60.0
Resolution	100mA	100mA	100mA	100mA	100mA	100mA	100mA	100mA	100mA	100mA	100mA	100mA	100mA
Resolution	100A	120A	150A	160A	200A	250A	300A	400A	500A	600A	700A	750A	800A
Display	100	120	150	160	200	250	300	400	500	600	700	750	800
Resolution	1kA	1,2kA	1,5kA	1,6kA	2kA	2,5kA	3kA	4kA	5kA	6kA	7kA	7,5kA	8kA
Display	1.00	1.20	1.50	1.60	2.00	2.50	3.00	4.00	5.00	6.00	7.00	7.50	8.00
Resolution	10A	10A	10A	10A	10A	10A	10A	10A	10A	10A	10A	10A	10A

Accessories for Measuring Instruments

Current Transformer for Cable Z-MG/WAK, Current Transformer for Busbar Z-MG/WAS

- Transform high currents to standard measuring currents
- Current transformers help to cut costs when installing and connecting busbar system
- Recommended from 40 A upward
- Accuracy classes
Class 0.5: for accurate measurement and calibrated kWh-meters
Class 1: for general measurement and non-calibrated kWh-meters
Class 3: for coarse measurement, relays and for protection
- When winding several turns of the primary cable around the current transformer, you will receive half the primary current per turn while power and class remain unchanged.

Connection diagram

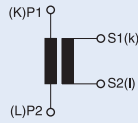

Technical Data

	Z-MG/WAK		Z-MG/WAS	
Electrical:				
Max. service voltage	720 V		720 V	
Secondary current	5 A		5 A	
Rated frequency	50 – 60 Hz		50 – 60 Hz	
Cable diameter	21 mm		23 mm, 30 mm	
Busbar cross section	–		30 x 10 mm, 40 x 10 mm, 50 x 12 mm	
	Class	P [VA]	Class	P [VA]
Primary nominal current I _{pN} 40 A	3	1.3		
50 A	3	1.5		
60 A	3	1.5		
80 A	3	2		
100 A			1	1.5
150 A			1	3
200 A			1	3
250 A			0.5	2
300 A			0.5	2
400 A			0.5	3
500 A			0.5	10
600 A			0.5	10
800 A			0.5	10
1000 A			0.5	10
Connections	P1 (K) primary input, P2 (L) primary output, s1 (k) secondary input, s2 (l) secondary output			
Nominal thermic short-time current I _{th}	60 x I _{pn} for 1 s		60 x I _{pn} for 1 s	
Nominal dynamic short circuit current I _{dyn}	2.5 x I _{th} for 1 s		2.5 x I _{th} for 1 s	
Permanent overload	1.2 x I _{pn}		1.2 x I _{pn}	
Insulation class (IEC 85)	E		E	
Test voltage 50 Hz/1 min.	6 kV		6 kV	
Mechanical:				
Weight	300 g		300 g	
Mounting	quick fastening on DIN rail EN 60715, wall mounting,		directly onto the cable or onto busbar	
Degree of protection	IP30		IP30	
Secondary connection	plug-in 6.3 mm		plug-in 6.3 mm	
Maximum tightening torque of screw terminals	1.9 Nm			
Permitted relative humidity	80 %		80 %	
Perm. ambient temperature range	-20 to +50 °C		-20 to +50 °C	
Max. temperature of busbars	–		70 °C	

Dimensions [mm]

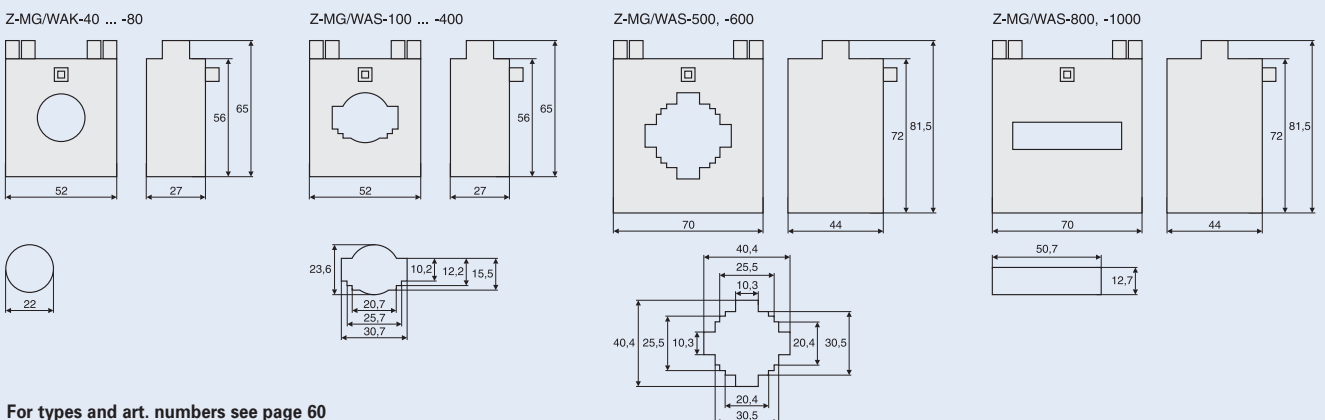

For types and art. numbers see page 60

Power Meter KWZ

- Power meter according to EN 61036 for sub-measurement
- For active energy
- **Type KWZ-230:** single-phase kWh-meter
- Possibility of remote consumption reading with e.g. impulse counter Z-IMZ/24

Connection diagram

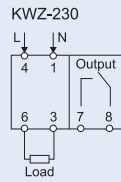

Technical Data

KWZ-230

Electrical:

Rated voltage U_n	230 V AC
Working range	0.9 - 1.2 x U_n
Rated current I_n	10 A, direct
Maximum current I_{max}	40 A
Rated frequency	50/60 Hz
Auxiliary voltage	from measurement
Power loss	2 W
Input signal	sinusoidal
Power factor	$\cos\varphi = 0,5$ inductive to $\cos\varphi = 0,8$ capacitive
Accuracy class	1
Resolution	0.1 kWh
LED signal	640 pulse/kWh
Own consumption per phase	<8 VA
Pulse output rated values	5–48 V DC, 50 mA
Pulse value (jumper)	10 pulse / kWh
Switching contact (potential-free)	1 NO
Rated peak withstand voltage (1.2/50) μ s	5 kV
Test voltage 50 Hz/1 min.	2.5 kV

Mechanical:

Frame size	45 mm
Device height	90 mm
Device width	35 mm (2 MU)
Weight	180 g
Display	5 + 1 digit
Maximum display reading	99999,9 kWh
Height of figures	4 mm
Mounting	quick fastening on DIN rail
Degree of protection, built-in	IP20
Upper and lower terminals	lift terminals
Terminal capacity	12 mm ² (2,5 mm ² pulse-outp.)
Tightening torque of terminal screws	2 Nm
Permitted relative humidity	90 %
Perm. ambient temperature range	-5 to +55 °C

Dimensions [mm]

KWZ-230

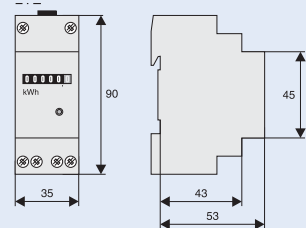

For types and art. numbers see page 61

Power Meter KWZ-3PH

- Energy meters for active energy measuring
- With digital display
- 3-phase version
- Rated voltage 230/400 V
- Accuracy class 1
- Programming by front keyboard, 2 keys
- Energy meter according to EN 62053 for sub-measurement
- Sealability front frame and terminal

Connection diagram

KWZ-3PH

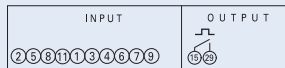

KWZ-3PH-63

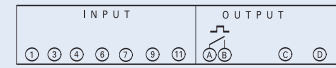

Technical Data

	KWZ-3PH	KWZ-3PH-63
Electrical		
Rated voltage U_n	230-240/400-415 V AC	230-240/400-415 V AC
Working range	110-254/190-440 V AC	110-254/190-440 V AC
Rated current I_b	1 a 5 A	10 A
Maximum current I_{max}	6 A	63 A
Maximum back-up fuse	10A gG/gL / B10 (only voltage pathes)	63A gG/gL / C63
Rated frequency	50 a 60 Hz	50 a 60 Hz
Frequency range	47-63 Hz	47-63 Hz
Power consumption per phase (current path)	≤ 0.5 VA – each phase	≤ 4 VA – each phase
Overload short time	20 x I_{max} / 0.5 s	30 x I_{max} / 10 ms
Auxiliary voltage	from measurement	from measurement
Input signal	sinusoidal	sinusoidal
Accuracy class	1	1
Metering LED	1 imp / 0,1 Wh	1 imp / Wh
Pulse output S0		
Max. load of transistor output	max. 110 V AC/DC, 50 mA	max. 110 V AC/DC, 50 mA
Meets requirements	DIN 43864 / EN 62053-31	DIN 43864 / EN 62053-31
Pulse frequency (selectable)	1 imp. / 10Wh-100Wh-1kWh-10kWh nebo 1 imp. / 10VArh-100VArh- 1kVArh-10kVArh	1 imp. / 1Wh-10Wh--100Wh1kWh-10kWh nebo 1 imp. / 10VArh-100VArh- 1kVArh-10kVArh
Pulse duration (selectable)	50-100-150-200-300-400-500 ms	50-100-150-200-300-400-500 ms
Programmable parameters	connection (1-phase, 3-phases 3- or 4-wire), external VT and CT-ratio, power demand, pulse output	connection (3-phases 3- or 4-wire), counting, power demand, pulse output
Overvoltage category	III	III
Insulation voltage rating (phase - phase)	450 V	300 V
Rated impulse withstand voltage (1.2/50) μ s	5 kV	5 kV
Test voltage		
Input/pulse-output	2.75 kV	2.75 kV
all circuits and earth	4 kV	4 kV
Protection class	II	II
Mechanical		
Frame size	45 mm	45 mm
Device height	89 mm	89 mm
Device width	71.2 mm	71.2 mm
Weight	260 g	260 g
Display	LCD 8 digit	LCD 8 digit
Digit height	6 mm	6 mm
Maximum display	setable	999999,99 kWh
Resolution	setable	10 W
Measurement display	subdivided on 6 pages	subdivided on 7 pages
Mounting	quick fastening on DIN rail EN 60715	
Degree of protection, front frame / terminals	IP52 / IP20	IP52 / IP20
Upper and lower terminals	screw terminals	screw terminals
Terminal capacity		
Current terminal	rigid cable 0.05-4 mm ² flexible cable 0.05-2.5 mm ²	input: rigid cable 1-10 mm ² flexible cable 1-13 mm ²
Voltage terminal	rigid cable 0.05-4 mm ² flexible cable 0.05-2.5 mm ²	output: rigid cable 1-4 mm ² flexible cable 1-3 mm ²
Permitted relative air humidity	suitable for tropical dissipation	suitable for tropical dissipation
Reference temperature	23 °C ±2 °C	23 °C ±2 °C
Perm. ambient temperature range		
Operating	-5 to +55 °C	-5 to +55 °C
Storing	-25 to +70 °C	-25 to +70 °C
Pollution degree	2	2

For types and art. numbers see page 61

Dimensions [mm]

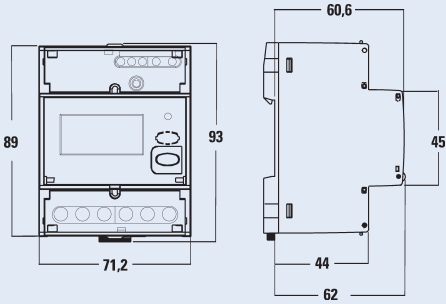

Wiring diagrams KWZ-3PH

1-phase

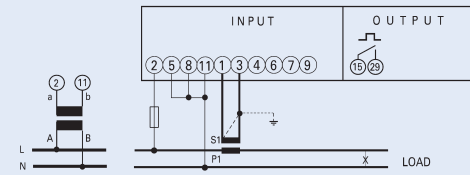

3-phases 3-wires balanced

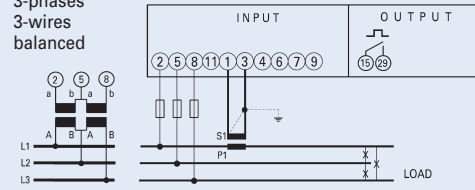

3-phases 3-wires unbalanced

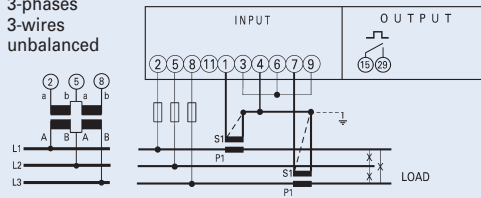

3-phases 3-wires unbalanced

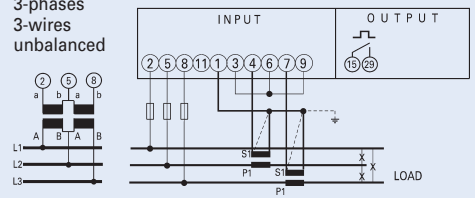

3-phases 3-wires unbalanced

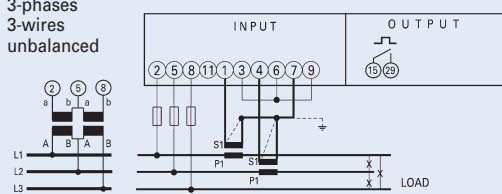

3-phases 3-wires unbalanced

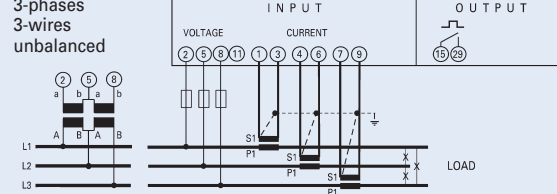

3-phases 4-wires unbalanced

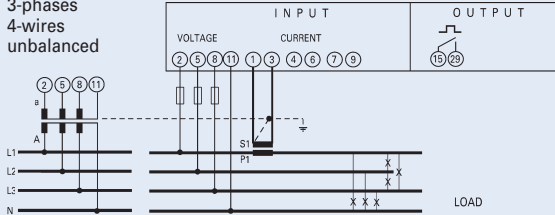

3-phases 4-wires unbalanced

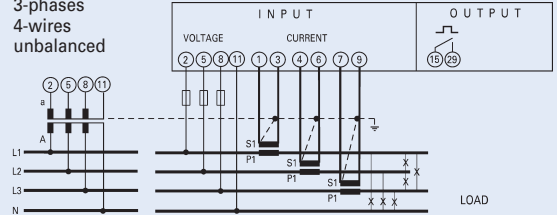

Wiring diagrams KWZ-3PH-63

3-phases 3-wires

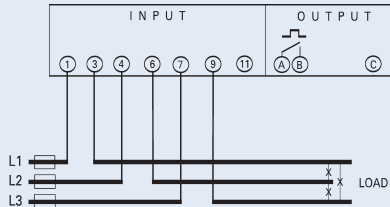

3-phases 4-wires

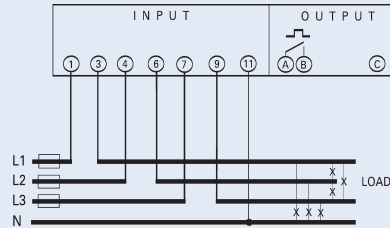

For types and art. numbers see page 61

Power meters KWZ-3PH(D)

- For measuring of active energy
- Accurate measuring even in case of uneven load per each phase
- Works properly even in case of 2 phase lost
- Can be used also for 1phase measuring
- Design according to EN 62053-21
- KWZ-3PH with electromechanical counter
- KWZ-3PHD with digital display
- KWZ-3PH(D)-63 for direct measuring, accuracy class 2
- KWZ-3PH(D)-I5(I1) for semidirect measuring x/5 A (x/1 A), accuracy class 1
- S0 impulse output as a standard for all versions
- KKWZ-3PHD as 1 to 4 tariff version
- KWZ-3PHD version -R with relay output
- KWZ-3PHD version -C with communication RS-485 (MODBUS RTU)
- KWZ-3PHD version -M with communication module M-BUS
- Type approval and calibration for Czech Rep.
- KWZ-3PHD version -D (-DC, -DR) two-tariff version

Connection diagrams

3-phase direct measuring

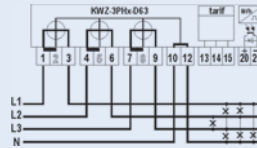

1-phase direct measuring

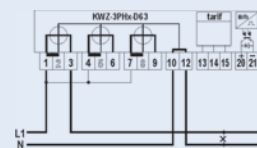

3-phase semidirect measuring

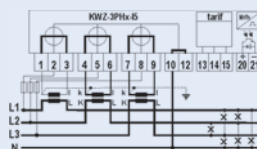

Technical Data

	KWZ-3PH(D)-D63	KWZ-3PH(D)-I5
Electrical:		
Rated voltage U_n	230/400 V AC	230/400 V AC
Working range	0.9–1.1 x U_n	0.9–1.1 x U_n
Rated current I_n	5 A	5 A
Maximum current I_{max}	63 A	6 A
Rated frequency	50 Hz ±5%	50 Hz ±5%
Input signal	Sinusoidal	Sinusoidal
Power consumption – current circuit	≤ 0.05 VA at I_n per phase	≤ 0.05 VA at I_n per phase
Power consumption – voltage circuit	≤ 7.7 VA, cap. 0.7 W per phase	≤ 7.7 VA, cap. 0.7 W per phase
Isolation strength of meas. core	12 kV	12 kV
Accuracy class	2	1
Resolution	0.1 kWh	X x 0.01 kWh
LED signal	10 000 imp/kWh	10 000 imp/kWh
S0 pulse output rated values	max. 27 VDC, 27 mA	max. 27 VDC, 27 mA
Pulse value S0	500 imp/kWh	5 000 imp/kWh
Relay output cont. (potential free)	1 NO	1 NO
Rated peak withstand voltage (1,2/50) μs výstupu S0	6 kV	6 kV
Test voltage 50 Hz/1 min., S0 output	4 kV	4 kV
Relay output rated values (-R version)	100 V DC/AC, 100 mA	100 V DC/AC, 100 mA
Relay pulse value (-R version)	100 imp/kWh, 250 ms	100 imp/kWh, 250 ms
Maximum back-up	B63	B6 (voltage and current circuit)
Mechanical:		
Frame size	45 mm	45 mm
Device height	93.5 mm	93.5 mm
Device width	153 mm (8.5 MU)	153 mm (8.5 MU)
Weight	490 g	490 g
Mech. counter	6+1	6+1
Dig. display	6+2	6+2
Height of figures dig.	8 mm	8 mm
Height of figures mech.	5.5 mm	5.5 mm
Terminals	screw	screw
Terminal capacity	16 mm ² (2.5 mm ²)	16 mm ² (2.5 mm ²)
Tightening torque of terminal screws	2 Nm (1 Nm)	2 Nm (1 Nm)
Degree of protection	IP20, IP40 with terminal cover KWZ-SCOV (measuring core IP51)	
Permitted relative humidity	<75 %	<75 %
Perm. ambient temperature range	-40 to + 60 °C	-40 to + 60 °C
Flame class	V1	V1

Dimensions [mm]

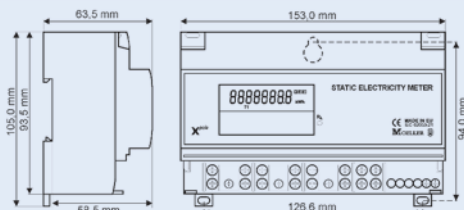

For types and art. numbers see page 61

Measuring modules NZM-XMC

- Measuring modules for net analysis
- Possibility of direct mounting onto NZM circuit breaker cables or onto mounting panel
- Versions – MB: possibility to display data at NZM-XMC-DISP or via MODBUS at other device (e.g. touch panels XV100)
- Display NZM-XMC-DISP with standard frame 96x96 mm
- Version with S0 output, or with MODBUS (one slot for external communication, the other for connection of NZM-XMC-DISP)
- Active and inductive reactive energy measurement including component analysis, accuracy 1 % and 2 %, respectively
- Temperature measurement
- All MODBUS versions can operate as a slave on PROFIBUS-DP via adapter

Technical Data

	NZM2-XMC-S0	NZM3-XMC-S0	NZM2/3-XMC-MB	
Electrical:				
Supply				
Rated voltage	18 – 36 V DC	18 – 36 V DC	18 – 36 V DC	
Maximum current	200 mA	200 mA	200 mA	
Connector type	Phoenix contact GMVSTBR (2.5-2-ST-7.62)			
Voltage measurement				
Rated operational voltage	690 V AC	690 V AC	690 V AC	
Test voltage (8/20 μs)	8 kV	8 kV	8 kV	
Maximum voltage	800 V AC	800 V AC	800 V AC	
Impedance	1 kΩ	1 kΩ	1 kΩ	
Frequency	45 – 65 Hz	45 – 65 Hz	45 – 65 Hz	
Accuracy	0.4 % measuring + 0.05 % FS	0.4 % measuring + 0.05 % FS	0.4 % measuring + 0.05 % FS	
Overvoltage category (EN 61010)	IV (600 V)	IV (600 V)	IV (600 V)	
Current measurement				
Rated operational current	300 A	500 A	300 A (NZM2) / 500 A (NZM3)	
Maximum current	350 A	740 A	350 A (NZM2) / 740 A (NZM3)	
Peak current test (1 s)	30 kA	30 kA	30 kA	
Frequency	45 – 200 Hz	45 – 200 Hz	45 – 200 Hz	
Overvoltage category (EN 61010)	IV (600 V)	IV (600 V)	IV (600 V)	
Power measurement				
Maximum power (per phase)	–	–	280 kW	
Accuracy	–	–	0.95 % measuring + 0.05 % FS	
Accuracy active power	class 1 (IEC 62053-21)	class 1 (IEC 62053-21)	class 1 (IEC 62053-21)	
Accuracy reactive power	–	–	class 2 (IEC 62053-23)	
Pulse input				
Input type	transistor NPN	transistor NPN	transistor NPN	
VCE max.	80 V	80 V	80 V	
VCE sat	0,4 V	0,4 V	0,4 V	
Ic max	50 mA	50 mA	50 mA	
Ic recommended	10 mA	10 mA	10 mA	
Insulation voltage	3 kV	3 kV	3 kV	
Maximum switching rate	2 Hz	2 Hz	4 Hz	
Pulse length	120 ms	120 ms	≥ 20 ms	
Number of pulses	15 imp. / kWh	7,5 imp. / kWh	–	
Digital output				
Maximum voltage	–	–	350 V	
Maximum current	–	–	120 mA	
Insulation voltage	–	–	2,5 kV	
Digital input				
Maximum voltage	–	–	50 V	
VIH max	–	–	3 V	
MODBUS RS-485				
Transfer rate	–	–	9600, 19200, 38400, 56000, 57600 bit/s	
Stop bites	–	–	1, 2	
Parity	–	–	none, odd, even	
Insulation voltage	–	–	3 kV	
Output - display				
Voltage	–	–	5 V DC	
Maximum current	–	–	180 mA	
Mechanical:				
Dimensions	3-pole	209x91x132 mm	209x91x132 mm	209x91x132 mm
	4-pole	251x91x132 mm	251x91x132 mm	251x91x132 mm
Weight	3-pole	850 g	850 g	850 g
	4-pole	975 g	975 g	975 g
Material	UL94-V0			
Operating temperature	-15 to +65 °C			
Storing temperature	-40 to +80 °C			
Humidity (without condensation)	5 to 95 %			
Maximum operational elevation above sea level	2000 m			
Degree of protection	IP20			

For types and art. numbers see page 62

Dimensions [mm]

NZM2 (3)...XMC-S0(MB)

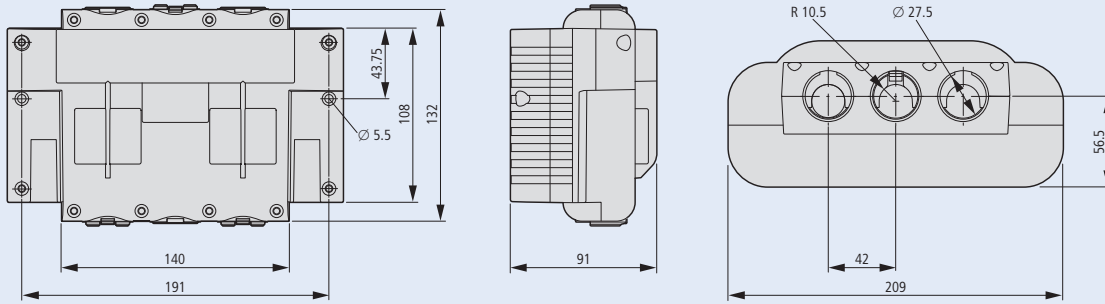

NZM2 (3)(-4)...XMC-S0(MB)

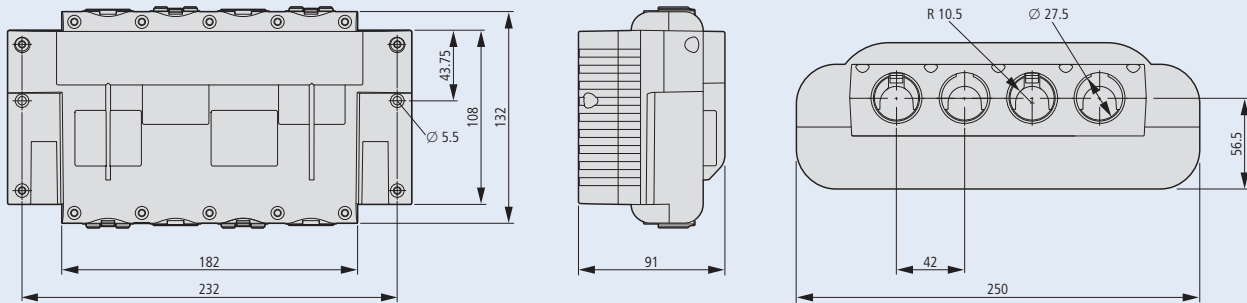

Accessories for Measuring Instruments

Current transformers MAK

- According to EN 60044-1, BS 3938 and DIN 42600
- Transform high currents to standard meas. currents to 5 A
- Current transformers reduce expenses on connection and installation of busbars
- Recommended for currents up 50 A
- Accuracy classes
 - class 0.5: for accurate measuring and type tested powermeters (for official measuring)
 - class 1 for common measuring and non type tested powermeters (sub-measurement)

Connection diagram

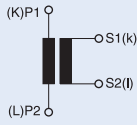

Technical Data

Electrical:

Rated voltage	720 V AC
Rated frequency	50–60 Hz
Rated primary current I_{pn}	50–2000 A
Rated secondary current	5 A (on request 1 A)
Rated thermic short time current I_{th}	40-80 I_{pn} for 1 s
Rated dynamic short circuit current I_{dyn}	2.5 x I_{th} for 1 s
Permanent overload	1.2 x I_{pn}
Insulation class	E
Test voltage 50 Hz/1 min.	4 kV _{eff}
Accuracy class	0.5 or 1
Perm. ambient temperature range	-20 °C ... +45 °C (+65 °C)
Perm. ambient temperature range (storing)	-50 °C ... +80 °C

Mechanical :

see dimension diagrams

MAK 45/21

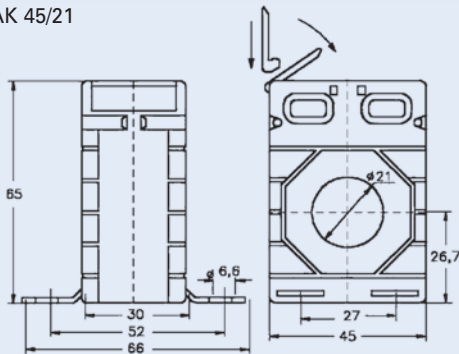

MAK 62/30

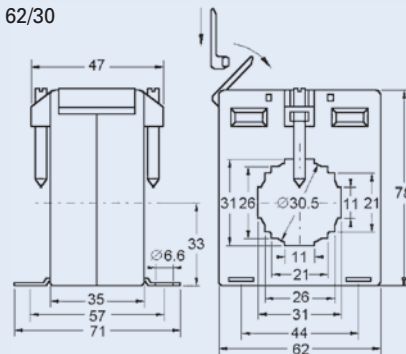

MAK 62/40

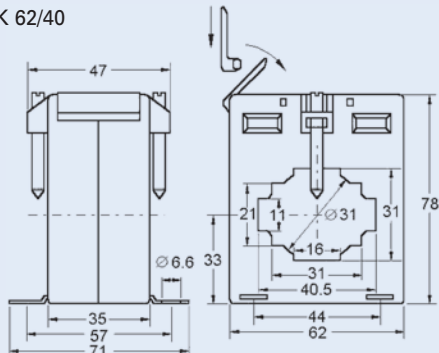

MAK 62/R

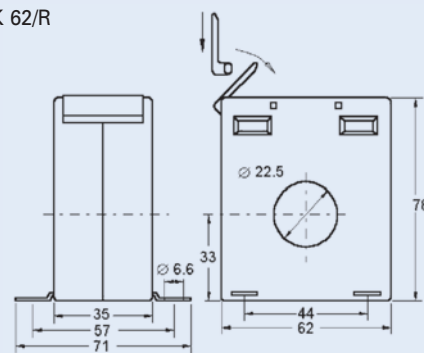

For types and art. numbers see page 63

Accessories for Measuring Instruments – Continuation

MAK 74/40

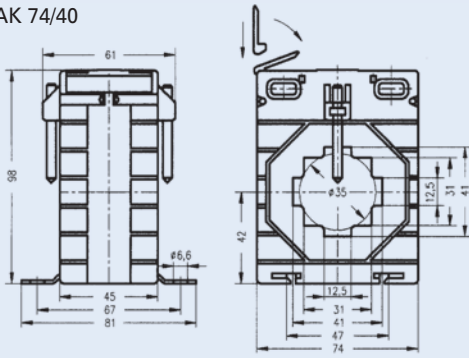

MAK 74/50

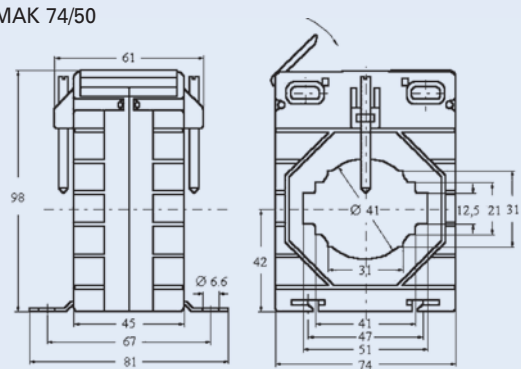

MAK 74/WS

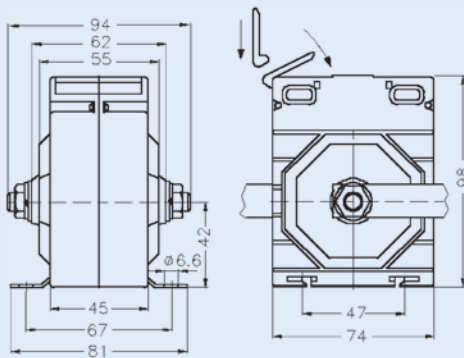

MAK 86/40

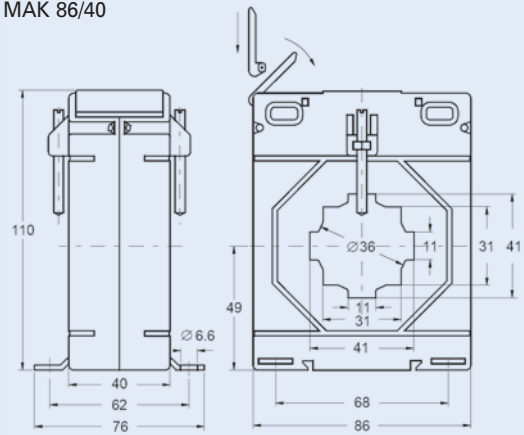

MAK 86/50

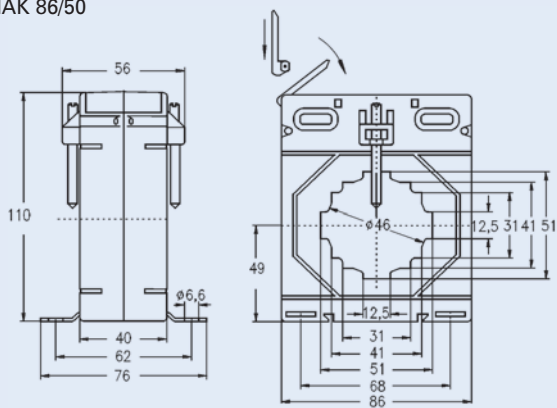

MAK 86/60

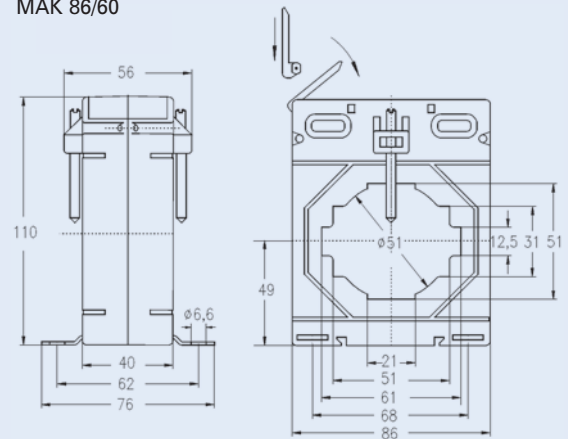

MAK 104/80

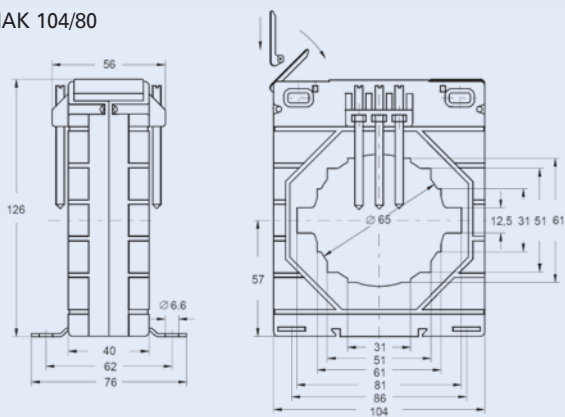

MAK 140/100/H

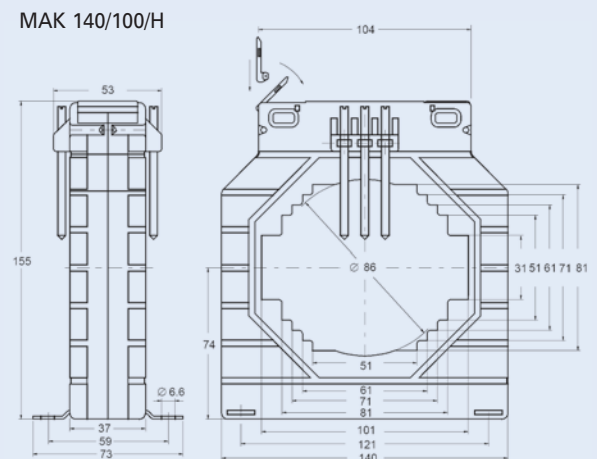

For types and art. numbers see page 63

Operating Hours Counter BSZ, Pulse Counter Z-IMZ

- According to EN 61010
- Hours counter for gathering operating time data of machines and systems and determining operating costs, maintenance intervals, warranty and working times.

Connection diagram

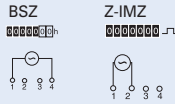

Technical Data

	BSZ/230	BSZ/24	Z-IMZ/230	Z-IMZ/24
Electrical:				
Rated voltage	230 V AC $\pm 10\%$	24 V AC $\pm 10\%$	230 V AC $\pm 10\%$	24 V AC $\pm 10\%$
Rated frequency	50 Hz	50 Hz	50 Hz	50 Hz
Current consumption	10 mA	10 mA	8 mA	10 mA
Accuracy	line frequency-dependent		-	-
Counting frequency	-	-	max. 10 imp. / s	max. 10 imp. / s
Pulse duration / interval	-	-	10 ms	10 ms
Duty	-	-	100 %	100 %
Own consumption	1 VA	1 VA	1.84 VA	0.24 VA
Mechanical:				
Frame size	45 mm	45 mm	45 mm	45 mm
Device height	85 mm	85 mm	90 mm	90 mm
Device width	35 mm	35 mm	35 mm	35 mm
Weight	75 g	75 g	60 g	60 g
Zero position	no	no	no	no
Operation indicator	no	no	no	no
Counting range	99999.99 h	99999.99 h	9999999	9999999
Height of figures	3.5 mm	3.5 mm	4 mm	4 mm
Colour of figures	white on black decimals red	white on black decimals red	white on black	white on black
Mounting	quick fastening on DIN rail EN 60715			
Degree of protection, built-in	IP40	IP40	IP65	IP65
Lower terminals	screw terminals			
Terminal capacity	10 mm ²	10 mm ²	0.14–4 mm ²	0.14–4 mm ²
Tightening torque of terminal screws	1.2 Nm	1.2 Nm	0.8 Nm	0.8 Nm
Temperature range	-25 to +55 °C	-25 to +55 °C	-10 to +70 °C	-10 to +70 °C

Dimensions [mm]

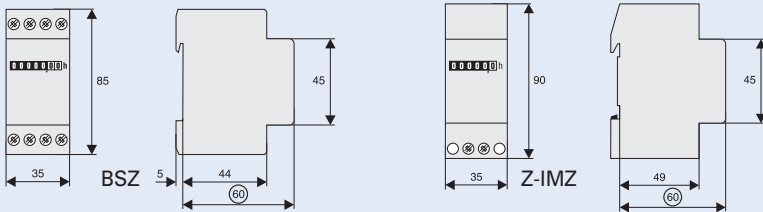

Signalling Devices, Buzzer Z-SUM, Bell Z-GLO

- Version without sparking

Technical Data

Electrical:		Mechanical:	
Rated voltage	12, 24, 230 V AC	Frame size	45 mm
Frequency	50 Hz	Device height	86 mm
Power loss 12 V	6.5 VA	Device width	17.5 mm (1 MU)
24 V, 230 V	4.5 VA	Mounting	quick fastening on DIN EN 60715
Duty	100 % (max 12 hours)	Degree of protection	IP20
Volume Buzzer Z-SU	75 dB	Upper and lower terminals	lift terminals
Bell Z-GL	77 dB	Terminal capacity	max. 10 mm ²

Dimensions [mm]

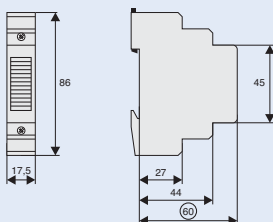

For types and art. numbers see page 64

Manual Motor Starters Z-MS

- Reliable protection of motors in case of thermal overload and short circuit
- Magnetic short-circuit tripping fixed
- Thermal overload tripping adjustable
- Suitable for installation in compact distribution boxes
- Contact position indicator red - green
- Busbar positioning optionally above or below
- Main field of application: switching and protection of three-phase AC motors with power ratings up to 15 kW (380/400 V) and other consumers up to 40 A
- Necessary not to exceed range of operation temperatures
- Load capacity is reduced with growing ambient temperature and with placing switches Z-MS one beside the other
- Also suitable as a main switch
- Isolating characteristics according to EN 60947
- Terminals and accessories compatible with PL7, PL6 etc.

Connection diagram

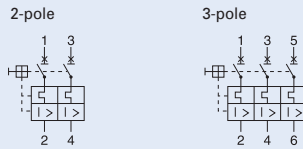

Technical Data

General:

Terminal capacity	1–25 mm ²
Busbar thickness	0.8–2 mm
Mechanical endurance	20,000 operating cycles
Shock resistance (shock duration 20 ms)	20 g
Ambient temperature	open -25 ... + 50 °C hermetically enclosed -25 ... + 40 °C
Resistance to climatic conditions	
- humidity and heat, constant, according to	60068-2-3
- humidity and heat, periodical, according to	60068-2-30
Mass approx. (2 MU / 3 MU)	244/366 g
Degree of protection	IP20

Main Current Paths

Rated insulation voltage U _i	440 V
Rated peak withstand voltage U _{imp}	4 kV
Rated short circuit breaking capacity I _q	10 kA
Rated max. breaking capacity I _{cu}	10 kA
Rated operational breaking capacity I _{cs}	7.5 kA
Thermal current I _{thmax} = I _{emax}	40 A
Electrical endurance AC-3 at I _e	6000 operating cycles
Motor switching capacity AC-3 at 16 A	400 (415) V
Max. voltage for DC	48 V per pole
Min. operating voltage AC/DC	12/12 V for I _n = 1.6 to 40 A 24/24 V for I _n = 1 A; 48/48 V for 0.4 to 0.63 A; 230/- for 0.16 to 0.25 A
Power loss per contact	2.3 W (1.6–10 A); 3.3 W (16 A); 4.5 W (25–40 A)

Auxiliary switch Z-AHK / Z-NHK

Rated insulation voltage U _i	440 V
Thermal current I _{th}	8 A
Rated operational current I _e	6 A
at AC-13	250 V 440 V
Max. back-up fuse for short-circuit protection	4 A (gL/gG), PL7-4/B-HS
Terminal capacity (1 or 2 conductors)	0.75 ... 2.5 mm ²

Dimensions [mm]

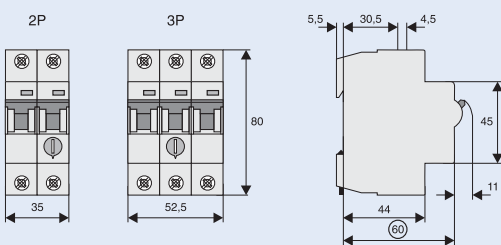

Connection

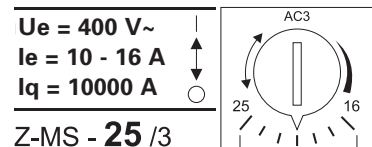
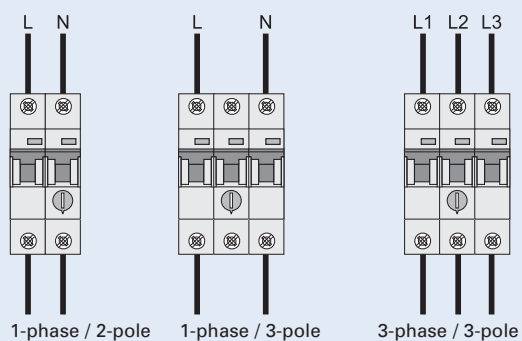

Example of device printing I_i = 10x I_e 16x I_e

For types and art. numbers see page 65

Selection of Switches for the Protection of Motors

Motor power and current						Setting ranges of overload release [A]
1-phase 230–240 V		3-phase 230–240 V		3-phase 400–415 V		
[kW]	[A]	[kW]	[A]	[kW]	[A]	
				0.06	0.2	0.16–0.25
		0.06	0.4	0.09	0.3	0.25–0.4
		0.09	0.5	0.12	0.4	0.4–0.63
				0.18	0.6	0.4–0.63
0.06	0.7	0.12	0.7	0.25	0.8	0.63–1
0.09	0.7					0.63–1
0.12	1.3	0.18	1.0	0.37	1.1	1–1.6
		0.25	1.4	0.55	1.5	1–1.6
0.18	1.9	0.37	2.0	0.75	1.9	1.6–2.5
0.25	2.4					1.6–2.5
0.37	2.9	0.55	2.7	1.1	2.6	2.5–4
		0.8	3.2	1.5	3.6	2.5–4
0.55	4.2	1.1	4.6	2.2	5.0	4–6.3
0.75	5.6					4–6.3
1.1	7.4	1.5	6.3	2.5–3.0	6.6	6.3–10
1.5	8.9	2.5	8.7			6.3–10
				4.0	8.5	6.3–10
2.2	14.5	3.0	11.5	5.5	11.3	10–16
				7.5	13.2	10–16
3	17.8	4.0	14.8			16–20
		5.5	19.6	11.0	21.7	16–20
		7.5	26.4	15.0	29.3	25–40
		11.0	38.0	18.5	36.0	25–40

Overview of Types, Maximum Back-up Fuse and Short Circuit Behaviour

Type	Setting range [A]	Max. back-up fuse gL/gG [A]		Typical responding currents of short-circuit releases [A]
		3 x 230 V	3 x 400 V	
Z-MS-0,16	0.10–0.16			1.3–1.7
Z-MS-0,25	0.16–0.25			2.0–2.6
Z-MS-0,40	0.25–0.40	in case of short circuit currents up to the short circuit breaking capacity		3.1–4.8
Z-MS-0,63	0.40–0.63	no back-up fuse required		4.9–6.6
Z-MS-1,00	0.63–1.00			10–13
Z-MS-1,60	1.0–1.6			16–21
Z-MS-2,50	1.6–2.5			25–33
Z-MS-4,00	2.5–4.0			40–52
Z-MS-6,30	4.0–6.3	100	100	63–82
Z-MS-10,0	6.3–10.0	100	100	78–105
Z-MS-16,0	10.0–16.0	100	100	160–208
Z-MS-25,0	16.0–25.0	100	100	250–325
Z-MS-40,0	25.0–40.0	100	100	400–520

Connection of Shunt Trip Release

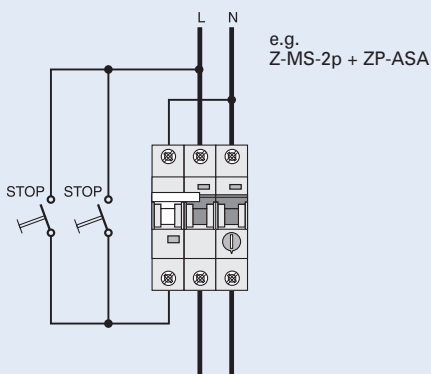

Connection of Undervoltage Release

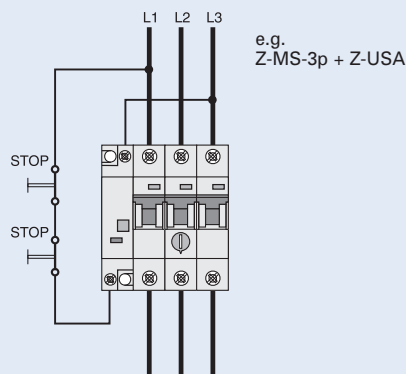

Block Diagram with Remote Switching Device

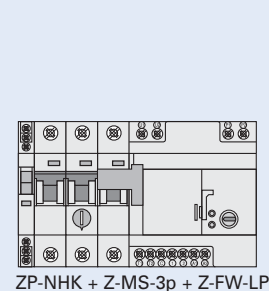

Load Capacity in Case of Block Installation

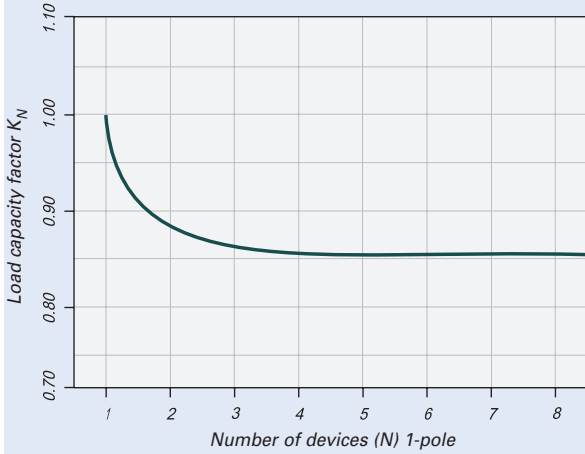

Permitted permanent load at ambient temperature T [°C] with n devices:
 $I_{DL}(T,N) = I_n \cdot K_T(T) \cdot K_N(N)$

Effect of the Ambient Temperature on the Load Capacity

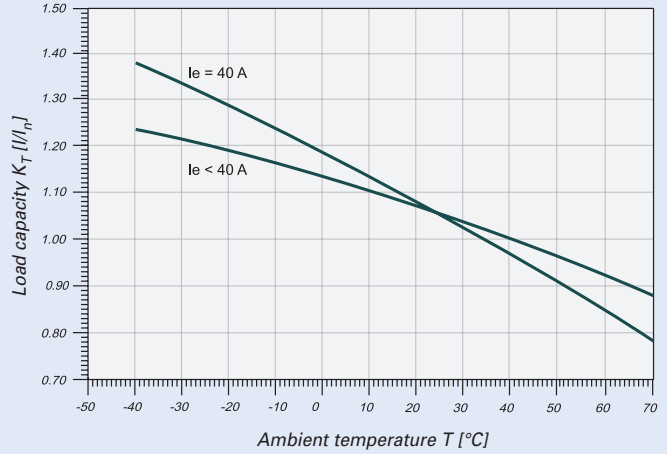

Valid for Z-MS devices, 3-pole, reference ambient temperature 20°C,
 permitted permanent load at ambient temperature T [°C] with N devices:
 $I_L(T) = I_n \cdot K_T(T)$

Typical Tripping Characteristic MS 0.16/0.25/0.4/0.63/10 A

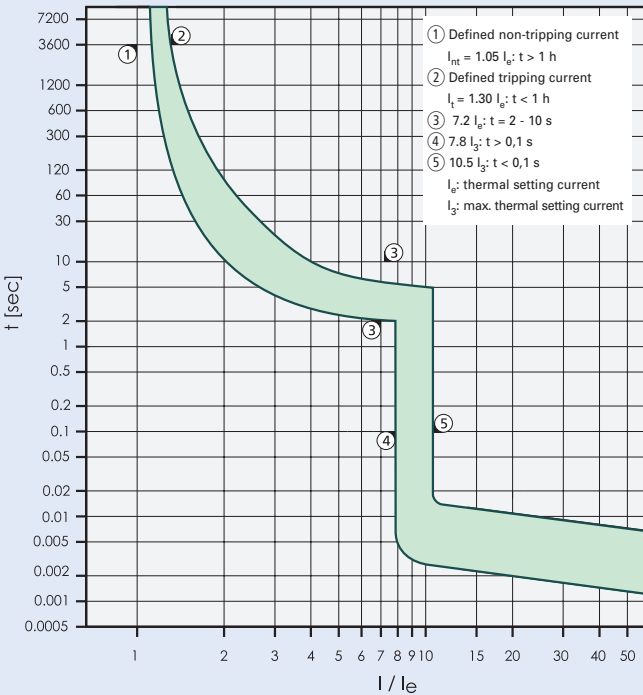

Tripping current as a multiple of the maximum setting current,
 at an ambient temperature of 20 °C, from cold state

Typical Tripping Characteristic MS 1/1.6/2.5/4/6.3/16/25/40 A

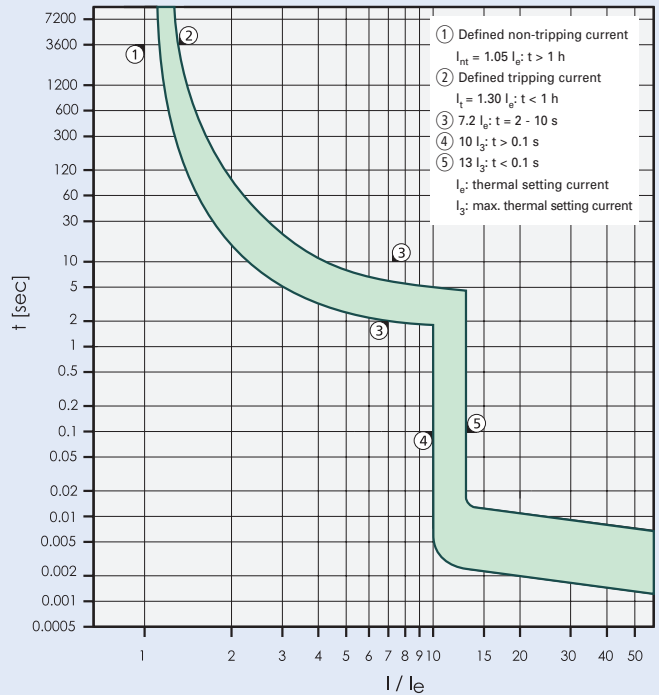

Tripping current as a multiple of the maximum setting current,
 at an ambient temperature of 20 °C, from cold state

Accessories for Manual Motor Starters Z-MS

- Accessories for manual motor starters are the same as for PF7, PF6 etc. (releases, auxiliary switches and busbar system)
- Shunt trip release ZP-ASA
- Undervoltage releases
 - Z-USA: instantaneous
 - Z-USD: delayed
- Auxiliary switch ZP-IHK: 1 NO + 1 NC
- Tripping signal switch ZP-NHK: 1 NO + 1 NC
- Remote control and automatic switching device Z-FW
- Moisture-proof enclosure IP54
 - Z-MFG: PE terminal only
 - Z-MFG/NL: PE + N terminals
 - Z-MFG/NOT: PE + N terminals and EMERGENCY OFF key

Installation Example

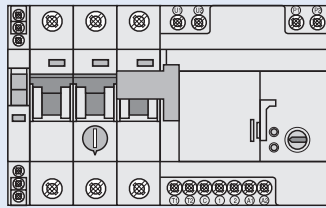

ZP-NHK + Z-MS-2p + Z-FW-LP

Moisture-proof Enclosure Z-MFG

- According to EN 50298
- Suitable for manual motor starters Z-MS, e.g. 3p (+ Z-USA); miniature circuit breakers; circuit breakers, etc.
- Earth conductor connection integrated in all types
- Entries for 4 x PG16 cable glands prepared
- Scope of delivery: 4 entry bushes, 1 mushroom-shaped pushbutton (red) + 1 contact (NC) in Z-MFG/NOT
- Operation: Turning handle, can be locked in the OFF-position by means of 3 padlocks, (max. Ø 6 mm)
- Enclosure cover can be sealed with leads in 2 locations

Technical Data

	Z-MFG	Z-MFG//NL	Z-MFG/NOT
Electrical:			
Power Loss of installed devices	max. 17 W	max. 17 W	max. 17 W
Mechanical:			
Degree of protection	IP54	IP54	IP54
Protection class	II	II	II
Neutral connection	-	integrated	integrated
Max. Device width	4 MU	4 MU	4 MU
Terminal capacity N/PE	max. 16 mm ²	max. 16 mm ²	max. 16 mm ²
Tightening torque			
N/PE-terminals	max. 2 Nm	max. 2 Nm	max. 2 Nm
cover screws	max. 2 Nm	max. 2 Nm	max. 2 Nm

Dimensions [mm]

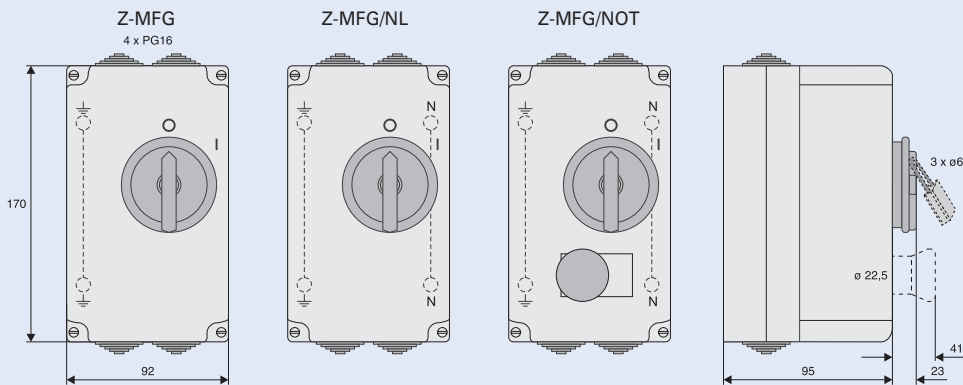

For types and art. numbers see page 65

Compact Enclosure KLV-TC

- Compact enclosure, degree of protection IP30
- Without door
- For 45 mm devices for modular installation
- Can be sealed

Technical Data

	KLV-TC-2	KLV-TC-4	KLV-TC-4-TB	KLV-TC-8	KLV-TC-8-TB1	KLV-TC-8-TB2
Mechanical:						
Module units (MU)	1+1	3+1	3+1	6+2	6+2	6+2
Weight	0.09 kg	0.15 kg	0.17 kg	0.32 kg	0.35 kg	0.36 kg
Terminal Support with Terminal Block	-	-	KLV-TC-TB-4/4	-	KLV-TC-TBC-4/4	KLV-TC-TBC-4/4+4

Terminal Support with Terminal Block

Type Designation	Number of Terminal	Weight
KLV-TC-TB-4/4	2 x 10 mm ² + 2 x 16 mm ²	0.018 kg
KLV-TC-TBC-4/4	2 x 10 mm ² + 2 x 16 mm ²	0.030 kg
KLV-TC-TBC-4/4+4	2 x (2 x 10 mm ² + 2 x 16 mm ²)	0.045 kg

Dimensions [mm]

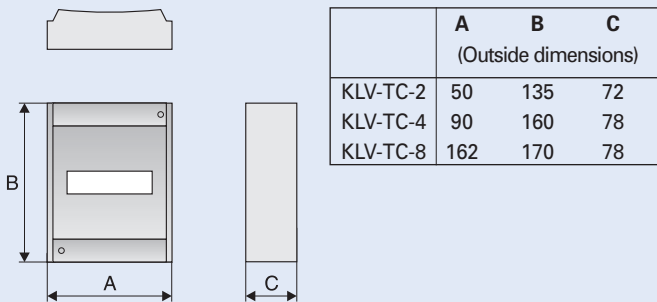

Enclosures ISO, KLV-LV-SP-45

- Plastic enclosure with terminal and busbar
- 1-row
- 45 mm device cut-out
- Terminal included
ISO 0 - KL7 (7 x 16 mm²)
ISO 1 - KL15 (15 x 16 mm²)
- For devices with frame size 45 mm
- Side boards and profiled strips are connected with glue
- KLV-LV-SP-45 - side boards
- KLV-LV-PL-45 - profiled strips 2 m

Dimensions [mm]

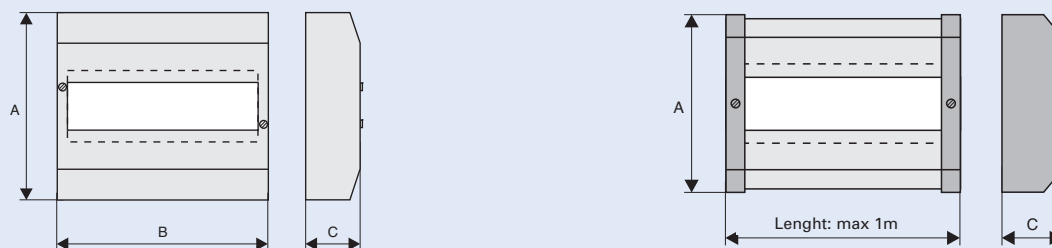

	A	B	C
	(Outside dimensions)		
ISO 0	180	150	79
ISO 1	180	220	79

	A	C
	(Outside dimensions)	
KLV-LV-45	156	75.5

For types and art. numbers see page 66

Busbar Systems

Universal busbar system 50 A, 80 A for devices

- Low number of components, 2 angle types per busbar cross-section for three-phase AC
- Same busbar cover and end caps for ZV-SS and ZV-SS-80A
- Short-circuit withstand strength and dielectric properties tested according to EN 60739-1
- Optional placing of connection points of particular phases, arbitrary combinations can be created

Connection diagram

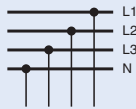

Technical Data

Electrical:

Rated operation voltage	240/415 V		
Rated frequency	50/60 Hz, DC		
Rated voltage	690 V (at pollution degree 2) 440 V (at pollution degree 3)		
Overvoltage category	III		
Rated impulse withstand voltage U_{imp}	4 kV		
Rated current	ZV-./., ZV-SS 50 A	ZV-./.-80A, ZV-SS-80A 80 A	ZV...-N-05TE 32 A
Rated conditional short-circuit current			
AC s 125 A gG	50 kA	50 kA	10 kA
AC s 160 A gG	-	50 kA	10 kA
DC s 160 A gG	10 kA	10 kA	-
Feed in the load centre with 50 mm ² terminal ZD-80			
rated current ZV-SS	80 A		
rated current ZV-SS-80A	125 A		
Mechanical:			
Busbar cross section	ZV-SS 25 mm ² Cu	16 mm ² Cu	
Busbar length	1 m		
Degree of protection mounted with cover and end caps	IP20		
Pollution degree	2 (3)		
Minimum clearance	≥ 3.2 mm		
Minimum creepage distance	≥ 7 mm		

Dimensions [mm] 50 A

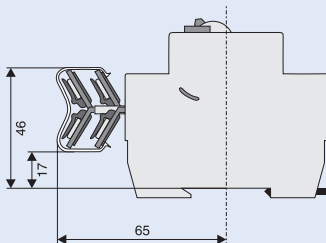

Dimensions [mm] 80 A

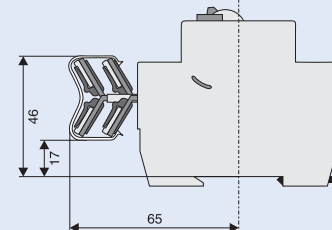

Example



Connection angle ZV-L1/N (-80A) for L1 and N

Connection angle ZV-L2/L3 (-80A) for L2 and L3

Connection angle ZV-N-05TE (-80A) for N path (e.g. PL7 with 1.5 MU)

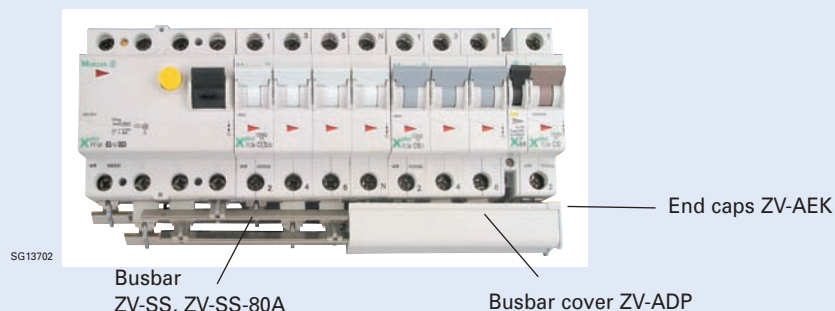

For types and art. numbers see page 68

Busbar Block 10 mm², 16 mm² (1 MU)

- Length 1 m
- Delivered without end caps. Please order separately.
- Short version (/16, /8) delivered with end caps.

Connection diagram

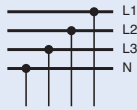

Technical Data

Electrical:

Rated voltage, frequency	240/415 V, 50/60 Hz
Rated current	
10 mm ²	63 A
16 mm ²	80 A
Short circuit strength	25 kA

Mechanical:

Busbar cross section	10 and 16 mm ² Cu
Step distance	17.8 / 27 mm

Dimensions [mm]

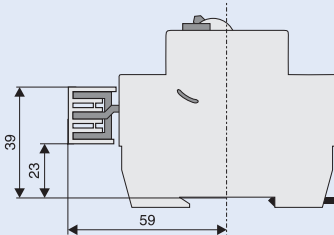

Devices to busbar	Pcs. of the devices	End caps		Type
1-phase 	x57 x57 x16	Z-V- AK/1P		Z-GV-10/1P-1TE Z-GV-16/1P-1TE Z-GV-16/1P-1TE/16
2-phases 	x28 x8	Z-AK- 16/2+3P		Z-GV-16/1P+N-2TE Z-GV-16/1P+N-2TE/16
3-phases 	x19 x19 x2 x5	Z-AK- 10/2+3P Z-AK- 16/2+3P		Z-GV-10/3P-3TE Z-GV-16/3P-3TE Z-GV-16/3P-3TE/8 Z-GV-16/3P-3TE/16
4-phases 	x27	Z-AK- 16/4P		Z-GV-16/3P+3N-6TE
	x14 x4	Z-AK- 16/4P		Z-GV-16/3P+N-4TE Z-GV-16/3P+N-4TE/16
1-phase + Auxiliary Switch 	x38	Z-V- AK/1P		Z-GV-16/1P+HS
3-phases + Auxiliary Switch 	x16	Z-AK- 16/2+3P		Z-GV-16/3P+HS

For types and art. numbers see page 68

Busbar Block 16 mm² for 1-p+N devices (1.5 MU)

- Length 1m
- Delivered without end caps. Please order separately.
- Short version (/9) delivered with end caps.

Connection diagram

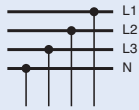

Technical Data

Electrical:





Rated voltage, frequency	240/415 V, 50/60 Hz
Rated current	63 A
Short circuit strength	25 kA

Mechanical:

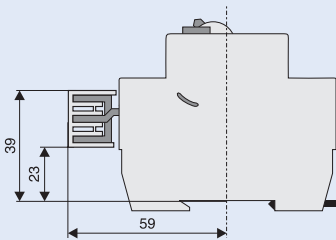
Busbar cross section	16 mm ² Cu
Step distance	26.7 mm

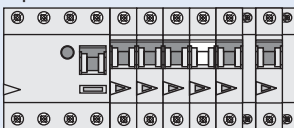
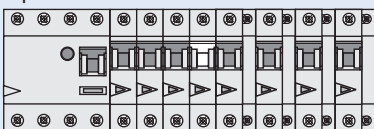
Dimensions [mm]



Devices to busbar	Pcs. of the devices	End caps	Type
<p>4-phases</p> 		Z-V-AK/4P	Z-GSV-10/FI+EH+2XLS1N
<p>4-phases</p> 		Z-V-AK/4P	Z-GSV-10/FI+EH+4XLS1N
<p>2-phases</p> 	x37 x9	Z-AK-16/2+3P	Z-GSV-16/1P+N Z-GSV-16/1P+N/9
<p>4-phases</p> 	x37 x9	Z-AK-16/4P	Z-GSV-16/3P+3N Z-GSV-16/3P+3N/9
<p>4-phases</p> 		Z-V-AK/4P	Z-GSV-16/FI+EH+KR+30XLS1N

Busbar Block 10mm² (Pins) Z-SV...-SD

- Special busbars for sockets Z-SD... (placing of sockets one besides the other)
- Cross section 10 mm² for rated current 50 A
- Length 1m
- Including end caps

Connection diagram



Technical Data

Electrical:

Rated voltage	230/400 V, 50/60 Hz
Rated current	50 A
Short circuit strength	25 kA

Mechanical:

Busbar cross section	10 mm ² Cu
Step distance	44 mm

Dimensions [mm]

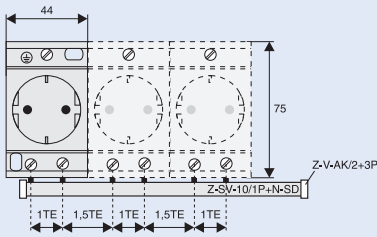

Accessories

WA_SG10602

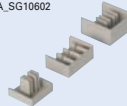

End caps

WA_SG10702



Connection terminal
Z-EK/25/QL

WA_SG10702



Connection terminal
Z-EK/25

Busbar Block Z-SV (1.5 MU) for PLHT

- Busbar system with fixed spacing and position of terminals
- For circuit breakers PLHT, fuse switch disconnectors and fuse bases Z-SLS, D0-SO/..
- Cross section 16 and 35 mm² for rated currents 80 and 110 A, respectively
- Length 1 m
- End caps must be ordered separately (type Z-SV-35/3P+N-6TE delivered with end caps)
- Terminal shape – pin

Connection diagram

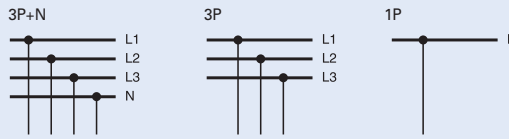

Technical Data

	Z-SV-16	Z-SV-35
Electrical		
Rated operational voltage	240/415 VAC	240/415 VAC
Rated frequency	50/60 Hz	50/60 Hz
Rated voltage	500 V	690 V
Overvoltage category	III	III
Rated impulse withstand voltage U_{imp}	4 kV	6 kV
Rated current	80 A	110 A
Rated conditional short-circuit current AC with 350 A gG	50 kA _{r.m.s.}	100 kA _{r.m.s.}
Mechanical		
Busbar cross section	16 mm ² Cu	35 mm ² Cu
Step distance	27 mm	27 mm (Z-SV-35/PLHT-V 30.5 mm)
Flame class	V0, Glow wire-test 960 °C	V0, Glow wire-test 850 °C
Degree of protection, with end caps	IP20	IP20
Pollution degree	2	2
Comparative tracking index	CTI 300	CTI 600
Minimum clearance	≥ 5 mm	≥ 4,3 mm
Minimum creepage distance	≥ 10.2 mm	≥ 6.7 mm

Dimensions [mm]

	n	A	B	C	D	E	F	G	H	I
Z-SV-16/3P	35	27	5	945	971	14.9	31	1.5	17	19
Z-SV-35/3P	35	27	8.5	945	1000	19.7	38.4	2.5	21.5	23.9
Z-SV-35/PLHT-V	32	30,5	8.5	976	1000	19.7	38.4	2.5	21.5	23.9

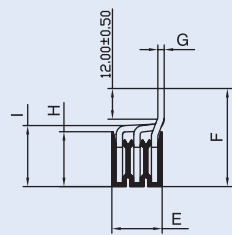

Z-SV-35/3P+N-6TE

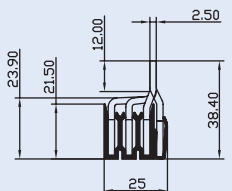

Z-SV-35/1P

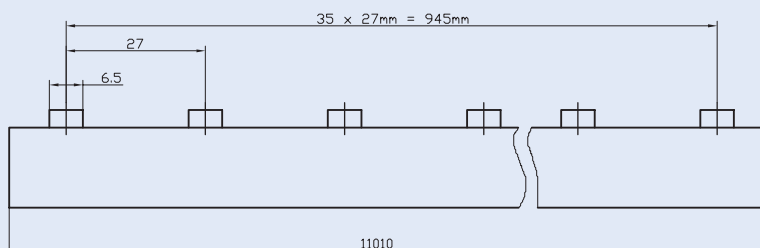
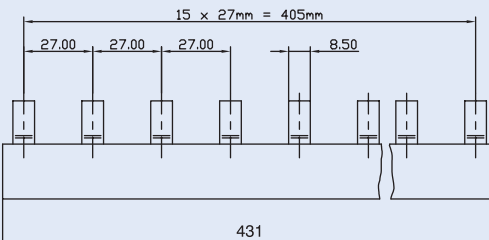
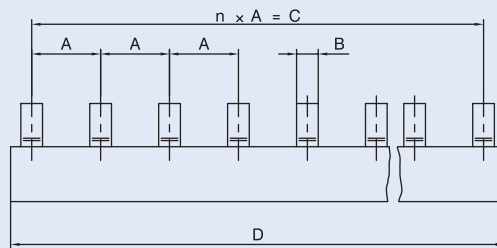
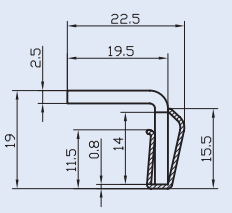

Accessories for Z-SV-16

Wa_sg10802



Connection terminal
Z-EK/50

Accessories for Z-SV-35

Wa_sg10802



Connection terminals
Z-EK/95, Z-EK/95-3N,
Z-EK/95-1

For types and art. numbers see page 70

Fork-Type Euro-Vario Busbar EVG

- Busbar system with fixed spacing and position of terminals
- For installation devices series Moeller line Xpole (PL7, PL6, PF7, PF6, PHF7, dRCM, PFL7, PFL6, PFR,...)
- Versions for device without or with auxiliary contact (not connected to busbar)
- 3-pole version for combination with 4-pole RCD when N-conductor is not connected to busbar
- Various length, cannot be cut
- End-cap-less design, terminal shape – fork





Technical Data

Electrical

Rated voltage	240/415 V, 50/60 Hz
Rated current	
10 mm ²	63 A
16 mm ²	80 A
Short circuit strength	25 kA

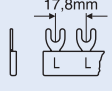
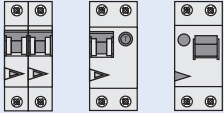
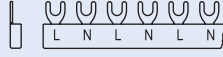
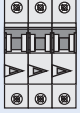
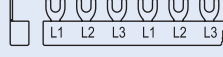
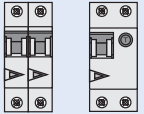
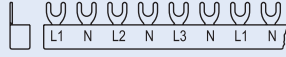
Mechanical

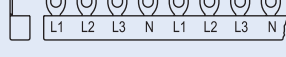
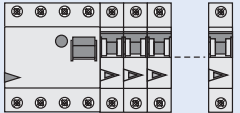
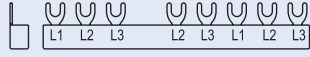
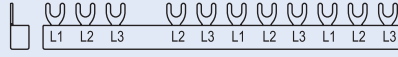
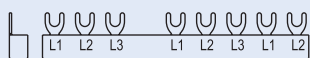
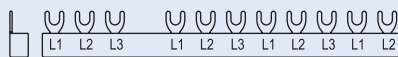
Busbar length	2, 6, 9, 12, 16, 20 MU
Busbar cross section	10 mm ² / 16 mm ²
Step distance	
10 mm ²	17.8 mm / 26.8 mm / 71.2 mm
16 mm ²	17.8 mm / 27 mm / 71.2 mm

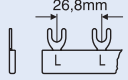
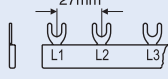
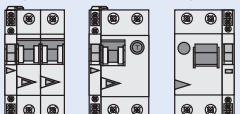
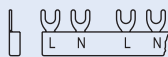
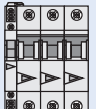
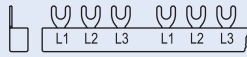
Devices to busbar	Pcs. of the devices	End caps	Type
1-phase 	x2 x6 x12		EVG-../1PHAS/2MODUL EVG-../1PHAS/6MODUL EVG-../1PHAS/12MODUL
2-phases 	x2 x3 x6		EVG-../2PHAS/4MODUL EVG-../2PHAS/6MODUL EVG-../2PHAS/12MODUL
3-phases 	x2 x3 x4 x5 x6		EVG-../3PHAS/6MODUL EVG-../3PHAS/9MODUL EVG-../3PHAS/12MODUL EVG-../3PHAS/16MODUL EVG-../3PHAS/20MODUL
4-phases 	x8 x9		EVG-3P+3N/16MODUL EVG-3P+3N/18MODUL
	x2 x3		EVG-../4PHAS/8MODUL EVG-../4PHAS/12MODUL
For combination RCD/MCBs with RCD 4-pole, 3-phases 			EVG-3PHAS/N/5MODUL/LS
			EVG-3PHAS/N/8MODUL/LS
			EVG-16/3PHAS/N/5MODUL/LS
			EVG-16/3PHAS/N/8MODUL/LS
1-phase + Auxiliary Switch 	x2 x6 x9		EVG-../1PHAS/2MODUL/HI EVG-16/1PHAS/6MODUL/HI EVG-../1PHAS/9MODUL/HI
	x6 x8 x9		EVG-16/3x1PHAS/6MODUL/HI EVG-16/3x1PHAS/8MODUL/HI EVG-16/3x1PHAS/9MODUL/HI
2-phases + Auxiliary Switch 	x2 x3 x5		EVG-../2PHAS/4MODUL/HI EVG-16/2PHAS/6MODUL/HI EVG-../2PHAS/10MODUL/HI
3-phases + Auxiliary Switch 	x2 x4		EVG-../3PHAS/6MODUL/HI EVG-../3PHAS/12MODUL/HI

For types and art. numbers see page 71

Fuse-links DII, DIII

- According to EN 60269-1, EN 60269-3
- For fuse-bases DII-SO..., DIII-SO...
- Delayed fuse links gG (gL)
- Standard fuse links DZ

Connection diagram



Technical Data

Electrical

Operating class	gG (gL)
Rated voltage U_n	
AC	500 V
DC	400 V
Rated frequency	45 - 65 Hz
Insulating class	C-VDE0110
Rated short-circuit breaking capacity at $1.1 \times U_n$	
AC	50 kA / $\cos \varphi = 0.2$
DC	8 kA / $t = 15 \text{ ms}$

Dimensions [mm]

I_n (A)	$\varnothing A$	$\varnothing B$
DII for fuse-base E27		
2	21.5	6
4	21.5	6
6	21.5	6
10	21.5	8
16	21.5	10
20	21.5	12
25	21.5	14
DIII for fuse-base E33		
35	27	16
50	27	18
63	27	20

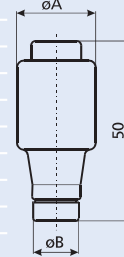

Characteristics Z-DII./SE

Time/current characteristics of Z-DII-Fuse-links 2 ... 63A gG(gL)

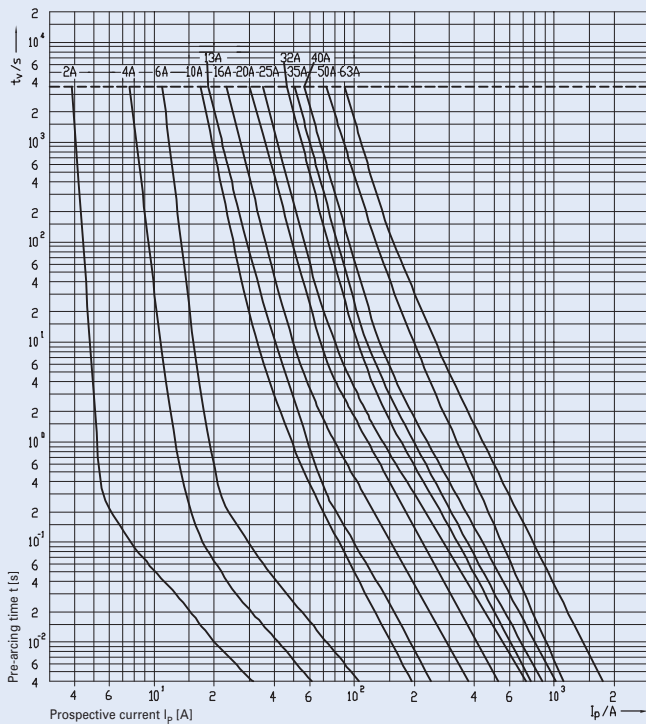

Let-through current characteristics of Z-DII-Fuse-links 2 ... 63A gG(gL)

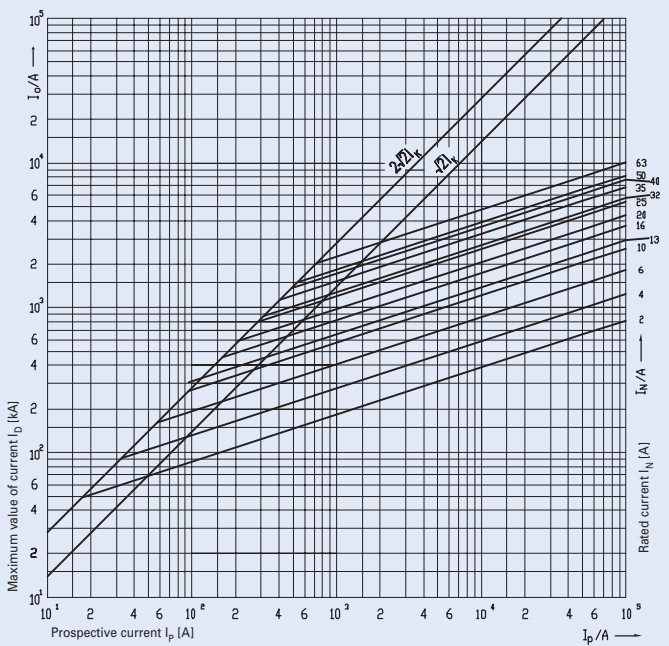

Characteristics Z-DII./SE

Melting energy characteristics I²t/A of Z-DII-Fuse-links 2 ... 63A gG(L)

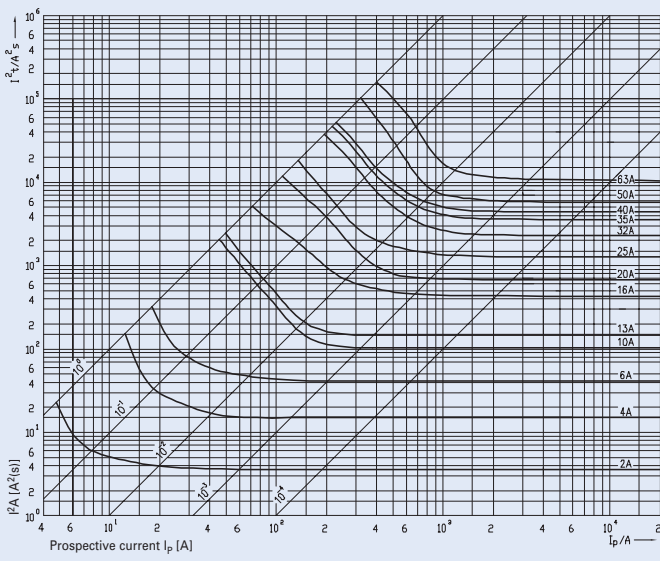

Time/current characteristics of Z-DII-Fuse-links 2 ... 63A DZ

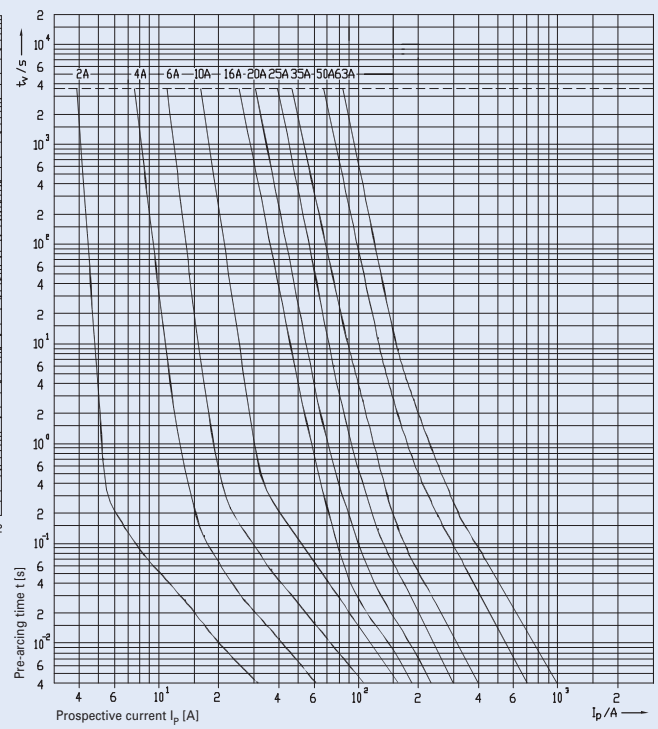

Screw-in Gauge Ring Z-DII./PS

- Used for current coding of DII.-SO/...

Technical Data

Electrical:

Rated current

DII	2 - 20 A
DIII	2 - 50 A

Gauge Ring Z-DII./PE

- Used for current coding of DII.-SO/...-PS

Technické údaje

Electrical:

Rated current

DII	2 - 25 A
DIII	35 - 63 A

Dimensions [mm]

I_n (A)	A	B	C	D
DII for fuse-base E27				
2	3/16"	6.5	17	24
4	3/16"	6,5	17	24
6	3/16"	6.5	17	24
10	3/16"	8.5	17	24
16	3/16"	10,5	17	24
20	3/16"	12.5	17	24
25	3/16"	14.5	17	24
DIII for fuse-base E33				
35	3/16"	16.5	17	24
50	3/16"	18.5	17	24
63	3/16"	20.5	17	24

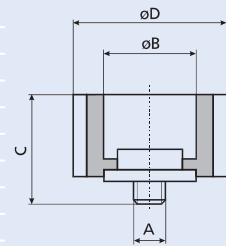

Screw Caps Z-DII./SK

- Used for DII.-SO

Technical Data

Electrical

Rated current

DII	max. 25 A
DIII	max. 63 A

Rated voltage

Z-DII/SK	500 V AC / 400 V DC
Z-DIII/SK	500 V AC / 400 V DC
Z-DIII/SK-690	690 V AC

Mechanical

Type

DII

DIII

Thread

E27

E33

Dimensions [mm]

I_n (A)	A	B	C	D
Z-DII/SK	34	44	12	35
Z-DIII/SK	43	44	12	43
Z-DIII/SK-690	43	65	12	43

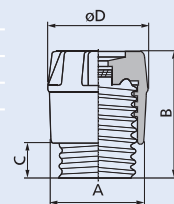

Practical Hint

A complete and functioning D-fuse system consists of

- base for screw-in gauge ring + fuse-link + screw-in gauge ring + screw cap
- base for gauge ring + fuse-link + gauge ring + screw cap

The gauge ring is not required for the highest rated current of each size (DII ... 25 A and DIII ... 63 A).

Fuse bases for standard mounting DII.-SO/...

- Fuse bases for fuse links DII and with thread E27 to 25 A
- Fuse bases for fuse links DIII and with thread E33 to 63 A
- For mounting onto device rail, type ...MP for mounting onto panel

Technical Data

	Type	Thread	Dimensions							
			A	B	C	D	E	F	G	H
1-pole fuse bases with plastic cover	DII-SO/25/1-MP	E27	41	39	44	47	60	62	-	-
	DII-SO/25/1	E27	41	39	44	47	60	62	-	-
	DIII-SO/63/1-MP	E33	43	47	44	47	56	79	-	-
	DIII-SO/63/1	E33	43	47	44	47	56	79	-	-
Plastic cover	DII-SO/25/1									
	DII-SO/25/1-MP	E27	40	24	10,8	80				
	DIII-SO/63/1									
	DIII-SO/63/1-MP	E33	49	21	9	80				
3-pole fuse bottoms linear	DII-SO/25/3	E27	41	121	44	47	60	30	4,3	50
	DIII-SO/63/3	E33	43	148	44	47	56	32	4,3	62

Dimensions [mm]

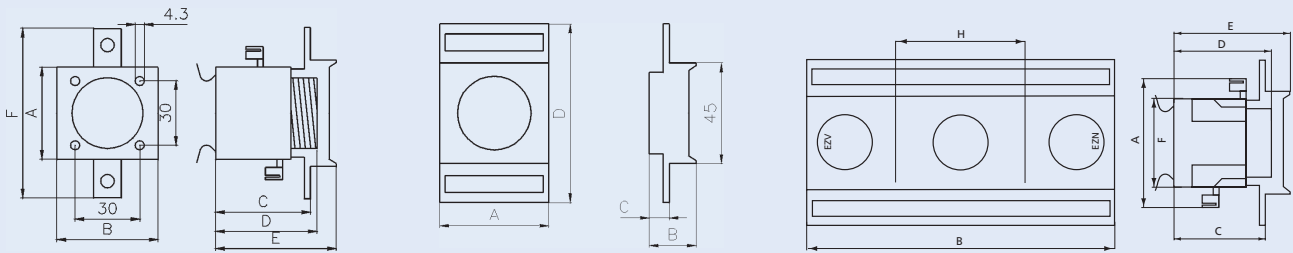

Fuse bases for direct mounting onto busbars

- Fuse bases for fuse links DII and with thread E27 to 25 A
- Fuse bases for fuse links DIII and with thread E33 to 63 A
- Including shock hazard protection cover, front and bottom plate and description label
- Delivered empty without screw caps
- Version -R for gauge rings Z-DII./PE
- Version -R-PS for screw/in gauge rings Z-DII./PS

Technical Data

	DII-SO/25/3-R(-PS)	DIII-SO/63/3-R(-PS)
Electrical		
Number of poles	3	3
Rated operational voltage U_e	500 V AC	690 V AC
Rated frequency	40 - 60 Hz	40 - 60 Hz
Rated operational current I_e	25 A	63 A
Conv. thermal current with fuse-links I_{th}	25 A	63 A
Rated duty	uninterrupted duty	uninterrupted duty
Rated conditional short-circuit current	50 kA _{r.m.s.}	50 kA _{r.m.s.}
Overvoltage category	III	III
Rated impulse withstand voltage U_{imp}	4 kV	4 kV
Power loss per current path	0.4 W	3.34 W
Power loss of base without fuse-links	1.2 W	10 W
Max. permissible power loss of fuse-links	4 W	7 W
Mechanical		
Device height	200 mm	200 mm
Device width	45 mm	54 mm
Weight	140 g	150 g
Mounting onto busbars, without drilling or screwing	12x5/10 20x5/10 25x5/10 30x5/10	12x5/10 20x5/10 25x5/10 30x5/10
Degree of protection while operating	IP20	IP20
Terminals	Lift terminals	Lift terminals
Terminal capacity	1.5 - 25 mm ²	1.5 - 25 mm ²
Tightening torque of terminal screws	2,6 Nm	2.6 Nm
Electrical thread type	E27	E33
Ambient temperature range	-25 to +55 °C *)	-25 to +55 °C *)
*) (35 °C normal temperature, at 55 °C with reduced operational current)		
Pollution degree	3	3
Climatic resistance: moist heat	EN 60068-2-78, EN 60068-2-30	

Dimensions [mm]

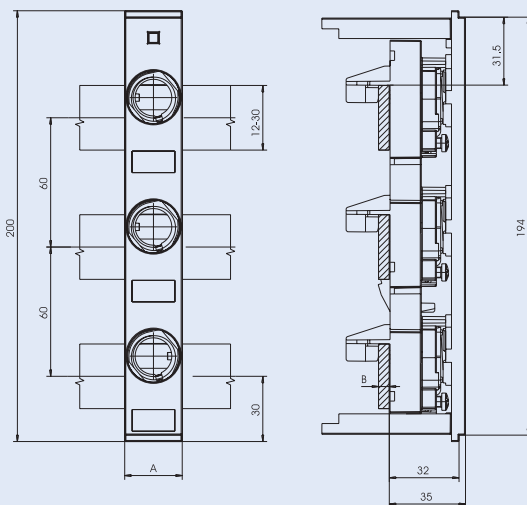

Type	A
DII-SO/25/3-R(-PS)	45
DIII-SO/63/3-R(-PS)	54

For types and art. numbers see page 75

Fuse-Links Z-C10, Z-C14, Z-C22

- For fuse-switch-disconnectors C10-SLS, VLC14 and VLC22
- According to EN 60269-1 and IEC 60269-2-1
- Rated voltage 690, 500, 400 V, 50 Hz (according to I_n)
- High breaking capacity 100 kA
- Low let-through energy
- Characteristic gG suitable for protection of electrical lines, cables
- Characteristic AM suitable for protection of circuits with motors

Connection diagram



Technical Data

Electrical	Z-C10/SE 10x38	Z-C14/SE 14x51	Z-C22/SE 22x58
Operating class	gG (gL)	gG (gL)	gG (gL)
Rated voltage U_n	1 - 25 A / 500 V AC 32 A / 400 V AC	2 - 32 A / 690 V AC 40 - 50 A / 500 V AC	16 - 40 A / 690 V AC 50 - 100 A / 500 V AC
Operating class	aM	aM	aM
Rated voltage U_n	1 - 16 A / 500 V AC 20 - 32 A / 400 V AC	2 - 25 A / 690 V AC 32 - 50 A / 500 V AC	16 - 50 A / 690 V AC 80 - 100 A / 500 V AC
Rated frequency	50 Hz	50 Hz	50 Hz
Rated short-circuit breaking capacity	100 kA	100 kA	100 kA

Max. Power dissipation

Operating class gG - Power dissipations 400 V / 500 V / 690 V

	max. 3 W acc. IEC 60269-2	max. 5 W acc. IEC 60269-2	max. 9,5 W acc. IEC 60269-2
Rated current I_n	10x38	14x51	22x58
1	0.55		
2	0.90	1.45	
4	1.45	1.60	
6	1.55	1.95	
8	1.05	1.40	
10	1.10	1.45	
12	1.55	1.95	
16	2.85	3.00	3.05
20	2.80	3.15	3.40
25	2.95	4.10	4.40
32	3.00	4.80	5.10
40		4.75	7.20
50		4.95	7.60
63			8.00
80			8.20
100			9.40

Operating class aM - Power dissipations 400 V / 500 V / 690 V

	max. 1,2 W acc. IEC 60269-2	max. 3 W acc. IEC 60269-2	max. 7 W acc. IEC 60269-2
Rated current I_n	10x38	14x51	22x58
1	0.55		
2	0.60	0.80	
4	0.55	0.60	
6	0.45	0.50	
8	0.45	0.50	
10	0.55	0.90	
12	0.55	0.95	
16	0.80	1.10	1.30
20	0.95	1.40	1.45
25	1.00	2.10	2.45
32	1.20	2.10	2.50
40		2.60	2.95
50		2.95	3.30
63			4.00
80			5.30
100			6.40

Dimensions [mm]

Type	Size	a	$b_{max.}$	c	$d_{min.}$	r
Z-C10	10x38	38,0±0,6	10,5	10,3±0,1	6	1,5±0,5
Z-C14	14x51	51,0+0,6/-1	13,8	14,3±0,1	7,5	2±0,5
Z-C22	22x58	58,0+1/-2	16,2	22,2±0,1	11	2±0,5

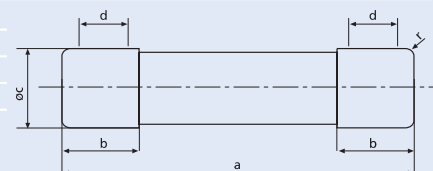

For types and art. numbers see page 76, 77

Characteristics Z-C10/SE, Operating class gG, 10x38

Time/current characteristics of Z-C10-Fuse-links 2 ... 32A gG(gL)

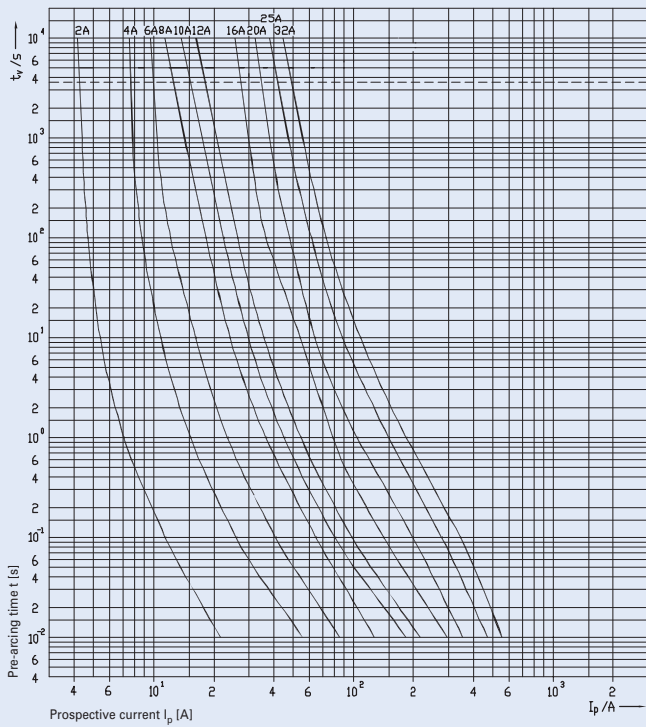

Let-through current characteristics of Z-C10-Fuse-links 2 ... 32A gG(gL)

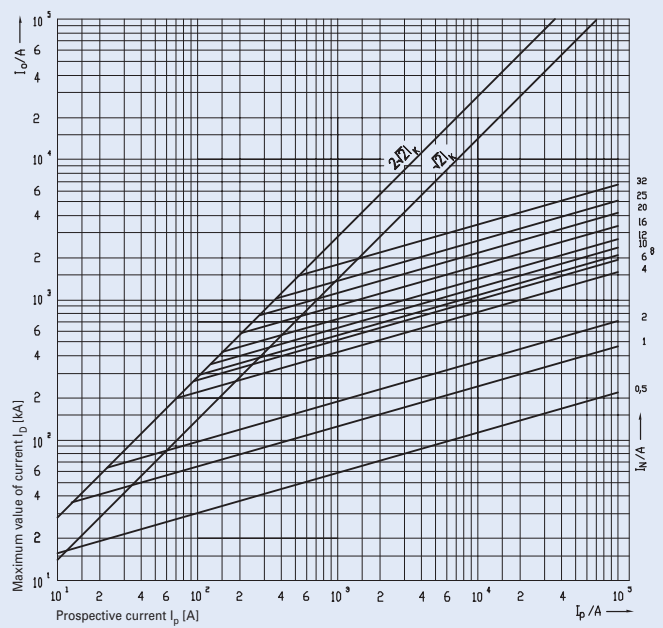

Melting energy characteristics I^2t/A of Z-C10-Fuse-links 1 ... 32A gG(gL)

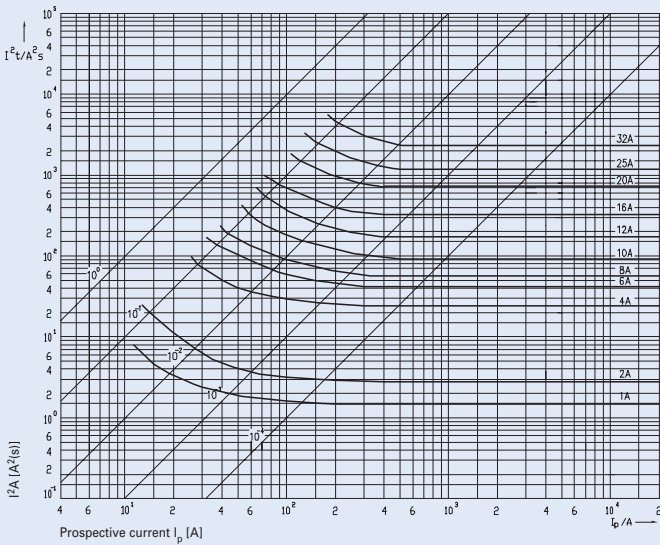

Characteristics Z-C14/SE, Operating class gG, 14x51

Time/current characteristics of Z-C14-Fuse-links 2 ... 50A gG(gL)

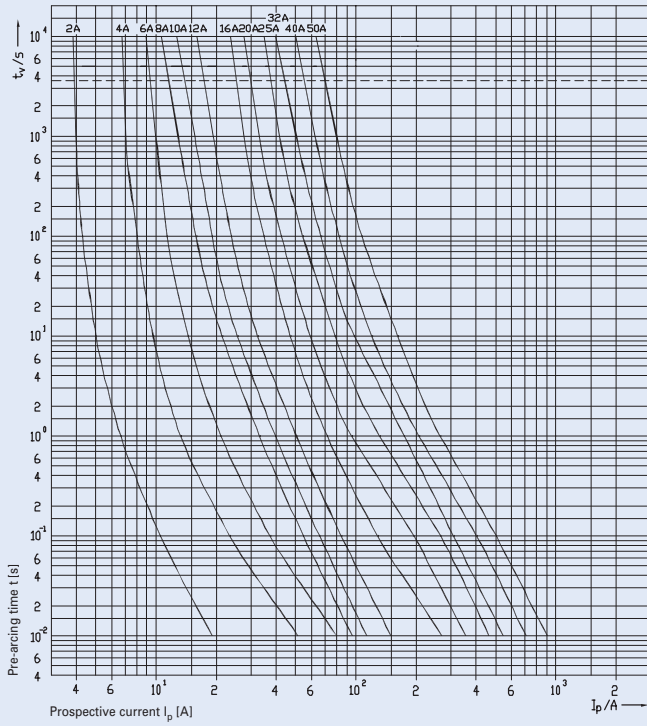

Let-through current characteristics of Z-C14-Fuse-links 2 ... 50A gG(gL)

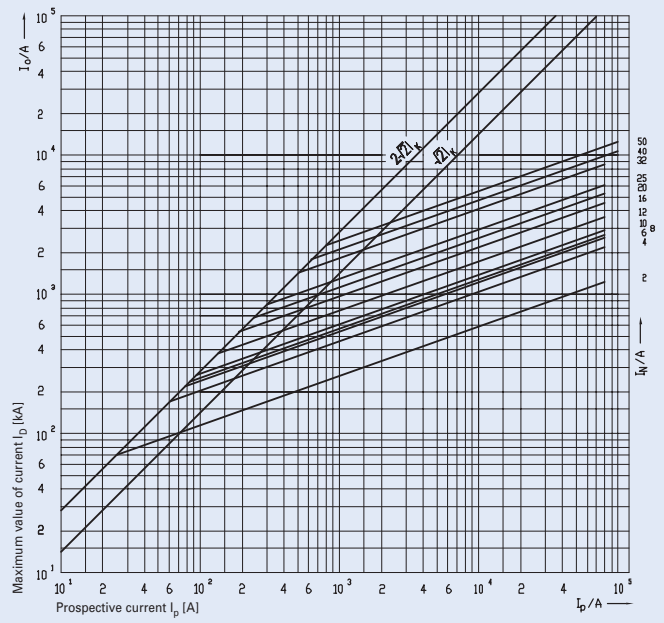

Melting energy characteristics I^2t/A of Z-C14-Fuse-links 2 ... 50A gG(gL)

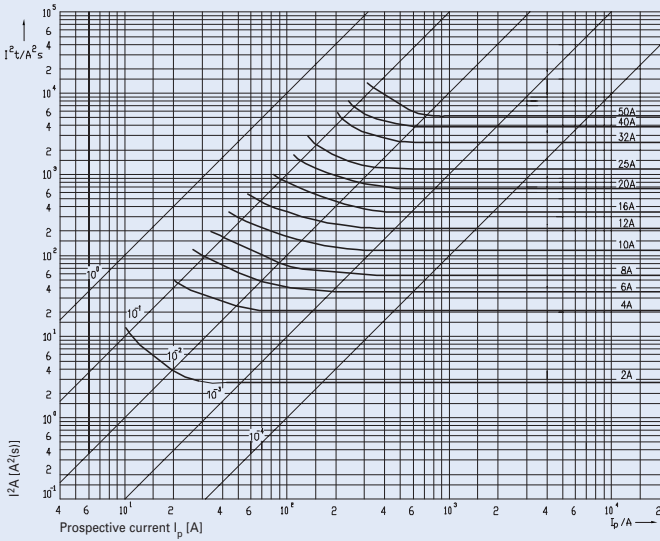

Characteristics Z-C22/SE, Operating class gG, 14x51

Time/current characteristics of Z-C22-Fuse-links 16 ... 100A gG(gL)

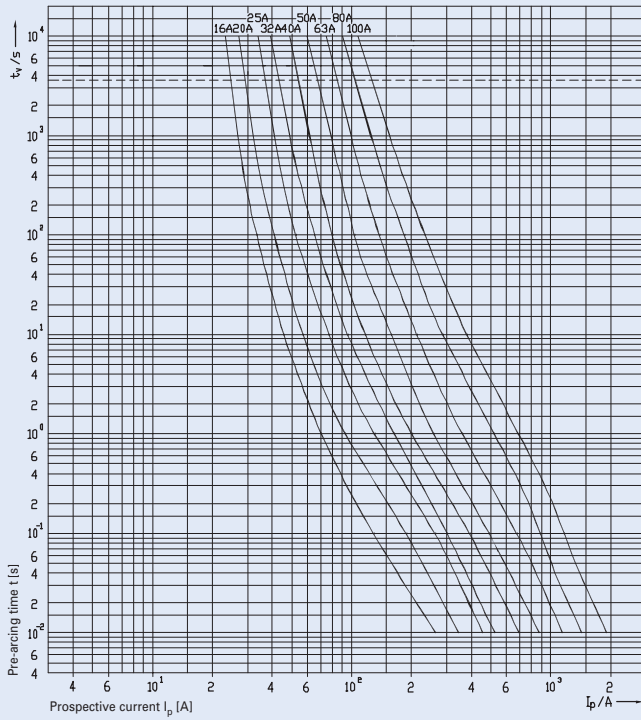

Let-through current characteristics of Z-C22-Fuse-links 16 ... 100A gG(gL)

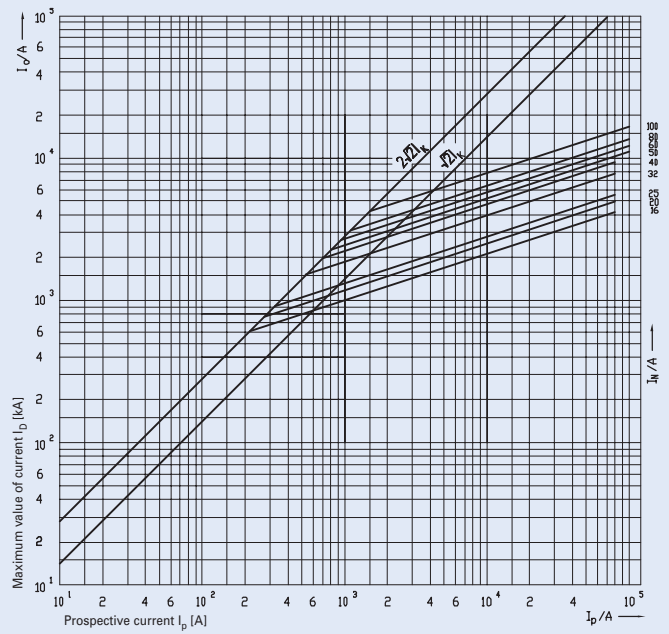

Melting energy characteristics I^2t/A of Z-C22-Fuse-links 16 ... 100A gG(gL)

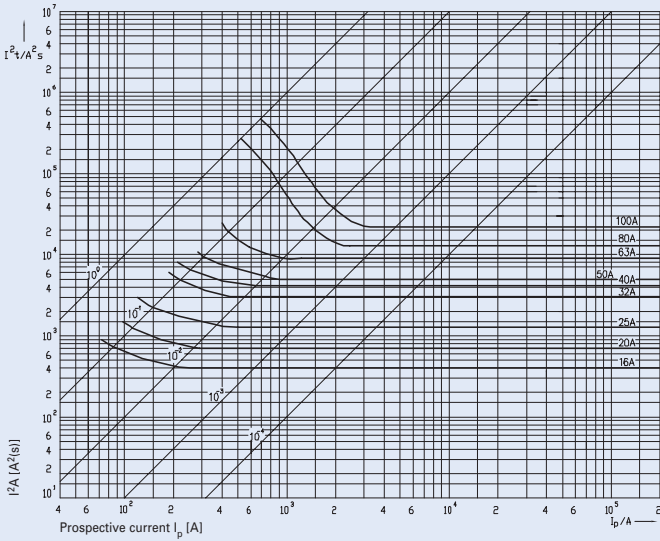

Characteristics Z-C../SE, Operating class aM, 10x38 - 14x51 - 22x58

Time/current characteristics of Z-C...Fuse-links 16 ... 100A gG(L)

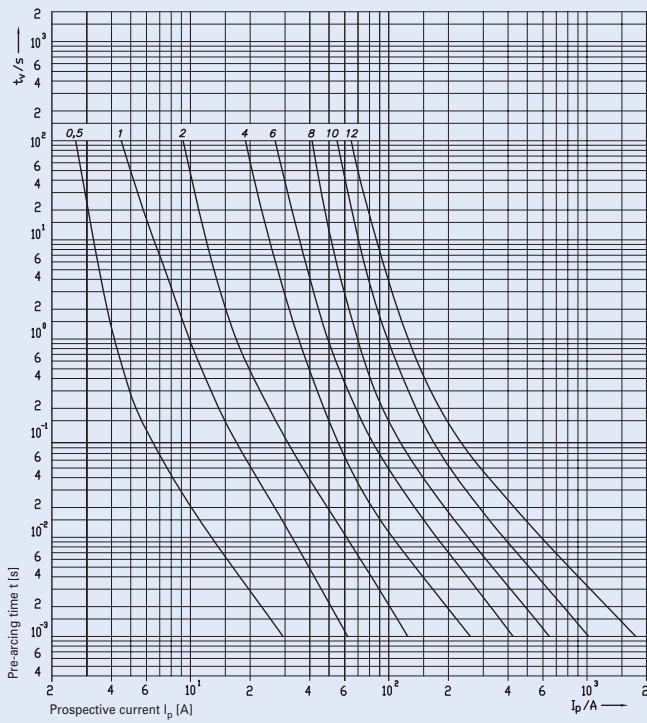

Time/current characteristics of Z-C...Fuse-links 16 ... 100A aM

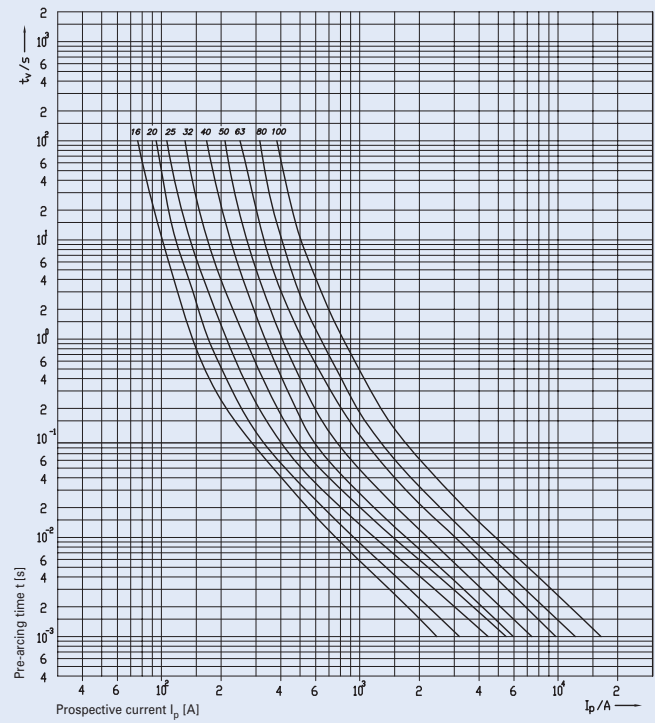

Fuse-Switch-Disconnecter C10-SLS, VLC

- For cylindrical fuse-links Z-C10, Z-C14, Z-C22
- Mainly for industrial applications
- Design according to EN 60947-3
- Types /L with visual tripping indicator (flashing)
- Sealable

Connection diagram

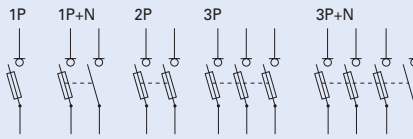

Technical Data

	C10-SLS	VLC14	VLC22
Electrical			
Number of poles	1P, 1P+N, 2P, 3P, 3P+N	1P, 1P+N, 2P, 3P, 3P+N	1P, 1P+N, 2P, 3P, 3P+N
Rated operational voltage U_e			
1P	690 V, 50 Hz	690 V, 50 Hz	690 V, 50 Hz
1P+N	400 V, 50 Hz	690 V, 50 Hz	690 V, 50 Hz
2P, 3P, 3P+N	690 V, 50 Hz	690 V, 50 Hz	690 V, 50 Hz
Rated operational current I_e	32 A	50 A	100 A
Rated conditional short-circuit current	100 kA (at 400 V)	100 kA	100 kA
Rated short-time withstand current I_{cw}	300 A	600 A	1200 A
Utilization category	AC 22 B	AC 22 B	AC 21 B
Rated insulation voltage U_i	690 V	690 V	690 V
Overvoltage category	II	IV	IV
Rated impulse withstand voltage U_{imp}	4 kV	8 kV	8 kV
Power loss per current path without fuse-link	0.9 W	1 W	3.1 W
Maximum permissible power loss of fuse-links			
gG	3 W	5 W	9.5 W
aM	1.2 W	3 W	7 W
Mechanical			
Frame size	45 mm	45 mm	45 mm
Device height	83.3 mm	94 mm	121 mm
Device width	17.5 mm per pole	27 mm per pole	36 mm per pole
Weight			
1P	58 g	100 g	160 g
1P+N	70 g	222 g	355 g
2P	120 g	201 g	310 g
3P	180 g	308 g	480 g
3P+N	195 g	437 g	680 g
Mounting	Quick fastening on DIN rail IEC/EN 60715		
Degree of protection	IP20	IP20	IP20
Terminals above and below	lift terminals	lift terminals	lift terminals
Terminal capacity	0.5 - 10 mm ² AWG 20-8	1.5 - 35 mm ² AWG 16-2	4 - 50 mm ² -
Tightening torque of terminal screws	≥ 1.2 Nm	2.5 - 3 Nm	2.5 - 3 Nm
Ambient temperature range	-25 to +40 °C	-25 to +40 °C	-25 to +40 °C
Flame class	glow wire tested 960 °C	glow wire tested 960 °C	glow wire tested 960 °C
Pollution degree	2	1	1
Comparative tracking index	CTI 450	CTI 400	CTI 400

Dimensions [mm]

C10-SLS

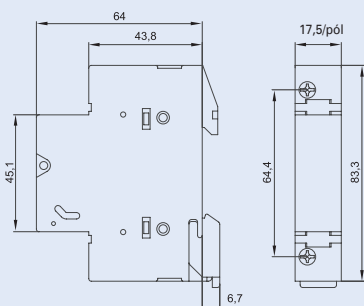

VLC 14

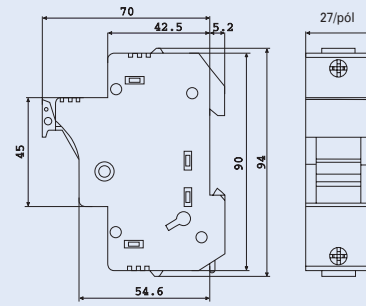

VLC 22

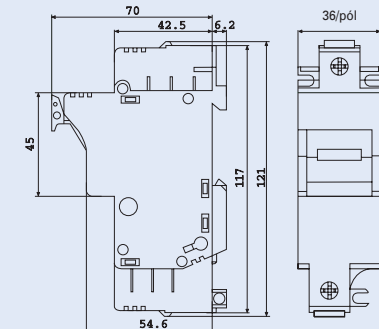

For types and art. numbers see page 77

Fuse-Links Z-C10../PV Photovoltaic application

- According to EN 60269-1 and EN 60269-4
- For fuse-switch-disconnectors FCFDC10DI...-SOL

Connection diagram



Technical Data

Electrical	Z-C10/SE-.../PV 10x38
Rated voltage U_n	6 - 20 A / 1000 V DC 25 A / 900 V DC
Rated frequency	DC
Rated short-circuit breaking capacity $t = L/R$	30 kA 2 ms

Max. Power dissipation

Rated current I_n	Pre-arcing Joule integral $L/R = 2$ ms	Operating Joule integral $L/R = 2$ ms	Power dissipation at $0.7 \times I_n$	Power loss at I_n P_d	Weight P_d
[A]	[A ² s]	[A ² s]	[W]	[W]	[g]
2	1.3	3.5	1.47	1.00	10
4	3.3	28	0.52	1.25	10
6	5.5	45	0.73	1.65	10
8	8	62	0.93	1.9	10
10	11	88	1.06	2.3	10
12	23	180	1.03	1.9	10
16	35	270	1.00	2.5	10
20	50	430	1.18	3.25	10
25	75	620	1.25	3.45	10

Dimensions [mm]

Type	Size	a	$b_{max.}$	c	$d_{min.}$	r
Z-C10	10x38	38.0±0.6	10.5	10.3±0.1	6	1.5±0.5

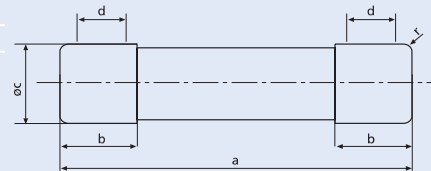

Characteristics Z-C10/SE-.../PV, Photovoltaic application

Time/current characteristics of Z-C10/SE-.../PV Fuse-links 2 ... 25A

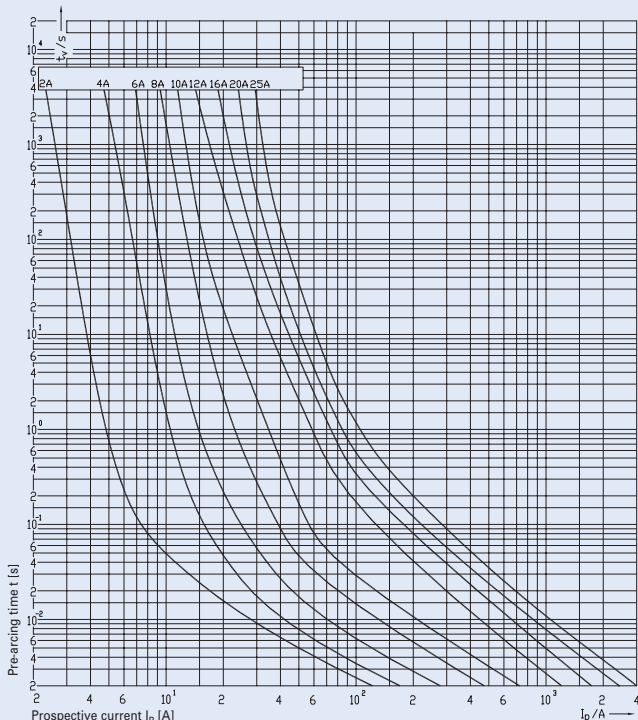

For types and art. numbers see page 78

Fuse disconnectors FCFDC10DI-..SOL for photovoltaic applications

- Design according to EN 60947-1 ed. 4.0
EN 60947-3 ed. 2 + A1
- Fuse disconnectors for PV strings
- For use with fuse links Z-C10/SE..PV
- Version with visual tripping indicator:
 - 50-400 V flashing
 - 400-1000 V permanent light
- Sealable
- Delivered without fuse links

Connection diagram

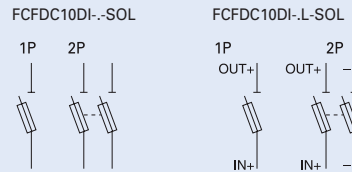

Technical Data

Electrical:

Number of poles	1P, 2P
Rated operational voltage U_e	1000 V DC
Rated current I_e	25 A
Conditional short-circuit current	10 kA
Utilization category	DC 20 B
Rated insulation voltage U_i	1000 V DC
Overvoltage category	III
Rated impulse withstand voltage U_{imp}	6 kV
Power loss per current path	
without fuse-link	0,9 W
Maximum permissible power loss of fuse-links	3 W

Mechanical:

Frame size	45 mm
Device height	83.3 mm
Device width	17.5 mm per pole
Weight	
1P	58 g
2P	70 g
Mounting	Quick fastening on DIN rail EN 60715
Degree of protection	IP20
Terminals	lift terminals
Terminal capacity	0.5 - 10 mm ² AWG 20-8
Tightening torque of terminal screws	1.2 Nm
Ambient temperature range	-25 to +40 °C
Flame class	glow wire tested 960 °C
Pollution degree	2
Comparative tracking index	CTI 450

Dimensions [mm]

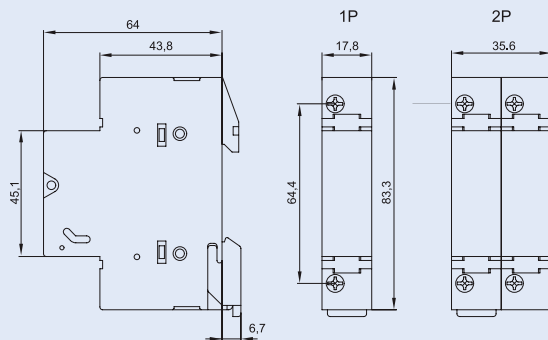

Photovoltaic applications

Earthed system

FCFDC10DI-1-SOL

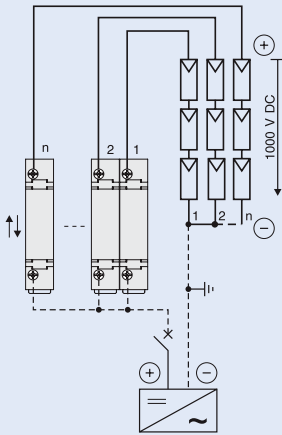

FCFDC10DI-1L-SOL

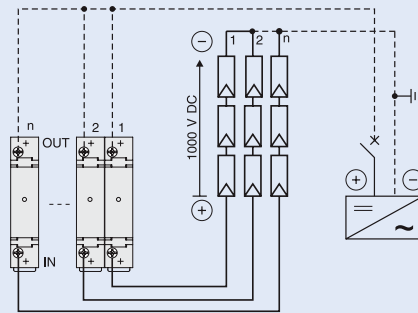

Unearthed system

FCFDC10DI-1-SOL

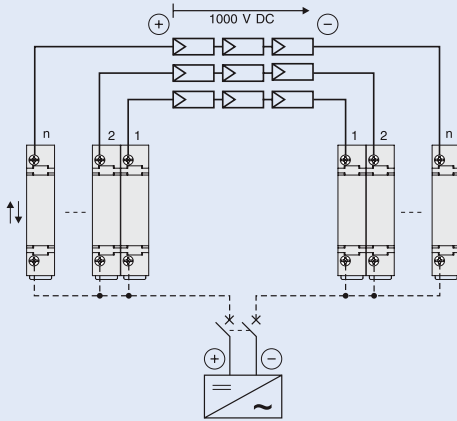

FCFDC10DI-2L-SOL

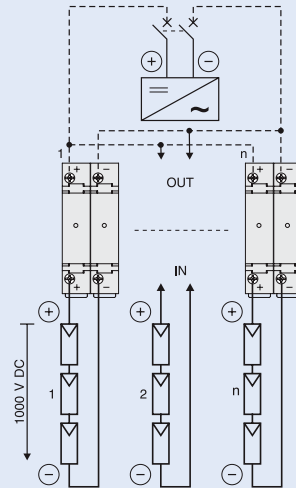

Fuse-Links Z-D0../SE

- According to DIN VDE 0636, DIN 49522
- For fuse-switch-disconnectors Z-SLS, -SLK
- For fuse-bases D0.-SO and Z-D02/R/3

Connection diagram

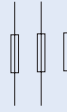

Technical Data

Electrical

Operating class	gG (gL)
Rated voltage	
AC	400 V
DC	220 V
Rated frequency	45 - 65 Hz
Rated insulation voltage U_i	2500 V
Rated short-circuit breaking capacity	50 kA (AC), 8 kA (DC)

Mechanical

Size	
D01	1, 2, 4, 6, 10, 13, 16 A
D02	20, 25, 32, 35, 40, 50, 63 A

Characteristics Z-D0../SE

Time/current characteristics of Z-D0-Fuse-links 2 ... 63A gG(gL)

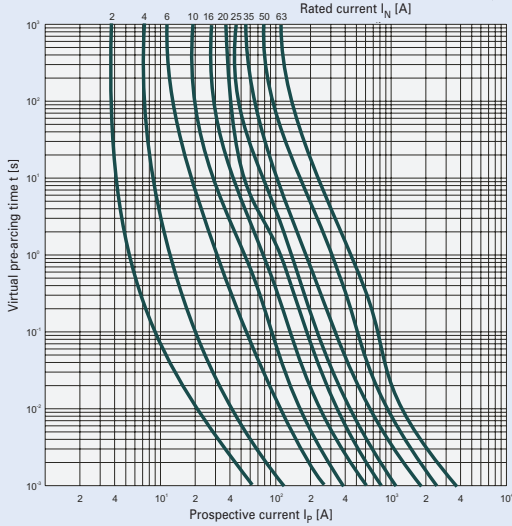

Let-through current characteristics of Z-D0-Fuse-links, 2...63 A gG(gL)

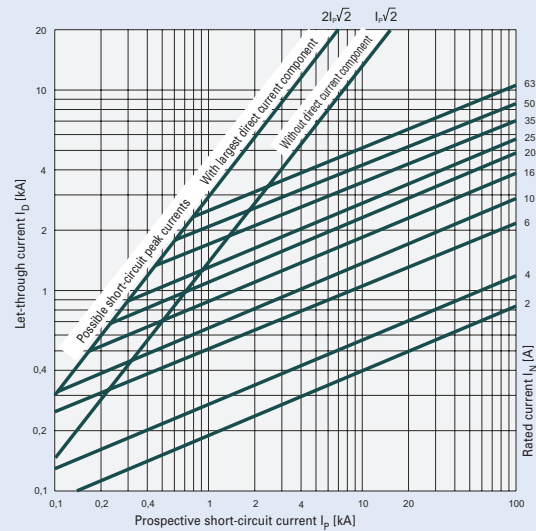

Cartridge Ring Adapter Insert D0

- According to DIN 49523
- For fuse links Z-D01/SE and Z-D02/SE

Technical Data

Electrical:

Rated current	
D01	2 - 10 A
D02	20 - 50 A
D02-D01	2 - 16 A

Screw Caps Z-D0../SK

- Screw caps for systems D01 and D02

Technical Data

Electrical:

Rated current	
D01	max. 16 A
D02	max. 63 A

Mechanical:

Electrical thread	
D01	E14
D02	E18

Practical Hint

A complete and functioning D-fuse system consists of base + fuse-link + cartridge-ring adapter insert + screw cap.
The cartridge-ring adapter insert is not required for the highest rated current of each size (D01...16A and D02...63A).

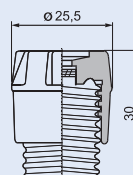

For types and art. numbers see page 79, 80

Fuse-Base D01 and D02 for mounting onto device rail

- According to DIN VDE 0636-301
- Size D01/D02
- Base with terminal cover
- Silikon- and chlorine free
- Cartridge-ring adapter inserts Z-D0./PE for D01 2-10A, D02 20-50A required for current coding
- Cartridge-ring adapter inserts Z-D02-D01-PE-.. for D02 fuse-base and D01 fuse-links available

Technical Data

Electrical

Number of poles	1P, 3P
Rated voltage	400 VAC, 250 VDC
Rated current	
D01	16 A
D02	63 A
Conditional short-circuit current tested with inserts	50 kA (AC)
Operating class gG (gL)	8 kA (DC)

Mechanical

Frame size	45 mm
Device height	68 mm
Device width	27 mm per pole
Weight	1P 3P
	76 g 230 g
Electrical thread	
D01	E14
D02	E18
Mounting	quick fastening on DIN rail EN 60715
Upper and lower terminals	double function terminals
Terminal capacity	1.5 - 35 mm ²
Tightening torque of terminal screws	2.5 - 3 Nm
Comparative tracking index	CTI 200

Dimensions [mm]

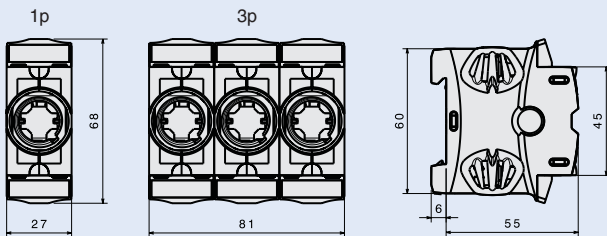

Busbar Examples

1-phase **35 mm²**

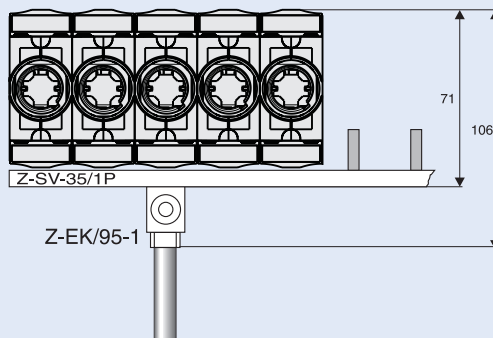

3-phases **16 mm²**

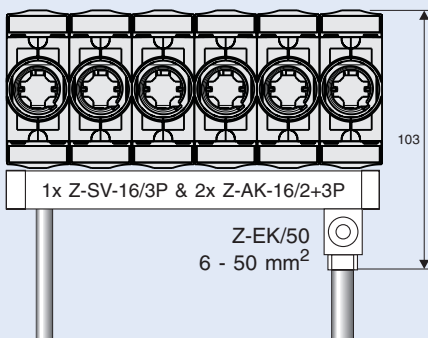

3-phases **35 mm²**

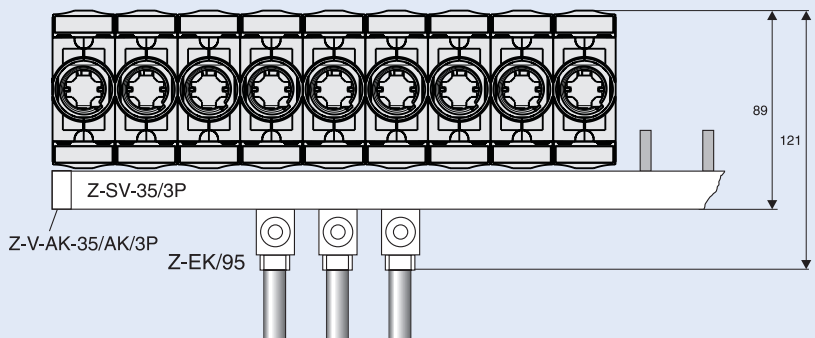

Terminal capacity Z-EK/95, Z-EK/95-1

- 25 - 95 mm² rigid/stranded
- 16 - 70 mm² flexible with wire end ferrules

For types and art. numbers see page 80

Slide Fuse-Base D02 (+D01) for direct mounting onto busbars

- Design according to EN 60269-1, VDE 0636 part 301
- Vertical and horizontal mounting possible
- Delivered empty and without screw caps
- For 60 mm - busbar system, 5 or 10 mm thick
- Suitable for busbars 12 x 5/10, 20 x 5/10, 25 x 5/10, 30 x 5/10, with double T profile
- Does not contain halogens, phosphorus or silicon
- Recyclable
- Marking area on the base and cover
- For fuse-links DIN 49522 D02 20...63A 400VAC / 250VDC
- For cartridge-ring adapter inserts DIN 49523
- Cartridge-ring adapter inserts Z-D02-D01-PE... for D01 fuse-links 1...16 A available

Technical Data

Electrical

Number of poles	3
Rated operational voltage U_e	400 V AC
Rated frequency	40 - 60 Hz
Rated operational current I_e	63 A
Conv. thermal current with fuse-links I_{th}	63 A
Rated duty	uninterrupted duty
Rated conditional short-circuit current	50 kA _{r.m.s.}
Overvoltage category	IV
Rated impulse withstand voltage U_{imp}	6 kV
Power loss per current path	0.5 W
Power loss of base without fuse-links	1.5 W
Max. permissible power loss of fuse-links	5.5 W

Mechanical

Device height	201 mm
Device width	27 / 36 / 54 mm
Weight	163 g / 184 g / 205 g
Mounting onto busbars, without drilling or screwing	12x5/10, 15x5/10, 20x5/10, 25x5/10, 30x5/10
Degree of protection while operating	IP20
Terminals	Lift terminals
Terminal capacity	1.5 - 35 mm ²
Tightening torque of terminal screws	3 - 4 Nm
Electrical thread type	E18
Ambient temperature range	-25 °C to +55 °C
Pollution degree	3
Flame class according UL94	V0
Comparative tracking index	CTI 600
Climatic resistance: moist heat	constant acc. to EN 60068-2-78 cyclical acc. to EN 60068-2-30

Dimensions [mm]

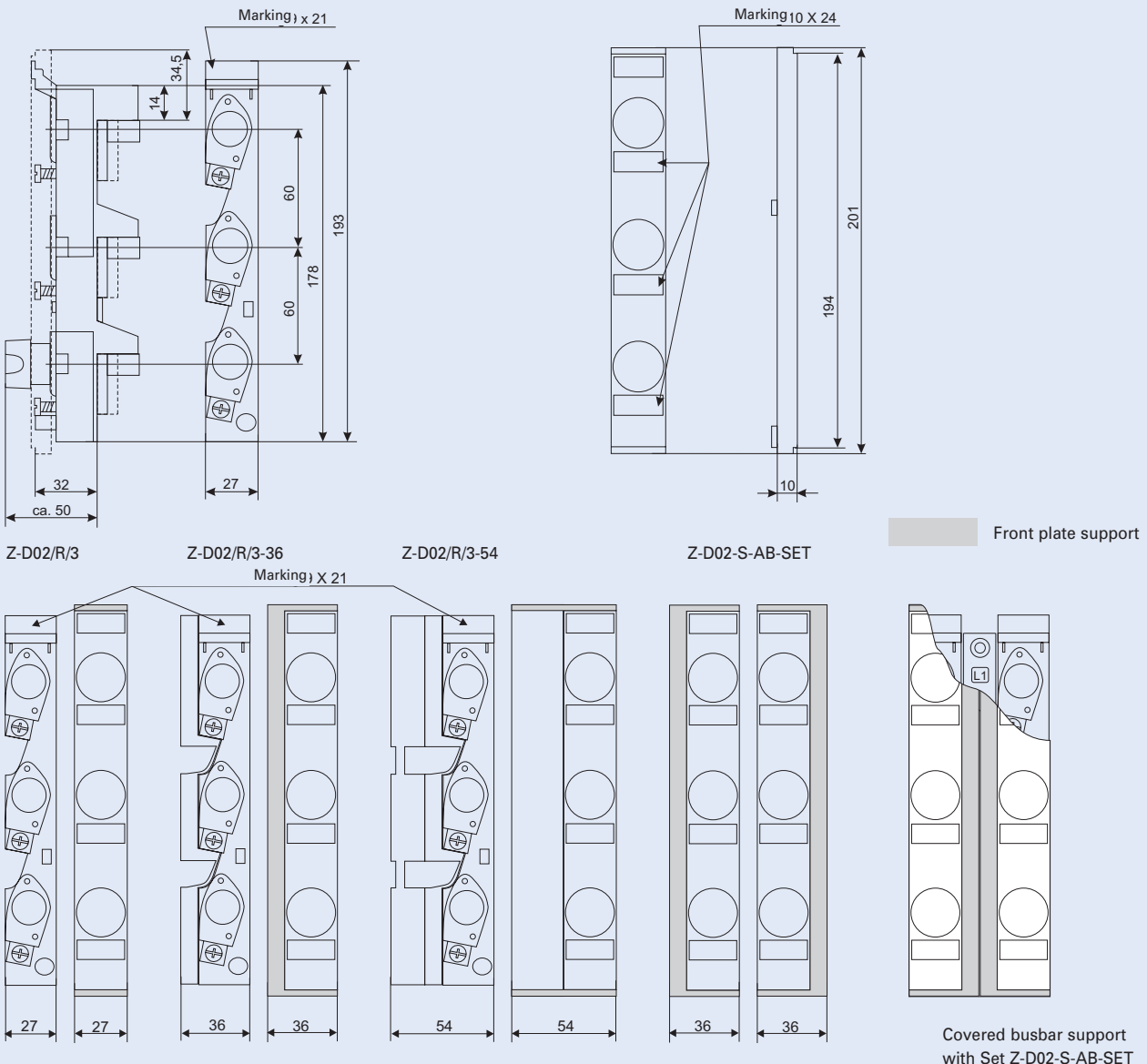

For types and art. numbers see page 80

Switch-Disconnecter-Fuse D02-S for direct mounting onto busbars

- Switch-Disconnectors with fuses (delivered without fuse links)
- For fuse links Z-D02/SE and Z-D01/SE (with cartridge-ring adapter insert Z-D02-D01/PE-... and adapter spring Z-D02/SIKA-HF)
- For mounting onto 60 mm busbar systems e.g. SASY 60i
- Suitable for busbars 20 x 5/10, 30 x 5/10, with double T profile
- Rated current 63 A, rated operating voltage 400 V AC
- Utilization category AC-23B
- Including shock hazard protection cover, front and bottom plate and description label
- Delivered empty without screw caps
- 3-pole
- Width 36 mm

Connection diagram



Technical Data

Electrical

Number of poles	3P
Rated operational voltage U_e AC	400 V / 40-60 Hz
Rated operational current I_e	63 A
Conventional thermal current with fuse-links I_{th}	63 A
Rated duty	Uninterrupted duty
Rated conditional short-circuit current	50 kA _{r.m.s}
Utilization category	AC 23 B
Overvoltage category	III
Rated impulse withstand voltage U_{imp}	8 kV
Power loss per current path	2 W at I_e
Power loss per current path with fuse-link	7.5 W at I_e
Max. permissible power loss of fuse-links	5.5 W

Mechanical

Device height	212 mm
Device width	36 mm
Weight	260 g
Mounting	with a distance between busbars of 60 mm, SASY 60i
Degree of protection (in use)	IP30
Terminals	lift terminals
Terminal capacity	1.5 - 25 mm ² Cu
Tightening torque of terminal screws	max. 2.6 Nm
Electrical thread	E18
Temperature range	-25 to +55 °C
Pollution degree	3

Dimensions [mm]

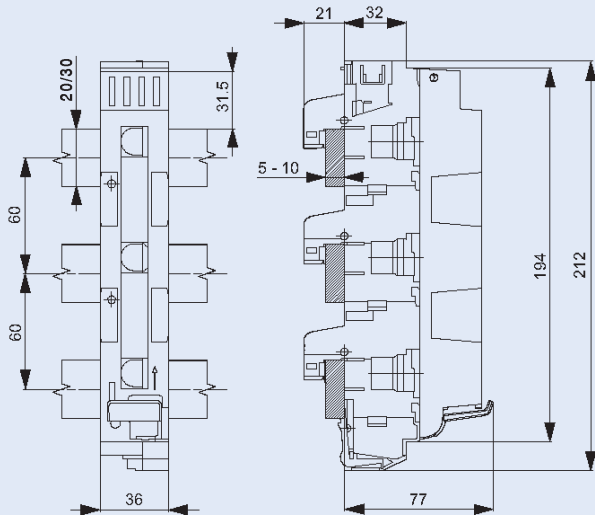

Cut-out for front plate

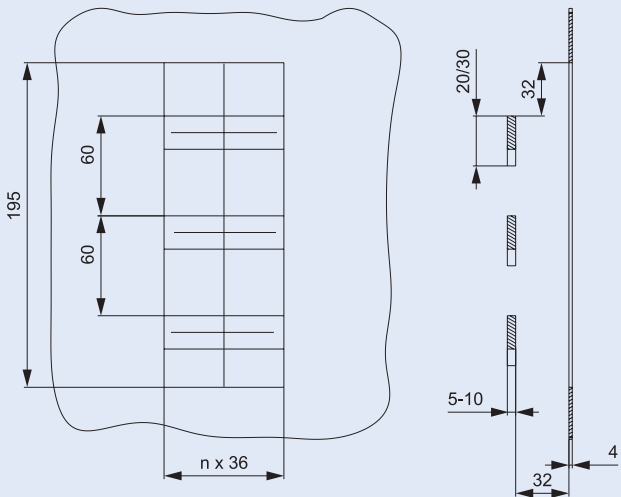

Slide Switch-Disconnecter-Fuse D02-LTS for direct mounting onto busbars

- Switch disconnectors with fuses (delivered without fuse links)
- Design according to EN 60947-3
- For fuse links Z-D02/SE and Z-D01/SE (with cartridge-ring adapter insert Z-D02-D01/PE-... and adapter spring Z-D02/SIKA-HF) and cylindrical fuse links Z-C10/SE (with adapter Z-D02-LTS-HF)
- For mounting onto 60 mm busbar systems e.g. SASY 60i
- Visual tripping indicator (flashing)
- Contact position indicator red - green
- Delivered empty
- Including adapter Z-D02-LTS-HF

- Version -HK with auxiliary contact
- Can be sealed with leads, lockable

Connection diagram

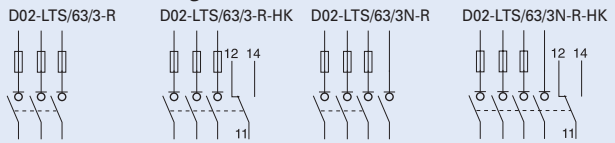

Technical Data

Electrical

Number of poles	3P/3P+N
Rated operational voltage U_e AC	400 V / 40-60 Hz
Rated operational current I_e	63 A
Rated uninterrupted current I_u	63 A
Rated duty	Uninterrupted duty
Rated short-circuit capacity I_{cm}, I_{cn}	50 kA _{r.m.s.}
Utilization category	AC 22 B
Overvoltage category	IV
Rated impulse withstand voltage U_{imp}	6 kV
Power loss per current path	1.5 W at I_e
Power loss per current path with fuse-link	7 W at I_e
Max. permissible power loss of fuse-links	5.5 W

Mechanical

Device height 3P/3P+N	226/262 mm
Device width	27 mm
Weight	340 g
Mounting onto busbars, without drilling or screwing	12x5/10 mm 20x5/10 mm 25x5/10 mm 30x5/10 mm
Degree of protection while operating (built-in)	IP20/IP40
Terminals	Lift terminals
Terminal capacity	1.5 - 35 mm ² Cu
Tightening torque of terminal screws	max. 4 Nm
Temperature range	-25 to +55 °C
Pollution degree	3

Auxiliary switch electrical

1 CO	5 A / 250 V AC
Max. thermal back-up protection	2 A gL PL7-B4/...HS

Connection

Femal push-on connector	2.8 x 0.5 mm
-------------------------	--------------

Dimensions [mm]

3P

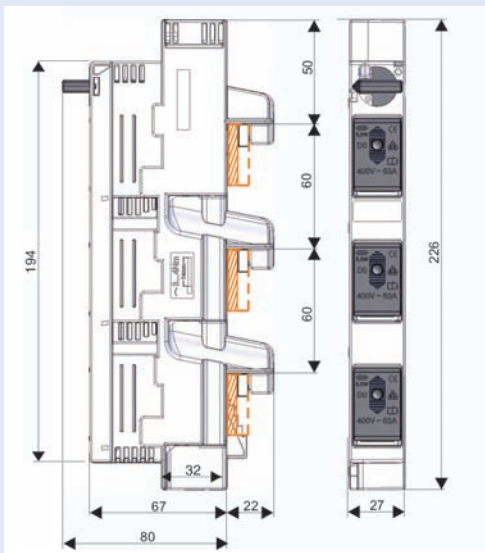

3P+N

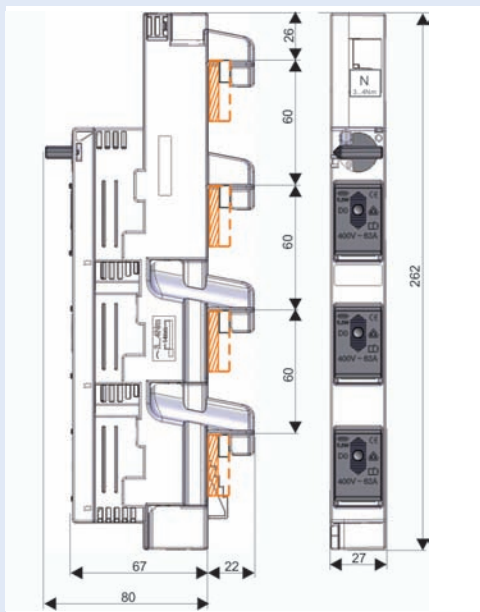

Switch-Disconnecter-Fuse Z-SLS/D01

- Switch disconnectors with fuses for fuse links Z-D01/SE
- Visual tripping indicator
- Delivered without fuse links
- Rated current 16 A
- Rated operating voltage 230/400 V AC, 60 V DC (1-pole), 110 V DC (2-pole)
- Utilization category AC-22B, DC-21B
- Integrated mechanical current coding
- Can be sealed
- Supply side from top or bottom

Connection diagram

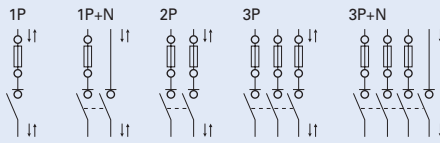

Technical Data

Electrical

Number of poles	1P, 1P+N, 2P, 3P, 3P+N
Rated operational voltage U_e	
AC	400 V
DC	1P to 60 V / 2P to 110 V
Rated operational current I_e	16 A
Rated uninterrupted current I_u	16 A
Rated short-circuit making capacity I_{cm}	50 kA _{r.m.s.}
Utilization category	AC 22 B, DC 21 B
Overvoltage category	IV
Rated impulse withstand voltage U_{imp}	6 kV
Power loss per current path	0.64 W at I_e
Power loss per current path with fuse-link	2.24 W at I_e

Mechanical

Frame size	45 mm
Device height	86 mm
Device width	17.5 mm per pole (1MU)
Weight	1P 90g 1P+N 170g 2P 180g 3P 270g 3P+N 350g
Mounting	quick fastening on DIN rail EN 60715
Degree of protection	IP20
Upper and lower terminals	lift terminals
Terminal capacity	1.5 - 25 mm ²
Tightening torque of terminal screws	max. 2.5 Nm
Temperature range	-25 to +60 °C
Flame class	V0, glow-wire tested 960 °C
Pollution degree	3
Comparative tracking index	CTI 600

Dimensions [mm]

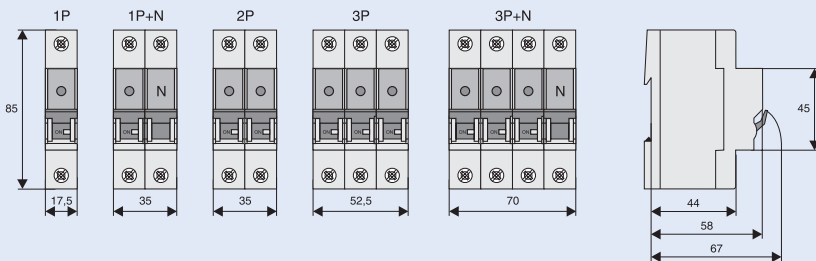

Busbar Connection Examples

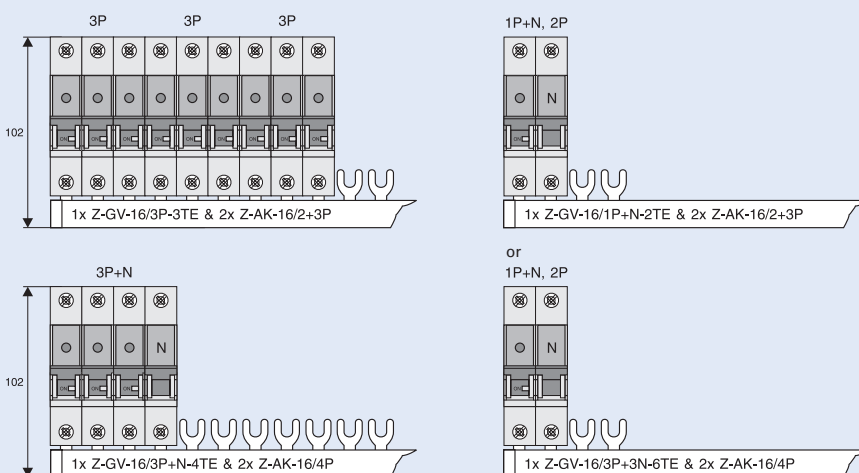

For types and art. numbers see page 81

Fuse-Switch-Disconnecter Z-SLS/NEOZ, Standard

- Fuse switch disconnectors for fuse links size D01 and D02
- Empty
- Mechanical current coding with fuse-link set
- Can be sealed
- Supply side from top or bottom

Connection diagram

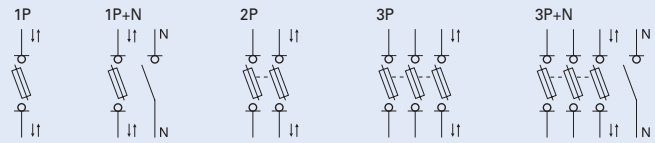

Technical Data

Electrical:

Number of poles	1P, 1P+N, 2P, 3P, 3P+N
Rated operational voltage U_e	
AC	400 V
DC	110 V (1P) / 220 V (2P)
Rated operational current I_e	63 A
Rated uninterrupted current I_u	63 A
Rated short-circuit making capacity I_{cm}	50 kAr.m.s
Utilization category	AC 22 B, DC 21 B
Overvoltage category	IV
Rated impulse withstand voltage U_{imp}	6 kV
Power loss per current path	0.5 W at I_e
Power loss per current path with fuse-link	7.5 W při I_e

Mechanical:

Frame size	45 mm
Device height	86 mm
Device width	27 mm per pole (1.5 MU)
Weight	1P 113g 1P+N 225g 2P 224g 3P 450g 3P+N 472g
Mounting	quick fastening on DIN rail EN 60715
Degree of protection	IP20
Upper and lower terminals	lift terminals
Terminal capacity	1.5 - 35 mm ²
Tightening torque of terminal screws	max. 4.5 Nm
Temperature range	-25 to +60 °C
Flame class	V0, glow-wire tested 960 °C
Pollution degree	3
Comparative tracking index	CTI 600

Dimensions [mm]

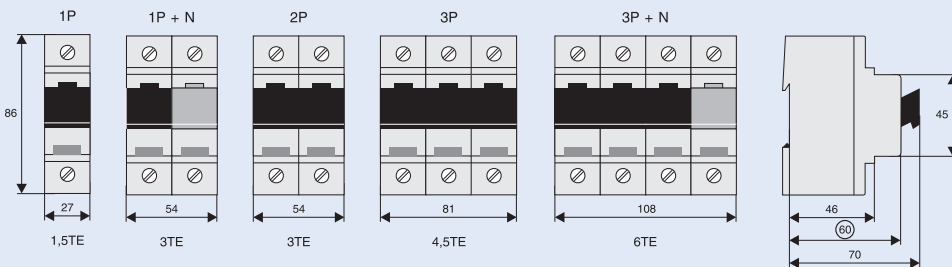

Busbar Connection Examples

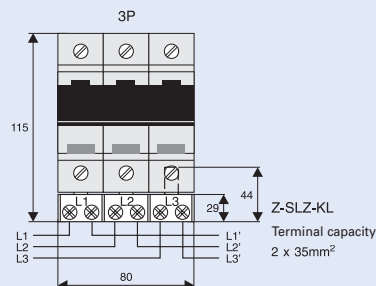
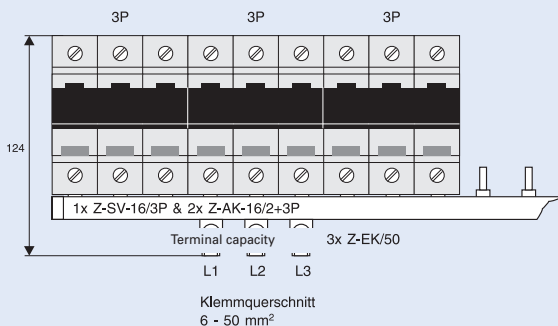
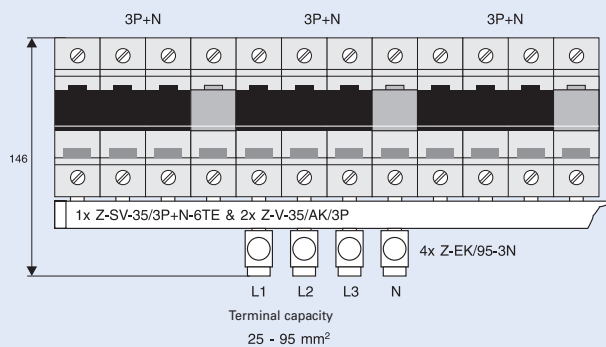
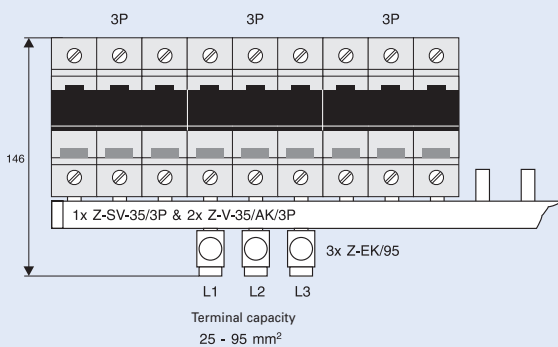

For types and art. numbers see page 82

Fuse-Switch-Disconnecter Z-SLS/CEK

- Fuse switch disconnectors for fuse links size D01 and D02
- Integrated mechanical current coding
- Rated current up to 63 A acc. to mech. coding
- Mechanical current coding by means of fuse link set
- Can be sealed
- Supply side from top or bottom
- Type Z-SLS/CEK no visual tripping indicator
- Type Z-SLS/CEK...SP visual tripping indicator, equipped with neutral lead through terminal, Integrated switch-locking

Connection diagrams

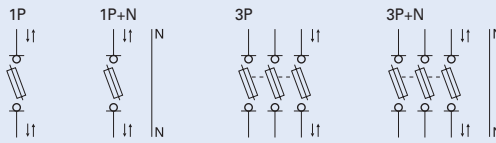

Technical Data

Electrical:

Number of poles	1P, 1P+N, 3P, 3P+N
Rated operational voltage U_e AC	400 V
Rated uninterrupted current I_u 1P, 1P+N 3P, 3P+N	10, 16, 25 A 16, 25, 35, 50, 63 A
Rated short-circuit making capacity I_{cm}	50 kAr.m.s
Utilization category	AC 22 B
Overvoltage category	IV
Rated impulse withstand voltage U_{imp}	6 kV
Power loss per current path	0.5 W at I_e
Power loss per current path with fuse-link	7.5 W at I_e

Mechanical:

Frame size	45 mm
Device height	86 mm
Device width	27 mm per pole (1.5 MU)
Weight	147 g / 441 g
Mounting	quick fastening on DIN rail EN 60715
Degree of protection	IP20
Upper and lower terminals	lift terminals
Terminal capacity	1.5 - 35 mm ²
Tightening torque of terminal screws	max. 4.5 Nm
Temperature range	-25 to +60 °C
Flame class	V0, glow-wire tested 960 °C
Pollution degree	3
Comparative tracking index	CTI 600

Dimensions [mm]

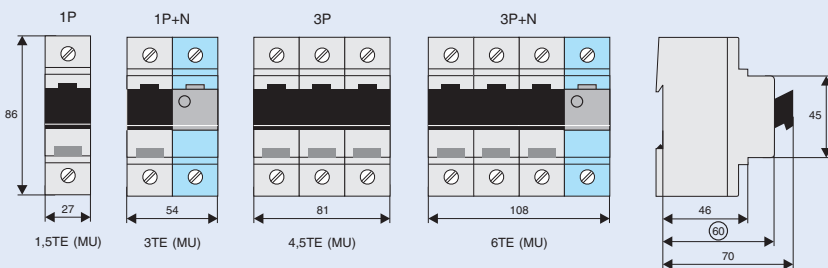

Busbar Connection Example

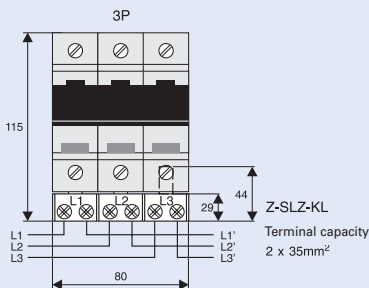

For types and art. numbers see page 82

Fuse-Switch-Disconnecter Z-SLK, with Fuse Monitoring

- Fuse switch disconnectors for fuse links size D01 and D02
- With fuse monitoring (HS)
- Rated current 63 A, utilization category AC-22B, DC-21B
- Mechanical current coding with fuse-link set
- Can be sealed
- Supply side from top or bottom
- Version Z-SLK/NEOZ for rated operational voltage 60-230 V AC, 60-110 V DC (1-pole); 60-400 V AC, 60-220 V DC (2-pole); 60-400 V AC (1+N, 3, 3+N-pole)
- Version Z-SLK/D0 for rated operational voltage 24-60 V AC/DC (1, 2-pole); 24-60 V AC (3-pole)

Connection diagram

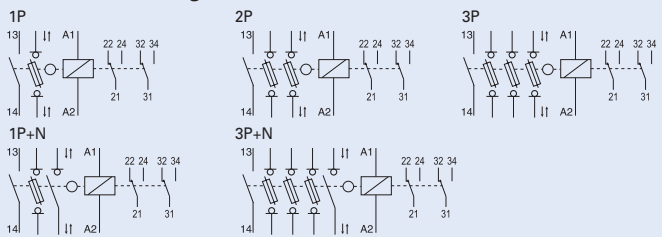

Technical Data

Electrical

Number of poles	1P, 1P+N, 2P, 3P, 3P+N
Rated operational voltage U_e	
AC: 1P, 1P+N	60 - 230 V AC
2P, 3P, 3P+N	60 - 400 V AC
DC: 1P	60 - 110 V DC
2P	60 - 220 V DC
Rated operational current I_e	63 A
Rated uninterrupted current I_u	63 A
Rated short-circuit making capacity I_{cm}	50 kA _{r.m.s}
1 NO	5 A / 250 V
Utilization category	AC 22 B, DC 21 B
Overvoltage category	IV
Rated impulse withstand voltage U_{imp}	6 kV
Power loss per current path	0.5 W at I_e
Power loss per current path with fuse-link	7,5 W at I_e

Relay Component - Electrical

Operational voltage range	24-240 V AC/DC
Operational voltage tolerance	±10%
Power consumption	5 VA
Frequency	50-60 Hz
Function display	
Line voltage	1 LED
Trouble	1 LED
Duty	100%
Responding delay	approx. 100 ms
Reset time	approx. 100 ms
Relay contacts	2 CO, 5 A / 250 V
Auxiliary switch	
Rated impulse withstand voltage	4 kV
Overvoltage category	III

Mechanical

Frame size	45 mm
Device height	86 mm
Device width	27 mm/pole (1.5 MU) + 27 mm
Weight	1P 2P 3P 3P+N 224 g 345 g 450 g 590 g
Mounting	quick fastening on DIN rail EN 60715
Degree of protection	IP20
Upper and lower terminals	lift terminals
Terminal capacity	1,5 - 35 mm ²
Tightening torque of terminal screws	max. 4,5 Nm
Temperature range	-25 až +60 °C
Flame class	V0, glow-wire tested 960 °C
Pollution degree	3
Comparative tracking index	CTI 600

Relay Component - Mechanical

Upper and lower terminals	lift terminals
Terminal capacity	
rigid	0.14 - 4 mm ²
flexible	0.14 - 2.5 mm ²
Tightening torque of terminal screws	0.5 - 0.7 Nm

Dimensions [mm]

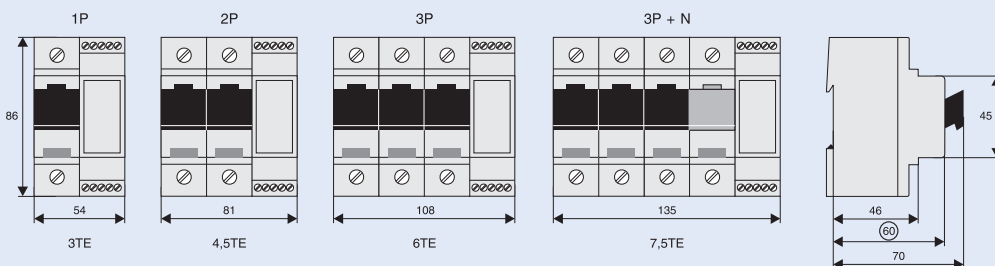

Block Diagram

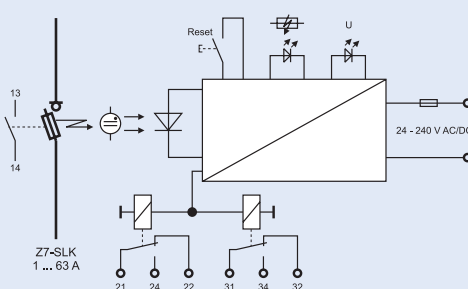

Function - Switch position

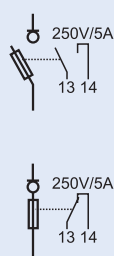

Relay - Fuse Monitoring

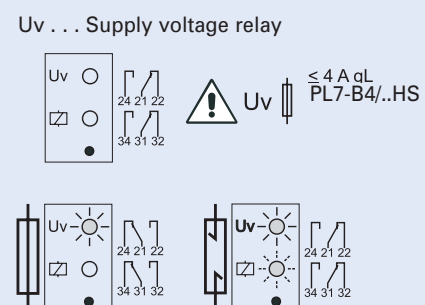

For types and art. numbers see page 82

Fuse-link Sets complete Z-SLS/B, Z-SLS/E

- Suitable for fuse switch disconnectors Z-SLS/NEOZ, Z-SLS/CEK, Z-SLK/NEOZ, Z-SLK/D0
- Supplied as a set with 3 fuse-links and 3 gauge-pieces in plastic box of different colours which can be mounted onto DIN rail.

Connection diagram



Technical Data

Electrical

Operating class	gG (gL)		
Rated voltage	Z-SLS/B/24	Z-SLS/B	Z-SLS/E
AC	24 - 60 V	60 - 400 V	400 V
DC	24 - 60 V	60 - 220 V	220 V
Test voltage	5 kV		

Mechanical

Size	
D01	1, 2, 4, 6, 10, 13, 16 A
D02	20, 25, 32, 35, 40, 50, 63 A

Characteristics

Time/current characteristics of D0-Fuse-links 2 ... 63A gG(gL)

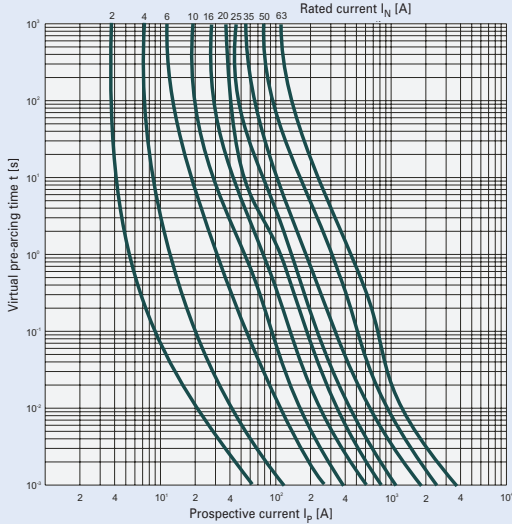

Let-through characteristics of D0-Fuse-links 2 ... 63A gG(gL)

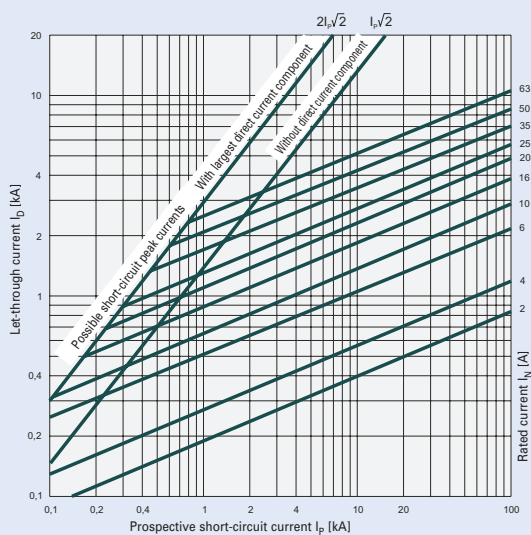

Solid-link Set Z-SLS/TR-SET

- Supplied as a set with 3 solid-links inserts and 3 gauge-pieces in plastic box which can be mounted onto DIN rail
- Suitable for fuse switch disconnectors Z-SLS/NEOZ, Z-SLS/CEK, Z-SLK/NEOZ, Z-SLK/D0
- Dimensions of plastic box:

Frame size	45 mm
Depth	75 mm
Width	54 mm

Connection diagram



Technical Data

Electrical

Rated voltage	400 V AC
Rated uninterrupted current I_U	63 A
Test voltage	5 kV

Mechanical

Size D02	63 A
----------	------

Fuse-Switch-Disconnecter with visual tripping indicator Z-SLS/CB

- Suitable for the following fuse-links Z-D01/SE and Z-D02/SE
- Installation of fuse links D01 by means of cartridge ring adapter insert Z-D02-D01/PE and adapter Z-SLS/CB-HF
- Installation of fuse links D02 by means of cartridge ring adapter insert D02 Z-D02/PE
- Can be sealed with leads
- Rated current up to 63 A acc. to cartridge ring insert
- Can be sealed

Connection diagram

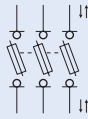

Technical Data

Electrical:

Number of poles	1P, 2P, 3P
Rated operational voltage U_e	
AC	400 V
DC	110 V (1P) / 220 V (2P)
Rated operational current I_e	63 A
Rated uninterrupted current I_u	63 A
Rated short-circuit making capacity I_{cm}	50 kAr.m.s
Utilization category	AC 22 B
Overvoltage category	IV
Rated impulse withstand voltage U_{imp}	6 kV
Power loss per current path	0.5 W at I_e
Power loss per current path with fuse-link	7.5 W at I_e

Mechanical:

Frame size	45 mm
Device height	86 mm
Device width	27 mm per pole (1.5 MU)
Weight	1P 2P 3P
	120 g 230 g 350 g
Mounting	quick fastening on DIN rail EN 60715
Degree of protection	IP20
Upper and lower terminals	lift terminals
Terminal capacity	1.5 - 35 mm ²
Tightening torque of terminal screws	max. 4.5 Nm
Temperature range	-25 to +60 °C
Flame class	V0, glow-wire tested 960 °C
Pollution degree	3
Comparative tracking index	CTI 600

Dimensions [mm]

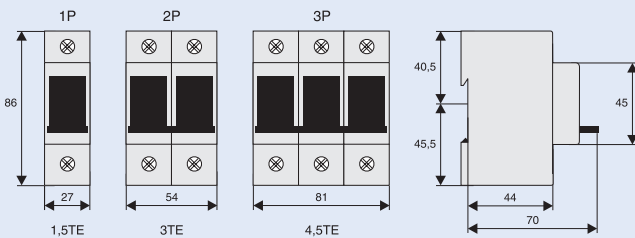

Busbar Connection Examples

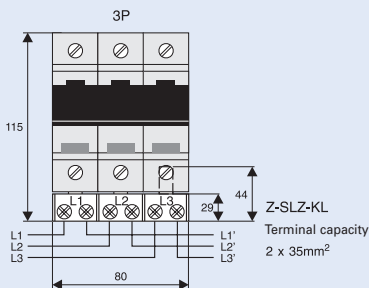
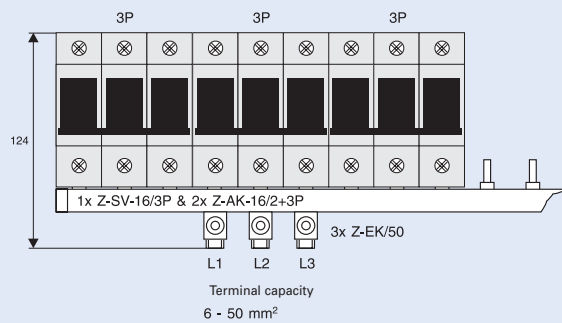
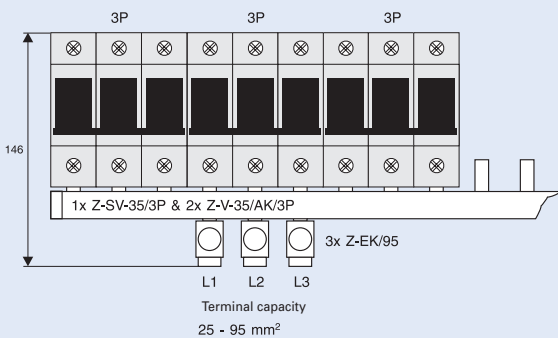

For types and art. numbers see page 84

Switch-Disconnecter-Fuse D02-LTS - Current coding by means of cartridge-ring adapter inserts

- Design according to EN 60947-3
- For fuse links Z-D01/SE and Z-D02/SE
- Thermal monitoring with integrated thermo switch
- Installation of fuse links D01 by means of cartridge ring adapter insert Z-D02-D01/PE and adapter Z-SLS/CB-HF
- Installation of fuse links D02 by means of cartridge ring adapter insert D02 Z-D02/PE
- Installation of cylindrical fuse links Z-C10/SE by means of adapter Z-D02-LTS -HF
- Visual tripping indicator is flashing
- Version D02-LTS/63-3-HK with integrated auxiliary contact
- Delivered without fuse links
- Including adapter Z-D02-LTS -HF for fuse links D01 or cylindrical fuse links Z-C10/SE
- Can be sealed

Connection diagram

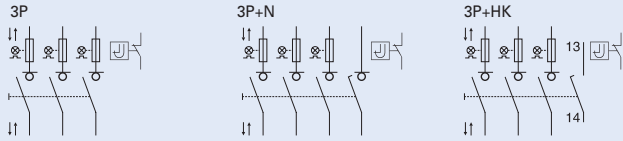

Technical Data

Electrical

Number of poles	3P, 3P+N, 3P+HK
Rated operational voltage U_e	
AC	400 V
Rated operational current I_e	63 A
Rated uninterrupted current I_u	63 A
Rated short-circuit making capacity I_{cm}	50 kA _{r.m.s.}
Utilization category	AC 22 B
Overvoltage category	IV
Rated impulse withstand voltage U_{imp}	6 kV
Power loss per current path	1.8 W at I_e
Power loss per current path with fuse-link	7.3 W at I_e
Max. permissible power loss of fuse-links	5.5 W
Auxiliary switch	
1 NO	5 A / 250 V AC
Max. thermal back-up protection	2 A gL: PL7-B4/..-HS
Thermo switch	
1 NC	
AC $\cos \varphi = 1$	2.5 A / 250 V
AC $\cos \varphi = 0.6$	1.5 A / 250 V
DC	1.6 A / 24 V
	1.2 A / 48 V

Mechanical

Frame size	45 mm
Device height	84 mm
Device width	18 mm per pole (1 MU)
Weight	3P 340 g 3P+N 380 g 3P+HK 380 g
Mounting	quick fastening on DIN rail EN 60715
Degree of protection	IP20
Upper and lower terminals	lift terminals
Terminal capacity	1.5 - 25 mm ²
Tightening torque of terminal screws	max. 3 Nm
Temperature range	-25 to +60 °C
Flame class	V0, glow-wire tested 960 °C
Pollution degree	3
Comparative tracking index	CTI 600
Femal push-on connector	0.8 x 2.5 mm

Dimensions [mm]

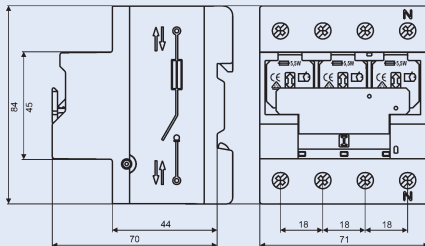

Busbar Connection Example 3P, 3P+N

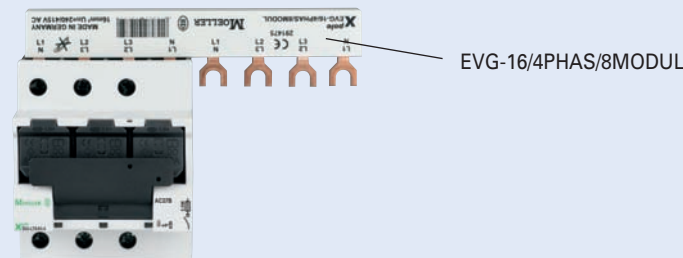

NH-Fuse-Links

- System of NH fuse links
- Type sizes 00, 1, 2, 3, 4a
- Rated voltage 500 V, 50 Hz
- Characteristic gG suitable for cables

Technical Data

	NH-00/	NH-1/	NH-2/	NH-3/	NH-4a/
Electrical					
Nominal voltage AC	500 V AC	500 V AC	500 V AC	500 V AC	500 V AC
Nominal current	6-160 A	32-250 A	35-400 A	100-630 A	800-1600 A
Rated frequency	50 Hz	50 Hz	50 Hz	50 Hz	50 Hz
Nominal breaking capacity AC	120 kA	120 kA	120 kA	120 kA	120 kA
Max. Power loss					
$I_n = 6 A$	1.3 W	-	-	-	-
10 A	1.5 W	-	-	-	-
16 A	1.8 W	-	-	-	-
20 A	1.9 W	-	-	-	-
25 A	2.4 W	-	-	-	-
32 A	2.9 W	3.6 W	-	-	-
35 A	3.1 W	3.8 W	3.7 W	-	-
40 A	3.6 W	4.1 W	-	-	-
50 A	4.2 W	4.6 W	4.6 W	-	-
63 A	5.0 W	6.2 W	5.8 W	-	-
80 A	5.2 W	6.4 W	6.4 W	-	-
100 A	6.7 W	8.7 W	8.3 W	7.7 W	-
125 A	7.8 W	10.3 W	10.0 W	10.8 W	-
145 A	8.7 W	-	-	-	-
160 A	9.4 W	14.1 W	12.8 W	12.1 W	-
200 A	-	15.8 W	15.8 W	13.6 W	-
224 A	-	17.4 W	17.4 W	15.4 W	-
250 A	-	19.1 W	19.1 W	19.6 W	-
300 A	-	-	20.6 W	21.2 W	-
315 A	-	-	21.6 W	22.3 W	-
355 A	-	-	24.2 W	26.5 W	-
400 A	-	-	26.8 W	26.8 W	-
425 A	-	-	-	29.0 W	-
500 A	-	-	-	37.0 W	-
630 A	-	-	-	47.0 W	-
800 A	-	-	-	-	67.0 W
1000 A	-	-	-	-	69.0 W
1250 A	-	-	-	-	84.0 W
1600 A	-	-	-	-	106.0 W

Dimensions [mm]

Type	a1	a2	a3	b1	c1	d	e1	e2	f	Rated current
00	78	53	45	15	35	2,0	36	20	5	up to 100 A
								30		125 – 160 A
1	135	72	62	15	40	2,5	41	30	8	up to 160 A
				20			39	40	12	200 – 250 A
2	150	72	62	20	48	2,5	49	40	12	up to 250 A
				25		2,8	59	50	15	300 – 400 A
3	150	72	62	25	60	2,8	59	50	15	up to 400 A
				32			72	71		425 – 630 A
4a	200	96	82	50	85	4,0	109	98	27	800 – 1600 A

For types and art. numbers see page 85

Dimensions [mm]

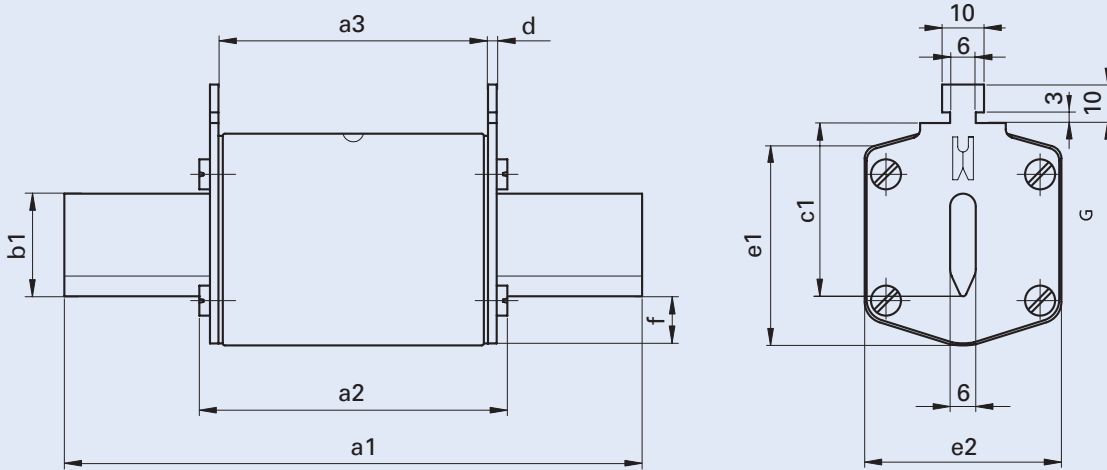

Let-through characteristics of NH fuse links

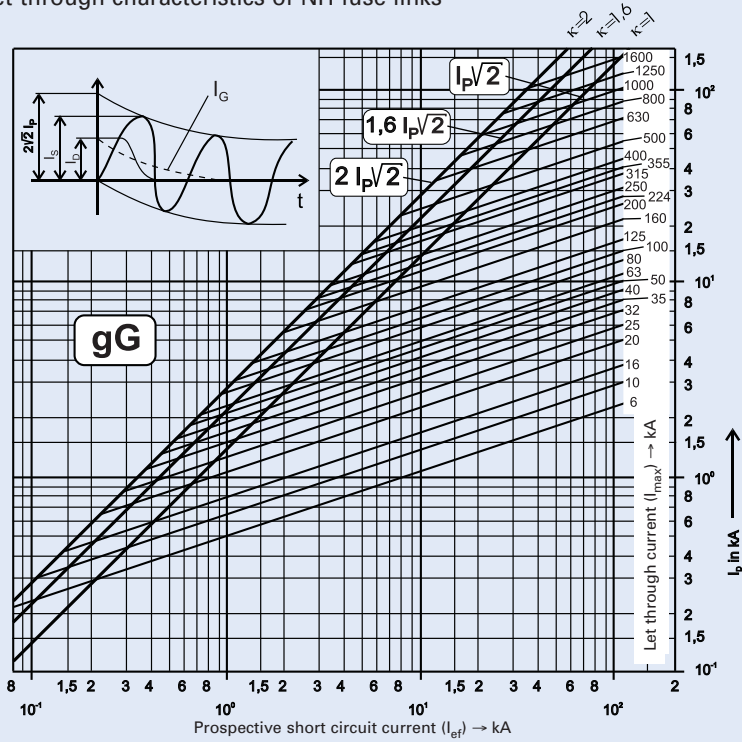

Time-current characteristics of NH fuse links

Time-current characteristics of NH fuse links for ambient temperature $20 \pm 5 \text{ }^\circ\text{C}$.

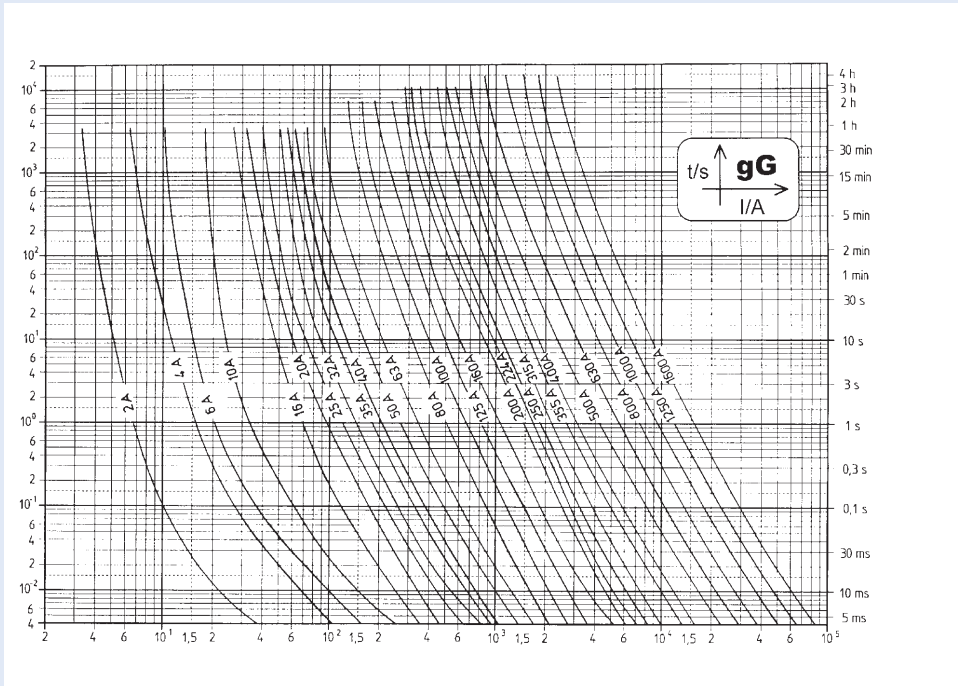

For types and art. numbers see page 85

NH-Fuse-Switch-Disconnecter LTS 160/..., LTS 250/...

- Supplied without NH-fuse-links
- Version LTS...R for direct mounting onto 60 mm busbar systems
- For mounting onto 100 mm busbar systems adapter Z-LTS-...-SAD/100 can be used
- Design according to EN 60947-3
- Halogen-free plastic, self-extinguishing, marked for recycling
- Corrosion-proof metal parts
- Parameters of LTS-160/00/3-ES with electronic signalisation are identical with LTS-160/00/3E, only standard connection by means of screws M8
- Parameters of LTS-250/1/3-ES with electronic signalisation are identical with LTS-250/1/3
- The switch cover can be removed in the OFF position
- Transparent windows are hinged and permit testing of the fuse-links

Connection diagram

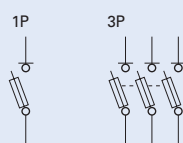

Technical Data

	LTS-100/C00/3-R	LTS-160/00/1	LTS-160/00/3E	LTS-160/00/3E-R	LTS-250/1/3	LTS-250/1/3-R
Electrical:						
Technical data according to	EN 60947	EN 60947	EN 60947	EN 60947	EN 60947	EN 60947
Size	C00	00	00	00	1	1
Number of poles/phases	3	1	3	3	3	3
Conventional free air thermal current with NH-fuse-links I_{th}	100 A (500 V) – (690 V)	160 A (500 V) 125 A (690 V)	160 A (500 V) 125 A (690 V)	160 A (500 V) 125 A (690 V)	250 A (500 V) 200 A (690 V)	250 A (500 V) 200 A (690 V)
Max. permitted nominal power loss of NH-fuse-links	7,5 W	12 W	12 W	12 W	23 W	23 W
Conventional free air thermal current with solid-links I_{th}	160 A	200 A	200 A	200 A	400 A	400 A
Max. permitted nominal power loss of solid-links	-	1.2 W	1.2 W	1.2 W	2.6 W	2.6 W
Utilization category AC-23B						
Rated operational voltage U_e	-	400 V AC	400 V AC	400 V AC	400 V AC	400 V AC
Rated operational current I_e	-	160 A	160 A	160 A	250 A	250 A
Rated short-circuit making capacity	-	80 kA	80 kA	80 kA	80 kA	80 kA
Utilization category AC-22B						
Rated operational voltage U_e	500 V AC	500 V AC	500 V AC	500 V AC	500 V AC	500 V AC
Rated operational current I_e	100 A	160 A	160 A	160 A	250 A	250 A
Rated short-circuit making capacity	50 kA	80 kA	80 kA	80 kA	50 kA	50 kA
Utilization category AC-21B						
Rated operational voltage U_e	-	690 V AC	690 V AC	690 V AC	690 V AC	690 V AC
Rated operational current I_e	-	125 A	125 A	125 A	200 A	200 A
Rated short-circuit making capacity	-	50 kA	50 kA	50 kA	50 kA	50 kA
Rated insulation voltage U_i	750 V	1000 V	1000 V	1000 V	1000 V	1000 V
Rated impulse withstand voltage U_{imp}	8 kV	8 kV	8 kV	8 kV	12 kV	12 kV
Rated frequency	50–60 Hz	50–60 Hz	50–60 Hz	50–60 Hz	50–60 Hz	50–60 Hz
Rated duty	uninterrupted duty					
Rated short-circuit making capacity I_{cm} with solid-links	-	6.2 kA	6.2 kA	6.2 kA	8.2 kA	8.2 kA
Rated short-time withstand current I_{cw} with solid-links	-	4 kA/1 s	4 kA/1 s	4 kA/1 s	8 kA/1 s	8 kA/1 s
Power loss without NH-fuse-links	-	2.3 W at 160 A	7 W at 160 A	10 W at 160 A	10 W at 250 A	10 W at 250 A
Power loss without solid-links	-	3.3 W at 200 A	10 W at 200 A	16 W at 200 A	24 W at 400 A	-
Mechanical:						
Standard connection	Lift terminal	M8	Lift terminal	Lift terminal	M10	M10
For busbar max. width	30 mm	20 mm	20 mm	30 mm	30 mm	30 mm
For cable lugs	Cu	1.5 – 50 mm ²	2x70 mm ²	2x70 mm ²	2.5 – 70 mm ²	2x150 mm ²
	Al	-	2x95 mm ²	2x95 mm ²	-	2x185 mm ²
Ambient temperature range	-5 °C to +40 °C	-5 °C to +40 °C	-5 °C to +40 °C	-5 °C to +40 °C	-5 °C to +40 °C	-5 °C to +40 °C
Degree of protection	IP20	IP20	IP20	IP30	IP20	IP20
Pollution degree	3	3	3	3	3	3

For types and art. numbers see page 86

Dimensions [mm]

LTS-100/C00/3-R

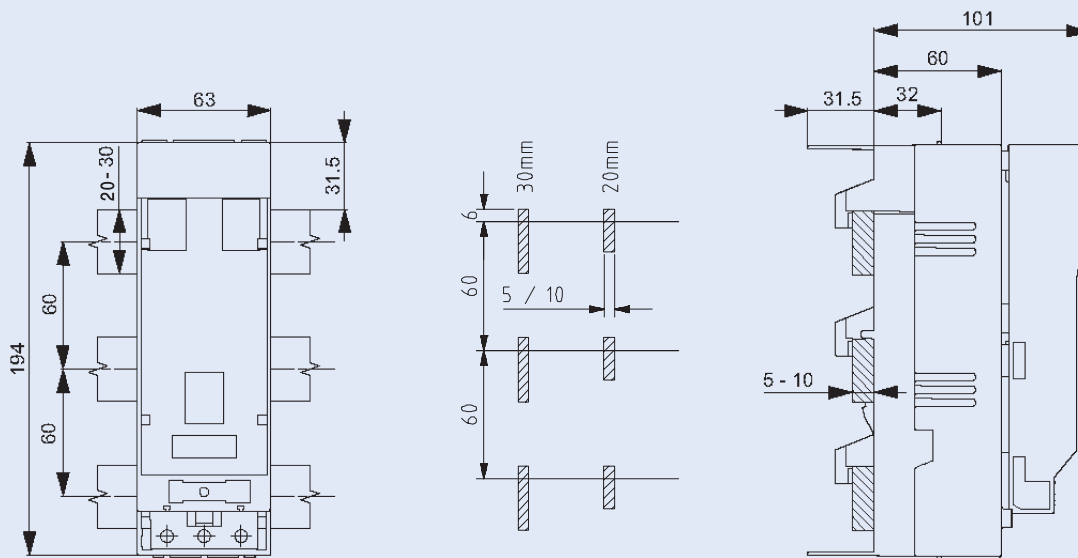

Cut-out for front plate

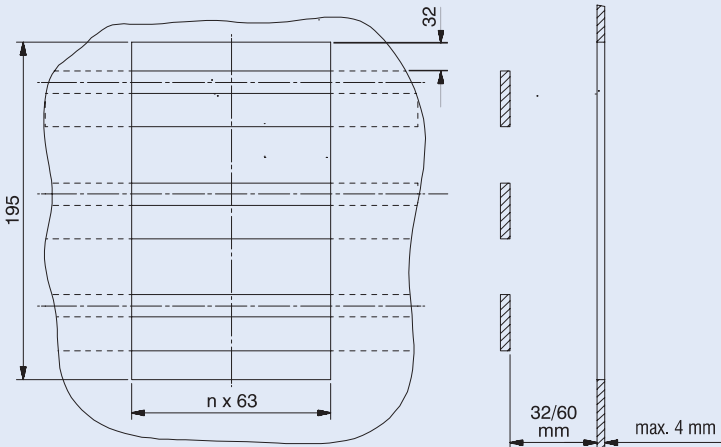

Cable Terminal Connections LTS-100/00/3-R

Lift terminal:

Cross section Cu 1.5-50 mm²
Cu-Band 6 x 9 x 0,8

Tightening torque 2.6 Nm

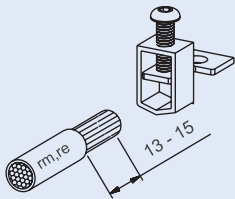

For types and art. numbers see page 86

Dimensions [mm]

LTS-160/00/1

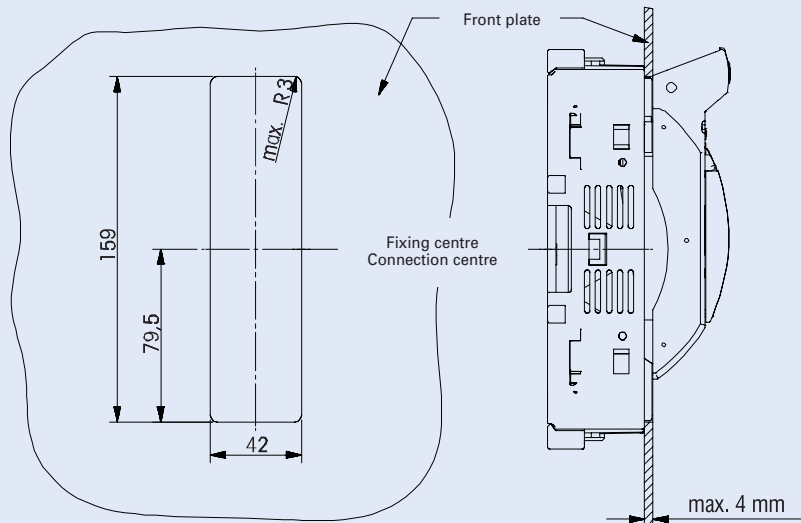
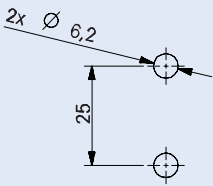
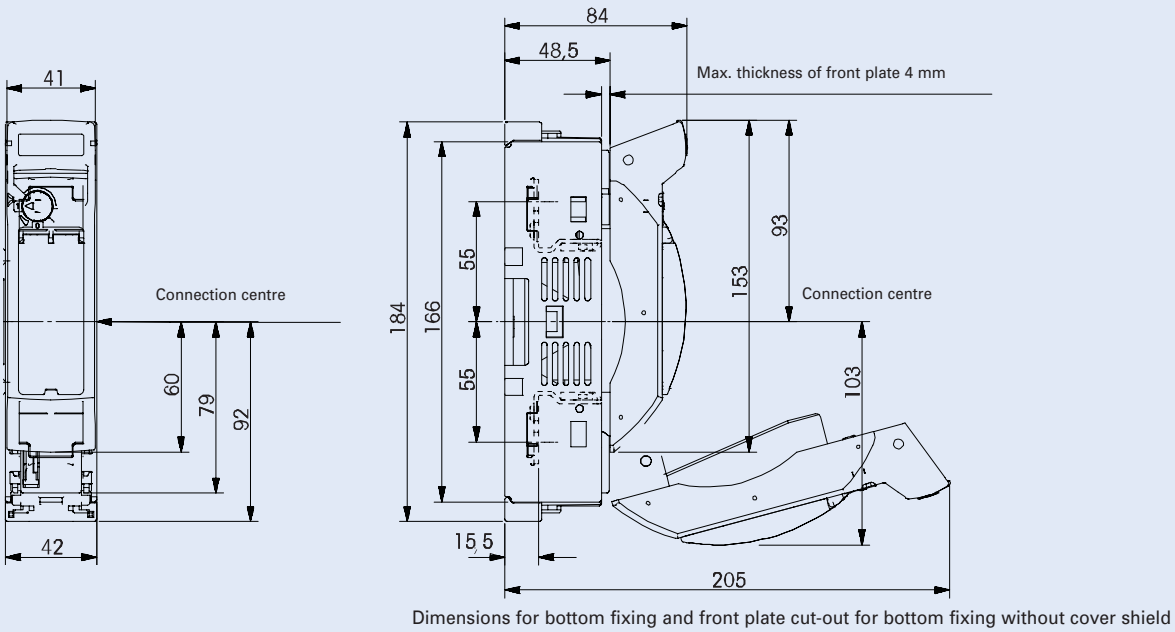

Cable Terminal Connections LTS-160/00/1

Clamp strap Z-LTS-160-BK:
Cross section Cu 4-70 mm²
Tightening torque 3-4 Nm

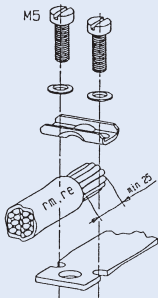

Screw M8
Cross section Cu 16-70, Al 16-95 mm²
Tightening torque 15-17 Nm

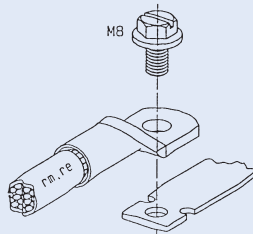

V-shaped terminal
Cross section: 50-95 mm² se (sector solid)
35-70 mm² sm (sector stranded)
10-50 mm² rm (round multi wired)
Tightening torque 12 Nm

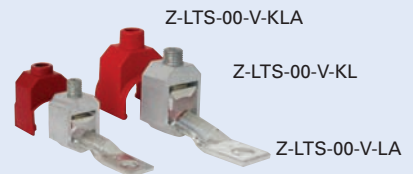

WA-SG01502

Dimensions [mm]

LTS-160/00/3E - mounting on panel

* Total depth of the device in version -ES with electronic signalisation is 106 mm

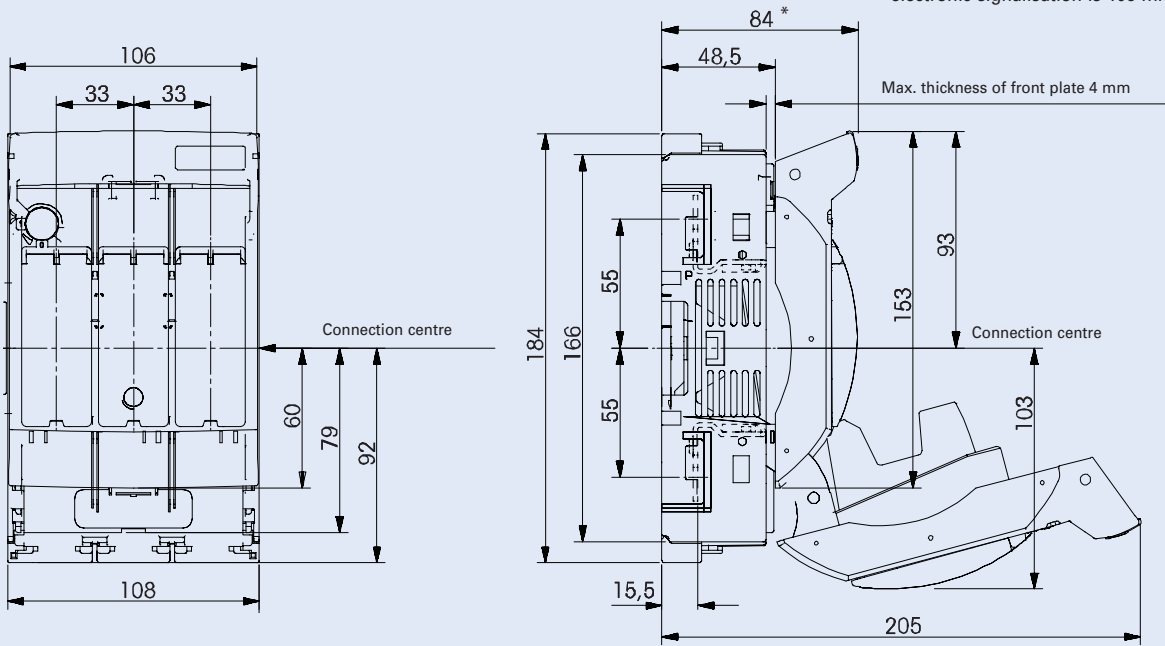

Dimensions of fastening openings **

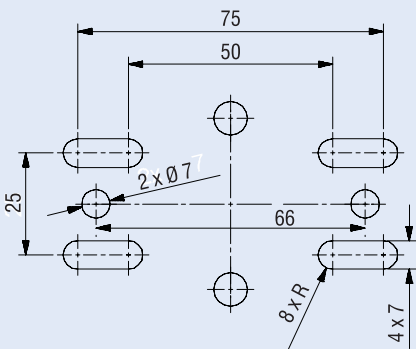

Cut-out for front plate **

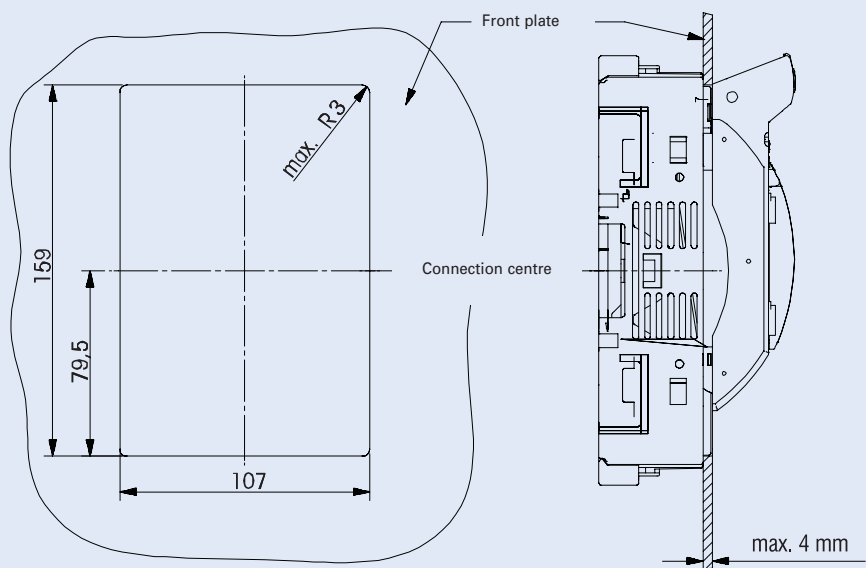

** For bottom connection

Cable Terminal Connections LTS-160/00/3E

Cross section Cu 2.5-70 mm²
Tightening torque 6 Nm

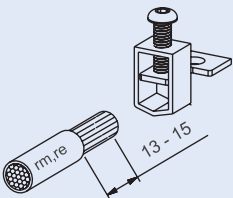

For types and art. numbers see page 86

Dimensions [mm]

LTS 160/00/3E-R - mounting on busbars

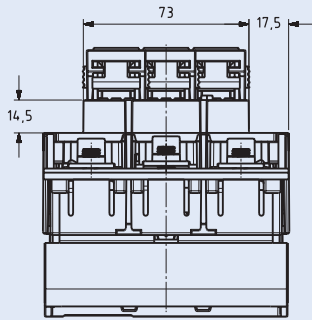
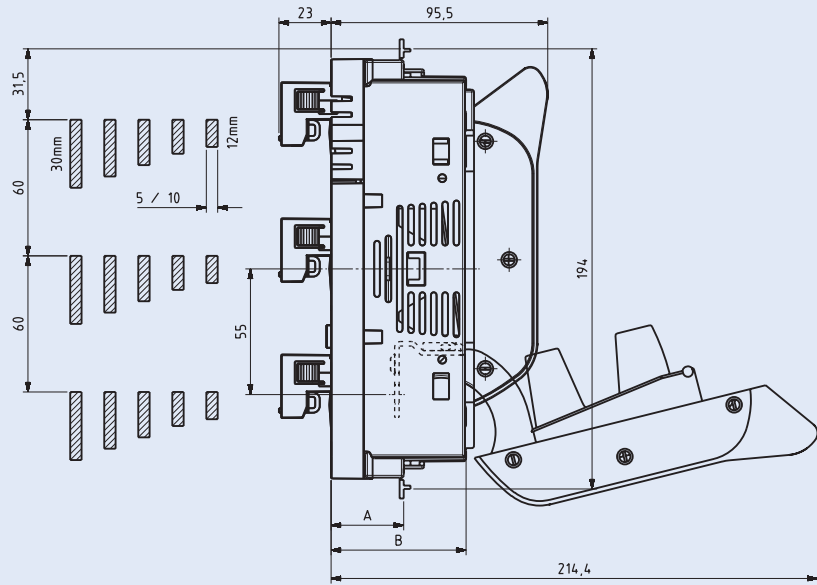
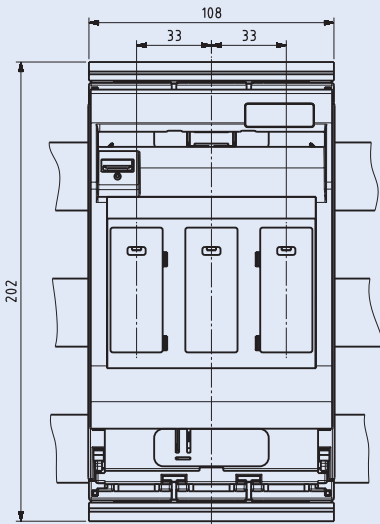

Cut-out for front plate

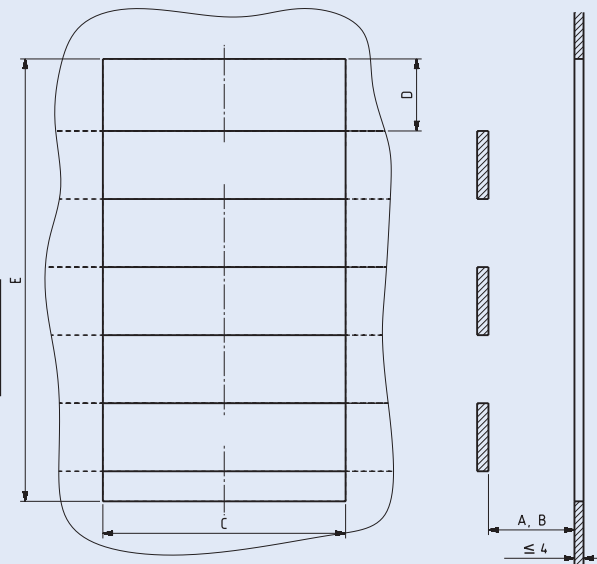

Depth	Cut-out dimensions		
	C	D	E
A 32	109	31.5	195
B 60	107	13.5	159

Cable Terminal Connections LTS-160/00/3E-R

Cross section Cu 2.5-70 mm²
Tightening torque 6 Nm

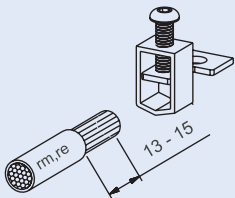

For types and art. numbers see page 86

Dimensions [mm]

LTS 250/1/3 - mounting on panel

* Total depth of the device in version -ES with electronic signalisation is 124 mm

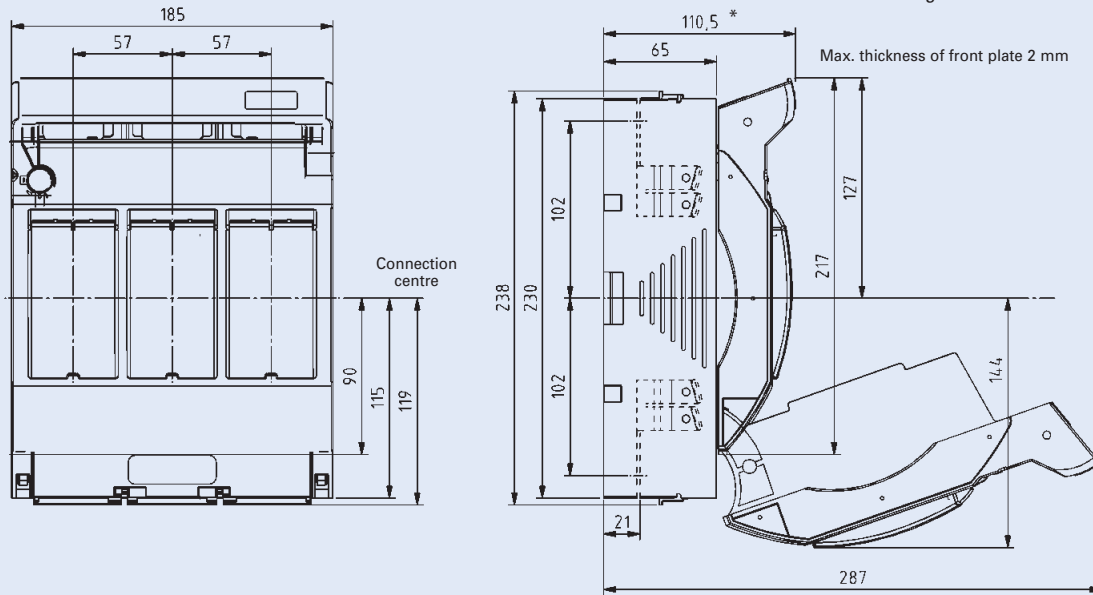

Cut-out for front plate **

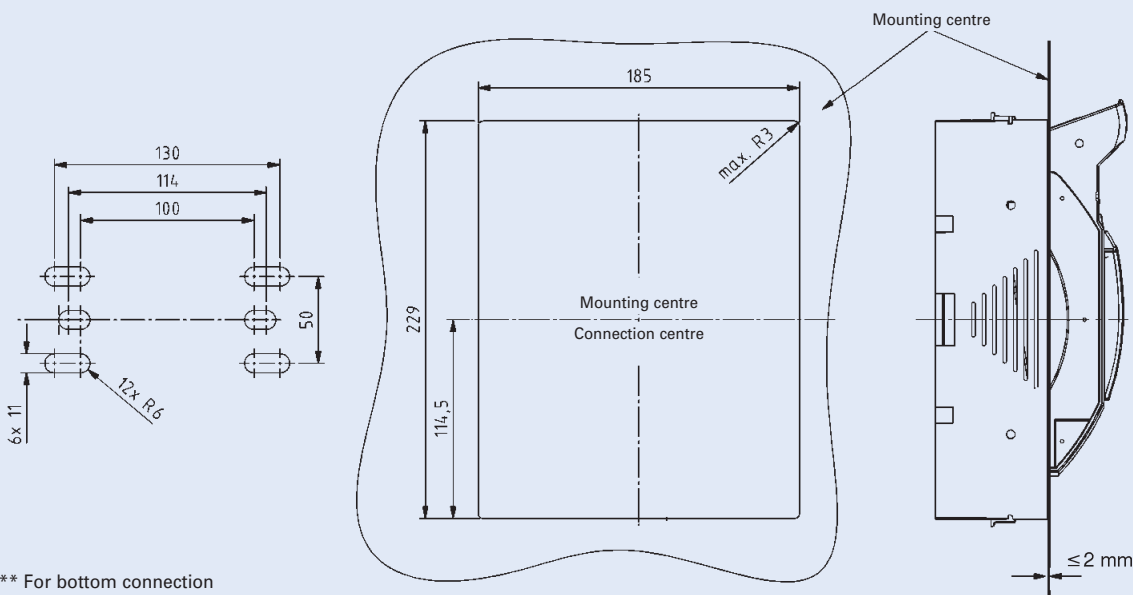

** For bottom connection

Cable Terminal Connections LTS-250/1/3

Screw connection

Screw M10 x 25
Tightening torque
20 Nm

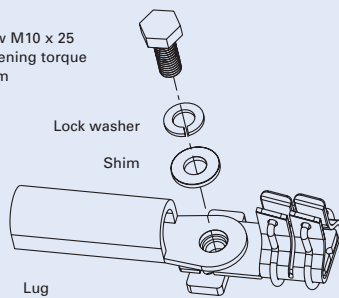

Suitable for lugs according to:
DIN 46235 max. 10-150 mm²
DIN 46234 max. 10-150 mm²
DIN 46329 max. 10-185 mm²
(240 mm²)

Bolt connection

Nut M10
Tightening torque
20 Nm

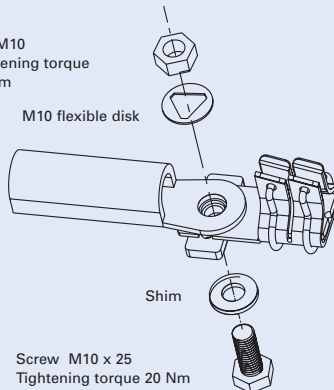

Suitable for lugs according to:
DIN 46235 max. 10-150 mm²
DIN 46234 max. 10-150 mm²
DIN 46329 max. 10-185 mm²
(240 mm²)

Al/Cu clamp strap Z-LTS-250-BK

Screw M6 x 30
Tightening torque
6 Nm

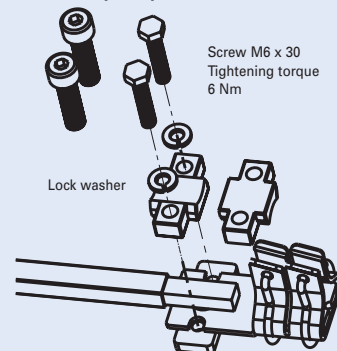

Suitable: for round conductor 70-150 mm² mm
for rails or laminated copper 18 x 7-18

For types and art. numbers see page 86

Dimensions [mm]

LTS 250/1/3-R - mounting on busbars

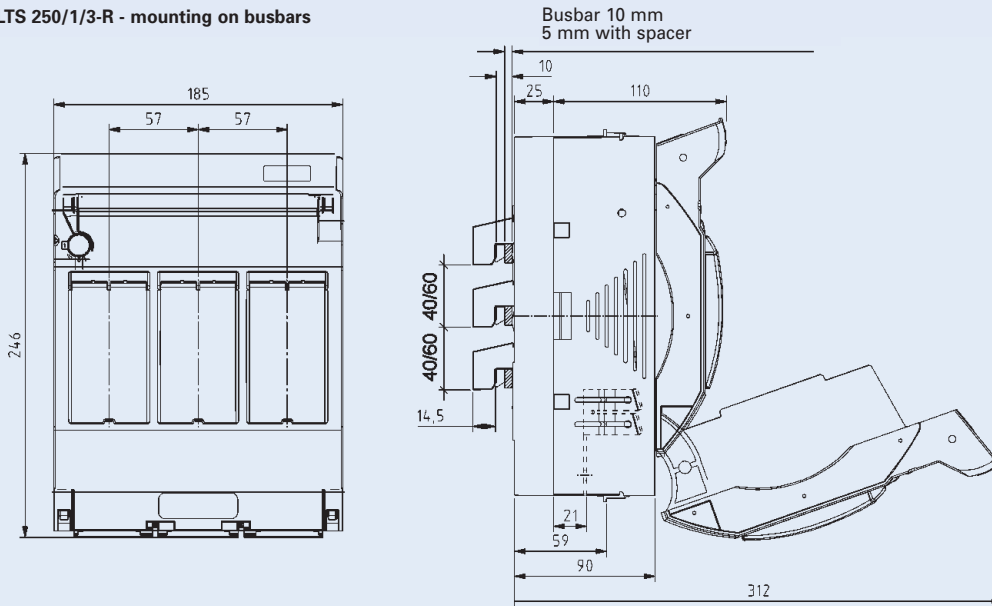

Cut-out for front plate

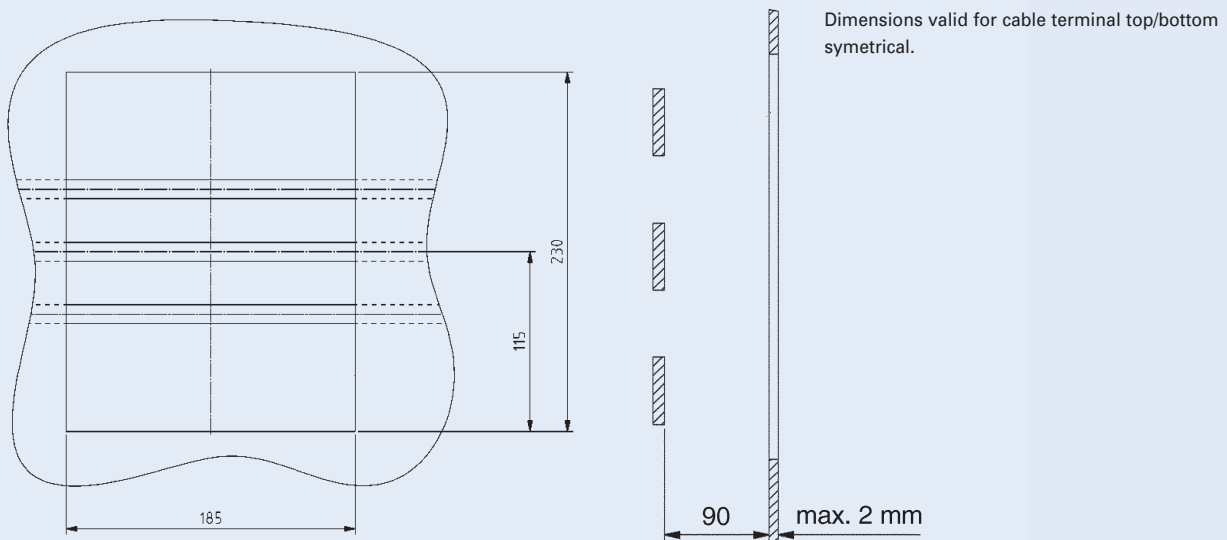

Cable Terminal Connections LTS-250/1/3-R

Screw connection

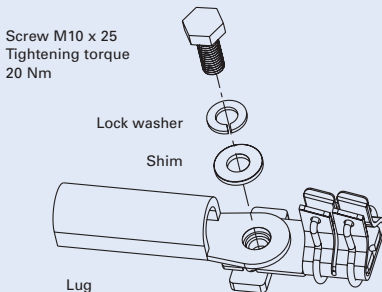

Screw M10 x 25
Tightening torque
20 Nm

Lock washer
Shim

Lug

Suitable for lugs according to:
DIN 46235 max. 10-150 mm²
DIN 46234 max. 10-150 mm²
DIN 46329 max. 10-185 mm²
(240 mm²)

Bolt connection

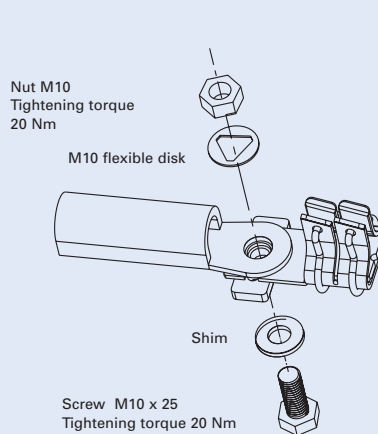

Nut M10
Tightening torque
20 Nm

M10 flexible disk

Shim

Screw M10 x 25
Tightening torque 20 Nm

Suitable for lugs according to:
DIN 46235 max. 10-150 mm²
DIN 46234 max. 10-150 mm²
DIN 46329 max. 10-185 mm²
(240 mm²)

Al/Cu clamp strap Z-LTS-250-BK

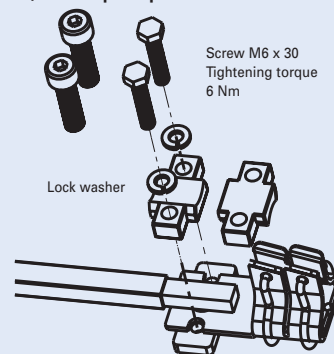

Screw M6 x 30
Tightening torque
6 Nm

Lock washer

Suitable: for round conductor 70-150 mm² rm
for rails or laminated copper 18 x 7-18

Copper Rails:

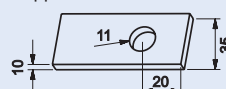

For types and art. numbers see page 86

NH-Fuse-Switch-Disconnecter LTS-400/..., LTS-630/...

- Supplied without NH-fuse-links
- For mounting onto 100 mm busbar systems adapter Z-LTS-...-SAD/100 can be used
- Fully isolated, touch protection acc. to EN 60947
- The base body consists of a glass-fibre reinforced high-temperature-resistant, non-flammable, self-extinguishing and halogen-free plastic
- The single-part contact system is corrosion- and torsion-proof
- The protective cover consists of a glass-fibre re-enforced, high-temperature-resistant, self-extinguishing and halogen-free plastic
- The switch cover features large viewing windows permitting to see the marking and the flat indicator of the NH-fuse-links
- Transparent windows are hinged and permit testing of the fuse-links
- The switch cover can be removed in the OFF position
- Type LTS-400/2/3-R for mounting onto SASY 60 mm
- Parameters of LTS-400/2/3-ES with electronic signalisation are identical with LTS-400/2/3
- Parameters of LTS-630/3/3-ES with electronic signalisation are identical with LTS-630/3/3

Connection diagrams

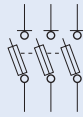

Technical Data

	LTS-400/2/3	LTS-400/2/3-R	LTS-630/3/3
Electrical:			
Technical data according to	EN 60947	EN 60947	EN 60947
Size	2	2	3
Number of poles/phases	3	3	3
Conventional free air thermal current with NH-fuse-links I_{th}	400 A (500 V) 315 A (690 V)	400 A (500 V) 315 A (690 V)	630 A (500 V) 500 A (690 V)
Max. permissible power loss of NH-fuse-links	34 W	34 W	48 W
Conventional free air thermal current with solid-links I_{th}	630 A	530 A	780 A
Max. permissible power loss of solid-links	9 W	9 W	17,5 W
Utilization category AC-23B			
Rated operational voltage U_e	400 V AC	400 V AC	400 V AC
Rated operational current I_e	400 A	400 A	630 A
Rated short-circuit making capacity with fuse-links	80 kA	80 kA	80 kA
Utilization category AC-22B			
Rated operational voltage U_e	500 V AC	500 V AC	500 V AC
Rated operational current I_e	400 A	400 A	630 A
Rated short-circuit making capacity with fuse-links	80 kA	80 kA	80 kA
Utilization category AC-21B			
Rated operational voltage U_e	690 V AC	690 V AC	690 V AC
Rated operational current I_e	315 A	315 A	500 A
Rated short-circuit making capacity with fuse-links	80 kA	80 kA	50 kA
Rated insulation voltage U_i	1000 V	1000 V	1000 V
Rated impulse withstand voltage U_{imp}	12 kV	12 kV	12 kV
Rated frequency	50–60 Hz	50–60 Hz	50–60 Hz
Rated duty	uninterrupted duty	uninterrupted duty	uninterrupted duty
Rated short-circuit making capacity I_{cm} with solid-links	10,6 kA	10,6 kA	18,6 kA
Rated short-time withstand current I_{cw} with solid-links	13 kA/1 s	13 kA/1 s	13 kA/1 s
Power loss without NH-fuse-links	20 W at 400 A	53 W at 400 A	40 W at 630 A
Power loss without solid-links	50 W at 630 A	-	150 W at 1000 A
Mechanical:			
Standard connection	M10	M10	M12
For busbar max. width	35 mm	35 mm	45 mm
For cable lugs	Cu 2x240 mm ² Al 2x240 mm ²	2x240 mm ² 2x240 mm ²	2x240 mm ² 2x300 mm ²
Ambient temperature range	-5 °C to +40 °C	-5 °C to +40 °C	-5 °C to +40 °C
Degree of protection	IP20	IP20	IP20
Pollution degree	3	3	3

For types and art. numbers see page 86

Dimensions [mm]

LTS-400/2/3

* Total depth of the device in version -ES with electronic signalisation is 144 mm

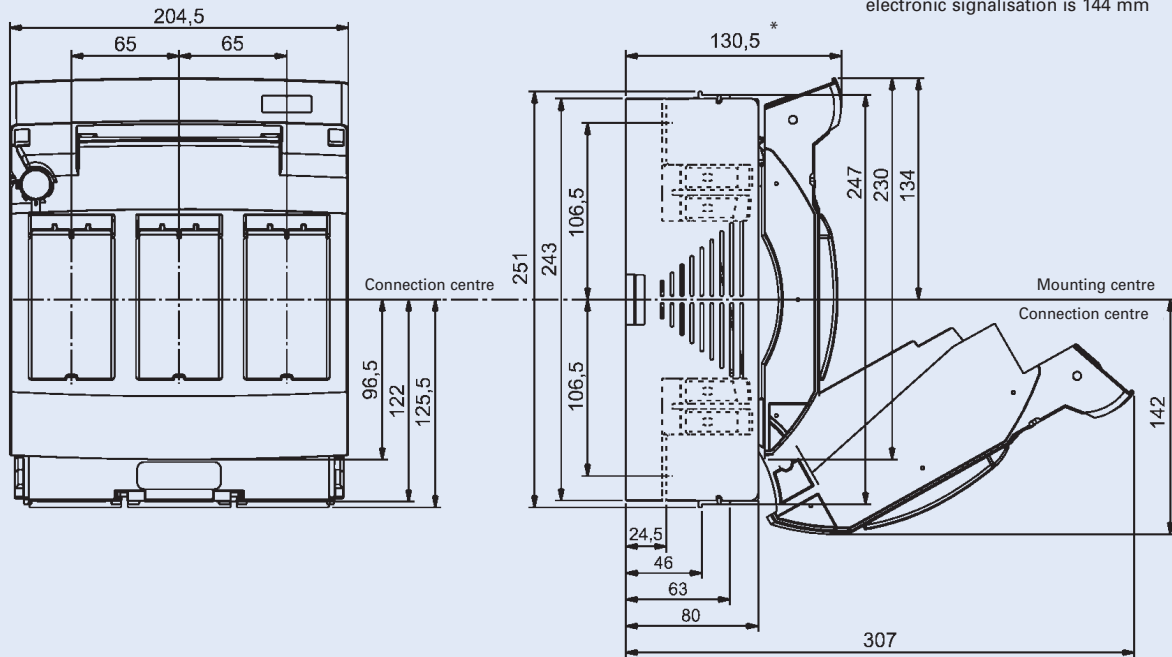

Cut-out for front plate **

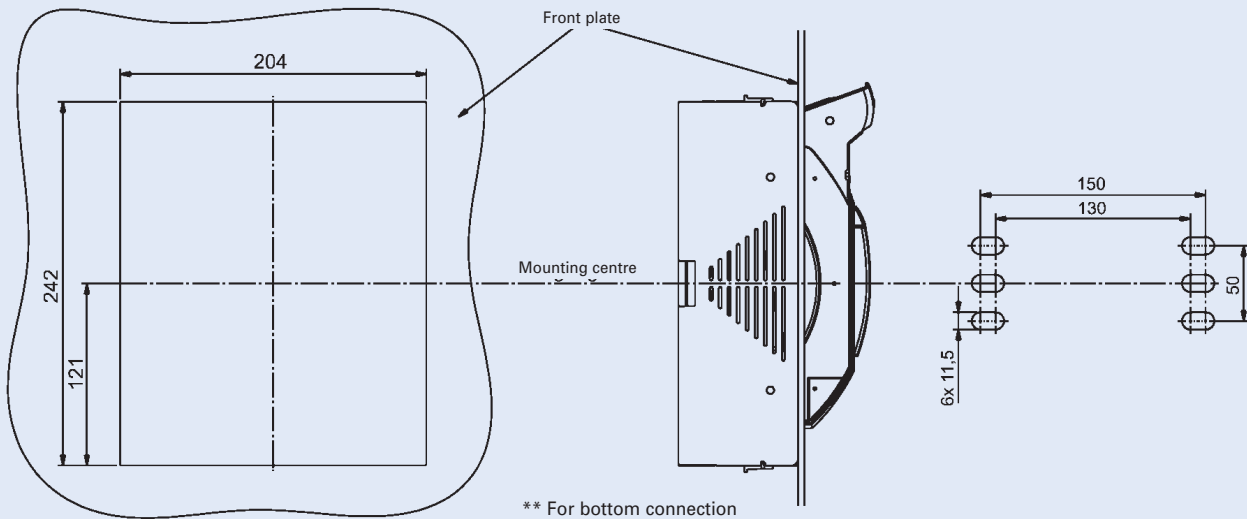

Cable Terminal Connections LTS-400/2/3

Screw connection

Screw M10 x 25
Tightening torque
20 Nm

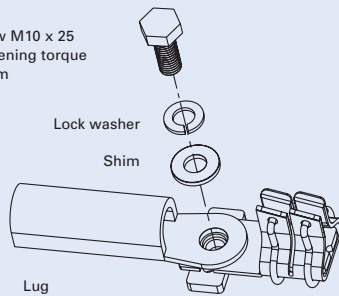

Bolt connection

Nut M10
Tightening torque
20 Nm

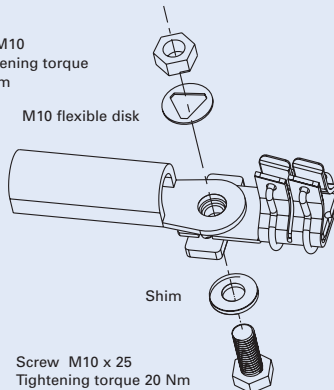

Screw M10 x 25
Tightening torque 20 Nm

Suitable for lugs according to:
DIN 46235 max. 10-185 mm²
DIN 46234 max. 10-240 mm²
DIN 46329 max. 10-240 mm²

Suitable for lugs according to:
DIN 46235 max. 10-185 mm²
DIN 46234 max. 10-240 mm²
DIN 46329 max. 10-240 mm²

Copper Rails:

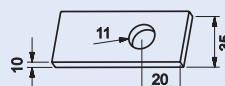

For types and art. numbers see page 86

Dimensions [mm]

LTS-400/2/3-R

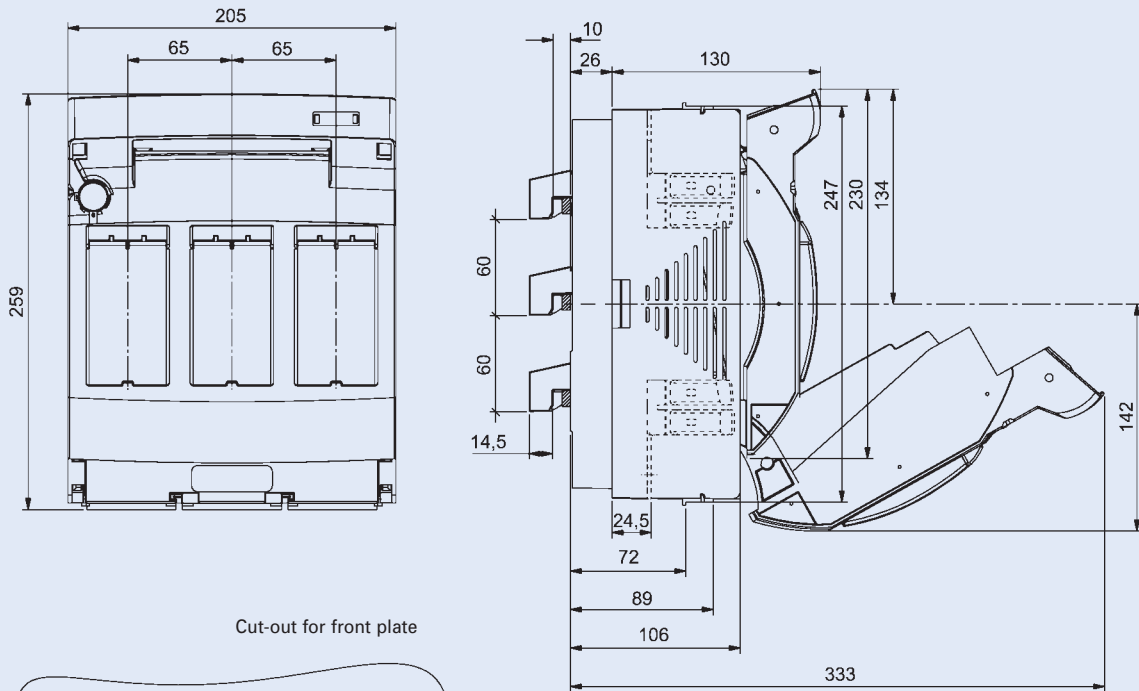

Dimensions valid for cable terminal top/bottom symmetrical.

Cable Terminal Connections LTS-400/2/3-R

Screw connection

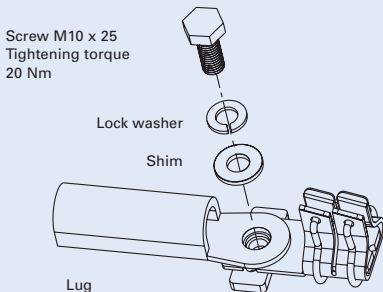

Bolt connection

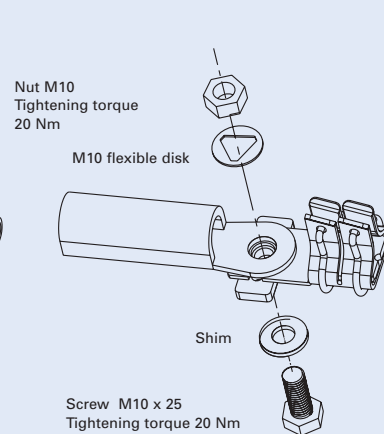

Suitable for lugs according to:
DIN 46235 max. 10-185 mm²
DIN 46234 max. 10-240 mm²
DIN 46329 max. 10-240 mm²

Suitable for lugs according to:
DIN 46235 max. 10-185 mm²
DIN 46234 max. 10-240 mm²
DIN 46329 max. 10-240 mm²

Copper Rails:

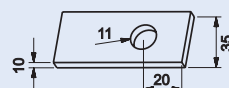

For types and art. numbers see page 86

Dimensions [mm]

LTS-630/3/3

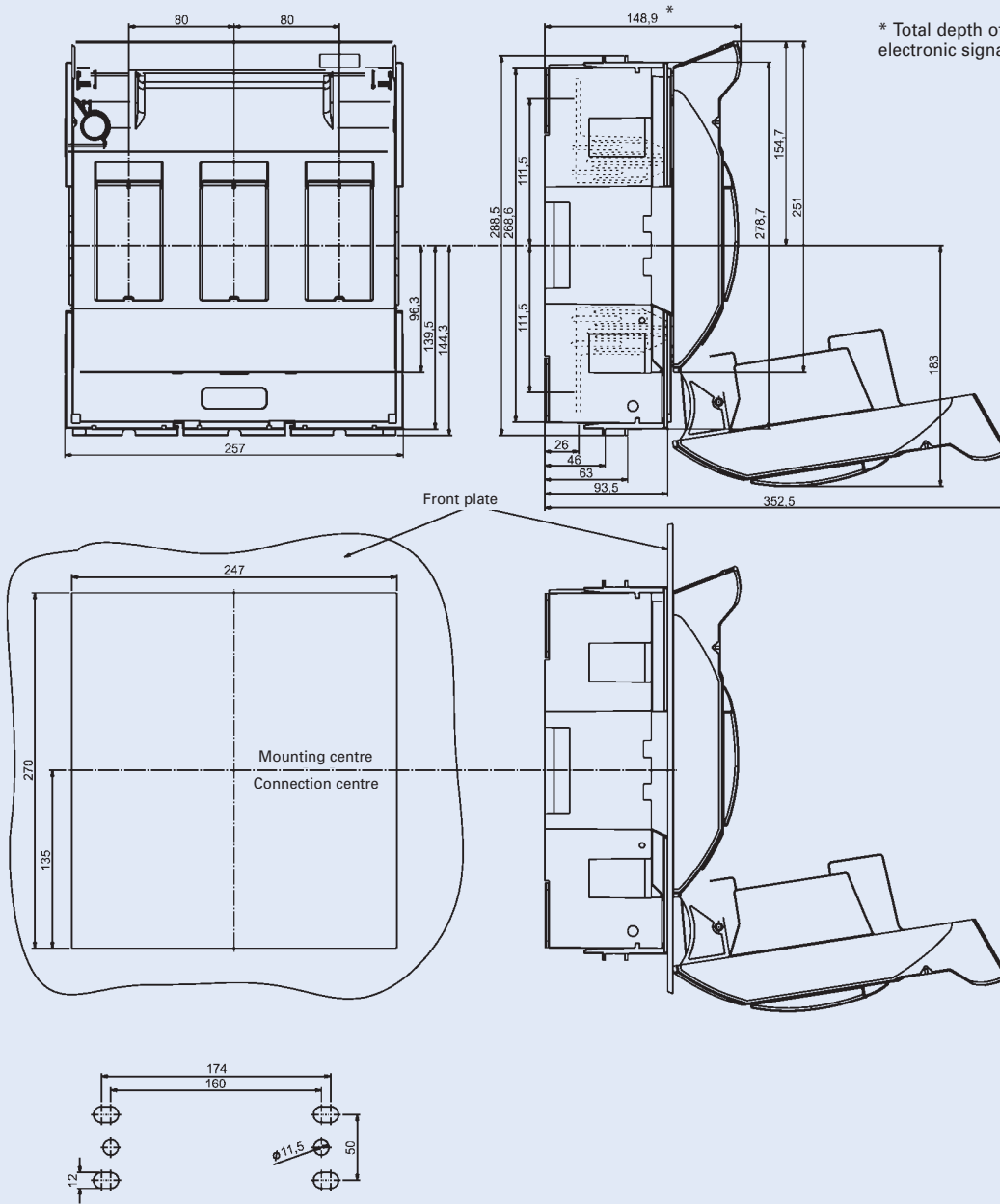

Cable Terminal Connections LTS-630/3/3

Screw connection

Screw M12 x 30
Tightening torque
35 Nm

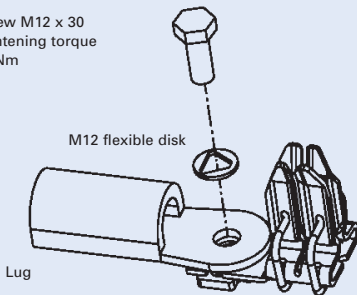

Bolt connection

Nut M12
Tightening torque
35 Nm

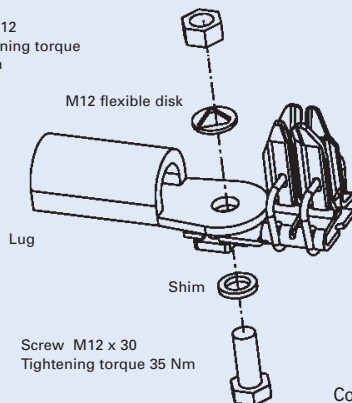

Suitable for lugs according to:
DIN 46235 max. 10-240 mm²
DIN 46234 max. 10-240 mm²
DIN 46329 max. 10-300 mm²

Note:

2 cable lugs can be connected simultaneously

Suitable for lugs according to:

DIN 46235 max. 10-240 mm²
DIN 46234 max. 10-240 mm²
DIN 46329 max. 10-300 mm²

For types and art. numbers see page 86

Copper Rails:

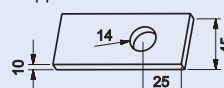

Busbar Adapter LTS

- For the drill-free mounting of LTS fuse-switch-disconnectors on busbar systems with a distance between busbars of 100 mm
- For busbar 15 x 5/10, 20 x 5/10, 25 x 5/10, 30 x 5/10, 40 x 5/10, 50 x 5/10, 60 x 5/10
- Connection on top or bottom possible
- Mounting requires little time and space
- 3-pole

Connection diagram

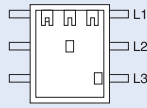

Technical Data

Adapter	Size	Distance between Busbars	Mounting	Max. Busbar Cross Section
Z-LTS-250-SAD/100-KR	1	100 mm	screw M10 15 Nm	60 x 10 mm
Z-LTS-400-SAD/100-KR	2	100 mm	screw M10 15 Nm	60 x 10 mm
Z-LTS-630-SAD/100-KR	3	100 mm	screw M10 15 Nm	60 x 10 mm

Dimensions [mm]

Symmetrical adapter, same dimensions for cable connection on top or bottom

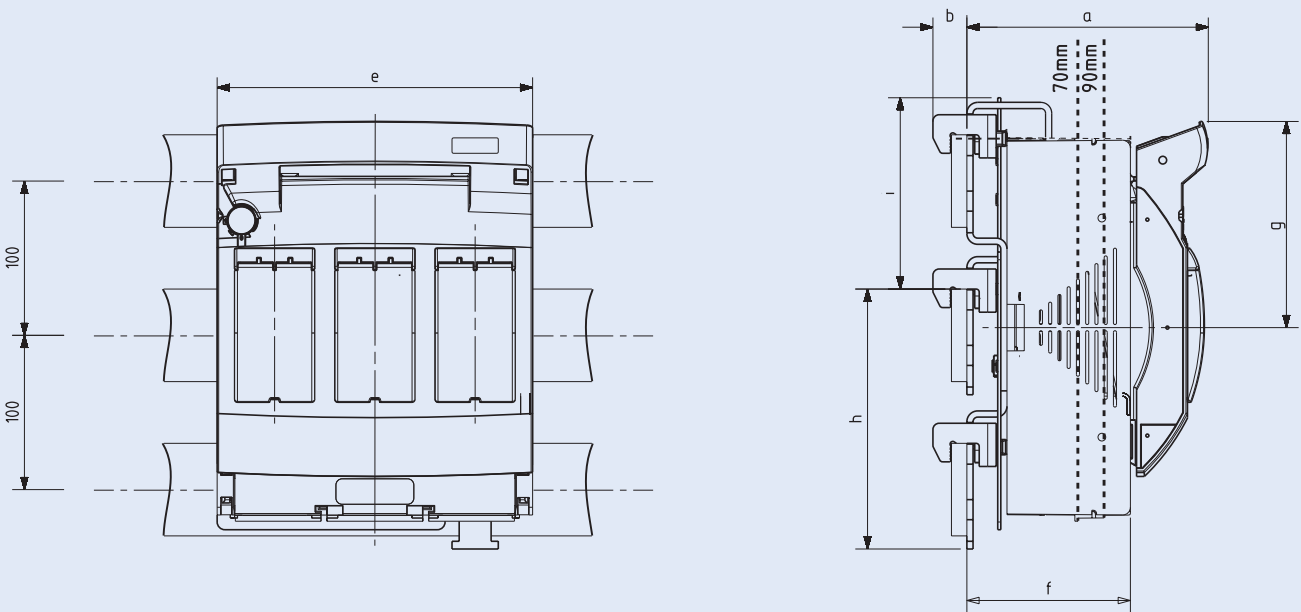

Adapter	Size	NH-Fuse-Switch-Disconnectors	a	b	e	f	g	h	i
Z-LTS-250-SAD/100-KR	1	LTS-250/1/3	137	22	185	91	127	168.5	121
Z-LTS-400-SAD/100-KR	2	LTS-400/2/3	157	22	204.5	106	134	168.5	124
Z-LTS-630-SAD/100-KR	3	LTS-630/3/3	174.5	22	256	122	155	168.5	124

Busbar Block 35 mm² Z-LTS-00/3-SV for LTS-160/00/3E

- Delivered with end caps
- Extension terminal Z-LTS-EK/95 available

Connection diagram

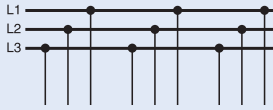

Technical Data

Electrical

Rated voltage, frequency	690/400 V, 50 Hz
Rated current	
Feeding from the side	110 A
Feeding in the middle	220 A
Rated conditional short-circuit current with back-up fuse 250 A gG(gL)	100 kA _{r.m.s}

Mechanical

Busbar cross section	35 mm ² Cu
Step distance	33 mm / 108.5 mm
Weight	446 g

Dimensions [mm]

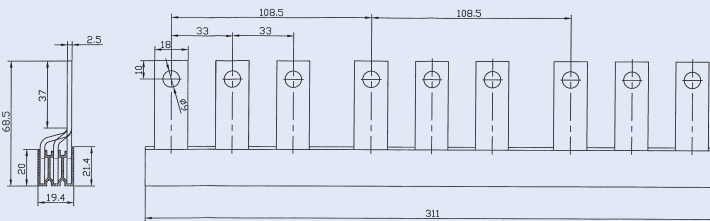

Example

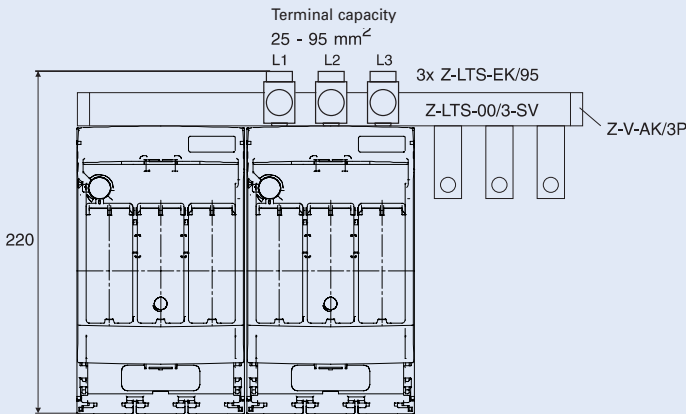

NH-Vertical Fuse Switch Disconnectors LTS-L(G)

- For power NH fuse-links
- Supplied without NH fuse links
- Symmetrical vertical fuse disconnector with a possibility of top or bottom output
- Fully insulated, finger and hand touch-safe according to EN 60947
- Base made from duroplastic strengthened with glass fibers
- Metal parts corrosion-proof
- Cover made from non-flammable termoplastic strengthened with glass fibers
- The switch cover features large viewing windows permitting to see the marking and the flat indicator of the NH-fuse links
- The sliding viewing windows feature test holes
- The switch cover can be deposited ("park position")

Connection diagram



Technical Data

	LTS-L(G)/160/00 LTS-L/160/00-60-10-R	LTS-L(G)/250/1	LTS-L(G)/400/2	LTS-L(G)/630/3
Electrical:				
Technical data according to	EN 60947	EN 60947	EN 60947	EN 60947
Size	00	1	2	3
Number of poles/phases	3	3	3	3
Conventional free air thermal current with NH-fuse links I_{th}	160 A (500 V) 160 A (690 V) 100 A (690 V) version -10-R	250 A (500 V) 200 A (690 V)	400 A (500 V) 315 A (690 V)	630 A (500 V) 500 A (690 V)
Max. permitted nominal power loss of NH fuse links	12 W	23 W	34 W	48 W
Conventional free air thermal current with solid links I_{th}	250 A	400 A	630 A	1000 A
Max. permitted nominal power loss of solid links	1.2 W	2.6 W	9 W	17.5 W
Utilisation category AC-23 B				
Rated operational voltage U_e	400 V AC	500 V AC	400 V AC	400 V AC
Rated operational current I_e	160 A	250 A	400 A	630 A
Rated short circuit making capacity with fuse links	80 kA	120 kA	120 kA	80 kA
Utilisation category AC-22 B				
Rated operational voltage U_e	500 V AC	690 V AC	500 V AC	500 V AC
Rated operational current I_e	160 A	250 A	400 A	630 A
Rated short circuit making capacity with fuse links	80 kA	120 kA	120 kA	80 kA
Utilisation category AC-21 B				
Rated operational voltage U_e	690 V AC	690 V AC	690 V AC	690 V AC
Rated operational current I_e	100 A	250 A	400 A	630 A
Rated short circuit making capacity with fuse links	10 kA	120 kA	120 kA	80 kA
Rated insulation voltage U_i	1000 V	1000 V	1000 V	1000 V
Rated impulse withstand voltage U_{imp}	8 kV	8 kV	8 kV	8 kV
Rated frequency	50–60 Hz	50–60 Hz	50–60 Hz	50–60 Hz
Rated duty	uninterrupted duty	uninterrupted duty	uninterrupted duty	uninterrupted duty
Rated short-circuit making capacity I_{cm} with solid links	4,5 kA	16 kA	16 kA	16 kA
Rated short-time withstand current I_{cw} with solid links	4.5 kA/1 s	8 kA/1 s	8 kA/1 s	12.6 kA/1 s
Power loss without NH-fuse links	20 W at 160 A	24 W at 250 A	46 W at 400 A	92 W at 630 A
Power loss without solid links	49 W at 200 A	65 W at 400 A	126 W at 630 A	161 W at 1000 A
Mechanical:				
Standard connection	M8 *	M10 *	M12 *	M12 *
For busbar max. width	20 mm	40 mm	40 mm	40 mm
For busbar	100 mm, 185 mm *	185 mm	185 mm	185 mm
For cable lugs	max. 1x70 mm ²	max. 300 mm ²	max. 300 mm ²	max. 300 mm ²
Ambient temperature range	-5 °C to +40 °C	-5 °C to +40 °C	-5 °C to +40 °C	-5 °C to +40 °C
Degree of protection	IP2Lx	IP2Lx	IP2Lx	IP2Lx
Pollution degree	3	3	3	3

* according to type

For types and art. numbers see page 88, 89

Dimensions [mm]

LTS-L/160/00

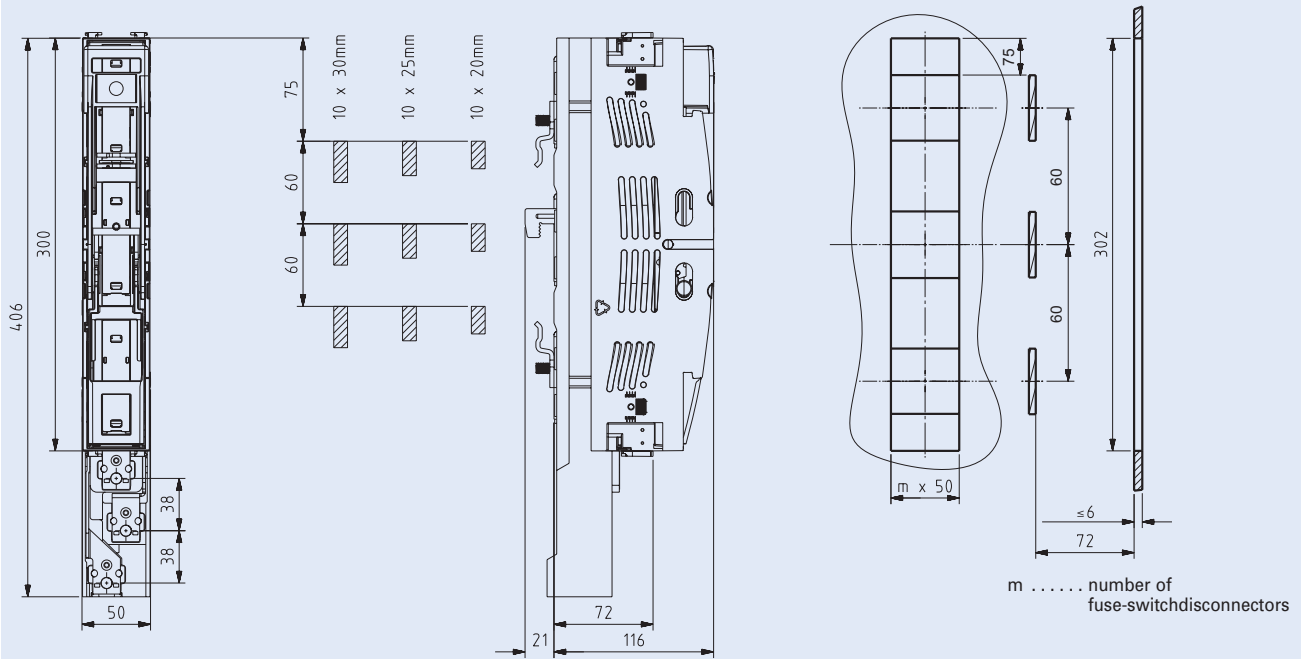

Cable Terminal Connections LTS-L/160/00

Clamp strap Z-LTS-160-BK:
Cross section Cu 4-70 mm²
Tightening torque 3-4 Nm

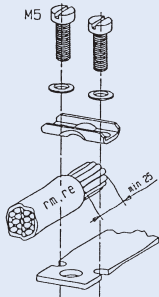

re round solid
rm round stranded
se sectorial solid
sm sectorial stranded

Screw M8
Cross section Cu 16-70, Al 16-95 mm²
Tightening torque 15-17 Nm

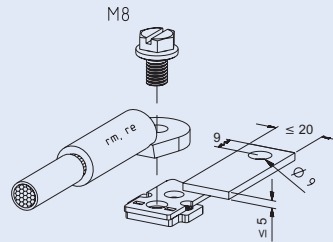

Dimensions [mm]

LTS-L(G)/160/00

Drill-free mounting with hooked clamps Z-LTS-LG/00-KR

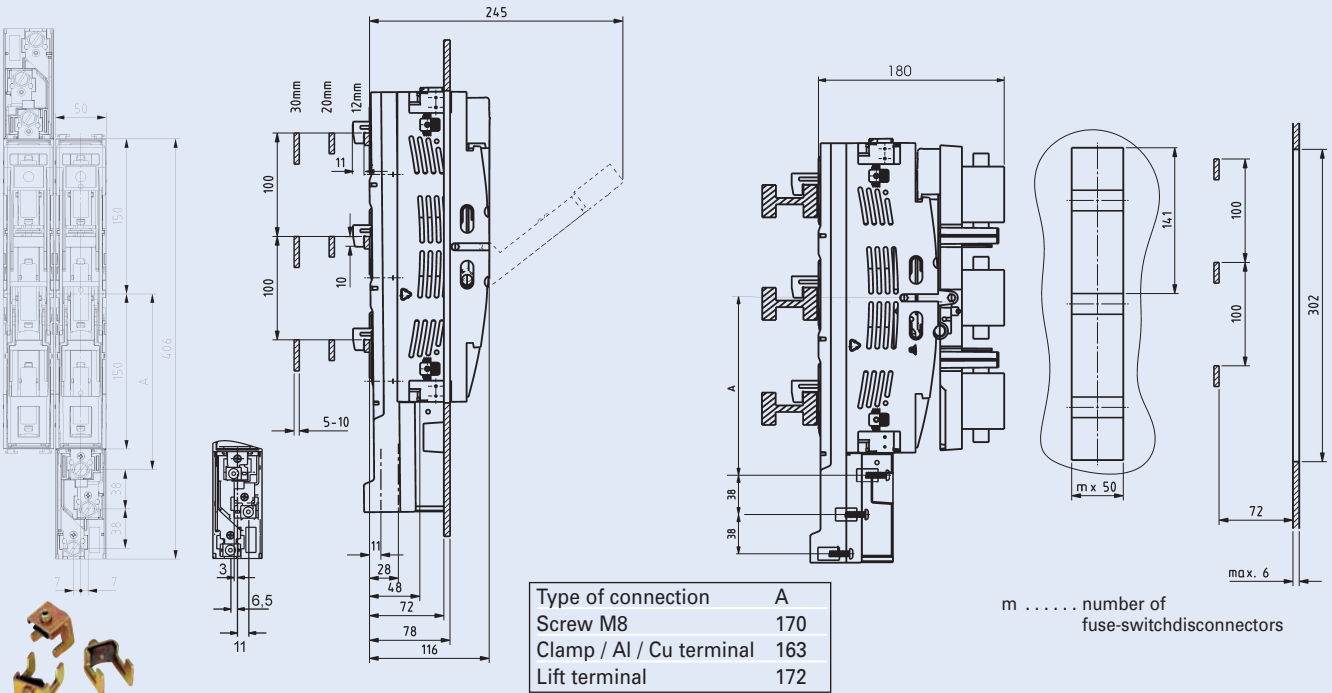

Screw Mounting - Cu drilled

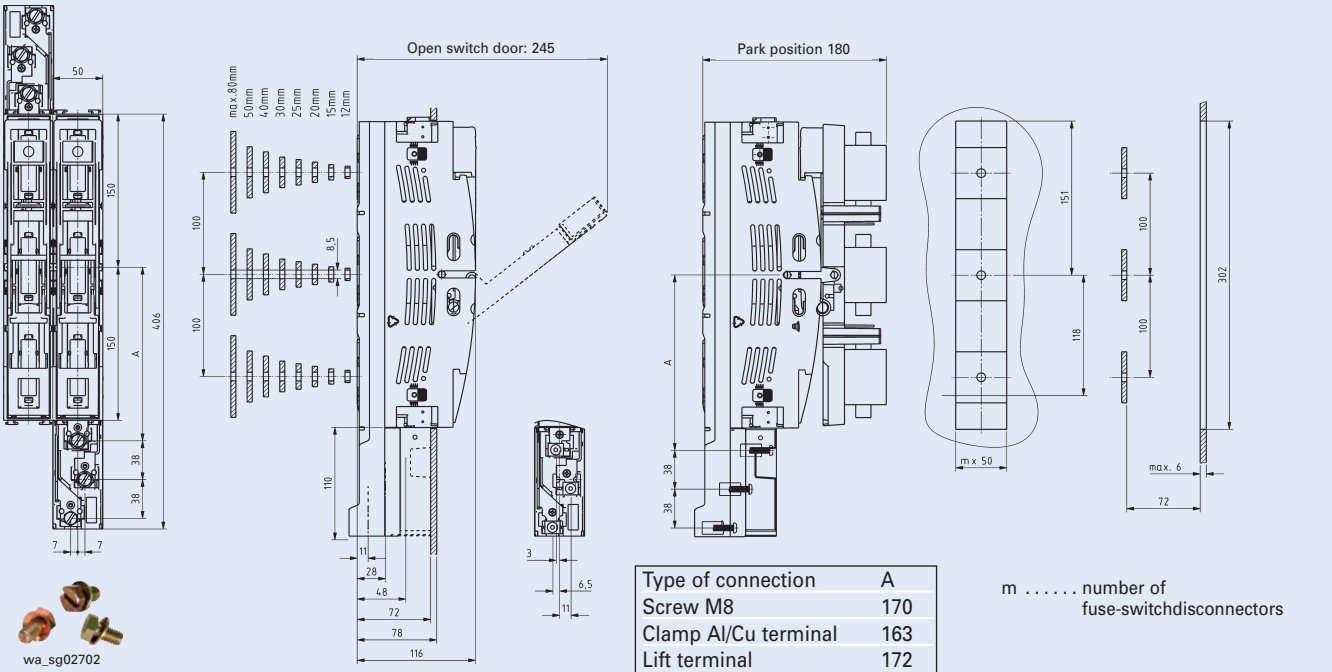

Cable Terminal Connections LTS-L/160/00

Clamp strap Z-LTS-160-BK:
Cross section Cu 4-70 mm²
Tightening torque 3-4 Nm

Screw M8
Cross section Cu 16-70, Al 16-95 mm²
Tightening torque 15-17 Nm

Cable Terminal Connections LTS-L/160/00/3-L

Cross section Cu 2.5-70 mm²
Tightening torque 6 Nm

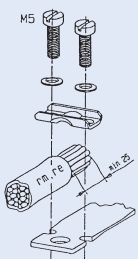

re round solid
rm round stranded
se sectorial solid
sm sectorial stranded

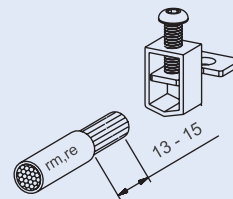
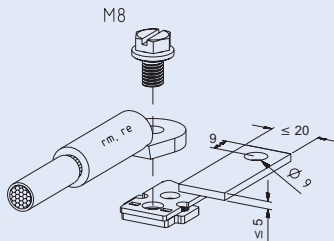

For types and art. numbers see page 88

Dimensions [mm]

LTS-L/250/1, LTS-L/400/2, LTS-L/630/3

Drill-free mounting with hooked clamps

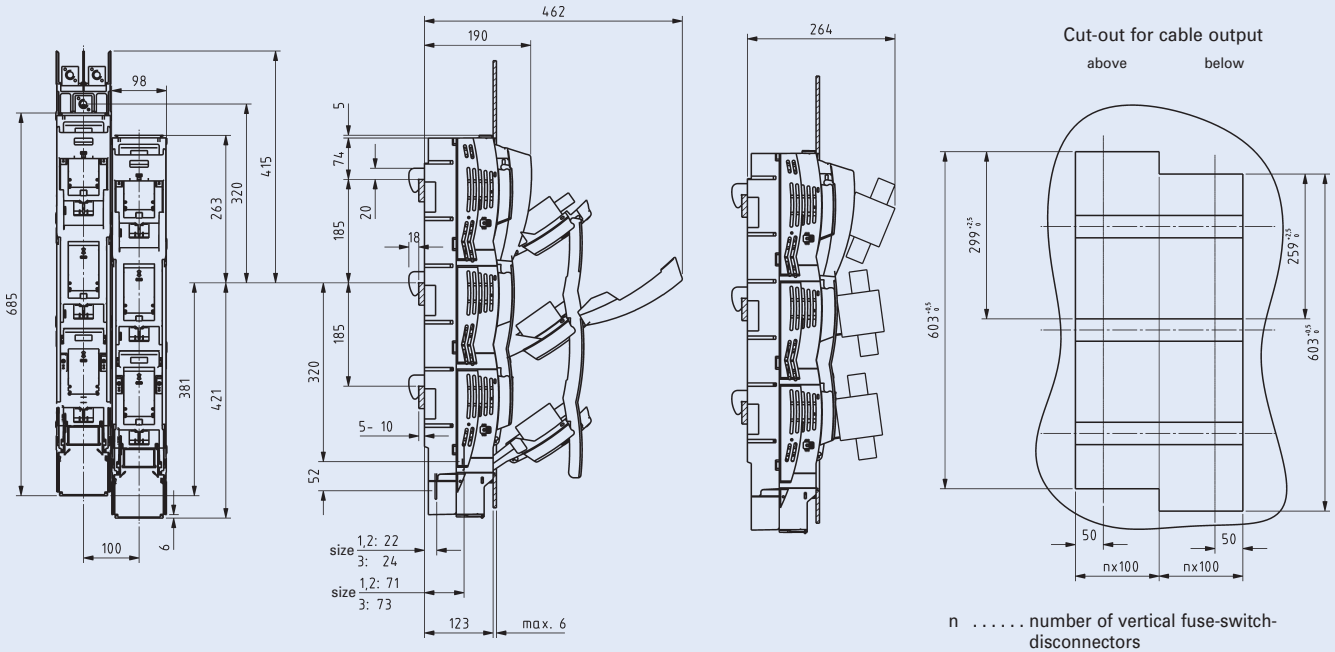

Hooked Clamps Z-LTS-L-KR

For direct mounting without drilling onto bus bar system.



Screw Mounting - Cu drilled

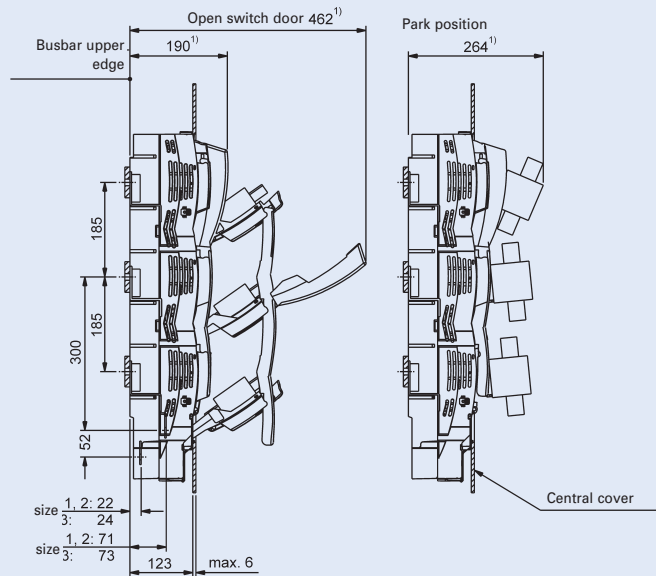
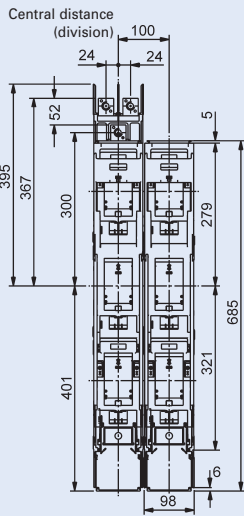

WA-SG14703

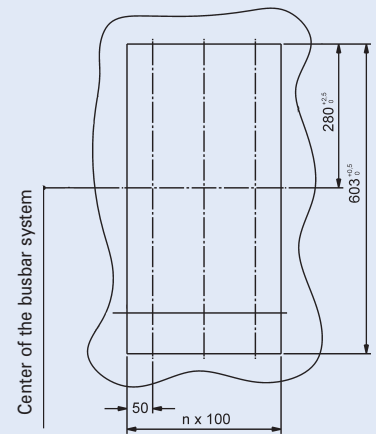

1) Dimensions to busbar upper edge

n number of vertical fuse-switch-disconnectors

Cable Terminal Connections LTS-L/250/1, LTS-L/400/2, LTS-L/630/3

Bolt connection:
Cross section max. 300 mm²
Tightening torque ± 35 Nm
Accessories: Cable lug max. width 45 mm

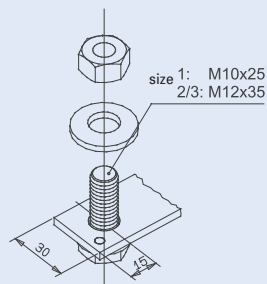

For types and art. numbers see page 88, 89

Dimensions [mm]

Kombination LTS-L/160/00 und LTS-L/250/1, LTS-L/400/2, LTS-L/630/3

Drill-free mounting with hooked clamps

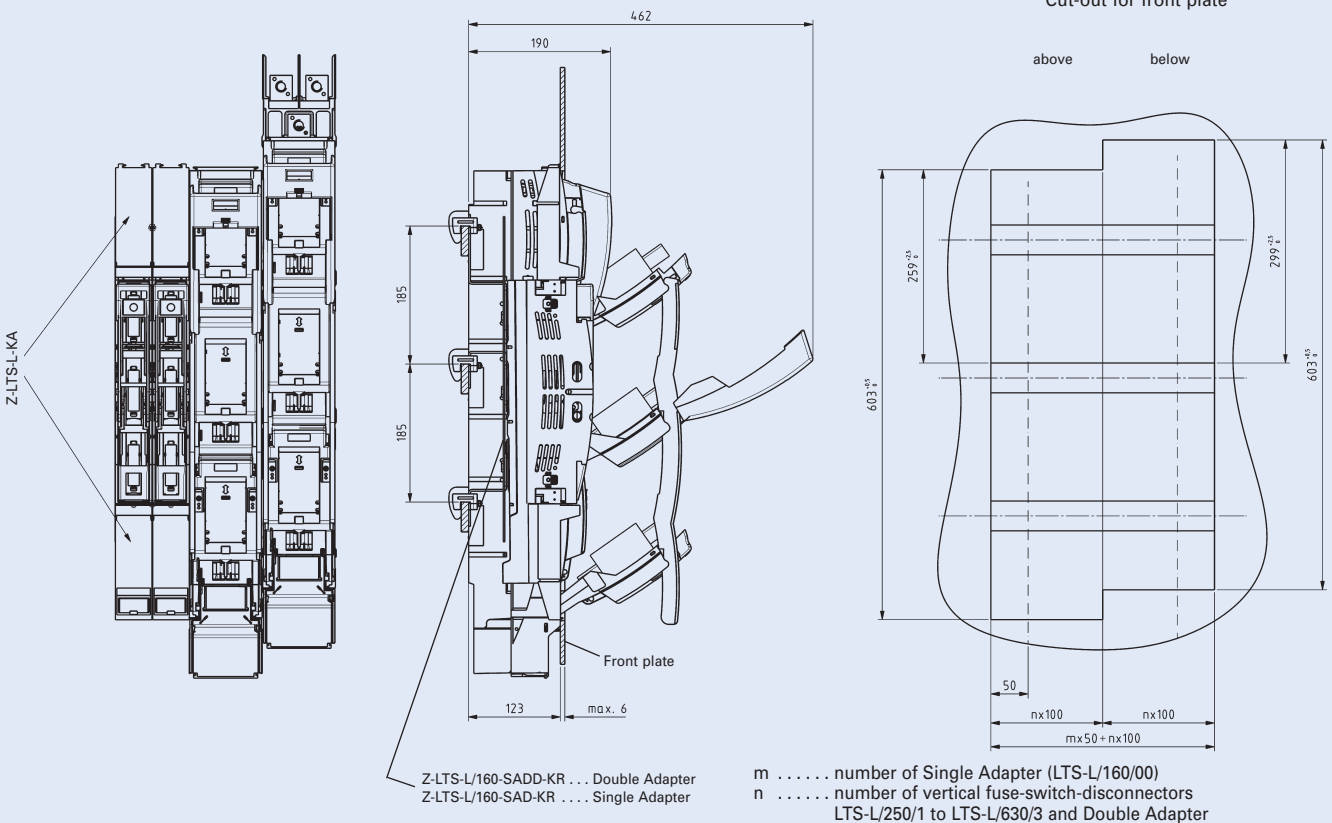

Screw Mounting - Cu drilled

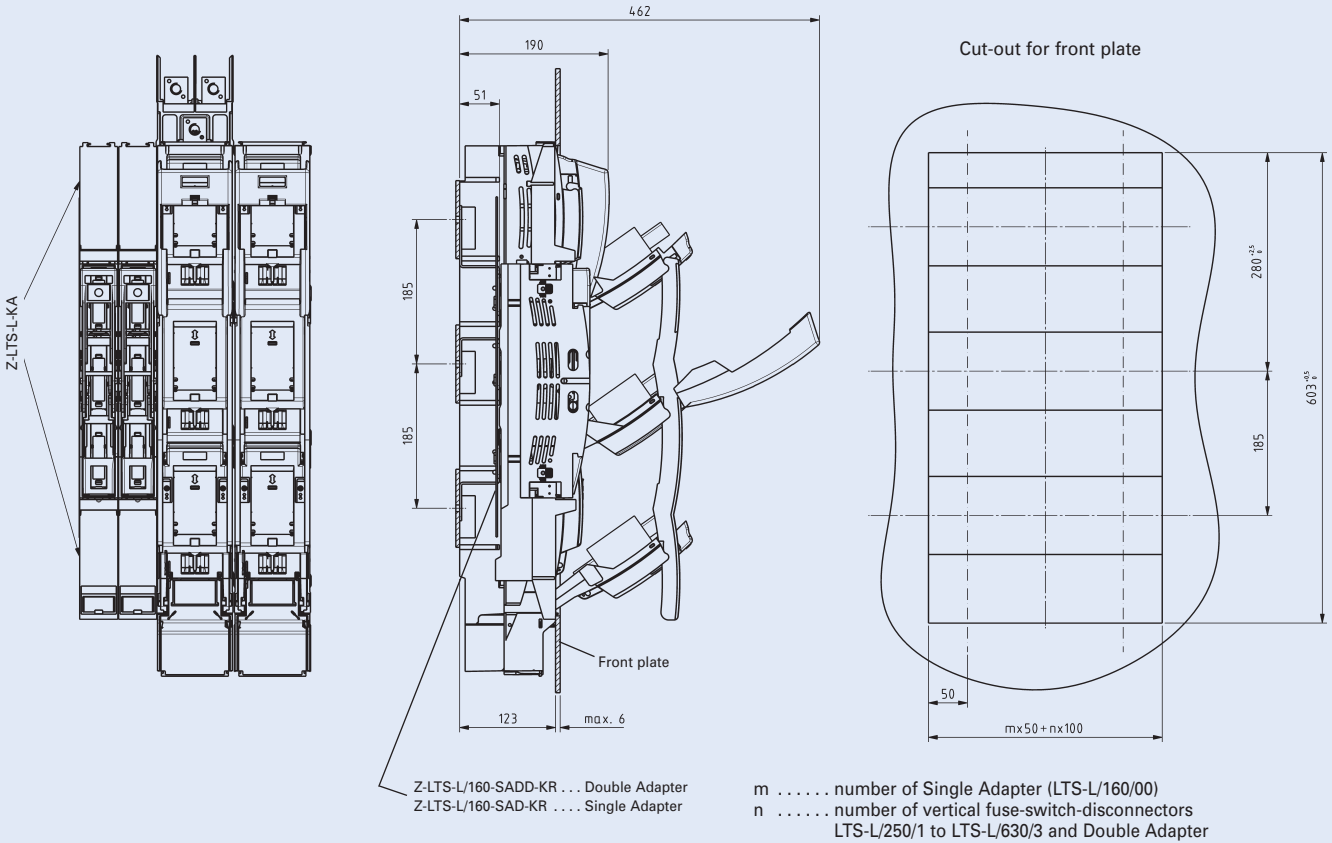

For types and art. numbers see page 88, 89

Vertical Fuse Disconnectors LTS-LG size 4a

Technical Data

	LTS-LG 1250/4a-B(T)	LTS-LG 1600/4a-B(T)
Electrical:		
Technical data according to	EN 60947	EN 60947
Rated operational voltage U_e	690 V AC	690 V AC
Size	4a	4a
Number of poles / phases	3	3
Conventional free air thermal current with NH-fuse-links I_{th}	1250 A	1600 A
Max. permitted nominal power loss of NH-fuse-links	110 W	140 W
Conventional free air thermal current with solid-links I_{th}	1250 A	1600 A
Max. permitted nominal power loss of solid-links	42 W	42 W
Utilization category AC-22B		
Rated operational voltage U_e	400 V AC	–
Rated operational current I_e	1250 A	–
Utilization category AC-21B		
Rated operational voltage U_e	–	400 V AC
Rated operational current I_e	–	1600 A
Rated insulation voltage U_i	1000 V	1000 V
Rated impulse withstand voltage U_{imp}	8 kV	8 kV
Rated frequency	50–60 Hz	50–60 Hz
Rated duty	uninterrupted duty	uninterrupted duty
Rated short-circuit making capacity I_{cm} with solid-links	68 kA	68 kA
Rated conditional short circuit current in case of protection with fuses	50 kA (400 V AC)	31,5 kA (400 V AC)
Rated short-time withstand current I_{cw} with solid-links	32 kA/1 s	32 kA/1 s
Power loss without NH-fuse-links	336 W	568 W
Power loss without solid-links	336 W at 1000 A	568 W at 1000 A
Mechanical:		
Standard connection	M16 / phase	2xM12 / phase
For busbar max. width	80 mm	80 mm
Degree of protection	IP20	IP20
Pollution degree	3	3

Dimensions [mm]

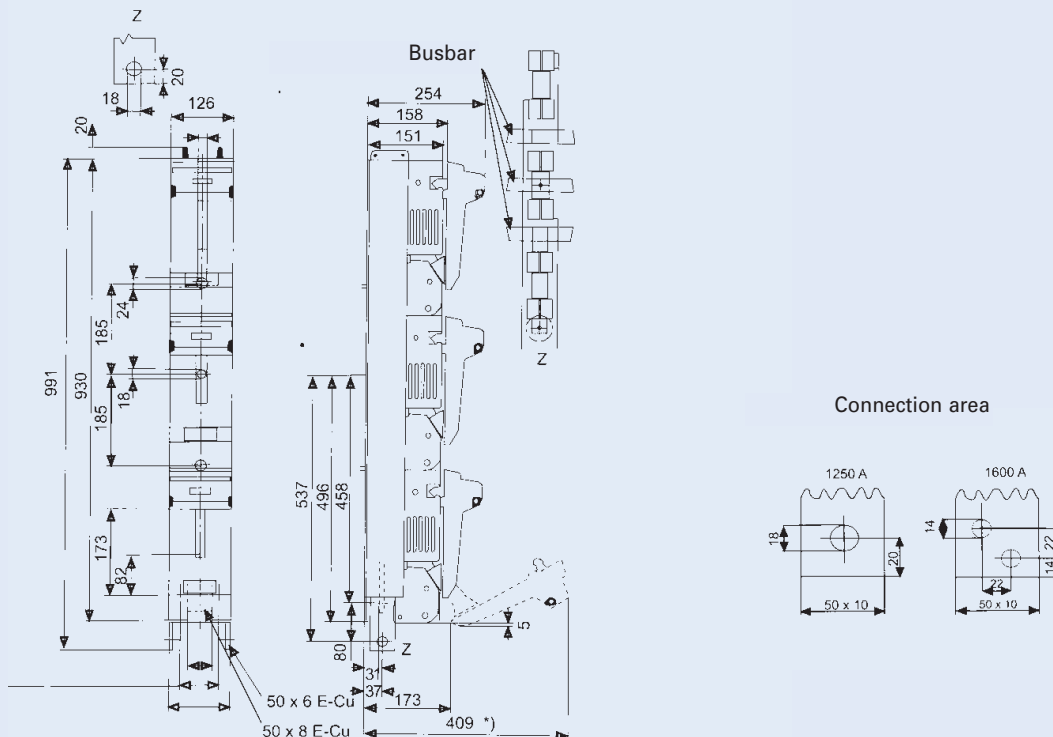

For types and art. numbers see page 89

Vertical Fuse Disconnectors for Busbars Splitting LTS-LG

- For NH fuse-links
- Vertical fuse disconnector for busbars splitting allows separation and protection of separate parts of busbar system
- Supplied without NH fuse-links
- Metal parts corrosion-proof
- Two sizes: size 2 (400 A)
size 3 (630 A)
- Universal mounting (right / left output)

Technical Data

	LTS-LG 400/2-S2	LTS-LG 630/3-1
Electrical:		
Rated voltage U_e	660 V AC	660 V AC
Rated current I_e	160 A	160 A
Max. NH fuse-link power loss	12 W	48 W

Vertical Fuse Disconnectors for Busbars Splitting (size 2, 3)

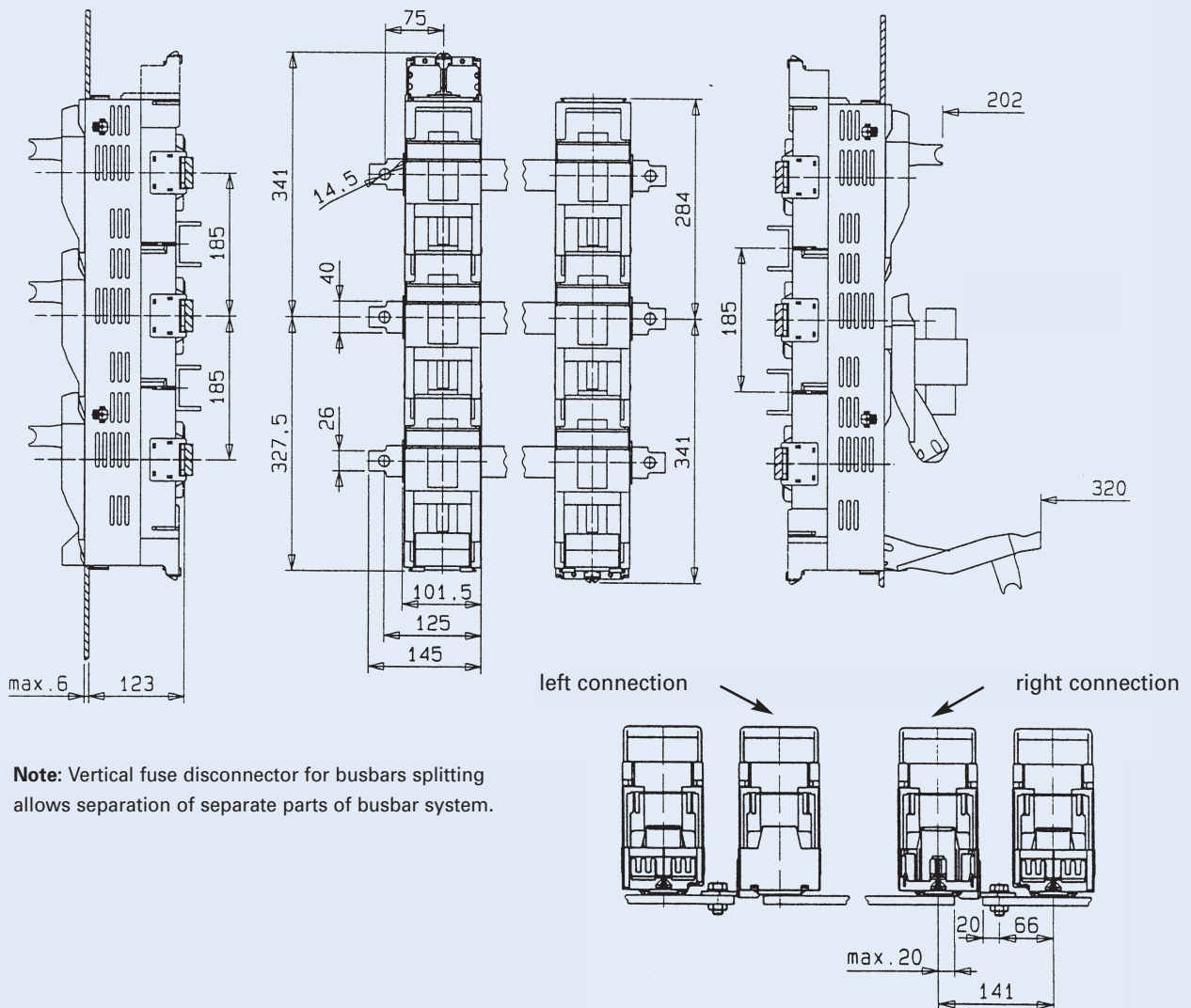

For types and art. numbers see page 89

LZM MCCBs up to 1600 A and LN Switch Disconnectors

- For protection against short circuit and overload
- Both thermal and short-circuit release adjustable
- Breaking capacity is not changed in case of reverse connection of MCCB
- Mounting: vertical, can be rotated by $\pm 90^\circ$ in each axis
- Possibility of mounting of all circuit breakers with identical mounting depth by means of spacers (step 17.5 mm)
- According to EN 60947-2
- Switch disconnectors LN are structurally identical with MCCBs LZM. They are not equipped with overcurrent tripping units (short circuit release and thermal release).
- Releases U/A for remote control can be used

Circuit diagram

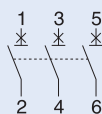

Technical data

	LZM1 / LN1	LZM2 / LN2	LZM3 / LN3	LZM4 / LN4
Electrical				
Rated current I_n	20-160 A / 63-160 A	160-300 A / 160-250 A	320-630 A / 400-630 A	800 – 1600 A
Rated operational voltage U_e	415 V AC	415 V AC	415 V AC	415 V AC
Rated insulation voltage U_i	690 V AC	690 V AC	690 V AC	690 V AC
Rated impulse withstand voltage U_{imp}				
main contacts	6000 V	6000 V	6000 V	6000 V
auxiliary contacts	6000 V	6000 V	6000 V	6000 V
Overvoltage category	III / 3	III / 3	III / 3	III / 3
Rated short-circuit making capacity I_{cm}				
240 V	121 kA / -	121 kA / -	187 kA / -	105 kA / -
400 / 415 V	76 kA / 2.8 kA	76 kA / 5.5 kA	105 kA / 25 kA	105 kA / 53 kA
Rated short-time withstand current I_{cw}				
$t = 0,3$ s	- / 2 kA	1.9 kA / 3.5 kA	3.3 kA / 12 kA	19.2 kA / 25 kA
$t = 1$ s	- / 2 kA	1.9 kA / 3.5 kA	3.3 kA / 12 kA	19.2 kA / 25 kA
Rated ultimate short-circuit breaking capacity I_{cu} of MCCB				
240 V 50/60 Hz	55 kA	55 kA	85 kA	50 kA
400/415 V 50/60 Hz	36 kA	36 kA	50 kA	50 kA
Rated service short-circuit breaking capacity I_{cs} of MCCB				
240 V 50/60 Hz	27.5 kA	27.5 kA	42.5 kA	25 kA
400/415 V 50/60 Hz	18 kA	18 kA	25 kA	25 kA
Maximum back-up fuse gG/gL				
Circuit breaker	$I_n \leq 100$ A: 200 A gG/gL $I_n \geq 125$ A: 315 A gG/gL	355 A gG/gL	$I_n \leq 400$ A: 400 A gG/gL $I_n \leq 630$ A: 630 A gG/gL	$I_n \leq 1250$ A: 2x630 A $I_n = 1600$ A: 2x800 A
Switch disconnector	$I_n \leq 125$ A: 125 A gG/gL $I_n = 160$ A: 160 A gG/gL	250 A gG/gL	630 A gG/gL	2 x 800 A gG/gL
Endurance mechanical	10000 operating cycles	10000 operating cycles	7500 operating cycles	5000 operating cycles
Maximum frequency of switching cycles	30 / 120 op. cycles/hod.	30 / 120 op. cycles/hod.	30 / 60 op. cycles/hod.	30 / 60 op. cycles/hod.
Endurance electrical				
AC-1 400/415 V 50/60 Hz	5000 operating cycles	5000 operating cycles	2500 operating cycles	1500 operating cycles
MCCB power loss per pole ¹⁾	16.7 W / 12.7 W	19 W / 16 W	40 W / 40 W	97 W / 97 W
Total disconnection time at short circuit	< 10 ms / -	< 10 ms / -	< 10 ms / -	< 25 ms / -

¹⁾ For power loss the given values are linked to maximum rated current (160 A / 300 A / 630 A / 1600 A).

Mechanical:

Frame size	45 mm	95 mm	95 mm	117 mm
Connecting terminals	Clamp type	M8 bolt connection	M10 bolt connection	M10 bolt connection
Terminal capacity				
1 conductor	2.5–70 mm ²	2.5–185 mm ²	35–240 mm ²	120–240 mm ²
2 conductors	4–25 mm ²	25–70 mm ²	4–120 mm ²	95–180 mm ²
Ambient temperature range	-25 to +70 °C	-25 to +70 °C	-25 to +70 °C	-25 to +70 °C
Mounting	4 pcs. of M4 on DIN rail using NZM1-XC35	4 pcs. of M4 on DIN rail using NZM2-XC75	4 pcs. of M5	4 pcs. of M5

Num. of auxiliary switches	LZM1 / LN1	LZM2 / LN2	LZM3 / LN3	LZM4 / LN4
HIN	1	2	3	3
HIA	1	1	1	2

LZM1 MCCBs and LN1 Switch Disconnectors

Dimensions [mm]

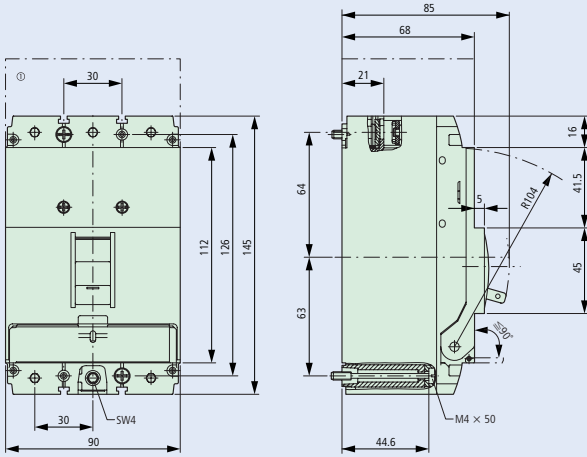

① Removable terminal cover

LZM1 circuit breaker tripping characteristic

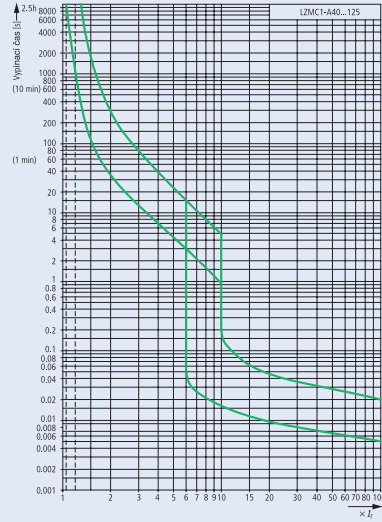

LZM2 MCCBs and LN2 Switch Disconnectors

Dimensions [mm]

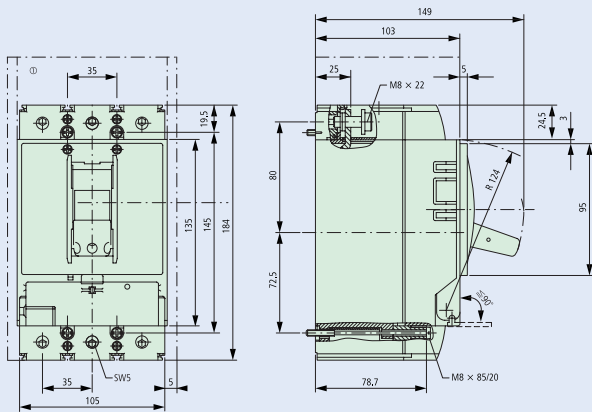

① Removable terminal cover

LZM2 circuit breaker tripping characteristic

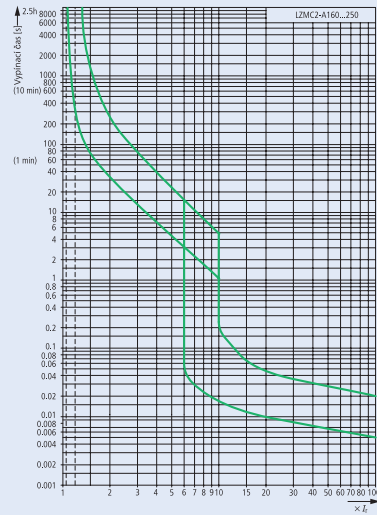

LZM3 MCCBs and LN3 Switch Disconnectors

Dimensions [mm]

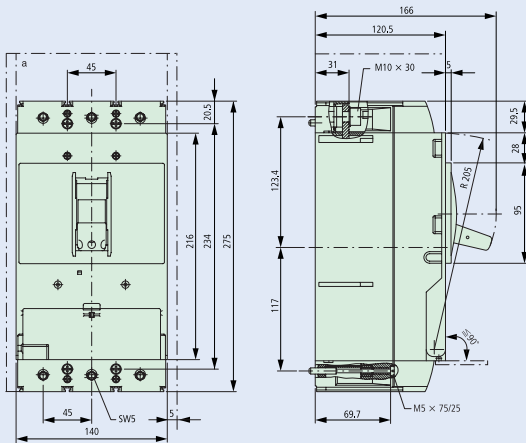

LZM3 circuit breaker tripping characteristic

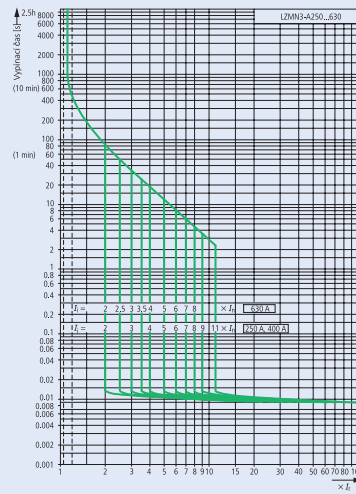

Note: Tripping characteristics of LZM3 are in lines because this MCCB is equipped with electronic releases (toleration area is not taken into account)

LZM4 MCCBs and LN4 Switch Disconnectors

Dimensions [mm]

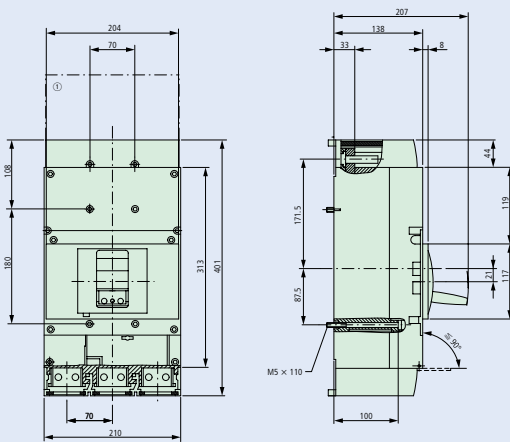

LZM4 circuit breaker tripping characteristic

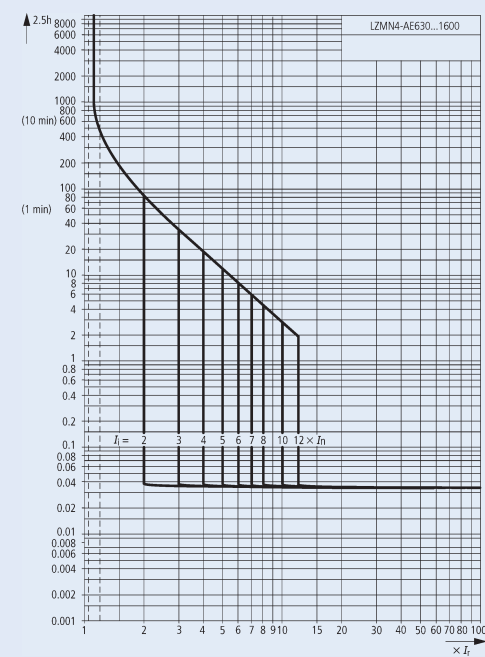

Detailed information about accessories of LZM see catalogue "Circuit-breakers and switch-disconnectors".

For types and art. numbers see page 94, 95

SPD Class T1 (I, B), Lightning Current Arrester SPI

- Field of application: For the protection of low voltage distribution systems against direct lightning stroke into the overhead power supply line or external lightning protection system (IEC 61024-1, IEC 61312-1).
- Application according to HD 60364-5-534
- SPD class **B** basically in accordance with VDE 0675, Part 6/A3 11.97
- Test class **I** in accordance with EN 61643-11
- SPD-type **T1** in accordance with EN 61643-11
- Capsuled version: during the discharge process, the device does not issue any hot ionised gases. Therefore, there is no need for keeping a safety distance to flammable materials and conductive parts.

Practical Hint

Installation of lightning current arresters upstream of the meter is subject to coordination with the relevant power supply company. Installation of an effective protection cascade (SPD classes T1 (I, B), T2 (II, C), T3 (III, C)) requires coordinated application of the respective protective devices. This is ensured by a defined line length between protective devices. When using lightning current arresters of type SPI in connection with surge arresters SPC with a maximum continuous operating voltage U_c of 460 V AC, no specific line length or decoupling coils are required. In case of building supply via underground cable and, in addition, there is no risk of direct lightning stroke it can be sufficient to use SPD class T2 (II, C) only. It is recommended, however, to use also SPD class T1 (I, B).

Technical Data

	SPI-35/440	SPI-50/NPE	SPI-100/NPE
Electrical:			
Design	capsuled	capsuled	capsuled
Responding time t_r	< 100 ns	< 100 ns	< 100 ns
Voltage protection level U_p	1.5 kV	1.5 kV	1.5 kV
Maximum continuous operating voltage U_c	440 V AC	260 V AC	260 V AC
Temporary overvoltage test value U_T (200 ms) (5 s)	–	1200 VAC	1200 VAC
Frequency	50/60 Hz	50/60 Hz	50/60 Hz
Impulse current (8/20) μs I_{max}/I_n	35 kA	50 kA	100 kA
Impulzní proud I_{imp} (10/350) μs			
Peak current	35 kA	50 kA	100 kA
Charge Q	17.5 As	25 As	50 As
Specific energy	305 kJ/Ω	625 kJ/Ω	2500 kJ/Ω
Insulation resistance R_{ISO}	>10 MΩ	>10 MΩ	>10 MΩ
Short-circuit current quenching capability I_{fi} without back-up fuse	3 kA _{r.m.s.} /260 V 1.5 kA _{r.m.s.} /440 V	500 A _{r.m.s.} /260 V	100 A _{r.m.s.} /260 V
Short-circuit current strength at max. back-up fuse	25 kA _{r.m.s.}	–	–
Maximum back-up fuse	125 AgL	–	–
Connection diagram			

Mechanical:

Frame size	45 mm	45 mm	45 mm
Device height	90 mm	90 mm	90 mm
Device width	17.5 mm	17.5 mm	35 mm
Weight	174 g	178 g	320 g
Upper and lower lift terminal capacity	rigid flexible	0.5–35 mm ² 0.5–25 mm ²	10–50 mm ² 16–35 mm ²
Tightening torque of terminal screws	4–4.5 Nm	4–4.5 Nm	6–8 Nm
Mounting	quick fastening on DIN rail EN 50022		
Degree of protection acc. to IEC 60529	IP20 (IP40)		
Accessories: busbars	Z-GV-U/		
Permitted relative air humidity	< 95 %		
Permitted ambient temperature	-40 °C to +85 °C		

Dimensions [mm]

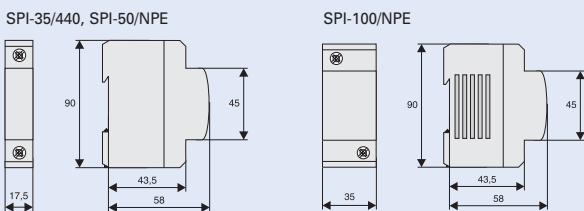

Lightning current arrester Sets, Lightning protection classes I, II, III, IV

SPI-35/440/3 SPI-3+1

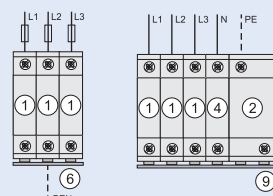

- ① ... SPI-35/440
- ② ... SPI-100/NPE
- ④ ... SPB-D-125
- ⑥ ... Z-GV-U/3
- ⑨ ... Z-GV-U/6

Application Example

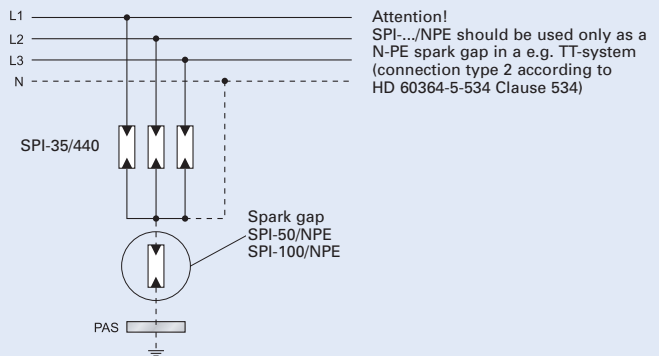

SPI-50/NPE: for protection class III, IV according to EN 62305-1

SPI-100/NPE: for protection class I, II, III, IV according to EN 62305-1

For types and art. numbers see page 98

Lead-Through Terminal for Surge Protective Devices, Class T1 (I, B), SPB-D-125

- Suitable for simplification of connection of SPDs.

Connection diagram

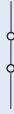

Technical Data

Electrical:

Design basically in accordance with	IEC 61643-1: 1998-02, DIN VDE 0675 part 6: 1989-11, IEC 61024-1: 1990-03, EN 60947-7-1: 1989-10, DIN VDE 0110-1: 1997-04
Rated voltage U_C	500 V AC/DC
Rated current I_n	125 A / 30 °C
Impulse current (10/350) μ s	
Peak current	100 kA
Charge Q	50 As
Specific energy	2.5 MJ/ Ω
Overvoltage category	III

Mechanical:

Frame size	45 mm
Device height	90 mm
Device width	17.5 mm
Mounting	quick fastening on DIN rail
Upper and lower terminals	lift and open-mouthed terminals
Terminal capacity	
rigid	0.5–35 mm ²
flexible	0.5–25 mm ²
Tightening torque of terminal screws	4–4.5 Nm
Permitted relative air humidity	< 95 %
Pollution degree	2
Resistance to climatic conditions	F / DIN 40040
Temperature range	-40 to +85 °C

Dimensions [mm]

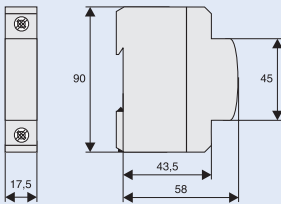

Connection type 2 according to HD 60364-5-534

Utilization of SPB-D-125 - see page 275

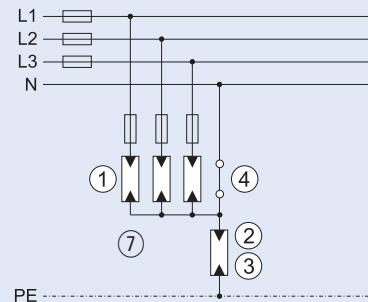

Busbars Z-GV-U

- Busbars Z-GV-U/ permit to implement customary SPD combinations
- Suitable for SPB-D-125, SPI
- The rated cross-section of Z-GV is 16 mm²
- The busbars must be cut to length in some cases

Technical Data

Electrical:

Rated voltage	230/400 V, 50/60 Hz
Rated current	63 A

Mechanical:

Busbar cross section	16 mm ² Cu
----------------------	-----------------------

Models



Z-GV-U/2



Z-GV-U/3



Z-GV-U/4



Z-GV-U/5



Z-GV-U/6



Z-GV-U/8



Z-GV-U/9

For types and art. numbers see page 98

Connection examples of SPDs class T1 (I, B) type SPI in different systems (according to HD 60364-5-534)

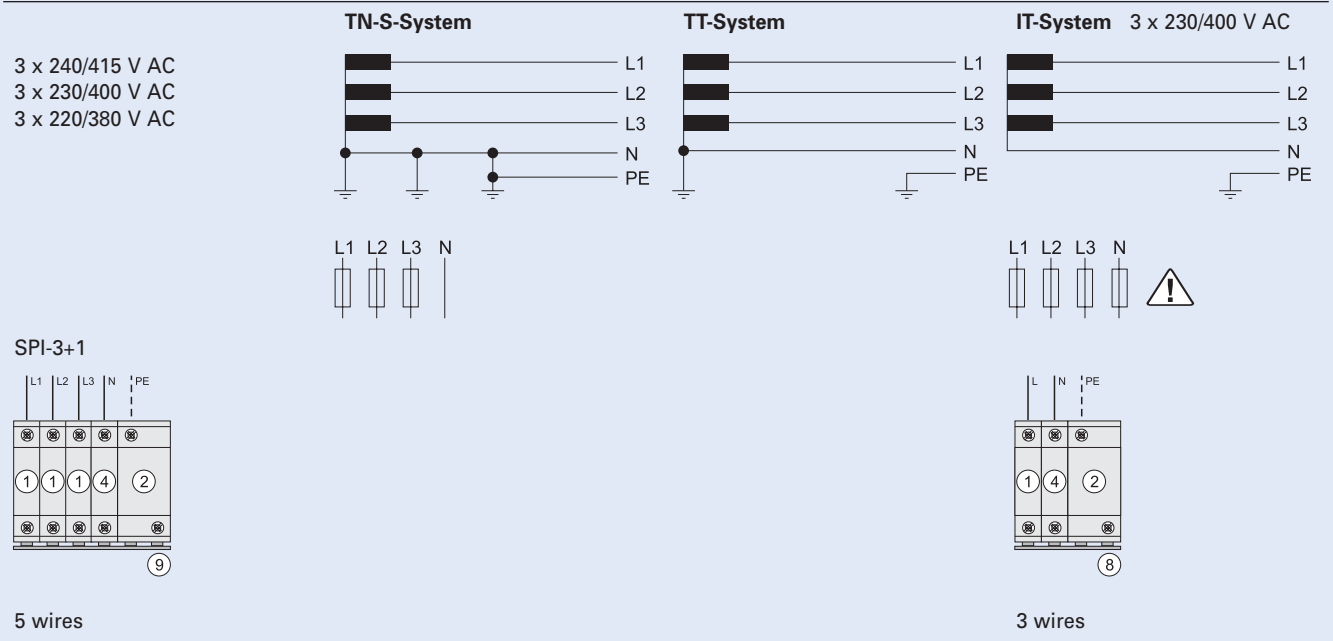
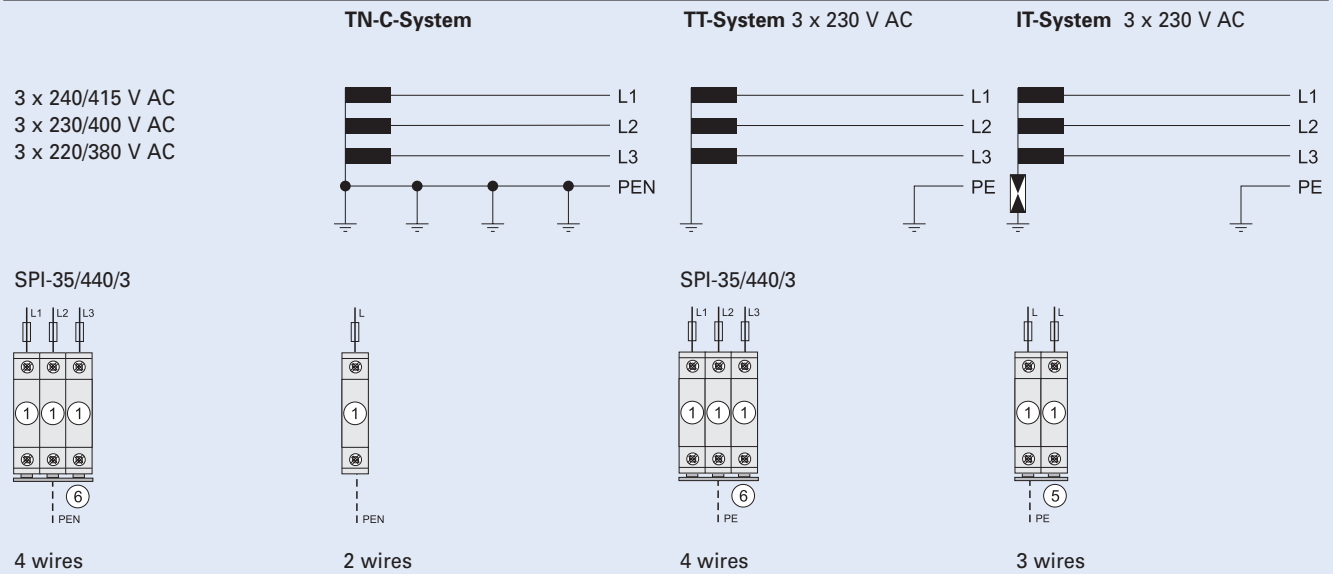

TN-S-System

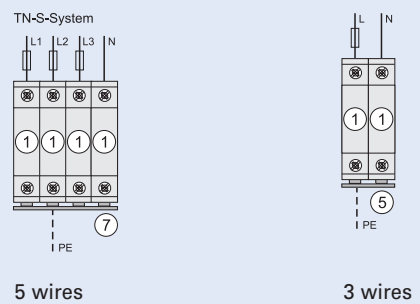

Lightning current arrester

- ① ... SPI-35/440
- ② ... SPI-100/NPE (for protection class I, II, III, IV)
- ③ ... SPI-50/NPE (for protection class III, IV)

Lead-through terminal

- ④ ... SPB-D-125

Busbar

- ⑤ ... Z-GV-U/2
- ⑥ ... Z-GV-U/3
- ⑦ ... Z-GV-U/4
- ⑧ ... Z-GV-U/4 at SPI-100/NPE
Z-GV-U/3 at SPI-50/NPE
- ⑨ ... Z-GV-U/6 (Z-GV-U/5 at SPI-50/NPE)

Connection examples of SPDs class T1 (I, B) of type SPI and SPDs class T2 (II, C) without using of decoupling coil in different systems (according to HD 60364-5-534)

Lightning current arrester

- ① ...SPI-35/440
- ⑥ ...SPI-100/NPE
- ③ ...SPI-50/NPE

Surge arrester

- ② ...SPC-S-20/460/3, SPC-E-460

Lead-through terminal

- ⑤ ...SPB-D-125
- ⑧ ...Z-D63

Busbar

- ④ ...ZV-KSBI-4TE

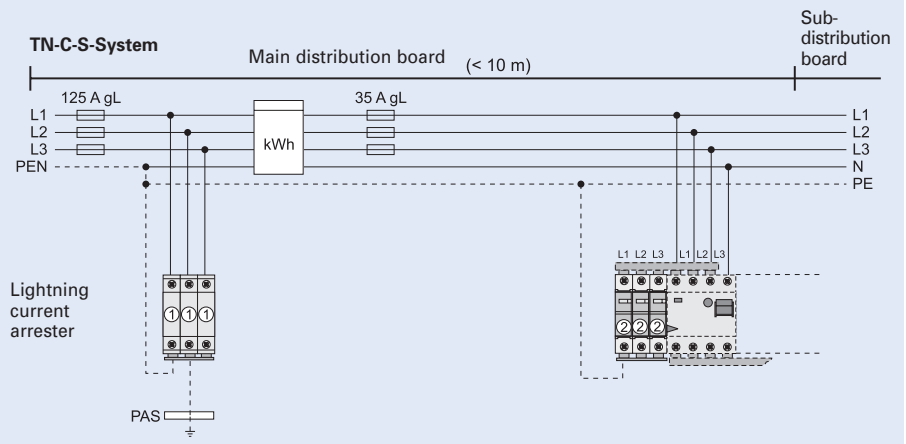

Protection Class I, II, III, IV

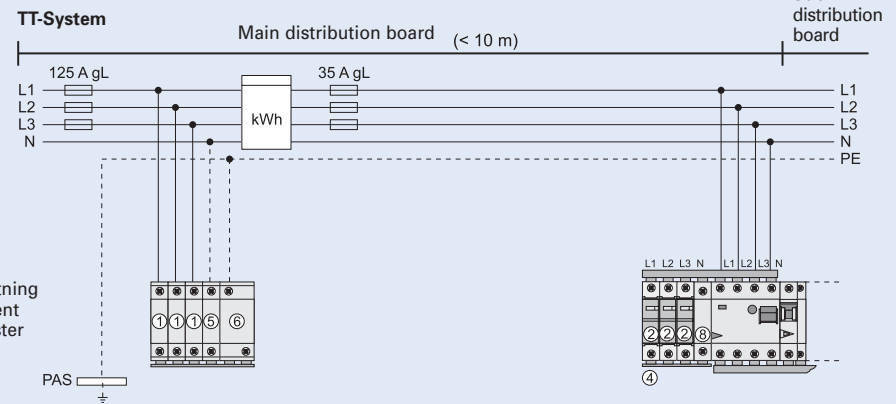

Protection Class III, IV

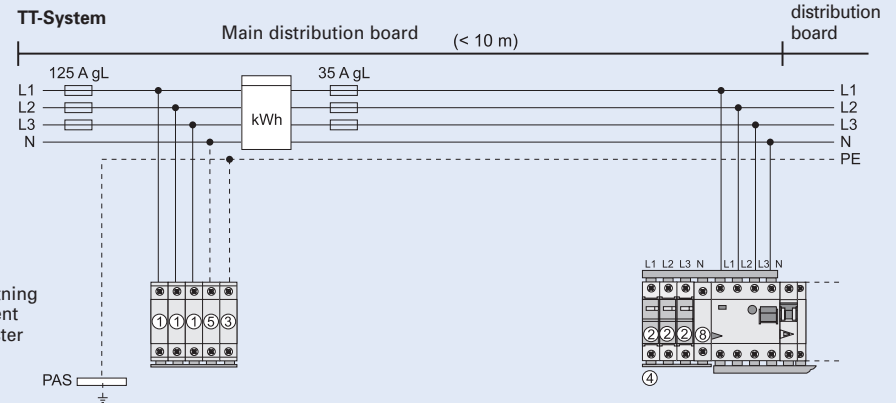



SPD Class T1+T2 (I+II, B+C), Lightning Current Arrester - Surge Arresters SPB-12/280

- For the protection of low voltage distribution systems against transient overvoltage caused by direct and indirect lightning stroke and switching operations.
- Application according to HD 60364-5-534
- Test class **I** and **II** in accordance with EN 61643-11
- SPD-type **T1** and **T2** in accordance with EN 61643-11
- Lightning protection classes III and IV in accordance with EN 62305-1

Connection diagram

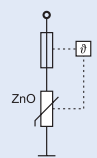

Technical Data

	SPB-12/280	SPB-100/NPE
Electrical:		
Responding time (rate of voltage rise 5 kV/μs)	< 25 ns	< 100 ns
Voltage protection level at nominal discharge current	< 1.5 kV	< 1.5 kV
Maximum continuous operating voltage U_C	280 V AC	255 V AC
Temporary overvoltage test value U_T	370 VAC (5 s)	1200 VAC (200 ms)
Rated frequency	50/60 Hz	50/60 Hz
Nominal discharge current (8/20) μs I_n	25 kA	100 kA
Maximum discharge current I_{max} (8/20) μs	50 kA	100 kA
Voltage protection level at 5 kA (8/20) μs	950 V	-
Impulse current I_{imp} (10/350) μs		
Peak current	12,5 kA	100 kA
Charge Q	6.25 As	50 As
Specific energy	39.1 kJ/Ω	2500 kJ/Ω
Open circuit voltage U_{OC}	10 kV	-
Follow current interrupt rating I_{fi}	-	100 A _{r.m.s}
Maximum back-up fuse	160 AgL/gG	-
Maximum short-circuit current	50 kA _{r.m.s}	-
Connection diagram		

Mechanical:

Frame size	45 mm	45 mm
Device height	80 mm	80 mm
Device width	17.5 mm	35 mm
Weight	121 g	250 g
Permitted ambient temperature	-40 °C to +70 °C	-40 °C to +70 °C
Degree of protection	IP40	IP40
Upper and lower lift terminal capacity	4–25 mm ²	4–35 mm ²
Upper and lower open mouthed terminals for busbar thickness up to	1.5 mm	1.5 mm
Tightening torque of terminal screws	2.4–3 Nm	2.4–3 Nm
Mounting	Quick fastening on DIN rail according to EN 60715	
Accessories: busbars 16 mm ² auxiliary switch	Type ZV-KSBI ...	SPB-HK-W

Dimensions [mm]

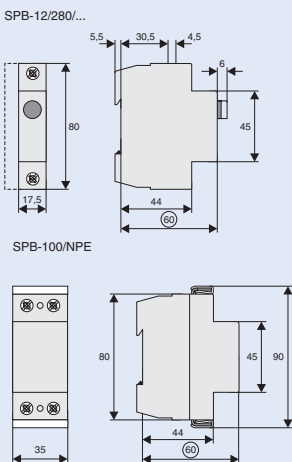

Lightning current arrester - surge arrester Sets

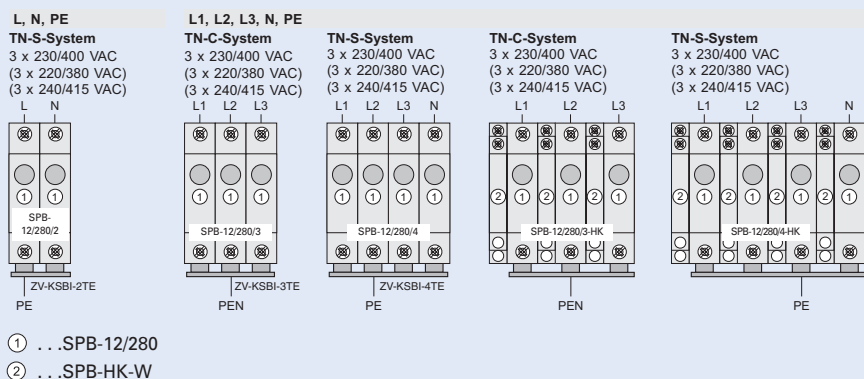

For types and art. numbers see page 99

Set consisting of SPD class T1 (I, B) and SPD class T2 (II, C), SP-B+C/3

- Combination of SPDs class T1 (I, B) and class T2 (II, C) is designed for protection of buildings, especially buildings with external protection against lightning stroke (lightning conductor) and buildings which are supplied with overhead cable.

Scope of delivery of the set

SP-B+C/3 (TN-C)

- 3 pieces of SPI-35/440 lightning current arrester
- 1 piece of SPC-S-20/460/3 surge arrester
- including busbar

SP-B+C/3+1 (TN-S)

- 3 pieces SPI-35/440 lightning current arrester
- 1 piece SPI-100/NPE sum sparring gap
- 1 piece SPB-D-125 lead-through terminal
- 1 piece SPC-S-20/460/3 surge arrester
- including busbar

Connection examples of SPDs T1 + T2 (I + II, B + C) in different systems

SPD Class T1 + T2 (I + II, B + C)

SPI B SPC C

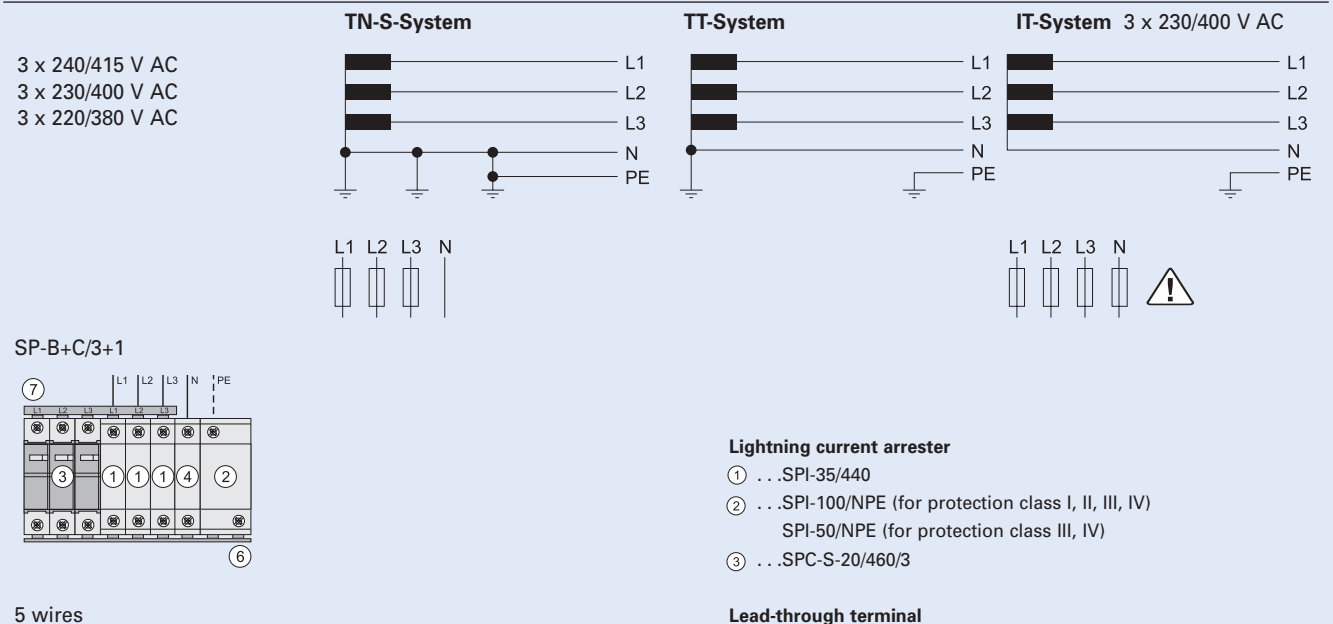
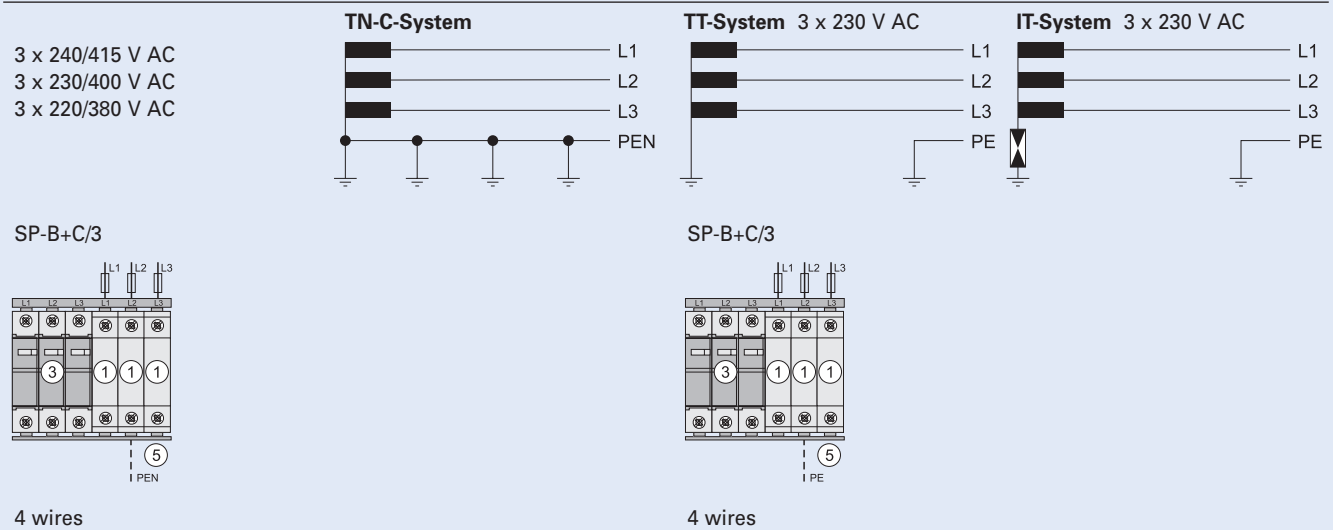

Lightning current arrester

- ① ... SPI-35/440
- ② ... SPI-100/NPE (for protection class I, II, III, IV)
SPI-50/NPE (for protection class III, IV)
- ③ ... SPC-S-20/460/3

Lead-through terminal

- ④ ... SPB-D-125

Busbar

- ⑤ ... Z-GV-U/6
- ⑥ ... Z-GV-U/9
- ⑦ ... Z-GV-16/3P-3TE/6

For types and art. numbers see page 99

SPD Class T2 (II, C), Surge Arresters SPC-E

- Field of application:
For the protection of low voltage distribution systems against transient overvoltage caused by indirect lightning stroke and switching operations.
- SPD class **C** according to ÖVE-SN 60 Part 1 / Part 4
- Test class **II** according to EN 61643-11
- SPD-type **T2** according to EN 61643-11

Connection diagram



Technical Data

	SPC-E-280	SPC-E-N/PE
Electrical:		
Responding time (rate of voltage rise 5 kV/μs)	< 25 ns	< 100 ns
Voltage protection level at nominal discharge current I_n	< 1.4 kV	< 1 kV
Voltage protection level at 5 kA (8/20) μs	1000 V	–
Maximum continuous operating voltage U_c	280 V AC	260 V AC
Maximum continuous operating voltage	50/60 Hz	50/60 Hz
Nominal discharge current I_n at (8/20) μs	20 kA	20 kA
Charge Q at I_n	0.57 As	0.57 As
Specific energy at I_n	5.7 kJ/Ω	5.7 kJ/Ω
Maximum discharge current I_{max}	40 kA	40 kA
Maximum back-up fuse	125 AgL	–
Maximum short-circuit current	50 kA	–
Short-circuit current quenching capability at U_c and I_n	–	100 A

Connection diagram

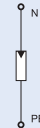
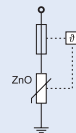

Mechanical:

Frame size	45 mm
Device height	80 mm
Device width	17.5 mm
Weight	97 g
Permitted ambient temperature	-40 °C to +70 °C
Degree of protection IEC 60529 (built-in)	IP40
Upper and lower lift terminal capacity	4–25 mm ²
Upper and lower open mouthed terminals for busbar thickness up to	1.5 mm
Tightening torque of terminal screws	2.4–3 Nm
Mounting	Quick fastening on DIN rail according to EN 60715
Accessories: busbars 16 mm ²	ZV-KSBI

Dimensions [mm]

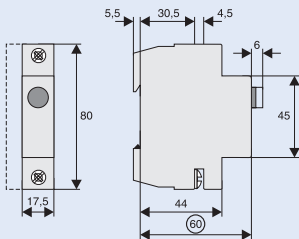

Application Examples SPC-E according to HD 60364-5-534

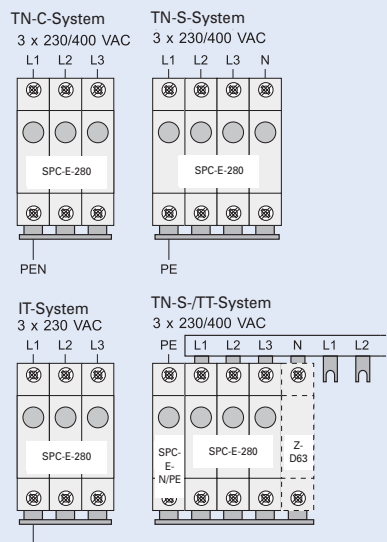

- ① ...SPB-12/280
- ② ...SPB-HK-W

For types and art. numbers see page 100

SPD Class T2 (II, C), Plug-in Surge Arresters SPC-S

- For the protection of low voltage distribution systems against transient overvoltage caused by indirect lightning stroke and switching operations.
- SPD class **C** according to ÖVE-SN 60 Part 1 / Part 4
- Test class **II** according to EN 61643-11
- SPD-type **T2** according to EN 61643-11
- Auxiliary switch SPC-S-HK for remote message transmission can be mounted onto the device

Connection diagram



Technical Data

	SPC-S-20/280	SPC-S-20/460	SPC-S-N/PE
Electrical:			
Mechanical coding	x	x	y
Responding time (rate of voltage rise 5 kV/μs)	< 25 ns	< 25 ns	< 100 ns
Voltage protection level at nominal discharge current I_n / U_{oc}	< 1.4 kV	< 2.2 kV	< 1.0 kV
Voltage protection level at 5 kA (8/20) μs	1000 V	1700 V	-
Maximum continuous operating voltage U_c	280 V AC	460 V AC	260 V AC
Temporary overvoltage test value U_T (5 s)	350 V AC	580 V AC	1200 V AC (200 ms)
Rated frequency	50/60 Hz	50/60 Hz	50/60 Hz
Open circuit voltage U_{oc}	10 kV	-	-
Nominal discharge current I_n (8/20) μs	20 kA	20 kA	20 kA
Charge Q at I_n	0.57 As	0.57 As	0.57 As
Specific energy at I_n	5.7 kJ/Ω	5.7 kJ/Ω	5.7 kJ/Ω
Maximum discharge current I_{max}	40 kA	40 kA	40 kA
Short-circuit current quenching capability at U_c and I_n	-	-	100 A
Maximum short-circuit current	50 kA	50 kA	-
Maximum back-up fuse	160 A gL	160 A gL	160 A gL
Connection diagram			

Mechanical:

Frame size	45 mm
Device height	80 mm
Device width	
1-pole	17.5 mm (1 MU)
1+1-pole	35 mm (2 MU)
2-pole	35 mm (2 MU)
3-pole	52.5 mm (3 MU)
3+1-pole	70 mm (4 MU)
4-pole	70 mm (4 MU)
Mechanical coding	
1-pole	x
1+1-pole	yx
2-pole	xx
3-pole	xxx
3+1-pole	yxxx
4-pole	xxxx
Weight Basey 1P/1+1P/2P/3P/3+1P/4P	53/120/120/180/240/240 g
Weight Complete Devices 1P/1+1P/2P/3P/3+1P/4P	110/201/220/330/412/440 g
Permitted ambient temperature	-40 °C to +70 °C
Upper and lower lift terminal capacity	4–25 mm ²
Upper and lower open mouthed terminals for busbar thickness up to 1.5 mm	
Tightening torque of terminal screws	2.4–3 Nm
Mounting	Quick fastening on DIN rail according to EN 60715
Accessories: busbars 16 mm ²	ZV-KSBI

Dimensions [mm]

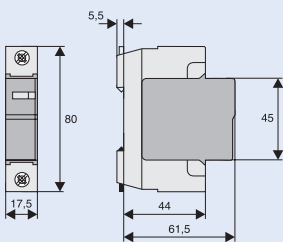

For types and art. numbers see page 100

Application Examples SPC-S according to HD 60364-5-534

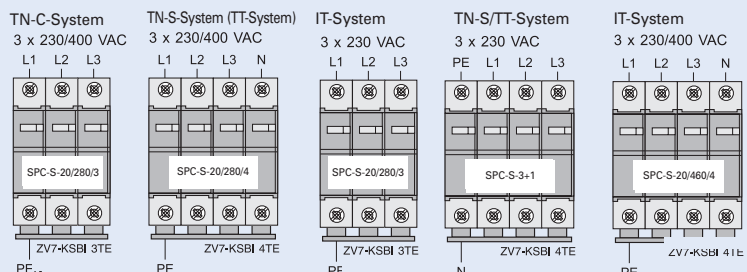

SPD Class T2 (II, C), Plug-in Surge Arresters SPC-S for special voltages

- Variants of arresters SPC-S for special voltages
- For standard application in TN system 230 / 400 V version with rated voltage 230 and 460 V are recommended
- For applications with nonstandard voltage
- Suitable e.g. for IT systems (continuous operating voltage of an arrester must be higher than phase to phase voltage)
- For the protection of low voltage distribution systems against transient overvoltage caused by indirect lightning stroke and switching operations.
- SPD class **C** according to ÖVE-SN 60 Part 1 / Part 4
- Test class **II** according to EN 61643-11
- SPD-type **T2** according to EN 61643-11
- Auxiliary switch SPC-S-HK for remote message transmission can be mounted onto the device

Connection diagram

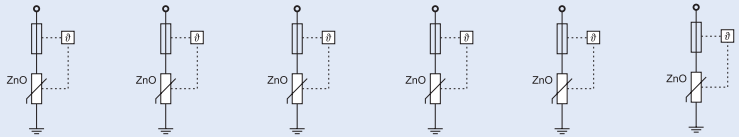

Technical Data

Inserts	SPC-S-15/75	-20/130	-20/175	-20/335	-20/385	-20/580
Electrical:						
Mechanical coding	x	x	x	x	x	x
Responding time (rate of voltage rise 5 kV/μs)	< 25 ns	< 25 ns	< 25 ns	< 25 ns	< 25 ns	< 25 ns
Voltage protection level at nominal discharge current I_n	< 550 V	< 800 V	< 1.0 kV	< 1.6 kV	< 1.8 kV	< 2.6 kV
Voltage protection level at 5 kA (8/20) μs	400 V	550 V	700 V	1200 V	1350 V	2000 V
Maximum continuous operating voltage U_c	75 V AC	130 V AC	175 V AC	335 V AC	385 V AC	580 V AC
Temporary overvoltage test value U_T (5 s)	= U_c	= U_c	= U_c	415 V AC	415 V AC	= U_c
Rated frequency	50/60 Hz	50/60 Hz	50/60 Hz	50/60 Hz	50/60 Hz	50/60 Hz
Open circuit voltage U_{OC}	-	-	-	5 kV	-	-
Nominal discharge current I_n (8/20) μs	15 kA	20 kA	15 kA	20 kA	20 kA	20 kA
Charge Q at I_n	0.43 As	0.57 As	0.57 As	0.57 As	0.57 As	0.57 As
Specific energy at I_n	3.2 kJ/Ω	5.7 kJ/Ω	5.7 kJ/Ω	5.7 kJ/Ω	5.7 kJ/Ω	5.7 kJ/Ω
Maximum discharge current I_{max}	30 kA	40 kA	40 kA	40 kA	40 kA	40 kA
Maximum short-circuit current	50 kA	50 kA	50 kA	50 kA	50 kA	50 kA
Maximum back-up fuse	160 A gL	160 A gL	160 A gL	160 A gL	160 A gL	160 A gL
Connection diagram						

Mechanical:

Frame size	45 mm
Device height	80 mm
Device width	
1-pole	17.5 mm (1 MU)
1+1-pole	35 mm (2 MU)
2-pole	35 mm (2 MU)
3-pole	52.5 mm (3 MU)
3+1-pole	70 mm (4 MU)
4-pole	70 mm (4 MU)
Mechanical coding	
1-pole	x
1+1-pole	yx
2-pole	xx
3-pole	xxx
3+1-pole	yxxx
4-pole	xxxx
Weight Basey 1P/1+1P/2P/3P/3+1P/4P	53/120/120/180/240/240 g
Weight Complete Devices 1P/1+1P/2P/3P/3+1P/4P	110/201/220/330/412/440 g
Permitted ambient temperature	-40 °C to +70 °C
Upper and lower lift terminal capacity	4–25 mm ²
Upper and lower open mouthed terminals for busbar thickness up to 1.5 mm	
Tightening torque of terminal screws	2.4–3 Nm
Mounting	Quick fastening on DIN rail according to EN 60715
Accessories: busbars 16 mm ²	ZV-KSBI

Dimensions [mm]

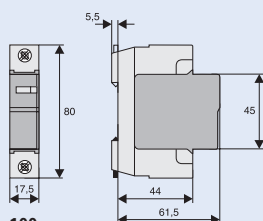

For types and art. numbers see page 100

Auxiliary Switch for Surge Arresters SPB-HK-W

- Field of application:
For mounting onto surge protective devices for external defect message transmission
- Design basically in accordance with EN 60947-5-1
- Can be mounted subsequently to SPD
- Suitable for SPB-12/280, SPC-E

Connection diagram

SPB-HK-W

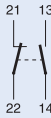

Technical Data

Electrical:

Rated insulation voltage	250 V
Rated frequency	50/60 Hz
Switching contact	
SPB-HK-W	1 NC + 1 NO
Minimum voltage per contact	24 V AC
Rated operational current AC12	2 A/250 V AC
Maximum back-up fuse	2 A gL
Overvoltage category	IV
Pollution degree	2

Mechanical:

Frame size	45 mm
Device height	80 mm
Device width	8.8 mm
Weight	41 g
Mounting	SPB-12/280, SPC-E
Degree of protection of terminals	finger and hand touch safe
Upper and lower terminals	lift terminals
Terminal capacity	2 x 2.5 mm ²
Tightening torque of terminal screws	0.8–1 Nm
Degree of protection, built-in	IP40

Dimensions [mm]

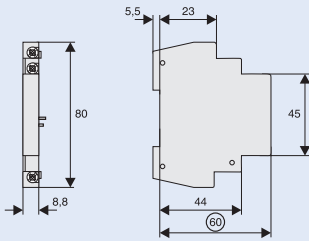

For types and art. numbers see page 99

Application Examples

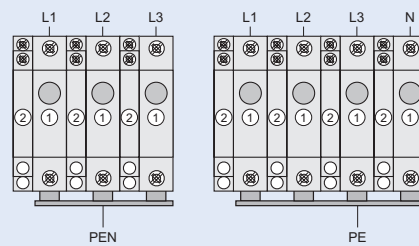

Auxiliary Switch for Surge Arresters SPC-S-HK

- Field of application:
For mounting onto surge protective devices for external defect message transmission
- Design basically in accordance with EN 60947-5-1
- Can be mounted subsequently
- Suitable for SPC-S, SPD-S-1+1

Connection diagram



Technical Data

Electrical:

Rated insulation voltage	250 V
Rated frequency	50/60 Hz
Switching contact	1 CO
Minimum voltage per contact	24 V AC
Rated operational current AC12	2 A/250 V AC
Maximum back-up fuse	2 A gL
Overvoltage category	IV
Pollution degree	2

Mechanical:

Frame size	45 mm
Device height	80 mm
Device width	8.8 mm
Weight	41 g
Mounting	screw-mounting onto SPC-S-S.
Degree of protection of terminals	finger and hand touch safe
Upper and lower terminals	lift terminals
Terminal capacity	2 x 2.5 mm ²
Tightening torque of terminal screws	0.8–1 Nm
Degree of protection, built-in	IP40

Dimensions [mm]

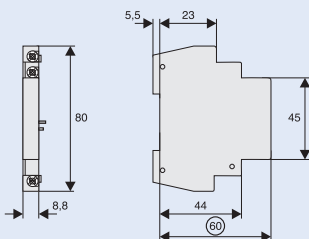

For types and art. numbers see page 100

Application Examples

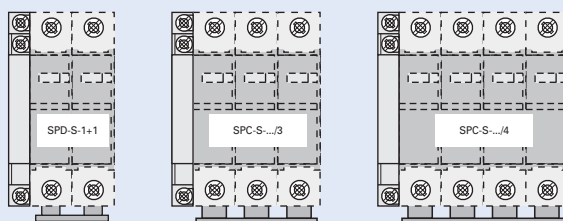

Lead-Through Terminal for Surge Protective Devices, Class T2 (II, C): Z-D63

- The lead-through terminal permits orderly wiring of SPDs of class T2 (II, C)
- 1-pole
- Suitable for standard busbar connection to all Xpole devices

Connection diagram

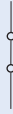

Technical Data

Electrical:

Rated voltage	500 V AC/DC
Rated current	63 A
Rated frequency	50/60 Hz

Mechanical:

Frame size	45 mm
Device height	80 mm
Device width	17.5 mm
Mounting	quick fastening on DIN rail EN 60715
Degree of protection, built-in	IP40
Degree of protection of terminals	finger and hand touch safe
Upper and lower terminals	lift and open-mouthed terminals
Terminal capacity	1–25 mm ²
Busbar thickness	0.8–2 mm
Tightening torque of terminal screws	2.4–3 Nm

Dimensions [mm]

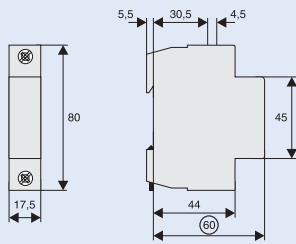

Application Example / Connection type 2 acc. to HD 60364-5-534

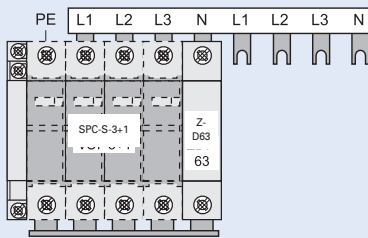

For types and art. numbers see page 101

Busbars ZV-KSBI

- Busbars ZV-KSBI permit to implement customary SPD combinations
- Suitable for SPC-..., Z-D63
- The rated cross-section of ZV-KSBI is 16 mm²
- The busbars must be cut to length in some cases

Technical Data

Electrical:

Rated voltage	230/400 V, 50/60 Hz
Rated current	63 A

Mechanical:

Busbar cross section	16 mm ² Cu
----------------------	-----------------------

Models

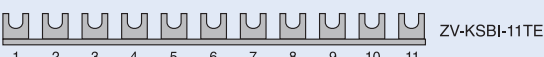

For types and art. numbers see page 101

SPD Class T3 (III, D), Surge Protective Device SPD-S-1+1 (set), SPD-S-280/2

- Field of application:
For fine protection of user equipment against transient overvoltage
- For mounting on DIN rails in distribution boxes for electrical installation EN 60715
- No decoupling from upstream surge protection of the consumer system required - SPD class T2 (II, C)
- SPD class **D** basically in accordance with ÖVE-SN 60 Part 1, 4
- Test class **III** according to EN 61643-11
- SPD-type **T3** according to EN 61643-11
- Suitable for high back-up fuse 63 A gL / C 63
- Auxiliary switch SPC-S-HK for remote message transmission can be mounted onto the device

Technical Data

	SPD-S-1+1		SPD-S-280/2	
Electrical:				
Mechanical coding	y / x		x / x	
Test class according (to IEC 61643-1)	III		III	
Test class basically in accordance (with ÖVE-SN 60, Part 1)	D		D	
Responding time (rate of voltage rise 5 kV/μs) L-N / N-PE / L-PE	< 25 ns / < 100 ns / < 100 ns		L1-L2(N) / L2(N)-PE / L1-PE < 25 ns	
Max. continuous operating voltage U_C L-N / N-PE	335 V AC / 260 V AC		L1-L2(N) / L2(N)-PE 280 V AC	
Temporary overvoltage test value U_T (5 s) L-N/L-PE	350 V AC / 416 V AC		L-N/L-PE 350 V AC / 416 V AC	
(200 ms) N-PE	1200 V AC		N-PE 1200 V AC	
Rated frequency	50/60 Hz		50/60 Hz	
Open circuit voltage U_{OC} L-N / N-PE / L-PE	5 kV		L1-L2(N) / L2(N)-PE / L1-PE 10 kV	
Voltage protection level U_p at U_{OC} L-N / N-PE / L-PE	≤ 1000 V / ≤ 900 V / ≤ 1000 V		L1-L2(N) / L2(N)-PE ≤ 950 V	
Nominal discharge current I_n L-N / N-PE / L-PE	2.5 kA (8/20) μs		L1-L2(N) / L2(N)-PE 5 kA (8/20) μs	
Voltage protection level U_p at I_n L-N / N-PE / L-PE	≤ 1000 V / ≤ 700 V / ≤ 1000 V		L1-L2(N) / L2(N)-PE ≤ 950 V	
Maximum discharge current I_{max} L-N / N-PE / L-PE	10 kA (8/20) μs		L1-L2(N) / L2(N)-PE / L1-PE 10 kA (8/20) μs	
Follow current interrupt rating I_{fi} N-PE	100 A _{r.m.s.}		-	
Maximum back-up fuse	63 A gL / C 63		63 A gL / C 63	
Maximum short-circuit current	50 kA _{r.m.s.}		50 kA _{r.m.s.}	

Connection diagram

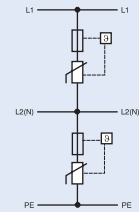
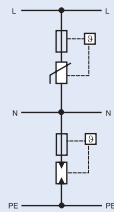

Mechanical:

Mechanical coding of base	yx	xx
Frame size	45 mm	45 mm
Device height	80 mm	80 mm
Device width	35 mm	35 mm
Weight	220 g	220 g
Upper and lower lift terminal capacity	1–25 mm ²	1–25 mm ²
Open-mouthed terminals at both sides for busbar thickness up to	1.5 mm	1.5 mm
Tightening torque of terminal screws	2.4–3 Nm	2.4–3 Nm
Permitted ambient temperature	-40 °C to +70 °C	-40 °C to +70 °C
Mounting	quick fastening on DIN rail EN 60715	
Degree of protection, built-in	IP40	IP40

Dimensions [mm]

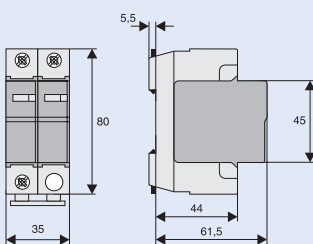

Application Examples

SPD-S-1+1

TN-, TT-System
3 x 230/400 V AC
3 x 240/415 V AC

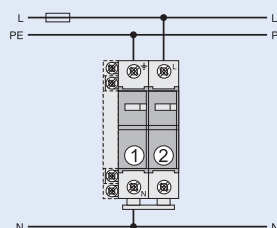

- ① ... SPD-S-N/PE
② ... SPD-S-L/N

SPD-S-280/2

IT-System
3 x 230/400 V AC

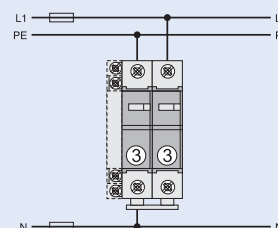

- ③ ... SPD-S-280/2

SPD-S-280/2

IT-, TT-System
3 x 133/230 V AC

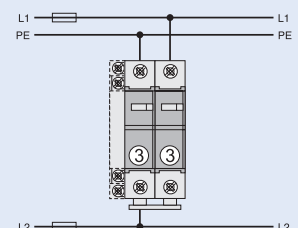

- ③ ... SPD-S-280/2

For types and art. numbers see page 102

SPD Class T3 (III, D), Surge Protective Device VDK 280 ES

- Surge arresters for protection of electronic instruments against overvoltage
- It is recommended to use SPD class T3 (III, D) in installations supplemented with SPDs class T2 (II, C)
- Distance between SPD class T2 (II, C) and T3 (III, D) should not be shorter than 5 m
- Clustered surge protection for a few sockets for distances up to 5 m
- Suitable to be installed into installation systems, e.g. cable canals and flush-mounted installation boxes
- SPD class **D** basically in accordance with VDE 0675, Part 6/A3 11.97
- Test class **III** basically in accordance with EN 61643-11
- Test type **T3** according to EN 61643-11

Connection diagram

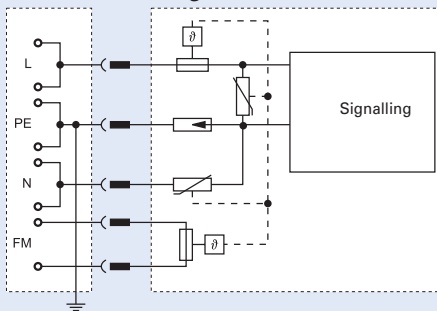

Technical Data

Electrical:

Open circuit voltage U_{oc}		4 kV
Voltage protection level U_p at U_{oc}	symm./asymm.(PE)	≤ 1.3 kV / ≤ 1.5 kV
Responding time (t_a)	symm./asymm.(PE)	≤ 25 ns / ≤ 150 ns
Maximum continuous operating voltage U_c		250 V / 50 Hz
Rated load current		16 A / 40 °C
Nominal discharge current I_n (8/20) μ s	symm./asymm.(PE)	1.5 kA / 1.5 kA
Maximum discharge current I_{max} (8/20) μ s	symm./asymm.(PE)	4.5 kA / 4.5 kA
Residual voltage at I_s	symm./asymm.(PE)	≤ 1.2 kV / ≤ 650 V
Maximum back-up fuse		16 A gL / C16
Message transmission contact		
Max. operational voltage		250 V AC
Max. operational current		3 A / 45 °C

Mechanical:

Weight	60 g	
Terminal capacity	Solid	Stranded wire
Line voltage	0.2–4 mm ²	0.2–2.5 mm ²
Message transmission contact	0.14–1.5 mm ²	0.14–1.5 mm ²
Tightening torque of terminal screws	0.5–0.6 Nm	
Permitted ambient temperature	-40 °C to +75 °C	
Degree of protection acc. to EN 529	IP40	

Dimensions [mm]

Insert: VDK 280 E

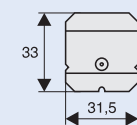
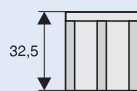

Base: VDK 280 S

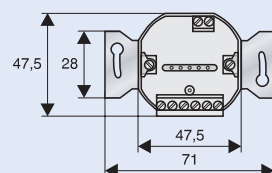
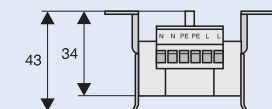

SPD class T3 (III, D), Socket with Surge Arrester

- Flush-mounted socket
- Safety flanges
- Mal-function of SPD signalisation. If red control light is lighting, SPD is broken and must be replaced. (Socket is in order, does not limit surges)

Technical Data

Electrical:

Rated voltage	250 V AC
Rated current I_n	16 A
Protection level	
-L/N	< 1.2 kV
-L/PE, N/PE	< 1 kV
Max. pulse current I_{max}	4.5 kA

Mechanical:

Device depth	32 mm
Mounting	into installation boxes
Terminal capacity	
L/N	4 x 2.5 mm ²
PE	2 x 4 mm ²

For types and art. numbers see page 102

SPD Class T3 (III, D), Plug-in-SPD SPD-STC

- For protection of user equipment against transient overvoltage in case of upstream surge protection in the low voltage distribution system
- Designed in the form of an earth-contact intermediate plug with integrated baby safe
- Pilot lamp operation/failure
 - Green LED lights - operating
 - Green LED does not light - failure
- No line length from upstream installed arrester class T2 (II, C) necessary
- Test class **III** according to EN 61643-11
- SPD-type 3 **T3** according to EN 61643-11
- Comply with standards: VDE 0620-1, SEK SS 428 08 34, NEK-HD 195 S6

Technical Data

		SPD-STC
Electrical:		
Rated voltage		230 V AC
Rated frequency		50 Hz
Rated load current I_L		16 A
Voltage protection level U_p	symm. / asymm. (PE)	1.2 kV / 1.5 kV
Maximum continuous operating voltage U_c	symm. / asymm. (PE)	275 V / 360 V AC
Open circuit voltage U_{oc}		4 kV
Nominal discharge current I_n		3 kA
Maximum discharge current I_{max}		8 kA
Maximum back-up fuse		16 A gL / C 16
Maximum short-circuit current		3 kA _{r.m.s.}
Overvoltage category		III
Mechanical:		
Device size		103 x 63 x 70 mm
Weight		110 g
Mounting		Intermediate plug in protective earth socket
Degree of protection acc. to IEC 60529		IP20
Range of temperature		-25 °C to +75 °C
Flame class		V0
Pollution degree		2

Dimensions [mm]

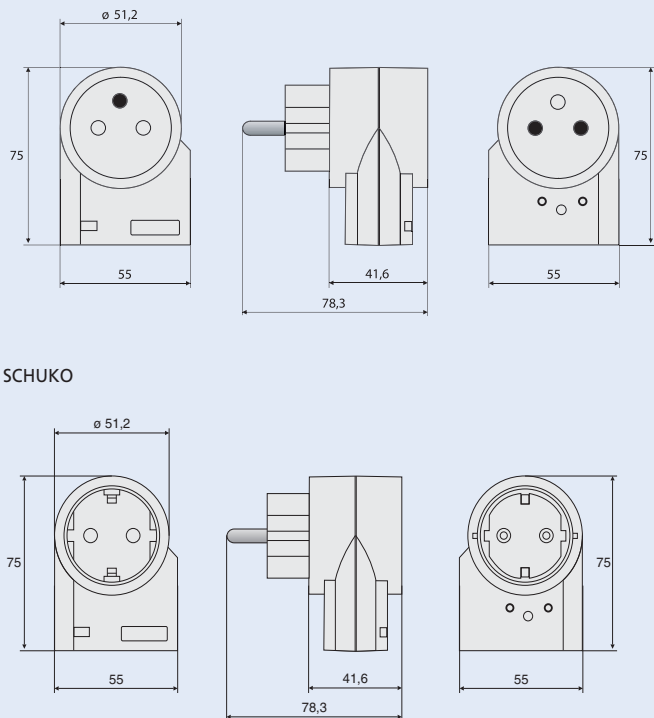

Connection diagram

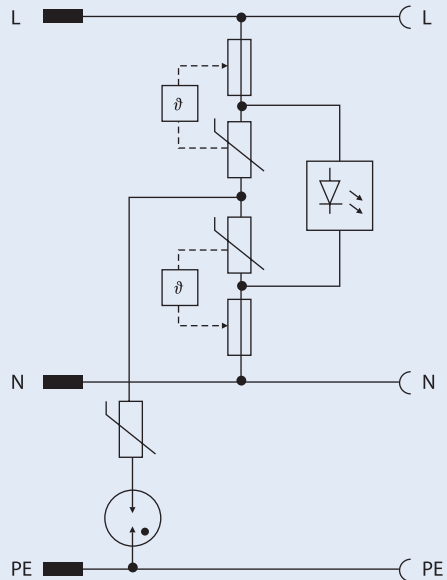

SPD Class T3 (III, D), Plug-in-SPD SPD-STC/ISDN

- For protection of user equipment against transient overvoltage in case of upstream surge protection in the low voltage distribution system
- Designed in the form of an earth-contact intermediate plug with integrated baby safe
- Pilot lamp operation/failure
 - Green LED lights - operating
 - Green LED does not light - failure
- No line length from upstream installed arrester class T2 (II, C) necessary
- Mains protection:
 - Test class III according to EN 61643-11
 - SPD-type T3 according to EN 61643-11
- ISDN-S0 - Interface:
 - Tested according to EN 61643-21
- Comply with standards: VDE 0620-1, SEK SS 428 08 34, NEK-HD 195 S6

Technical Data

		SPD-STC/ISDN
Electrical - Mains side		
Rated voltage		230 V AC
Rated frequency		50 Hz
Rated load current I_L		16 A
Voltage protection level U_p	symm. / asymm. (PE)	1.2 kV / 1.5 kV
Maximum continuous operating voltage U_c	symm. / asymm. (PE)	275 V / 360 V AC
Open circuit voltage U_{oc}		4 kV
Nominal discharge current I_n		3 kA
Maximum discharge current I_{max}		8 kA
Maximum back-up fuse		16 A gL / C 16
Maximum short-circuit current		3 kA _{r.m.s.}
Overvoltage category		III
Electrical - ISDN-S0-Interface		
Cut off frequency f_g (3 db)	symm. in the 100 Ω -system	300 kHz
Protection level U_p	Line-Line: C1 (1 kV/0.5 kA)	≤ 65 V
	Line-PE: C2 (4 kV/2 kA)	≤ 900 V
Max. continuous operating voltage U_c		6 V DC
Impulse durability	Line-Line:	C1 (1 kV/0.5 kA) C3 (7.5 kV/100 A)
	Line-PE:	C2 (4 kV/2 kA) C3 (7.5 kV/100 A)
Mechanical		
Device size		104 x 63 x 79 mm
Weight		144 g
Mounting		Intermediate plug in protective earth socket
Degree of protection acc. to IEC 60529		IP20
Range of temperature		-25 °C to +75 °C
Flame class		V0
Pollution degree		2

Dimensions [mm]

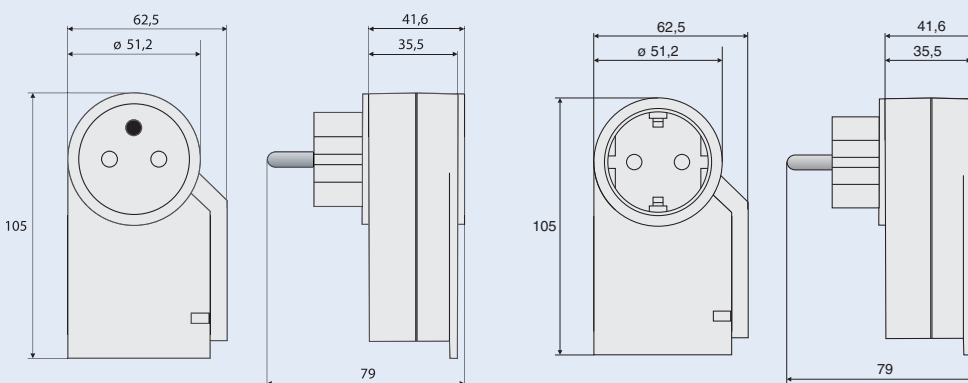

Practical Hint

No telecom signal – protection device of the ISDN-S0-interface is defect.

For types and art. numbers see page 103

Connection diagram

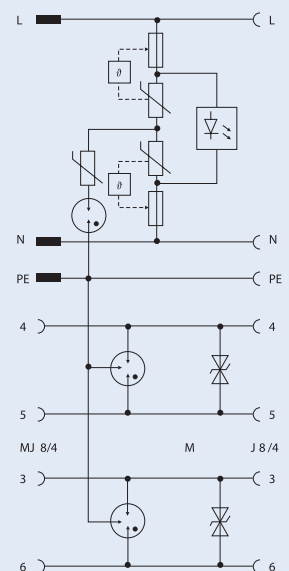

SPD Class T3 (III, D), Plug-in-SPD SPD-STC/TV-SAT

- For protection of user equipment against transient overvoltage in case of upstream surge protection in the low voltage distribution system
- Designed in the form of an earth-contact intermediate plug with integrated baby safe
- Pilot lamp operation/failure
 - Green LED lights - operating
 - Green LED does not light - failure
- No line length from upstream installed arrester class T2 (II, C) necessary
- Mains protection:
 - Test class **III** according to EN 61643-11
 - SPD-type **T3** according to EN 61643-11
- TV/SAT - Interface:
 - Tested according to EN 61643-21
- Comply with standards: VDE 0620-1, SEK SS 428 08 34, NEK-HD 195 S6

Technical Data

		SPD-STC/TV-SAT
Electrical - Mains side		
Rated voltage		230 V AC
Rated frequency		50 Hz
Rated load current I_L		16 A
Voltage protection level U_p	symm. / asymm. (PE)	1.2 kV / 1.5 kV
Maximum continuous operating voltage U_c	symm. / asymm. (PE)	275 V / 360 V AC
Open circuit voltage U_{oc}		4 kV
Nominal discharge current I_n		3 kA
Maximum discharge current I_{max}		8 kA
Maximum back-up fuse		16 A gL / C 16
Maximum short-circuit current		3 kA _{r.m.s.}
Overvoltage category		III
Electrical - ISDN-S0-Interface		
Operating frequency range		DC ... 2400 MHz
Insertion loss a_E		≤ 0.3 dB to 2.4 GHz
Return loss a_R		≤ 14 dB to 2.4 GHz
Protection level U_p	Inner conductor-Shield: C2 (4 kV/2 kA)	≤ 700 V
	Shield-PE: C2 (10 kV/5 kA)	≤ 1200 V
Max. continuous operating voltage U_c		72 V DC
Impulse durability	Inner conductor-Shield:	C2 (4 kV/2 kA) C3 (7.5 kV/100 A)
	Shield-PE:	C2 (10 kV/5 kA) C3 (7.5 kV/100 A)
Mechanical		
Device size		104 x 63 x 79
Weight		157 g
Mounting		Intermediate plug in protective earth socket
Degree of protection acc. to IEC 60529		IP20
Range of temperature		-25 °C to +75 °C
Flame class		V0
Pollution degree		2

Dimensions [mm]

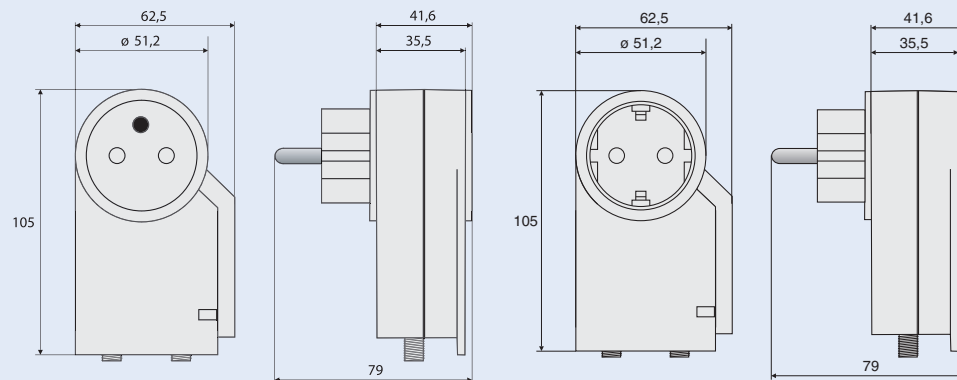

Connection diagram

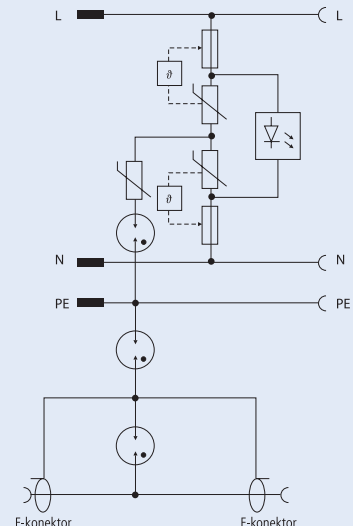

Practical Hint

No TV-signal – protection device of the TV/SAT-interface is defect.

For types and art. numbers see page 103

SPD class T3 (III, D), Multiple Socket Ledges 19" with Switch SPD-STL/19

Technical Data

SPD-STL/19/7F-S/BL/UTE

Electrical

Tested according to	IEC 61643-1+A1 / EN 61643-11
SPD-type / Test class	T3 / III
Maximum continuous operating voltage U_c	255 V / 50 Hz
Rated load current / Rated current I_L	16 A
Max. back-up fuse	B 16 / 16 A gG
Open circuit voltage U_{oc}	5 kV
Voltage protection level U_p at U_{oc}	symm./asymm. (PE) 1 kV / 1 kV
Short-circuit strength with maximum back-up fuse	6 kA _{rms}
Filter	-

Mechanical

Device size	19" x 1HE x 44 mm
Permitted ambient temperature	-5 °C to +25 °C
Degree of protection acc. to IEC 60529	IP20

Dimensions [mm]

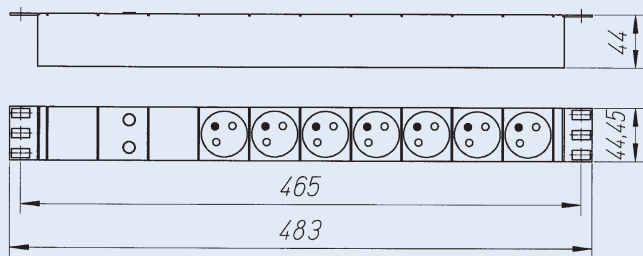

SCHUKO

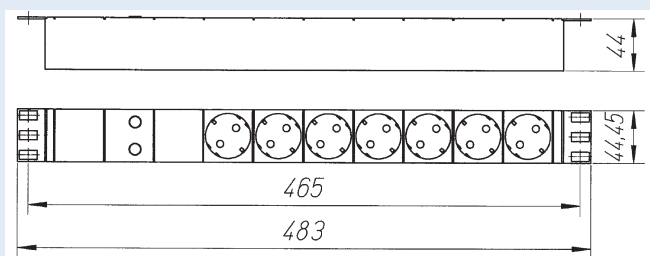

Insertion loss

Asymmetrical

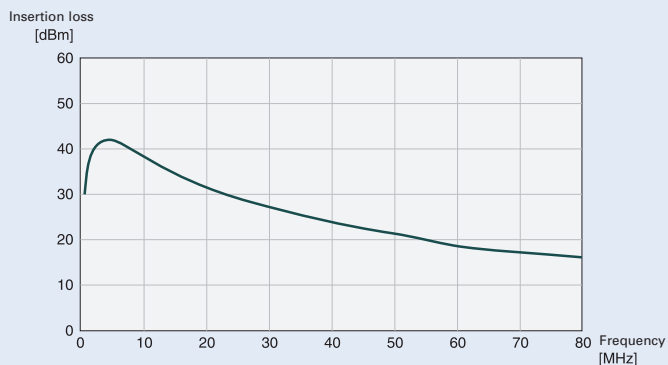

Symmetrical

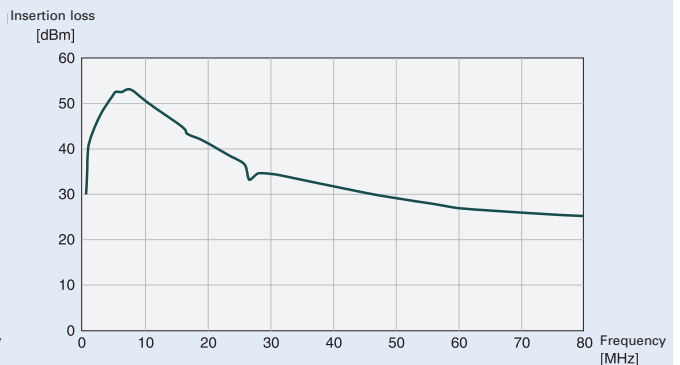

Connection diagram

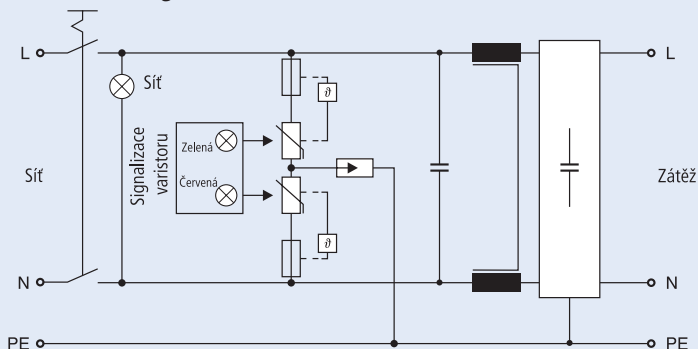

For types and art. numbers see page 103

Surge Protective Device SP-MS/SAT for Receiving Facilities

- Field of application:
Protection of antenna distributors/multi-switches against lightning
- Suitable for analog or digital satellite receiving facilities as well as for terrestrial TV and radio antennas
- Protects 5 separate channels of your choice
- Tested to EN 61643-21

Technical Data

SP-MS/SAT		
Electrical		
IEC test class		B2 / C1 / C2 / C3 / D1
Responding time t_a	centre - shield	≤ 1 ns
Measured limiting voltage at 1 kV/ s spike	centre - shield	2.5 kA
Max. continuous operating voltage U_c	centre - shield	20 VDC
Frequency range		47 MHz ... 2200 MHz
Rated current		400 mA
Continuous operating current I_c at U_c		≤ 2 μ A
Nominal discharge current I_n (8/20) μ s	centre - shield	2.5 kA
Max. discharge current I_{max} (8/20) μ s	centre - shield	5 kA
Impulse current I_{imp} (10/350) μ s		500 A
Impulse durability according to EN 61643-21	centre - shield	C2 (4 kV / 2 kA)
	centre - shield	D1 (500 A)
	centre - shield	C3 (100 A)
	centre - shield	B2 (4 kV / 100 A)
	centre - shield	C3 (1 kV / 500 A)
Resistance per path		3.3 Ω (in DC-path)
Insertion loss up to 2.4 GHz		≤ 2 dB
Overvoltage category		II
Mechanical		
Dimensions		139 x 73 x 34 mm
Weight		269 g
Mounting		Surface-mounting
Degree of protection according to IEC 60529		IP40
Connection of TV-SAT	5 x IN	F-Connector jack
	5 x OUT	F-Connector jack
Equipotential bonding		Screw connection M3
Ambient temperature for operation/storage/transport		-40 °C to +80 °C
Pollution degree		2

Dimensions [mm]

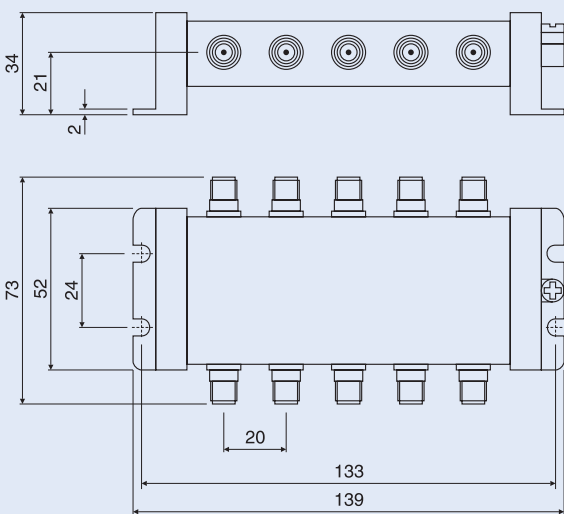

Connection diagram

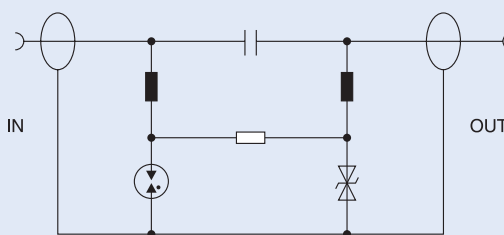

Example of application

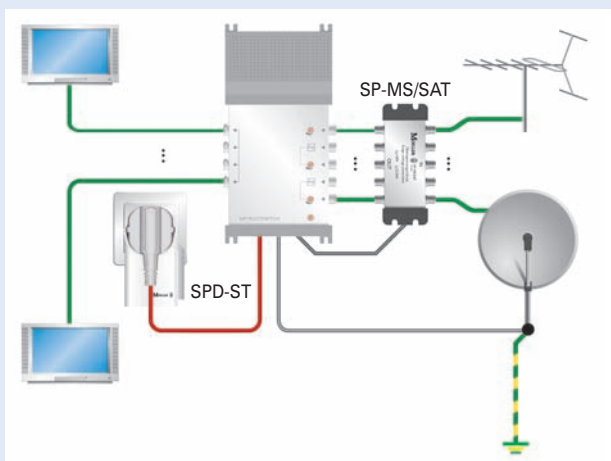

Practical Hint

SP-MS/SAT surge protective device is defect - no TV-signal.

For types and art. numbers see page 103

SPD Class T2 (II, C) for photovoltaic applications for earthed systems SPPT2PA-...-2PE

- Utilization:
For protection of photovoltaic systems against transient overvoltage caused by indirect lightning strokes and switching processes
- Test class II according to EN 61643-11
- SPD-type T2 according to EN 61643-11
- Version SPPT2PA-...-AX with signalisation contact of malfunction of an insert

Connection diagram

SPPT2PA-...-2PE

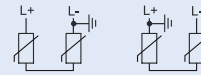

Technical Data

	SPPT2PA-600-2PE	SPPT2PA-1000-2PE(-AX)
Electrical		
Responding time	≤ 25 ns	≤ 25 ns
Maximum continuous operating voltage U_c	600 V DC	1000 V DC
Rated frequency	DC	DC
Nominal discharge current (8/20) μs I_n	15 kA (8/20) μs	15 kA (8/20) μs
Protection level U_p at I_n	≤ 3 kV	≤ 5 kV
Protection level at 5 kA (8/20) μs	≤ 2.5 kV	≤ 4 kV
Maximum discharge current I_{max}	30 kA (8/20) μs	30 kA (8/20) μs
Max. back-up fuse	–	–
Max. short circuit current I_{sc}	80 A	80 A
Residual current I_{PE}	≤ 20 A	≤ 20 A
Mechanical		
Frame size	45 mm	45 mm
Device height	90 mm	90 mm (99 mm)
Device width	35.6 mm	35.6 mm
Weight	247 g	247 g (249 g)
Terminal capacity flexible / rigid	4-25/4-35 mm ² /AWG11-2	4-25/4-35 mm ² /AWG11-2
Tightening torque of terminal	4.5 Nm	4.5 Nm
Permitted ambient temperature	-40 °C to +80 °C	-40 °C to +80 °C
Mounting	quick fastening on DIN rail EN 60715	
Degree of protection	IP20	IP20
Pollution degree	2	2

Auxiliary contact

Electrical:

Rated insulating voltage	250 V
Rated frequency	50/60 Hz
Contact	1 CO
Minimum voltage per contact	5 V AC/DC
Rated operational current	1.5 A / 250 V AC 1.5 A / 30 V DC
Min. allowed energy	5 mA / 5 V

Mechanical:

Cross section of connected conductors stranded / solid	1.5/1.5 mm ² /AWG28-16
Terminal torque	0.25 Nm

Dimensions [mm]

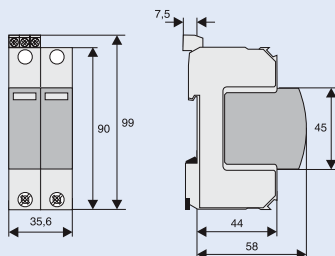

Application notes acc. to EN 50539-12

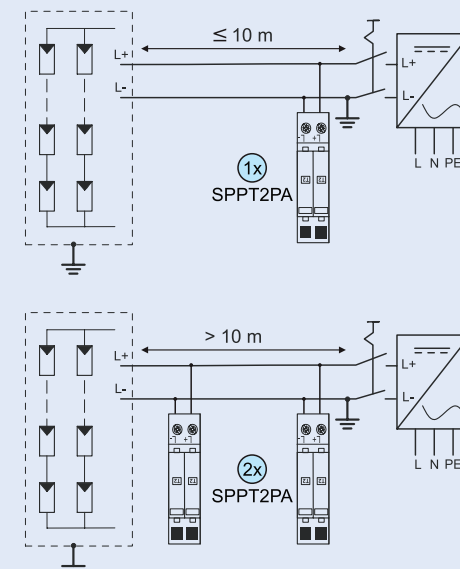

For types and art. numbers see page 104

SPD Class T2 (II, C) for photovoltaic applications for unearthed systems SPPT2PA-...-2+1PE

- Utilization:
For protection of photovoltaic systems against transient overvoltage caused by indirect lightning strokes and switching processes
- Test class **II** according to EN 61643-11
- SPD-type **T2** according to EN 61643-11
- Galvanic separation of unearthed systems by means of spark gap
- Version SPPT2PA-...-AX with signalisation contact of malfunction of an insert

Connection diagram

SPPT2PA-...-2+1PE

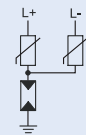

Technical Data

		SPPT2PA-600-2+1PE	SPPT2PA-1000-2+1PE(-AX)
Electrical			
Responding time	L+ -> L- / L- -> PE	≤ 25 ns / ≤ 100 ns	≤ 25 ns / ≤ 100 ns
Maximum continuous operating voltage $U_{c,e}$		600 V DC	1000 V DC
Rated frequency		DC	DC
Rated discharge current I_n for (8/20) μ s		15 kA (8/20) μ s	15 kA (8/20) μ s
Protection level U_p at I_n	L+ -> L- / L- -> PE	≤ 3 kV / ≤ 3 kV	≤ 5 kV / ≤ 3 kV
Protection level at 5 kA (8/20) μ s	L+ -> L- / L- -> PE	≤ 2.5 kV / ≤ 2 kV	≤ 4 kV / ≤ 2 kV
Maximum discharge current I_{max}		30 kA (8/20) μ s	30 kA (8/20) μ s
Max. back-up fuse		-	-
Max. zkratový proud I_{sc}		80 A	80 A
Residual current I_{PE}		≤ 20 A	≤ 20 A
Mechanical			
Frame size		45 mm	45 mm
Device height		90 mm	90 mm (99 mm)
Device width		53.4 mm	53.4 mm
Weight		318 g	318 g (323 g)
Terminal capacity flexible / rigid		4-25/4-35 mm ² /AWG11-2	4-25/4-35 mm ² /AWG11-2
Tightening torque of terminal		4.5 Nm	4.5 Nm
Permitted ambient temperature		-40 °C to +80 °C	-40 °C to +80 °C
Mounting		quick fastening on DIN rail EN 60715	
Degree of protection		IP20	IP20
Pollution degree		2	2

Pomocný kontakt

Electrical:

Rated insulating voltage	250 V
Rated frequency	50/60 Hz
Contact	1 CO
Minimální napětí na kontakt	5 V AC/DC
Jmenovitý pracovní proud	1.5 A / 250 V AC
	1.5 A / 30 V DC
Min. dovolená energie	5 mA / 5 V

Mechanical:

Cross section of connected conductors	
stranded / solid	1.5/1.5 mm ² /AWG28-16
Terminal torque	0.25 Nm

Dimensions [mm]

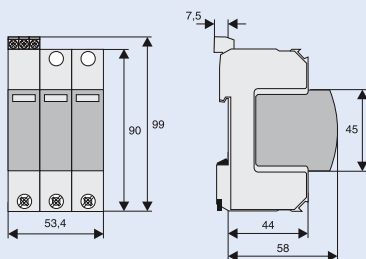

Application notes acc. to EN 50539-12

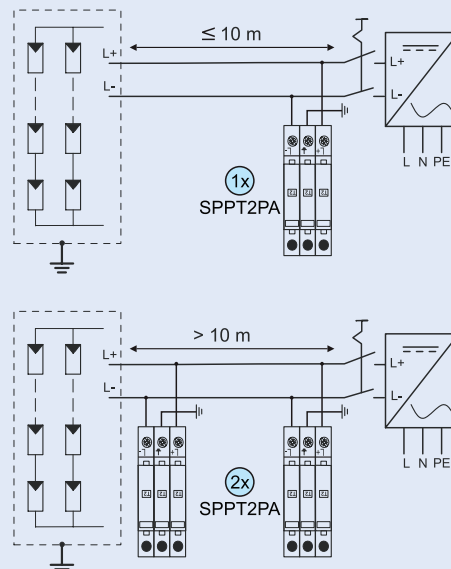

For types and art. numbers see page 104

Earthing / Equipotential Bonding

Equipotential Bonding Bar PAS-7x16

Dimensions [mm]

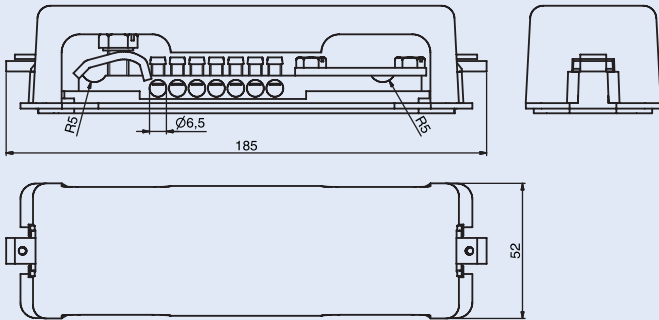

Earthing Bar for Antenna Lines PAS-HF-6

Dimensions [mm]

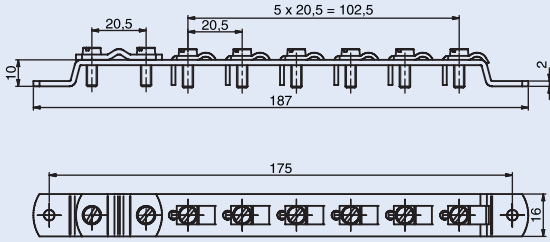

Earth Clip EBS

Dimensions [mm]

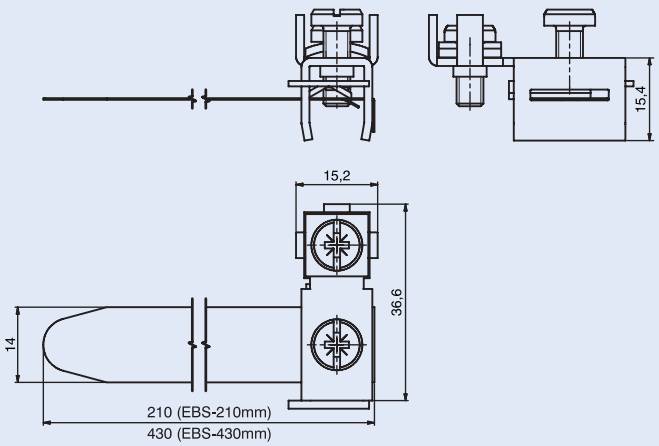

PV-Inverter Grid connected Indoor ISG11

- With three MC3 sockets
- LCD display
- With integrated protection against earth residual current
- Inverters are operated with monitoring software
- Two independent main monitoring units with all-pole disconnecter (ENS) acc. to VDE 0126-1-1

Connection diagram

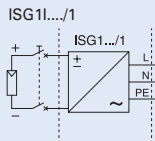

Technical Data

	ISG11-1500/1	ISG11-2000/1	ISG11-2800/1	ISG11-3300/1	ISG11-4000/1
Electrical					
DC					
Max. DC power	1760 W	2320 W	3180 W	3820 W	4630 W
Max. DC voltage	450 VDC	500 VDC	500 VDC	500 VDC	500 VDC
MPP voltage range	150-405 VDC	150-450 VDC	150-450 VDC	150-450 VDC	150-450 VDC
Nominal DC voltage	360 VDC	400 VDC	400 VDC	400 VDC	400 VDC
Max. input current	8.9 ADC	10 ADC	13 ADC	17 ADC	20 ADC
MPP Tracker	1	1	1	1	1
AC					
Output power	1500 W	2000 W	2800 W	3300 W	4000 W
Max. output power	1650 W	2200 W	3000 W	3600 W	4400 W
Operating voltage	190-256 VAC	190-256 VAC	190-256 VAC	190-256 VAC	190-256 VAC
Operating frequency	50 Hz	50 Hz	50 Hz	50 Hz	50 Hz
Current THD	< 3%	< 3%	< 3%	< 3%	< 3%
Power factor	< 1	< 1	< 1	< 1	< 1
Power connection	1-phase	1-phase	1-phase	1-phase	1-phase
SYSTEM					
Max. efficiency	> 95%	> 96%	> 96%	> 96%	> 96%
Euro efficiency	> 94%	> 95%	> 95%	> 95%	> 95%
Stand-by power	≤ 7 W	≤ 7 W	≤ 7 W	≤ 7 W	≤ 7 W
Overvoltage category	III	III	III	III	III
Degree of protection	IP43	IP43	IP43	IP43	IP43
Operating temperature	-20 °C to +55 °C	-20 °C to +55 °C	-20 °C to +55 °C	-20 °C to +55 °C	-20 °C to +55 °C
Humidity (non-condensing)	0-95%	0-95%	0-95%	0-95%	0-95%
Accoustic noise level	< 35 dBA	< 35 dBA	< 35 dBA	< 35 dBA	< 35 dBA
Comm. interface	RS232 (RS485 optional)				
Display	LCD / 1 line, 16 characters				
Mechanical					
W x H x D [mm]	326x270x130	360x303x130	360x303x145	447x389x146	447x389x146
T1 [mm]	340	373	373	459	459
Weight [kg]	9.2	11.5	12.5	16.4	16.4

Dimensions [mm]

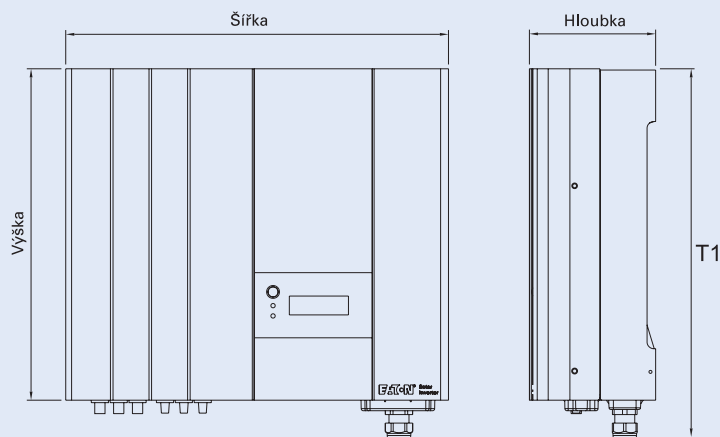

PV-Inverter Grid connected Outdoor ISG.O

- With three MC3 sockets
- LCD display
- With integrated protection against earth residual current
- Inverters are operated with monitoring software
- Two independent main monitoring units with all-pole disconnector (ENS) acc. to VDE 0126-1-1
- Outdoor line with degree of protection IP65, inverter must not be exposed to rain (necessary to place e.g. under a roof)

Connection diagram

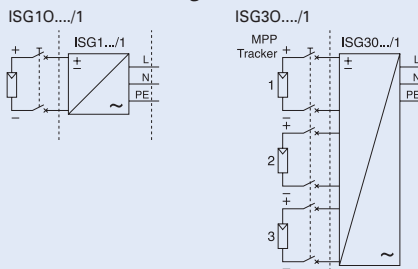

Technical Data

		ISG10-4000/1	ISG30-4600/1
Electrical			
DC	Max. DC power	4630 W	3800 W / tracker
	Max. DC voltage	500 VDC	750 VDC
	MPP voltage range	150-450 VDC	125-700 VDC
	Nominal DC voltage	400 VDC	600 VDC
	Max. input current	20 ADC	8,5 A / tracker
	MPP Tracker	1	3
AC	Output power	4000 W	4600 W
	Max. output power	4400 W	5000 W
	Operating voltage	190-256 VAC	190-256 VAC
	Operating frequency	50 Hz	50 Hz
	Current THD	< 3%	< 3%
	Power factor	< 1	< 1
Power connection		1-phase	1-phase
SYSTEM	Max. efficiency	> 96%	> 96%
	Euro efficiency	> 95%	> 94.5%
	Stand-by power	≤ 7 W	≤ 8 W
	Overvoltage category	III	III
	Degree of protection	IP65	IP65
	Operating temperature	-20 °C to +55 °C	-20 °C to +55 °C
	Humidity (non-condensing)	0-95%	0-95%
	Accoustic noise level	< 35 dBA	< 35 dBA
Comm. interface		RS232 (RS485 optional)	RS232 (RS485 optional)
Display		LCD / 1 line, 16 characters	LCD / 2 lines, 32 characters
Mechanical			
W x H x D [mm]		447x389x146	442x532x134
T1 [mm]		459	602
Weight [kg]		19,5	27

Dimensions [mm]

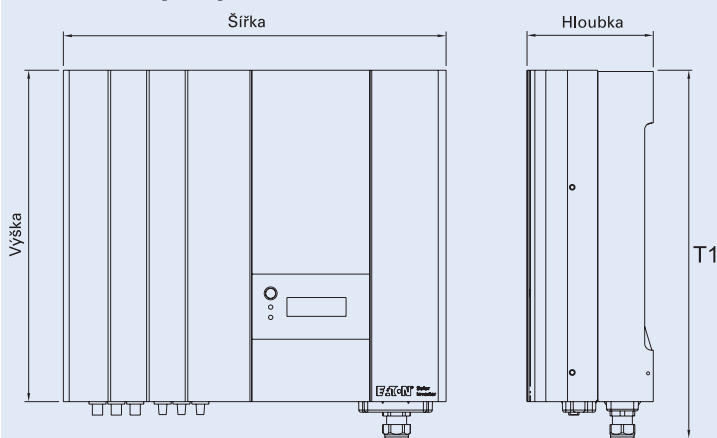

For types and art. numbers see page 106

Power loss

Type designation	P _V [W]	Type designation	P _V [W]	Type designation	P _V [W]	Type designation	P _V [W]
C10-SLS/32/1	3.00	LTS-100/C00/3-R	7.50	NH-1/160	14.10	PF7-40/4/003-A	9.60
C10-SLS/32/1N	3.00	LTS-160/00/1	2.30	NH-1/200	15.80	PF7-40/4/003-G	9.60
C10-SLS/32/2	6.00	LTS-250/1/3	10.00	NH-1/224	17.40	PF7-40/4/01	8.40
C10-SLS/32/3	9.00	LTS-250/1/3-R	28.00	NH-1/250	19.10	PF7-40/4/01-A	8.40
C10-SLS/32/3N	9.00	LTS-400/2/3	20.00	NH-2/35	3.70	PF7-40/4/01-G	8.40
C10-SLS/32/1-L	3.00	LTS-400/2/3-R	53.00	NH-2/50	4.60	PF7-40/4/01-S/A	8.40
C10-SLS/32/1N-L	3.00	LTS-L/160/00	20.00	NH-2/63	5.80	PF7-40/4/01-U	8.40
C10-SLS/32/2-L	6.00	LTS-L/160/00-60-10-R	20.00	NH-2/80	6.40	PF7-40/4/03	8.40
C10-SLS/32/3-L	9.00	LTS-L/400/2	46.00	NH-2/100	8.30	PF7-40/4/03-A	8.40
C10-SLS/32/3N-L	9.00	LTS-L/630/3	92.00	NH-2/125	10.00	PF7-40/4/03-S/A	8.40
D01-SO/16/1	2.50	LZMC1-A20-I	9.80	NH-2/160	12.80	PF7-40/4/03-U	8.40
D01-SO/16/3	7.50	LZMC1-A25-I	8.80	NH-2/200	15.80	PF7-40/4/05	8.40
D02-S/63/3-RS	8.00	LZMC1-A32-I	9.10	NH-2/224	17.40	PF7-63/2/003	9.70
D02-SO/63/1	5.50	LZMC1-A40-I	11.00	NH-2-250	19.10	PF7-63/2/003-A	9.70
D02-SO/63/3	16.50	LZMC1-A50-I	13.50	NH-2-300	20.60	PF7-63/2/01	7.20
dRCM-25/4/003-G/A+	3.30	LZMC1-A63-I	14.00	NH-2/315	21.60	PF7-63/2/01-A	7.20
dRCM-25/4/03-G/A+	3.30	LZMC1-A80-I	15.50	NH-2/355	24.20	PF7-63/2/03	7.20
dRCM-40/4/003-G/A+	10.10	LZMC1-A100-I	24.00	NH-2/400	26.80	PF7-63/2/03-A	7.20
dRCM-40/4/03-G/A+	10.10	LZMC1-A125-I	38.00	NH-3/100	7.70	PF7-63/4/003	13.40
dRCM-63/4/003-G/A+	13.90	LZMC1-A160-I	50.00	NH-3/125	10.80	PF7-63/4/003-A	13.40
dRCM-63/4/03-G/A+	11.00	LZMC2-A160-I	40.00	NH-3/160	12.10	PF7-63/4/003-G	13.40
dRCM-80/4/003-G/A+	11.90	LZMC2-A200-I	48.00	NH-3/200	13.60	PF7-63/4/003-R	13.40
dRCM-80/4/03-G/A+	11.90	LZMC2-A250-I	57.00	NH-3/224	15.40	PF7-63/4/01	10.50
dRCM-63/4/003-R+	13.90	LZMC2-A300-I	83.70	NH-3/250	19.60	PF7-63/4/01-A	10.50
dRCM-40/4/03-S/A+	8.90	LZMN3-A320-I	30.72	NH-3/300	21.20	PF7-63/4/01-G	10.50
dRCM-63/4/03-S/A+	11.00	LZMN3-A400-I	48.00	NH-3/315	22.30	PF7-63/4/01-S/A	10.50
dRCM-80/4/03-S/A+	11.90	LZMN3-A500-I	75.00	NH-3/355	26.50	PF7-63/4/01-U	10.50
dRCM-40/4/003-U+	8.90	LZMN3-AE630-I	119.10	NH-3/400	26.80	PF7-63/4/03	10.50
dRCM-40/4/03-U+	8.90	LZMN4-AE800-I	71.00	NH-3/425	29.00	PF7-63/4/03-A	10.50
dRCM-63/4/003-U+	13.90	LZMN4-AE1000-I	111.00	NH-3/500	37.00	PF7-63/4/03-S/A	10.50
dRCM-63/4/03-U+	13.90	LZMN4-AE1250-I	173.40	NH-3/630	47.00	PF7-63/4/03-U	10.50
dRCM-80/4/03-U+	11.90	LZMN4-AE1600-I	284.20	NH-4a/800	67.00	PF7-63/4/05	10.50
IS-16/1	0.20	mRB6-13/3N/B/003-A	10.20	NH-4a/1000	69.00	PF7-80/4/003	11.40
IS-16/2	0.40	mRB6-13/3N/B/01-A	10.20	NH-4a/1250	84.00	PF7-80/4/003-A	11.40
IS-16/3	0.60	mRB6-13/3N/B/03-A	10.20	NH-4a/1600	106.00	PF7-80/4/01	11.40
IS-16/4	0.80	mRB6-16/3N/B/003-A	9.00	PBHT-80/4/003-A	7.00	PF7-80/4/01-S	11.40
IS-20/1	0.40	mRB6-16/3N/B/01-A	9.00	PBHT-80/4/03-A	7.00	PF7-80/4/03	11.40
IS-20/2	0.70	mRB6-16/3N/B/03-A	9.00	PBHT-80/4/03-S/A	7.00	PF7-80/4/03-A	11.40
IS-20/3	1.10	mRB6-6/3N/C/003-A	5.80	PBHT-80/4/05-A	7.00	PF7-80/4/03-S/A	11.40
IS-20/4	1.40	mRB6-6/3N/C/01-A	5.80	PBHT-80/4/05-S/A	7.00	PF7-80/4/03-U	11.40
IS-25/1	0.50	mRB6-6/3N/C/03-A	5.80	PBHT-80/4/1-A	7.00	PF7-80/4/05	11.40
IS-25/2	0.90	mRB6-10/3N/C/003-A	5.90	PBHT-80/4/1-S/A	7.00	PF7-100/4/003	18.80
IS-25/3	1.40	mRB6-10/3N/C/01-A	5.90	PBHT-125/4/003-A	39.70	PF7-100/4/003-A	18.80
IS-25/4	1.80	mRB6-10/3N/C/03-A	5.90	PBHT-125/4/03-A	39.70	PF7-100/4/003-R	18.80
IS-32/1	0.50	mRB6-13/3N/C/003-A	10.20	PBHT-125/4/03-S/A	39.70	PF7-100/4/01	18.80
IS-32/2	1.00	mRB6-13/3N/C/01-A	10.20	PBHT-125/4/05-A	39.70	PF7-100/4/01-A	18.80
IS-32/3	1.60	mRB6-13/3N/C/03-A	10.20	PBHT-125/4/05-S/A	39.70	PF7-100/4/03	18.80
IS-32/4	2.00	mRB6-16/3N/C/003-A	9.00	PBHT-125/4/1-A	39.70	PF7-100/4/03-A	18.80
IS-40/1	0.70	mRB6-16/3N/C/01-A	9.00	PBHT-125/4/1-S/A	39.70	PF7-100/4/03-S/A	18.80
IS-40/2	1.50	mRB6-16/3N/C/03-A	9.00	PF6-25/2/003	2.00	PF7-100/4/03-U	18.80
IS-40/3	2.20	mRB6-6/3N/D/003-A	5.80	PF6-25/4/003	3.10	PF7-100/4/05	18.80
IS-40/4	2.80	mRB6-6/3N/D/01-A	5.80	PF6-40/2/003	5.80	PF7-100/4/05-A	18.80
IS-63/1	1.80	mRB6-10/3N/D/003-A	5.90	PF6-40/2/03	5.40	PFDm-125/4/003	27.00
IS-63/2	3.50	mRB6-10/3N/D/01-A	5.90	PF6-40/4/003	9.60	PFDm-125/4/003-A	27.00
IS-63/3	5.30	mRB6-13/3N/D/003-A	7.70	PF6-40/4/03	8.40	PFDm-125/4/01	27.00
IS-63/4	7.00	mRB6-13/3N/D/01-A	7.70	PF6-63/4/003	10.50	PFDm-125/4/01-A	27.00
IS-80/1	2.70	mRB6-16/3N/D/003-A	9.00	PF6-63/4/03	10.50	PFDm-125/4/03	27.00
IS-80/2	5.40	mRB6-16/3N/D/01-A	9.00	PF7-16/2/001-A	2.60	PFDm-125/4/03-A	27.00
IS-80/3	8.00	NH-00/6	1.30	PF7-25/2/003	2.00	PFDm-125/4/03-S/A	81.00
IS-80/4	10.80	NH-00/10	1.50	PF7-25/2/003-A	2.00	PFDm-125/4/05	27.00
IS-100/1	4.30	NH-00/16	1.80	PF7-25/2/003-G	1.30	PFDm-125/4/05-A	27.00
IS-100/2	8.60	NH-00/20	1.90	PF7-25/2/01	1.30	PFL7-6/1N/B/003	1.90
IS-100/3	12.90	NH-00/25	2.40	PF7-25/2/01-A	1.30	PFL7-6/1N/B/003-A	1.90
IS-100/4	17.20	NH-00/32	2.90	PF7-25/2/01-G	1.30	PFL7-6/1N/C/003	1.90
IS-125/1	5.50	NH-00/35	3.10	PF7-25/2/03-A	1.30	PFL7-6/1N/C/003-A	1.90
IS-125/2	11.00	NH-00/40	3.60	PF7-25/4/003	3.10	PFL7-10/1N/B/003	2.50
IS-125/3	16.50	NH-00/50	4.20	PF7-25/4/003-A	3.10	PFL7-10/1N/B/003-A	2.50
IS-125/4	22.00	NH-00/63	5.00	PF7-25/4/01	2.80	PFL7-10/1N/C/003	2.50
LN1-63-I	5.91	NH-00/80	5.20	PF7-25/4/01-A	2.80	PFL7-10/1N/C/003-A	2.50
LN1-100-I	14.88	NH-00/100	6.70	PF7-25/4/01-S/A	2.80	PFL7-13/1N/B/003	3.10
LN1-125-I	23.25	NH-00/125	7.80	PF7-25/4/03-A	2.80	PFL7-13/1N/B/003-A	3.10
LN1-160-I	38.10	NH-00/145	8.70	PF7-40/2/003	5.80	PFL7-13/1N/B/003-G	3.10
LN2-160-I	19.66	NH-00/160	9.40	PF7-40/2/003-A	5.80	PFL7-13/1N/C/003	3.10
LN2-200-I	30.72	NH-1/32	3.60	PF7-40/2/003-G	5.80	PFL7-13/1N/C/003-A	3.10
LN2-250-I	48.00	NH-1/35	3.80	PF7-40/2/01	5.40	PFL7-13/1N/C/003-G	3.10
LN3-400-I	48.37	NH-1/40	4.10	PF7-40/2/01-A	5.40	PFL7-16/1N/B/003	3.20
LN3-630-I	120.00	NH-1/50	4.60	PF7-40/2/01-G	5.80	PFL7-16/1N/B/003-A	3.20
LN4-800-I	72.75	NH-1/63	6.20	PF7-40/2/01-S	5.80	PFL7-16/1N/B/003-G	3.20
LN4-1000-I	113.67	NH-1/80	6.40	PF7-40/2/03-A	5.40	PFL7-16/1N/C/003	3.20
LN4-1250-I	177.61	NH-1/100	8.70	PF7-40/2/03-S	5.40	PFL7-16/1N/C/003-A	3.20
LN4-1600-I	291.00	NH-1/125	10.30	PF7-40/4/003	9.60	PFL7-16/1N/C/003-G	3.20

Type designation	P_V [W]	Type designation	P_V [W]	Type designation	P_V [W]	Type designation	P_V [W]
PFL7-20/1N/B/003	4.70	PL7-B4	1.40	PL7-C16/3	6.90	PL7-D32/3N	11.40
PFL7-20/1N/B/003-G	4.70	PL7-B6	1.80	PL7-C16/3N	7.20	PL7-D40	3.20
PFL7-20/1N/C/003	4.70	PL7-B6/1N	2.00	PL7-C20	3.20	PL7-D40/2	7.00
PFL7-20/1N/C/003-G	4.70	PL7-B6/2	3.60	PL7-C20/1N	3.60	PL7-D40/3	10.40
PFL7-25/1N/B/003	4.80	PL7-B6/3	5.50	PL7-C20/2	6.60	PL7-D40/3N	10.70
PFL7-25/1N/B/003-G	4.80	PL7-B6/3N	5.60	PL7-C20/3	9.80		
PFL7-25/1N/C/003	4.80	PL7-B10	1.90	PL7-C20/3N	10.10	PLHT-B20	2.70
PFL7-25/1N/C/003-G	4.80	PL7-B10/1N	2.10	PL7-C25	3.00	PLHT-B20/2	2.70
PFL7-32/1N/B/003	6.60	PL7-B10/2	3.90	PL7-C25/1N	3.50	PLHT-B20/3	2.70
PFL7-32/1N/C/003	6.60	PL7-B10/3	5.90	PL7-C25/2	6.40	PLHT-B20/3N	2.70
PFL7-40/1N/B/003	9.40	PL7-B10/3N	6.10	PL7-C25/3	9.40	PLHT-B25	2.80
PFL7-40/1N/C/003	9.40	PL7-B13	2.50	PL7-C25/3N	9.70	PLHT-B25/2	2.80
PL6-B10	1.90	PL7-B13/1N	2.90	PL7-C32	3.70	PLHT-B25/3	2.80
PL6-B10/2	3.90	PL7-B13/2	5.30	PL7-C32/1N	4.40	PLHT-B25/3N	2.80
PL6-B10/3	5.90	PL7-B13/3	7.80	PL7-C32/2	8.10	PLHT-B32	3.80
PL6-B13	2.50	PL7-B13/3N	8.10	PL7-C32/3	12.10	PLHT-B32/2	3.80
PL6-B13/2	5.30	PL7-B16	2.20	PL7-C32/3N	12.50	PLHT-B32/3	3.80
PL6-B13/3	7.80	PL7-B16/1N	2.60	PL7-C40	3.40	PLHT-B32/3N	3.80
PL6-B16	2.20	PL7-B16/2	4.70	PL7-C40/2	7.50	PLHT-B40	4.40
PL6-B16/2	4.70	PL7-B16/3	6.90	PL7-C40/3	11.20	PLHT-B40/2	4.40
PL6-B16/3	6.90	PL7-B16/3N	7.20	PL7-C40/3N	11.50	PLHT-B40/3	4.40
PL6-B2	1.40	PL7-B20	3.20	PL7-C50	4.50	PLHT-B40/3N	4.40
PL6-B2/2	2.80	PL7-B20/1N	3.60	PL7-C50/2	9.90	PLHT-B50	5.10
PL6-B2/3	4.10	PL7-B20/2	6.60	PL7-C50/3	14.90	PLHT-B50/2	5.10
PL6-B20	3.20	PL7-B20/3	9.80	PL7-C50/3N	15.30	PLHT-B50/3	5.10
PL6-B20/2	6.60	PL7-B20/3N	10.10	PL7-C63	5.20	PLHT-B50/3N	5.10
PL6-B20/3	9.80	PL7-B25	3.00	PL7-C63/2	11.50	PLHT-B63	5.20
PL6-B25	3.00	PL7-B25/1N	3.50	PL7-C63/3	17.20	PLHT-B63/2	5.20
PL6-B25/2	6.40	PL7-B25/2	6.40	PL7-C63/3N	17.70	PLHT-B63/3	5.20
PL6-B25/3	9.40	PL7-B25/3	9.40	PL7-C1/1-DC	1.50	PLHT-B63/3N	5.20
PL6-B32	3.70	PL7-B25/3N	9.70	PL7-C2/1-DC	1.40	PLHT-B80	7.10
PL6-B32/2	8.10	PL7-B32	3.70	PL7-C3/1-DC	1.50	PLHT-B80/2	7.10
PL6-B32/3	12.10	PL7-B32/1N	4.40	PL7-C4/1-DC	1.50	PLHT-B80/3	7.10
PL6-B4	1.40	PL7-B32/2	8.10	PL7-C6/1-DC	1.50	PLHT-B80/3N	7.10
PL6-B4/2	2.90	PL7-B32/3	12.10	PL7-C10/1-DC	1.50	PLHT-B100	9.10
PL6-B4/3	4.40	PL7-B32/3N	12.50	PL7-C13/1-DC	2.50	PLHT-B100/2	9.10
PL6-B40	3.40	PL7-B40	3.40	PL7-C16/1-DC	2.20	PLHT-B100/3	9.10
PL6-B40/2	7.50	PL7-B40/2	7.50	PL7-C20/1-DC	3.20	PLHT-B100/3N	9.10
PL6-B40/3	11.20	PL7-B40/3	11.20	PL7-C25/1-DC	3.00	PLHT-B125	11.90
PL6-B50	4.50	PL7-B40/3N	11.50	PL7-C32/1-DC	3.70	PLHT-B125/2	11.90
PL6-B50/2	9.90	PL7-B50	4.50	PL7-C40/1-DC	3.40	PLHT-B125/3	11.90
PL6-B50/3	14.90	PL7-B50/2	9.90	PL7-C50/1-DC	4.50	PLHT-B125/3N	11.90
PL6-B6	1.80	PL7-B50/3	14.90	PL7-C1/2-DC	3.00	PLHT-C20	2.71
PL6-B6/2	3.60	PL7-B50/3N	15.30	PL7-C2/2-DC	2.80	PLHT-C20/2	5.42
PL6-B6/3	5.50	PL7-B63	5.20	PL7-C3/2-DC	3.00	PLHT-C20/3	16.30
PL6-B63	5.20	PL7-B63/2	11.50	PL7-C4/2-DC	2.90	PLHT-C20/3N	18.40
PL6-B63/2	11.50	PL7-B63/3	17.20	PL7-C6/2-DC	2.90	PLHT-C25	2.78
PL6-B63/3	17.20	PL7-B63/3N	17.70	PL7-C10/2-DC	3.00	PLHT-C25/2	5.56
PL6-C2	1.40	PL7-C0,16	2.20	PL7-C13/2-DC	5.30	PLHT-C25/3	8.34
PL6-C2/2	2.80	PL7-C0,25	2.00	PL7-C16/2-DC	4.70	PLHT-C25/3N	8.62
PL6-C4	1.40	PL7-C0,5	1.20	PL7-C20/2-DC	6.60	PLHT-C32	3.79
PL6-C4/2	2.90	PL7-C0,5/2	2.40	PL7-C25/2-DC	6.40	PLHT-C32/2	7.58
PL6-C4/3	4.40	PL7-C0,5/3	3.50	PL7-C32/2-DC	8.10	PLHT-C32/3	11.40
PL6-C6	1.50	PL7-C0,75	1.30	PL7-C40/2-DC	7.50	PLHT-C32/3N	11.75
PL6-C6/2	2.90	PL7-C1	1.60	PL7-C50/2-DC	9.90	PLHT-C40	4.42
PL6-C6/3	4.40	PL7-C1,6	1.60	PL7-D2	1.00	PLHT-C40/2	8.84
PL6-C10	1.50	PL7-C1/2	3.10	PL7-D4	1.40	PLHT-C40/3	13.30
PL6-C10/2	3.00	PL7-C1/3	4.70	PL7-D6	1.50	PLHT-C40/3N	13.70
PL6-C10/3	4.60	PL7-C2	1.40	PL7-D6/2	2.90	PLHT-C50	5.14
PL6-C13	2.50	PL7-C2/1N	1.50	PL7-D6/3	4.40	PLHT-C50/2	10.30
PL6-C13/2	5.30	PL7-C2/2	2.80	PL7-D6/3N	4.60	PLHT-C50/3	15.40
PL6-C13/3	7.80	PL7-C2/3	4.10	PL7-D10	1.50	PLHT-C50/3N	15.93
PL6-C16	2.20	PL7-C4	1.40	PL7-D10/2	3.00	PLHT-C63	5.20
PL6-C16/2	4.70	PL7-C4/1N	1.60	PL7-D10/3	4.60	PLHT-C63/2	10.40
PL6-C16/3	6.90	PL7-C4/2	2.90	PL7-D10/3N	4.70	PLHT-C63/3	15.60
PL6-C20	3.20	PL7-C4/3	4.40	PL7-D13	1.90	PLHT-C63/3N	16.12
PL6-C20/2	6.60	PL7-C6	1.50	PL7-D13/2	4.00	PLHT-C80	7.14
PL6-C20/3	9.80	PL7-C6/1N	1.60	PL7-D13/3	5.90	PLHT-C80/2	14.30
PL6-C25	3.00	PL7-C6/2	2.90	PL7-D13/3N	6.10	PLHT-C80/3	21.40
PL6-C25/2	6.40	PL7-C6/3	4.40	PL7-D16	2.20	PLHT-C80/3N	22.13
PL6-C25/3	9.40	PL7-C6/3N	4.60	PL7-D16/2	4.70	PLHT-C100	9.13
PL6-C32	3.70	PL7-C10	1.50	PL7-D16/3	6.90	PLHT-C100/2	18.30
PL6-C32/2	8.10	PL7-C10/1N	1.70	PL7-D16/3N	7.20	PLHT-C100/3	27.40
PL6-C32/3	8.10	PL7-C10/2	3.00	PL7-D20	2.00	PLHT-C100/3N	28.30
PL6-C40	3.40	PL7-C10/3	4.60	PL7-D20/2	4.10	PLHT-C125	11.89
PL6-C40/2	7.50	PL7-C10/3N	4.70	PL7-D20/3	6.10	PLHT-C125/2	23.80
PL6-C40/3	11.20	PL7-C13	2.50	PL7-D20/3N	6.20	PLHT-C125/3	35.67
PL6-C50	4.50	PL7-C13/1N	2.90	PL7-D25	2.50	PLHT-C125/3N	36.86
PL6-C50/2	9.90	PL7-C13/2	5.30	PL7-D25/2	5.20	PLHT-D20	2.70
PL6-C50/3	14.90	PL7-C13/3	7.80	PL7-D25/3	7.70	PLHT-D20/2	2.70
PL6-C63	5.20	PL7-C13/3N	8.10	PL7-D25/3N	7.90	PLHT-D20/3	2.70
PL6-C63/2	11.50	PL7-C16	2.20	PL7-D32	3.40	PLHT-D20/3N	2.70
PL6-C63/3	17.20	PL7-C16/1N	2.60	PL7-D32/2	7.40	PLHT-D25	2.80
PL7-B2	1.40	PL7-C16/2	4.70	PL7-D32/3	11.10	PLHT-D25/2	2.80

Type designation	P _V [W]	Type designation	P _V [W]	Type designation	P _V [W]
PLHT-D25/3	2.80	Z-RK230/S	4.47	Z-SLS/B-25A	1.40
PLHT-D25/3N	2.80	Z-RK230/SO	4.47	Z-SLS/B-2A	1.20
PLHT-D32	3.80	Z-RK230/SS	6.47	Z-SLS/B-32A	2.40
PLHT-D32/2	3.80	Z-RK24/SO	4.15	Z-SLS/B-35A	2.80
PLHT-D32/3	3.80	Z-RK24/SS	6.15	Z-SLS/B-40A	3.70
PLHT-D32/3N	3.80	Z-S/2WE	1.17	Z-SLS/B-4A	1.20
PLHT-D40	4.40	Z-S/2WM	1.44	Z-SLS/B-50A	4.00
PLHT-D40/2	4.40	Z-S/3S	2.16	Z-SLS/B-63A	5.00
PLHT-D40/3	4.40	Z-S/3S10	2.53	Z-SLS/B-6A	1.20
PLHT-D40/3N	4.40	Z-S/4S	2.35	Z-SLS/CB/1	7.50
PLHT-D50	5.10	Z-S/SSOO	1.17	Z-SLS/CB/2	15.00
PLHT-D50/2	5.10	Z-S/WM	0.72	Z-SLS/CB/3	22.50
PLHT-D50/3	5.10	Z-S12/SS	3.00	Z-SLS/CEK10/1	1.60
PLHT-D50/3N	5.10	Z-S230/2S2O	3.00	Z-SLS/CEK10/1-SP	1.60
PLHT-D63	5.20	Z-S230/S	1.50	Z-SLS/CEK16/1	2.20
PLHT-D63/2	10.40	Z-S230/SO	1.50	Z-SLS/CEK16/1-SP	2.20
PLHT-D63/3	15.60	Z-S230/SS	3.00	Z-SLS/CEK16/3	6.60
PLHT-D63/3N	16.12	Z-S230/W	1.50	Z-SLS/CEK16/3-SP	6.60
PLHT-D80	7.10	Z-S230/WW	3.00	Z-SLS/CEK25/1	2.90
PLHT-D80/2	14.30	Z-S24/2S2O	3.00	Z-SLS/CEK25/1-SP	2.90
PLHT-D80/3	21.40	Z-S24/S	1.50	Z-SLS/CEK25/3	8.70
PLHT-D80/3N	22.11	Z-S24/SO	3.00	Z-SLS/CEK25/3-SP	8.70
PLHT-D100	9.10	Z-S24/SS	3.00	Z-SLS/CEK35/3	9.90
PLHT-D100/2	18.30	Z-S24/W	1.50	Z-SLS/CEK35/3-SP	9.90
PLHT-D100/3	27.40	Z-S24/WW	3.00	Z-SLS/CEK50/3	13.50
PLHT-D100/3N	28.29	Z-S32/3S	4.48	Z-SLS/CEK50/3-SP	13.50
SP-B+C/3	0.45	Z-S32/4S	6.21	Z-SLS/CEK63/3	16.50
SP-B+C/3+1	0.45	Z-S32/S	1.44	Z-SLS/CEK63/3-SP	16.50
SPB-1+1	0.22	Z-S32/SS	2.88	Z-SLS/D01/1	0.70
SPB-12/280	0.22	Z-S48/2S2O	3.00	Z-SLS/D01/1+N	1.20
SPB-12/280/2	0.44	Z-S48/S	1.50	Z-SLS/D01/2	1.40
SPB-12/280/3	0.66	Z-S48/SO	1.50	Z-SLS/D01/3	2.10
SPB-12/280/4	0.88	Z-S48/SS	3.00	Z-SLS/D01/3+N	2.60
SPB-3+1	0.66	Z-S48/W	1.50	Z-SLS/E-10A	1.10
SPC-E-280	0.10	Z-S48/WW	3.00	Z-SLS/E-13A	1.90
SPC-S-15/75	0.02	Z-SB23/SS	3.05	Z-SLS/E-16A	1.70
SPC-S-20/130	0.08	Z-SB230/SS	3.37	Z-SLS/E-20A	1.80
SPC-S-20/130/1	0.08	Z-SB24/SS	3.05	Z-SLS/E-25A	2.40
SPC-S-20/175	0.07	Z-SC230/1S1W	3.00	Z-SLS/E-2A	1.20
SPC-S-20/175/1	0.07	Z-SC230/2S1O	3.00	Z-SLS/E-32A	2.40
SPC-S-20/175/2	0.13	Z-SC230/3S	4.50	Z-SLS/E-35A	2.80
SPC-S-20/280	0.11	Z-SC230/S	1.50	Z-SLS/E-40A	3.70
SPC-S-20/280/1	0.10	Z-SC24/S	1.50	Z-SLS/E-4A	1.20
SPC-S-20/280/2	0.20	Z-SCH230/25-04	8.00	Z-SLS/E-50A	4.00
SPC-S-20/280/3	0.30	Z-SCH230/25-22	6.50	Z-SLS/E-63A	5.00
SPC-S-20/280/4	0.40	Z-SCH230/25-31	8.50	Z-SLS/E-6A	1.20
SPC-S-20/335	0.10	Z-SCH230/25-40	10.50	Z-SLS/NEOZ/1	0.50
SPC-S-20/335/1	0.10	Z-SCH230/40-20	8.60	Z-SLS/NEOZ/1+N	1.00
SPC-S-20/335/2	0.21	Z-SCH230/40-22	8.60	Z-SLS/NEOZ/2	1.00
SPC-S-20/335/3	0.31	Z-SCH230/40-31	11.60	Z-SLS/NEOZ/3	1.50
SPC-S-20/335/4	0.41	Z-SCH230/40-40	14.60	Z-SLS/NEOZ/3+N	2.00
SPC-S-20/385	0.13	Z-SCH230/63-20	16.60	Z-SLS/TR-SET	1.00
SPC-S-20/385/1	0.13	Z-SCH230/63-22	16.60	Z-SUM12	5.00
SPC-S-20/385/2	0.27	Z-SCH230/63-31	23.60	Z-SUM230	10.00
SPC-S-20/385/3	0.40	Z-SCH230/63-40	30.60	Z-SUM24	7.00
SPC-S-20/385/4	0.54	Z-SCH24/25-22	6.50	Z-SW/S	1.50
SPC-S-20/460	0.15	Z-SCH24/25-40	10.50	Z-SW/SO	1.50
SPC-S-20/460/1	0.15	Z-SDM/1K-TA	0.90	Z-SW/SS	3.00
SPC-S-20/460/2	0.30	Z-SDM/1K-WO	0.90	Z-SW/W	1.50
SPC-S-20/460/3	0.45	Z-SDM/2K-WO	0.90	Z-SWL230/S	2.08
SPC-S-20/460/4	0.60	Z-SLK/NEOZ/1	0.50	Z-SWL230/SO	2.08
SPC-S-20/580	0.18	Z-SLK/NEOZ/1+N	1.00	Z-SWL230/SS	3.58
SPC-S-20/580/1	0.18	Z-SLK/NEOZ/2	1.00	Z-SWL24/SO	1.62
SPD-S-1+1	0.10	Z-SLK/NEOZ/3	1.50	Z-SWL24/SS	3.12
SPD-S-280	0.10	Z-SLK/NEOZ/3+N	2.00	Z-TN230/1S1O	4.10
SPD-S-280/2	0.20	Z-SLS/B/24-10A	1.10	Z-TN230/3S	10.20
SPD-S-L/N	0.10	Z-SLS/B/24-13A	1.90	Z-TN230/4S	12.20
SPD-STC	0.50	Z-SLS/B/24-16A	1.70	Z-TN230/SS	6.10
SPD-STC/ISDN	0.90	Z-SLS/B/24-1A	1.20	Z-TN24/1S1O	4.10
SPD-STC/TV-SAT	0.90	Z-SLS/B/24-20A	1.80	Z-TN24/3S	10.20
SPI-100/NPE	0.10	Z-SLS/B/24-25A	2.40	Z-TN24/4S	12.20
SPI-35/440	0.06	Z-SLS/B/24-2A	1.20	Z-TN24/SS	6.10
SPI-50/NPE	0.06	Z-SLS/B/24-32A	2.40	Z-UDL230	1.15
TLE	1.00	Z-SLS/B/24-35A	2.80	Z-UDL24	0.24
TLK	1.00	Z-SLS/B/24-40A	3.70	Z-UEL230	0.58
TR-G/8	7.10	Z-SLS/B/24-4A	1.20	Z-UEL24	0.12
TR-G2/24	11.90	Z-SLS/B/24-50A	4.00	Z-UR/400	4.00
TR-G2/24-SF	10.40	Z-SLS/B/24-63A	5.00	Z-USA/115	3.30
TR-G2/24-SF2	6.30	Z-SLS/B/24-6A	1.20	Z-USA/230	3.10
TR-G2/63-SF	19.60	Z-SLS/B-10A	1.10	Z-USA/400	4.40
TR-G3/18	11.60	Z-SLS/B-13A	1.90	ZRER/W	1.00
TR-G3/8	6.20	Z-SLS/B-16A	1.70	ZRMF1/W	1.00
Z-RE24/SS	6.15	Z-SLS/B-1A	1.20	ZRMF2/WW	1.30
Z-RK23/2S2O	10.25	Z-SLS/B-20A	1.80	ZRTAK/W	1.00

Type	Business information page	Technical data page	Type	Business information page	Technical data page	Type	Business information page	Technical data page
B								
BSZ	64	212	NZMN2-VED	93		Z-C10/SE..PV	78	235
C			NZMN3-VED	94		Z-C14/SE	76	229
C10-SLS/32	77	234	NZMN4-VED	95		Z-C22/SE	76	229
D			NZM-XMC	62	208	Z-CC/2CO	50	167
D IV	74	224	P			Z-D01/PE	79	238
D01-SO/16	80	239	PAS	104	296	Z-D01/SE	79	238
D02-LTS/63	81	242	PBHT	22	125	Z-D01/SK	80	238
D02-LTS/63	84	249	PDIM	20	124	Z-D02/PE	79	238
D02-S/63/3-RS	81	241	PF6	18	122	Z-D02/R/3-36	80	240
D02-SO/63	80	239	PF7	6	113	Z-D02/R/3-54	80	240
D02-SO/63/3-R-27	80	240	PFDI	16	121	Z-D02/SE	79	238
DIII-SO/63	75	227	PFL6	28	132	Z-D02/SIKA-HF	80	
DII-SO/25	75	227	PFL7	24	128	Z-D02/SK	80	238
dRCM	10	115	PFR2-03	12	117	Z-D02-D01/PE	79	238
DS-T	56	183	PFR3-03	12	117	Z-D02-LTS-HF	81	
E			PHF7	14	119	Z-D02-S-AB-SET	80	
EBS	104	296	PL6	38	144	Z-D0-PE-Z	79	
EVG	71	223	PL7	32	137	Z-D63	47	156
F			PL7-B4...-HS	47	157	Z-D80	47	156
FCFDC10DI...-SOL	78	236	PL7-C...-DC	36	137	Z-DII/PE	74	226
FFS/16	50	169	PLHT	42	150	Z-DII/PS	74	226
G			R			Z-DII/SE	74	224
GR	66		REHLVA	58	197	Z-DII/SK	75	226
I			RELLVA	58	197	Z-DIII/PE	74	226
IS	46	155	REMLVA	58	197	Z-DIII/PS	74	226
IS/SPE-1TE	46		S			Z-DIII/SE	74	224
ISG	106	297	SA-TD/1W	59	198	Z-DIII/SK	75	226
ISO	66	217	SBS-RS60	75		Z-DLD	52	172
K			SPB	99	280	Z-DS	54	174
KLV-LV	66		SP-B+C	99	281	Z-DS/S	56	185
KLV-TC	66	217	SPB-D-125	98	277	Z-DST	55	
KWZ-230	61	204	SPB-HK-W	99		Z-DST	58	
KWZ-3PH	61	205	SPC-E	100	282	Z-EK	70	
KWZ-3PH-63	61	205	SPC-S	100	283	Z-EL	52	172
KWZ-3PH-D63	61	207	SPC-S-HK	99		Z-FAM	49	164
KWZ-3PHD-D63	61	207	SPC-S-HK	100		Z-FW/0..	50	168
KWZ-3PHD-I5	61	207	SPD-S	102	287	Z-FW-LP	50	165
KWZ-3PH-I5	61	207	SPD-STC	102	289	Z-FW-MO	50	165
KWZ-SCOV	61		SPD-STC/ISDN	102	290	Z-GLO	64	212
L			SPD-STC/TV-SAT	102	291	Z-GSV	68	220
LN1	92	273	SPD-STL/19/7F-S/BL/UTE102	292		Z-GV	68	219
LN2	93	273	SPI	98	276	Z-GV-U	98	277
LN3	94	273	SP-MS/SAT	102	293	Z-HA-EK/35	48	
LN4	95	273	SPPT2PA	104	294	Z-HD	16	121
LTS	86	253	SU-TQ	59	199	Z-HD	47	158
LTS-L	88	266	SU-TS	59	199	Z-HK	47	121
LZMC1	92	273	T			Z-HWS-FI	8	
LZMC2	93	273	TLE	56	182	Z-IMZ	64	212
LZMN3	94	273	TLK	56	182	Z-IS/AK-1TE	46	
LZMN4	95	273	TR-G	56	187	Z-KAM	49	164
M			V			Z-LAR	51	171
MAK	63	210	VDK280ES	102	288	Z-LHASA/24	44	154
mRB6	30	136	VLC14	77	234	Z-LHK	44	154
N			VLC22	77	234	Z-LTS	87	265
NH	85	250	Z			Z-LTS....-SAD/100-KR	86	264
NZM2-4-XMC	62	208	Z7-MG/WS	60		ZLTS-M/DOHD	89	
NZM2-XMC	62	208	Z7-SDM/AK-2TE	59		ZLTS-M/KH	89	
NZM3-4-XMC	62	208	Z7-SDM/MP-2TE	59		ZLTS-M3/W	89	
NZM3-XMC	62	208	Z-AHK	47	158	ZLTS-MO/SW	89	
			Z-AK	68	219	Z-MFG	65	216
			Z-BEL	52	172	Z-MFPA	51	170
			Z-BHASA	22	127	Z-MG	60	201
			Z-BOX	66		Z-MG/WAK	60	203
			Z-C10/SE	76	229	Z-MG/WAS	60	203
						Z-MS	65	213
						Z-NH	86	
						Z-NH-AE	89	
						Z-NHK	47	158
						Z-NKA-SCH	50	169
						ZP-A	46	158

Type	Business information page	Technical data page
ZP-ASA	48	161
ZP-IHK	48	160
ZP-NHK	48	160
Z-PU	52	172
Z-PUL	52	172
ZP-WHK	48	160
ZR	54	177
Z-R	57	189
Z-RC/230	58	
Z-RC/AK	8	
Z-RE	57	189
Z-RK	57	189
Z-S	55	179
Z-S/	53	173
Z-S/KO	55	180
Z-SB	55	179
Z-SC	58	191
Z-SC..	55	180
Z-SC/GP	55	180
Z-SD230	51	170
Z-SDM	59	200
Z-SCH	58	191
Z-SCHAK	58	
Z-SLK/D0	82	246
Z-SLK/NEOZ	82	246
Z-SLS/B	83	247
Z-SLS/CB	84	248
Z-SLS/CEK	82	245
Z-SLS/D01	81	243
Z-SLS/E	83	247
Z-SLS/NEOZ	82	244
Z-SLS/TR-SET	83	
Z-SLZ	84	
Z-SUM	64	212
Z-SV	68	221
Z-SW	53	172
Z-SWL	53	172
Z-T	53	173
Z-TN	57	189
Z-TR/AP	56	
Z-UDL	52	172
Z-UEL	52	172
Z-UR/400	49	163
Z-USA	49	162
Z-USD	49	162
ZV-ADP	68	218
ZV-AEK	68	218
Z-V-AK	68	219
ZV-BS-G	68	
ZV-KSBI	101	286
ZV-L1/N-10	68	218
ZV-L1/N-80A-10	68	218
ZV-L2/L3-10	68	218
ZV-L2/L3-80A-10	68	218
ZV-N-05TE-10	68	218
ZV-SS	68	218
ZV-SS-80A	68	218
Z-WFR 2	12	117
Z-WFR 3	12	117

Eaton's electrical business is a global leader in electrical control, power distribution, uninterruptible power supply and industrial automation products and services.

Eaton's global electrical brands, including Cutler-Hammer®, MGE Office Protection Systems™, Powerware®, Holec®, MEM®, Santak and Moeller, provide customer-driven PowerChain Management® solutions to serve the power system needs of the industrial, institutional, government, utility, commercial, residential, IT, mission critical and OEM markets worldwide.

www.eaton.com

Eaton Elektrotechnika s.r.o.

Komárovská 2406
CZ-193 00 Praha, Czech republic
Tel.: +420 267 990 481
Fax: +420 267 990 489

ExportCZ@eaton.com
www.eaton.com
www.EatonElektrotechnika.cz

© 2010 by Eaton Elektrotechnika s.r.o.
All rights reserved
KAT BA-P-2010 GB Ex/Ak (11/10)
Art. number: 999 200 409
Valid from 10/2010



Powering Business Worldwide



X-ON Electronics

Largest Supplier of Electrical and Electronic Components

Click to view similar products for [Circuit Breaker Accessories](#) category:

Click to view products by [Eaton](#) manufacturer:

Other Similar products are found below :

[CSC-403PS](#) [8T1-D-11A](#) [B151-7184-L](#) [NEB10](#) [8C1-C-721](#) [8T1-E-115](#) [8T1-E-275](#) [8T1-E-278](#) [4-1393247-8](#) [4-1393247-9](#) [506-11315-001](#)
[3803221](#) [3803231](#) [NEB6](#) [X10506BF](#) [NES](#) [9-1393249-0](#) [802-ESB50UL489](#) [3RV2011-1CA15](#) [607.5689.127](#) [30.329](#) [CA707/TS/01](#)
[11-32-2733](#) [X10508BF](#) [X22261102](#) [975090700](#) [CX2.5/4/O](#) [975090701](#) [PS-2P](#) [Y30019003](#) [C-TEC1225 P](#) [PS-1006](#) [618.6335.069](#)
[975455700](#) [BAC03](#) [930727103](#) [934097101](#) [ZG20-1](#) [934097100](#) [JX2.5/4](#) [KEM380CUL](#) [CC848756916](#) [JX2.5/6](#) [JX2.5/5](#) [HSP6/10U](#)
[DMRBU BLACK BOX](#) [DB16/BU](#) [DB16/BL](#) [CM2.5S2](#) [973604100](#)