

# Manual Motor Protectors, Motor Protectors with Contactor Motor Starter Combinations

<b>System PKZ 0- Motor Protector</b>	Overview	7/2
	Manual Motor Protector Motor Protector for high inrush loads Motor Protector Combinations with Contactor NEC Group Motor Application Ratings	7/6  7/8
	Auxiliary Contacts Voltage Trips (High Capacity) Magnetic Contactors + Accessories	7/10 7/11 7/12
	Enclosures, Housings Handles, Accessories Wiring accessories: Feeder Connectors Bus Bar Adapters Mounting & Wiring System <b>MVS</b>	7/14 7/15 7/16 7/17 7/18
<b>System PKZ 2- Motor Protector</b>	Overview	7/20
	Manual Motor Protector Motor Protector Combinations with Contactor NEC Group Motor Application Ratings Motor Protector without Protective Trip Module Protective Trip Module	7/24  7/25 7/26
	Auxiliary Contacts Voltage Trips Remote Control Drives High Capacity Magnetic Contactors + Accessories	7/28 7/29 7/30 7/32
	Enclosures, Housings Handles, Accessories Wiring accessories: Feeder Connectors Bus Bar Adapters	7/36 7/37 7/37 7/38
	System <b>PKZ 0-</b> Motor Protector Coil Voltage Ratings System <b>PKZ 2-</b> Motor Protector Coil Voltage Ratings	7/39 7/40
	Technical Data- System <b>PKZ 0</b> - Motor Protector - Electrical Life Curves - Let-through Current and Energy Curves - General Technical Information - Short Circuit Ratings IEC/EN 60 947	7/42 7/43 7/44 7/47
	Technical Data- System <b>PKZ 2</b> - Motor Protector - Electrical Life Curves - Let-through Current and Energy Curves - General Technical Information - Short Circuit Ratings IEC/EN 60 947	7/48 7/49 7/50 7/54
	Dimensions	7/55

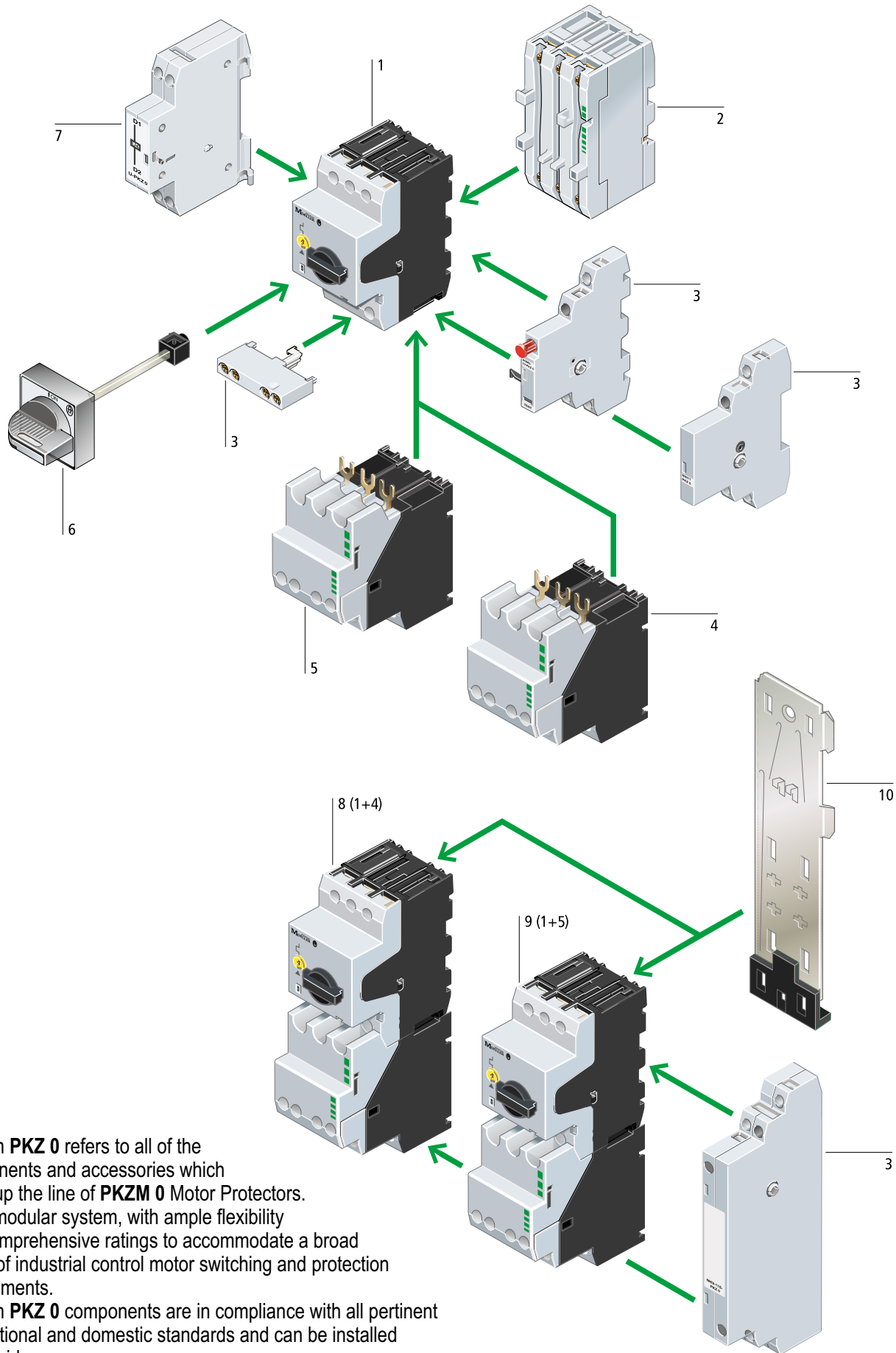

System **PKZ 0** refers to all of the components and accessories which make up the line of **PKZM 0** Motor Protectors. It is a modular system, with ample flexibility and comprehensive ratings to accommodate a broad range of industrial control motor switching and protection requirements. System **PKZ 0** components are in compliance with all pertinent international and domestic standards and can be installed world-wide.  
 Maximum ratings: 25 Amps, 600 V AC

Manual Motor Protectors, Motor Protectors with Contactor  
 Motor Starter Combinations

7

### 1 Manual Motor Protector

Thermal-Magnetic Motor Protector  
 Rated up to 25 Amps  
 Maximum 3 Phase HP rating: 15/ 20 @ 460/ 575 V AC  
 UL Listed for Group installations per NEC 430-53  
 CSA Certified for Group installations per CEC Part 1, 28-206  
 High Short Circuit Rating: Up to 50 kA @ 600 V AC  
 UL Listed, CSA Certified, in Conformity with IEC/EN 60 947  
 CE Marked  
 Type: **PKZM 0**-...

### 2 Current Limiter Module

Increases short circuit current rating of the **PKZM 0**.  
 Fuseless, current limiting set of contacts housed in a module.  
 Mounts directly beneath or ahead of the **PKZM 0**.  
 Type: **CL-PKZ 0**

### 3 Auxiliary Contact Modules

Signals ON/OFF status of **PKZM 0** Motor Protector and Motor Protector + Contactor combination.  
 Trip indicating contacts which differentiate between overload and short circuit tripping.  
 Early-Make contacts for use with undervoltage trips.  
 Type: **NHI**-..., **AGM**-..., **VHI**-...

### 4 Magnetic Contactor Module

AC or DC operated versions.  
 Supplied with 1 N.O./1N.C. or 2 N.O. contacts.  
 Plugs into the load side of the **PKZM 0** protector or can be separately mounted.  
 Rated 7 1/2 HP @ 460 V AC/ 10 HP @ 575 V AC  
 UL Listed with **PKZM 0** Motor Protector for Group installations per NEC 430-53.  
 CSA Certified with **PKZM 0** Motor Protector for Group installations per CEC 28-206.  
 IEC 60 947-4-1 rated for Type 1 co-ordination.  
 Type: **SE 00**-...

### 5 High Capacity Magnetic Contactor Module

Same approvals & features as Type **SE00** above except: Internal current limitation feature to increase short circuit current rating and self-protection characteristics per IEC/EN 60 947.  
 IEC 60 947-4-1 rated for Type 2 co-ordination.  
 Type: **S 00**

### 6 Door Mounted Handle

Rated IP 65/ NEMA/UL 12, 3R.  
 3 Positions- ON, OFF, Tripped.  
 Door interlocking feature and padlockable with up to 3 padlocks. (Also available without door interlocking or padlockable feature.)  
 Plug-in extension shaft to accommodate various mounting depths.  
 Black, or Red/Yellow for E-Stop function  
 Type: **(R)H-PKZ 0**, **HSOV-PKZ 0**

### 7 Voltage trips

Undervoltage trip module  
 Shunt trip module  
 Mounts to the side of the **PKZM 0**.  
 Type: **U-PKZ0**, **A-PKZ0**

### 8(1+4) Magnetic Motor Protector Combination

Thermal-Magnetic Motor Protector (1) combined with the Magnetic Contactor Module (4) on a clip plate, suitable for DIN rail mounting (EN 50 022).  
 Maximum rating: 7 1/2 HP @ 460 V AC/ 10 HP @ 575 V AC  
 UL Listed for Group installations per NEC 430-53.  
 CSA Certified for Group installations per CEC 28-206.  
 High Short Circuit Rating: Up to 50 kA @ 600 V AC  
 UL Listed, CSA Certified, in Conformity with IEC/EN 60 947 IEC 60 947-4-1 rated for Type 1 co-ordination.  
 CE Marked  
 Type: **PKZM 0**-.../SE 00

### 9(1+5) Magnetic Motor Protector Combination with High Capacity Contactor

Thermal-Magnetic Motor Protector (1) combined with the High Capacity Magnetic Contactor Module (5) on a clip plate, suitable for DIN rail mounting (EN 50 022).  
 Maximum rating: 7 1/2 HP @ 460 V AC/ 10 HP @ 575 V AC  
 UL Listed for Group installations per NEC 430-53  
 CSA Certified for Group installations per CEC 28-206.  
 High Short Circuit Rating: Up to 50 kA @ 600 V AC  
 UL Listed, CSA Certified, in Conformity with IEC/EN 60 947 IEC 60 947-4-1 rated for Type 2 co-ordination.  
 CE Marked  
 Type: **PKZM 0**-.../S 00

### 10 Mounting/Wiring

Clip plate, onto which the compact motor protector combinations **PKZM 0**-.../S(E) 00 are mounted.  
 Suitable for DIN rail mounting (EN 50 022).  
 Other Mounting/Wiring Hardware:  
 - Adapters for direct busbar feeds in control panels.  
 - Mounting and Wiring system Type **MVS**-... to combine **PKZM 0** protectors with Type **DIL**...**M** magnetic contactors. (Refer to Section 3 for **DIL**...**M** info.)  
 Refer to pages 7/16-18 for additional details on these mounting and wiring accessories.

# System PKZ 0- Motor Protector Overview of Combinations

The possible combinations of open and enclosed motor protectors with various accessories is indicated by a dot ● in each shaded row.

## Open Devices, Enclosures

## Contacts and Modules

Standard Auxiliary Contacts



NHI 11-PKZ 0  
NHI 21-PKZ 0  
NHI 12-PKZ 0

Standard Auxiliary Contacts



NHI-E-11-PKZ 0  
NHI-E-10-PKZ 0

Early Make Auxiliary Contacts



VHI 20-PKZ 0

Trip Indicating Contacts



AGM 2-10-PKZ 0  
AGM 2-01-PKZ 0

Type	Type	Degree of Protection	NHI 11-PKZ 0 NHI 21-PKZ 0 NHI 12-PKZ 0	NHI-E-11-PKZ 0 NHI-E-10-PKZ 0	VHI 20-PKZ 0	AGM 2-10-PKZ 0 AGM 2-01-PKZ 0
<b>Manual Motor Protector</b>						
PKZM 0-...	-	IP 20	●	● or	●	●
	<b>Insulated Enclosure for Flush Mounting</b>					
	E-PKZ 0	Front IP 40	● -	- -	- -	- -
	E-PKZ 0-G(R)	Front IP 55	● -	● ●	- -	● -
<b>Insulated Enclosure for Surface Mounting</b>						
CI-PKZ 0	IP 40 UL/NEMA 1	● -	- -	- -	- -	
CI-PKZ 0-G(R)	IP 55 UL/NEMA 12	● -	● ●	- -	● -	
CI-PKZ 0-G(R)V	IP 55 UL/NEMA 12	-	-	-	●	-
<b>Motor Protector Combination</b>						
PKZM 0-.../S(E) 00	-	IP 20	● -	● or ● or	● ●	● -
<b>Insulated Enclosure for Surface Mounting</b>						
CI 23X -125-NA	IP 65 UL/NEMA 12	● -	● ●	● or ● or	● ●	● -

Manual Motor Protectors, Motor Protectors with Contactor

Motor Starter Combinations

7

# System PKZ 0- Motor Protector Overview of Combinations

Standard Auxiliary  
Contacts



NH12-11S-PKZ 0

Contactor



SE 00-...PKZ 0  
S 00-...PKZ 0

Undervoltage  
Trip



U-PKZ 0

Shunt Trip



A-PKZ 0

Door Mounting  
Handle



H-PKZ 0  
RH-PKZ 0  
HSOV-PKZ 0

Indicating Light



L-PKZ 0

Standard Auxiliary Contacts	Contactor	Undervoltage Trip	Shunt Trip	Door Mounting Handle	Indicating Light
-	●	● or	●	●	-
-	-	- or	-	-	●
-	-	● or	●	-	●
-	-	- or	-	-	●
-	-	●	-	-	●
●	-	● or	●	●	-
●	-	● or	●	● IP 65 ● IP 65	●

Manual Motor Protectors, Motor Protectors with Contactor  
Motor Starter Combinations

7

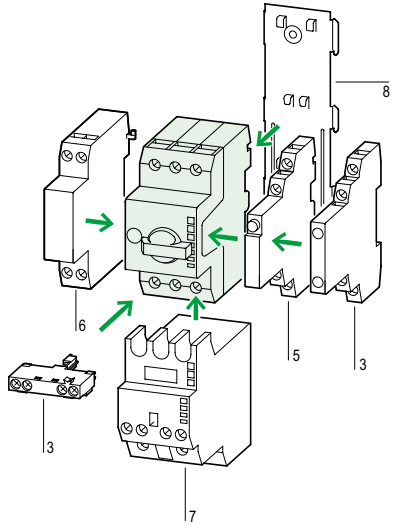

6	7	8	9	10	11
Adjustable Thermal Range	Response Current of Magnetic Trips	UL/CSA Short Circuit Current Rating @ 600 V AC.	Maximum Listed Branch Circuit Protective Fuse	Maximum Listed Branch Circuit Protective Breaker	Remarks
A	A	kA	A	A	
0.1 - 0.16	2.2	50	600	600	 <p>1 - <b>PKZM 0(-T)</b> Motor Protector 7/6                  2 - Side-mounted Auxiliary Contact 7/10                  3 - Top-mounted Auxiliary Contact 7/10                  4 - Trip Indicating Auxiliary Contact 7/11                  5 - Shunt Trip Undervoltage Trip 7/11                  6 - Magnetic Contactor Module* 7/12                  7 - Clip Plate 7/15                  - Accessories 7/10 - 7/19</p> <p>* Note:                  The <b>PKZM 0-...-T</b> cannot be combined with the high capacity contactor module (Type <b>S 00</b>).</p>
0.16 - 0.25	3.4	50	600	600	
0.25 - 0.4	5.6	50	600	600	
0.4 - 0.63	8.8	50	600	600	
0.63 - 1	14	50	600	600	
1 - 1.6	22	50	600	600	
1.6 - 2.5	35	50	600	600	
2.5 - 4	56	50	600	600	
4 - 6.3	88	50	600	600	
6.3 - 11	140	22 <sup>1)</sup>	150	125	
10 - 16	224	10 <sup>1)</sup>	150	125	
16 - 20	280	10 <sup>1)</sup>	150	125	
20 - 25	350	10 <sup>1)</sup>	150	125	
0.1 - 0.16	2.4	50	600	600	
0.16 - 0.25	4.25	50	600	600	
0.25 - 0.4	6.8	50	600	600	
0.4 - 0.63	11.97	50	600	600	
0.63 - 1	20	50	600	600	
1 - 1.6	32	50	600	600	
1.6 - 2.5	50	50	600	600	
2.5 - 4	84	50	600	600	
4 - 6.3	141	50	600	600	
6.3 - 11	224	22 <sup>1)</sup>	150	125	
10 - 16	358	10 <sup>1)</sup>	150	125	
16 - 20	380	10 <sup>1)</sup>	150	125	

Manual Motor Protectors, Motor Protectors with Contactor  
Motor Starter Combinations

**System PKZ 0 Motor Protectors in Group Motor Applications**

**PKZM 0** motor protectors are UL listed and CSA certified for group applications as per the intent of NEC 430-53 and CEC part 1, Rule 28-206. This eliminates the need for individual motor branch circuit overcurrent protective devices for each motor, thus greatly reducing the cost and space requirements of industrial control panels and assemblies.

In group installations involving a number of **PKZM 0** motor protectors, the maximum rating of the group branch circuit overcurrent protective device is based on the lowest backup overcurrent rating marked on each motor protector in the group, combined with applicable NEC installation rules.

Please refer to the UL/CSA short circuit current and backup overcurrent protection ratings in columns 8-10 for selection guidelines on **PKZM 0** Motor protectors.

1) Higher short circuit ratings can be obtained by use of the **CL-PKZ0** accessory: (See page 7/11).  
 - **PKZM 0-... + CL-PKZ0**: 50 kA @ 600 V AC, for 10 A and 16 A models  
 - **PKZM 0-... + CL-PKZ0**: 18 kA @ 600 V AC, for 20 A and 25 A models



**Magnetic Motor Protector Combinations Type PKZM 0.../S(E) 00**

1	2	3	4	5
	<p>Circuit Diagram</p> <p>Contactors supplied standard with 1 N.O. &amp; 1 N.C. Auxiliary contacts.</p>	<p>UL/CSA 3 Phase HP Ratings</p> <p>(Single phase ratings &amp; IEC kW Ratings, see pages 7/44 &amp; 7/45)</p> <p>200 V 230 V <b>460 V</b> 575 V</p>	<b>Type</b>	<b>Price</b>

**Magnetic Motor Protector Combination**

UL/CSA Group installations  
IEC/EN 60 947-4-1 "Type 1" co-ordination level

Specify Coil Voltage from page 7/39 when ordering (...)

- PKZM 0-0.16/SE 00-11 (...)
- PKZM 0-0.25/SE 00-11 (...)
- PKZM 0-0.4/SE 00-11 (...)
- PKZM 0-0.63/SE 00-11 (...)
- PKZM 0-1/SE 00-11 (...)
- PKZM 0-1.6/SE 00-11 (...)
- PKZM 0-2.5/SE 00-11 (...)
- PKZM 0-4/SE 00-11 (...)
- PKZM 0-6.3/SE 00-11 (...)
- PKZM 0-10/SE 00-11 (...)

Manual Motor Protectors, Motor Protectors with Contactor

Motor Starter Combinations

7

Specify Coil Voltage from page 7/39 when ordering (...)

- PKZM 0-0.16/S 00-11 (...)
- PKZM 0-0.25/S 00-11 (...)
- PKZM 0-0.4/S 00-11 (...)
- PKZM 0-0.63/S 00-11 (...)
- PKZM 0-1/S 00-11 (...)
- PKZM 0-1.6/S 00-11 (...)
- PKZM 0-2.5/S 00-11 (...)
- PKZM 0-4/S 00-11 (...)
- PKZM 0-6.3/S 00-11 (...)
- PKZM 0-10/S 00-11 (...)

In this range select Motor Protector in accordance with the Motor nameplate Full Load Current.

1/2	1/2	1	1 1/2
1	1	2	3
1 1/2	1 1/2	3	5
2	3	7 1/2	10

In this range select Motor Protector in accordance with the Motor nameplate Full Load Current.

1/2	1/2	1	1 1/2
1	1	2	3
1 1/2	1 1/2	3	5
2	3	7 1/2	10

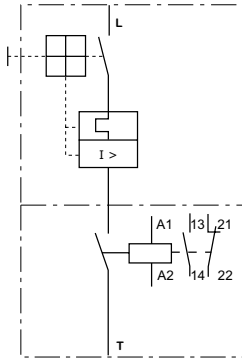

**Magnetic Motor Protector Combination with High Capacity Contactor**

UL/CSA Group installations  
IEC/EN 60 947-4-1 "Type 2" co-ordination level

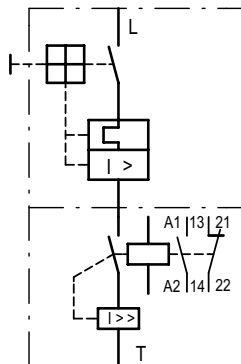

The **PKZM 0-.../SE 00** and **PKZM 0-.../S 00** are motor protector combinations made up of **PKZM 0-...** manual motor protectors (see page 7/6) and System **PKZ 0** magnetic contactors (Types **SE 00** and **S 00**).

These Motor Protector combinations are UL listed and CSA certified as assemblies which provide motor controller functions and running overload protection. In addition, they are UL listed and CSA certified for group applications as per NEC 430-53(c) and CEC part 1, Rule 28-206. This means that a group of motors, each protected and controlled by a **PKZM 0-.../S(E) 00**, can be combined under a single branch circuit short circuit and ground fault protective device, the maximum rating of which is marked on each **PKZM 0** motor protector. (See columns 8-10 for UL/CSA short circuit current and backup overcurrent protection ratings.)

**Features:**

- Ratings: 11 Amp, 600 V AC - 7 1/2 HP @ 460 V, 10 HP @ 575 V max.
- Approved for world markets = UL, CSA, IEC/EN 60 947, CE Marked
- Conformity with "Type 1" and "Type 2" co-ordination levels
- Phase failure sensitive & ambient compensated.
- Adjustable thermal trips set to motor FLC or nameplate current.
- Fixed instantaneous magnetic trip response.
- Open or door mounted handle, padlockable, with 3 position indication (ON, OFF, Trip). See Accessories on page 7/15
- 'Finger Safe' construction.
- Assembled on clip plate for 35 mm DIN rail or panel mounting.

Ordering Information: Specify Type from column 4 and add desired control voltage. Example: **PKZM 0-10/SE 00-11 (120V, 60Hz)**



Magnetic Motor Protector Combinations Type PKZM 0.../S(E) 00

6	7	8	9	10	11
Adjustable Thermal Range (Set to Motor FLC)	Response Current of Magnetic Trips	UL/CSA Short Circuit Current Rating RMS Sym @ 600 V AC.	Maximum Listed Branch Circuit Protective Fuse	Maximum Listed Branch Circuit Protective Circuit Breaker	Remarks
A	A	kA	A	A	

0.1 - 0.16	2.2	50	600	600
0.16 - 0.25	3.4	50	600	600
0.25 - 0.4	5.6	50	600	600
0.4 - 0.63	8.8	50	600	600
0.63 - 1	14	50	600	600
1 - 1.6	22	50	600	600
1.6 - 2.5	35	50	600	600
2.5 - 4	56	50	600	600
4 - 6.3	88	50	600	600
6.3 - 11	140	22	150	125

0.1 - 0.16	2.2	50	600	600
0.16 - 0.25	3.4	50	600	600
0.25 - 0.4	5.6	50	600	600
0.4 - 0.63	8.8	50	600	600
0.63 - 1	14	50	600	600
1 - 1.6	22	50	600	600
1.6 - 2.5	35	50	600	600
2.5 - 4	56	50	600	600
4 - 6.3	88	50	600	600
6.3 - 11	140	22	150	125

System PKZ 0 Motor Protector Combinations & Accessories

- 1 - PKZM 0/S(E) 00-11 Motor Protector Combination
- 2 - Side Mounted Auxiliary Contact 7/10
- 3 - Top Mounted Auxiliary Contact 7/10
- 4 - Side Mounted Auxiliary Contact to fit over entire starter 7/11
- 5 - Trip Indicating Auxiliary Contact 7/11
- 6 - Shunt Trip Undervoltage Trip 7/11
- 7 - Clip Plate 7/12

Additional Accessories 7/10 - 7/19

Note:  
DC operated versions come standard with built-in surge suppressors.  
Surge Suppressors available for AC versions as an option. See page 7/12

Manual Motor Protectors, Motor Protectors with Contactor Motor Starter Combinations





**Group Motor Applications**

PKZM 0.../S(E) 00 Motor Protector combinations are UL listed and CSA certified for group applications as per the intent of NEC 430-53 and CEC part 1, Rule 28-206. This eliminates the need for individual motor branch circuit overcurrent protective devices for each motor, thus greatly reducing the cost and space requirements of industrial control panels and assemblies.

In group installations involving a number of System PKZ 0 motor protectors, the maximum rating of the group branch circuit overcurrent protective device is based on the lowest backup overcurrent rating marked on each motor protector in the group, combined with applicable NEC installation rules.

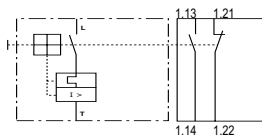
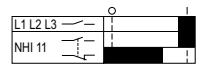
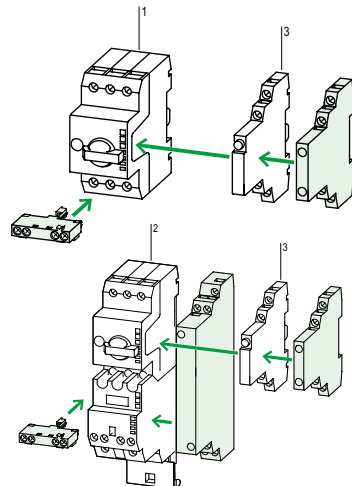
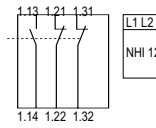
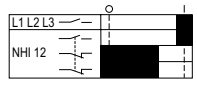
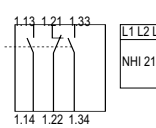
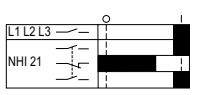
Please refer to the UL/CSA short circuit current and backup overcurrent protection ratings in columns 8-10 for selection guidelines on PKZM 0 and PKZM 0.../S(E) 00 motor protectors.  
Additional Notes:  
PKZM 0.../SE 00 Motor Protector combinations are in conformity with Type 1 co-ordination levels @ up to 500 V AC, per IEC/EN 60 947-4-1.  
PKZM 0.../S 00 Motor Protector combinations are in conformity with Type 2 co-ordination levels @ up to 500 VAC, per IEC/EN 60 947-4-1. Further, during UL/CSA short circuit testing of this combination, no heater burn-out or contact welding occurred.

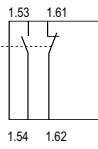
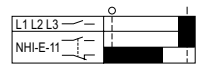
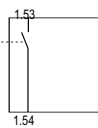
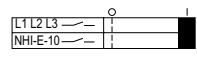

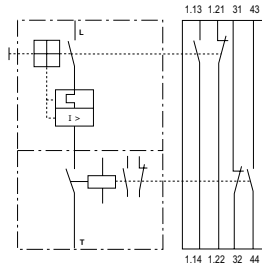
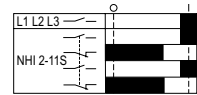



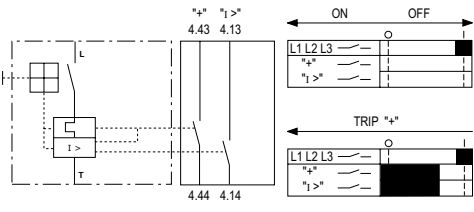
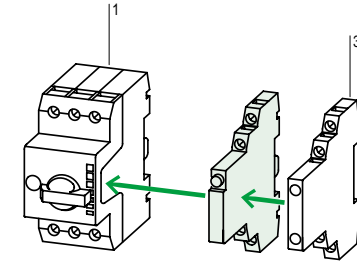
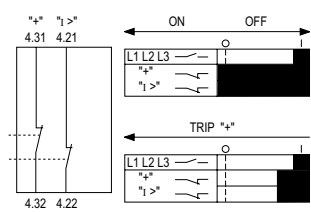

# System PKZ 0- Motor Protector Accessories- Auxiliary Contacts

1	2	3	4	5	6	7
Connection Diagram	Auxiliary Contact state in relation to Main Contacts	Number of Contacts	Type	Price	Remarks	
		N.O. = Normally Open N.C. = Normally Closed				
		N. O.    N. C.		\$		
<b>Standard Auxiliary Contacts</b> Short Version- Side Mounted						
 <p>Mounts to side of <b>PKZM 0</b> Motor Protector</p>	 	1	1	<b>NHI 11-PKZ 0</b>		
	 	1	2	<b>NHI 12-PKZ 0</b>		
	 	2	1	<b>NHI 21-PKZ 0</b>		
<b>Standard Auxiliary Contacts</b> Top Mounted						
 <p>Clips onto top portion of <b>PKZM 0</b> Motor Protector</p>	 	1	1	<b>NHI-E-11-PKZ 0</b>	<p>1 - Manual Motor Protector 7/6 2 - Motor Protector Combinations 7/8 3 - Trip Indicating Contact 7/11</p> <p>The Side Mounted contacts (Short Version) mount on the right side of the protector and can be combined with:</p> <ul style="list-style-type: none"> <li>- Trip indicating contacts Type <b>AGM...</b></li> <li>- Top-Mounted contacts Type <b>NHI-E...</b></li> </ul> <p>but cannot be combined with the long version contact module Type <b>NHI2-11S-PKZ0</b>.</p>	
	 	1	0	<b>NHI-E-10-PKZ 0</b>		
<b>Standard Auxiliary Contacts</b> Long Version- Side Mounted						
 <p>Mounts on side of <b>PKZM 0/S(E) 00</b> protector combination. Features two sets of contacts: - One set actuated by Motor Protector - One set actuated by Contactor Permits differentiated signalling of the state of Motor Protector and Contactor Main Contacts.</p>	 	2	2	<b>NHI 2-11S-PKZ 0</b>	<p>The Top-Mounted contacts Type <b>NHI-E...</b> have the added benefit of not increasing the width or height of the Motor Protector when inserted.</p> <p>The long version contact module Type <b>NHI2-11S-PKZ0</b> mounts on the right side of the <b>PKZM0/S(E) 00</b> Motor Protector Combination and can be combined with:</p> <ul style="list-style-type: none"> <li>- Top-Mounted contacts Type <b>NHI-E...</b></li> </ul> <p>but cannot be combined with:</p> <ul style="list-style-type: none"> <li>- Short version contact Modules Type <b>NHI...</b></li> <li>- Trip indicating contacts Type <b>AGM...</b></li> </ul>	

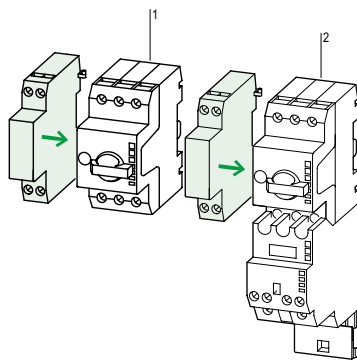
Manual Motor Protectors, Motor Protectors with Contactor  
Motor Starter Combinations

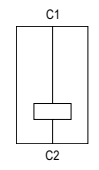
7

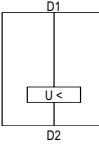
# System PKZ 0- Motor Protector Accessories- Auxiliary Contacts, Voltage Trips

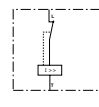
1	2	3	4	5	6	7
	Connection Diagram	Auxiliary Contact state in relation to Main Contacts	Number of Contacts N.O. = Normally Open N.C. = Normally Closed N.O.    N.C.	Type	Price	Remarks
<b>Trip Indicating Auxiliary Contacts</b>						
			2      0	<b>AGM 2-10-PKZ 0</b>	See Price List	 <p>1 - Manual Motor Protector 7/6 3 - Standard Auxiliary Contact 7/10 - Accessories 7/13</p> <p>The <b>AGM...</b> trip indicating contact mounts on the right side of the Motor Protector and can be combined with: Standard Auxiliary Contacts: <b>NHI 11-PKZ 0</b> <b>NHI 12-PKZ 0</b> <b>NHI 21-PKZ 0</b> <b>NHI-E-PKZ 0</b></p> <p>It cannot be combined with the long version auxiliary contact: <b>NHI 2-11S-PKZ 0</b></p>
Mounts to side of <b>PKZM 0</b> Motor Protector. Provides a differentiated trip signal: "+"> : These contacts actuate under all trip conditions. "I >" : These contacts actuate <b>only</b> under short circuit trip conditions. Also comes with red short circuit trip indicator which can be reset manually.			0      2	<b>AGM 2-01-PKZ 0</b>	See Price List	
<b>Early-Make Auxiliary Contacts</b>						
			2      0	<b>VHI 20-PKZ 0</b>	See Price List	 <p>1 - Manual Motor Protector 7/6 2 - Motor Protector Combinations 7/8</p> <p>Voltage trip modules mount on the left side of the main device.</p> <p><b>A-PKZ 0</b> shunt trips cannot be combined with <b>U-PKZ 0</b> undervoltage trips. The DC version is rated for short time duty: Max. 5 sec.</p> <p><b>U-PKZ 0</b> undervoltage trips cannot be combined with <b>A-PKZ 0</b> shunt trips. Can be used in conjunction with the Motor Protector <b>PKZM 0</b> and <b>VHI</b> early-make contacts to provide Emergency-Stop functions.</p>
Clips onto top portion of <b>PKZM 0</b> Motor Protector. Ideally used in combination with the undervoltage trip module in Emergency-Stop circuits						
<b>Voltage trips</b>						
<b>Shunt Trip</b> AC and DC ratings						
				<b>A-PKZ 0 (...)</b>	See Price List	<p>Insert desired Voltage rating from page 7/39</p>
				<b>A-PKZ 0 (...)</b> DC	See Price List	
				<b>U-PKZ 0 (...)</b>	See Price List	
<b>Undervoltage Trip</b> AC ratings						
					See Price List	
<b>Fuseless Current Limiter</b>						
		Used to increase the short circuit rating of Motor Protectors and Motor Protector Combinations. Mounts beneath or next to <b>PKZM 0</b> Motor Protector.		<b>CL- PKZ 0</b>	See Price List	

 Manual Motor Protectors, Motor Protectors with Contactor  
Motor Starter Combinations

7



**Ordering Information:**

- If ordered separately: Specify Type from Column 5. Example: **U-PKZ 0 (120V, 60Hz)**
- If ordered with device: Add a + in front of Type: Example: **+ U-PKZ 0 (120V, 60 Hz)**

# System PKZ 0- Motor Protector Contactors and Accessories, Auxiliary Contacts, Surge Suppressors

1	2	3	4	5
	Connection Diagram	UL/CSA Maximum 3 Phase HP Rating @:  (Single phase ratings: page 7/44)	Number of Contacts  N.O. = Normally Open N.C. = Normally Closed	For Use With:
		200 V    230 V <b>460 V</b> 575 V	N. O.    N. C.	

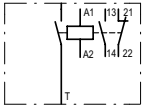
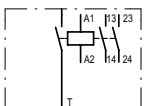
## Magnetic Contactor Module

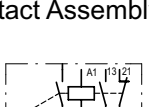

		2	3	<b>5</b>	5	1	1	PKZM 0
		2	3	<b>5</b>	5	2	-	PKZM 0
		2	3	<b>5</b>	5	2	-	PKZM 0
		2	3	<b>5</b>	5	1	1	PKZM 0

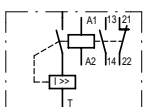
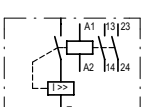
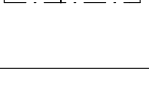
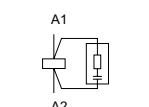
## High Capacity Magnetic Contactor Module with Current Limiting Contact Assembly

		2	3	<b>5</b>	5	1	1	PKZM 0
		2	3	<b>5</b>	5	2	-	PKZM 0
		2	3	<b>5</b>	5	2	-	PKZM 0
		2	3	<b>5</b>	5	1	1	PKZM 0

Plug-fit into load side  
of Motor Protector

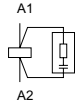
## Surge Suppressors for AC Contactor Coils

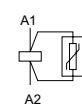
		Voltage Range (50,60Hz):					
		24 - 48 V AC				S(E)00-...-PKZ 0	
		110 - 250 V AC				S(E)00-...-PKZ 0	
		24 - 48 V AC				S(E)00-...-PKZ 0	
		110 - 250 V AC				S(E)00-...-PKZ 0	
		380 - 415 V AC				S(E)00-...-PKZ 0	

## Base for separate mounting

	S(E)00-PKZ 0 (...) HI 11-S/EZ-PKZ 0
--	--

## Mechanical Interlock

	S(E)00-PKZ 0 (...) PKZM 0-../S(E)00
--	--







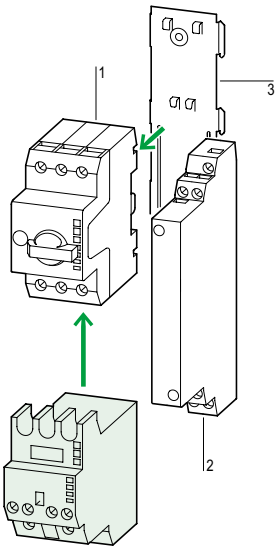
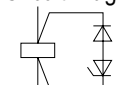
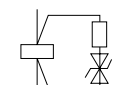

## Auxiliary contact module

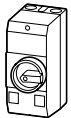
		1	1	S(E)00 + EZ-PKZ 0
--	---	---	---	-------------------

# System PKZ 0- Motor Protector Contactors and Accessories, Auxiliary Contacts, Surge Suppressors

6 Type	7 Price	8 Notes	9 Remarks
<p>Specify Coil Voltage from page 7/39 when ordering ↓</p> <p>SE00-11-PKZ 0 (...)</p> <p>SE00-20-PKZ 0 (...)</p> <p>SE00-20-PKZ 0 (...V DC)</p> <p>SE00-11-PKZ 0 (...V DC)</p> <p>Specify Coil Voltage from page 7/39 when ordering ↓</p> <p>S00-11-PKZ 0 (...)</p> <p>S00-20-PKZ 0 (...)</p> <p>S00-20-PKZ 0 (...V DC)</p> <p>S00-11-PKZ 0 (...V DC)</p>	<p>See Price List</p> <p>See Price List</p> <p>See Price List</p> <p>See Price List</p> <p>See Price List</p> <p>See Price List</p> <p>See Price List</p> <p>See Price List</p> <p>See Price List</p> <p>See Price List</p>	<p><b>SE 00</b> and <b>S 00</b> contactors are only suitable for use with <b>PKZM 0</b> protectors.</p> <p>The Contactors are designed to plug into the load side of the <b>PKZM 0</b> Motor Protector to form a compact and contoured fit. A clip plate (see figure at right), onto which the combination is mounted, is a necessary part of the assembly and must be ordered separately if the Motor Protector combination is not purchased complete as shown on page 7/8.</p> <p><b>S(E) 00</b> contactors can also be individually mounted using the <b>EZ-PKZ 0</b> mounting base. Contactors so mounted can also be equipped with a side-mounted auxiliary contact module Type <b>HI11-S/EZ-PKZ 0</b>. (See below).</p> <p>The <b>S 00</b> contactor is identical to the <b>SE 00</b> except for the built-in current limiting contact assembly, which makes it suitable for "Type 2" co-ordination levels per IEC/EN 60 947 and no welding performance in combination with the <b>PKZM 0</b> Motor Protector.</p>	<div style="text-align: center;">  </div> <ul style="list-style-type: none"> <li>1 - <b>PKZM 0</b> Motor Protector <span style="float: right;">7/6</span></li> <li>2 - Side-mounted, long version Auxiliary Contact <span style="float: right;">7/10</span></li> <li>3 - Clip Plate <span style="float: right;">7/13</span></li> </ul> <p style="text-align: right;">- Additional Accessories <span style="float: right;">7/14</span></p>
<p>RC SPKZ 0 48</p> <p>RC SPKZ 0 250</p> <p>VG SPKZ 48</p> <p>VG SPKZ 250</p> <p>VG SPKZ 415</p>	<p>See Price List</p> <p>See Price List</p> <p>See Price List</p> <p>See Price List</p> <p>See Price List</p>	<p>DC rated contactor coils are supplied standard with built-in surge suppressors.</p> <p>Coil Voltage:      Circuit Diagram:</p> <p>12 V DC              </p> <p>24 V DC</p> <p>48 V DC</p> <p>60 V DC</p> <p>110 V DC            </p> <p>220 V DC</p>	
<p>EZ-PKZ 0</p>	<p>See Price List</p>	<p><b>SE 00</b> and <b>S 00</b> contactors can be individually or separately mounted using the <b>EZ-PKZ 0</b> mounting base. The base can also be mounted on DIN rail (on rails of 7.5 mm or 15 mm heights).</p>	
<p>MV-PKZ 0</p>	<p>See Price List</p>	<p>The <b>MV-PKZ 0</b> can be used to mechanically interlock two <b>S(E) 00</b> contactors e.g. to build reversing starter combinations.</p>	
<p>HI11-S/EZ-PKZ 0</p>	<p>See Price List</p>	<p>Cannot be combined with: <b>PKZM 0-.../S(E) 00</b> equipped with <b>NHI-...-PKZ 0</b> and/or <b>AGM-...-PKZ 0</b>.</p>	<p>Ordering Information: Specify Type from Column 6. Example: <b>MV-PKZ 0</b></p> <p>Insert desired coil voltage where specified. Example: <b>SE00-11-PKZ 0 (120V, 60Hz)</b> <b>S00-20- PKZ 0 (24V DC)</b></p>

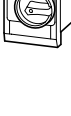
# System PKZ 0- Motor Protector Insulated Enclosures, Housings, Padlocking provisions









1	2	3	4	5	6	7
	Notes	Degree of Protection	For Use With	Remarks	Type	Price
<b>Insulated Enclosures for surface mounting</b>						
For Motor Protector						
	Cover with opening dimensioned to accommodate front of Motor Protector	IP 40 UL/NEMA 1	<b>PKZM 0-...+NHI</b> or <b>U</b> or <b>A</b> , <b>+L-PKZ 0</b> (Max. 2 lights)	Includes ground terminal connection, 2 PG 16 cable entry knockouts, top and bottom	<b>CI-PKZ 0</b>	See Price List
	With black/gray handle	IP 55 UL/NEMA 12	<b>PKZM 0-...+NHI+NHI-E</b> or <b>U+NHI-E</b> or <b>A+NHI-E</b> , <b>+L-PKZ 0</b> (Max. 2 lights)		<b>CI-PKZ 0-G</b>	See Price List
	With red/yellow handle for use in Emergency-Stop circuits.	IP 55 UL/NEMA 12	<b>PKZM 0-...+VHI...+ U...</b>		<b>CI-PKZ 0-GR</b>	See Price List
For Motor Protector with early-make contacts						
	With black/gray handle	IP 55 UL/NEMA 12	<b>PKZM 0-...+VHI...+ U...</b>	Includes ground terminal connection, 2 PG 16 cable entry knockouts, top and bottom	<b>CI-PKZ 0-GV</b>	See Price List
	With red/yellow handle for use in Emergency-Stop circuits.	IP 55 UL/NEMA 12	<b>PKZM 0-...+VHI...+ U...</b>		<b>CI-PKZ 0-GRV</b>	See Price List
For Motor Protector enclosures						
	Padlocking assembly accommodating up to 3 padlocks with a hasp thickness of 3 - 6 mm		<b>CI-PKZ 0-G(R)(V)</b>	Padlockable in the OFF position of the <b>PKZM 0</b> Manual Motor Protector	<b>SVB-PKZ 0-CI</b>	See Price List
For Motor Protector Combinations						
	Suitable for cover interlocking handle <b>(R)H-PKZ 0</b> (IP 65).	IP 65 UL/NEMA 12 <sup>1)</sup>	<b>PKZM 0-.../S(E)00+NHI</b> or <b>NHI...S+NHI-E</b> , <b>+U</b> or <b>A+(R)H</b> <b>+L PKZ 0</b> (MAX. 2 lights)	Mounting depth 125 mm, additional <b>M3-CI23</b> mounting plate required	<b>CI23X-125-NA</b>	See Price List
<b>Insulated Housings for cavity mounting</b>						
	Cover with opening dimensioned to accommodate front of Motor Protector	Front IP 40	<b>PKZM 0-...+NHI</b> or <b>U</b> or <b>A</b> , <b>+L-PKZ 0</b> (Max.2 lights)	Includes ground terminal connection, 2 PG 16 cable entry knockouts, top and bottom	<b>E-PKZ 0</b>	See Price List
	With black/gray rotary handle	Front IP 55	<b>PKZM 0-...+NHI+NHI-E</b> or <b>U+NHI-E</b> or <b>A+NHI-E</b> , <b>+AGM</b> or <b>U+NHI-E</b> or <b>A+NHI-E</b> , <b>+L-PKZ 0</b>		<b>E-PKZ 0-G</b>	See Price List
	With red/yellow rotary handle for use in Emergency-Stop circuits	Front IP 55			<b>E-PKZ 0-GR</b>	See Price List
	Padlocking accessory to accommodate up to 3 padlocks with a hasp thickness of 3 - 6 mm		<b>E-PKZ 0-G(R)</b>	Padlockable in the OFF position of the <b>PKZM 0</b> Manual Motor Protector	<b>SVB-PKZ 0-E</b>	See Price List

1) UL Type 12 currently under submittal

Ordering Information:  
Specify Type from Column 6.  
Example: **CI-PKZ 0-G**









# System PKZ 0- Motor Protector Accessories- Clip plates, Handles, Indicating Lights

1	2	3	4
	Notes	Type	Price
<b>Clip Plate</b>			
	Always necessary when combining a <b>PKZM 0</b> manual protector and a <b>S(E) 00</b> magnetic contactor to create a magnetic Motor Protector Combination. Can be either panel mounted with screws or DIN rail mounted using one 15 mm height rail or two 7.5 or 15 mm height rails. DIN rails must conform to EN 50 022-35.	<b>C-PKZ 0</b>	See Price List
<b>Door Coupling Handles UL/NEMA 12 / IEC IP 65<sup>1)</sup></b> Drive dog and A-H-PKZ 0 extension shaft supplied with all door coupling handles. The extension shaft can be cut to any required length to accommodate mounting depths of 100 – 240 mm.			
	For use as Main Switch. Door/Cover interlocked when switch is in the ON position. Color: Black with On/Off and "+" (Trip) switch positions, lockable in OFF position using three 4 - 8 mm padlocks. Can also be modified to be lockable in the ON position.	<b>H-PKZ 0</b>	See Price List
	For use as Main Switch with Emergency-Stop function. Door/Cover interlocking feature. Color: Red/yellow with On/Off and "+" (Trip) switch positions, lockable in OFF position using three 4 - 8 mm padlocks.	<b>RH-PKZ 0</b>	See Price List
	Simpler mechanism, without any door/cover interlocking or padlocking capability. Color: Black, with On/Off and "+" (Trip) switch positions.	<b>HSOV-PKZ 0</b>	See Price List
<b>1/4" Padlockable Knob for Manual Protector</b>			
	Replaces standard <b>PKZM 0</b> knob handle with a padlockable version. Accommodates 1/4" padlocks (range: 3 – 6.35 mm). Padlockable in OFF position.	<b>AK-PKZ 0</b>	See Price List
<b>Tamper sealing Cover</b>			
	To prevent unauthorized access to the Motor FLC thermal trip dial setting and the Test-to-Trip function. Uses conventional lead seal.	<b>PL-PKZ 0</b>	See Price List
<b>Indicator Lights</b>			
	<b>For CI23X-..., CI-PKZ 0-..., E-PKZ 0-... Enclosures and Housings</b>		
	Color: White	Voltages: 110 - 230 V	<b>L-PKZ 0 (230V)</b>
		230 - 400 V	<b>L-PKZ 0 (400V)</b>
		415 - 500 V	<b>L-PKZ 0 (500V)</b>
	Color: Green	Voltages: 110 - 230 V	<b>L-PKZ 0-GN (230V)</b>
		230 - 400 V	<b>L-PKZ 0-GN (400V)</b>
		415 - 500 V	<b>L-PKZ 0-GN (500V)</b>
	Color: Red	Voltages: 110 - 230 V	<b>L-PKZ 0-RT (230V)</b>
		230 - 400 V	<b>L-PKZ 0-RT (400V)</b>
		415 - 500 V	<b>L-PKZ 0-RT (500V)</b>

1) UL Type 12 currently under submittal

Ordering Information:  
Specify Type from Column 3.  
Example: **AK-PKZ 0**



1	2	3	4	5	6	7
	For use with	Maximum Rated Current	Adapter Supply leads	Adapter Width	<b>Type</b>	<b>Price</b>
		Amps	AWG	mm		
<b>Control Panel Bus Bar Adapters, 3-Pole</b>						
For mounting in industrial control panels on Cu 20 x 5 mm busbar arrangements with 60 mm phase separation. The back of the adapter connects onto the bus. Components are mounted on top of the adapter and wired to the supply leads. All assembly is done under de-energized (Power OFF) conditions.						
	<b>PKZM 0-... or PKZM 0-.../S(E)00 + AGM or NHI</b>	25	10	54	<b>AD 25/5-1</b>	See Price List
	<b>2 x PKZM 0-... or 2 x PKZM 0-.../S(E) 00 + AGM or NHI, or 1 x PKZM 0-... + 2 x EZ-PKZ 0 + MV-PKZ 0</b>	25	10	108	<b>AD 25/5-2</b>	See Price List
	<b>2 x PKZM 0-... or 2 x PKZM 0-.../S(E) 00 + AGM or NHI, or 1 x PKZM 0-... + 2 x EZ-PKZ 0 + MV-PKZ 0 + AGM or NHI</b>	25	10	144	<b>AD 25/5-144</b>	See Price List
Same as above except for mounting on Cu 30 x 10 and 20 x 10 mm busbar arrangements with 60 mm phase separation.						
	<b>PKZM 0-... or PKZM 0-.../S(E) 00 + AGM or NHI</b>	25	10	54	<b>AD 25/10-1</b>	See Price List
	<b>2 x PKZM 0-... or 2 x PKZM 0-.../S(E) 00 + AGM or NHI, or 1 x PKZM 0-... + 2 x EZ-PKZ 0 + MV-PKZ 0</b>	25	10	108	<b>AD 25/10-2</b>	See Price List
	<b>2 x PKZM 0-... or 2 x PKZM 0-.../S(E) 00 + AGM or NHI, or 1 x PKZM 0-... + 2 x EZ-PKZ 0 + MV-PKZ 0 + AGM or NHI</b>	25	10	144	<b>AD 25/10-144</b>	See Price List
<b>Adapter Extension</b>						
	Push-fit strip, can be fitted onto AD... to extend mounting width			9	<b>AD-E</b>	See Price List

Ordering Information:  
Specify Type from Column 6. Example: **AD 25/10-1**

# System PKZ 0- Motor Protector MVS Mounting and Wiring Accessory Kits for Motor Starter Combinations

1	2	3	4	5	6
	For Use With <b>PKZM 0</b> Motor Protectors + <b>DIL...M</b> Magnetic Contactors  (Refer to Section 3 for info on Type <b>DIL...M</b> contactors.)	UL/CSA Maximum 3 Phase HP Rating @:  460 V 575 V	<b>MVS Kit Type</b>	<b>Price</b>	Remarks

## Full Voltage, Non-Reversing Starter Combinations

	<b>PKZM 0 + DIL (E)EM</b>	5	5	<b>MVS-D4</b>	Includes a mounting plate and finger-safe wiring harness to accommodate FVNR motor starter combinations consisting of <b>PKZM 0</b> Motor Protectors and <b>DIL...M</b> Magnetic Contactors in various HP sizes. UL listed/CSA certified for group installations and high fault short circuit current ratings (see page 7/19) in association with Moeller Electric components.
	<b>PKZM 0 + DIL 00(A)M</b>	7½	10	<b>MVS-D5</b>	
	<b>PKZM 0 + DIL 0M</b>	10	15	<b>MVS-D11</b>	
	<b>PKZM 0 + DIL 0AM</b>	15	20	<b>MVS-D11</b>	

Accommodates Mechanically Interlocked Contactors

	<b>PKZM 0 + DIUL (E)EM/21/MV</b>	5	5	<b>MVS-W4</b>	Includes a mounting plate and finger-safe wiring harnesses to accommodate FVR motor starter combinations consisting of <b>PKZM 0</b> Motor Protectors and <b>DIL...M</b> mechanically interlocked Magnetic Contactors in various HP sizes. UL listed/CSA certified for group installations and high fault short circuit current ratings (see page 7/19) in association with Moeller Electric components.
	<b>PKZM 0 + DIUL 00(A)M/11/MV</b>	7½	10	<b>MVS-W5MV</b>	
	<b>PKZM 0 + DIUL 0M/11/MV</b>	10	15	<b>MVS-W11MV</b>	
	<b>PKZM 0 + DIUL 0AM/11/MV</b>	15	20	<b>MVS-W11MV</b>	

## Star-Delta Starter Combinations

Open Transition

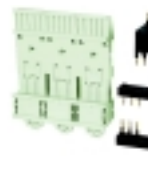
	<b>PKZM 0 + DIL EM/EEM +DIL ET 11-30-A</b>	7½	10	<b>MVS-S5</b>	Includes a mounting plate and finger-safe wiring harnesses to accommodate Star-Delta motor starter combinations consisting of <b>PKZM 0</b> Motor Protectors, electronic timing relays and <b>DIL...M</b> Magnetic Contactors in various HP sizes. UL listed/CSA certified for group installations and high fault short circuit current ratings (see page 7/19) in association with Moeller Electric components.
	<b>PKZM 0 + DIL 00AM/00M +ETR 4-51-A</b>	10	15	<b>MVS-S7</b>	
	<b>PKZM 0 + DIL 0M/00AM +ETR 4-51-A</b>	15	20	<b>MVS-S11</b>	

## For PKZM 0 Motor Protector Combinations

	<b>PKZM 0-.../SE 00</b> <b>PKZM 0-.../S 00</b>			<b>MVS-C45-S</b>	Mounting Plate to combine <b>PKZM 0-.../S(E) 00</b> Motor Protector Combinations with other <b>MVS</b> starters. Also allows feed using bus bar connectors (page 7/16).
--	---	--	--	------------------	---

Notes:

### Control Circuit Voltage

The **MVS** System wiring harnesses are designed to accommodate **DIL (E)EM** contactors that are either AC or DC energized and **DIL...M** contactors that are AC energized only.

### Surge Suppressors for DIL...M contactors

The following surge suppressors can be used with **DIL...M** contactors mounted on **MVS** mtg. plates:  
**RC B DIL 250** (RC filter), **VG B DIL 250** (Varistor suppressor) and **FD B-DIL** (diode suppressor)

Refer to Section 3 for more information on **DIL (E)EM** and **DIL M** contactors.

### Ordering Information:

Specify Type from Column 4.  
Example: **MVS-D5**

**MVS System**

The **MVS** system consists of mounting plates and wiring harnesses designed to combine **PKZM 0** Motor Protectors and **DIL...M** Magnetic Contactors in various Motor Starter configurations.

**MVS** Motor Starter Combinations are UL Listed and CSA Certified for group installations per the intent of NEC 430-53 and are also rated for high fault current ratings in association with listed upstream protective circuit breakers or fuses.

The **MVS** mounting and wiring system greatly cuts down the amount of mounting and wiring assembly time normally associated with motor starters and is thus ideally suited for use in industrial control panels.

**Installation Instructions**

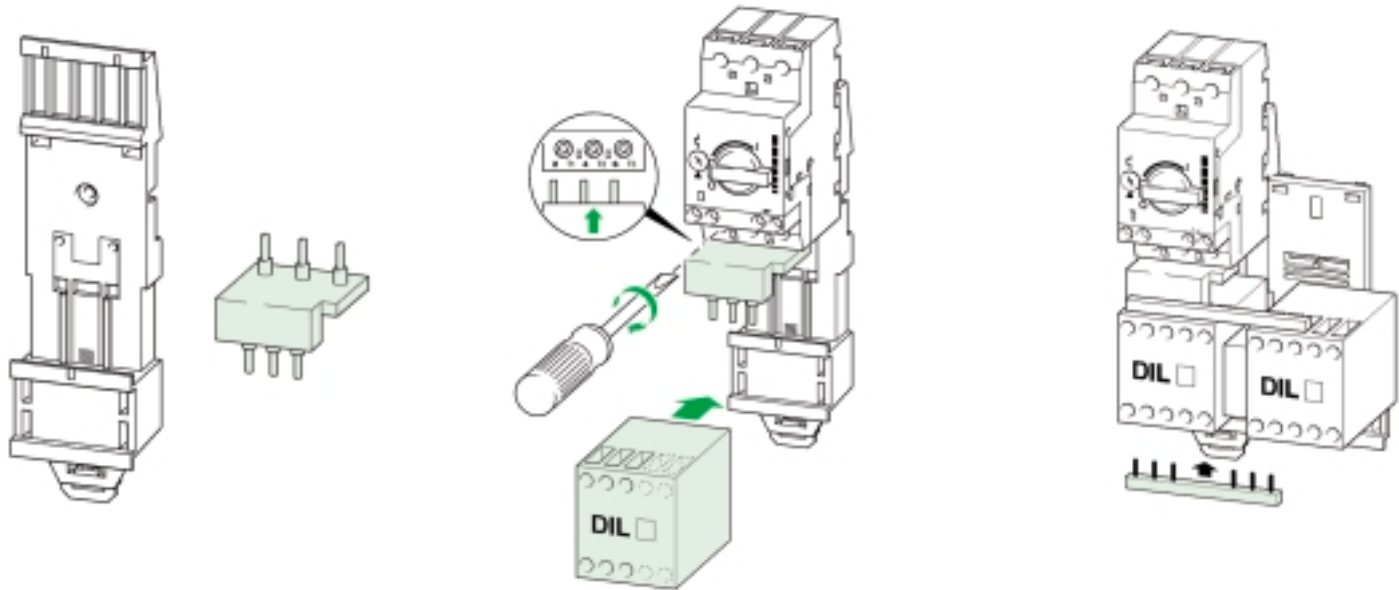

The **MVS** System Mounting plates are equipped with DIN Rails onto which **PKZM 0** Motor Protector and **DIL...M** Magnetic Contactors are securely fastened. Each **MVS** type comes with its own set of wiring harnesses to accommodate a number of starter configurations such as Full Voltage Non-Reversing and Full Voltage Reversing combinations. Once the wiring harness is in place it will provide a finger-safe connection between the Motor Protector and Contactor(s). One size screwdriver is the only tool required to complete the assembly. The mounting plate itself can either be panel mounted using screws or snapped onto a 35 mm DIN rail (EN 50 022) for quicker assembly. Depending on the starter type, assembly and wiring time is reduced by more than 50% over conventional methods. In addition to the time saving, the **MVS** System kits will further lower costs by reducing overall panel space requirements.

Full Voltage Non-Reversing Combinations: **MVS-D...**

Full Voltage Reversing Combinations: **MVS-W...(MV)**

Star-Delta Combinations **MVS-S...**

**UL/CSA Short Circuit Current / NEC Group Protection Ratings**

**MVS System used in association with PKZM 0 Motor Protectors, DIL...M Magnetic Contactors and Listed Branch Circuit Overcurrent Protective Devices**

	RMS Short Circuit Current Rating @ 600 V AC kA	Listed Group Protection Back-up Device	
		Fuse	Breaker
<b>PKZM 0-6.3 + DIL...M + MVS</b>	50	600 A	600 A
<b>PKZM 0-10 + DIL...M + MVS</b>	22	150 A	125 A
<b>PKZM 0-16, 20, 25 + DIL...M + MVS</b>	10	150A	125 A

## X-ON Electronics

Largest Supplier of Electrical and Electronic Components

*Click to view similar products for [Contactors - Electromechanical category](#):*

*Click to view products by [Eaton manufacturer](#):*

Other Similar products are found below :

[686-120111](#) [70-901](#) [70-914](#) [MB-3D-6](#) [MC-22A/4-AC120V](#) [8-1616943-9](#) [8-1672124-5](#) [A701U](#) [AVR743D](#) [B6-40-00-84](#) [B7-40-00-84](#)  
[1616017-5](#) [HP-11D-24](#) [P25-E5019-1](#) [P40P47D13P1-24-01](#) [CA7-72-00-24Z](#) [90-162](#) [9-1393132-2](#) [2NC4F0222](#) [ACC338UMM20](#)  
[AF80-30-11-13](#) [SZ-B1](#) [3GC2H0M22](#) [3NC0T0A22](#) [3NC1Q0A22](#) [42AF35AG](#) [42AF35AH](#) [42CF35AE](#) [42CF35AL](#) [42FE35AFR](#)  
[45CG10AFA](#) [45CG10AJA](#) [45CG10EJA](#) [45CG20AF](#) [45CG20AL](#) [45CG20EF](#) [45CG20EG](#) [45CG20EL](#) [45DG10AFA](#) [45DG10AGA](#)  
[45DG10AJA](#) [45DG10ALA](#) [45DG10ELA](#) [45DG20AG](#) [45DG20AL](#) [45EG10AFA](#) [45EG10AJA](#) [45EG10ALA](#) [45EG20AL](#) [45FG10AFA](#)