

PTR030V

30 Volt DC radial leaded, PolyTron™ PTC devices



Product features

- PolyTron™ radial leaded thru-hole PTC device
- Maximum 30 V
- Current ratings from 0.90 A to 9.00 A
- Fast time-to-trip
- Low resistance
- Halogen free, Lead free, RoHS compliant

Applications

- Medical equipment
- White goods
- Industrial power transmission
- Telecommunications
- Computers and peripherals
- Consumer and automotive electronics
- Rechargeable battery packs

Agency information

- cURus: Recognized Card: File E343021 (Ihold 0.9-9 A)
- TUV File: J 50194729

Ordering information/ part number system

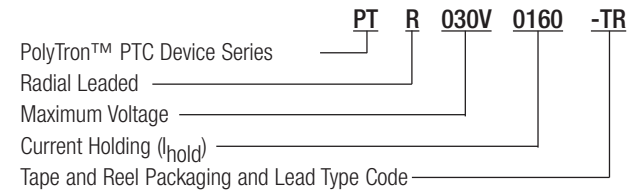

Lead Codes: TR & BK - Straight Leads, TR1 & BK1 - Kinked Leads

TR & TR1 On Reels

- 0.90-1.60 A - 3000 devices
- 1.85-3.00 A - 2000 devices
- 4.00-9.00 A - 1000 devices

BK & BK1 In Poly Bags

- 0.90-1.35 A - 1,000 devices
- 1.60-6.00 A - 500 devices
- 7.00-9.00 A - 250 devices

Specifications

Catalog Number	V _{max} (Vdc)	I _{max} (A)	I _{hold} @+23 °C (A)	I _{trip} @+23 °C (A)	P _d Typ. (W)	Time to Trip (Max.)		Resistance (Ω)			Agency Information	
						(A)	(sec)	Initial (R _i)		Post Trip (R _t) Max.	cURus	TUV
								Min.	Max.			
PTR030V0090	30	40	0.90	1.80	0.6	4.50	5.90	0.070	0.120	0.22	X	X
PTR030V0110	30	40	1.10	2.20	0.7	5.50	6.60	0.050	0.100	0.17	X	X
PTR030V0135	30	40	1.35	2.70	0.8	6.75	7.30	0.040	0.080	0.13	X	X
PTR030V0160	30	40	1.60	3.20	0.9	8.00	8.00	0.030	0.070	0.11	X	X
PTR030V0185	30	40	1.85	3.70	1.0	9.25	8.70	0.030	0.060	0.09	X	X
PTR030V0250	30	40	2.50	5.00	1.2	12.50	10.30	0.020	0.040	0.07	X	X
PTR030V0300	30	40	3.00	6.00	2.0	15.00	10.80	0.020	0.050	0.08	X	X
PTR030V0400	30	40	4.00	8.00	2.5	20.00	12.70	0.010	0.030	0.05	X	X
PTR030V0500	30	40	5.00	10.00	3.0	25.00	14.50	0.010	0.030	0.05	X	X
PTR030V0600	30	100	6.00	12.00	3.5	30.00	16.00	0.005	0.020	0.04	X	X
PTR030V0700	30	100	7.00	14.00	3.8	35.00	17.50	0.005	0.020	0.03	X	X
PTR030V0800	30	100	8.00	16.00	4.0	40.00	18.80	0.005	0.013	0.02	X	X
PTR030V0900	30	100	9.00	18.00	4.2	45.00	20.00	0.005	0.010	0.02	X	X

Notes: I_{hold} – Hold current: Maximum current device will pass without interruption in +23 °C still air.
 I_{trip} – Trip current: Minimum current that will switch the device from low resistance to high resistance in +23 °C still air.
 V_{max}: Maximum continuous voltage device can withstand without damage at rated current.
 I_{max}: Maximum fault current device can withstand without damage at rated voltage.
 P_d: Power dissipated from device when in the tripped state in +23 °C still air.
 R_i (min.): Minimum resistance of device as supplied at +23 °C unless otherwise specified.
 R_i (max.): Maximum resistance of device as supplied at +23 °C unless otherwise specified.
 R_t (max.): Maximum resistance of device when measured one hour post reflow (SMD) or one hour post trip (radial-leaded device) at +23 °C unless otherwise specified.



Powering Business Worldwide

Dimensions - mm

Part Number	A Max.	B Max Lead Type		C	D Min.	E Max.	F	Figure/Lead Style	
		Straight (-TR)	Kink (-TR1)					Straight TR	Kink TR1
PTR030V0090	7.4	12.2	12.2	5.0±0.8	7.6	3.5	0.5±0.02	2	1
PTR030V0110	7.4	14.2	14.2	5.0±0.8	7.6	3.5	0.5±0.02	2	1
PTR030V0135	8.9	13.5	13.5	5.0±0.8	7.6	3.5	0.5±0.02	2	1
PTR030V0160	8.9	15.2	15.2	5.0±0.8	7.6	3.5	0.5±0.02	2	1
PTR030V0185	10.2	15.7	15.7	5.0±0.8	7.6	3.5	0.5±0.02	2	1
PTR030V0250	11.4	18.3	20.5	5.0±0.8	7.6	3.5	0.5±0.02	2	1
PTR030V0300	11.4	17.3	21.8	5.0±0.8	7.6	3.5	0.8±0.02	2	1
PTR030V0400	14.0	20.1	24.6	5.0±0.8	7.6	3.5	0.8±0.02	2	1
PTR030V0500	14.0	24.9	26.6	10.0±0.8	7.6	3.5	0.8±0.02	2	1
PTR030V0600	16.5	24.9	29.4	10.0±0.8	7.6	3.5	0.8±0.02	2	1
PTR030V0700	19.1	26.7	31.2	10.0±0.8	7.6	3.5	0.8±0.02	2	1
PTR030V0800	21.6	29.2	33.7	10.0±0.8	7.6	3.5	0.8±0.02	2	1
PTR030V0900	24.1	29.7	34.2	10.0±0.8	7.6	3.5	0.8±0.02	2	1

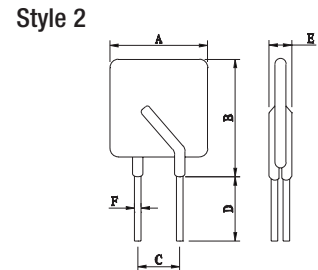
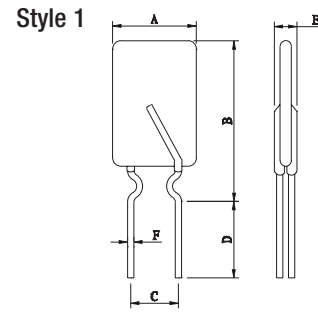

Packaging/Taping Specifications

Description	IEC Mark	Dimension (mm)	Tolerance (mm)
Sprocket hole pitch	P ₀	12.7	0.3
Ordinate to adjacent component lead PTR030V0090~PTR030V0300	P ₁	3.6	1.0
Ordinate to adjacent component lead PTR030V0400	P ₁	3.45	1.0
Ordinate to adjacent component lead PTR030V0500~PTR030V0900	P ₁	7.3	1.0
Device pitch PTR030V0090~PTR030V0300	P	12.7	1.0
Device pitch PTR030V0400~PTR030V0900	P	25.4	1.0
Lead spacing	C	*	--
Carrier tape width	W	18	1.0
Top distance between tape edges	W ₀	3.0	Max.
Hold-down tape width	W ₁	12	1.0
Sprocket hole position	W ₂	9.0	+0.75/-0.5
Abscissa to top PTR030V0090~PTR030V0300	H ₁	32.2	Max.
Abscissa to top PTR030V0400~PTR030V0900	H ₁	47.5	Max.
Abscissa to plane (straight lead)	H	18.0	+2/-0
Abscissa to plane (kinked lead)	H ₀	16.0	±0.5
Sprocket hole diameter	D ₀	4	±0.2
Lead protrusion	L ₁	1	Max.
Tape thickness	t	0.9	Max.
Body lateral deviation	Δ _h	0	±1.0
Body tape plane deviation	Δ _p	0	±0.13
Reel width	W ₃	56	Max.
Reel diameter		340	±10
Arbor hole diameter	n ₀	31	±1
Core diameter	n	80	Min.

* See Dimensions table.

Figure 1 - PTR030V0090-PTR030V0400

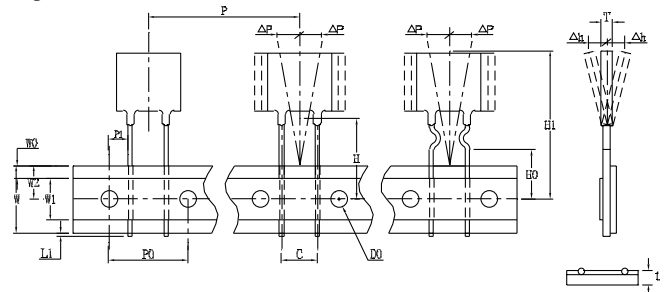
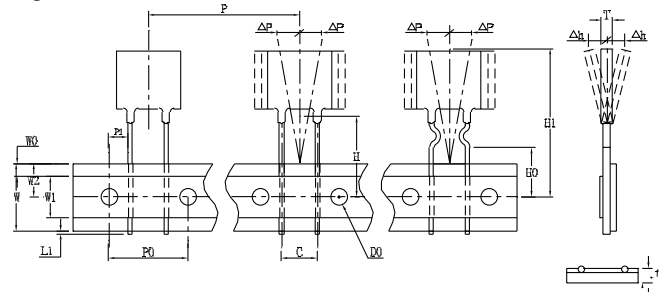
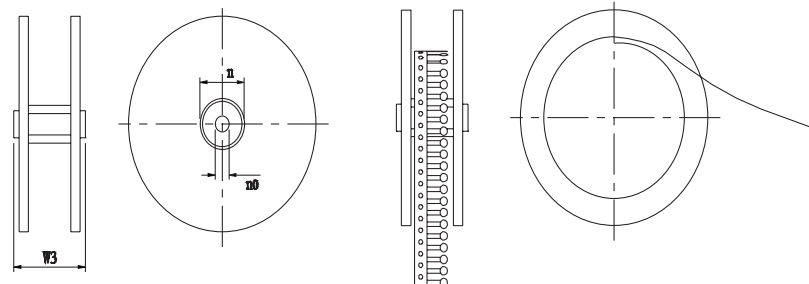

Figure 2 - PTR030V0500-PTR030V0900



Reel specification



Time-to-Trip Curves at +23 °C

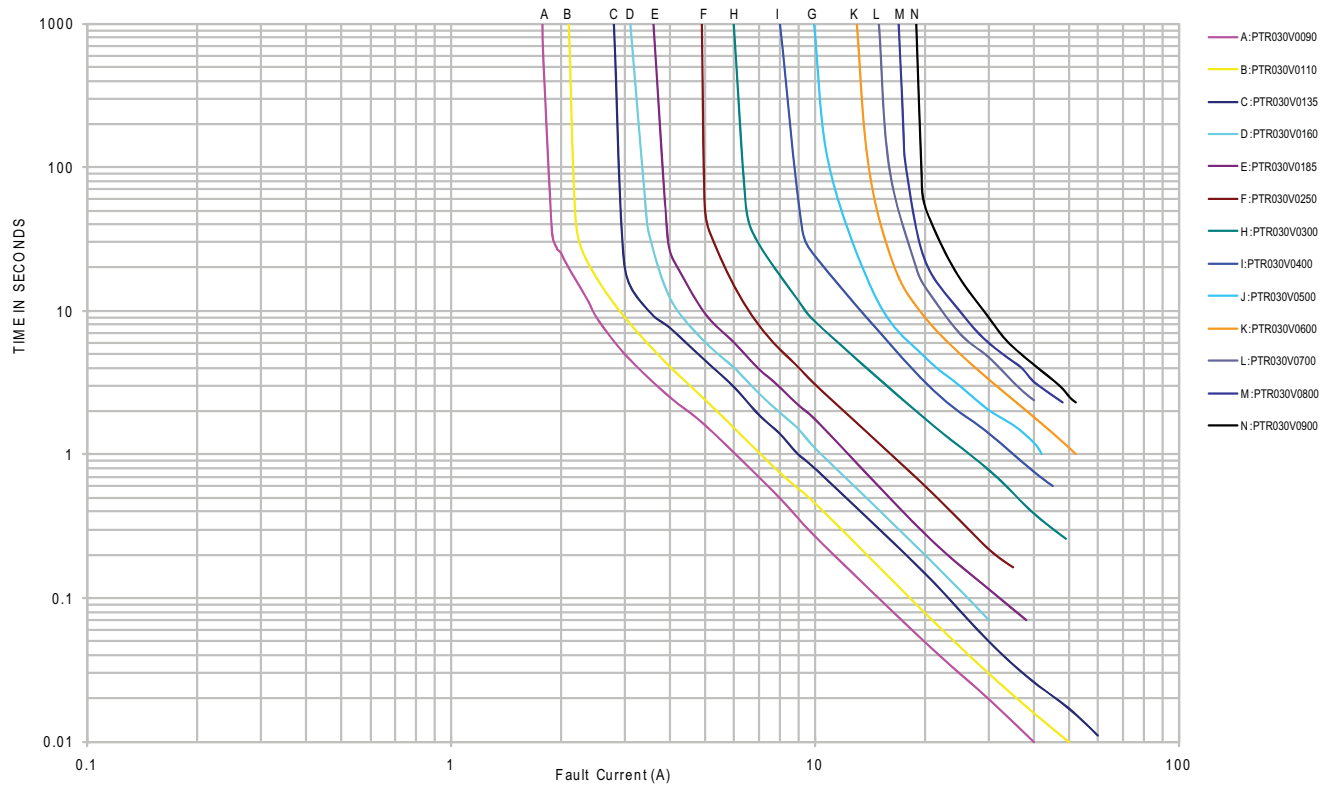

Thermal Derating Curve

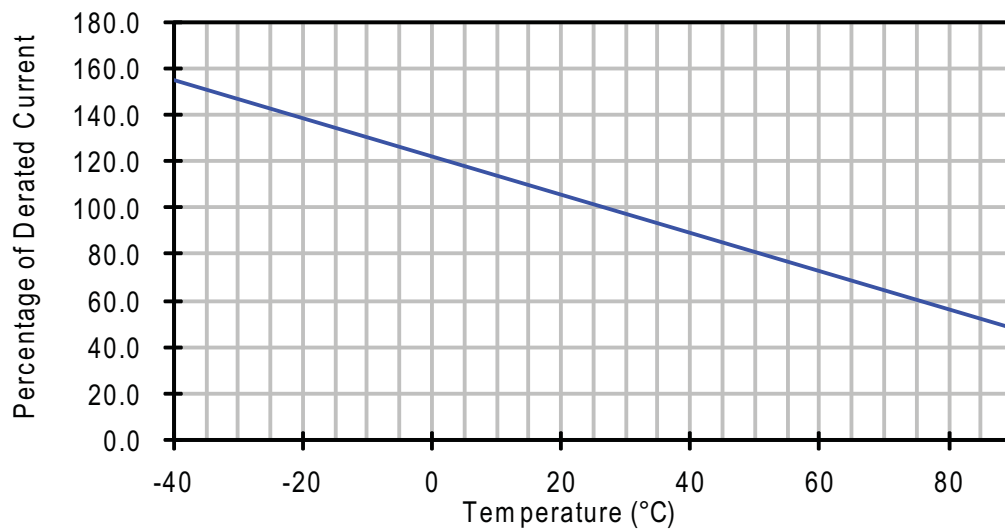

Recommended Wave Solder Profile.

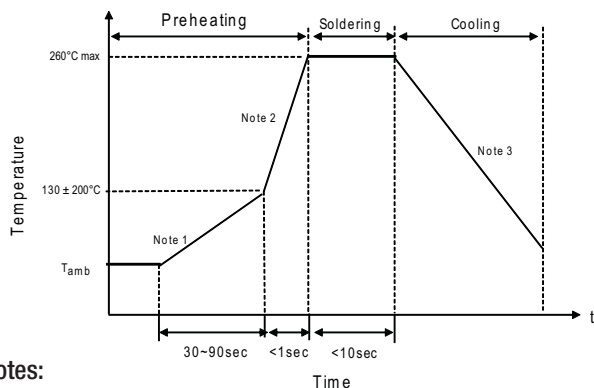

Notes:

- 1. (1-3) °C/sec
- 2. Approximately 200 °C/sec
- 3. 5 °C/sec Maximum

Recommended Reworking Conditions with Soldering Iron

- Soldering Iron Tip Temperature: +360 °C max.
- Solder Time: 3 seconds max.
- Distance from Thermistor: 2 mm min.

Environmental Specifications	
Characteristic	Value
Operating Temperature Range	-40 °C to +85 °C
Surface Temperature Trip State	+125 °C max.
Thermal Shock	+85 °C to -40 °C , 10 cycles, 5% typical resistance change
Solvent Resistance	MIL-STD-202 Method 215, no change
Humidity Age Test	+85 °C, 85% R.H., 1000 hours ±5% typical resistance change. Specified temperature (+23 °C ± 3 °C)
Storage Temperature Range	-10 °C to +40 °C
Storage Duration	One year
Storage Relative Humidity	≤75%
Storage Conditions	Keep away from corrosive atmosphere and sunlight

Material Composition

- Lead material:
 - PTR030V0090-PTR030V0250 Tin-plated copper clad steel
 - PTR030V0300-PTR030V0900 Tin-plated copper
- Insulating material: Cured epoxy resin meeting UL 94V0 requirements

Life Support Policy: Eaton does not authorize the use of any of its products for use in life support devices or systems without the express written approval of an officer of the Company. Life support systems are devices which support or sustain life, and whose failure to perform, when properly used in accordance with instructions for use provided in the labeling, can be reasonably expected to result in significant injury to the user.

Eaton reserves the right, without notice, to change design or construction of any products and to discontinue or limit distribution of any products. Eaton also reserves the right to change or update, without notice, any technical information contained in this bulletin.

Eaton
Electronics Division
 1000 Eaton Boulevard
 Cleveland, OH 44122
 United States
www.eaton.com/electronics

© 2017 Eaton
 All Rights Reserved
 Printed in USA
 Publication No. 4400 BU-SB11019
 October 2017



Eaton is a registered trademark.

All other trademarks are property of their respective owners.

X-ON Electronics

Largest Supplier of Electrical and Electronic Components

Click to view similar products for [Resettable Fuses - PPTC category](#):

Click to view products by [Eaton manufacturer](#):

Other Similar products are found below :

[0001.1010.G](#) [D38999/20WG39JN](#) [F02B250V1-4AS](#) [9728214S-2\(621\)](#) [RF0627-000](#) [RF2534-000](#) [ASMD185-2](#) [EN2997S61212AN](#)
[EN2997SE61203AN](#) [BK-ABC-V-5-R](#) [LR4-550RAF](#) [SMD125-2](#) [F60C500V20AS](#) [RF0078-000](#) [RF1548-000](#) [RF1973-000](#) [RF2171-000](#)
[RF2531-000](#) [RF2533-000](#) [RF2550-000](#) [TR600-150Q-B-0.5-0.130](#) [BK-AGX-20](#) [5E4795/04-1502](#) [EN2997S61212MN](#) [EN2997SE61203MN](#)
[EN2997SE61212AN](#) [EN2997SE61212MN](#) [BK1/S505-1.25-R](#) [TR-3216FF20-R](#) [TRF250-080T-B-1.0-0.125](#) [JT06RT1832BN014](#) [S-3-2-10](#)
[SMD100-2](#) [FRN-R-5-6-10](#) [FRS-R-3-2-10](#) [LP-CC-2-1-2](#) [LPS-RK-3-2-10SP](#) [BK-AGC-1-8-R](#) [BK-AGC-2-10-R](#) [BK-AGC-7-1-2](#) [BK-GDC-](#)
[500MA](#) [BK-MDL-1-6-10-R](#) [BK-SFE-4](#) [BK-ABC-1-R](#) [BK-C518-250-R](#) [BK-GDB-2A](#) [BK-MDL-1-8-R](#) [BK-MDL-6](#) [BK-AGC-5-R](#) [BK-ATC-](#)