

# SD

## Low profile metalized shielded drum core power inductors

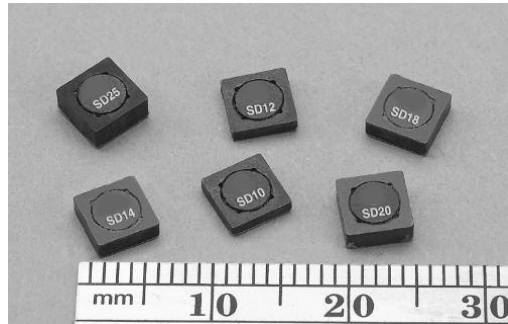

### Product features

- Six sizes of shielded drum core inductors with low profiles (as low as 1.0mm) and high power density
- Inductance range from .47 uH to 1000 uH
- Current range from 0.88 A to 6.0 A
- Ferrite shielded, low EMI
- Ferrite core material

### Applications

- Digital cameras
- Media players
- Mobile phones
- Hand held equipment
- PCMCIA cards
- GPS systems

### Environmental data

- Storage temperature range (component): -40 °C to +125 °C
- Operating temperature range: -40 °C to +125 °C (ambient plus self-temperature rise)
- Solder reflow temperature: J-STD-020 (latest revision) compliant



**Product specifications**

Part Number	Rated Inductance (µH)	OCL (1) +/-20% (µH)	Part Marking	I <sub>rms</sub> (2) (A)	I <sub>sat</sub> (3) (A)	DCR (4) (Ω) Typ.	Volt u-sec Typ.
SD10-R47-R	0.470	0.453	A	2.59	3.54	0.0249	2.1
SD10-1R0-R	1.00	1.119	B	1.93	2.25	0.0448	3.3
SD10-1R5-R	1.50	1.563	C	1.60	1.91	0.0653	3.9
SD10-2R2-R	2.20	2.081	D	1.35	1.65	0.0912	4.5
SD10-3R3-R	3.30	3.339	E	1.24	1.31	0.1078	5.7
SD10-4R7-R	4.70	4.893	F	1.04	1.08	0.1535	6.9
SD10-6R2-R	6.20	6.743	G	0.94	0.92	0.218	8.1
SD10-8R2-R	8.20	8.889	H	0.800	0.800	0.2607	9.3
SD10-100-R	10.0	10.07	J	0.760	0.752	0.336	9.9
SD10-150-R	15.0	15.55	K	0.613	0.605	0.4429	12.3
SD10-220-R	22.0	22.21	L	0.498	0.506	0.6718	14.7
SD10-330-R	33.0	32.20	M	0.412	0.420	0.9807	17.7
SD10-470-R	47.0	46.63	N	0.337	0.349	1.47	21.3
SD10-680-R	68.0	70.01	O	0.301	0.285	1.84	26.1
SD10-820-R	82.0	83.48	P	0.258	0.261	2.50	28.5
SD10-101-R	100	102.0	Q	0.225	0.236	3.29	31.5
SD10-151-R	150	149.2	R	0.200	0.195	4.15	38.1
SD10-221-R	220	222.2	S	0.161	0.160	6.41	46.5
SD10-331-R	330	330.4	T	0.130	0.131	9.83	56.7
SD10-471-R	470	468.3	U	0.117	0.110	12.10	67.5
SD12-R47-R	0.470	0.490	A	3.19	3.86	0.0246	2.84
SD12-1R2-R	1.20	1.21	B	2.62	2.45	0.0366	4.47
SD12-1R5-R	1.50	1.69	C	2.19	2.08	0.0521	5.28
SD12-2R2-R	2.20	2.25	D	1.83	1.80	0.0747	6.09
SD12-3R3-R	3.30	3.61	E	1.55	1.42	0.1043	7.71
SD12-4R7-R	4.70	4.41	F	1.46	1.29	0.1177	8.53
SD12-6R2-R	6.20	6.25	G	1.21	1.08	0.1699	10.15
SD12-8R2-R	8.20	8.41	H	1.02	0.931	0.2399	11.77
SD12-100-R	10.0	10.89	J	0.938	0.818	0.2844	13.40
SD12-150-R	15.0	15.21	K	0.782	0.692	0.4089	15.83
SD12-220-R	22.0	22.09	L	0.628	0.574	0.6338	19.08
SD12-330-R	33.0	32.49	M	0.519	0.474	0.9289	23.14
SD12-470-R	47.0	47.61	N	0.428	0.391	1.37	28.01
SD12-680-R	68.0	68.89	O	0.341	0.325	2.16	33.70
SD12-820-R	82.0	82.81	P	0.326	0.297	2.36	36.95
SD12-101-R	100	98.0	Q	0.308	0.273	2.64	40.19
SD12-151-R	150	151.3	R	0.251	0.220	3.96	49.94
SD12-221-R	220	222.0	S	0.229	0.181	4.76	60.49
SD12-331-R	330	334.9	T	0.186	0.148	7.25	74.30
SD12-471-R	470	462.3	U	0.167	0.126	8.95	87.29
SD12-681-R	680	670.8	V	0.149	0.104	11.30	105
SD12-821-R	820	800.9	W	0.129	0.095	14.93	115
SD12-102-R	1000	992.3	X	0.121	0.086	17.20	128

(1) Open Circuit Inductance Test Parameters: 100 kHz, 0.25 V<sub>rms</sub>, 0.0 Adc.

(2) RMS current for an approximate ΔT of 40 °C without core loss. It is recommended that the temperature of the part not exceed +125 °C.

(3) SD10,12,18,25 Peak current for approximate 30% rolloff at +20 °C.  
SD14 Peak current for approximate 20% roll off at +20 °C.

(4) DCR limits @ +20 °C.

(5) Applied Volt-Time product (V-us) across the inductor at 100 kHz necessary to generate a core loss equal to 10% of the total losses for 40 °C temperature rise.

Product specifications

Part Number	Rated Inductance (μH)	OCL (1) +/-20% (μH)	Part Marking	I <sub>rms</sub> (2) (A)	I <sub>sat</sub> (3) (A)	DCR (4) (Ω) Typ.	Volt u-sec Typ.
SD14-R58-R	0.58	0.61	A	3.52	4.84	0.0220	3.38
SD14-R87-R	0.87	0.88	B	3.2	3.96	0.0243	4.13
SD14-1R2-R	1.2	1.23	C	2.7	3.35	0.0344	4.88
SD14-1R5-R	1.5	1.63	D	2.53	2.91	0.0390	5.63
SD14-2R0-R	2	2.09	E	2.37	2.56	0.0445	6.38
SD14-2R5-R	2.5	2.62	F	2.05	2.29	0.0595	7.1
SD14-3R2-R	3.2	3.19	G	1.94	2.08	0.0663	7.9
SD14-4R5-R	4.5	4.53	H	1.64	1.74	0.0935	9.4
SD14-6R9-R	6.9	6.98	J	1.35	1.41	0.1363	11.6
SD14-8R8-R	8.8	8.88	K	1.14	1.25	0.1913	13.1
SD14-100-R	10	9.93	L	1.1	1.18	0.2058	13.9
SD14-150-R	15	14.68	M	0.98	0.969	0.2609	16.9
SD14-220-R	22	21.93	N	0.806	0.793	0.3853	20.6
SD14-330-R	33	32.55	O	0.654	0.651	0.5852	25.1
SD14-470-R	47	47.57	P	0.525	0.538	0.9055	30.4
SD14-680-R	68	68.21	Q	0.474	0.449	1.11	36
SD14-820-R	82	83	R	0.408	0.407	1.50	40
SD14-101-R	100	99.25	S	0.386	0.373	1.68	44
SD14-151-R	150	152.4	T	0.315	0.301	2.52	54
SD14-221-R	220	222	U	0.258	0.249	3.77	66
SD14-331-R	330	335.1	V	0.206	0.203	5.92	81
SD14-471-R	470	471.4	W	0.173	0.171	8.34	96
SD14-681-R	680	683.3	X	0.156	0.142	10.3	115
SD14-821-R	820	823.4	Y	0.134	0.129	13.9	126
SD14-102-R	1000	1008	Z	0.126	0.117	15.8	140
SD18-R47-R	0.47	0.49	A	3.58	4.63	0.0201	2.35
SD18-R82-R	0.82	0.81	B	3.24	3.60	0.0247	3.02
SD18-1R2-R	1.20	1.21	C	2.97	2.95	0.0294	3.70
SD18-1R5-R	1.50	1.69	D	2.73	2.49	0.0345	4.37
SD18-2R2-R	2.20	2.25	E	2.55	2.16	0.0398	5.04
SD18-3R3-R	3.30	3.61	F	2.07	1.71	0.0605	6.38
SD18-4R7-R	4.70	4.41	G	1.77	1.54	0.0824	7.06
SD18-6R2-R	6.20	6.25	H	1.61	1.30	0.1000	8.40
SD18-8R2-R	8.20	8.41	J	1.38	1.12	0.1351	9.74
SD18-100-R	10.0	10.89	K	1.28	0.982	0.1584	11.09
SD18-150-R	15.0	15.21	L	1.06	0.831	0.2278	13.10
SD18-220-R	22.0	22.09	M	0.876	0.689	0.3366	15.79
SD18-330-R	33.0	32.49	N	0.715	0.568	0.5057	19.15
SD18-470-R	47.0	47.61	O	0.578	0.470	0.7732	23.18
SD18-680-R	68.0	68.89	P	0.514	0.390	0.9798	27.89
SD18-820-R	82.0	82.81	Q	0.446	0.356	1.30	30.58
SD18-101-R	100	102.01	R	0.419	0.321	1.47	33.94
SD18-151-R	150	151.29	S	0.345	0.263	2.18	41.33
SD18-221-R	220	222.01	T	0.296	0.217	2.95	50.06
SD18-331-R	330	334.89	U	0.248	0.177	4.20	61.49
SD18-471-R	470	479.61	V	0.201	0.148	6.39	73.58
SD18-681-R	680	681.21	W	0.167	0.124	9.28	87.70
SD18-821-R	820	823.69	X	0.145	0.113	12.35	96.43
SD18-102-R	1000	1004	Y	0.136	0.102	14.01	107

(1) Open Circuit Inductance Test Parameters: 100 kHz, 0.25 V<sub>rms</sub>, 0.0 Adc.

(2) RMS current for an approximate ΔT of 40 °C without core loss. It is recommended that the temperature of the part not exceed +125 °C.

(3) SD10,12,18,25 Peak current for approximate 30% rolloff at +20 °C.  
SD14 Peak current for approximate 20% roll off at +20 °C.

(4) DCR limits @ +20 °C.

5) Applied Volt-Time product (V-us) across the inductor at 100 kHz necessary to generate a core loss equal to 10% of the total losses for 40 °C temperature rise.

**Product specifications**

Part Number	Rated Inductance (μH)	OCL (1) +/-20% (μH)	Part Marking	I <sub>rms</sub> (2) Amperes	I <sub>sat</sub> (3) Amperes	DCR (4) (Ω) Typ.	Volt u-sec Typ.
SD20-R47-R	0.47	0.490	A	3.59	4.00	0.0200	2.28
SD20-1R2-R	1.20	1.21	B	3.07	2.55	0.0275	3.58
SD20-1R5-R	1.50	1.69	C	2.88	2.15	0.0312	4.23
SD20-2R2-R	2.20	2.25	D	2.45	1.87	0.0429	4.88
SD20-3R3-R	3.30	3.61	E	2.17	1.47	0.0547	6.18
SD20-4R7-R	4.70	4.41	F	2.05	1.33	0.0612	6.83
SD20-6R2-R	6.20	6.25	G	1.89	1.12	0.0720	8.13
SD20-8R2-R	8.20	8.41	H	1.61	0.966	0.1000	9.43
SD20-100-R	10.0	9.61	J	1.53	0.903	0.1100	10.08
SD20-150-R	15.0	15.21	K	1.25	0.718	0.1655	12.68
SD20-220-R	22.0	22.09	L	1.12	0.596	0.2053	15.28
SD20-330-R	33.0	32.49	M	0.913	0.491	0.3100	18.53
SD20-470-R	47.0	47.61	N	0.745	0.406	0.4650	22.43
SD20-680-R	68.0	68.89	O	0.610	0.337	0.6947	26.98
SD20-820-R	82.0	82.81	P	0.576	0.308	0.7785	29.58
SD20-101-R	100	98.01	Q	0.495	0.283	1.06	32.18
SD20-151-R	150	151.3	R	0.435	0.228	1.37	39.98
SD20-221-R	220	222.0	S	0.356	0.188	2.04	48.43
SD20-331-R	330	327.6	T	0.294	0.155	2.99	58.83
SD20-471-R	470	470.9	U	0.263	0.129	3.74	70.53
SD20-681-R	680	681.2	V	0.216	0.107	5.56	84.83
SD20-821-R	820	823.7	W	0.204	0.098	6.22	93.28
SD20-102-R	1000	1004.9	X	0.172	0.088	8.73	103
SD25-R47-R	0.47	0.466	A	3.88	6.00	0.0177	2.13
SD25-R82-R	0.82	0.770	B	3.58	4.67	0.0208	2.74
SD25-1R2-R	1.20	1.15	C	3.33	3.81	0.0240	3.34
SD25-1R5-R	1.50	1.61	D	3.12	3.23	0.0274	3.95
SD25-2R2-R	2.20	2.14	E	2.93	2.80	0.0311	4.56
SD25-3R3-R	3.30	3.43	F	2.64	2.21	0.0384	5.78
SD25-4R7-R	4.70	5.03	G	2.39	1.83	0.0467	6.99
SD25-6R8-R	6.80	6.93	H	2.19	1.56	0.0556	8.21
SD25-8R2-R	8.20	7.99	J	1.92	1.45	0.0724	8.82
SD25-100-R	10.0	10.35	K	1.80	1.27	0.0824	10.03
SD25-150-R	15.0	14.45	L	1.67	1.08	0.0956	11.86
SD25-220-R	22.0	22.81	M	1.34	0.857	0.1478	14.90
SD25-330-R	33.0	33.07	N	1.11	0.711	0.2149	17.94
SD25-470-R	47.0	47.89	O	0.919	0.592	0.3156	21.58
SD25-680-R	68.0	68.64	P	0.741	0.482	0.4850	25.84
SD25-820-R	82.0	82.17	Q	0.713	0.441	0.5242	28.27
SD25-101-R	100	100.79	R	0.670	0.398	0.5937	31.31
SD25-151-R	150	148.4	S	0.553	0.328	0.8723	38.00
SD25-221-R	220	222.4	T	0.446	0.268	1.34	46.51
SD25-331-R	330	332.2	U	0.359	0.219	2.07	56.85
SD25-471-R	470	472.4	V	0.293	0.184	3.10	67.79
SD25-681-R	680	677.2	W	0.262	0.154	3.88	81.17
SD25-821-R	820	826.7	X	0.230	0.139	5.04	89.68
SD25-102-R	1000	1003.4	Y	0.216	0.126	5.70	98.80

(1) Open Circuit Inductance Test Parameters: 100 kHz, 0.25 Vrms, 0.0 Adc.

(2) RMS current for an approximate ΔT of 40 °C without core loss. It is recommended that the temperature of the part not exceed +125 °C.

(3) SD10,12,18,25 Peak current for approximate 30% roll off at +20 °C.  
SD14 Peak current for approximate 20% roll off at +20 °C.

(4) DCR limits @ +20 °C.

5) Applied Volt-Time product (V-us) across the inductor at 100 kHz necessary to generate a core loss equal to 10% of the total losses for 40 °C temperature rise.

Dimensions-mm

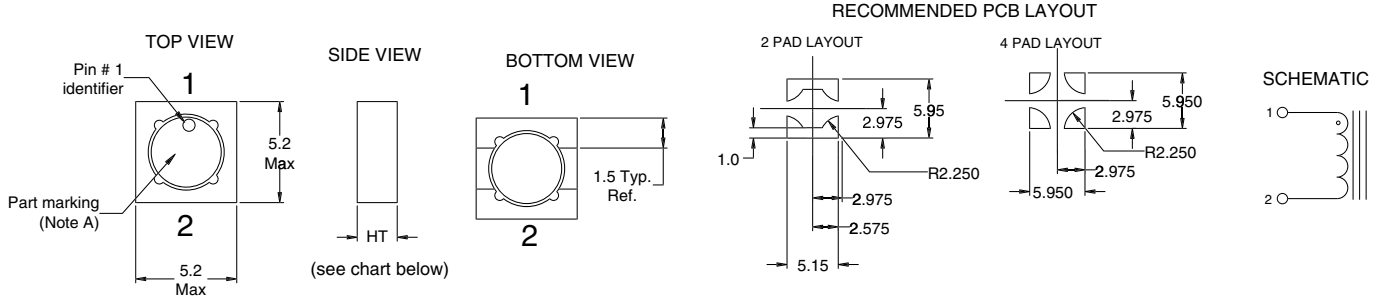

Series	HT
SD10	1.0mm max
SD12	1.2mm max
SD14	1.45mm max
SD18	1.8mm max
SD20	2.0mm max
SD25	2.5mm max

A) Part Marking: Line 1: (1st digit indicates the inductance value per part marking designator in chart above)  
(2nd digit is a bi-weekly production date code)  
(3rd digit is the last digit of the year produced)  
Line 2: XX (indicates the product size code)  
Do not route traces or vias underneath the inductor

Packaging Information

SD10

A0=5.45mm  
Bo=5.45mm  
Ko=1.20mm

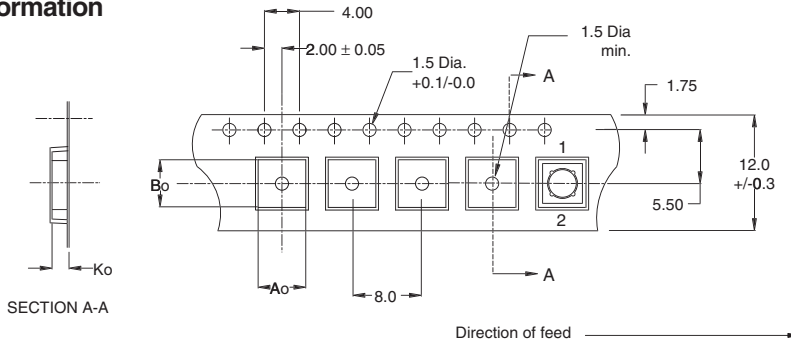

ACTUAL SIZE  
SD10

Parts packaged on 13" Diameter reel,  
3,800 parts per reel.

SD12/14/18

A0=5.45mm  
Bo=5.45mm  
Ko=2.00mm

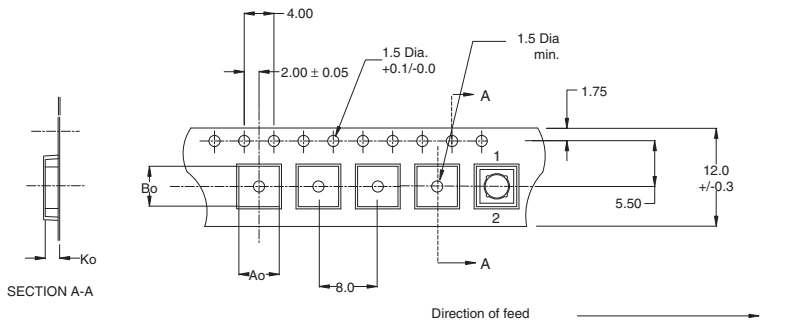

ACTUAL SIZE  
SD12

ACTUAL SIZE  
SD14

ACTUAL SIZE  
SD18

Parts packaged on 13" Diameter reel,  
3,800 parts per reel.

SD20/25

A0=5.45mm  
Bo=5.45mm  
Ko=2.70mm

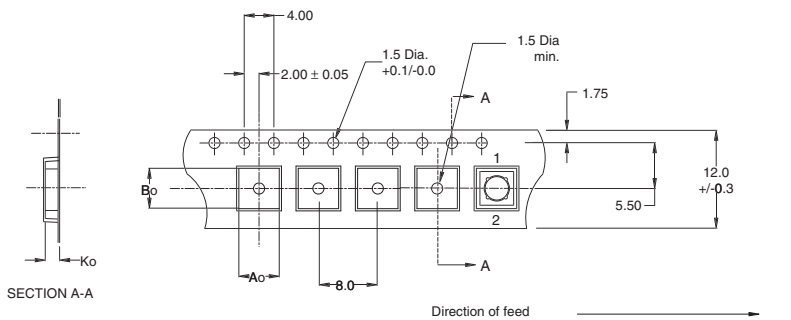

ACTUAL SIZE  
SD20

ACTUAL SIZE  
SD25

Parts packaged on 13" Diameter reel,  
2,900 parts per reel.

Dimensions are in millimeters.

Temperature rise vs current

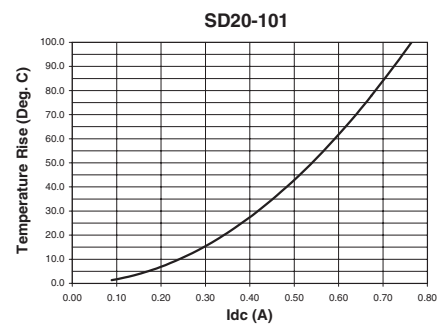
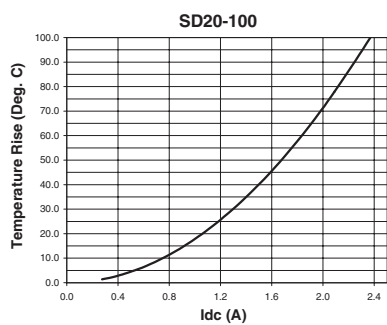
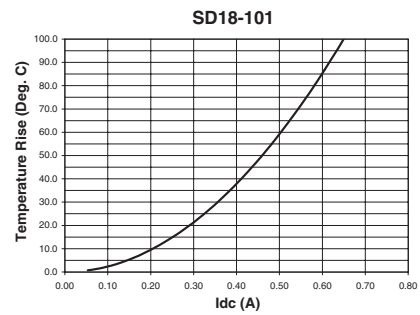
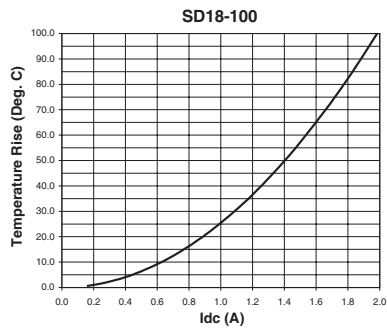
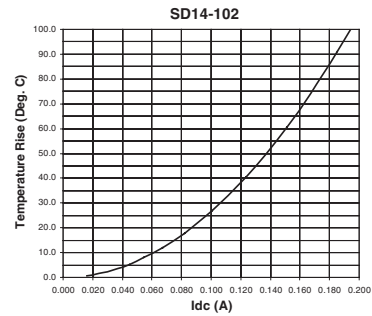
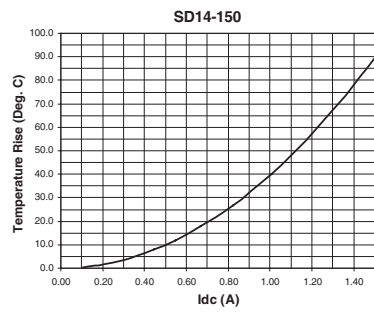
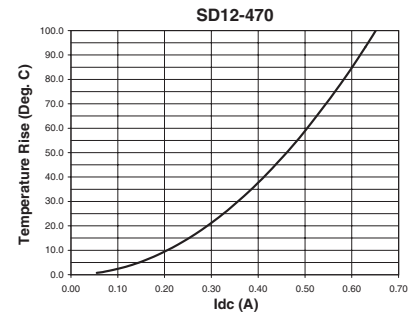
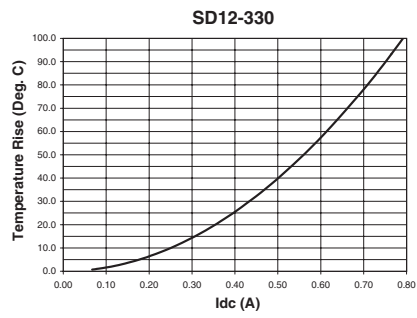
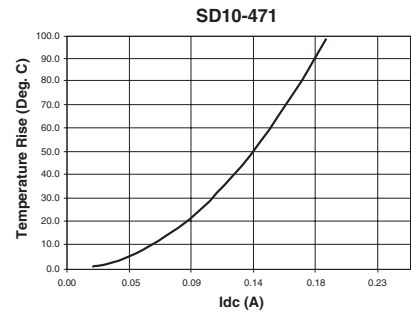
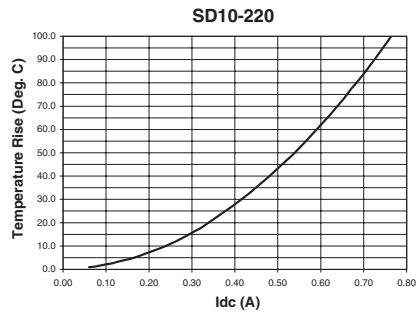

Temperature rise vs current

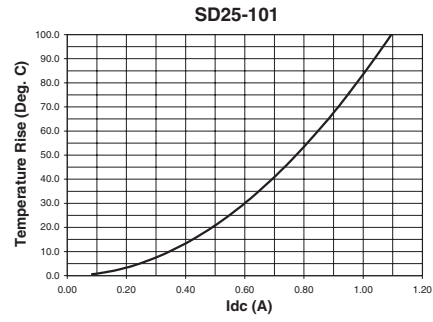
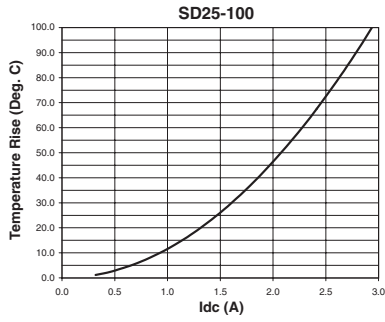

Inductance Characteristics

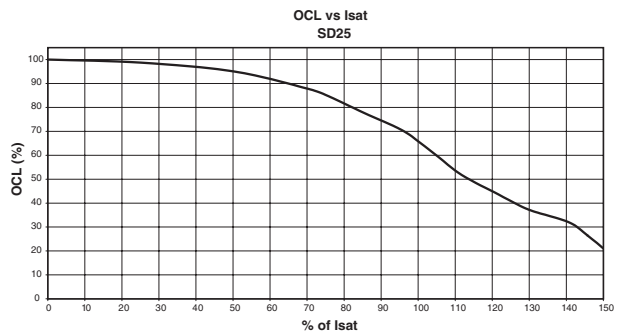
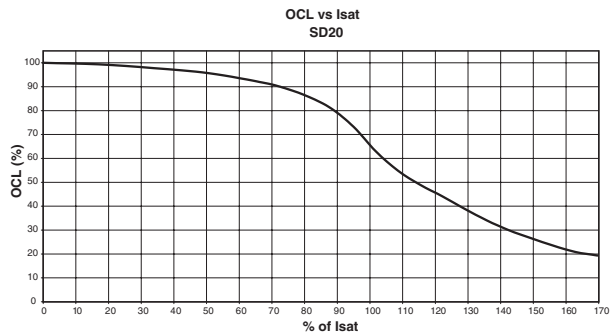
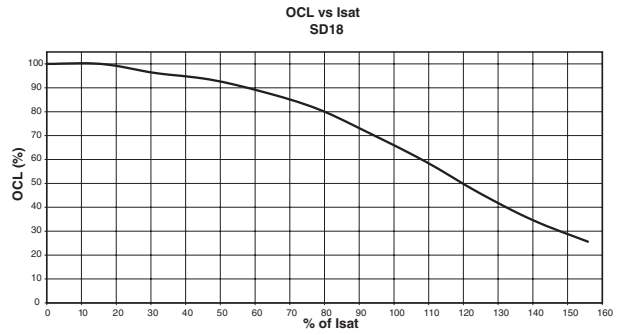
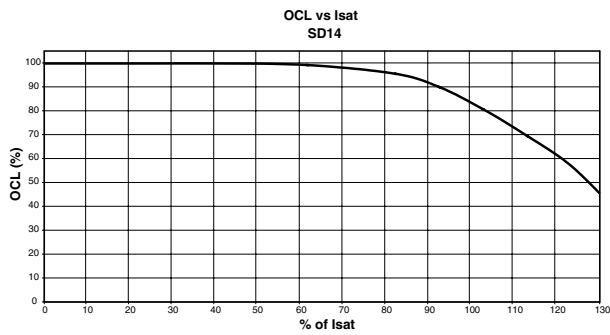
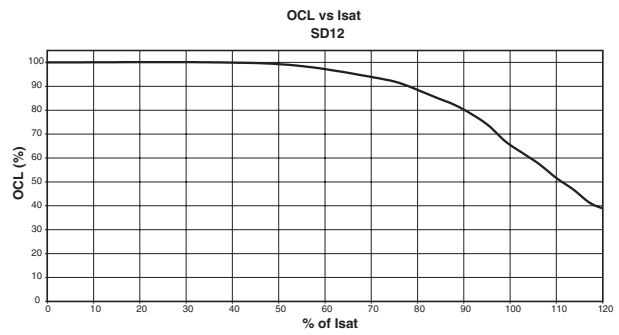
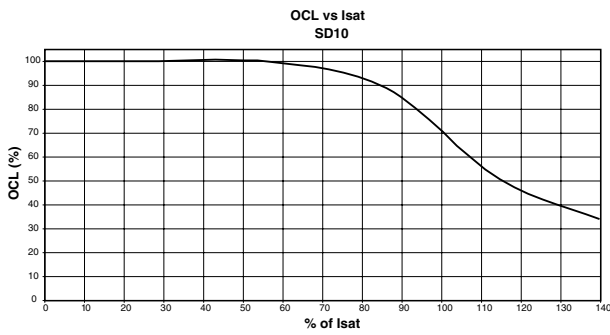

**Core loss**

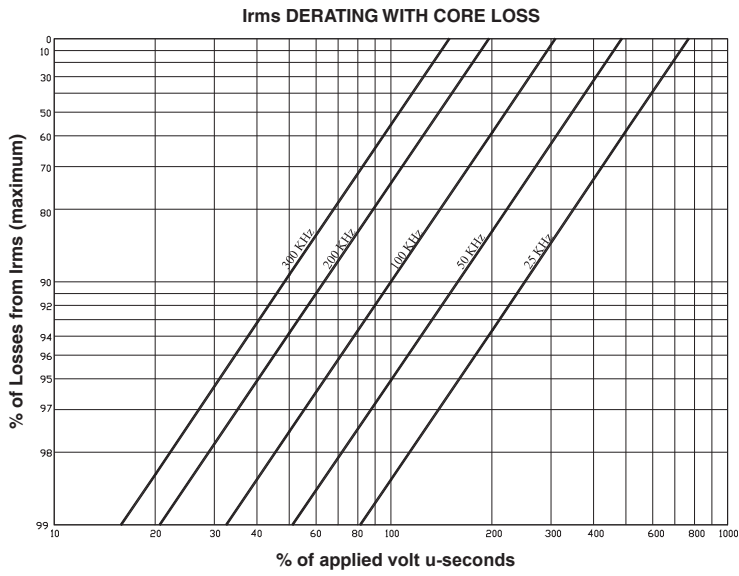



**Solder Reflow Profile**

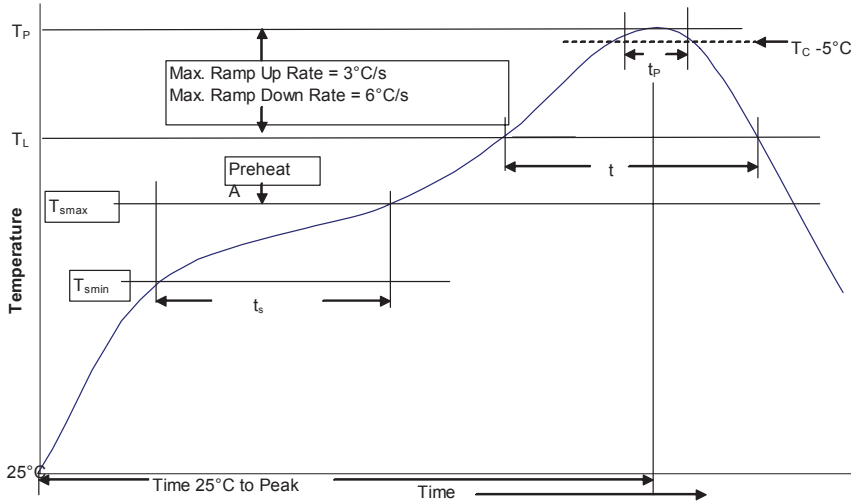

**Table 1 - Standard SnPb Solder ( $T_C$ )**

Package Thickness	Volume $\text{mm}^3$ <350	Volume $\text{mm}^3$ $\geq 350$
<2.5mm	235°C	220°C
$\geq 2.5\text{mm}$	220°C	220°C

**Table 2 - Lead (Pb) Free Solder ( $T_C$ )**

Package Thickness	Volume $\text{mm}^3$ <350	Volume $\text{mm}^3$ 350 - 2000	Volume $\text{mm}^3$ >2000
<1.6mm	260°C	260°C	260°C
1.6 – 2.5mm	260°C	250°C	245°C
>2.5mm	250°C	245°C	245°C

**Reference JDEC J-STD-020**

Profile Feature	Standard SnPb Solder	Lead (Pb) Free Solder
Preheat and Soak		
• Temperature min. ( $T_{smin}$ )	100°C	150°C
• Temperature max. ( $T_{smax}$ )	150°C	200°C
• Time ( $T_{smin}$ to $T_{smax}$ ) ( $t_s$ )	60-120 Seconds	60-120 Seconds
Average ramp up rate $T_{smax}$ to $T_p$	3°C/ Second Max.	3°C/ Second Max.
Liquidous temperature ( $T_L$ )	183°C	217°C
Time at liquidous ( $t_l$ )	60-150 Seconds	60-150 Seconds
Peak package body temperature ( $T_p$ )*	Table 1	Table 2
Time ( $t_p$ )** within 5 °C of the specified classification temperature ( $T_C$ )	20 Seconds**	30 Seconds**
Average ramp-down rate ( $T_p$ to $T_{smax}$ )	6°C/ Second Max.	6°C/ Second Max.
Time 25°C to Peak Temperature	6 Minutes Max.	8 Minutes Max.

\* Tolerance for peak profile temperature ( $T_p$ ) is defined as a supplier minimum and a user maximum.

\*\* Tolerance for time at peak profile temperature ( $t_p$ ) is defined as a supplier minimum and a user maximum.

Life Support Policy: Eaton does not authorize the use of any of its products for use in life support devices or systems without the express written approval of an officer of the Company. Life support systems are devices which support or sustain life, and whose failure to perform, when properly used in accordance with instructions for use provided in the labeling, can be reasonably expected to result in significant injury to the user.

Eaton reserves the right, without notice, to change design or construction of any products and to discontinue or limit distribution of any products. Eaton also reserves the right to change or update, without notice, any technical information contained in this bulletin.

**Eaton**  
Electronics Division  
1000 Eaton Boulevard  
Cleveland, OH 44122  
United States  
www.eaton.com/electronics

© 2017 Eaton  
All Rights Reserved  
Printed in USA  
Publication No. PM4311  
August 2017

## X-ON Electronics

Largest Supplier of Electrical and Electronic Components

*Click to view similar products for [Fixed Inductors](#) category:*

*Click to view products by [Eaton](#) manufacturer:*

Other Similar products are found below :

[CR43NP-680KC](#) [CR54NP-820KC](#) [CR54NP-8R5MC](#) [CTX32CT-100](#) [70F224AI](#) [MGDQ4-00004-P](#) [MHL1ECTTP18NJ](#) [MHL1JCTTD12NJ](#)  
[PE-51506NL](#) [PE-53601NL](#) [PE-53602NL](#) [PE-53630NL](#) [PE-53824SNLT](#) [PE-92100NL](#) [PG0434.801NLT](#) [PG0936.113NLT](#) [9310-16](#) [PM06-2N7](#) [PM06-39NJ](#) [A01TK](#) [1206CS-471XJ](#) [HC2-2R2TR](#) [HC2LP-R47-R](#) [HC3-2R2-R](#) [1206CS-151XG](#) [RCH664NP-140L](#) [RCH664NP-4R7M](#)  
[RCH8011NP-221L](#) [RCP1317NP-332L](#) [RCP1317NP-391L](#) [RCR1010NP-470M](#) [RCR110DNP-331L](#) [DH2280-4R7M](#) [DS1608C-106](#) [ASPI-4020HI-R10M-T](#) [B10TJ](#) [B82477P4333M](#) [B82498B3101J000](#) [B82498B3680J000](#) [ELJ-RE27NJF2](#) [1812CS-153XJ](#) [1812CS-183XJ](#) [1812CS-223XJ](#) [1812LS-104XJ](#) [1812LS-105XJ](#) [1812LS-124XJ](#) [1812LS-154XJ](#) [1812LS-223XJ](#) [1812LS-224XJ](#) [1812LS-563XJ](#)