

SDCH1V60

Semi-shielded power inductors

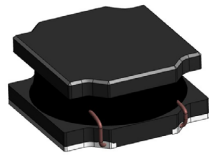

Product features

- High current carrying capacity
- High power density, low core losses
- Magnetically semi-shielded
- 6.2 mm x 6.2 mm surface mount package in 3.0 mm and 4.5 mm heights
- NiZn ferrite magnetic material
- Moisture sensitivity level (MSL): 1

Applications

- DC-DC converters
- Switching controllers
- Industrial IoT equipment
- Game consoles
- Portable electronics
- Laptops, notebooks, and netbooks
- Desktops and workstations
- Battery backup
- LED lighting
- HD televisions and displays

Environmental compliance and general specifications

- Storage temperature range (component): -40 °C to +125 °C
- Operating temperature range: -40 °C to +125 °C (ambient plus self-temperature rise)
- Solder reflow temperature: J-STD-020 (latest revision) compliant



Product specifications

Part number ⁵	OCL ¹ (μ H)	FLL ² (μ H) minimum	I _{FRMS} ³ (A)	I _{PKT} ⁴ (A)	DCR (m Ω) @ +20 °C nominal	DCR (m Ω) @ +20 °C maximum
SDCH1V6028						
SDCH1V6028-1R0N-R	1.0 \pm 30%	0.46	5.7	8.5	16	20
SDCH1V6028-1R5N-R	1.5 \pm 30%	0.68	5.3	7.0	18	21
SDCH1V6028-2R2M-R	2.2 \pm 20%	1.14	4.5	6.0	22	25
SDCH1V6028-3R3M-R	3.3 \pm 20%	1.72	3.5	4.5	29	33
SDCH1V6028-4R7M-R	4.7 \pm 20%	2.44	3.1	4.0	43	49
SDCH1V6028-6R8M-R	6.8 \pm 20%	3.54	2.4	3.5	57	66
SDCH1V6028-100M-R	10 \pm 20%	5.2	2.0	2.8	72	83
SDCH1V6028-150M-R	15 \pm 20%	7.8	1.8	2.5	102	117
SDCH1V6028-220M-R	22 \pm 20%	11.44	1.4	1.9	150	173
SDCH1V6028-330M-R	33 \pm 20%	17.16	1.3	1.5	210	242
SDCH1V6028-470M-R	47 \pm 20%	24.44	1.1	1.4	360	410
SDCH1V6028-680M-R	68 \pm 20%	35.36	0.85	1.0	400	460
SDCH1V6028-101M-R	100 \pm 20%	52.0	0.75	0.85	620	713
SDCH1V6028-221M-R	220 \pm 20%	114.4	0.5	0.55	1300	1495
SDCH1V6028-331M-R	330 \pm 20%	171.6	0.45	0.5	1900	2185
SDCH1V6028-471M-R	470 \pm 20%	244.4	0.34	0.35	2400	2760
SDCH1V6028-681M-R	680 \pm 20%	353.6	0.3	0.32	4300	4945
SDCH1V6028-821M-R	820 \pm 20%	426.4	0.25	0.26	4500	5175
SDCH1V6028-102M-R	1000 \pm 20%	520.0	0.24	0.25	6000	6900
SDCH1V6045						
SDCH1V6045-1R0N-R	1.0 \pm 30%	0.46	6.0	12.8	12	15
SDCH1V6045-1R5N-R	1.5 \pm 30%	0.68	4.9	11.5	16	19
SDCH1V6045-2R2M-R	2.2 \pm 20%	1.14	4.5	9.0	19	22
SDCH1V6045-3R3M-R	3.3 \pm 20%	1.72	4.0	8.5	23	26
SDCH1V6045-4R7M-R	4.7 \pm 20%	2.44	3.6	6.7	31	36
SDCH1V6045-6R8M-R	6.8 \pm 20%	3.54	2.8	5.3	45	52
SDCH1V6045-100M-R	10 \pm 20%	5.2	2.4	4.5	58	67
SDCH1V6045-150M-R	15 \pm 20%	7.8	2.1	3.6	80	92
SDCH1V6045-220M-R	22 \pm 20%	11.44	1.6	3.0	125	144
SDCH1V6045-330M-R	33 \pm 20%	17.16	1.4	2.3	175	201
SDCH1V6045-470M-R	47 \pm 20%	24.44	1.1	2.1	260	299
SDCH1V6045-680M-R	68 \pm 20%	35.36	0.95	1.8	355	408
SDCH1V6045-101M-R	100 \pm 20%	52.0	0.8	1.45	550	633
SDCH1V6045-221M-R	220 \pm 20%	114.4	0.46	0.9	1500	1725
SDCH1V6045-331M-R	330 \pm 20%	171.6	0.4	0.8	2000	2300
SDCH1V6045-471M-R	470 \pm 20%	244.4	0.35	0.7	2500	2875
SDCH1V6045-681M-R	680 \pm 20%	353.6	0.28	0.58	4000	4600
SDCH1V6045-821M-R	820 \pm 20%	426.4	0.25	0.5	5200	5980
SDCH1V6045-102M-R	1000 \pm 20%	520.0	0.23	0.45	6000	6900

1. Open circuit inductance (OCL) test parameters: 100 kHz, 0.25 Vrms, 0.0 Adc, +25 °C

2. Full load inductance (FLL) test parameters: 100 kHz, 0.25 Vrms, I_{sat}, +25 °C

3. I_{FRMS}: DC current for an approximate temperature rise of 40 °C without core loss. Derating is necessary for AC currents. PCB layout, trace thickness and width, air-flow, and proximity of other heat generating components will affect the temperature rise. It is recommended that the temperature of the part not exceed +125 °C under worst case operating conditions verified in the end application.

4. I_{PKT}: Peak current for approximately 35% maximum rolloff @ +25 °C

5. Part number definition: SDCH1Vxxxx-yyyz-R

SDCH1V = Product code
xxxx= size code
yyy= Inductance value in μ H, R=decimal point
z= Inductance tolerance
-R suffix = RoHS compliant

Dimensions-mm

SDCH1V6028

SDCH1V6045

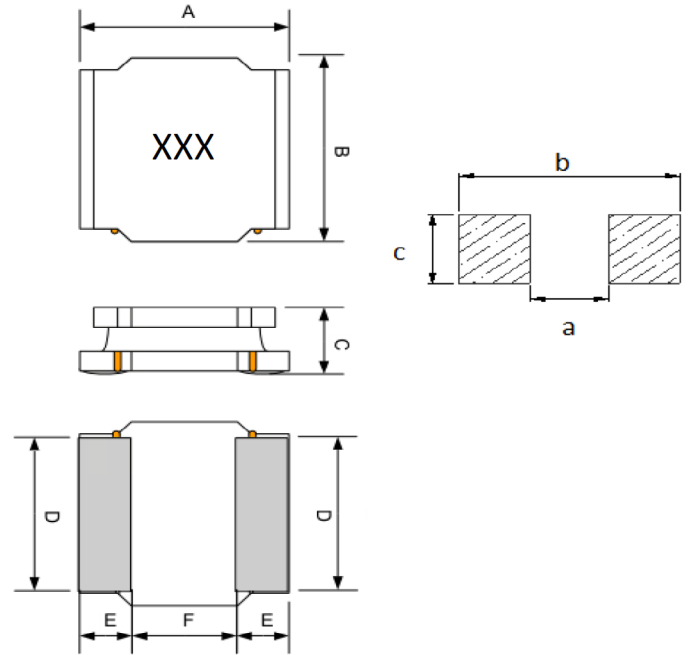
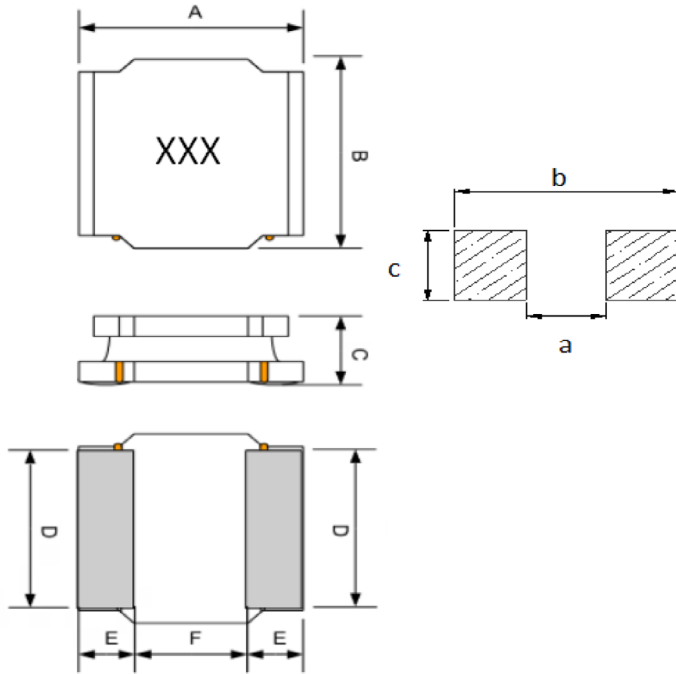

Dimension	Value
A	6.0 ± 0.2
B	6.0 ± 0.2
C	3.0 MAX
D	5.0 ± 0.2
E	1.85 ± 0.3
F	2.3 ± 0.3
a	2.0 TYP
b	6.3 TYP
c	5.3 TYP

Dimension	Value
A	6.0 ± 0.2
B	6.0 ± 0.2
C	4.5 MAX
D	4.9 ± 0.2
E	1.55 ± 0.3
F	2.7 ± 0.3
a	2.4 TYP
b	6.3 TYP
c	5.2 TYP

Part marking: xxx= inductance value in uH, R= decimal point. If no R is present then last character equals number of zeros.
Tolerances are ±0.3 millimeters unless stated otherwise
All soldering surfaces to be coplanar within 0.1 millimeters
Pad layout tolerances are ±0.1 millimeters unless stated otherwise
Traces or vias underneath the inductor is not recommended

Packaging information- mm

SDCH1V6028

Supplied in tape and reel packaging, 2000 parts per 13" diameter reel (EIA-481 compliant)

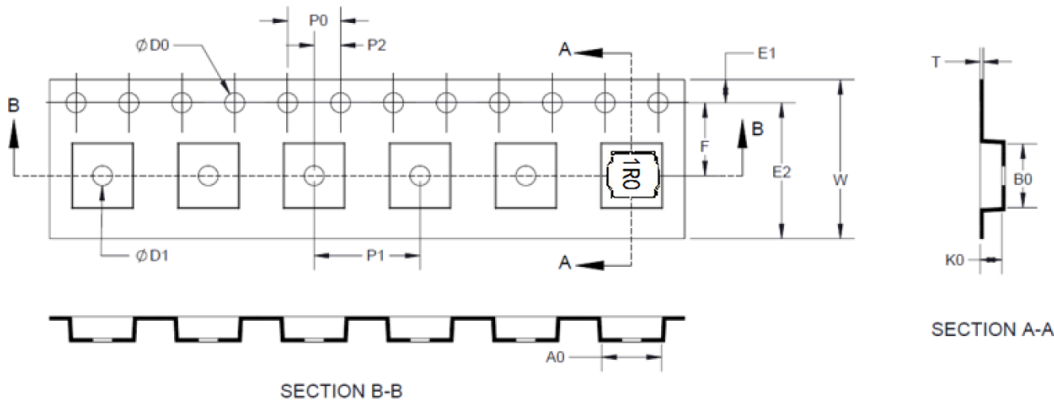

Dimension	Value
W	16.00 ± 0.30
F	7.50 ± 0.10
E1	1.75 ± 0.10
E2	N/A
P0	4.00 ± 0.10
P1	8.00 ± 0.10
P2	2.00 ± 0.10
$\phi D0$	1.50 + 0.1/-0
$\phi D1$	1.50 + 0.1/-0
A0	6.45 ± 0.10
B0	6.40 ± 0.10
K0	3.15 ± 0.10
T	0.35 ± 0.05

Packaging information- mm

SDCH1V6045

Supplied in tape and reel packaging, 1500 parts per 13" diameter reel (EIA-481 compliant)

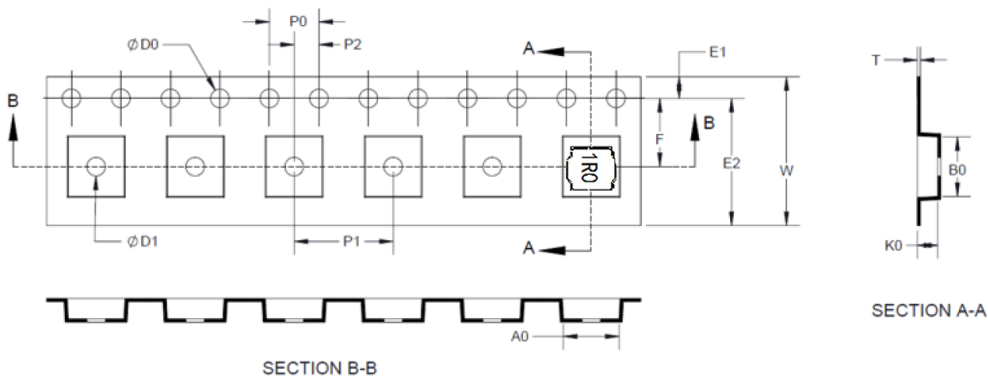

Dimension	Value
W	16.00 + 0.2/-0.3
F	7.50 ± 0.10
E1	1.75 ± 0.10
E2	N/A
P0	4.00 ± 0.10
P1	8.00 ± 0.10
P2	2.00 ± 0.10
$\phi D0$	1.50 + 0.1/-0
$\phi D1$	N/A
A0	6.40 ± 0.10
B0	6.40 ± 0.10
K0	4.75 ± 0.10
T	0.40 ± 0.05

Inductance and temperature rise vs current
SDCH1V6028

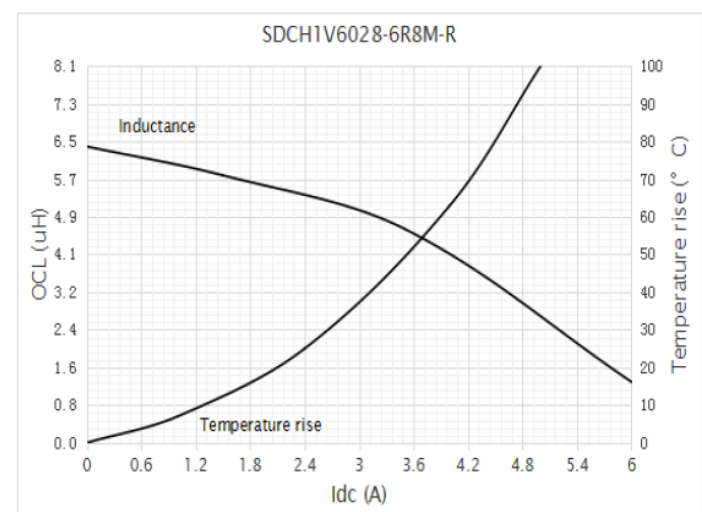
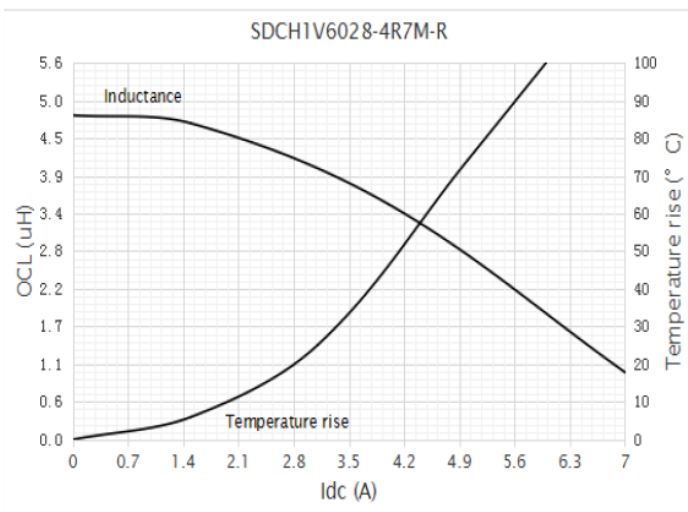
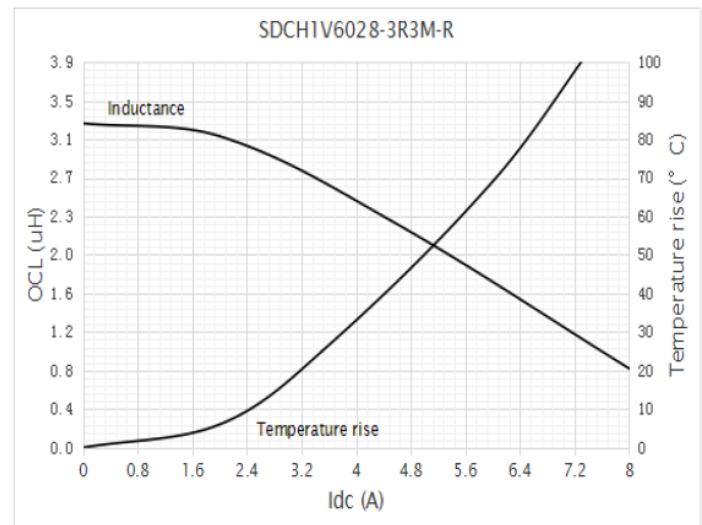
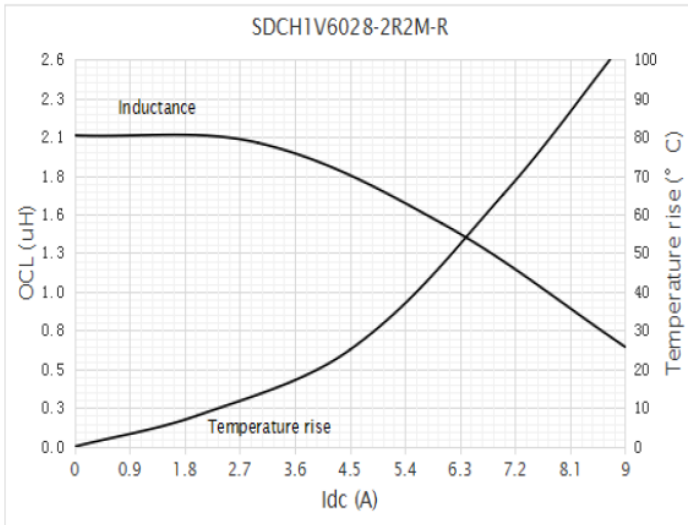
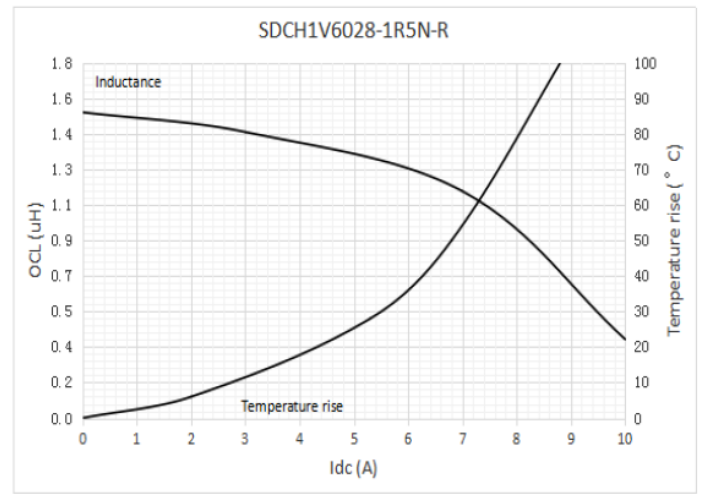
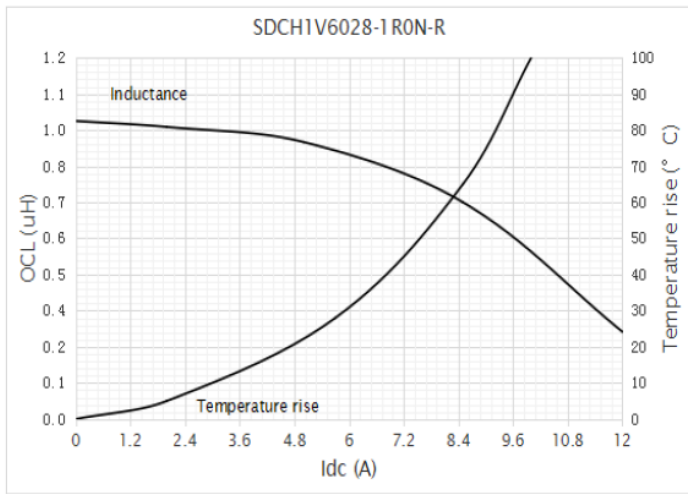

Inductance and temperature rise vs current
SDCH1V6028

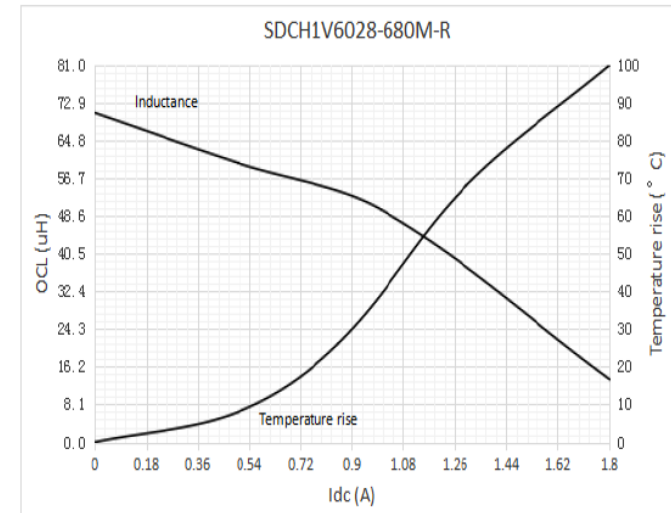
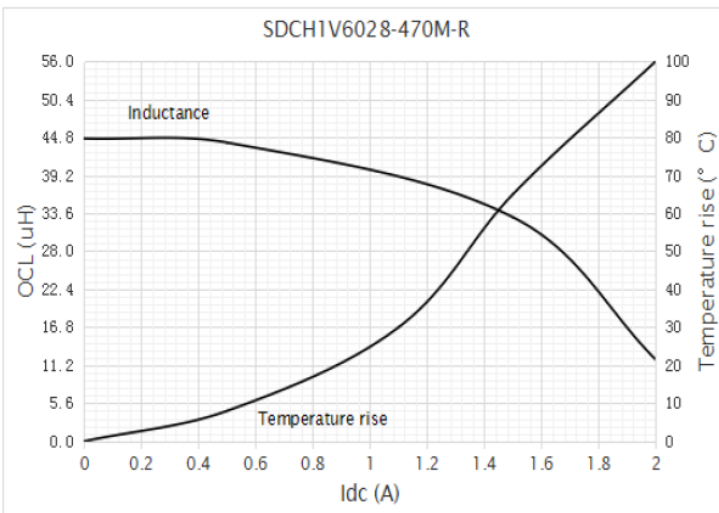
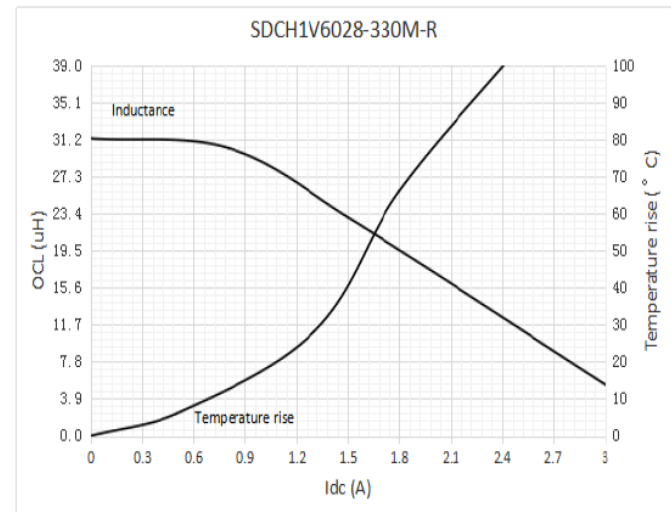
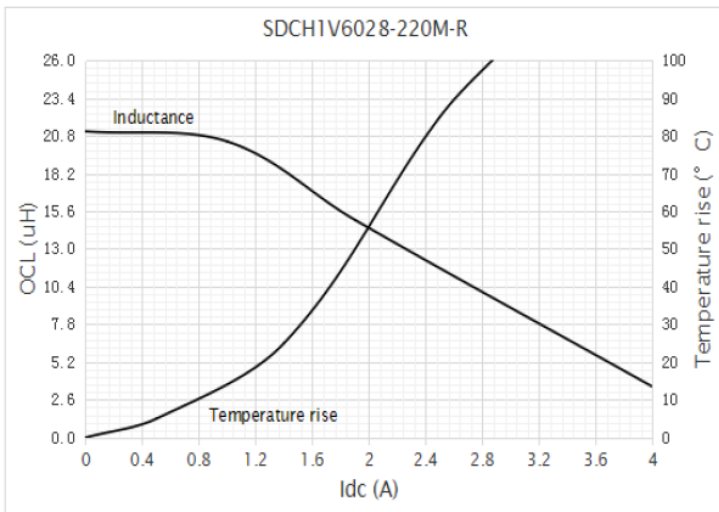
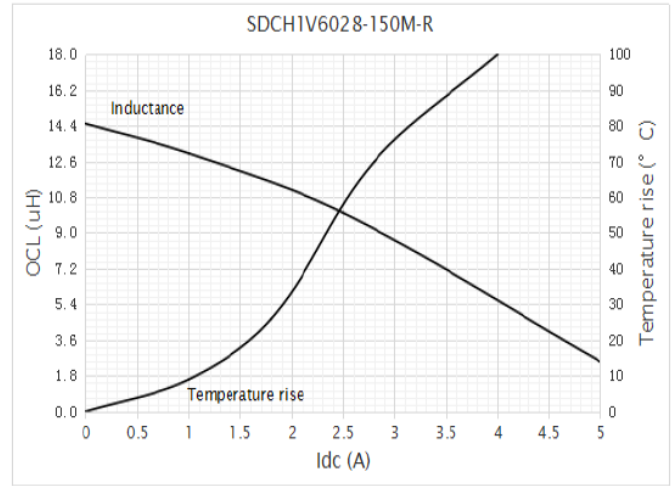
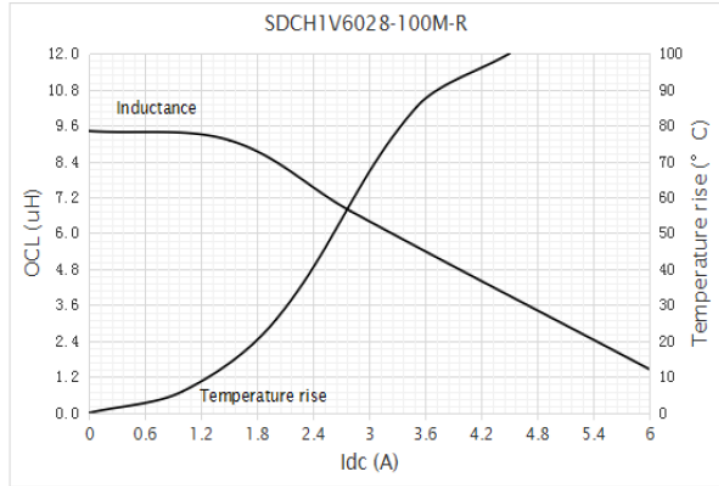

Inductance and temperature rise vs current
SDCH1V6028

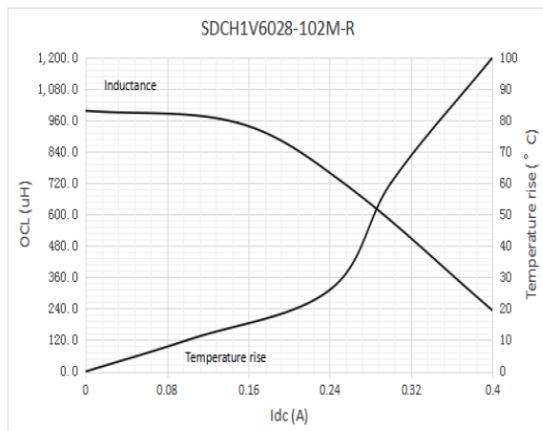
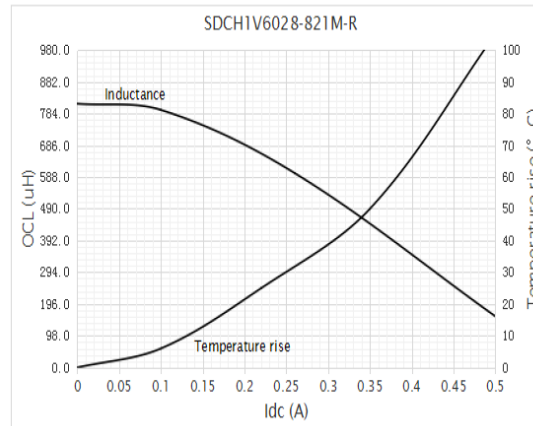
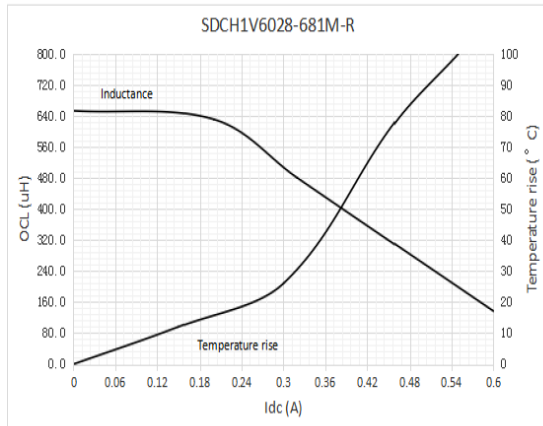
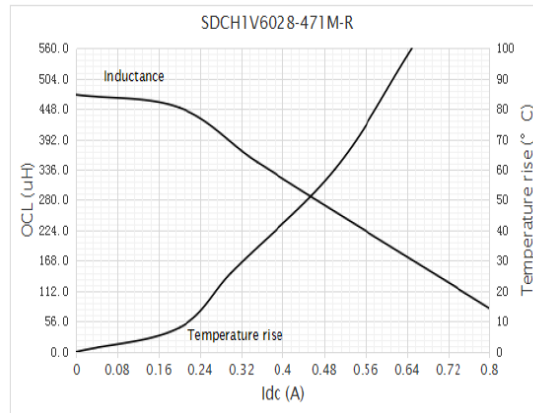
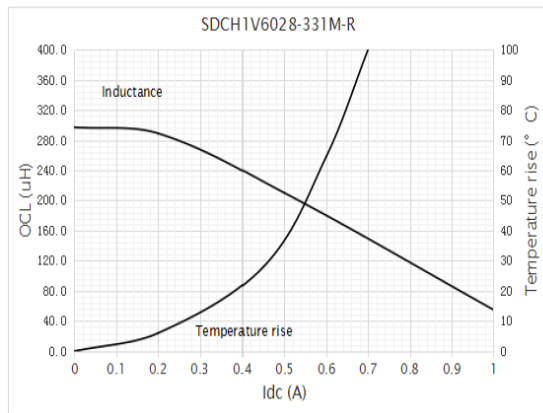
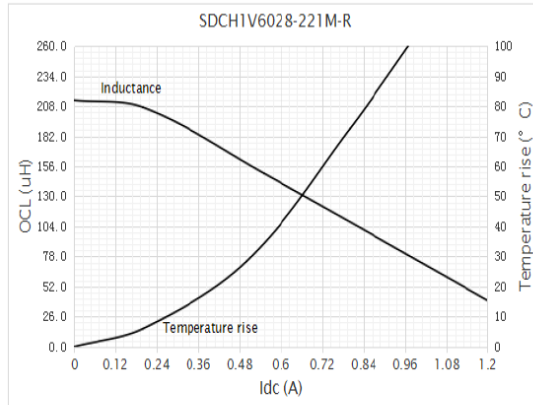
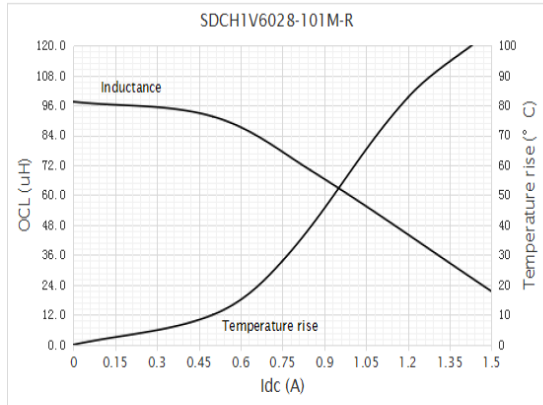

Inductance and temperature rise vs current
SDCH1V6045

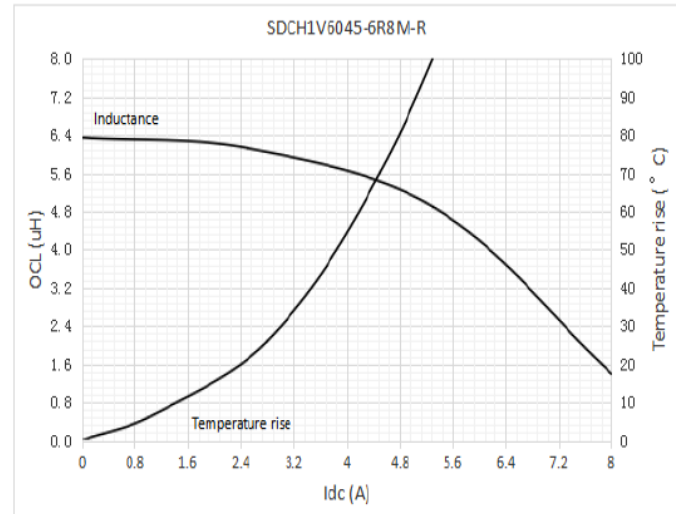
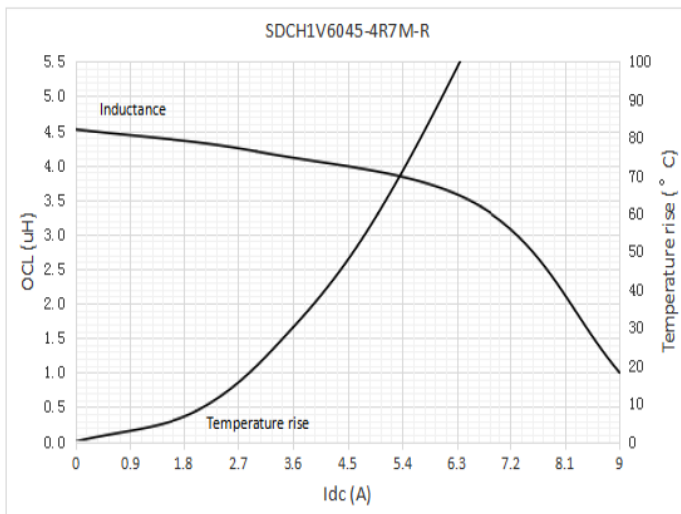
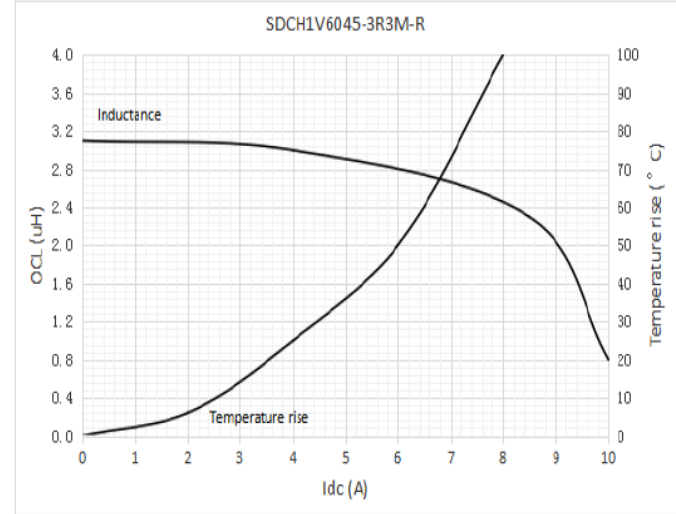
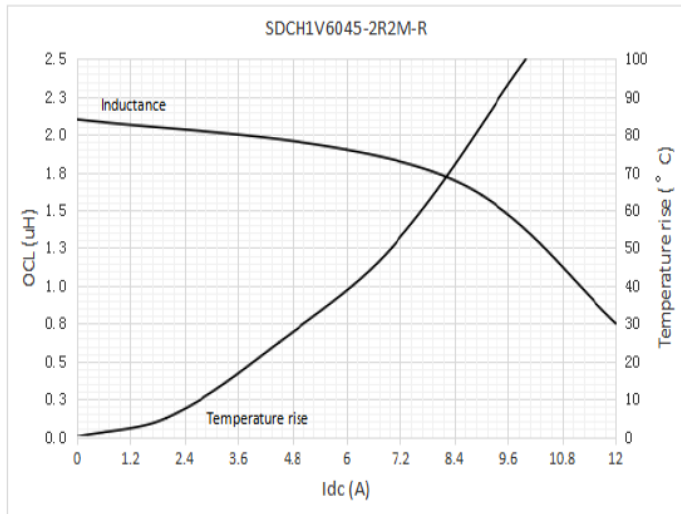
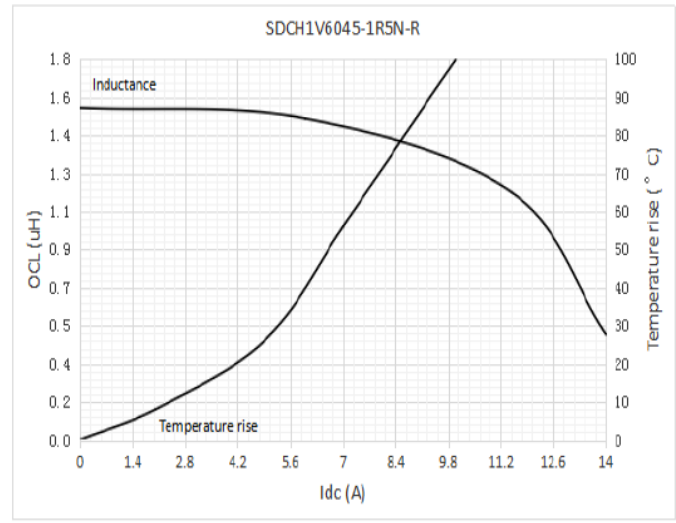
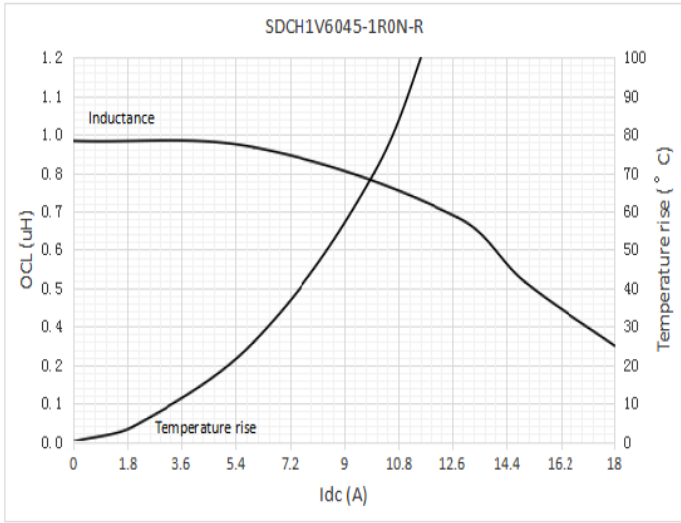

Inductance and temperature rise vs current
SDCH1V6045

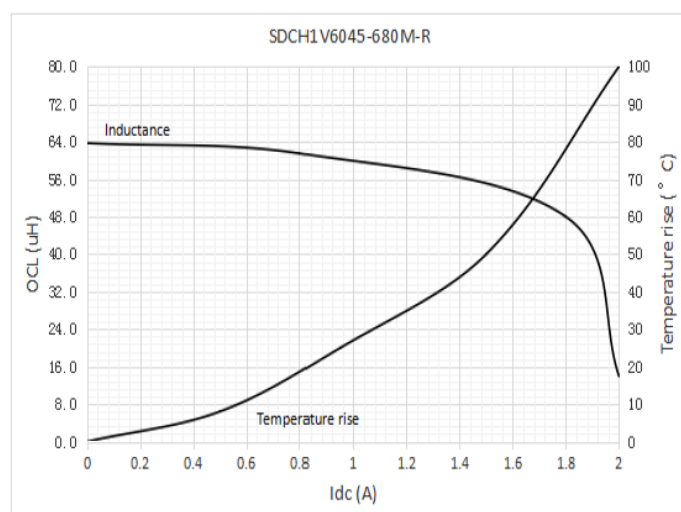
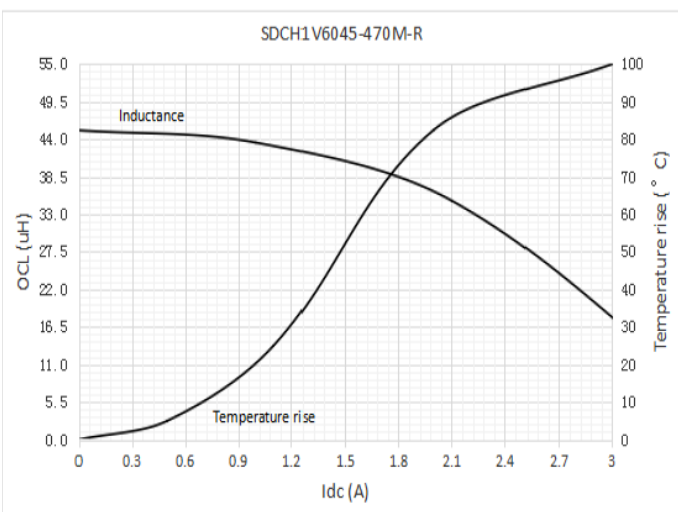
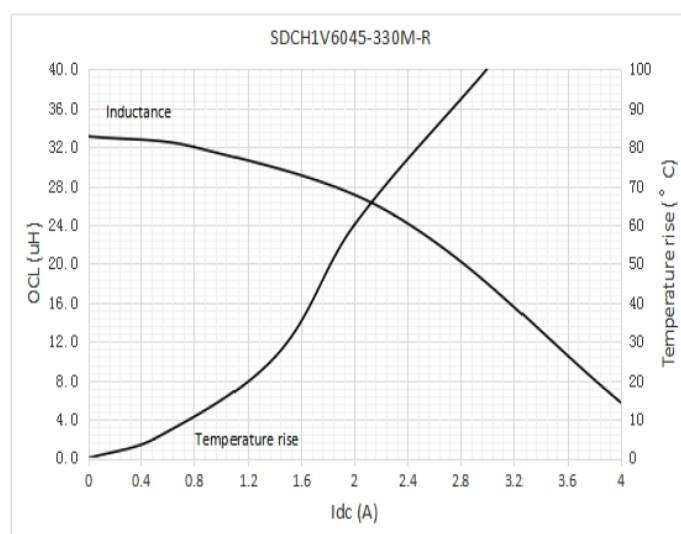
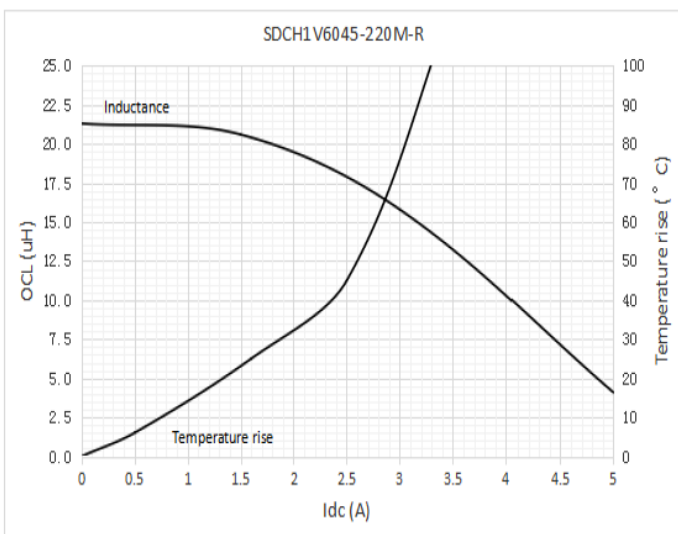
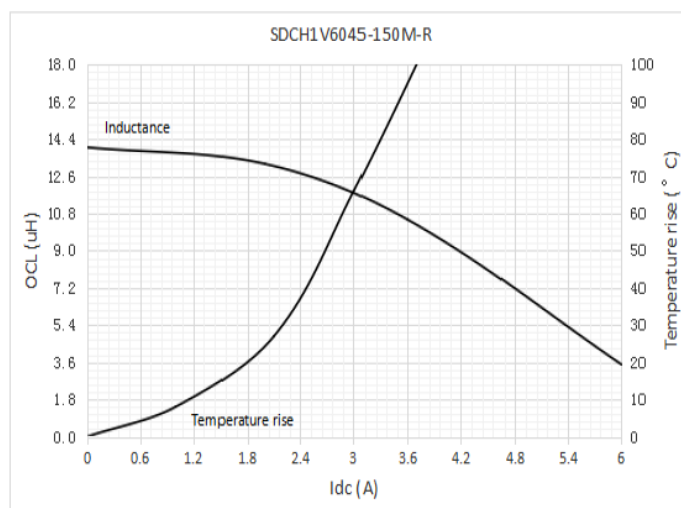
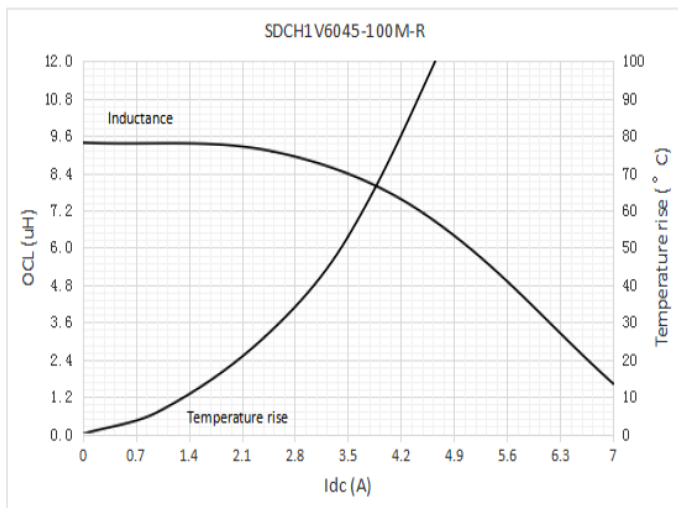

Inductance and temperature rise vs current
SDCH1V6045

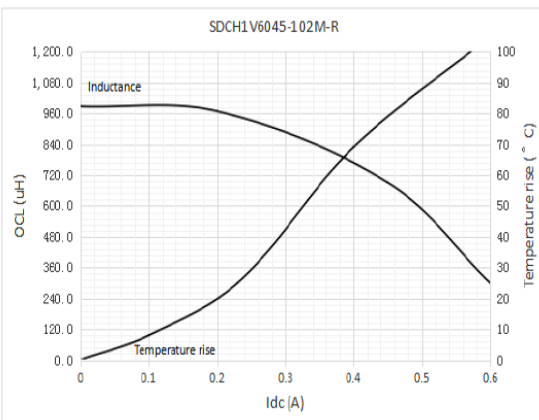
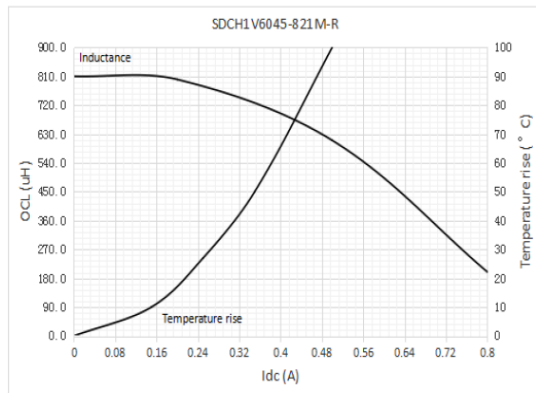
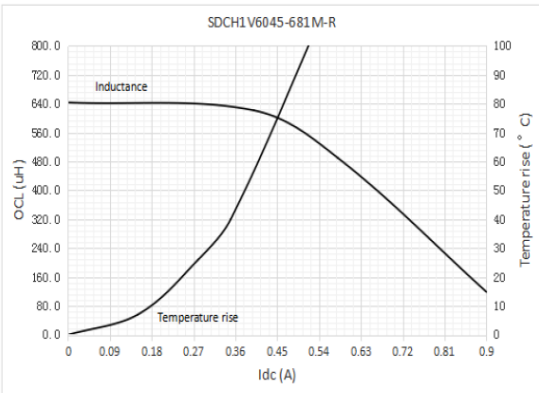
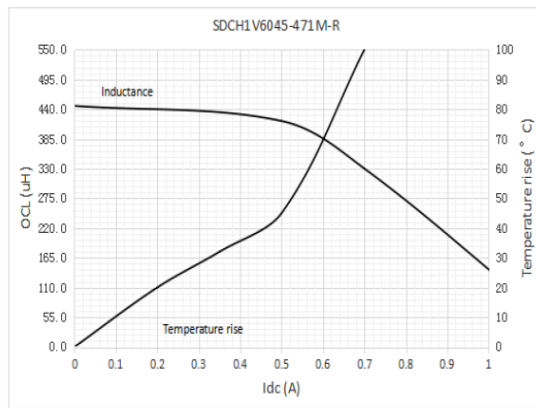
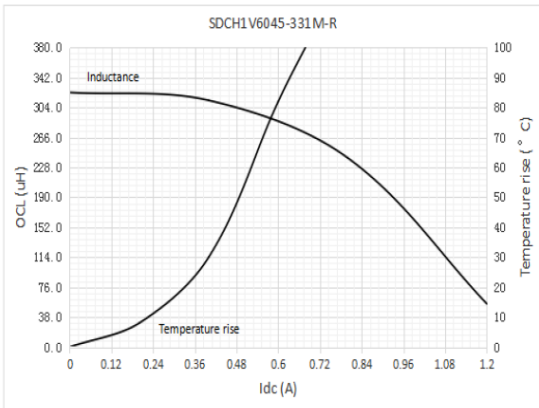
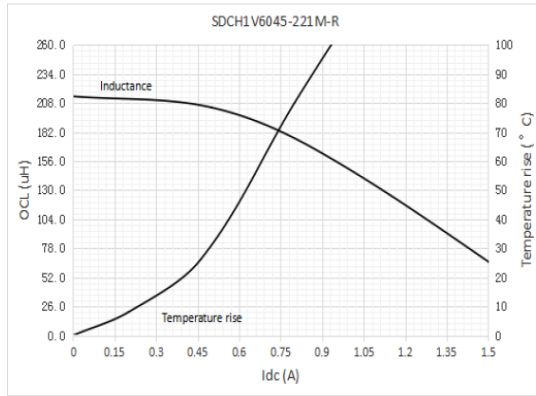
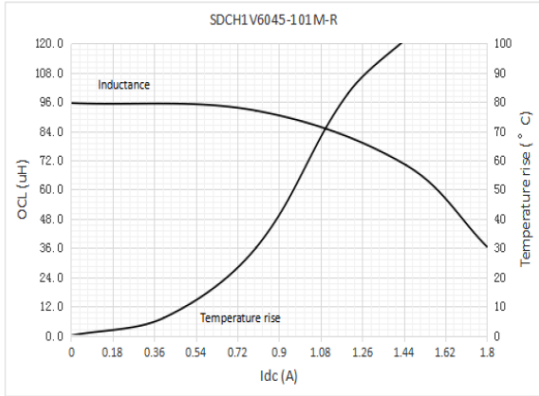

Solder reflow profile

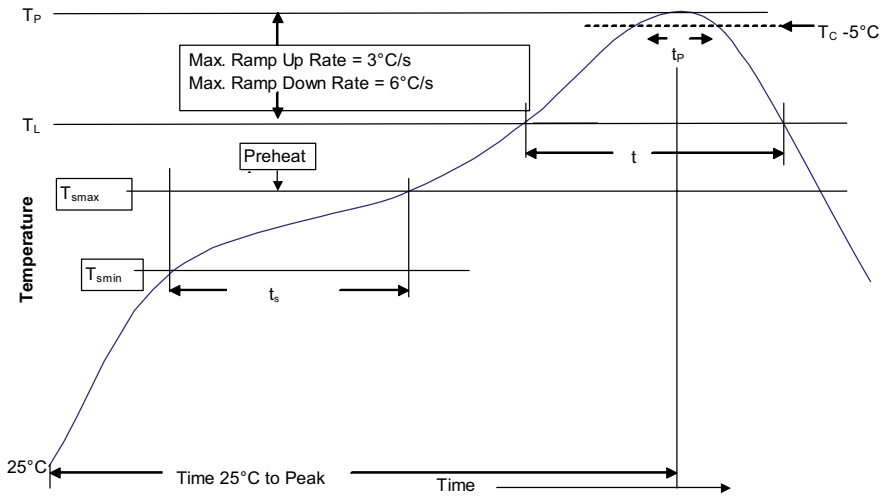

Table 1 - Standard SnPb solder (T_C)

Package thickness	Volume mm ³ <350	Volume mm ³ ≥350
<2.5 mm	235 °C	220 °C
≥2.5 mm	220 °C	220 °C

Table 2 - Lead (Pb) free solder (T_C)

Package thickness	Volume mm ³ <350	Volume mm ³ 350 - 2000	Volume mm ³ >2000
<1.6 mm	260 °C	260 °C	260 °C
1.6 – 2.5 mm	260 °C	250 °C	245 °C
>2.5 mm	250 °C	245 °C	245 °C

Reference J-STD-020

Profile feature	Standard SnPb solder	Lead (Pb) free solder
Preheat and soak		
• Temperature min. (T _{smin})	100 °C	150 °C
• Temperature max. (T _{smax})	150 °C	200 °C
• Time (T _{smin} to T _{smax}) (t _s)	60-120 seconds	60-120 seconds
Ramp up rate T _L to T _p	3 °C/ second max.	3 °C/ second max.
Liquidous temperature (T _L)	183 °C	217 °C
Time (t _L) maintained above T _L	60-150 seconds	60-150 seconds
Peak package body temperature (T _p)*	Table 1	Table 2
Time (t _p)* within 5 °C of the specified classification temperature (T _C)	20 seconds*	30 seconds*
Ramp-down rate (T _p to T _L)	6 °C/ second max.	6 °C/ second max.
Time 25 °C to peak temperature	6 minutes max.	8 minutes max.

* Tolerance for peak profile temperature (T_p) is defined as a supplier minimum and a user maximum.

Life Support Policy: Eaton does not authorize the use of any of its products for use in life support devices or systems without the express written approval of an officer of the Company. Life support systems are devices which support or sustain life, and whose failure to perform, when properly used in accordance with instructions for use provided in the labeling, can be reasonably expected to result in significant injury to the user.

Eaton reserves the right, without notice, to change design or construction of any products and to discontinue or limit distribution of any products. Eaton also reserves the right to change or update, without notice, any technical information contained in this bulletin.

Eaton
Electronics Division
1000 Eaton Boulevard
Cleveland, OH 44122
United States
Eaton.com/electronics

© 2021 Eaton
All Rights Reserved
Printed in USA
Publication No. ELX1034 BU-ELX21034
April 2021

Eaton is a registered trademark.
All other trademarks are property of their respective owners.

Follow us on social media to get the latest product and support information.



X-ON Electronics

Largest Supplier of Electrical and Electronic Components

Click to view similar products for [Fixed Inductors](#) category:

Click to view products by [Eaton](#) manufacturer:

Other Similar products are found below :

[CR43NP-680KC](#) [CR54NP-820KC](#) [CR54NP-8R5MC](#) [CTX32CT-100](#) [70F224AI](#) [MGDQ4-00004-P](#) [MHL1ECTTP18NJ](#) [MHL1JCTTD12NJ](#)
[PE-51506NL](#) [PE-53601NL](#) [PE-53602NL](#) [PE-53630NL](#) [PE-53824SNLT](#) [PE-62892NL](#) [PE-92100NL](#) [PG0434.801NLT](#) [PG0936.113NLT](#)
[9310-16](#) [PM06-2N7](#) [PM06-39NJ](#) [A01TK](#) [1206CS-471XJ](#) [HC2-2R2TR](#) [HC2LP-R47-R](#) [HC3-2R2-R](#) [1206CS-151XG](#) [RCH664NP-140L](#)
[RCH664NP-4R7M](#) [RCH8011NP-221L](#) [RCP1317NP-332L](#) [RCP1317NP-391L](#) [RCR1010NP-470M](#) [RCR110DNP-331L](#) [DH2280-4R7M](#)
[DS1608C-106](#) [ASPI-4020HI-R10M-T](#) [B10TJ](#) [B82477P4333M](#) [B82498B3101J000](#) [B82498B3680J000](#) [ELJ-RE27NJF2](#) [1812CS-153XJ](#)
[1812CS-183XJ](#) [1812CS-223XJ](#) [1812LS-104XJ](#) [1812LS-105XJ](#) [1812LS-124XJ](#) [1812LS-154XJ](#) [1812LS-223XJ](#) [1812LS-224XJ](#)