

SMCJE

1500 W Transient voltage suppressor

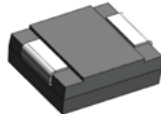

Product features

- Low profile SMC package
- Excellent clamping capability
- 1500 W peak pulse power capability at 10/1000 μ s waveform
- Typical I_R less than 1 μ A above 11 V
- Fast response time: typically less than 1.0 ps from 0 V to V_{BR} minimum
- High temperature reflow soldering: +260 °C /40 s at terminal
- Plastic package meets UL 94 V-0 flammability rating
- Meets moisture sensitivity level (MSL) level 1
- Terminal: Solder plated leads, solderable per J-STD-002
- For surface mounted applications in order to optimize board space
- UL 497B recognized.
File No. : E198449 Guide QVGO2

Applications

- Consumer electronics
- Telecommunications
- Computing and servers
- Appliances
- Industrial automation
- Power conversion

Environmental compliance and general specifications



Ordering part number

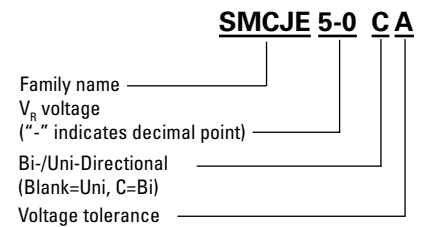

PIN configuration

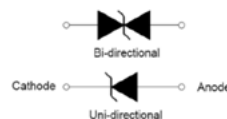
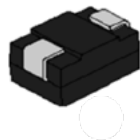

Absolute maximum ratings

(+25 °C, RH=45%-75%, unless otherwise noted)

Parameter	Symbol	Value	Unit
Storage operating junction temperature range	T_{STG}/T_J	-55 to +150	°C
Steady state power dissipation at $T_L = +75$ °C	$P_{M(AV)}$	6.5	W
Peak pulse power dissipation on 10/1000 μ s waveform	P_{PP}	1500	W
Maximum instantaneous forward voltage at 100 A for unidirectional	V_F	5.0	V
Peak forward surge current, 8.3 ms single half sine wave ¹	I_{FSM}	200	A
Typical thermal resistance junction to lead	$R_{\theta JL}$	15	°C/W
Typical thermal resistance junction to ambient	$R_{\theta JA}$	75	°C/W

1. Measured on 8.3 ms single half sine wave or equivalent square wave for unidirectional device only, duty cycle = 4 per minute maximum

Mechanical parameters, pad layout- mm

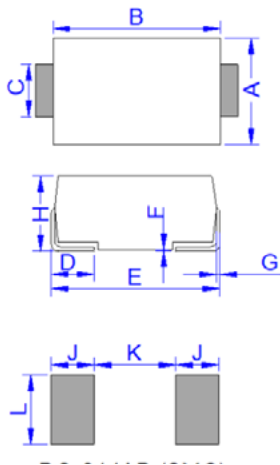

Dimension	Millimeters		Inches	
	Minimum	Maximum	Minimum	Maximum
A	5.75	6.25	0.226	0.246
B	6.90	7.40	0.272	0.291
C	2.75	3.25	0.108	0.128
D	0.95	1.52	0.037	0.060
E	7.70	8.20	0.303	0.323
F	0.051	0.203	0.002	0.008
G	0.15	0.31	0.006	0.012
H	2.15	2.62	0.085	0.103
J	2.40		0.094	
K		4.20		0.165
L	3.30		0.130	

Part marking

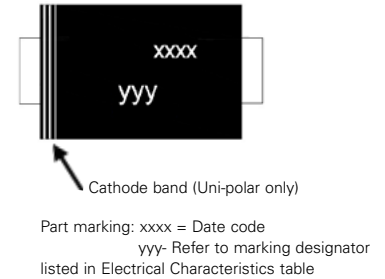

Packaging information (mm)

Drawing not to scale.

Supplied in tape and reel packaging, 3,000 parts per 13" diameter reel (EIA-481 compliant)

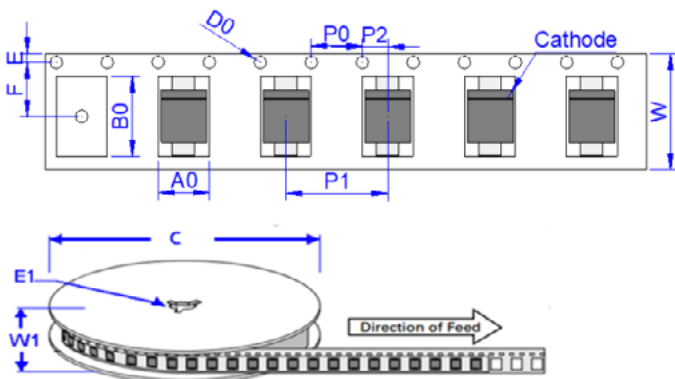

Dimension	Millimeters	Inches
A0	6.05 ± 0.3	0.238 ± 0.012
B0	8.31 ± 0.3	0.327 ± 0.012
C	330.0	13.0
D0	1.55 ± 0.1	0.061 ± 0.004
E	1.75 ± 0.2	0.069 ± 0.008
E1	13.3 ± 0.3	0.524 ± 0.012
F	7.50 ± 0.2	0.295 ± 0.008
P0	4.00 ± 0.2	0.157 ± 0.008
P1	8.00 ± 0.2	0.315 ± 0.008
P2	2.00 ± 0.2	0.079 ± 0.008
W	16.0 ± 0.2	0.630 ± 0.008
W1	19.7 ± 2.0	0.776 ± 0.079

SMCJE

1500 W Transient voltage suppressor

Technical Data 11215
Effective November 2020

Electrical characteristics (+25 °C)

Part number		Marking		V _R (V)	I _R @ V _R (μA)	V _{BR} @ I _T		I _T (mA)	V _C @ I _{PP} max (V)	I _{PP} (A)
Uni-polar	Bi-polar	Uni	Bi			min (V)	max (V)			
SMCJE5-0A	SMCJE5-0CA	GDE	BDE	5	300	6.4	7	10	9.2	163
SMCJE6-0A	SMCJE6-0CA	GDG	BDG	6	250	6.67	7.37	10	10.3	145.6
SMCJE6-5A	SMCJE6-5CA	GDK	BDK	6.5	150	7.22	7.98	10	11.2	134
SMCJE7-0A	SMCJE7-0CA	GDM	BDM	7	100	7.78	8.6	10	12	125
SMCJE7-5A	SMCJE7-5CA	GDP	BDP	7.5	50	8.33	9.21	1	12.9	116.3
SMCJE8-0A	SMCJE8-0CA	GDR	BDR	8	30	8.89	9.83	1	13.6	110.3
SMCJE8-5A	SMCJE8-5CA	GDT	BDT	8.5	20	9.44	10.4	1	14.4	104.2
SMCJE9-0A	SMCJE9-0CA	GDV	BDV	9	10	10	11.1	1	15.4	97.4
SMCJE10A	SMCJE10CA	GDX	BDX	10	5	11.1	12.3	1	17	88.2
SMCJE11A	SMCJE11CA	GDZ	BDZ	11	2	12.2	13.5	1	18.2	82.4
SMCJE12A	SMCJE12CA	GEE	BEE	12	1	13.3	14.7	1	19.9	75.4
SMCJE13A	SMCJE13CA	GEG	BEG	13	1	14.4	15.9	1	21.5	69.8
SMCJE14A	SMCJE14CA	GEK	BEK	14	1	15.6	17.2	1	23.2	64.7
SMCJE15A	SMCJE15CA	GEM	BEM	15	1	16.7	18.5	1	24.4	61.5
SMCJE16A	SMCJE16CA	GEP	BEP	16	1	17.8	19.7	1	26	57.7
SMCJE17A	SMCJE17CA	GER	BER	17	1	18.9	20.9	1	27.6	54.4
SMCJE18A	SMCJE18CA	GET	BET	18	1	20	22.1	1	29.2	51.4
SMCJE20A	SMCJE20CA	GEV	BEV	20	1	22.2	24.5	1	32.4	46.3
SMCJE22A	SMCJE22CA	GEX	BEX	22	1	24.4	26.9	1	35.5	42.3
SMCJE24A	SMCJE24CA	GEZ	BEZ	24	1	26.7	29.5	1	38.9	38.6
SMCJE26A	SMCJE26CA	GFE	BFE	26	1	28.9	31.9	1	42.1	35.6
SMCJE28A	SMCJE28CA	GFG	BFG	28	1	31.1	34.4	1	45.4	33.1
SMCJE30A	SMCJE30CA	GFK	BFK	30	1	33.3	36.8	1	48.4	31
SMCJE33A	SMCJE33CA	GFM	BFM	33	1	36.7	40.6	1	53.3	28.2
SMCJE36A	SMCJE36CA	GFP	BFP	36	1	40	44.2	1	58.1	25.8
SMCJE40A	SMCJE40CA	GFR	BFR	40	1	44.4	49.1	1	64.5	23.3
SMCJE43A	SMCJE43CA	GFT	BFT	43	1	47.8	52.8	1	69.4	21.6
SMCJE45A	SMCJE45CA	GFV	BFV	45	1	50	55.3	1	72.7	20.6
SMCJE48A	SMCJE48CA	GFX	BFX	48	1	53.3	58.9	1	77.4	19.4
SMCJE51A	SMCJE51CA	GFZ	BFZ	51	1	56.7	62.7	1	82.4	18.2
SMCJE54A	SMCJE54CA	GGE	BGE	54	1	60	66.3	1	87.1	17.2
SMCJE58A	SMCJE58CA	GGG	BGG	58	1	64.4	71.2	1	93.6	16.1
SMCJE60A	SMCJE60CA	GGK	BGK	60	1	66.7	73.7	1	96.8	15.5
SMCJE64A	SMCJE64CA	GGM	BGM	64	1	71.1	78.6	1	103	14.6
SMCJE70A	SMCJE70CA	GGP	BGP	70	1	77.8	86	1	113	13.3
SMCJE75A	SMCJE75CA	GGR	BGR	75	1	83.3	92.1	1	121	12.4
SMCJE78A	SMCJE78CA	GGT	BGT	78	1	86.7	95.8	1	126	11.9
SMCJE85A	SMCJE85CA	GGV	BGV	85	1	94.4	104	1	137	11
SMCJE90A	SMCJE90CA	GGX	BGX	90	1	100	111	1	146	10.3
SMCJE100A	SMCJE100CA	GGZ	BGZ	100	1	111	123	1	162	9.3
SMCJE110A	SMCJE110CA	GHE	BHE	110	1	122	135	1	177	8.5
SMCJE120A	SMCJE120CA	GHG	BHG	120	1	133	147	1	193	7.8
SMCJE130A	SMCJE130CA	GHK	BHK	130	1	144	159	1	209	7.2
SMCJE150A	SMCJE150CA	GHM	BHM	150	1	167	185	1	243	6.2
SMCJE160A	SMCJE160CA	GHP	BHP	160	1	178	197	1	259	5.8
SMCJE170A	SMCJE170CA	GHR	BHR	170	1	189	209	1	275	5.5
SMCJE180A	SMCJE180CA	GHT	BHT	180	1	201	222	1	292	5.2
SMCJE190A	SMCJE190CA	GHU	BHU	190	1	211	234	1	307	4.9
SMCJE200A	SMCJE200CA	GHV	BHV	200	1	224	247	1	324	4.7
SMCJE210A	SMCJE210CA	GHW	BHW	210	1	233	258	1	337	4.5
SMCJE220A	SMCJE220CA	GHX	BHX	220	1	246	272	1	356	4.2
SMCJE250A	SMCJE250CA	GJG	BJG	250	1	279	309	1	405	3.7
SMCJE300A	SMCJE300CA	GJK	BJK	300	1	335	371	1	486	3.1
SMCJE350A	SMCJE350CA	GJM	BJM	350	1	391	432	1	567	2.7
SMCJE400A	SMCJE400CA	GJP	BJP	400	1	447	494	1	648	2.3
SMCJE440A	SMCJE440CA	GJR	BJR	440	1	492	543	1	713	2.1

Ratings and V-I characteristic curves (+25 °C unless otherwise noted)

V- I curve characteristics (Uni-directional)

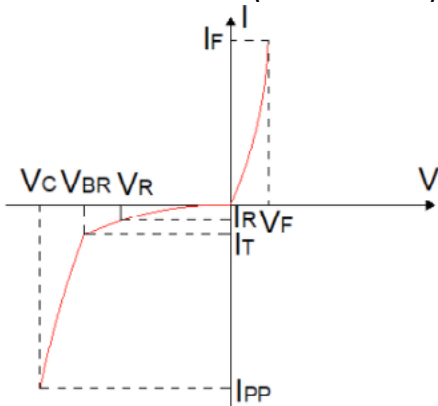

V- I curve characteristics (Bi-directional)

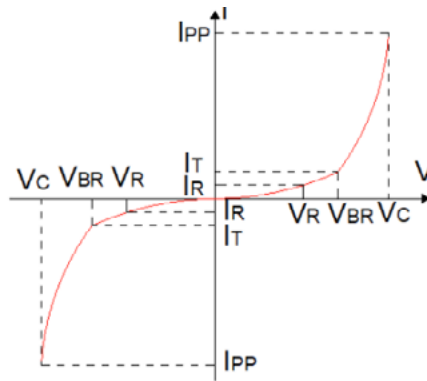

Surge waveform: 10/1000 μ s

V_R : Stand-off voltage – Maximum voltage that can be applied

V_{BR} : Breakdown voltage

V_C : Clamping voltage – Peak voltage measured across the suppressor at a specified I_{PP}

I_R : Reverse leakage current

I_T : Test current

V_F : Forward voltage drop for Uni-directional TVS diode

Pulse waveform

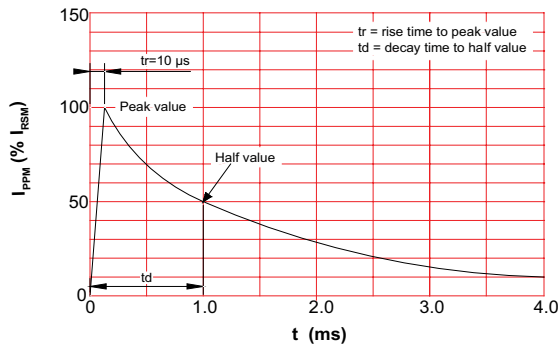

Pulse derating curve

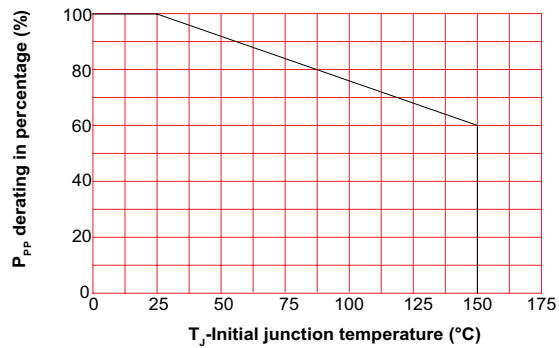

Peak pulse power dissipation vs. pulse width

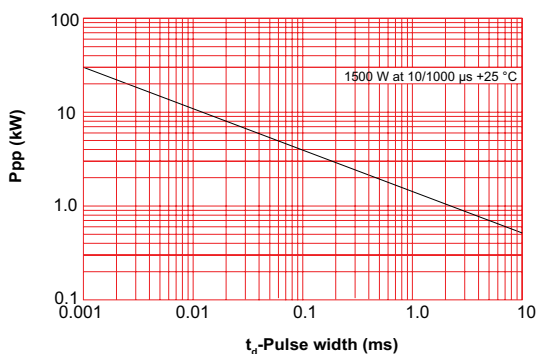

Solder reflow profile

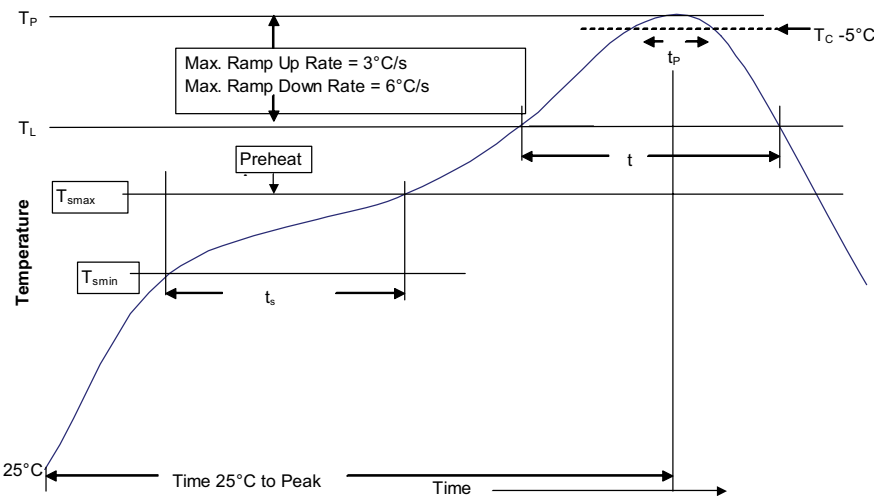

Table 1 - Standard SnPb solder (T_C)

Package thickness	Volume mm ³ <350	Volume mm ³ ≥350
<2.5 mm	235 °C	220 °C
≥2.5 mm	220 °C	220 °C

Table 2 - Lead (Pb) free solder (T_C)

Package thickness	Volume mm ³ <350	Volume mm ³ 350 - 2000	Volume mm ³ >2000
<1.6 mm	260 °C	260 °C	260 °C
1.6 – 2.5 mm	260 °C	250 °C	245 °C
>2.5 mm	250 °C	245 °C	245 °C

Reference J-STD-020

Profile feature	Standard SnPb solder	Lead (Pb) free solder
Preheat and soak	<ul style="list-style-type: none"> Temperature min. (T_{smin}) Temperature max. (T_{smax}) Time (T_{smin} to T_{smax}) (t_s) 	<ul style="list-style-type: none"> 100 °C 150 °C 60-120 seconds
Ramp up rate T_L to T_p	3 °C/ second max.	3 °C/ second max.
Liquidous temperature (T_L) Time (t_L) maintained above T_L	<ul style="list-style-type: none"> 183 °C 60-150 seconds 	<ul style="list-style-type: none"> 217 °C 60-150 seconds
Peak package body temperature (T_p)*	Table 1	Table 2
Time (t_p)* within 5 °C of the specified classification temperature (T_c)	20 seconds*	40 seconds*
Ramp-down rate (T_p to T_L)	6 °C/ second max.	6 °C/ second max.
Time 25 °C to peak temperature	6 minutes max.	8 minutes max.

* Tolerance for peak profile temperature (T_p) is defined as a supplier minimum and a user maximum.

Life Support Policy: Eaton does not authorize the use of any of its products for use in life support devices or systems without the express written approval of an officer of the Company. Life support systems are devices which support or sustain life, and whose failure to perform, when properly used in accordance with instructions for use provided in the labeling, can be reasonably expected to result in significant injury to the user.

Eaton reserves the right, without notice, to change design or construction of any products and to discontinue or limit distribution of any products. Eaton also reserves the right to change or update, without notice, any technical information contained in this bulletin.

Eaton
Electronics Division
1000 Eaton Boulevard
Cleveland, OH 44122
United States
Eaton.com/electronics

© 2020 Eaton
All Rights Reserved
Printed in USA
Publication No. 11215 BU-MC20193
November 2020

Eaton is a registered trademark.
All other trademarks are property of their respective owners.

Follow us on social media to get the latest product and support information.



X-ON Electronics

Largest Supplier of Electrical and Electronic Components

Click to view similar products for [ESD Suppressors / TVS Diodes](#) category:

Click to view products by [Eaton](#) manufacturer:

Other Similar products are found below :

[60KS200C](#) [D12V0H1U2WS-7](#) [D18V0L1B2LP-7B](#) [82356050220](#) [D5V0M5U6V-7](#) [NTE4902](#) [P4KE27CA](#) [P6KE11CA](#) [P6KE39CA-TP](#)
[P6KE8.2A](#) [SA110CA](#) [SA60CA](#) [SA64CA](#) [SMBJ12CATR](#) [SMBJ8.0A](#) [SMLJ30CA-TP](#) [ESD101-B1-02ELS E6327](#) [ESD112-B1-02EL E6327](#)
[ESD119B1W01005E6327XTSA1](#) [ESD5V0L1B02VH6327XTSA1](#) [ESD7451N2T5G](#) [19180-510](#) [CPDT-5V0USP-HF](#) [3.0SMCJ33CA-F](#)
[3.0SMCJ36A-F](#) [HSPC16701B02TP](#) [D3V3Q1B2DLP3-7](#) [D55V0M1B2WS-7](#) [DESD5V0U1BL-7B](#) [DRTR5V0U4SL-7](#) [SCM1293A-04SO](#)
[ESD200-B1-CSP0201 E6327](#) [ESD203-B1-02EL E6327](#) [SM12-7](#) [SMF8.0A-TP](#) [SMLJ45CA-TP](#) [CEN955 W/DATA](#) [82350120560](#)
[82356240030](#) [VESD12A1A-HD1-GS08](#) [CPDUR5V0R-HF](#) [CPDUR24V-HF](#) [CPDQC5V0U-HF](#) [CPDQC5V0USP-HF](#) [CPDQC5V0-HF](#)
[D1213A-01LP4-7B](#) [D1213A-02WL-7](#) [ESDLIN1524BJ-HQ](#) [5KP100A](#) [5KP15A](#)