

# STSP84XXXXXX

## TVS Diode array ESD suppressor

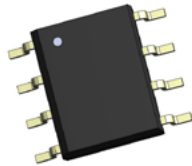

### Product features

- Protects four I/O lines
- Low clamping voltage
- Low operating voltage
- Meets moisture sensitivity level (MSL) 3
- Molding compound flammability rating: UL 94V-0
- Termination finish: Tin

### Applications

- WAN/LAN equipment
- Desktops, servers, notebooks & handhelds
- Switching systems
- Audio/video inputs
- 10/100/1000 ethernet
- Base stations

### Environmental compliance and general specifications

- IEC61000-4-2 (ESD)
  - Up to  $\pm 30$  kV (air)
  - Up to  $\pm 30$  kV (contact)
- IEC61000-4-5 (Lightning) Up to 50 A (8/20  $\mu$ s)



### Pin out/functional diagram



STSP84150B601

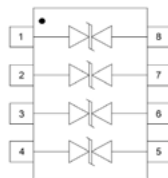

Pin Configuration (Top view)

### Ordering part number

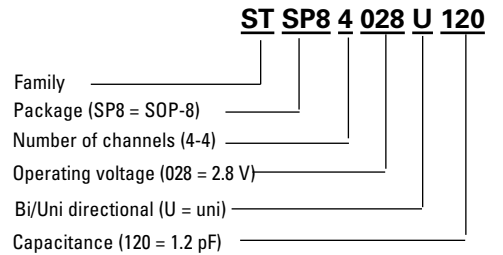

STSP84028U120  
STSP84028UL65

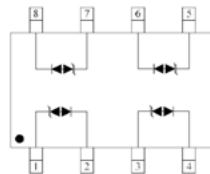

PIN Configuration

STSP84033U800  
STSP84050U800

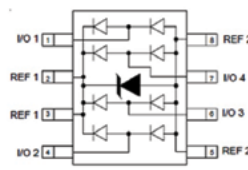

Pin configuration

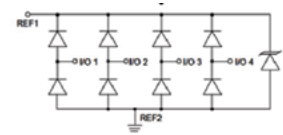

Circuit diagram

### Absolute maximum ratings

(+25 °C, RH=45%-75%, unless otherwise noted)

Parameter	Symbol	Value					Unit
		STSP84028 U120	STSP84028 UL65	STSP84033 U800	STSP84050 U800	STSP84150 B601	
Peak pulse power dissipation on 8/20 $\mu$ s waveform	$P_{pp}$	1000	600	500	500	300	W
ESD per IEC 61000-4-2 (Air)	$V_{ESD}$	+/-30	+/-30	+/-15	+/-15	+/-15	kV
ESD per IEC 61000-4-2 (Contact)		+/-30	+/-30	+/-8	+/-8	+/-8	
Lead soldering temperature	$T_L$	+260 (10 seconds)					°C
Operating junction temperature range	$T_J$	-55 to +125					°C
Storage temperature range	$T_{STG}$	-55 to +150					°C

### Electrical characteristics

(+25 °C)

#### STSP84028U120

Parameter	Test condition	Minimum	Typical	Maximum	Symbol (Units)
Reverse working voltage	-	-	-	2.8	$V_{RWM}$ (V)
Holding voltage	$I_h = 10$ mA	3.0	-	-	$V_h$
Reverse leakage current	$V_{RWM} = 2.8$ V	-	-	1	$I_R$ ( $\mu$ A)
Clamping voltage	$I_{pp} = 2$ A, $t_p = 8/20$ $\mu$ s	-	-	5.5	$V_c$ (V)
	$I_{pp} = 10$ A, $t_p = 8/20$ $\mu$ s	-	-	10	$V_c$ (V)
	$I_{pp} = 50$ A, $t_p = 8/20$ $\mu$ s	-	-	18	$V_c$ (V)
Junction capacitance	$V_{RWM} = 0$ V, $f = 1$ MHz	-	1.2	2.0	$C_J$ (pF)

#### STSP84028UL65

Parameter	Test condition	Minimum	Typical	Maximum	Symbol (Units)
Reverse working voltage	-	-	-	2.8	$V_{RWM}$ (V)
Reverse breakdown voltage	$I_T = 1$ mA	3.0	-	-	$V_{BR}$ (V)
Reverse leakage current	$V_{RWM} = 2.8$ V	-	0.01	0.1	$I_R$ ( $\mu$ A)
Clamping voltage	$I_{pp} = 2$ A, $t_p = 8/20$ $\mu$ s	-	-	7.6	$V_c$ (V)
	$I_{pp} = 20$ A, $t_p = 8/20$ $\mu$ s	-	14	20	$V_c$ (V)
Junction capacitance	$V_{RWM} = 0$ V, $f = 1$ MHz	-	0.65	1	$C_J$ (pF)

**STSP84033U800**

Parameter	Test condition	Minimum	Typical	Maximum	Symbol (Units)
Reverse working voltage	-	-	-	3.3	$V_{RWM}$ (V)
Reverse leakage current	$V_{RWM} = 3.3$ V	-	-	1	$I_R$ ( $\mu$ A)
Punch-through voltage	$I_{PT} = 2$ $\mu$ A	3.5	-	-	$V_{PT}$ (V)
Snapback voltage	$I_{SB} = 50$ mA	2.8	-	-	$V_{SB}$ (V)
Clamping voltage	$I_{pp} = 1$ A, $t_p = 8/20$ $\mu$ s	-	-	5.3	$V_C$ (V)
	$I_{pp} = 10$ A, $t_p = 8/20$ $\mu$ s	-	-	10	$V_C$ (V)
	$I_{pp} = 25$ A, $t_p = 8/20$ $\mu$ s	-	-	15	$V_C$ (V)
Junction capacitance	$V_{RWM} = 0$ V, $f = 1$ MHz	-	8	15	$C_J$ (pF)
	$V_{RWM} = 0$ V, $f = 1$ MHz; Between I/O pins and GND	-	4	-	$C_J$ (pF)

**STSP84050U800**

Parameter	Test condition	Minimum	Typical	Maximum	Symbol (Units)
Reverse working voltage	-	-	-	5	$V_{RWM}$ (V)
Reverse breakdown voltage	$I_T = 1$ mA	6	-	-	$V_{BR}$ (V)
Reverse leakage current	$V_{RWM} = 5$ V	-	-	10	$I_R$ ( $\mu$ A)
Clamping voltage	$I_{pp} = 1$ A, $t_p = 8/20$ $\mu$ s	-	-	9.8	$V_C$ (V)
	$I_{pp} = 10$ A, $t_p = 8/20$ $\mu$ s	-	-	12	$V_C$ (V)
	$I_{pp} = 25$ A, $t_p = 8/20$ $\mu$ s	-	-	20	$V_C$ (V)
Junction capacitance	$V_{RWM} = 0$ V, $f = 1$ MHz	-	8	15	$C_J$ (pF)
	$V_{RWM} = 0$ V, $f = 1$ MHz; Between I/O pins and GND	-	4	-	$C_J$ (pF)

**STSP84150B601**

Parameter	Test condition	Minimum	Typical	Maximum	Symbol (Units)
Reverse working voltage	-	-	-	15	$V_{RWM}$ (V)
Reverse breakdown voltage	$I_T = 1$ mA	16.5	-	-	$V_{BR}$ (V)
Reverse leakage current	$V_{RWM} = 15$ V	-	-	1	$I_R$ ( $\mu$ A)
Peak pulse current	$t_p = 8/20$ $\mu$ s	-	-	12	$I_{pp}$ (A)
Clamping voltage	$I_{pp} = 1$ A, $t_p = 8/20$ $\mu$ s	-	-	24	$V_C$ (V)
	$I_{pp} = 12$ A, $t_p = 8/20$ $\mu$ s	-	-	30	$V_C$ (V)
Junction capacitance	$V_{RWM} = 0$ V, $f = 1$ MHz	-	-	60	$C_J$ (pF)

**Mechanical parameters, pad layout- mm/inches**

**STSP84033U800, STSP84050U800& STSP84150B601**

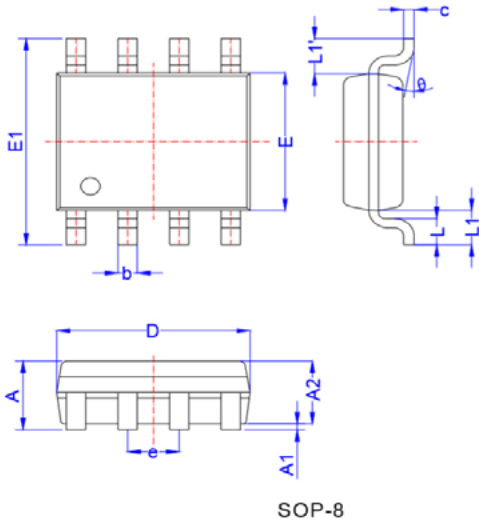

Dimension	Millimeters			Inches		
	Min.	Typ.	Max.	Min.	Typ.	Max.
A	1.40		1.70	0.055		0.067
A1	0.05		0.15	0.002		0.006
A2	1.35		1.55	0.053		0.061
b	0.31		0.51	0.012		0.020
c	0.17		0.25	0.007		0.010
D	4.70		5.10	0.185		0.201
E	3.80		4.00	0.150		0.157
E1	5.80		6.20	0.228		0.244
e	1.14	1.27	1.40	0.045	0.050	0.055
L	0.62		0.77	0.024		0.030
L1	1.00	1.02	1.04	0.039	0.040	0.041
L1-L1'			0.12			0.005
θ	0°		8°	0°		8°

**STSP84028U120&STSP84028UL65**

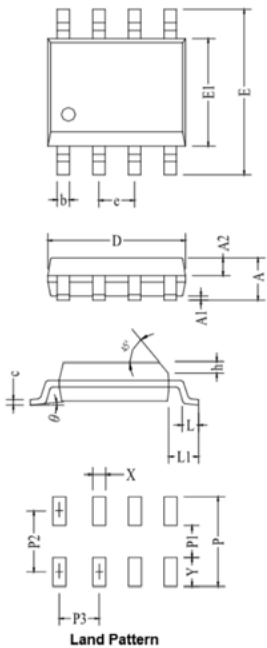

Dimension	Millimeters		Inches	
	Min.	Max.	Min.	Max.
A	1.35	1.75	0.053	0.069
A1	0.10	0.25	0.004	0.010
A2	0.67	0.77	0.026	0.030
b	0.33	0.51	0.013	0.020
c	0.17	0.25	0.007	0.010
D	4.70	5.10	0.185	0.201
e	1.27 BSC		0.05 BSC	
E	5.80	6.20	0.228	0.244
E1	3.80	4.00	0.150	0.157
h	0.25	0.50	0.010	0.020
θ	0°	8°	0°	8°
L	0.40	1.27	0.016	0.050
L1	1.04 BSC		0.041 BSC	
X	0.60		0.24	
Y	2.20		0.037	
P	7.40		0.291	
P1	3.00		0.118	
P2	5.20		0.205	
P3	1.27		0.050	

**Part marking**

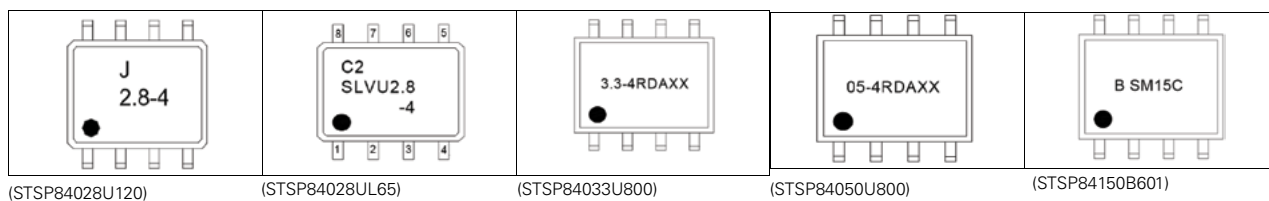

**Packaging information mm/inches**

Drawing not to scale.

Supplied in tape and reel packaging, 2,500 parts per 7" diameter reel (EIA-481 compliant)

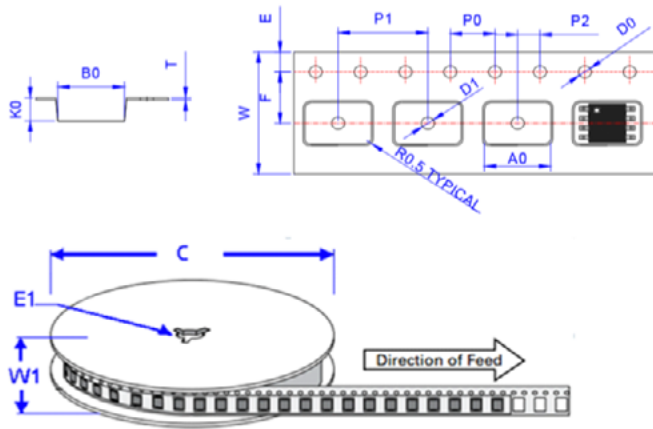

Ref.	Dimensions	
	Millimeters	Inches
A0	6.6±0.10	0.260 ± 0.004
B0	5.3±0.10	0.209 ± 0.004
C	330	13.0
D0	1.50±0.10	0.059 + 0.004
D1	1.50±0.10	0.059 + 0.004
E1	13.3±0.3	0.524± 0.012
E	1.75±0.1	0.069± 0.004
F	5.5±0.05	0.217 ± 0.002
K0	2.1±0.1	0.083 ± 0.004
P0	4.0±0.1	0.157± 0.004
P1	8.0±0.1	0.315± 0.004
P2	2.0±0.05	0.079 ± 0.002
T	0.24±0.1	0.009 ± 0.002
W	12.0±0.3	0.472 ± 0.012
W1	15.7±2.0	0.618 ± 0.079

**Ratings and V-I characteristic curves** (+25 °C unless otherwise noted)

**V- I curve characteristics (Uni-directional)**

STSP84028U120, STSP84028UL65, STSP84033U800

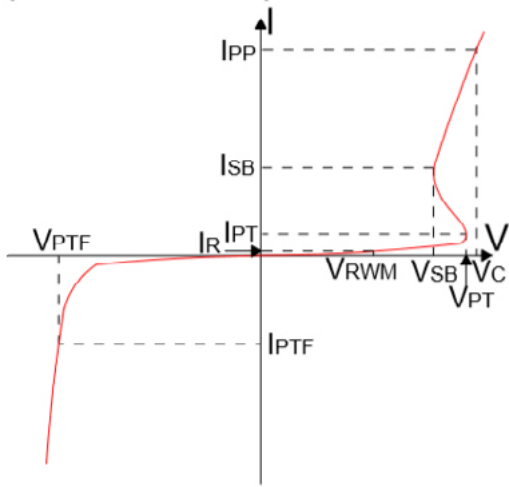

**V- I curve characteristics (Uni-directional)**

STSP84050U800

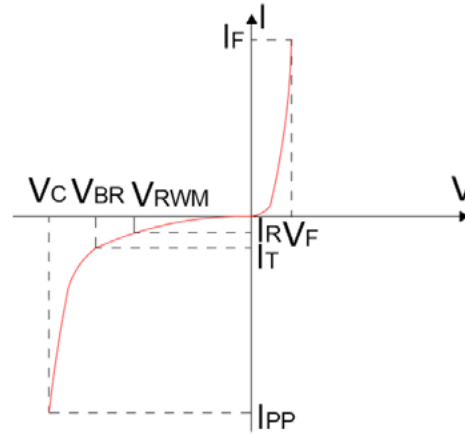

**V- I curve characteristics (Bi-directional)**

STSP84150B601

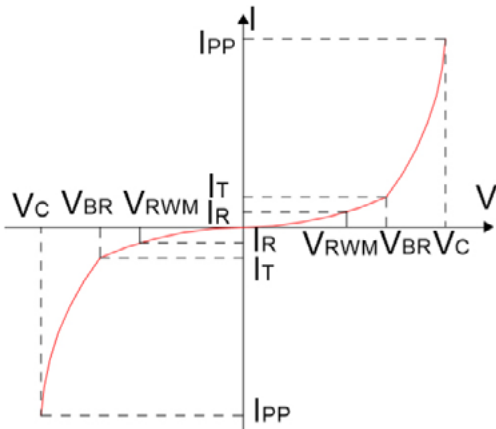

**Pulse waveform (8/20 μs)**

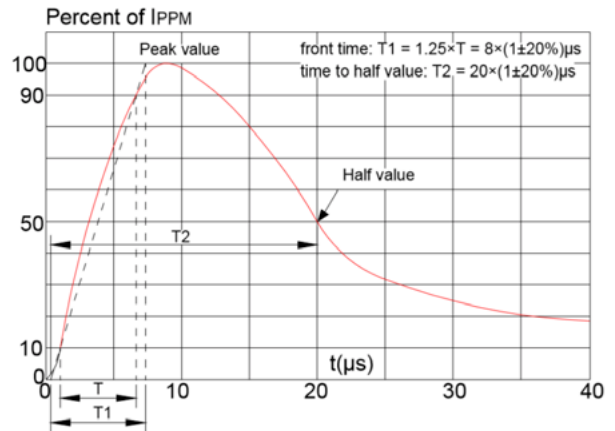

**Pulse derating curve**

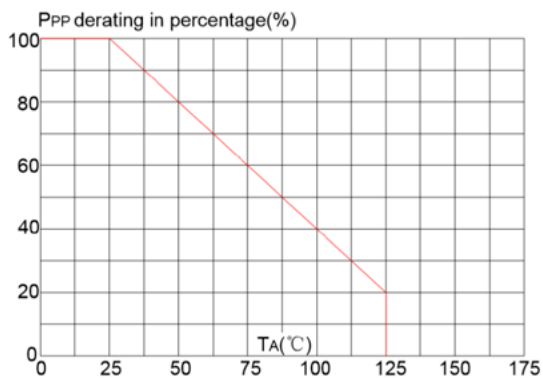

**ESD waveform**

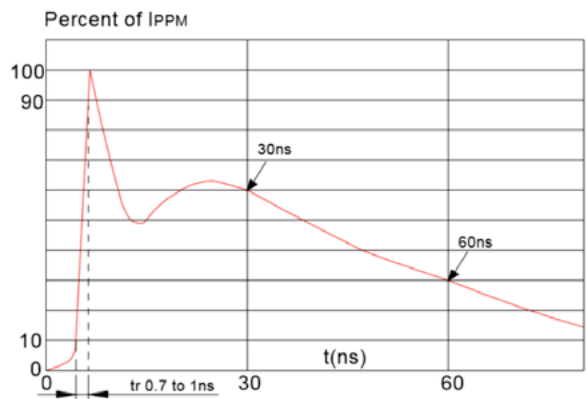

**Application information**

STSP84028U120 can be configured in different connections to meet the requirement of common-mode and differential-mode as shown in the diagrams below.

**Four line uni-directional common-mode protection**

- Pin 1 is connected to Line 1
- Pin 3 is connected to Line 2
- Pin 5 is connected to Line 3
- Pin 7 is connected to Line 4
- Pin 2, 4, 6 and 8 are connected to ground

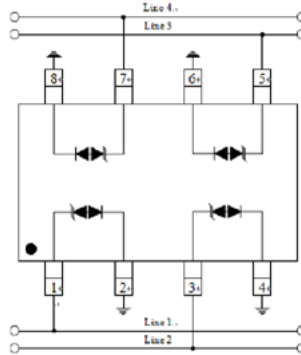

**Two Line bi-directional common-mode protection**

- Pin 1 & 4 is connected to Line 1
- Pin 5 & 8 is connected to Line 2
- Pin 2, 3, 6 and 7 are connected to ground

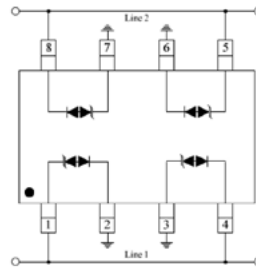

**Two line pairs bi-directional differential-mode protection**

- Pin 1, 2, 7 and 8 are connected to Line 1
- Pair 1 Pin 3, 4, 5 and 6 are connected to Line Pair 2

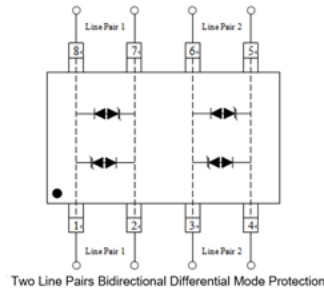

**Gigabit ethernet ESD/surge protection**

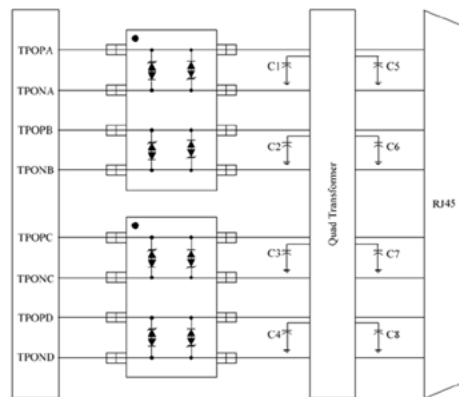

Schematic Diagram for Gigabit Ethernet ESD/ Surge Protection

### Solder reflow profile

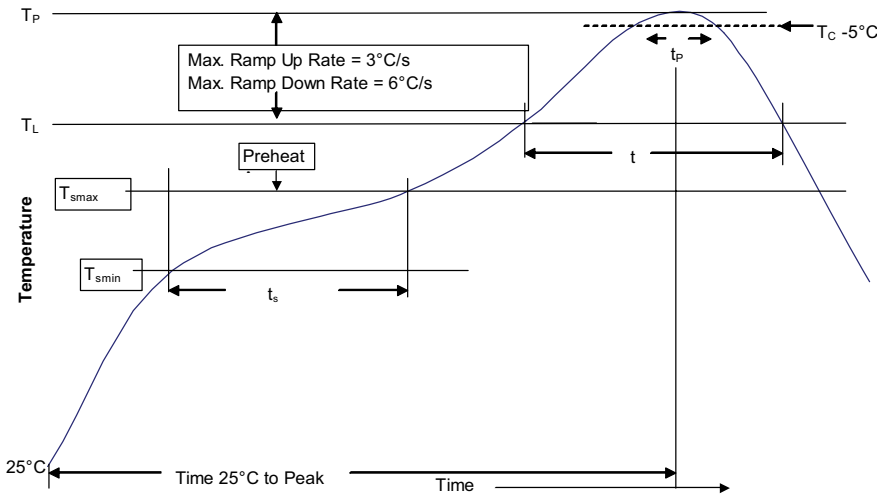

**Table 1 - Standard SnPb solder ( $T_c$ )**

Package thickness	Volume mm <sup>3</sup> <350	Volume mm <sup>3</sup> ≥350
<2.5 mm	235 °C	220 °C
≥2.5 mm	220 °C	220 °C

**Table 2 - Lead (Pb) free solder ( $T_c$ )**

Package thickness	Volume mm <sup>3</sup> <350	Volume mm <sup>3</sup> 350 - 2000	Volume mm <sup>3</sup> >2000
<1.6 mm	260 °C	260 °C	260 °C
1.6 – 2.5 mm	260 °C	250 °C	245 °C
>2.5 mm	250 °C	245 °C	245 °C

### Reference J-STD-020

Profile feature	Standard SnPb solder	Lead (Pb) free solder
Preheat and soak	<ul style="list-style-type: none"> <li>Temperature min. (<math>T_{smin}</math>)</li> <li>Temperature max. (<math>T_{smax}</math>)</li> <li>Time (<math>T_{smin}</math> to <math>T_{smax}</math>) (<math>t_s</math>)</li> </ul>	<ul style="list-style-type: none"> <li>100 °C</li> <li>150 °C</li> <li>60-120 seconds</li> </ul>
Ramp up rate $T_L$ to $T_p$	3 °C/ second max.	3 °C/ second max.
Liquidous temperature ( $T_L$ ) Time ( $t_L$ ) maintained above $T_L$	183 °C 60-150 seconds	217 °C 60-150 seconds
Peak package body temperature ( $T_p$ )*	Table 1	Table 2
Time ( $t_p$ )* within 5 °C of the specified classification temperature ( $T_c$ )	20 seconds*	30 seconds*
Ramp-down rate ( $T_p$ to $T_L$ )	6 °C/ second max.	6 °C/ second max.
Time 25 °C to peak temperature	6 minutes max.	8 minutes max.

\* Tolerance for peak profile temperature ( $T_p$ ) is defined as a supplier minimum and a user maximum.

Life Support Policy: Eaton does not authorize the use of any of its products for use in life support devices or systems without the express written approval of an officer of the Company. Life support systems are devices which support or sustain life, and whose failure to perform, when properly used in accordance with instructions for use provided in the labeling, can be reasonably expected to result in significant injury to the user.

Eaton reserves the right, without notice, to change design or construction of any products and to discontinue or limit distribution of any products. Eaton also reserves the right to change or update, without notice, any technical information contained in this bulletin.

**Eaton**  
Electronics Division  
1000 Eaton Boulevard  
Cleveland, OH 44122  
United States  
Eaton.com/electronics

© 2020 Eaton  
All Rights Reserved  
Printed in USA  
Publication No. 11160 BU-MC20142  
September 2020

Eaton is a registered trademark.  
All other trademarks are property of their respective owners.

Follow us on social media to get the latest product and support information.





## X-ON Electronics

Largest Supplier of Electrical and Electronic Components

*Click to view similar products for [ESD Suppressors / TVS Diodes](#) category:*

*Click to view products by [Eaton](#) manufacturer:*

Other Similar products are found below :

[60KS200C](#) [D12V0H1U2WS-7](#) [D18V0L1B2LP-7B](#) [82356050220](#) [D5V0M5U6V-7](#) [NTE4902](#) [P4KE27CA](#) [P6KE11CA](#) [P6KE39CA-TP](#)  
[P6KE8.2A](#) [SA110CA](#) [SA60CA](#) [SA64CA](#) [SMBJ12CATR](#) [SMBJ8.0A](#) [SMLJ30CA-TP](#) [ESD101-B1-02ELS E6327](#) [ESD112-B1-02EL E6327](#)  
[ESD119B1W01005E6327XTSA1](#) [ESD5V0L1B02VH6327XTSA1](#) [ESD7451N2T5G](#) [19180-510](#) [CPDT-5V0USP-HF](#) [3.0SMCJ33CA-F](#)  
[3.0SMCJ36A-F](#) [HSPC16701B02TP](#) [D3V3Q1B2DLP3-7](#) [D55V0M1B2WS-7](#) [DESD5V0U1BL-7B](#) [DRTR5V0U4SL-7](#) [SCM1293A-04SO](#)  
[ESD200-B1-CSP0201 E6327](#) [ESD203-B1-02EL E6327](#) [SM12-7](#) [SMF8.0A-TP](#) [SMLJ45CA-TP](#) [CEN955 W/DATA](#) [82350120560](#)  
[82356240030](#) [VESD12A1A-HD1-GS08](#) [CPDUR5V0R-HF](#) [CPDUR24V-HF](#) [CPDQC5V0U-HF](#) [CPDQC5V0USP-HF](#) [CPDQC5V0-HF](#)  
[D1213A-01LP4-7B](#) [D1213A-02WL-7](#) [ESDLIN1524BJ-HQ](#) [5KP100A](#) [5KP15A](#)