

# 2410TD

## High current time-delay SMT Brick fuse



### Product features

- 2410 (6125 metric) surface mount package
- Time-delay
- Designed to UL248
- Overcurrent protection of systems up to 250 Vac/60 Vdc
- Current rating: 500 mA to 7.0 A
- High inrush withstand capability
- Moisture sensitivity level: (MSL): 1

### Applications

- Power supplies
- Servers
- LED lighting drivers
- Appliances and white goods
- LCD monitor/backlight inverters
- Vac chip-on-board (COB) lighting
- Industrial electronics and computing

### Agency information

cURus Recognition file number: E19180



### Environmental compliance



### Ordering part number

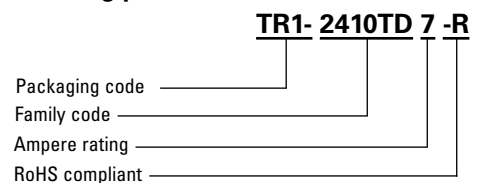

### Packaging prefix

TR1-(1000 parts on a 8.66" diameter tape and reel, 1 reel per box)

PK-(1000 parts on a 8.66" diameter tape and reel, 10 reels per carton)



Powering Business Worldwide

### Electrical characteristics

Amp Rating	% of Amp rating	Opening time
500 mA to 7 A	100	4 hours minimum
500 mA to 7 A	200	1 to 60 seconds

### Product specifications

Part number	Current rating (A)	Voltage rating (Vac)	Voltage rating (Vdc)	Interrupting rating <sup>1</sup> at rated voltage (A)	Interrupting rating <sup>1</sup> at rated voltage (A) (Vdc)	Typical DC cold resistance <sup>2</sup> (ohm)	Typical voltage drop (mV)	Part marking
2410TD500-R	0.5	250	60	50	50	0.4025	245	T0.5
2410TD750-R	0.75	250	60	50	50	0.235	250	T0.75
2410TD1-R	1	250	60	50	50	0.168	256	T1
2410TD1-5-R	1.5	250	60	50	50	0.063	125	T1.5
2410TD2-R	2	250	60	50	50	0.048	133	T2
2410TD2-5-R	2.5	250	60	50	50	0.035	130	T2.5
2410TD3-R	3	250	60	50	50	0.0263	97	T3
2410TD3-5-R	3.5	250	60	50	50	0.0195	95	T3.5
2410TD4-R	4	250	60	50	50	0.0185	106	T4
2410TD5-R	5	250	60	50	50	0.0133	100	T5
2410TD7-R	7	250	60	50	50	0.0087	99	T7

1. AC Interrupting rating (measured at designated voltage, 100% power factor random closing); DC Interrupting rating (measured at designated voltage, time constant of less than 50 microseconds, battery source)

2. DC Cold Resistance measured at <10% of rated current in the ambient temperature of +25 °C

### Dimensions- mm

Drawing not to scale

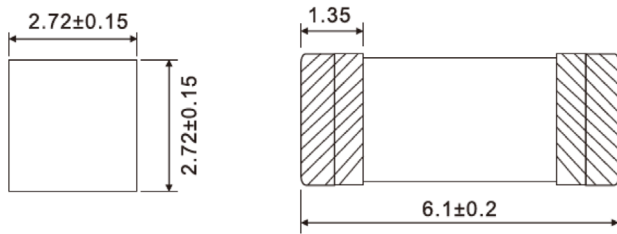

### Recommended pad layout

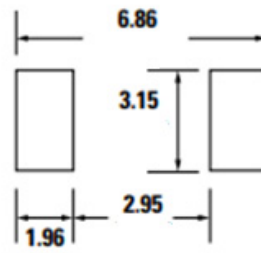

### General specifications

Operating temperature: -55 °C to +125 °C with proper derating factor applied

Soldering heat resistance: MIL-STD-202 method 210

Solderability test: J-STD-002, method B1

Thermal shock: MIL-STD-202 method 107, -55 °C/+125 °C, 200 cycles

Humidity bias: MIL-STD-202 method 103, 1000 hours

Vibration: MIL-STD-202F method 204

Mechanical shock: MIL-STD-202 method 213, condition A

Life test: MIL-STD-202 method 108, test condition D

**Packaging information - mm**

1000 parts per 8.66" diameter reel (EIA-481 compliant)  
Drawing not to scale

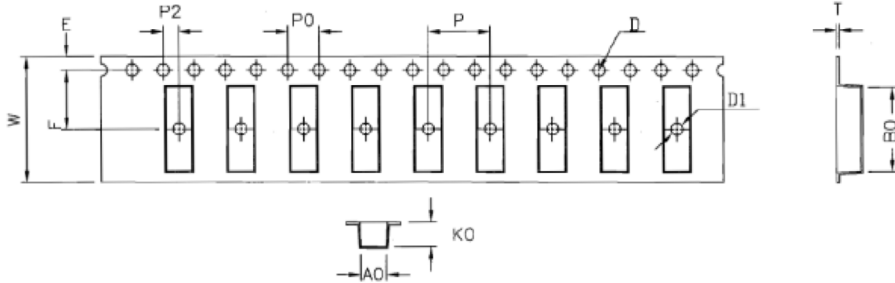

Dimension	millimeter
W	16.00
A0	2.95
B0	6.30
K0	3.00
P0	4.00
P	8.00
P2	2.00
T	0.35
E	1.80
F	7.50
D	1.50
D1	1.50

**Reel dimension- mm**

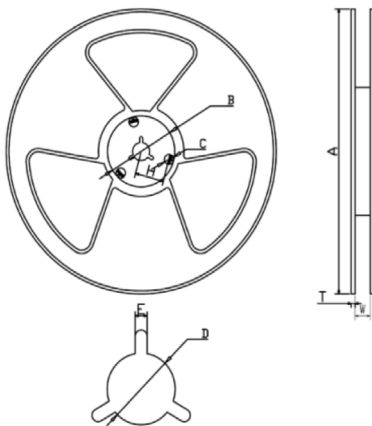

Dimension	millimeter
A	220
B	58
D	13
E	2.3
W	21
T	1.6

**Temperature derating curve**

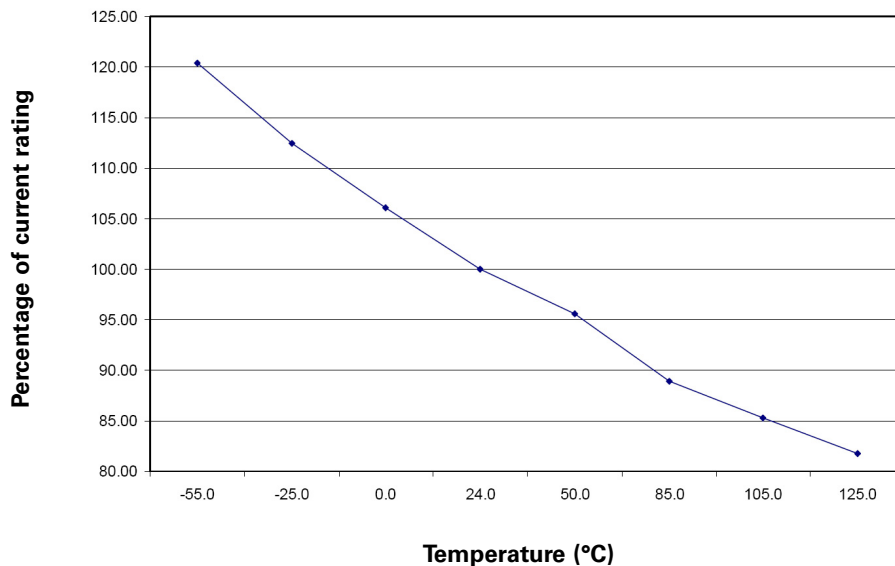

**Current vs. time curve**

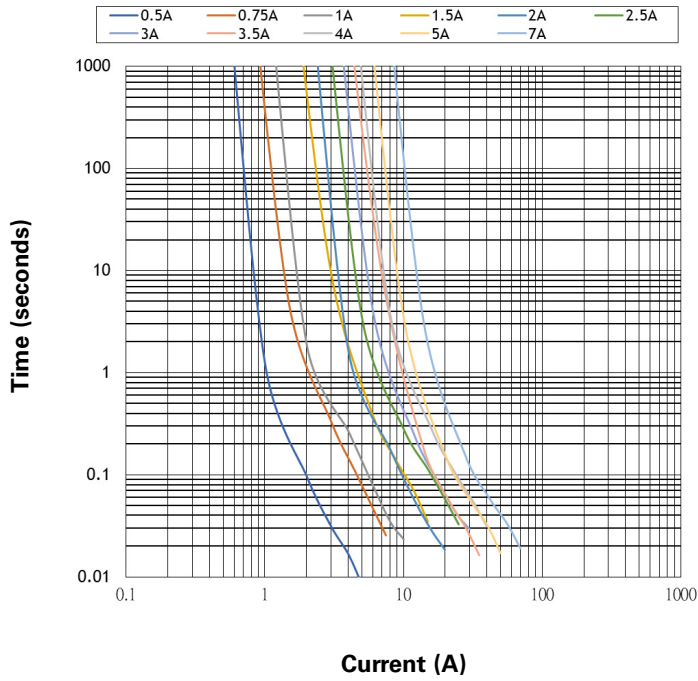

**I<sup>2</sup>t vs time curve**

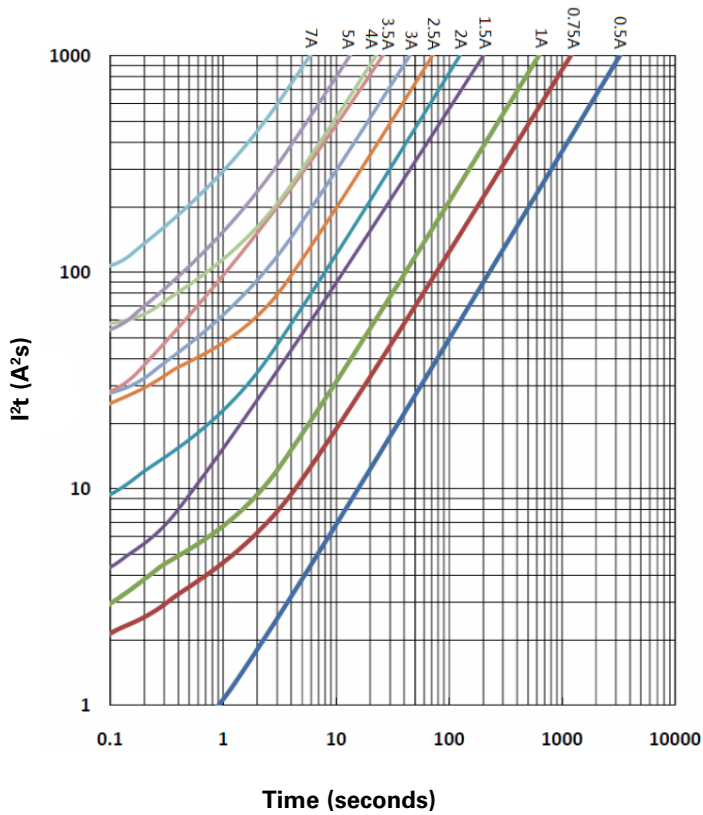

**I<sup>2</sup>t vs current curve**

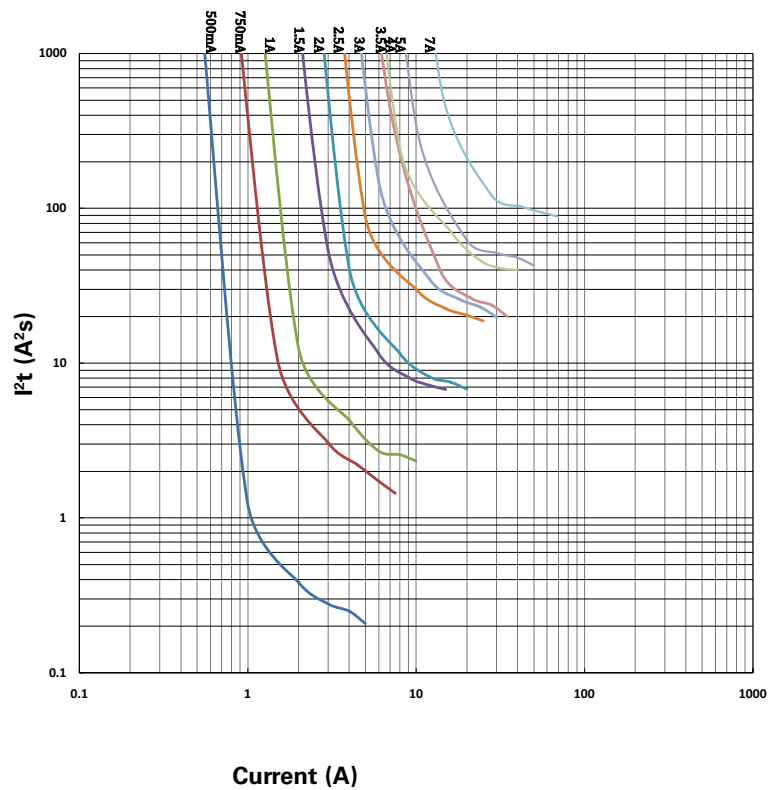

**Wave solder profile**

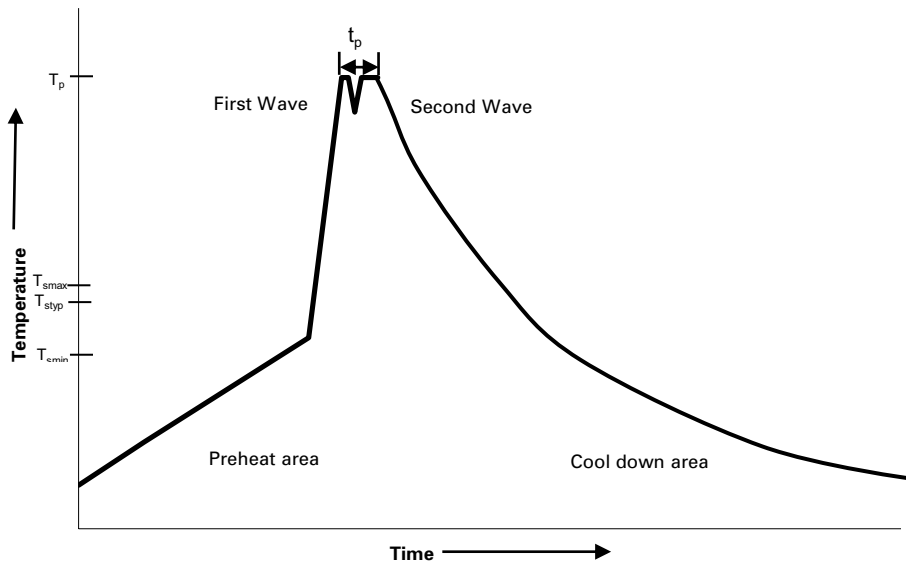

**Reference EN 61760-1:2006**

Profile feature	Standard SnPb solder	Lead (Pb) free solder
Preheat	• Temperature min. ( $T_{smin}$ )	100 °C
	• Temperature typ. ( $T_{styp}$ )	120 °C
	• Temperature max. ( $T_{smax}$ )	130 °C
	• Time ( $T_{smin}$ to $T_{smax}$ ) ( $t_s$ )	70 seconds
$\Delta$ preheat to max Temperature	150 °C max.	150 °C max.
Peak temperature ( $T_p$ )*	235 °C – 260 °C	250 °C – 260 °C
Time at peak temperature ( $t_p$ )	10 seconds max 5 seconds max each wave	10 seconds max 5 seconds max each wave
Ramp-down rate	~ 2 K/s min ~3.5 K/s typ ~5 K/s max	~ 2 K/s min ~3.5 K/s typ ~5 K/s max
Time 25 °C to 25 °C	4 minutes	4 minutes

**Manual solder**

+350 °C (4-5 seconds by soldering iron), generally manual/hand soldering is not recommended.

**Solder reflow profile**

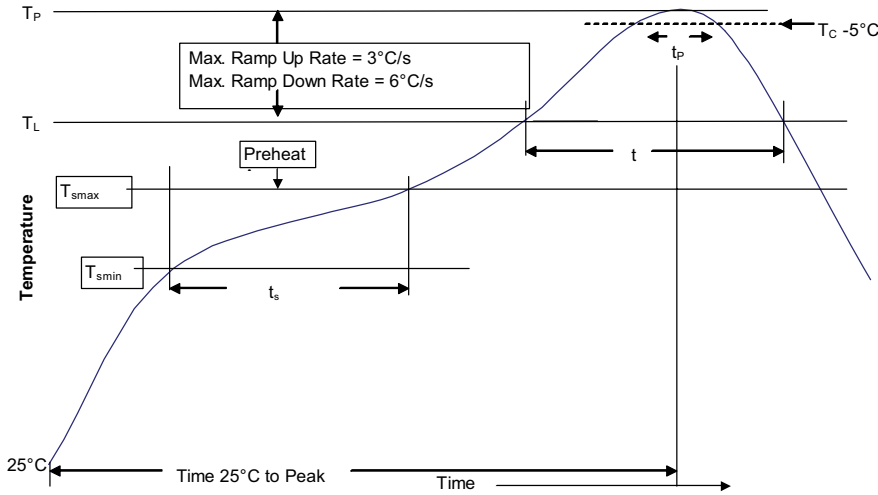

**Table 1 - Standard SnPb solder ( $T_c$ )**

Package thickness	Volume mm <sup>3</sup> <350	Volume mm <sup>3</sup> ≥350
<2.5 mm	235 °C	220 °C
≥2.5 mm	220 °C	220 °C

**Table 2 - Lead (Pb) free solder ( $T_c$ )**

Package thickness	Volume mm <sup>3</sup> <350	Volume mm <sup>3</sup> 350 - 2000	Volume mm <sup>3</sup> >2000
<1.6 mm	260 °C	260 °C	260 °C
1.6 – 2.5 mm	260 °C	250 °C	245 °C
>2.5 mm	250 °C	245 °C	245 °C

**Reference J-STD-020**

Profile feature	Standard SnPb solder	Lead (Pb) free solder
Preheat and soak	<ul style="list-style-type: none"> <li>Temperature min. (<math>T_{smin}</math>)</li> <li>Temperature max. (<math>T_{smax}</math>)</li> <li>Time (<math>T_{smin}</math> to <math>T_{smax}</math>) (<math>t_s</math>)</li> </ul>	<ul style="list-style-type: none"> <li>100 °C</li> <li>150 °C</li> <li>60-120 seconds</li> </ul>
Ramp up rate $T_L$ to $T_p$	3 °C/ second max.	3 °C/ second max.
Liquidous temperature ( $T_L$ ) Time ( $t_L$ ) maintained above $T_L$	<ul style="list-style-type: none"> <li>183 °C</li> <li>60-150 seconds</li> </ul>	<ul style="list-style-type: none"> <li>217 °C</li> <li>60-150 seconds</li> </ul>
Peak package body temperature ( $T_p$ )*	Table 1	Table 2
Time ( $t_p$ )* within 5 °C of the specified classification temperature ( $T_c$ )	20 seconds*	30 seconds*
Ramp-down rate ( $T_p$ to $T_L$ )	6 °C/ second max.	6 °C/ second max.
Time 25 °C to peak temperature	6 minutes max.	8 minutes max.

\* Tolerance for peak profile temperature ( $T_p$ ) is defined as a supplier minimum and a user maximum.

Life Support Policy: Eaton does not authorize the use of any of its products for use in life support devices or systems without the express written approval of an officer of the Company. Life support systems are devices which support or sustain life, and whose failure to perform, when properly used in accordance with instructions for use provided in the labeling, can be reasonably expected to result in significant injury to the user.

Eaton reserves the right, without notice, to change design or construction of any products and to discontinue or limit distribution of any products. Eaton also reserves the right to change or update, without notice, any technical information contained in this bulletin.

**Eaton**  
Electronics Division  
1000 Eaton Boulevard  
Cleveland, OH 44122  
United States  
Eaton.com/electronics

© 2022 Eaton  
All Rights Reserved  
Printed in USA  
Publication No. ELX1195 BU-ELX22055  
May 2022

Eaton is a registered trademark.  
All other trademarks are property of their respective owners.

Follow us on social media to get the latest product and support information.



## X-ON Electronics

Largest Supplier of Electrical and Electronic Components

*Click to view similar products for [Cartridge Fuses](#) category:*

*Click to view products by [Eaton](#) manufacturer:*

Other Similar products are found below :

[MBO-20](#) [MDM-4/10](#) [MDQ-V-15/100](#) [MDV-2-1/4](#) [MDX-1-6/10](#) [MDX-2](#) [MDX-3-2/10](#) [MDX-6-1/4](#) [FLSR-15](#) [FLSR-30](#) [FRS-1-6/10](#) [FRS-4/10](#) [H362003](#) [ABC-2](#) [1/2A](#) [AGC-15EX](#) [AGC-V-3-12-R](#) [AGY-50](#) [15019-G](#) [MSL-1-1/2](#) [MSL-3](#) [MSL-5](#) [BK1/C436-2A](#) [BK1/S500-3.15-R](#) [BK1-S501-3-15-R](#) [BK1-S505-1-R](#) [BK1-S505-5-R](#) [BK/C515S-250-R](#) [S501-V-10A](#) [301030](#) [303030](#) [FLA10](#) [FLA-4/10](#) [FLNR-5](#) [20.0M6.3X32F](#) [FSC-3.5A](#) [301001](#) [301020](#) [311008](#) [31301.5H-XP](#) [313.25](#) [313.75](#) [334006](#) [361.250](#) [362001](#) [36202.5](#) [362.500](#) [3AG3](#) [3AG5](#) [3AG8](#)