

Controlling & Switching

- Switches
- Installation Contactors
- Relays
- Signalling Devices
- Transformers

SG10611



SG59411



SG83911



SG82911







SG84611



wa_sg04311







Controlling & Switching

Main Load Disconnecter Switch (Isolator) IS						
	Rated Current (A)	Poles	Type Designation	Article No.	Units per package	
	16	1	IS-16/1	276254	12 / 120	
	16	2	IS-16/2	276255	1 / 60	
	16	3	IS-16/3	276256	1 / 40	
	16	4	IS-16/4	276257	1 / 30	
	20	1	IS-20/1	276258	12 / 120	
	20	2	IS-20/2	276259	1 / 60	
	20	3	IS-20/3	276260	1 / 40	
	20	4	IS-20/4	276261	1 / 30	
	25	1	IS-25/1	276262	12 / 120	
		25	2	IS-25/2	276263	1 / 60
25		3	IS-25/3	276264	1 / 40	
25		4	IS-25/4	276265	1 / 30	
32		1	IS-32/1	276266	12 / 120	
32		2	IS-32/2	276267	1 / 60	
32		3	IS-32/3	276268	1 / 40	
32		4	IS-32/4	276269	1 / 30	
40		1	IS-40/1	276270	12 / 120	
40		2	IS-40/2	276271	1 / 60	
		40	3	IS-40/3	276272	1 / 40
	40	4	IS-40/4	276273	1 / 30	
	63	1	IS-63/1	276274	12 / 120	
	63	2	IS-63/2	276275	1 / 60	
	63	3	IS-63/3	276276	1 / 40	
	63	4	IS-63/4	276277	1 / 30	
	80	1	IS-80/1	276278	12 / 120	
	80	2	IS-80/2	276279	1 / 60	
	80	3	IS-80/3	276280	1 / 40	
	80	4	IS-80/4	276281	1 / 30	
	100	1	IS-100/1	276282	12 / 120	
	100	2	IS-100/2	276283	1 / 60	
	100	3	IS-100/3	276284	1 / 40	
	100	4	IS-100/4	276285	1 / 30	
	125	1	IS-125/1	276286	12 / 120	
	125	2	IS-125/2	276287	1 / 60	
	125	3	IS-125/3	276288	1 / 40	
	125	4	IS-125/4	276289	1 / 30	
		Accessories				
		Switching interlock without lock for Isolators, RCDs, combined RCD/MCBs, ...		IS/SPE-1TE	101911	5 / 30
Terminal cover			Z-IS/AK-1TE	276290	10 / 600	

xPole

Controlling & Switching

Circuit Breaker ZP-A					
		Number of Poles/Rated Operational Current	Type Designation	Article No.	Units per package
 <p>SG00912</p>	1	40A	ZP-A40/1	248263	12 / 120
	2	40A	ZP-A40/2	248264	1 / 60
	3	40A	ZP-A40/3	248265	1 / 40
	3+N	40A	ZP-A40/3N	248266	1 / 30
	1	63A	ZP-A63/1	284906	12 / 120
	2	63A	ZP-A63/2	284907	1 / 60
	3	63A	ZP-A63/3	284908	1 / 40
	3+N	63A	ZP-A63/3N	284909	1 / 30
Miniature Circuit Breakers (MCBs) for Auxiliary Circuits PLSM-B4/-HS, CLS6-B4/-HS					
		Poles / Rated Breaking Capacity	Type Designation	Article No.	Units per package
 <p>SG54312</p>	1	10kA	PLSM-B4-HS	247221	2 / 120
	2	10kA	PLSM-B4/2-HS	247222	1 / 60
	1	6kA	CLS6-B4-HS	247969	2 / 120
	1+N	6kA	CLS6-B4/1N-HS	247970	2 / 80
	2	6kA	CLS6-B4/2-HS	247971	1 / 60
	Pushbutton Z-T/				
		Colour of Button/Function	Type Designation	Article No.	Units per package
 <p>SG37112</p>	green	4NO	Z-T/4S-G	248328	12 / 120
	black	3NO+1NC	Z-T/3S10	248330	12 / 120
Control Switch Z-S../					
		Rated Current (A)/Function	Type Designation	Article No.	Units per package
 <p>SG38912</p>	16	3NO	Z-S/3S	248334	12 / 120
	16	4NO	Z-S/4S	248335	12 / 120
	16	2NO+2NC	Z-S/SSOO	248337	12 / 120
	16	3NO+1NC	Z-S/3S10	248338	12 / 120
	Changeover Switch Z-S/W				
		Function	Type Designation	Article No.	Units per package
 <p>SG39012</p>	1CO	I-0-II	Z-S/WM	248345	12 / 120
	2CO	I-0-II	Z-S/2WM	248346	12 / 120
	1CO	DAY-0-NIGHT	Z-S/WTN	248347	12 / 120
	2CO	DAY-0-NIGHT	Z-S/2WTN	248348	12 / 120

Controlling & Switching

Switch Z-SW, Z-SWL

- Z-SWL: with LED
- 16 A 250 VAC

SG59911



Rated voltage LED	Function	Type Designation	Article No.	Units per package
–	1NO	Z-SW/S	276300	2 / 120
–	2NO	Z-SW/SS	276301	2 / 120
–	1NO+1NC	Z-SW/SO	276302	2 / 120
–	1CO	Z-SW/W	276303	2 / 120
24 V AC/DC	2NO	Z-SWL24/SS	276304	2 / 120
24 V AC/DC	1NO+1NC	Z-SWL24/SO	276305	2 / 120
230 V AC/DC	1NO	Z-SWL230/S	292300	2 / 120
230 V AC/DC	2NO	Z-SWL230/SS	276306	2 / 120
230 V AC/DC	1NO+1NC	Z-SWL230/SO	276307	2 / 120

Additional LED colours, voltages and contact functions upon enquiry.

wa_sg02512



Z-EK/25

Busbar block

1-pole straight grey 10mm ²	Z-SV-10/1P-F/13	264918	10
1-pole straight blue 10mm ²	Z-SV-10/N-F/13	264919	10
1-pole straight grey 16mm ²	Z-SV-16/1P-1TE/F	269523	25
1-pole straight blue 16mm ²	Z-SV-16/N-1TE/F	269524	25
Extension terminal 25mm ² long, straight	Z-EK/25	264935	10 / 600
Extension terminal 25mm ² short, straight	Z-EK/25/K	269525	10 / 600
Extension terminal 25mm ² long, crosswise	Z-EK/25/QL	264937	10 / 600
Extension terminal 25mm ² short, crosswise	Z-EK/25/Q	264936	10 / 600

xPole

Controlling & Switching

SG59211



Z-BEL/R230

Signal Lamps

Rated voltage	LED colour	Type Designation	Article No.	Units per package
Single Lamp Z-EL				
24 V AC/DC	orange	Z-EL/OR24	275444	2 / 120
24 V AC/DC	white	Z-EL/WH24	107493	2 / 120
230 V AC/DC	red	Z-EL/R230	284921	2 / 120
230 V AC/DC	green	Z-EL/G230	284922	2 / 120
230 V AC/DC	orange	Z-EL/OR230	275865	2 / 120
230 V AC/DC	blue	Z-EL/BL230	103131	2 / 120
230 V AC/DC	white	Z-EL/WH230	107494	2 / 120
Twin Lamp Z-DLD				
2 x 24 V AC/DC	red + green	Z-DLD/2/24	284926	2 / 120
2 x 230 V AC/DC	red + green	Z-DLD/2/230	284925	2 / 120
2 x 24 V AC/DC	white + white	Z-DLD/WH24	108897	2 / 120
2 x 230 V AC/DC	white + white	Z-DLD/WH230	108898	2 / 120
Universal Single Lamp - changeover function Z-UEL				
24 V AC/DC	red/green	Z-UEL24	284924	2 / 120
230 V AC/DC	red/green	Z-UEL230	284923	2 / 120
Universal Twin Lamp - changeover function Z-UDL				
2 x 24 V AC/DC	red/green	Z-UDL24	284928	2 / 120
2 x 230 V AC/DC	red/green	Z-UDL230	284927	2 / 120
Signal Lamp - with integrated flash function Z-BEL				
24 V AC/DC	red	Z-BEL/R24	284931	2 / 120
24 V AC/DC	green	Z-BEL/G24	284932	2 / 120
230 V AC/DC	red	Z-BEL/R230	284929	2 / 120
230 V AC/DC	green	Z-BEL/G230	284930	2 / 120

Pushbutton Unit Z-PU, Z-PUL

- Z-PUL: with LED
- 16 A 250 VAC

SG59811



Rated voltage LED	Function	Type Designation	Article No.	Units per package
–	1NO	Z-PU/S	276291	2 / 120
–	2NO	Z-PU/SS	276292	2 / 120
–	1NO+1NC	Z-PU/SO	276293	2 / 120
–	2NC	Z-PU/OO	276294	2 / 120
24 V AC/DC	2NO	Z-PUL24/SS	276295	2 / 120
24 V AC/DC	1NO+1NC	Z-PUL24/SO	276296	2 / 120
230 V AC/DC	2NO	Z-PUL230/SS	276297	2 / 120
230 V AC/DC	1NO+1NC	Z-PUL230/SO	276298	2 / 120
230 V AC/DC	2NC	Z-PUL230/OO	276299	2 / 120

Controlling & Switching

Rotary Switch Z-DS

SG85211



Z-DSU1-102

SG85311



Z-DSA2-01-SL

Function/Switching Position	Type Designation	Article No.	Units per package
1pole OFF 0 - 1	Z-DSA1-01	248868	1 / 40
1pole CHANGE 1 - 0 - 2	Z-DSU1-102	248869	1 / 40
1pole CHANGE HA - 0 - AU	Z-DSU1-H0A	248870	1 / 40
1pole CHANGE TA - 0 - NA	Z-DSU1-T0N	248871	1 / 40
2pole OFF 0 - 1	Z-DSA2-01	248872	1 / 40
2pole OFF 0 - 1	Z-DSA2-01-SL	248873	1 / 40
2pole CHANGE 1 - 2	Z-DSU2-12	248874	1 / 40
2pole CHANGE 1 - 0 - 2	Z-DSU2-102	248875	1 / 40
2pole CHANGE HA - 0 - AU	Z-DSU2-H0A	248876	1 / 40
3pole CHANGE 1 - 0 - 2	Z-DSU3-102	248877	1 / 40
Voltmeter L-N L1 - N...	Z-DSV-LN	248878	1 / 40
Voltmeter L-L L1 - L2...	Z-DSV-LL	248879	1 / 40
Voltmeter L+N L1 - N3...	Z-DSV-LLN	248880	1 / 40
Amperemeter 0-1-2-3	Z-DSAM-0123	129712	1 / 40

Relay for low-level signals RE

- electronic relay
- 2 relays for separate energizing with one changeover contact each relay per frame

SG83411



Control Voltage	Function	MU	Type Designation	Article No.	Units per package
24-230V AC/DC	1CO+1CO	1	RELLVA	120854	1 / 40
24-230V AC/DC	1CO+1CO	1	REHLVA	120855	1 / 40
24-230V AC/DC	1CO+1CO	1	REMLVA	120856	1 / 40

xPole

Controlling & Switching

Installation Relays Z-R., Z-TN

SG12211



Z-R12/S

SG60411



Z-R230/2S2O

Control Voltage/Function/MU	Type Designation	Article No.	Units per package
-----------------------------	------------------	-------------	-------------------

Type Z-R

- with manual operation
- 20 A 250 VAC $\text{—} \text{—} \text{—} \text{—}$ AC1

240 V 50Hz	2NO	1	Z-R240/SS	285525	2 / 120
240 V 60Hz	2NO	1	Z-R241/SS	265166	2 / 120
240 V 60Hz	2NC	1	Z-R241/SO	265179	2 / 120
230 V 50Hz	1NO	1	Z-R230/S	265149	2 / 120
230 V 50Hz	2NO	1	Z-R230/SS	265168	2 / 120
230 V 50Hz	4NO	2	Z-R230/4S	265226	1 / 60
230 V 50Hz	1NO+1NC	1	Z-R230/SO	265181	2 / 120
230 V 50Hz	2NO+2NC	2	Z-R230/2S2O	265215	1 / 60
230 V 50Hz	3NO+1NC	2	Z-R230/3S1O	265221	1 / 60
230 V 50Hz	2NC	1	Z-R230/OO	265188	2 / 120
230 V 50Hz	4NC	2	Z-R230/4O	265228	1 / 60
230 V 60Hz	2NO	1	Z-R231/SS	265167	2 / 120
230 V 60Hz	1NO+1NC	1	Z-R231/SO	265180	2 / 120
110 V 50Hz	2NO	1	Z-R110/SS	265170	2 / 120
110 V 50Hz	2NO+2NC	2	Z-R110/2S2O	265216	1 / 60
110 V 50Hz	3NO+1NC	2	Z-R110/3S1O	265222	1 / 60
110 V 60Hz	2NO	1	Z-R111/SS	265169	2 / 120
110 V DC	2NO	1	Z-R109/SS	265171	2 / 120
110 V DC	1NO+1NC	1	Z-R109/SO	265182	2 / 120
110 V DC	2NO+2NC	2	Z-R109/2S2O	265217	1 / 60
110 V DC	3NO+1NC	2	Z-R109/3S1O	265223	1 / 60
48 V 50Hz	2NO	1	Z-R48/SS	265172	2 / 120
24 V 50Hz	1NO	1	Z-R24/S	265160	2 / 120
24 V 50Hz	2NO	1	Z-R24/SS	265173	2 / 120
24 V 50Hz	4NO	2	Z-R24/4S	265227	1 / 60
24 V 50Hz	1NO+1NC	1	Z-R24/SO	265183	2 / 120
24 V 50Hz	2NO+2NC	2	Z-R24/2S2O	265218	1 / 60
24 V 50Hz	3NO+1NC	2	Z-R24/3S1O	265224	1 / 60
24 V 50Hz	2NC	1	Z-R24/OO	265189	2 / 120
24 V 50Hz	4NC	2	Z-R24/4O	265229	1 / 60
24 V 60Hz	2NO	1	Z-R25/SS	248368	2 / 120
24 V DC	1NO	1	Z-R23/S	265161	2 / 120
24 V DC	2NO	1	Z-R23/SS	265174	2 / 120
24 V DC	1NO+1NC	1	Z-R23/SO	265184	2 / 120
24 V DC	2NO+2NC	2	Z-R23/2S2O	265219	1 / 60
24 V DC	4NC	2	Z-R23/4O	101910	1 / 60
12 V 50Hz	1NO	1	Z-R12/S	265162	2 / 120
12 V 50Hz	2NO	1	Z-R12/SS	265175	2 / 120
12 V 50Hz	1NO+1NC	1	Z-R12/SO	265185	2 / 120
12 V 50Hz	2NO+2NC	2	Z-R12/2S2O	265220	1 / 60
12 V 50Hz	3NO+1NC	2	Z-R12/3S1O	265225	1 / 60
12 V DC	1NO	1	Z-R11/S	265163	2 / 120
12 V DC	2NO	1	Z-R11/SS	265176	2 / 120
12 V DC	1NO+1NC	1	Z-R11/SO	265186	2 / 120
12 V DC	2NC	1	Z-R11/OO	290198	2 / 120
8 V 50Hz	1NO	1	Z-R8/S	265164	2 / 120
8 V 50Hz	2NO	1	Z-R8/SS	265177	2 / 120
8 V 50Hz	1NO+1NC	1	Z-R8/SO	265187	2 / 120
8 V DC	1NO	1	Z-R7/S	265165	2 / 120
8 V DC	2NO	1	Z-R7/SS	265178	2 / 120

xPole

Controlling & Switching

SG59411



Z-RE24/S

SG59111



Z-RK230/SS

SG59711



Z-TN230/SO

SG60111



Z-TN230/3S

Control Voltage/Function/MU	Type Designation	Article No.	Units per package
Type Z-RE			
• with LED, without manual operation			
• 20 A 250 VAC $\text{—} \text{—}$			
230 V 50Hz	1NO	1 Z-RE230/S	265190 2 / 120
230 V 50Hz	2NO	1 Z-RE230/SS	265193 2 / 120
230 V 50Hz	1NO+1NC	1 Z-RE230/SO	265197 2 / 120
230 V 50Hz	2NO+2NC	2 Z-RE230/2S2O	265230 1 / 60
230 V 50Hz	3NO+1NC	2 Z-RE230/3S1O	265235 1 / 60
24 V 50Hz	1NO	1 Z-RE24/S	265191 2 / 120
24 V 50Hz	2NO	1 Z-RE24/SS	265194 2 / 120
24 V 50Hz	1NO+1NC	1 Z-RE24/SO	265198 2 / 120
24 V 50Hz	2NO+2NC	2 Z-RE24/2S2O	265231 1 / 60
24 V 50Hz	3NO+1NC	2 Z-RE24/3S1O	265236 1 / 60
24 V DC	1NO	1 Z-RE23/S	265192 2 / 120
24 V DC	2NO	1 Z-RE23/SS	265195 2 / 120
24 V DC	1NO+1NC	1 Z-RE23/SO	265199 2 / 120
24 V DC	2NO+2NC	2 Z-RE23/2S2O	265232 1 / 60
12 V 50Hz	2NO+2NC	2 Z-RE12/2S2O	265233 1 / 60
12 V 50Hz	3NO+1NC	2 Z-RE12/3S1O	265237 1 / 60
12 V DC	2NO+2NC	2 Z-RE11/2S2O	265234 1 / 60
8 V 50Hz	2NO	1 Z-RE8/SS	265196 2 / 120

Control Voltage/Function/MU	Type Designation	Article No.	Units per package
Type Z-RK			
• with manual operation and LED			
• 20 A 250 VAC $\text{—} \text{—}$ AC1			
230 V 60Hz	2NO	1 Z-RK241/SS	265202 2 / 120
230 V 60Hz	2NC	1 Z-RK241/SO	265207 2 / 120
230 V 50Hz	1NO	1 Z-RK230/S	265200 2 / 120
230 V 50Hz	2NO	1 Z-RK230/SS	265203 2 / 120
230 V 50Hz	1NO+1NC	1 Z-RK230/SO	265208 2 / 120
230 V 50Hz	2NO+2NC	2 Z-RK230/2S2O	265238 1 / 60
230 V 50Hz	3NO+1NC	2 Z-RK230/3S1O	265241 1 / 60
230 V 50Hz	2NC	1 Z-RK230/OO	265213 2 / 120
110 V DC	2NO	1 Z-RK109/SS	265204 2 / 120
24 V 50Hz	1NO	1 Z-RK24/S	265201 2 / 120
24 V 50Hz	2NO	1 Z-RK24/SS	265205 2 / 120
24 V 50Hz	1NO+1NC	1 Z-RK24/SO	265209 2 / 120
24 V 50Hz	2NO+2NC	2 Z-RK24/2S2O	265239 1 / 60
24 V 50Hz	3NO+1NC	2 Z-RK24/3S1O	265242 1 / 60
24 V 50Hz	2NC	1 Z-RK24/OO	265214 2 / 120
24 V DC	2NO	1 Z-RK23/SS	265206 2 / 120
24 V DC	1NO+1NC	1 Z-RK23/SO	265210 2 / 120
24 V DC	2NO+2NC	2 Z-RK23/2S2O	271464 1 / 60
12 V 50Hz	1NO+1NC	1 Z-RK12/SO	265211 2 / 120
12 V 50Hz	2NO+2NC	2 Z-RK12/2S2O	265240 1 / 60
12 V 50Hz	3NO+1NC	2 Z-RK12/3S1O	265243 1 / 60
8 V 50Hz	1NO+1NC	1 Z-RK8/SO	265212 2 / 120

Other control voltages, frequencies, and contact functions upon enquiry.

Control Voltage/Function/MU	Type Designation	Article No.	Units per package
Type Z-TN			
• with manual pre-selection of functions - permanently ON / AUTOM / OFF			
• 20 A 250 VAC $\text{—} \text{—}$			
230 V 50Hz	2NO	1 Z-TN230/SS	265574 2 / 120
230 V 50Hz	3NO	2 Z-TN230/3S	265576 1 / 60
230 V 50Hz	4NO	2 Z-TN230/4S	265579 1 / 60
230 V 50Hz	1NO+1NC	1 Z-TN230/1S1O	267975 2 / 120
230 V 50Hz	2NO+2NC	2 Z-TN230/2S2O	103168 1 / 60
24 V 50Hz	2NO	1 Z-TN24/SS	267976 2 / 120
24 V 50Hz	3NO	2 Z-TN24/3S	267977 1 / 60
24 V 50Hz	4NO	2 Z-TN24/4S	267978 1 / 60
24 V 50Hz	1NO+1NC	1 Z-TN24/1S1O	267979 2 / 120

xPole

Controlling & Switching

wa_sg02512



Z-EK/25

Accessories

Spacer 0.5 MU	Z-DST	248949	10
---------------	-------	--------	----

Busbar block for Impulse Relays, Relays, Control and Switching Devices (Series Z-PU, Z-SW)

1-pole straight grey 10mm ²	Z-SV-10/1P-F/13	264918	10
1-pole straight blue 10mm ²	Z-SV-10/N-F/13	264919	10
1-pole straight grey 16mm ²	Z-SV-16/1P-1TE/F	269523	25
1-pole straight blue 16mm ²	Z-SV-16/N-1TE/F	269524	25
Extension terminal 25mm ² long, straight	Z-EK/25	264935	10 / 600
Extension terminal 25mm ² short, straight	Z-EK/25/K	269525	10 / 600
Extension terminal 25mm ² long, crosswise	Z-EK/25/QL	264937	10 / 600
Extension terminal 25mm ² short, crosswise	Z-EK/25/Q	264936	10 / 600

xPole

Controlling & Switching

Installation Contactors Z-SCH/CMUC

Installation Contactors Z-SCH

SG84611



Z-SCH230/25-40

SG84711



Z-SCH230/63-40

U _s / I _n AC1 / Function	Type Designation	Article No.	Units per package
230VAC 25A 2NO	Z-SCH230/1/25-20	120853	2 / 120
230VAC 25A 4NO	Z-SCH230/25-40	248847	1 / 60
230VAC 25A 4NC	Z-SCH230/25-04	248848	1 / 60
230VAC 25A 3NO+1NC	Z-SCH230/25-31	248846	1 / 60
230VAC 25A 2NO+2NC	Z-SCH230/25-22	248849	1 / 60
24VAC 25A 4NO	Z-SCH24/25-40	248851	1 / 60
24VAC 25A 2NO+2NC	Z-SCH24/25-22	248850	1 / 60
230VAC 40A 4NO	Z-SCH230/40-40	248852	1 / 40
230VAC 40A 3NO+1NC	Z-SCH230/40-31	248854	1 / 40
230VAC 40A 2NO+2NC	Z-SCH230/40-22	248853	1 / 40
230VAC 40A 2NO	Z-SCH230/40-20	248855	1 / 40
230VAC 63A 4NO	Z-SCH230/63-40	248856	1 / 40
230VAC 63A 4NC	Z-SCH230/63-04	285735	1 / 40
230VAC 63A 3NO+1NC	Z-SCH230/63-31	248858	1 / 40
230VAC 63A 2NO+2NC	Z-SCH230/63-22	248857	1 / 40
230VAC 63A 2NO	Z-SCH230/63-20	248859	1 / 40

Installation Contactors CMUC

- Universal Control Voltage U_c AC/DC

SG28812



CMUC230/25-40

U _c / I _n AC1 / Function	Type Designation	Article No.	Units per package
230V AC/DC 25A 4NO	CMUC230/25-40	137309	1 / 60
230V AC/DC 25A 4NC	CMUC230/25-04	137405	1 / 60
230V AC/DC 25A 3NO+1NC	CMUC230/25-31	137401	1 / 60
230V AC/DC 25A 2NO+2NC	CMUC230/25-22	137403	1 / 60
24V AC/DC 25A 4NO	CMUC24/25-40	137308	1 / 60
24V AC/DC 25A 4NC	CMUC24/25-04	137404	1 / 60
24V AC/DC 25A 3NO+1NC	CMUC24/25-31	137400	1 / 60
24V AC/DC 25A 2NO+2NC	CMUC24/25-22	137402	1 / 60

Accessories suitable for Z-SCH / CMUC

SG84311



Z-SC

Sealing cover (25A)	Z-SCHAK-2TE	248860	10
Sealing cover (40, 63A)	Z-SCHAK-3TE	248861	10
Auxiliary switch (1NO+1NC *)	Z-SC	248862	3
Spacer (0.5 MU)	Z-DST	248949	10
Suppressor RC-Combination 12-250 VAC	Z-RC/230	101428	2 / 120

*) NOT suitable for Z-SCH230/1/25-20 (120853)

Controlling & Switching

SG5611



Z-S230/SO

Impulse Relays Z-S

• 16 A 250 VAC

Control Voltage/Function/MU	Type Designation	Article No.	Units per package
240 V 50Hz 1NO 1	Z-S240/S	265261	2 / 120
240 V 50Hz 2NO 1	Z-S240/SS	265269	2 / 120
240 V 50Hz 1NO+1NC 1	Z-S240/SO	265282	2 / 120
240 V 50Hz 2NO+2NC 2	Z-S240/2S2O	265304	1 / 60
240 V 50Hz 1CO 1	Z-S240/W	265289	2 / 120
240 V 50Hz 2CO 2	Z-S240/WW	265311	1 / 60
240 V 60Hz 2NO 1	Z-S241/SS	265268	2 / 120
230 V 50Hz 1NO 1	Z-S230/S	265262	2 / 120
230 V 50Hz 2NO 1	Z-S230/SS	265271	2 / 120
230 V 50Hz 4NO 2	Z-S230/4S	270335	1 / 60
230 V 50Hz 1NO+1NC 1	Z-S230/SO	265283	2 / 120
230 V 50Hz 2NO+2NC 2	Z-S230/2S2O	265305	1 / 60
230 V 50Hz 1CO 1	Z-S230/W	265290	2 / 120
230 V 50Hz 2CO 2	Z-S230/WW	265312	1 / 60
230 V 60Hz 2NO 1	Z-S231/SS	265270	2 / 120
110 V 50Hz 1NO 1	Z-S110/S	265263	2 / 120
110 V 50Hz 2NO 1	Z-S110/SS	265273	2 / 120
110 V 50Hz 1NO+1NC 1	Z-S110/SO	265284	2 / 120
110 V 50Hz 2NO+2NC 2	Z-S110/2S2O	265306	1 / 60
110 V 50Hz 1CO 1	Z-S110/W	265291	2 / 120
110 V 50Hz 2CO 2	Z-S110/WW	265313	1 / 60
110 V 60Hz 2NO 1	Z-S111/SS	265272	2 / 120
110 V DC 2NO 1	Z-S109/SS	265274	2 / 120
110 V DC 1CO 1	Z-S109/W	265292	2 / 120
110 V DC 2CO 2	Z-S109/WW	265314	1 / 60
48VAC/24VDC*) 1NO 1	Z-S48/S	265534	2 / 120
48VAC/24VDC*) 2NO 1	Z-S48/SS	265536	2 / 120
48VAC/24VDC*) 4NO 2	Z-S48/4S	100665	1 / 60
48VAC/24VDC*) 1NO+1NC 1	Z-S48/SO	265538	2 / 120
48VAC/24VDC*) 2NO+2NC 2	Z-S48/2S2O	265540	1 / 60
48VAC/24VDC*) 1CO 1	Z-S48/W	265544	2 / 120
48VAC/24VDC*) 2CO 2	Z-S48/WW	265542	1 / 60
24VAC/12VDC*) 1NO 1	Z-S24/S	265535	2 / 120
24VAC/12VDC*) 2NO 1	Z-S24/SS	265537	2 / 120
24VAC/12VDC*) 1NO+1NC 1	Z-S24/SO	265539	2 / 120
24VAC/12VDC*) 2NO+2NC 2	Z-S24/2S2O	265541	1 / 60
24VAC/12VDC*) 1CO 1	Z-S24/W	265545	2 / 120
24VAC/12VDC*) 2CO 2	Z-S24/WW	265543	1 / 60
24 V 60Hz 2NO 1	Z-S25/SS	265276	2 / 120
12 V 50Hz 1NO 1	Z-S12/S	265266	2 / 120
12 V 50Hz 2NO 1	Z-S12/SS	265278	2 / 120
12 V 50Hz 1NO+1NC 1	Z-S12/SO	265287	2 / 120
12 V 50Hz 2NO+2NC 2	Z-S12/2S2O	265309	1 / 60
12 V 50Hz 1CO 1	Z-S12/W	265296	2 / 120
12 V 50Hz 2CO 2	Z-S12/WW	265317	1 / 60
8 V 50Hz 1NO 1	Z-S8/S	265267	2 / 120
8 V 50Hz 2NO 1	Z-S8/SS	265280	2 / 120
8 V 50Hz 1NO+1NC 1	Z-S8/SO	265288	2 / 120
8 V 50Hz 2NO+2NC 2	Z-S8/2S2O	265310	1 / 60
8 V 50Hz 1CO 1	Z-S8/W	265297	2 / 120
8 V 50Hz 2CO 2	Z-S8/WW	265318	1 / 60
8 V DC 2NO 1	Z-S7/SS	265281	2 / 120
8 V DC 1CO 1	Z-S7/W	265298	2 / 120
8 V DC 2CO 2	Z-S7/WW	265319	1 / 60

*) Double voltage AC/DC

xPole

Controlling & Switching

SG68011



Z-SC230/S

SG69111



Z-SB230/SS

SG58011



Z-S/KO

wa_sg02512



Z-EK/25

SG07312



SG07412



ZRMF1/W

SG07912



ZRMF2/WW

Control Voltage/Function/MU	Type Designation	Article No.	Units per package	
With central control Z-SC				
240 V AC 50/60Hz 3NO	2 Z-SC240/3S	265320	1 / 60	
240 V AC 50/60Hz 1NO+1CO	2 Z-SC240/1S1W	265323	1 / 60	
240 V AC 50/60Hz 2NO+1NC	2 Z-SC240/2S1O	265326	1 / 60	
230 V AC 50/60Hz 1NO	1 Z-SC230/S	265299	2 / 120	
230 V AC 50/60Hz 3NO	2 Z-SC230/3S	265321	1 / 60	
230 V AC 50/60Hz 1NO+1CO	2 Z-SC230/1S1W	265324	1 / 60	
230 V AC 50/60Hz 2NO+1NC	2 Z-SC230/2S1O	265327	1 / 60	
110 V AC 50/60Hz 3NO	2 Z-SC110/3S	265322	1 / 60	
110 V AC 50/60Hz 1NO+1CO	2 Z-SC110/1S1W	265325	1 / 60	
110 V AC 50/60Hz 2NO+1NC	2 Z-SC110/2S1O	265328	1 / 60	
24 V AC 50/60Hz 1NO	1 Z-SC24/S	265300	2 / 120	
With switchable LED Z-SB				
230 V 50Hz	2NO Z-SB230/SS	265301	2 / 120	
24 V 50Hz	2NO Z-SB24/SS	265302	2 / 120	
24 V DC	2NO Z-SB23/SS	265303	2 / 120	
Other control voltages, frequencies, and contact arrangements upon enquiry.				
Accessories for Z-S./.				
Compensator	1 Z-S/KO	270588	2 / 120	
Group block	1 Z-SC/GP	270587	2 / 120	
Busbar block				
1-pole straight grey 10mm ²	Z-SV-10/1P-F/13	264918	10	
1-pole straight blue 10mm ²	Z-SV-10/N-F/13	264919	10	
1-pole straight grey 16mm ²	Z-SV-16/1P-1TE/F	269523	25	
1-pole straight blue 16mm ²	Z-SV-16/N-1TE/F	269524	25	
Extension terminal 25mm ² long, straight	Z-EK/25	264935	10 / 600	
Extension terminal 25mm ² short, straight	Z-EK/25/K	269525	10 / 600	
Extension terminal 25mm ² long, crosswise	Z-EK/25/QL	264937	10 / 600	
Extension terminal 25mm ² short, crosswise	Z-EK/25/Q	264936	10 / 600	
Staircase Switch with switch-off warning and stop function TL				
Function	Type Designation	Article No.	Units per package	
Staircase switch with switch-off warning and stop function	TLE	101064	2 / 120	
Staircase switch as TLE, with additional control input for central control, zero-voltage proof	TLK	101066	2 / 120	
Time-Lag Relay ZR				
Function	Contacts	Type Designation	Article No.	Units per package
E, R	1CO	ZRER/W	110405	2 / 120
E, R, Ws, Wa, Es, Wu, Bp	1CO	ZRMF1/W	110406	2 / 120
E, R, Ws, Wa, Es, Wu, Bp	2CO	ZRMF2/WW	110408	1 / 60
Ip, li	1CO	ZRTAK/W	110747	2 / 120

Controlling & Switching

Undervoltage Relay REUVM

- Optical indication
Power...green LED
Fault in phases L1, L2, L3...red LED is flashing
Loss of Neutral conductor N...green Power LED is flashing
- Single phase application is possible

SG83511



Switching Voltage / U_N / Kontakte	Type Designation	Article No.	Units per package
$U_N \times 0,85$ 230/400 VAC	1CO REUVM	148598	1
$U_N \times 0,85$ 230/400 VAC	2CO REUVM2	167284	1

Voltage indication UVA

- Optical indication
Voltage of phases L1, L2, L3 is indicated with green LED's even at loss of Neutral conductor N
- Single-phase application, or even possible to use DC

SG00112



Rated operational voltage	Type Designation	Article No.	Units per package
230/400 VAC 50/60Hz	UVA	167285	1

Load Shedding (Current) Relay Z-LAR/

SG78711



Function/Op. Current Range (A)	Type Designation	Article No.	Units per package
NC 3-8	Z-LAR/8-O	248256	1 / 60
NC 10-16	Z-LAR/16-O	248257	1 / 60
NC 15-32	Z-LAR/32-O	248258	1 / 60
NO 3-8	Z-LAR/8-S	248259	1 / 60
NO 10-16	Z-LAR/16-S	248260	1 / 60
NO 15-32	Z-LAR/32-S	248261	1 / 60
CO 3-8	Z-LAR/8-W	248262	1 / 60

Bio-Switch FFS/16

SG08012



	Type Designation	Article No.	Units per package
Bio-Switch	FFS/16	107325	1 / 60

SG09708



Accessories

PHASE OUT

Base load resistor for FFS/16	Z-NKA-SCH	120890	1 / 12
-------------------------------	-----------	--------	--------

Controlling & Switching

SG84011



PHASE OUT

Timers digital TSDW...

Drive	Program	Channels	Type Designation	Article No.	Units per package
Quartz	Week	1 chan.	TSDW1CO	167379	1
Quartz	Week	2 chan.	TSDW2CO	167380	1
DCF/GPS	Week	1 chan.	TSDW1CODG	167382	1
Quartz	Week	1 chan.	TSDW1COMIN	167383	1
Quarz	Day	1 chan.	SA-TD/1W	111450	1

Accessories

DCF antenna for timers digital TSDW1CODG	TSADCF	167384	1
GPS antenna with power supply for TSDW1CODG	TSAGPSKIT	167385	1
PC Set + memory card for SRCD1CO, TSDW1CO, TSDW2CO, TSDW1COA, TSDW1CODG	TSAMEMKIT	167386	1
Memory card	TSAMEM	167387	1

PHASE OUT TYPE

SG2302



Z-SDM/1K-WO

Timers digital Z-SDM

Drive	Program	Channels	Type Designation	Article No.	Units per package
Digital					
Quartz	Day	1 chan.	Z-SDM/1K-TA	248210	1 / 60
Quartz	Week	1 chan.	Z-SDM/1K-WO	248211	1 / 60
Quartz	Week	2 chan.	Z-SDM/2K-WO	248212	1 / 60

Accessories

Terminal cover 2MU	Z7-SDM/AK-2TE	850000317	6
Mounting plate 2MU	Z7-SDM/MP-2TE	850000318	24

Astronomical Timer TSDW1COA, SA-TD/1W

SG84011



PHASE OUT

Drive	Programme	Channels	Type Designation	Article No.	Units per package
Astronomical, digital					
Quartz	Week	1 chan.	TSDW1COA	167381	1
Quartz	Day	1 chan.	SA-TD/1W	111450	1 / 40

Timers analogue TS...

SG83911



Drive	Program	Channels	Type Designation	Article No.	Units per package
Quarz	Day	1 chan.	TSQD1NO	167388	1
Synchron.	Day	1 chan.	TSSD1NO	167389	1
Quarz	Day	1 chan.	TSQD1CO	167390	1
Synchron.	Day	1 chan.	TSSD1CO	167391	1
Quarz	Week	1 chan.	TSQW1CO	167392	1

Controlling & Switching

PHASE OUT TYPE

Timers analogue SU-T

SG12107



SU-TQ/1W-TA

SG12407



SU-TQ/TA

Drive	Programme	Channels	Type Designation	Article No.	Units per package
-------	-----------	----------	------------------	-------------	-------------------

Analogue

Synchron.	Day	1 chan.	SU-TS/TA	111442	1 / 120
Synchron.	Day	1 chan.	SU-TS/1W-TA	111443	1 / 40
Synchron.	Week	1 chan.	SU-TS/WO	111444	1 / 40
Quartz	Day	1 chan.	SU-TQ/TA	111445	1 / 120
Quartz	Day	1 chan.	SU-TQ/1W-TA	111446	1 / 40
Quartz	Week	1 chan.	SU-TQ/1W-WO	111447	1 / 40
Quartz	Week	2 chan.	SU-TQ/2W-TW	111448	1 / 40

Light Intensity Switch SR...

SG84111



Switching contact / Light intensity	Type Designation	Article No.	Units per package
-------------------------------------	------------------	-------------	-------------------

1NO	2-100 Lux	SRSD1NO	167375	1
1NO	2-2000 Lux	SRSW1NO	167376	1
1CO	with timer	SRCD1CO	167377	1
1CO	2-2000 Lux	SRSD1COW	167378	1

PHASE OUT TYPE

Light Intensity Switch for wall mounting DS-TA, DS-TD

SG11107



DS-TA/WA

SG11207



DS-TD/WA

Switching contact / Light intensity	Type Designation	Article No.	Units per package
-------------------------------------	------------------	-------------	-------------------

1NO	5 - 200 Lux	DS-TA/WA	111454	1 / 40
1NO	2 - 2000 Lux	DS-TA/VWA	111455	1 / 40
1NO + watch	2 - 200 Lux	DS-TD/WA	111456	1 / 40

PHASE OUT TYPE

Light Intensity Switch for support rail assembly DS-TA, DS-TD

SG11807



DS-TA/1S

SG11607



DS-TD/1W

Switching contact / Light intensity	Type Designation	Article No.	Units per package
-------------------------------------	------------------	-------------	-------------------

1NO	2 - 100 Lux	DS-TA/1S	111451	1 / 40
1CO	2 - 2000 Lux	DS-TA/1W	111452	1 / 40
1CO + watch	2 - 2000 Lux	DS-TD/1W	111453	1 / 40

Accessories

Spare Built-in Light Sensor	Z-DS/S-E	111457	1 / 40
Spare External Light Sensor	Z-DS/S-A	111458	1 / 40

SG47412



Z-DS/S-A

Controlling & Switching

PHASE OUT TYPE

Light Intensity Switch Z.-LMS

SG2402



Z-LMS

	Type Designation	Article No.	Units per package
Support rail assembly	Z-LMS	248218	1
Accessories			
Spare sensor for Z-LMS	Z7-LMS/SENSOR	850000754	1 / 6
Terminal cover 2MU	Z7-SDM/AK-2TE	850000317	2
Mounting plate 2MU	Z7-SDM/MP-2TE	850000318	24

xPole

Controlling & Switching

xSystem EASY Control Relay

EASY Control Relay

230 V AC, Display

wa_sg03211, wa_sg02511



Inputs	Outputs	Type Designation	Article No.	Units per package
8 x 230 V AC	4 x Relay 8A	EASY512-AC-RC	274104	1
12 x 230 V AC	6 x Relay 8A	EASY719-AC-RC	274115	1
12 x 230 V AC	6 x Relay 8A	EASY819-AC-RC	256267	1

24 V DC, Display, Analog Value Processing

wa_sg02811, wa_sg02611



Inputs	Outputs	Type Designation	Article No.	Units per package
8 x 24 V DC	4 x Relay 8A	EASY512-DC-RC	274109	1
8 x 24 V DC	4 x Transistor	EASY512-DC-TC	274111	1
12 x 24 V DC	6 x Relay 8A	EASY719-DC-RC	274119	1
12 x 24 V DC	8 x Transistor	EASY721-DC-TC	274121	1
12 x 24 V DC	6 x Relay 8A	EASY819-DC-RC	256269	1
12 x 24 V DC	8 x Transistor	EASY821-DC-TC	256273	1

EASY Multifunction Display - MFD

230 V AC, Graphical Display, Degree of Protection IP66

wa_sg02411



	Type Designation	Article No.	Units per package
LCD-display, 80 mm, with keys	MFD-80-B	265251	1
CPU power supply for MFD, AC	MFD-AC-CP8-NT	274092	1
230V inputs, relay outputs	MFD-AC-R16	274093	1

24 V DC, Graphical Display, Degree of Protection IP66

wa_sg02411



	Type Designation	Article No.	Units per package
LCD-display, 80 mm, with keys	MFD-80-B	265251	1
CPU power supply for MFD, DC	MFD-CP8-NT	265253	1
Inputs 24 V DC, relay outputs	MFD-R16	265254	1
Inputs 24 V DC, transistor outputs	MFD-T16	265255	1
Inputs 24 V DC, relay outputs, analog	MFD-RA17	265364	1
Inputs 24 V DC, transistor outputs, analog	MFD-TA17	265256	1

Accessories for EASY and MFD

	Type Designation	Article No.	Units per package
Operating and programming software	EASY-SOFT-BASIC	284545	1
Operating and programming software incl. graphic editor	EASY-SOFT-PRO	266040	1
USB-PC programming cable easy400 to easy700	EASY-USB-CAB	107926	1
USB-PC programming cable easy800 and multifunction display	EASY800-USB-CAB	106408	1
Power supply, 24VDC, 0.2A	EASY200-POW	229424	1
Power supply, 24VDC, 1.25A	EASY400-POW	212319	1
Power supply, 24VDC, 2.5A	EASY500-POW	110941	1

Controlling & Switching

PHASE OUT TYPE

Communication Center Z-CC/2CO

- Universal remote monitoring and controlling via SMS based on GSM

SG42612



Description	Type Designation	Article No.	Units per package
2 Change-over contacts	Z-CC/2CO	119383	1

Accessories for Z-CC/2CO

Power supply unit (24V 0.2A)	EASYPOW200	229424	1
Temperature sensor	Z-CC/2CO-SE	119430	1
Patch cord 2.0 m	DNW-PX/0200/RJ45/RJ45/5E/CSUTP/GR/PV	237271	1

PHASE OUT TYPE

Signalling Devices: Buzzer Z-SUM, Bell Z-GLO

SG27712



Function/Rated Voltage (V~)	Type Designation	Article No.	Units per package
Buzzer 230	Z-SUM230	270584	2 / 120
Buzzer 24	Z-SUM24	270583	2 / 120
Buzzer 12	Z-SUM12	271087	2 / 120
Bell 230	Z-GLO230	270586	2 / 120
Bell 24	Z-GLO24	270585	2 / 120
Bell 12	Z-GLO12	271088	2 / 120

Signalling Devices AS

wa_sg04311



ASBELL230

Function/Rated Voltage (V~)	Type Designation	Article No.	Units per package
Bell 230V AC	ASBELL230	167393	1
Bell 12V AC	ASBELL12	167394	1
Buzzer 230V AC	ASBUZZ230	167395	1
Siren 24V AC/DC	ASSIR24	167396	1

Transformers 230V, TR-G

Bell-Transformers 230V, TR-G.

- Type -S with primary switch

SG82911



MU	Sec.-Volt. (V)	Sec.-Current (A)	Type Designation	Article No.	Units per package
2	8	1	TR-G/8	272480	1 / 28
2	4-8-12	1-1-0,67	TR-G3/8	272481	1 / 28
2	8	1	TR-G/8-S	272482	1 / 28
2	4-8-12	2-2-1,5	TR-G3/18	272483	1 / 28
3	12-24	2-1	TR-G2/24	272484	1 / 20

Controlling & Switching

Safety-Transformers 230V, TR-G./..-SF.

- 100% ED

SG42512



MU	Sec.-Volt. (V)	Sec.-Current (A)	Type Designation	Article No.	Units per package
5	12-24	5,2-2,6	TR-G2/63-SF	272485	1 / 12

xPole

Controlling & Switching

xCommand RMQ Titan® Command and Signalling Devices

- Complete units for front installation

Push-button, flat, 1 NO + 1 NC

wa_sg00912



Description	Type Designation	Article No.	Units per package
spring-return, black	M22-D-S-K11	SET000001	1
spring-return, white	M22-D-W-K11	SET000002	1
spring-return, red	M22-D-R-K11	SET000003	1
spring-return, green	M22-D-G-K11	SET000004	1
spring-return, yellow	M22-D-Y-K11	SET000005	1
spring-return, blue	M22-D-B-K11	SET000006	1
stay-put, black	M22-DR-S-K11	SET000007	1
stay-put, white	M22-DR-W-K11	SET000008	1
stay-put, red	M22-DR-R-K11	SET000009	1
stay-put, green	M22-DR-G-K11	SET000010	1
stay-put, yellow	M22-DR-Y-K11	SET000011	1
stay-put, blue	M22-DR-B-K11	SET000012	1

Push-button, flat, LED 230 V, 1 NO + 1 NC

wa_sg00912



Description	Type Designation	Article No.	Units per package
spring-return, white	M22-DL-W-K11-230-W	SET000013	1
spring-return, red	M22-DL-R-K11-230-R	SET000014	1
spring-return, green	M22-DL-G-K11-230-G	SET000015	1
spring-return, yellow	M22-DL-Y-K11-230-W	SET000016	1
spring-return, blue	M22-DL-B-K11-230-B	SET000017	1
stay-put, white	M22-DRL-W-K11-230-W	SET000018	1
stay-put, red	M22-DRL-R-K11-230-R	SET000019	1
stay-put, green	M22-DRL-G-K11-230-G	SET000020	1
stay-put, yellow	M22-DRL-Y-K11-230-W	SET000021	1
stay-put, blue	M22-DRL-B-K11-230-B	SET000022	1

Indicator lamp, flat, LED 230 V

wa_sg00612



Description	Type Designation	Article No.	Units per package
white	M22-L-W-230-W	SET000023	1
red	M22-L-R-230-R	SET000024	1
green	M22-L-G-230-G	SET000025	1
yellow	M22-L-Y-230-W	SET000026	1
blue	M22-L-B-230-B	SET000027	1

Selector, 1 NO + 1 NC

wa_sg00712



Description	Type Designation	Article No.	Units per package
2 positions, spring-return	M22-WK-K11	SET000028	1
2 positions, stay-put	M22-WRK-K11	216519	1

Key-operated switch, 1 NO + 1 NC

wa_sg00812





Description	Type Designation	Article No.	Units per package
2 positions, spring-return	M22-WS-K11	SET000029	1
2 positions, stay-put	M22-WRS-K11	216517	1

Controlling & Switching

wa_sg01012



Double push-button, 1 NO + 1 NC with LED

Description	Type Designation	Article No.	Units per package
Double push-button 1 NO + 1 NC with LED	  M22-DDL-GR-X1/X0/K11/230-W	216509	1

Accessories for RMQ Titan®

SG06410



Description	Type Designation	Article No.	Units per package
Din rail adapter	M22-IVS	216400	1
Contact element 1 NO	M22-K10	216376	20
Contact element 1 NC	M22-K01	216378	20

EMERGENCY SWITCH-OFF button, complete unit IP66

wa_sg02911



Description	Type Designation	Article No.	Units per package
Emergency switch-off button, 2 NC, surface-mounted	M22-PV/KC02/IY	216524	1

xCommand LS-TITAN® Command & Signalling Devices

Position switch LS-11, IP66

- 1 NO, 1 NC

wa_sg03111



Actuation	Type Designation	Article No.	Units per package
Cap plunger head	LS-11	266109	10
Roller plunger	LS-11/P	266112	2
Spring-rod head, snap-action switch	LS-11S/S	266104	2
Roller lever	LS-11/L	266110	2
Rotary lever	LS-11/RL	266111	2
Adjustable roller lever	LS-11/RLA	266113	2
Actuating lever, snap-action switch	LS-11S/RR	266106	4

Controlling & Switching

xStart Contactors

DILM Contactors

- Control voltage 230 V 50 Hz, 240 V 60 Hz

wa_sg00111



Rated current (A)	Rated power (kW)	Aux. contact	Type Designation	Article No.	Units per package
7	3	1 NO	DILM7-10(230V50HZ)	276550	1
7	3	1 NC	DILM7-01(230V50HZ)	276585	1
6	4	1 NO	DILM9-10(230V50HZ)	276690	1
6	4	1 NC	DILM9-01(230V50HZ)	276725	1
12	5.5	1 NO	DILM12-10(230V50HZ)	276830	1
12	5.5	1 NC	DILM12-01(230V50HZ)	276865	1
17	7.5	1 NO	DILM17-10(230V50HZ)	277004	1
17	7.5	1 NC	DILM17-01(230V50HZ)	277036	1
25	11	1 NO	DILM25-10(230V50HZ)	277132	1
25	11	1 NC	DILM25-01(230V50HZ)	277164	1
32	15	1 NO	DILM32-10(230V50HZ)	277260	1
32	15	1 NC	DILM32-01(230V50HZ)	277292	1
40	18.5	-	DILM40(230V50HZ)	277766	1
50	22	-	DILM50(230V50HZ)	277830	1
65	30	-	DILM65(230V50HZ)	277894	1

DILM Contactors

- Control voltage 24 VDC

wa_sg00111



Rated current (A)	Rated power (kW)	Aux. contact	Type Designation	Article No.	Units per package
7	3	1 NO	DILM7-10(24VDC)	276565	1
7	3	1 NC	DILM7-01(24VDC)	276600	1
6	4	1 NO	DILM9-10(24VDC)	276705	1
6	4	1 NC	DILM9-01(24VDC)	276740	1
12	5.5	1 NO	DILM12-10(24VDC)	276845	1
12	5.5	1 NC	DILM12-01(24VDC)	276880	1
17	7.5	1 NO	DILM17-10(RDC24)	277018	1
17	7.5	1 NC	DILM17-01(RDC24)	277050	1
25	11	1 NO	DILM25-10(RDC24)	277146	1
25	11	1 NC	DILM25-01(RDC24)	277178	1
32	15	1 NO	DILM32-10(RDC24)	277274	1
32	15	1 NC	DILM32-01(RDC24)	277306	1
40	18.5	-	DILM40(RDC24)	277780	1
50	22	-	DILM50(RDC24)	277844	1
65	30	-	DILM65(RDC24)	277908	1

Motor-protective Relay ZB

- Suitable for DILM7 to DILM32

wa_sg17604



Overload release setting range (A)	Type Designation	Article No.	Units per package
0.1 - 0.16	ZB12-0,16	278431	1
0.16 - 0.25	ZB12-0,24	278432	1
0.25 - 0.4	ZB12-0,4	278433	1
0.4 - 0.63	ZB12-0,6	278434	1
0.63 - 1	ZB12-1	278435	1
1 - 1.6	ZB12-1,6	278436	1
1.6 - 2.5	ZB12-2,4	278437	1
2.5 - 4	ZB12-4	278438	1
4 - 6.3	ZB12-6	278439	1
6.3 - 10	ZB12-10	278440	1
10 - 12	ZB12-12	278441	1
12 - 16	ZB32-16	278452	1
16 - 24	ZB32-24	278453	1
24 - 32	ZB32-32	278454	1

Controlling & Switching

Motor-protective Relay ZB

- Suitable for DILM40 to DILM65

wa_sg17704



Overload release setting range (A)	Type Designation	Article No.	Units per package
6 - 10	ZB65-10	278455	1
10 - 16	ZB65-16	278456	1
16 - 24	ZB65-24	278457	1
24 - 40	ZB65-40	278458	1
40 - 57	ZB65-57	278459	1
50 - 65	ZB65-65	278460	1

Auxiliary Switch Modules DILA-XHI

- Suitable for DILM7 to DILM32

wa_sg17404



NO	NC	Type Designation	Article No.	Units per package
2	–	DILA-XHI20	276422	5
1	1	DILA-XHI11	276421	5
4	–	DILA-XHI40	276428	5
3	1	DILA-XHI31	276427	5
2	2	DILA-XHI22	276426	5

Auxiliary Switch Modules DILM150-XHI

- Suitable for DILM40 to DILM65

wa_sg03011



NO	NC	Type Designation	Article No.	Units per package
2	–	DILM150-XHI20	277945	5
1	1	DILM150-XHI11	277946	5
4	–	DILM150-XHI40	277948	5
3	1	DILM150-XHI31	277949	5
2	2	DILM150-XHI22	277950	5

Controlling & Switching

Main Load Disconnecter Switch (Isolator) IS

- Load circuit breaker with isolating function
- Design according to IEC/EN 60947-3
- Highly wear resistant contacts
- Quick make, black toggle
- Terminal capacity 50 mm²
- Compatible busbars with switchgear series Xpole by use of the mouth terminal in combination with standard fork busbar

Connection diagram

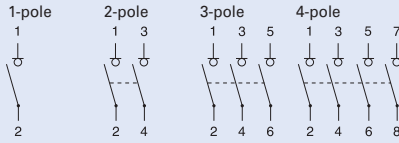

Technical Data

	IS-16	IS-20	IS-25	IS-32	IS-40	IS-63	IS-80	IS-100	IS-125
Electrical									
Design according to	IEC/EN 60947-3								
Rated voltage	240/415V								
Frequency	50/60 Hz								
Rated insulation voltage U _i	690 V~								
Rated peak withstand voltage U _{imp}	6 kV								
Pollution degree	3								
Rated short-time withstand current I _{cw}	2 kA								
Rated short-circuit making capacity I _{cm}	2.8 kA								
Rated current									
240/415V, AC23A	16 A	20 A	25 A	32 A	40 A	63 A	80 A	100 A	125 A
Number of poles	1-, 2-, 3-, 4-pole								
Maximum back-up fuse	125 A gG								
Short circuit strength - with back-up fuse acc. to the applicable rules									
IEC/EN 60947-3	12.5 kA	12.5 kA	12.5 kA	12.5 kA	12.5 kA	12.5 kA	12.5 kA	10 kA	10 kA
Endurance									
electrical comp. op. cycles	≥ 3,000	≥ 3,000	≥ 3,000	≥ 3,000	≥ 3,000	≥ 3,000	≥ 3,000	≥ 3,000	≥ 2,000
mechanical comp. op. cycles	≥ 16,000	≥ 16,000	≥ 16,000	≥ 16,000	≥ 16,000	≥ 16,000	≥ 16,000	≥ 16,000	≥ 14,000

Mechanical

Frame size	45 mm
Device height	80 mm
Device width	17.5mm/pole
Mounting	quick fastening with 2 lock-in positions on DIN rail IEC/EN 60715
Degree of protection, built-in	IP40
Terminal protection	finger and hand touch safe according to BGV A3
Terminals	Twin-purpose terminals
Terminal capacity	2.5 - 50 mm ²
Busbar thickness	0.8-1.0 mm
Fastening torque of terminal screws	2.5 - 5 Nm
Function	irrespective of the position of installation

Dimensions (mm)

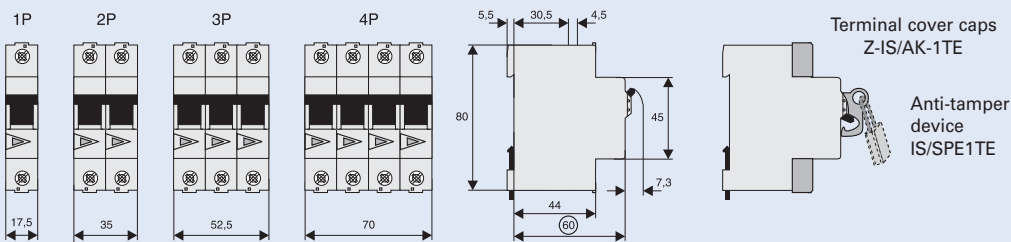

Switching interlock IS/SPE-1TE

- Without lock
- Also suitable for PFIM, CFI6, PKNM, CKN6

Terminal Cover Caps Z-IS/AK-1TE

- Can be sealed with leads
- Modular design, width 1 MU

Controlling & Switching

Circuit Breaker ZP-A

- Design according to IEC/EN 60947-1, -3
- Number of poles: 1, 2, 3, 3N
- Rated current: 40 A, 63 A
- Accessories for switchgear also for ZP-A usable!

Accessories:

Auxiliary switch for subsequent installation	ZP-IHK	286052
	ZP-WHK	286053
Tripping signal contact for subsequent installation	ZP-NHK	248437
Shunt trip release	ZP-ASA/..	248438, 248439
Undervoltage release	Z-USA/..	248288-248291
Compact enclosure	KLV-TC-2	276240
	KLV-TC-4	276241
Additional terminal 35mm ²	Z-HA-EK/35	263960
Switching interlock	Z-IS/SPE-1TE	274418

Connection diagrams

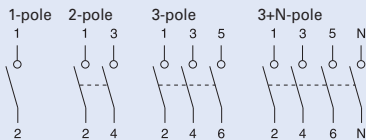

Technical Data

Electrical

Rated operational voltage U_e	230/400 V AC
Rated frequency	50 Hz
Rated insulation voltage U_i	440 VAC
Rated peak withstand voltage U_{imp}	4 kV (1.2/50 μ)
Conventional thermal current I_{th}	
ZP-A40	40 A
ZP-A63	63 A
Utilisation category AC22A	
Rated operational current I_e	
ZP-A40	40 A AC
ZP-A63	63 A AC
Utilisation category AC23A	
Rated operational current I_e	16 A AC
Short circuit strength with back-up fuse 40 A gG	3 kA ($U = 240V, \cos \varphi = 0.87$)
Endurance	
electrical comp.	$\geq 8,000$ operating cycles
mechanical comp.	$\geq 20,000$ operating cycles

Mechanical

Frame size	45 mm
Device height	80 mm
Device width	17.5mm/pole
Mounting	quick fastening on DIN rail IEC/EN 60715
Degree of protection, built-in	IP40
Upper and lower terminals	lift terminals + guide for secure terminal
Terminal protection	finger and hand touch safe, BGV A3, ÖVE-EN 6
Terminal capacity	1.5-25 mm ²
Terminal screws	M5 (Pozidrive) Z2
Tightening torque of terminal screws	max. 2.4 Nm

Dimensions (mm)

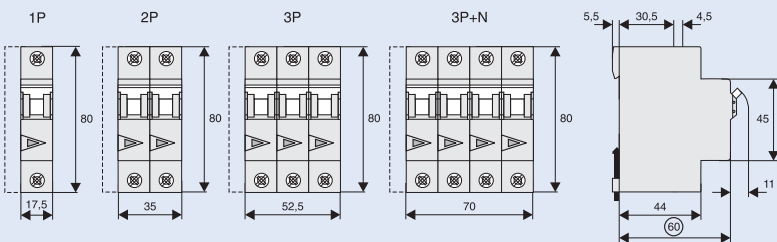

Controlling & Switching

Practical Hint

e.g. 16(2)A ...



Ratings for resistive/inductive consumers

Ratings for incandescent lamp load (AC 5b IEC 60947-4)

ÖVE-SN45, § 305

Practical Hint

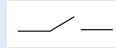

Switching contact in general

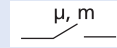

Switch with reduced air gap

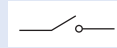

Power circuit breaker

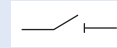

Disconnector

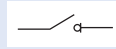

Load disconnect switch

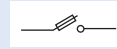

Fuse power circuit breaker



Fuse disconnect

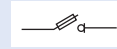

Fuse switch disconnect

ÖVE-SN45, § 207, IEC 60947-3

Controlling & Switching

MCB for Auxiliary Switch Circuits PLSM-B4/-HS, CLS6-B4/-HS

- Design according to EN 60898-1, 4 A, Characteristic B
- Very low let-through energy in order to prevent contact welding in auxiliary switches of **any and all switchgear**, as well as thermostats control devices, timers, etc.
- Busbar connection to CLS6, PFIM, PKN, ...

Connection diagram



Technical Data

	PLSM-B4/-HS	CLS6-B4/-HS
Electrical		
Number of poles	1-, 2-pole	1-, 1+N-, 2-pole
Rated voltage	230/400 V	230/400 V
Frequency	50/60 Hz	50/60 Hz
Rated current	4 A	4 A
Rated breaking capacity	10 kA	6 kA
Mechanical		
Frame size	45 mm	45 mm
Device height	80 mm	80 mm
Device width	17.5 mm (1MU)	17.5 mm (1MU)
Mounting	quick fastening with 2 lock-in positions	on DIN rail IEC/EN 60715
Degree of protection, built-in	IP40	IP40
Terminal protection	finger and hand touch safe according to BGV A3, ÖVE-EN 6	
Terminals	Twin-purpose terminals	Twin-purpose terminals
Terminal capacity	1-25 mm ²	1-25 mm ²
Terminal screws	M3 (Pozidrive)	M3 (Pozidrive)
Fastening torque of terminal screws	0.8-1.0 Nm	0.8-1.0 Nm
Busbar thickness	0.8 - 2 mm	0.8 - 2 mm

Dimensions (mm)

PLSM-B4/-HS

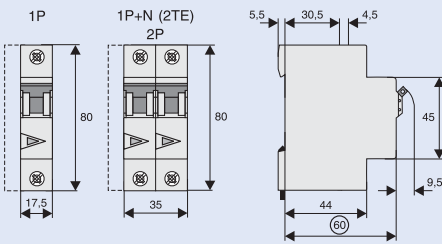

CLS6-B4/-HS

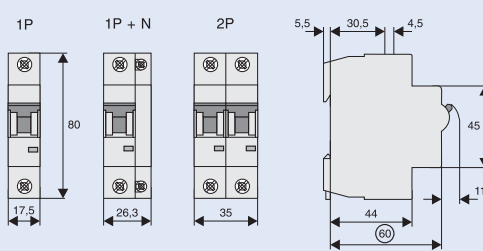

Let-through Energy PLSM-B4-HS

Let-through energy PLS., characteristic B, 1-pole

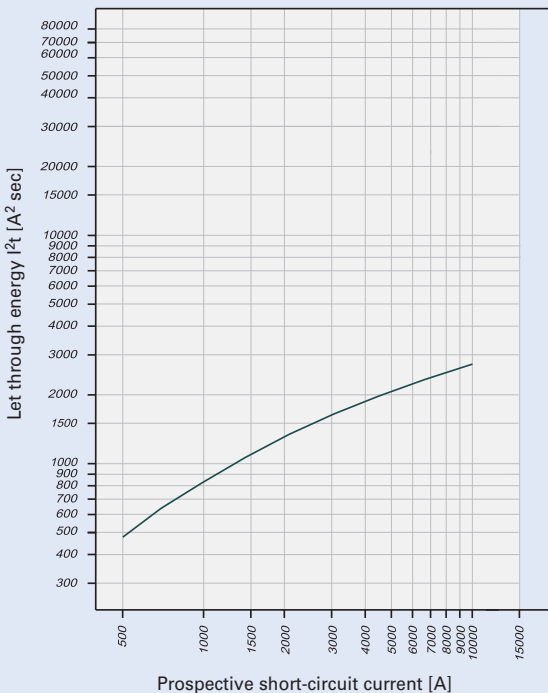

Practical Hint

Even auxiliary switches must be protected against overload and short circuit by means of suitable back-up fuses according to manufacturer specification. According to IEC 60947-5 a maximum back-up fuse is specified for conditional short circuit prevention up to 1,000 A. Therefore, connection of the auxiliary switch to the nearest MCB is not permitted. Danger of contact welding! The MCB for auxiliary switch circuits ...-HS offers a simple solution.

Controlling & Switching

Pushbutton Z-T; Control Switch Z-S/..; Changeover Switch Z-S/W

- Design according to IEC 60669, VDE 0632
- Types Z-S/WM and /2WM with central position (0-position)
- Types Z-S/WTN and -2WTN with TAG-0-NACHT (DAY-0-NIGHT) printed onto the device

Connection diagrams

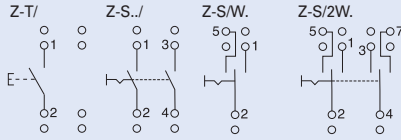

Technical Data

	Z-T/	Z-S./	Z-S/W
Electrical			
Rated voltage	230/400V AC	230/400V AC	230/400V AC
Frequency	50 HZ	50 HZ	50 HZ
Rated current	16A/230V~	16A/230V~	16A/230V~
Switching capacity	–	$1.25 \times I_n; 1.1 \times U_n$	$1.25 \times I_n; 1.1 \times U_n$
Short circuit strength	10 kA	10 kA	10 kA
Mechanical			
Switching toggle	–	black	black
Pushbutton colour	green - NO black - NO/NC	–	–
Frame size	45 mm	45 mm	45 mm
Device height	80 mm	80 mm	80 mm
Device width	17.5 mm (1MU)	17.5 mm (1MU)	17.5 mm (1MU)
Mounting	quick fastening with 2 lock-in positions on DIN rail IEC/EN 60715		
Degree of protection, built-in	IP40	IP40	IP40
Upper and lower terminals	lift terminals	lift terminals	lift terminals
Terminal capacity	1-10 mm ²	1-10 mm ²	1-10 mm ²
Terminal protection	finger and hand touch safe, according to BGV A3, ÖVE-EN 6		
Resistance to climatic conditions	acc. to IEC/EN 60068	acc. to IEC/EN 60068	acc. to IEC/EN 60068

Dimensions (mm)

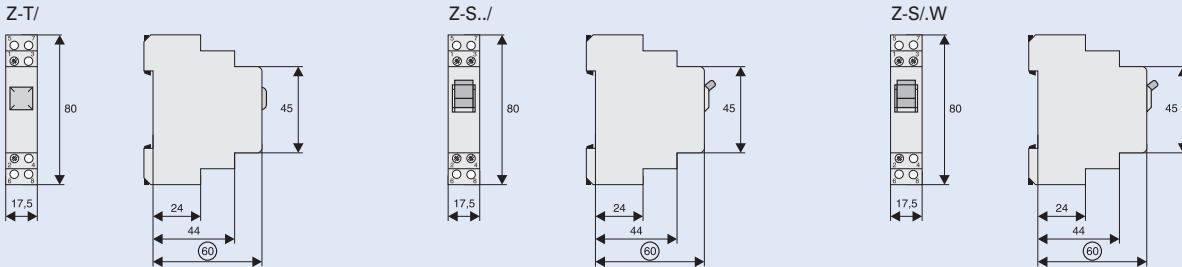

Controlling & Switching

Switches Z-SW.; Signal Lamps Z-EL, Z-DL., Z-BEL; Pushbutton Units Z-PU.

- Design according to IEC/EN 60669, VDE 0632
- Low power loss
- Long service life
- Twin lamp with separate connections
- Colour red/green, can be selected by alternative wiring
- Flash option by usage of different terminals only, changeover option, no additional relay necessary (Z-BEL)
- Terminals with guide for secure terminal connection
- Identical terminal screws for coil and contacts

Connection diagrams

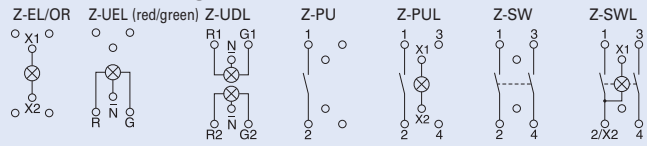

Technical Data

	Z-EL, Z-DLD, Z-BEL	Z-PU, Z-PUL	Z-SW, Z-SWL
Electrical			
Rated voltage	–	250 V AC	250 V AC
Frequency	–	50 HZ	50 HZ
Rated current	–	16 A	16 A
LED			
Rated voltage	230 V AC/DC 24 V AC/DC	230 V AC/DC 24 V AC/DC	230 V AC/DC 24 V AC/DC
Range of operational voltage	(50 V) 110-240 V AC/DC (5 V) 12-24 V AC/DC	(50 V) 110-240 V AC/DC (5 V) 12-24 V AC/DC	(50 V) 110-240 V AC/DC (5 V) 12-24 V AC/DC
Luminosity	15 mcd	15 mcd	15 mcd
Power loss	2W per LED	2W	2W
Switching contact	–	16A/250V~	16A/250V~
Contact function	–	1NO, 2NO, 1NO+1NC, 2NC	1NO, 2NO, 1NO+1NC
Flashing frequency	typ. 2 cy (Z-BEL)	–	–
Maximum back-up fuse, short circuit	–	20 A gG	20 A gG
Mechanical			
LED colour	red, green, red + green, white + white, red/green, orange, blue, white	orange	orange
Push-button colour	–	green - NO-contact red - NC-contact black - NO/NC-contact	black
Frame size	45 mm	45 mm	45 mm
Device height	90 mm	90 mm	90 mm
Device width	17.5 mm (1TE)	17.5 mm (1TE)	17.5 mm (1TE)
Mounting	quick fastening with 2 lock-in positions on DIN rail IEC/EN 60715		
Degree of protection installed device	IP40	IP40	IP40
Upper and lower terminals	lift terminals with guides for secure connection		
Terminal capacity	1-10 mm ²	1-10 mm ²	1-10 mm ²
Terminal protection	finger and hand touch safe according to BGV A3, ÖVE-EN6		
Resistance to climatic conditions	acc. to IEC/EN 60068	acc. to IEC/EN 60068	acc. to IEC/EN 60068

Dimensions (mm)

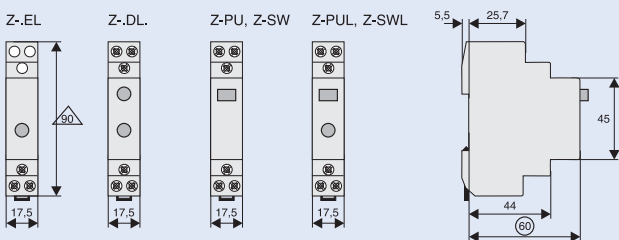

Connection example for LED red/green

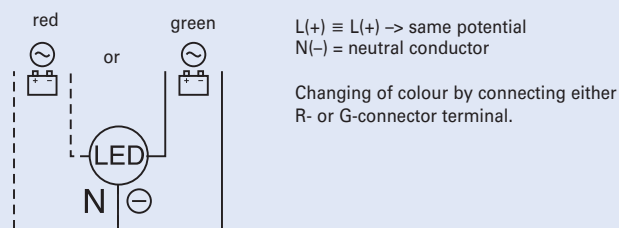

Connection example for flashing function

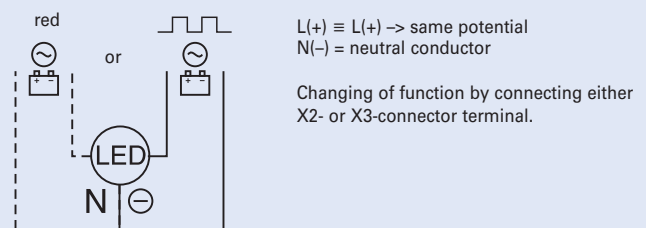

Controlling & Switching

Rotary Switch Z-DS

- Rotary switches of series Z-DS are of a modular design: The switch proper consists of the engaging work and the switching package. The switching cams (for which it is also called cam switch) are driven by a stable, torsion-proof aluminium shaft. The switching package consists of one or several switching cells with one or two independent contacts. Connections of adjoining switch terminals (necessary in case of voltmeter changeover switch Z-DSV) are contained in the pressed switch component. Consequently, there is no obstacle when connecting the connection lines.
- Application: Suitable for virtually any application, e.g. motor switch, garage doors, fans, shutters, heating system control, lighting fixtures, instrument switches, different control purposes, etc.

Dimensions (mm)

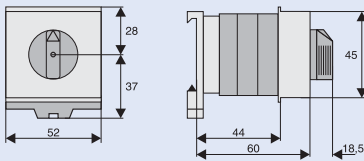

Connection diagrams

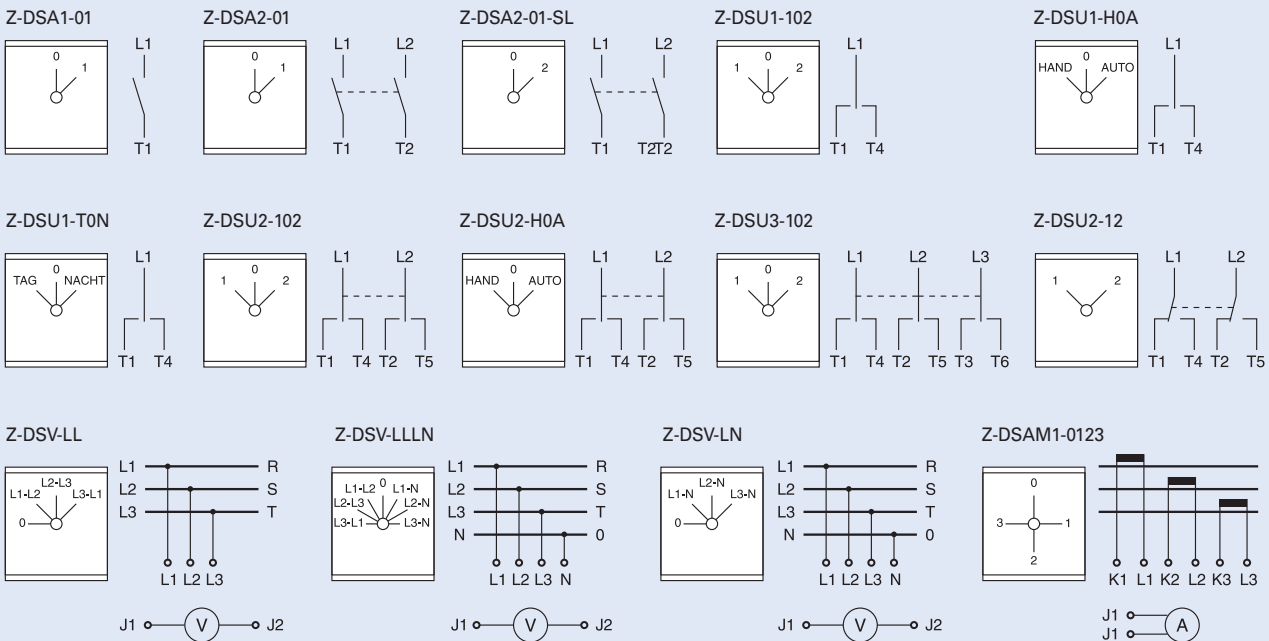

Technical Data

Data acc. to IEC 60947-3, IEC 60947-5-1, VDE 0660, EN 60947-3, SEV					
Nominal thermal current I_{th} open	A	20	Utilisation category AC15 Switching of electromagnetic drives, contactors, valves, pull-type electromagnets Nominal operational current I_n	A	6
Nominal thermal current I_{thg} hermetically enclosed	A	20			
Nominal operational voltage U_e	V	690	2-pole disconnection	A	5
$U_{imp} = 6$ kV					
Disconnector conditions acc. to ÖVE, IEC met up to	V	440	Utilisation category DC21A, DC21B Switching of resistive loads Time constant L/R ≤ 1 ms Nominal operational current I_n	A	20
Circuit breaking capacity I_v					
3 x 220-440V	A	160	1-pole	A	4
3 x 500 V	A	100			
3 x 660-690V	A	80			
Utilisation category AC21A, AC21B Switching resistive loads including low overloads Nominal operational current I_n	A	20	30V 60V 110V 220V 440V	A	0.6 0.3 -
Utilisation category AC23A, AC23B Switching motors and other highly inductive loads Nominal operational current I_n	A	16			
Nominal power	kW	4			
3-phase, 3-pole	kW	7.5			
220-240V	kW	7.5	30V 60V 110V	A	8 1 0.3
380-440V	kW	7.5			
500V 660-690V	kW	7.5			
Star-delta starting switch for squirrel cage motors Nominal power			Terminal capacity one or several wires fine wires fine wires with wire end sleeve terminal screw number of conductors per terminal	mm ²	1 - 2.5 0.75 - 2.5 0.75 - 1.5 M3.5 2
3-phase, 3-pole	kW	3.7			
220-240V	kW	7.5	Switching of capacitive load maximum making capacity	A	140
380-415V	kW	7.5			
Utilisation category AC3 Switching of 3-phase AC motors Nominal operational current I_n	A	12	Degree of protection from behind		IP20
Nominal power	kW	3			
3-phase, 3-pole	kW	5.5			
500V 660-690V	kW	5.5			

Controlling & Switching

Short circuit protection				Short-time load capacity			
max. fuse	gL (gG)	A	20	Load duration	3s	A	100
Rated short-time withstand current (1 second current)	3000	A	250	(values applicable to already closed contacts only)	10s	A	60
Conditional rated short circuit current		kA _{r.m.s.}	10		30s	A	35
					60s	A	25

Rotary Switch Z-DS for Lighting Systems

		Rated operational current 60°C		Z-DS...	
Utilisation category AC1		leAC1	A		20
Utilisation category AC5a	220-240V~	Rated operational power cosφ 0,5 cosφ 0,9 DUO	kW kW kW		1,1
Utilisation category AC5b	220-240V~	Rated operational power	kW		1,4
					

Incandescent Lamps

		Power	Current	Z-DS...
Utilisation category AC5b		W	W	A
Incandescent lamps AC5B		60 100 200 300 500 1000	0,27 0,45 0,91 1,36 2,27 4,5	22 13 7 4 3 1
				
				max. number of lamps per current path at 230V, 50 Hz

Fluorescent Tubes, Mercury Arc Lamps

Utilisation category AC5a		Power	Current	Capacitor	Z-DS...	
Lamp Types		W	A	µF		
Fluorescent tubes without compensation or with series compensation	11	11	0,16	-	60	
	18	18	0,37	2,7	25	
	24	24	0,35	2,5	25	
	36	36	0,43	3,4	20	
	58	58	0,67	5,3	14	
	65	65	0,67	5,3	13	
	85	85	0,8	-	11	
	Fluorescent tubes lead-lag circuit	11	11	0,07	-	2 x 100
		18	18	0,11	-	2 x 50
		24	24	0,14	-	2 x 40
		36	36	0,22	-	2 x 30
		58	58	0,35	-	2 x 20
		65	65	0,35	-	2 x 15
	Fluorescent tubes with parallel comp.	85	85	0,47	-	2 x 10
		11	11	0,16	2,0	30
18		18	0,37	2,0	20	
24		24	0,35	3,0	15	
36		36	0,43	4,5	10	
58		58	0,67	7,0	6	
Fluorescent tubes with electronic ballast	65	65	0,67	7,0	5	
	85	85	0,8	8,0	4	
	18	18	0,09	-	40	
	36	36	0,16	-	20	
	58	58	0,25	-	15	
	2 x 18	2 x 18	0,17	-	2 x 20	
Mercury arc lamps, high pressure without compensation e.g.: HQL, HPL	2 x 36	2 x 36	0,32	-	2 x 10	
	2 x 58	2 x 58	0,49	-	2 x 7	
	50	50	0,61	-	16	
	80	80	0,8	-	12	
	125	125	1,15	-	8	
	250	250	2,15	-	4	
	400	400	3,25	-	3	
	700	700	5,4	-	1	
	1000	1000	7,5	-	1	
	Mercury arc lamps, high pressure with compensation e.g.: HQL, HPL	50	50	0,28	7	7
		80	80	0,41	8	5
		125	125	0,65	10	3
		250	250	1,22	18	2
		400	400	1,95	25	1
		700	700	3,45	45	1
1000	1000	4,8	60	-		
				max. number of lamps per current path at 230V, 50 Hz		

Controlling & Switching

Metal Halide Lamps

Lamp Types	Power	Current	Capacitor	Z-DS...
	W	A	µF	
Metal halide lamps without compensation e.g.. HQI, HPI	35	0,53	-	22
	70	1	-	12
	150	1,8	-	6
	250	3	-	4
	400	3,5	-	3
	1000	9,5	-	1
	2000	16,5	-	-
Metal halide lamps with compensation e.g.. HQI, HPI	35	0,25	6	8
	70	0,45	12	4
	150	0,75	20	2
	250	1,5	33	1
	400	2,1	35	1
	1000	5,8	95	-
	2000	11,5	148	-
Transformers for low-voltage halogen lamps	20	-	-	40
	50	-	-	20
	75	-	-	13
	100	-	-	10
	150	-	-	7
	200	-	-	5
	300	-	-	3
max. number of lamps per current path at 230V, 50 Hz				

Sodium Vapour Lamps

Lamp Types	Power	Current	Capacitor	Z-DS...
	W	A	µF	
Sodium vapour lamps low-pressure without compensation	35	1,5	-	7
	55	1,5	-	7
	90	2,4	-	4
	135	3,5	-	3
	150	3,3	-	3
	180	3,3	-	3
	200	3,3	-	3
Sodium vapour lamps low-pressure with compensation	35	0,31	20	3
	55	0,42	20	2
	90	0,63	30	1
	135	0,94	45	1
	150	1	40	1
	180	1,16	40	1
	200	1,32	25	1
Sodium vapour lamps high-pressure without compensation	150	1,8	-	5
	250	3	-	4
	330	3,7	-	3
	400	4,7	-	2
	1000	10,3	-	1
Sodium vapour lamps high pressure with compensation	150	0,83	20	2
	250	1,5	33	2
	330	2	40	1
	400	2,4	48	1
	1000	6,3	106	-
max. number of lamps per current path at 230V, 50 Hz				

Controlling & Switching

Relay for low-level signals RELLVA, REHLVA, REMLVA

The electronic relay is a universal switching device designed especially for transmitting small or low-level signals of electronic control systems.

The **RELLVA** has been designed to switch low-level signals. The relay can be energized through analogue control signals of a roller-shutter or heating control, for example. The switching contact allows to switch a binary signal for digital inputs, for example of a programmable controller, of a control relay (e.g. EASY control relay) or of a Z-CC Communication Centre.

The **REHLVA** in turn can switch higher loads of up to 5A 250V AC1. It can be energized through a binary signal of a digital output, for example. The switching contact can switch electrical consumers of up to

5A 250V AC1, but it can also be used for energizing contactors, for example. The **REMLVA** is a combination of the relays mentioned above. One relay is equipped with the switching contact for low-level signals, the other one with the switching contact for higher loads up to 5A 250V AC1.

The multi-functional coil, which can be energized in a range from 24V to 250V AC and DC, covers a wide variety of applications. In addition, all types have two relays for separate energizing in one enclosure of 1 MU width.

- Electronic switching relay
- Universal control voltage range from 24 to 250V AC/DC with a minimum of power consumption
- Switching of very small signals from 10mV / 1µA
- Switching of higher loads of up to 5A 250VAC AC1
- 2 relays for separate energizing in one enclosure of 1 MU width
- 1 change-over contact for each relay with switch position indication by LED
- No switching noise, hum-free
- Railway service qualification tested

Connection diagram

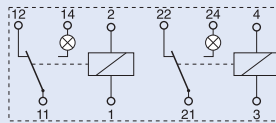

Technical Data

Electrical

Standard according	IEC/EN 61810
Number of poles	2x1
EMC-Environment	EN 61000-4-2, 61000-4-4, 61000-4-5, 61810-5

Control circuit

Rated voltage U_s	24-250V AC/DC
Rated frequency	0-50Hz
Operating range	0.90-1.1 x U_s
Minimum command duration	0.1s
Operating noise	non
Rated peak withstand voltage U_{imp}	4kV (1.2/50µs)
Duty	100%
Trip coil power	
switching on	0.1/24V; 1/250V VA/W
holding	0.1/24V; 1/250V VA/W

Load Circuit, Main Contacts

Change over	2 (to be energized separately)
Rated operational voltage U_e / Rated operational current I_e	
RELLVA	30V DC / 2A 220V DC / 0,3A
REHLVA	250V AC / 5A 30V DC / 5A 300V DC / 0,25A
REMLVA	
Switching contact 11/12/14	30V DC / 2A 220V DC / 0,3A
Switching contact 21/22/24	250V AC / 5A 30V DC / 5A 300V DC / 0,25A

Minimum operational voltage U_{min} / Minimum operational current I_{min}

RELLVA	10mV / 10µA
REHLVA	100mV / 10mA
REMLVA	
Switching contact 11/12/14	10mV / 10µA
Switching contact 21/22/24	100mV / 10mA

Rated insulation voltage U_i	500V DC
Rated peak withstand voltage U_{imp}	1.5kV between open contacts; 2.5kV between contacts and

coil

Mechanical

Frame size	45 mm
Device height	70 mm
Device width	17.8 mm (1 MU)
Mounting	quick fastening on DIN rail IEC/EN 60715
Degree of protection installed device	IP20
Mounting position	as required
Shock resistance	max. 750m/s ²
Terminal capacity	1x 2.5 mm ² flexible 1x 4 mm ² rigid 2x 1.5 mm ² rigid
Temperature range	-40 to +85°C

Controlling & Switching

Dimensions (mm)

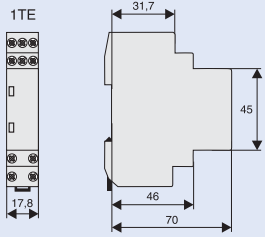

Examples

RELLVA

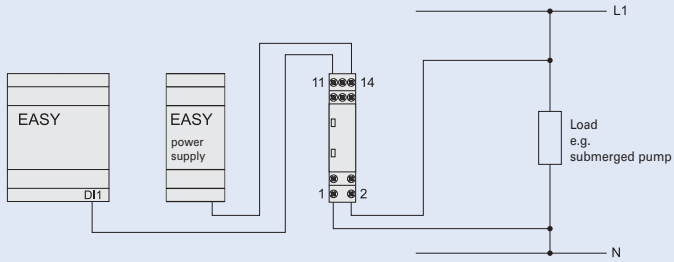

REHLVA

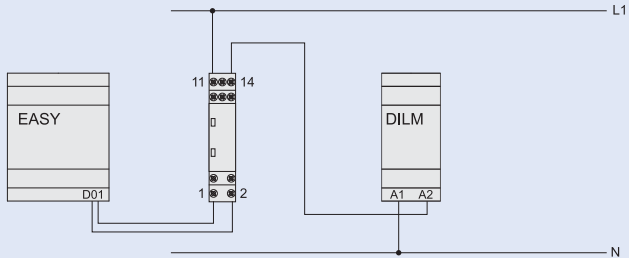

Controlling & Switching

Installation Relays Z-R, Z-TN

Installation relays Z-R are suitable for switching 1-phase or 3-phase consumers up to 20 A. These devices for universal use in building installations and systems permit implementation of the following applications and control functions:

- Switching lighting systems and electrical heating systems
- Switching ventilation and air conditioning systems, fans
- Switching heat pumps
- Switching electrically controlled roller doors/gates, and blinds
- Switching incandescent lamps and gas discharge lamps

The installation relays of series Z-R./ meet the requirements of standards EN/IEC 60947 and EN/IEC 1095.

EN/IEC 1095 deals with "Electromechanical contactors for household and similar purposes." Compliance with this standard means meeting very high demands in terms of safety for humans and property.

EN/IEC 947 deals with "Electromagnetic contactors in electrical system manufacturing".

Security:

- Manual operation for testing purposes
- Switching contacts with safe disconnection AC1 according to EN 60947-4-1 (Z-R, Z-RK)
- Optional optical operating status display by means of LED
- Switching position indicated on the front side by manual operating key
- All terminals - coil and contacts - equipped with guide for secure terminal connection. Misplacement of wires impossible.
- Main contacts can be connected to standard pin busbar
- Made of hardly flammable materials and plastics free from chlorine and halogens
- Finger and hand touch safe according to VBG4

Advantages:

- Available in three versions (Z-R, Z-RK, Z-RE)
- Low switching noise, no humming
- Easy to connect thanks to large terminals supplied open
- Simple snap-on fastening on 35 mm DIN rail
- High degree of flexibility thanks to a variety of contact configurations
- Easy access for coil feed connection
- Version with mechanical pre-selection of functions ON/AUTO/OFF (Z-TN)
ON/permanently ON: Contact permanently ON until a control pulse is switched on and OFF again. Then, the relay reverts to the AUT position.
AUT/AUTOMATIC: Standard relay function by control voltage at the coil.
OFF/permanently OFF: Contacts permanently OFF, independently of the control voltage at the coil.
- Type Z-TN available only in AC, other coil voltages than 24V and 230V on request

Connection diagrams

1MU Z-R

"S"

1 NO

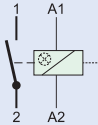

"SS"

2 NO

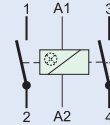

"SO"

1 NO / 1 NC

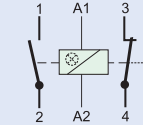

"OO"

2 NC

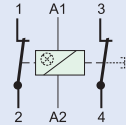

2MU Z-R

"2S2O"

2 NO / 2 NC

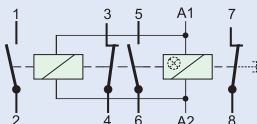

1MU Z-TN (with mechanical pre-selection)

"SS"

2 NO

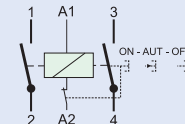

Versions

with manual operation

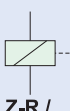

Z-R./

with manual operation and LED

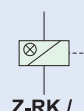

Z-RK./

with LED

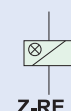

Z-RE./

with mech. pre-selection

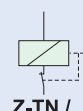

Z-TN./

Permitted installation positions

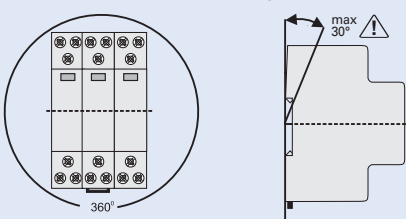

Packing density at full contact load

Z-R./
Spacers recommended! (Z-DST)

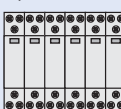

≤40°C

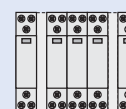

40-60°C

1/2 1/2

Technical Data

Electrical

Design according to	IEC/EN 60947
Rated voltage	250 V, 240/415 V AC
Rated current	20 A, 250 V AC
Rated current AC1 I _e	20 A AC1 (Z-R, Z-RK)
Rated operational power P _e	4.6 kW 415 V
Number of poles	1 to 4
Main contacts	
NO/NC	1, 2 (1MU) 3, 4 (2MU)

EMR compatibility

B

Control Circuit

Rated control feed voltage U _s	8, 12, 24, 48, 110, 230, 240 V AC 8, 12, 24, 110 V DC
Rated frequency	50 Hz
Operating range	0.85-1.1 x U _s
Maximum power of coils	
pick-up	10-13 VA, 6-8 W
retaining	3,4-4,0 VA, 2,0-2,4 W
Minimum command duration	> 50 ms
Operating noise	no humming
Rated peak withstand voltage U _{imp}	2 kV (1.2/50 μs)
Duty	100%

Load Circuit

Rated operational voltage U _e	1p, 2p: 250VAC; 3p, 4p: 240/415VAC
Minimum operational voltage U _{min}	24 V AC/DC (U _s 8-110 V)
Rated insulation voltage U _i	500 V
Rated peak withstand voltage U _{imp}	4 kV (1.2/50 μs)
Conventional thermal current I _{th}	20 A AC
Rated operational current I _e	20 A AC
Rated constant current I _u	20 A AC
Rated current DC	
24 V	I _e 16 A
48 V	I _e 12,5 A
230 V	I _e 1 A
Conditional rated short circuit current I _q	10 kA (with 20 A gL/gG)
Duration of bouncing	< 10 ms (typ. < 5 ms)

Controlling & Switching

Technical Data (continued)

UTILISATION CATEGORIES 1MU, 2MU (except 3S, 4S)

AC-1 $\square/\square/\square$ *)	
Rated operational voltage U_e	250 V AC
Rated operational current I_e	20 A AC
Rated operational power AC-1	4000 W ($\cos \varphi = 0.8$), 5000 VA
AC-3 \odot	
Rated operational voltage U_e	250 V AC
Rated operational current I_e	8 A AC
Rated operational power AC-3	900 W ($\cos \varphi = 0.45$), 2000 VA
AC-5a \otimes	
Rated operational voltage U_e	250 V AC
Rated operational current I_e	10 A AC
Rated operational power AC-5a	1125 W ($\cos \varphi = 0.45$), 2500 VA
AC-5b \otimes	
Rated operational voltage U_e	230 V AC
Rated operational current I_e	8,8 A AC
Rated operational power AC-5b	2024 W
AC-7a (according to EN 61095) \blacksquare	
Rated operational voltage U_e	250 V AC
Rated operational current I_e	20 A AC
Rated operational power AC-7a	4000 W ($\cos \varphi = 0.8$), 5000 VA

UTILISATION CATEGORIES 2MU (3S, 4S)

AC-1 $\square/\square/\square$ *)	
Rated operational voltage U_e	240/415 V AC
Rated operational current I_e	20 A AC
Rated operational power AC-1	4000 W ($\cos \varphi = 0.8$), 5000 VA
AC-3 \odot	
Rated operational voltage U_e	240/415 V AC
Rated operational current I_e	8 A AC
Rated operational power AC-3	900 W ($\cos \varphi = 0.45$), 2000 VA
AC-5a \otimes	
Rated operational voltage U_e	240/415 V AC
Rated operational current I_e	10 A AC
Rated operational power AC-5a	1125 W ($\cos \varphi = 0.45$), 2500 VA

AC-5b \otimes	
Rated operational voltage U_e	230/400 V AC
Rated operational current I_e	8,8 A AC
Rated operational power AC-5b	2024 W
AC-7a (according to EN 61095) \blacksquare	
Rated operational voltage U_e	240/415 V AC
Rated operational current I_e	20 A AC
Rated operational power AC-7a	4000 W ($\cos \varphi = 0.8$), 5000 VA
AC-7b (according to EN 61095) \odot	
Rated operational voltage U_e	240/415 V AC
Rated operational current I_e	10 A AC
Rated operational power AC-7b	1125 W ($\cos \varphi = 0.8$), 2500 VA

Endurance	electrical comp.	$\geq 40 \times 10^3$ operating cycles
	mechanical comp.	$\geq 1 \times 10^6$ operating cycles

Mechanical

Frame size	45 mm
Device height	90 mm
Device width	17.5 mm (1MU)
Mounting	quick fastening on DIN rail IEC/EN 60715
Degree of protection installed device	IP20
Position of device in use	works in any position, however not hanging
Upper and lower terminals	lift terminals (captive)
Terminal capacity	
Contact and coil	0,5 - 10 mm ² one- or more wire 0,5 - 6 mm ² fine-wire with wire end sleeve
Temperature range	-20°C to +45°C
Total contact gap	> 5mm / independent contacts
Contact material	does not contain cadmium

*)  suitable for insulation, tested on AC-1

Dimensions (mm)

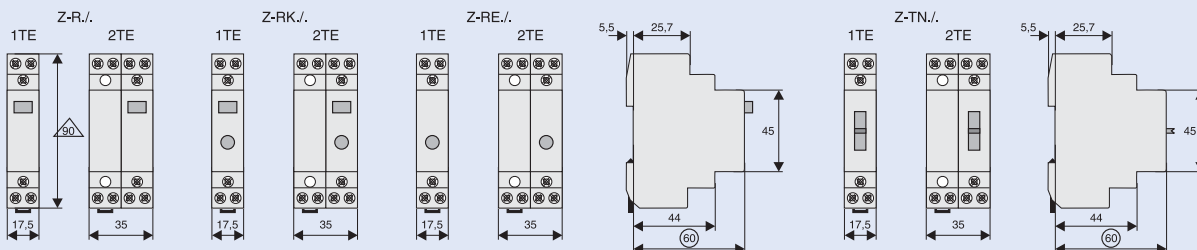

Controlling & Switching

Lamp Types	Power	Current	Capacitor	Z-R
	W	A	μF	max. number of lamps per current path at 230V, 50 Hz
Incandescent lamps	60	0,27		33
Low-voltage halogen lamps (12 or 24 V) with transformer / electronic transformer	20	0,09		55
	50	0,22		22
	75	0,33		14
	100	0,43		11
	150	0,65		7
	200	0,87		5
	300	1,3		3
Fluorescent tubes without compensation or with series comp.	11	0,16	1,3	62
	18	0,37	2,7	27
	24	0,35	2,5	27
	36	0,43	3,4	24
	58	0,67	5,3	15
	65	0,67	5,3	14
	85	0,8	5,3	12
	Fluorescent tubes lead-lag circuit	11	0,07	-
18		0,11	-	2 x 45
24		0,14	-	2 x 35
36		0,22	-	2 x 22
58		0,35	-	2 x 14
65		0,35	-	2 x 14
85		0,47	-	2 x 10
Fluorescent tubes with parallel comp.	11	0,16	3,0	34
	18	0,37	4,0	26
	24	0,35	4,0	26
	36	0,43	4,0	26
	58	0,67	7,0	14
	65	0,67	7,0	14
	85	0,8	8,0	13
Fluorescent tubes with electronic ballast	18	0,09	-	32
	36	0,16	-	16
	58	0,25	-	12
	2 x 18	0,17	-	2 x 16
	2 x 36	0,32	-	2 x 8
2 x 58	0,49	-	2 x 6	

xPole

Controlling & Switching

Installation Contactors Z-SCH, CMUC

These Installation Contactors are design to cover all applications in residential and commercial sites as for as example:

- Switching of lighting systems
- Switching of electrical heating systems
- Switching of ventilation systems
- Switching of air conditioning systems and fans
- Switching of heat pumps
- Switching of roller doors/gates and blinds
- etc. etc.

Advantages and Safety:

- Front-side switch position indicator
- Compact frame
- Large terminals
- Low switching noise
- No humming
- High contact force for high switching capacity
- Simple snap-on fastening of 35mm DIN rail
- Finger and hand touch safe according to VGB 4
- Hardly flammable materials and chlorine-free and halogen-free plastics are used
- Z-SCH
Innovative AC magnet system
- CMUC
Innovative AC/DC magnet system

These products meets the requirement of the standards IEC/EN 60947-4-1 and IEC/EN 61095

Connection diagrams

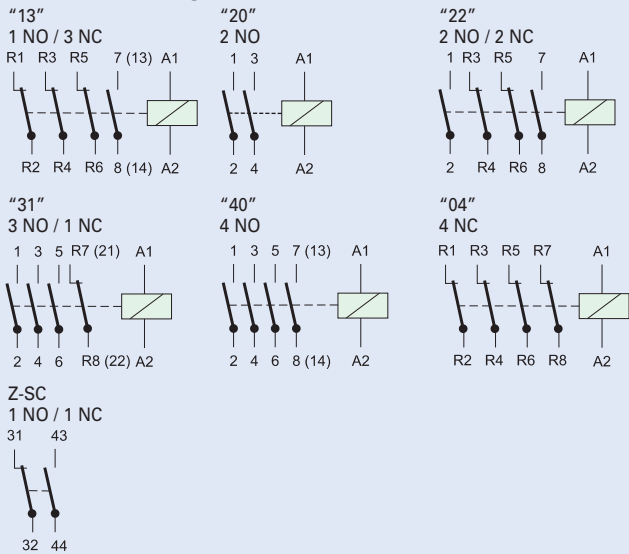

Permitted Installation Positions

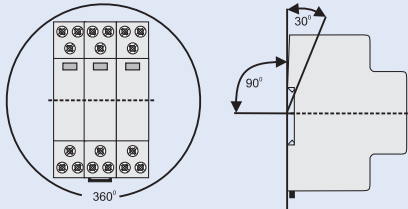

Packing Density at full contact load

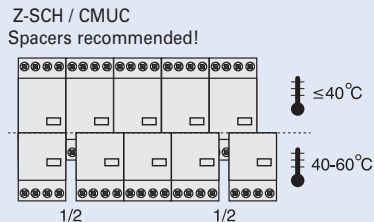

Dimensions (mm)

Z-SCH.../1/25 Z-SCH.../25 Z-SCH.../40, .../63
CMUC.../25

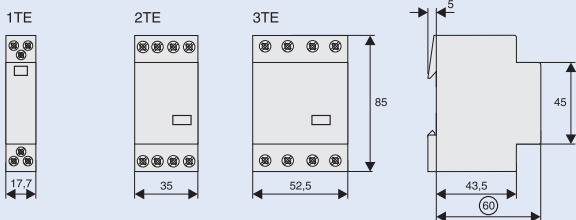

Z-SC

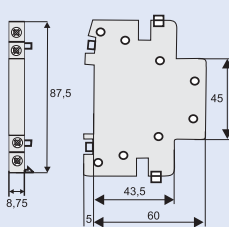

Controlling & Switching

Technical Data of Installation Contactors Z-SCH, CMUC

Values according to IEC 61095, EN 61095, VDE 0660, IEC 60947-4-1, EN 60947-4-1, VDE			Z-SCH/25/.. CMUC.../25/	Z-SCH/40/..	Z-SCH/63/..	Z-SC
Utilisation category AC1 (e.g. heating system)						
Rated operational current $I_n (=I_{th})$ open	at 60°C	A	25	40	63	-
Service life of switching element		$S \times 10^6$	0,1	0,1	0,1	-
Rated operational power AC1	220 - 240 V	kW	9,5	16	25	-
	380 - 415 V	kW	17	27,5	43	-
Lowest switching power		V/mA	24/100	24/100	24/100	17/5
Utilisation category AC3 (Switching of 3-phase AC motors)						
Rated operational current I_n		A	9	27	30	-
Service life of switching element		$S \times 10^6$	0,15	0,15	0,15	-
Rated power of 3-phase AC motors 50-60 Hz	220 V	kW	2,2	7,5	8	-
	230-240V	kW	2,5	8	8,5	-
	380-415V	kW	4	12,5	15	-
Utilisation category DC1 (Switching of resistive loads, $L/R \leq 15ms$) values for make contacts						
1-pole	24V DC	A	25	40	63	-
	48V DC	A	22	25	26	-
	60V DC	A	18	19	21	-
	110V DC	A	5	7	8	-
	220V DC	A	0,5	0,7	0,7	-
2-pole in series	24V DC	A	25	40	63	-
	48V DC	A	25	40	44	-
	60V DC	A	25	33	36	-
	110V DC	A	16	17	18	-
	220V DC	A	4	5	6	-
3-pole in series	24V DC	A	25	40	63	-
	48V DC	A	25	40	63	-
	60V DC	A	25	40	61	-
	110V DC	A	25	31	34	-
	220V DC	A	10	15	16	-
4-pole in series	24V DC	A	25	40	63	-
	48V DC	A	25	40	63	-
	60V DC	A	25	40	63	-
	110V DC	A	25	40	63	-
	220V DC	A	15	20	21	-
Utilisation category DC3 and DC5 (Switching of inductive load, $L/R \leq 15ms$) values for make contacts						
1-pole	24V DC	A	15	23	25	-
	48V DC	A	5	10	10	-
	60V DC	A	4	5	5	-
	110V DC	A	1	1,5	1,5	-
	220V DC	A	0,1	0,3	0,3	-
2-pole in series	24V DC	A	25	40	45	-
	48V DC	A	17	23	25	-
	60V DC	A	13	15	15	-
	110V DC	A	5	5	5	-
	220V DC	A	0,5	1	1	-
3-pole in series	24V DC	A	25	40	63	-
	48V DC	A	25	40	45	-
	60V DC	A	25	30	30	-
	110V DC	A	15	15	15	-
	220V DC	A	3	4	4	-
4-pole in series	24V DC	A	25	40	63	-
	48V DC	A	25	40	63	-
	60V DC	A	25	40	63	-
	110V DC	A	25	40	45	-
	220V DC	A	8	10	10	-
Main Switching Elements ($U_{imp} = 4 kV$)						
Rated insulation voltage U_i		V AC	440	440	440	440
Rated operational voltage U_e		V AC	440	440	440	440
Permissible switching frequency z	AC1, AC3	1/h	300	600	600	600
Mechanical endurance		$S \times 10^6$	1	1	1	1
Auxiliary Switching Elements ($U_{imp} = 4 kV$)						
Rated insulation voltage U_i		V AC	440	440	440	440
Nominal thermal current = I_{th}	40°C	A	25	40	63	10
	60°C	A	25	40	63	6
Utilisation category AC15 (Controlling of electromagnetic load)						
Rated operational current I_e	220-240V	A	-	-	-	3
	380-415V	A	-	-	-	2
	440V	A	-	-	-	1,6
Utilisation category DC13 (Controlling of electromagnetic load at DC)						
Rated operational current I_e per pole	24-60V	A	-	-	-	2
	110V	A	-	-	-	0,4
	220V	A	-	-	-	0,1

Controlling & Switching

			Z-SCH/25/.. CMUC.../25/	Z-SCH/40/..	Z-SCH/63/..	Z-SC
Trip Coil Power Z-SCH CMUC Operating range of trip coils multiple of U_n (-40°C to +40°C) Z-SCH CMUC Pv Power loss per current path Pvges. Power loss per device at nominal current load	Switching on	VA	14 - 18	33 - 45	33 - 45	-
	Holding	VA	4,4 - 8,4	7	7	-
		W	1,6 - 3,2	2,6	2,6	-
		W	3-4			
	Coil voltage 50 Hz	V	220 - 240	220 - 240	220 - 240	-
	60 Hz	V	230 - 264	230 - 264	230 - 264	-
	Coil voltage 50/60 Hz	V	24, 220-240			
	DC	V	24, 220			
		W	2	3	7	0,5
	1-pole	W	5,2	5,6	5,6	-
2-pole	W	7,2	8,6	16,6	-	
3-pole	W	9,2	11,6	23,6	-	
4-pole	W	11,2	14,6	30,6	-	
Switching noise (on and off) Typical mean values		dB	80	78	78	-
Terminal capacity						
Main conductor	one or several wires	mm ²	1,5 - 10	2,5 - 25	2,5 - 25	0,5 - 2,5
	fine wires	mm ²	1,5 - 6	2,5 - 16	2,5 - 16	0,5 - 2,5
	fine wires with wire end sleeve	mm ²	1,5 - 6	2,5 - 16	2,5 - 16	0,5 - 1,5
	number of conductors per terminal		1	1	1	2
Coil	one or several wires	mm ²	0,75 - 2,5	0,75 - 2,5	0,75 - 2,5	-
	fine wires	mm ²	0,5 - 2,5	0,5 - 2,5	0,5 - 2,5	-
	fine wires with wire end sleeve	mm ²	0,5 - 1,5	0,5 - 1,5	0,5 - 1,5	-
	number of conductors per terminal		1	1	1	-
Weight		kg/unit	0,22	0,36	0,36	0,026
Tightening torque of terminal screws						
Main contacts		Nm	0,8 - 1,4	2,5 - 3,0	2,5 - 3,0	-
Coil		Nm	0,6 - 1,2	0,6 - 1,2	0,6 - 1,2	-
Short circuit protection (main circuit) Maximum nominal current of fuse Co-ordination type (1)		gL (gG)	A	35	63	80
Short circuit protection (auxiliary circuit) Maximum nominal current of fuses Short-circuit current 1kA, without fusing of contacts		gL (gG)	A	-	-	10
Switching times at control voltage $U_s \pm 10\%$						
	Make delay	ms	9 - 15	11 - 15	11 - 15	-
	Break delay	ms	4 - 8	6 - 13	6 - 13	-
	Arc duration	ms	10 - 15	10 - 15	10 - 15	-

Installation Contactors Z-SCH for Lighting Systems

The decisive factors are the type, connection and current consumption of lamps during switch-on and in permanent operation. Only 90 % of the continuous current of switching devices should be used in view of higher current consumption as a result of increases of voltage. The maximum number of lamps per phase that can be operated by a switching device is dependent

on the nominal current and making current of lamps on the one hand, and on the continuous current and making capacity of the switching devices on the other. Thus, e.g. in lead-lag circuits, the continuous current of contactors can be used, while this is not possible in fluorescent tubes with separate compensation.

			Z-SCH/25/.. CMUC.../25/	Z-SCH/40/..	Z-SCH/63/..	Z-SC
Utilisation category AC1	Rated operational current	IeAC1	A	25 (60°C)	40 (60°C)	63 (60°C) -
	Making capacity	A	200	360	480	-
	Root mean square $I_{r.m.s.}$ Peak value I_{Spitze}	A	280	510	680	-
Utilisation category AC5a	Rated operational power (250 V)	cos φ 0,45	kW	1,3	3,4	5,5 -
	220-240V~	cos φ 0,90	kW	1,2	3,1	-
	DUO		kW	3,7	6,3	10 -
Utilisation category AC5b 	Rated operational power		kW	3	5,7	8 -
	240V~					

Controlling & Switching

Incandescent Lamps

The incandescent lamp filament has a very low ohmic resistance when it is cold. Therefore, when switching on, there is a high peak current

(up to $20 \times I_n$).

When switching off, only the nominal current is switched off.

	Power	Current	Z-SCH/25/.. CMUC.../25/	Z-SCH/40/..	Z-SCH/63/..	Z-SC
Utilisation category AC5b	W	A	max. number of lamps per current path at 230V, 50 Hz			
Incandescent lamps AC5B 	60	0,27	50	92	129	-
	100	0,45	30	55	77	-
	200	0,91	15	27	38	-
	300	1,36	10	19	26	-
	500	2,27	6	11	16	-
	1000	4,5	3	6	8	-
Low voltage halogen lamps (12 ur 24V) with transformer (with electronic transformer)	20	0,09	52	110	174	-
	50	0,22	24	50	80	-
	75	0,33	16	35	54	-
	100	0,43	12	27	43	-
	150	0,65	9	19	29	-
	200	0,87	6	14	23	-
	300	1,30	4	9	14	-

Controlling & Switching

Fluorescent Tubes, Mercury Arc Lamps

High- and low pressure discharge lamps with mercury vapour, with or without fluorescent-coated glass body are perfectly identical in their electrical behaviour.

In order to limit the operational current and pre-conduction current, and to achieve the initial peak voltage, reactance coils are used as ballast.

Capacitors are used for compensation of the resulting reactive current, which

are either connected in series with the coil (lead-lag circuit) or parallel to the mains (separate compensation, very rarely used now). The high making current in case of separate compensation (max. 30 x nominal current of the capacitor) which goes down quickly is usually attenuated considerably by the feed line.

Utilisation category AC5a		
	Fluorescent lamps without comp. or with series comp.	$I = I_{eAC1} \times 0,5$
	Lead-lag circuit (2x..)	$I = I_{eAC1} \times 0,35$
	Fluorescent tubes parallelkomp.	$I = I_{Spitze} / 100$ (take into account compensation capacitor)
I / I_{Lampe} = number of connectable lamps per current path	Fluorescent tubes with electronic ballast	$I = I_{Spitze} / 50$
	Mercury arc lamps,HD without compensation	$I = I_{eAC1} \times 0,5$
	Mercury arc lamps,HD with compensation	$I = I_{Spitze} / 100$ (take into account compensation capacitor)

Utilisation category AC5a		Power	Current	Capacitor	Z-SCH/25/.. CMUC.../25/	Z-SCH/40/..	Z-SCH/63/..	Z-SC
Lamp Types		W	A	µF	max. number of lamps per current path at 230V, 50 Hz			
Fluorescent lamps without compensation or with series compensation	11	0,16	1,3	75	210	310	-	
	18	0,37	2,7	34	90	140	-	
	24	0,35	2,5	34	90	140	-	
	36	0,43	3,4	30	70	140	-	
	58	0,67	5,3	20	45	70	-	
	65	0,67	5,3	19	40	65	-	
	85	0,8	5,3	16	35	60	-	
	Fluorescent tubes lead-lag circuit	11	0,07	-	2 x 110	2 x 220	2 x 250	-
		18	0,11	-	2 x 55	2 x 130	2 x 200	-
		24	0,14	-	2 x 44	2 x 110	2 x 160	-
		36	0,22	-	2 x 33	2 x 70	2 x 100	-
		58	0,35	-	2 x 22	2 x 46	2 x 70	-
		65	0,35	-	2 x 16	2 x 40	2 x 60	-
		85	0,47	-	2 x 11	2 x 30	2 x 40	-
	Fluorescent tubes with parallel comp.	11	0,16	3,0	43	67	107	-
		18	0,37	4,0	32	50	80	-
		24	0,35	4,0	32	50	80	-
		36	0,43	4,0	32	50	80	-
		58	0,67	7,0	18	36	46	-
		65	0,67	7,0	18	36	46	-
		85	0,8	8,0	16	33	44	-
	Fluorescent tubes with electronic ballast	18	0,09	-	40	100	150	-
		36	0,16	-	20	50	75	-
		58	0,25	-	15	30	55	-
80		0,4	-	10	20	30	-	
2 x 18		0,17	-	2 x 20	2 x 50	2 x 60	-	
2 x 36		0,32	-	2 x 10	2 x 25	2 x 30	-	
2 x 58		0,49	-	2 x 7	2 x 15	2 x 20	-	
Mercury arc lamps, high pressure without compensation e.g.: HQL, HPL	50	0,61	-	21	38	55	-	
	80	0,8	-	16	28	40	-	
	125	1,15	-	11	20	28	-	
	250	2,15	-	6	11	15	-	
	400	3,25	-	4	7	10	-	
	700	5,4	-	2	4	6	-	
	1000	7,5	-	1	3	4	-	
	Mercury arc lamps, high pressure with parallel comp. e.g.: HQL, HPL	50	0,28	7	18	36	50	-
		80	0,41	8	16	31	44	-
		125	0,65	10	13	25	35	-
		250	1,22	18	7	14	19	-
		400	1,95	25	5	10	14	-
		700	3,45	45	3	6	8	-
		1000	4,8	60	2	4	6	-

Controlling & Switching

Metal Halide Lamps

Metal halide lamps are a version of high-pressure mercury arc lamps with higher luminous efficiency and fidelity of colour (metalloids [halogens] added to the mercury fill up the Hg-spectrum with its many gaps). Ballast and ignition devices are necessary. Starting time 3 ... 5 minutes at 1.4 - 2 x I. After switching on, it is not possible to light the lamp again immediately (lamp extinguishes after a power cut-off of only 1/2 period). Therefore, in

many cases in important facilities ionisation of part of the lamps is maintained by switching over to 415 V, 500 Hz (e.g. to an emergency power supply). In this case, the lamp lights immediately after the mains voltage is on again. Otherwise, this would take several minutes. When using suitable ignition devices, the lamps can be lit again immediately.

I / I _{Lampe} = number of connectable lamps per current path	Metal halide lamps (HQI) without compensation	$I = I_{eAC1} \times 0,5$
	Metal halide lamps (HQI) with compensation	$I = I_{Spitze} / 100$ (take into account compensation capacitor)
	Transformer for low voltage halogen lamps	$I = I_{Spitze} / 50$

Lamp Types	Power	Current	Capacitor	Z-SCH/25/.. CMUC.../25/	Z-SCH/40/..	Z-SCH/63/..	Z-SC	
	W	A	µF	max. number of lamps per current path at 230V, 50 Hz				
Metal halide lamps without compensation e.g.. HQI, HPI	35	0,53	-	28	57	-	-	
	70	1	-	15	30	-	-	
	150	1,8	-	8	17	-	-	
	250	3	-	5	10	-	-	
	400	3,5	-	4	8	-	-	
	1000	9,5	-	1	3	-	-	
	2000	16,5	-	-	2	-	-	
	400V per Pol	2000	10,5	-	-	2	-	
		3500	18	-	-	1	-	
Metal halide lamps with electronic ballast (50-125xIn) HQI	20	0,1	i	9	18	20	-	
	35	0,2	i	6	11	13	-	
	70	0,36	i	5	12	12	-	
	150	0,7	i	4	10	10	-	
Metal halide lamps with compensation, with parallel comp. e.g.. HQI, HPI	35	0,25	6	21	42	58	-	
	70	0,45	12	11	21	29	-	
	150	0,75	20	4	13	18	-	
	250	1,5	33	4	9	11	-	
	400	2,1	35	1	9	10	-	
	1000	5,8	95	-	3	4	-	
	2000	11,5	148	-	2	2	-	
	400V per Pol	2000	6,6	58	-	3	4	-
		3500	11,6	100	-	2	3	-
	Transformers for low-voltage halogen lamps	20	-	-	52	110	174	-
50		-	-	24	50	80	-	
75		-	-	16	35	54	-	
100		-	-	12	27	43	-	
150		-	-	9	19	29	-	
200		-	-	5	14	23	-	
300		-	-	4	9	14	-	

Controlling & Switching

Sodium Vapour Lamps

For 200 W, 1200 mm high-pressure lamps and low-pressure lamps, reactance coils are used as ballast. For smaller lamps, stray field transformers can be used as ballast. Take into account, the long starting period.

Low pressure lamps:

Without compens.: Making curr. $1 \times X_{I_e}$, $\cos\varphi$ 0,3; starting time 5 .. 10min
Decisive for selection of device: 60% continuous current
 $I = I_{eAC1} \times 0,6$

With compensation: Making curr.: $20 \times X_{I_e}$, $\cos\varphi$ 0,45; starting time 5 .. 10min
(at $1,6 \times I_n$), $I = I_{Spitze}/200$

High pressure lamps:

Without compens.: Making curr. $1,4 \times X_{I_e}$, $\cos\varphi$ 0,5; starting time 5 .. 10min
Decisive for selection of device: 60% continuous current
 $I = I_{eAC1} \times 0,6$

With compensation: Making curr.: $20 \times X_{I_e}$, $\cos\varphi$ 0,95; starting time 5 .. 10min
(at $1,6 \times I_n$)

	Power	Current	Capacitor	Z-SCH/25/.. CMUC.../25/	Z-SCH/40/..	Z-SCH/63/..	Z-SC	
	W	A	µF	max. number of lamps per current path at 230V, 50 Hz				
Sodium vapour lamps low-pressure without compensation	35	1,5	-	9	22	30	-	
	55	1,5	-	9	22	30	-	
	90	2,4	-	6	13	19	-	
	135	3,3	-	4	10	14	-	
	150	3,3	-	4	10	14	-	
	180	3,3	-	4	10	14	-	
	200	3,3	-	4	10	14	-	
	Sodium vapour lamps low-pressure with compensation, with parallel comp.	35	0,31	20	6	15	18	-
		55	0,42	20	4	15	18	-
		90	0,63	30	4	10	12	-
		135	0,94	45	3	7	8	-
		150	1	40	3	8	9	-
		180	1,16	40	3	8	9	-
	200	1,32	30	-	10	12	-	
Sodium vapour lamps high-pressure without compensation	150	1,8	-	8	15	22	-	
	250	3	-	5	10	13	-	
	330	3,7	-	4	8	10	-	
	400	4,7	-	3	6	8	-	
	1000	10,3	-	1	3	4	-	
	Sodium vapour lamps high pressure with compensation, with parallel comp.	150	0,83	20	7	20	25	-
		250	1,5	33	4	12	15	-
		330	2	40	3	10	13	-
		400	2,4	48	2	8	12	-
		1000	6,3	106	1	4	6	-
Sodium vapour lamps high pressure with electronic ballast (50-125xln) HQI	20	0,1	i	9	18	20	-	
	35	0,2	i	6	11	13	-	
	70	0,36	i	5	12	12	-	
	150	0,7	i	4	10	10	-	

Controlling & Switching

Utilisation Categories of Contactors

Type of current	Utilisation category	Typical Applications I = Making current, I _c = Breaking current, I _e = Rated operational current, U = Voltage, U _e = Rated operational voltage U _r = Recovery voltage	Verification of electrical service life														
			Switching on							Switching off							
			I _e	I	U	cosφ	I _c	U _r	cosφ	I _e	I	U	cosφ	I _c	U _r	cosφ	
			A	A	V		A	V		A	V		A	V			
AC	AC-1	Non-inductive or slightly inductive load Resistance furnaces	all values	1	1	0,95	1	1	0,95	all values	1,5	1,05	0,8	1,5	1,05	0,8	
	AC-2	Slip ring motors: starting, switching off	all values	2,5	1	0,65	2,5	1	0,65	all values	4	1,05	0,65	4	1,05	0,8	
	AC-3	Squirrel cage motors: starting, switching off (running motors ⁴)	I _e ≤ 17 I _e > 17	6 6	1 1	0,65 0,35	1 1	0,17 0,35	0,65 0,35	I _e ≤ 100 I _e > 100	10 8	1,05 1,05	0,45 0,35	8 6	1,05 1,05	0,45 0,35	
	AC-4	Squirrel cage motors: starting, plugging reversing, inching	I _e ≤ 17 I _e > 17	6 6	1 1	0,65 0,35	6 6	1 1	0,65 0,35	I _e ≤ 100 I _e > 100	12 10	1,05 1,05	0,45 0,35	10 8	1,05 1,05	0,45 0,35	
	AC-5 AC-5b	Switching of electric discharge lamp controls Switching of incandescent lamps									3,0 1,5 ²⁾	1,05 1,05	0,45 2)	3,0 1,05 ²⁾	1,05 1,05	0,45 2)	
	AC-6a ³⁾ AC-6b ³⁾	Switching of transformers Switching of capacitor banks															
	AC-7a	Slightly inductive loads in household appliances and similar applications	according to manufacturer specifications								1,5	1,05	0,8	1,5	1,05	0,8	
	AC-7b	Motor loads for household appliances									8,0	1,05	1)	8,0	1,05	1)	
	AC-8a	Switching of hermetically enclosed refrigerant compressor motors with manual reset of overload releases ⁵⁾									6,0	1,05	1)	6,0	1,05	1)	
	AC-8b	Switching of hermetically enclosed refrigerant compressor motors with automatic reset of overload releases ⁵⁾									6,0	1,05	1)	6,0	1,05	1)	
DC	DC-1	Non-inductive or slightly inductive load, Resistance furnaces	all values	1	1	1	1	1	1	all values	1,5	1,05	1	1,5	1,05	1	
	DC-3	Shunt motors: starting, plugging, reversing, inching, dynamic braking	all values	2,5	1	2	2,5	1	2	all values	4	1,05	2,5	4	1,05	2,5	
	DC-5	Series motors: starting, plugging, reversing, inching, dynamic braking	all values	2,	1	7,5	2,5	1	7,5	all values	4	1,05	2,5	4	1,05	2,5	
	DC-6	Switching of incandescent lamps									1,5 ²⁾	1,05	2)	1,5 ²⁾	1,05	2)	

according to IEC 947-4-1, EN 60 947 VDE 0660 Part 102

¹⁾ cosφ = 0,45 for I_e ≤ 100 A; cosφ = 0,35 for I_e ≤ 100 A.

²⁾ The tests must be carried out with an incandescent lamp load connected.

³⁾ In this case, the test data must be derived from the test values for AC-3 or AC-4 according to a special table.

⁴⁾ Devices for utilisation category AC-3 may be used for occasional inching or plugging during a limited period, such as for setting up a machine. However, during this limited period of time, the number of operations must not exceed five per minute or ten in a ten minute period.

⁵⁾ Hermetically enclosed refrigerant compressor motor means a combination of a compressor and a motor both of which are housed in the same enclosure with no external shaft or shaft seals, the motor running in the refrigerant.

Utilisation Categories of Auxiliary Switches

Type of current	Utilisation category	Typical Applications I = Making current, I _c = Breaking current, I _e = Rated operational current, U = Voltage, U _e = Rated operational voltage U _r = Recovery voltage t _{0,95} = the time in ms until 95% of the stationary current has been reached P = U _e × I _e = Rated power in Watts	Divergent conditions of use														
			Normal conditions of use						Switching on						Switching off		
			I	U	cosφ	I	U	cosφ	I	U	cosφ	I	U	cosφ	I	U	cosφ
			I _e	U _e		I _e	U _e		I _e	U _e		I _e	U _e		I _e	U _e	
AC	AC-12	Control of resistive and solid state loads in optocoupler input circuits	1	1	0,9	1	1	0,9	-	-	-	-	-	-	-	-	-
	AC-13	Control of solid state loads with transformerisolation	2	1	0,65	1	1	0,65	10	1,1	0,65	1,1	1,1	0,65	1,1	1,1	0,65
	AC-14	Control of small electromagnetic loads (max. 72 VA)	6	1	0,3	1	1	0,3	6	1,1	0,7	6	1,1	0,7	6	1,1	0,7
	AC-15	Control of electromagnetic loads (above 72 VA)	10	1	0,3	1	1	0,3	10	1,1	0,3	10	1,1	0,3	10	1,1	0,3
DC	DC-12	Control of resistive and solid state loads in optocoupler input circuits	1	1	1 ms	1	1	1 ms	-	-	-	-	-	-	-	-	-
	DC-13	Control of electromagnets	1	1	6xP ¹⁾	1	1	6xP ¹⁾	1,1	1,1	6xP ¹⁾	1,1	1,1	6xP ¹⁾	1,1	1,1	6xP ¹⁾
	DC-14	Control of electromagnetic loads with economy resistors in the circuit	10	1	15 ms	1	1	15 ms	10	1,1	15 ms	10	1,1	15 ms	10	1,1	15 ms

according to IEC 947-4-1, EN 60 947 VDE 0660 Part 102

¹⁾ The value „6xP“ is the result of an empirical relationship which is found to represent most direct current magnetic loads up to an upper limit of P = 50W with 6 [ms]/[W] = 200 [ms]. Loads with a rated power above 50 W are composed of small loads located parallel to each other. Therefore, 300 ms is an upper limit independent of the power rating.

Controlling & Switching

Impulse Relay Z-S.

- Impulse relays according to EN/IEC 60669 for switching electrical consumers in impulse operation.
- Shape and terminal compatible with the installation relay range
- Manual operation for testing purposes is possible
- Separately switchable LED (Z-SB../SS) for signalling purposes
- Glow lamps of illuminated pushbuttons connected parallel produce reactive currents which may be compensated by a capacitor block in order to prevent excessive heating of coils in case of high numbers of glow lamps.
- Glow lamps parallel to control keys according to table
- Main contacts can be connected to standard pin busbar

Security:

- Optional optical operating status display by means of LED
- Switching position indicated on the front side by manual operating key
- All terminals - coil and contacts - equipped with guide for secure terminal connection. Misplacement of wires impossible.
- Made of hardly flammable materials and plastics free from chlorine and halogens.
- Finger and hand touch safe according to VBG4

Advantages:

- Available in two versions (Z-S., Z-SB.)
- Low switching noise and no humming
- Easy to connect thanks to large terminals which are supplied open
- Simple snap-on fastening on 35 mm DIN rail
- High degree of flexibility thanks to a variety of contact configurations
- Easy access for coil connection

Accessories:

Capacitor block	Z-S/KO	270588
-----------------	--------	--------

Connection diagrams

1MU Z-S./.

"S"
1 NO

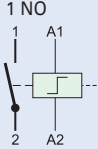

"SS"
2 NO

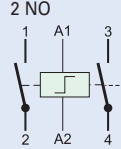

"W"
1 CO

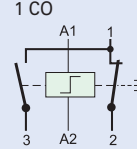

Z-SB../SS
2 NO

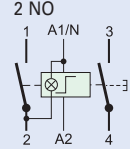

2MU Z-S./.

"WW"
2 CO

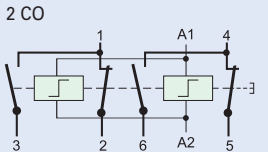

"2S20"
2 NO / 2 NC

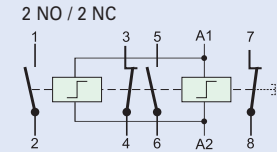

Technical Data

Electrical

Rated current (IEC/EN 60669-2-2)	
250 V AC	16 A
Number of poles	1 to 4
Main contacts	
NO/NC	1 and 2 (1MU); 3 and 4 (2MU)
CO	1 (1MU); 2 (2MU)

Control Circuit

Rated control feed voltage U_s	8, 12, 24, 48, 230 V AC
	8, 12, 24, 110 V DC

Alternative control voltages, frequencies, and contact arrangements upon enquiry

Rated frequency	50 Hz
Operating range	0.9-1.1 x U_s
Pickup power of coils	12 VA / 7 W typ.
Max. number of parallel pushbutton units	unlimited
Max. number of parallel illuminated pushbutton units 230 V 0.6 mA typ.	
without compensation	8 units (1MU), 15 units (2MU)
with compensation 1 x Z-SC/KO (Z-S/KO)	23 units (1MU), -
with compensation 2 x Z-SC/KO (Z-S/KO)	46 units (1MU), 43 units (2MU)
Minimum command duration	> 200 ms
Operating noise	no humming
Rated peak withstand voltage U_{imp}	2 kV (1.2/50 μ s)
Duty max.	1h, 100% with spacer

Load Circuit

Rated operational voltage U_n	1p, 2p: 250VAC; 3p, 4p: 240/415VAC
Minimum operational voltage U_{min}	24 V AC/DC (U_s 8-110 V)
Rated insulation voltage U_i	500 V
Rated peak withstand voltage U_{imp}	4 kV (1.2/50 μ s)
Conventional thermal current I_{th}	16 A AC
Rated operational current I_e	16 A AC

Rated constant current I_u	16 A AC
Rated current DC	
24 V	I_e 16 A
48 V	I_e 12.5 A
230 V	I_e 1 A
Conditional rated short circuit current I_q	10 kA (with 20 A gL/gG)
Duration of bouncing	< 10 ms (typ. < 5 ms)
Endurance electrical comp.	$\geq 40 \times 10^3$ operating cycles
mechanical comp.	$\geq 1 \times 10^6$ operating cycles

Mechanical

Frame size	45 mm
Device height	90 mm
Device width	17.5 mm per MU
Mounting	quick fastening on DIN rail IEC/EN 60715
Degree of protection installed device	IP20
Position of device in use	works in any position
Upper and lower terminals	lift terminals (captive)
Terminal capacity	
Contact and coil	0.5 - 10 mm ² one- or more wire
	0.5 - 6 mm ² fine-wire with wire end sleeve
Temperature range	-20°C to +45°C
Total contact gap	> 5mm / independent contacts
Contact material	does not contain cadmium

Accessories

Capacitor block	1.5 μ F, 240 V AC
-----------------	-----------------------

Dimensions (mm)

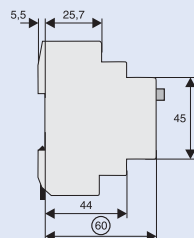
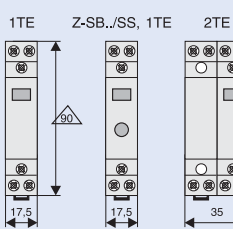

Z-S/KO

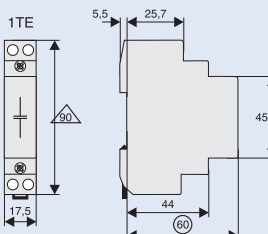

Devices for Modular Installation

Utilization Categories (acc. to IEC/EN 60947-4-1)

UTILIZATION CATEGORIES

1MU (1NO, 2NO, 1NO+1NC, 1CO), 2MU (2NO+2NC, 2CO, 3NO+1NC)

AC-1 $\overline{\text{I}}\overline{\text{M}}\overline{\text{I}}$

Rated operational voltage U_e	250 V AC
Rated operational current I_e	16 A AC
Rated operational power AC-1	3200 W ($\cos \varphi = 0.8$), 4000 VA
Make-/break-current I_c (AC-1)	24 A AC

AC-3 M

Rated operational voltage U_e	250 V AC
Rated operational current I_e	8 A AC
Rated operational power AC-3	900 W ($\cos \varphi = 0.45$), 2000 VA
Make-/break-current I_c (AC-3)	80 A AC

AC-5a \otimes

Rated operational voltage U_e	250 V AC
Rated operational current I_e	10 A AC
Rated operational power AC-5a	1125 W ($\cos \varphi = 0.45$), 2500 VA
Make-/break-current I_c (AC-5a)	30 A AC

AC-5b \otimes

Rated operational voltage U_e	230 V AC
Rated operational current I_e	8.8 A AC
Rated operational power AC-5b	2024 W
Make-/break-current I_c (AC-5b)	13.2 A AC

AC-7a (acc. to EN 61095) M

Rated operational voltage U_e	250 V AC
Rated operational current I_e	16 A AC
Rated operational power AC-7a	3200 W ($\cos \varphi = 0.8$), 4000 VA
Make-/break-current I_c (AC-7a)	24 A AC

UTILIZATION CATEGORIES

2MU (3NO, 4NO)

AC-1 $\overline{\text{I}}\overline{\text{M}}\overline{\text{I}}$

Rated operational voltage U_e	240/415 V AC
Rated operational current I_e	16 A AC
Rated operational power AC-1	3200 W ($\cos \varphi = 0.8$), 4000 VA
Make-/break-current I_c (AC-1)	24 A AC

AC-3 M

Rated operational voltage U_e	240/415 V AC
Rated operational current I_e	8 A AC
Rated operational power AC-3	900 W ($\cos \varphi = 0.45$), 2000 VA
Make-/break-current I_c (AC-3)	80 A AC / 64 A AC

AC-5a \otimes

Rated operational voltage U_e	240/415 V AC
Rated operational current I_e	10 A AC
Rated operational power AC-5a	1125 W ($\cos \varphi = 0.45$), 2500 VA
Make-/break-current I_c (AC-5a)	30 A AC

AC-5b \otimes

Rated operational voltage U_e	230/400 V AC
Rated operational current I_e	8.8 A AC
Rated operational power AC-5b	2024 W
Make-/break-current I_c (AC-5b)	13.2 A AC

AC-7a (acc. to EN 61095) M

Rated operational voltage U_e	240/415 V AC
Rated operational current I_e	16 A AC
Rated operational power AC-7a	3200 W ($\cos \varphi = 0.8$), 4000 VA
Make-/break-current I_c (AC-7a)	24 A AC

AC-7b (acc. to EN 61095) M

Rated operational voltage U_e	240/415 V AC
Rated operational current I_e	10 A AC
Rated operational power AC-7b	1125 W ($\cos \varphi = 0.8$), 2500 VA
Make-/break-current I_c (AC-7b)	30 A AC

Lamp Types	Power W	Current A	Capacitor μF	Z-S max. number of lamps per current path at 230V, 50 Hz
Incandescent lamps	60	0,27		33
Low-voltage halogen lamps (12 or 24 V) with transformer / electronic transformer	20	0,09		55
	50	0,22		22
	75	0,33		14
	100	0,43		11
	150	0,65		7
	200	0,87		5
	300	1,3		3
Fluorescent tubes without compensation or with series comp.	11	0,16	1,3	62
	18	0,37	2,7	27
	24	0,35	2,5	27
	36	0,43	3,4	24
	58	0,67	5,3	15
	65	0,67	5,3	14
	85	0,8	5,3	12
	Fluorescent tubes lead-lag circuit	11	0,07	-
18		0,11	-	2 x 45
24		0,14	-	2 x 35
36		0,22	-	2 x 22
58		0,35	-	2 x 14
65		0,35	-	2 x 14
85		0,47	-	2 x 10
Fluorescent tubes with parallel comp.	11	0,16	3,0	34
	18	0,37	4,0	26
	24	0,35	4,0	26
	36	0,43	4,0	26
	58	0,67	7,0	14
	65	0,67	7,0	14
	85	0,8	8,0	13
	Fluorescent tubes with electronic ballast	18	0,09	-
36		0,16	-	16
58		0,25	-	12
2 x 18		0,17	-	2 x 16
2 x 36		0,32	-	2 x 8
2 x 58	0,49	-	2 x 6	

Controlling & Switching

Impulse Relay with Switchable LED

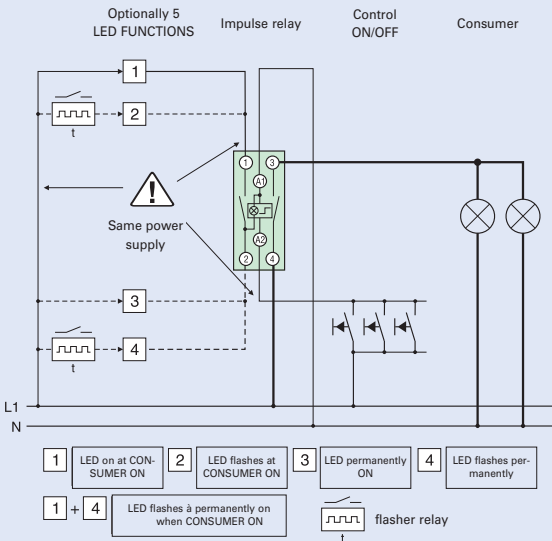

Applikation at 24 V AC and DC

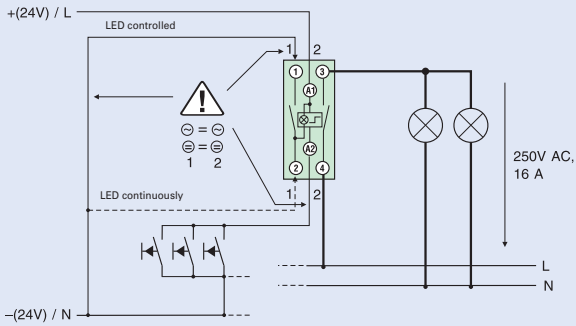

Controlling & Switching

Impulse Relay Z-SC with Central Control

- Impulse relay according to EN/IEC 60669 for switching electrical consumers in impulse operation.
- Local and central control, capable of switching 2-stage groups
- Shape and terminal compatible with the installation relay range
- Manual operation for testing purposes is possible
- Glow lamps of illuminated pushbuttons connected parallel produce reactive currents which may be compensated by a capacitor block in order to prevent excessive heating of coils in case of high numbers of glow lamps.
- Glow lamps parallel to control keys according to table
- Main contacts can be connected to standard busbar

Security:

- Switching position indicated on the front side by manual operating key
- All terminals - coil and contacts - equipped with guide for secure terminal connection. Misplacement of wires impossible.
- Made of hardly flammable materials and plastics free from chlorine and halogens.
- Finger and hand touch safe according to VBG4.

Advantages:

- Low switching noise and no humming
- Easy to connect thanks to large terminals which are supplied open
- Simple snap-on fastening on 35 mm DIN rail
- High degree of flexibility thanks to a variety of contact configurations
- Easy access for coil connection

Connection diagrams

1MU Z-SC./S

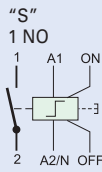

2MU Z-SC./.

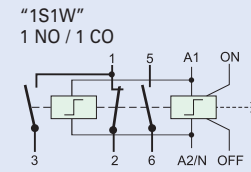

2MU Z-SC./.

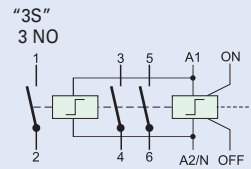
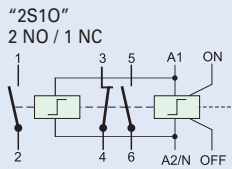

- Permanent command, control by long pulse (1MU) and timer is possible



Technical Data

Electrical

Rated current (IEC/EN 60669-2-2)	
250 V AC	16 A
Number of poles	1 to 3
Main contacts	
NO	1 (1MU), 3 (2MU)
NO + NC	2+1 (2MU)
CO + NO	1 (2MU)

Control Circuit

Rated control feed voltage U_s	12, 24, 110, 230, 240 V AC
Alternative control voltages, frequencies, and contact arrangements upon enquiry	
Rated frequency	50 Hz; 50-60 Hz 240 V
Operating range	$0.9-1.1 \times U_s$
Maximum power of coils, pick-up	$U_s = 24V: 25VA (15W)$ $U_s = 230V: 32VA (19W)$
Max. number of parallel pushbutton units	unlimited
Max. number of parallel illuminated pushbutton units 230 V 0.6 mA typ.	
without compensation	4 units (1MU, 2MU)
with compensation 1 x Z-SC/KO (Z-S/KO)	19 units (1MU), 9 units (2MU)
with compensation 2 x Z-SC/KO (Z-S/KO)	30 units (1MU), 18 units (2MU)
Minimum command duration	> 200 ms
Operating noise	no humming
Rated peak withstand voltage U_{imp}	2 kV (1.2/50 μ s)
Duty	100% (1MU) see above \triangle <100% (2MU), 1 h max. with spacer

Load Circuit

Rated operational voltage U_n	1p, 2p: 250VAC; 3p, 4p: 240/415VAC
Minimum operational voltage U_{min}	24 V AC/DC (U_s 8-110 V)
Rated insulation voltage U_i	500 V
Rated peak withstand voltage U_{imp}	4 kV (1.2/50 μ s)
Conventional thermal current I_{th}	16 A AC

Rated operational current I_e	16 A AC
Rated constant current I_u	16 A AC
Rated current DC	
24 V	I_e 16 A
48 V	I_e 12.5 A
230 V	I_e 1 A
Conditional rated short circuit current I_q	10 kA (with 20 A gL/gG)
Duration of bouncing	< 10 ms (typ. < 5 ms)
Endurance electrical comp.	$\geq 40 \times 10^3$ operating cycles
mechanical comp.	$\geq 1 \times 10^6$ operating cycles

Mechanical

Frame size	45 mm
Device height	90 mm
Device width	17.5 mm (1MU)
Mounting	quick fastening on DIN rail IEC/EN 60715
Degree of protection installed device	IP20
Position of device in use	works in any position
Upper and lower terminals	lift terminals (captive)
Terminal capacity	
Contact and coil	0.5 - 10 mm ² one- or more wire 0.5 - 6 mm ² fine-wire with wire end sleeve
Temperature range	-20°C to +45°C
Total contact gap	> 5mm / independent contacts
Contact material	does not contain cadmium

Accessories

Capacitor block	1.5 μ F, 240 V AC
Group block	240 V AC

Dimensions (mm)

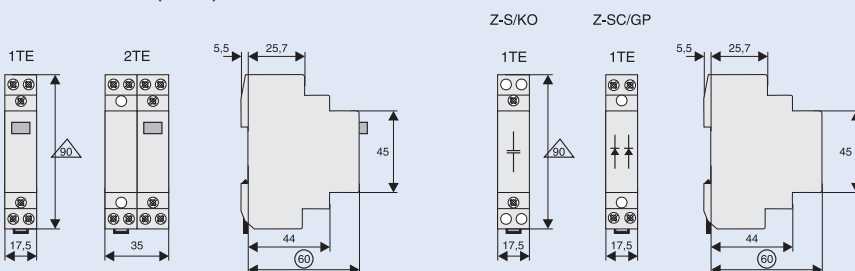

Controlling & Switching

Utilization Categories (acc. to IEC/EN 60947-4-1)

UTILIZATION CATEGORIES

1MU (1NO, 2NO, 1NO+1NC, 1CO), 2MU (2NO+2NC, 2CO, 3NO+1NC)

AC-1 $\overline{\square}\square$

Rated operational voltage U_e	250 V AC
Rated operational current I_e	16 A AC
Rated operational power AC-1	3200 W ($\cos \varphi = 0.8$), 4000 VA
Make-/break-current I_c (AC-1)	24 A AC

AC-3 \odot

Rated operational voltage U_e	250 V AC
Rated operational current I_e	8 A AC
Rated operational power AC-3	900 W ($\cos \varphi = 0.45$), 2000 VA
Make-/break-current I_c (AC-3)	80 A AC

AC-5a \otimes

Rated operational voltage U_e	250 V AC
Rated operational current I_e	10 A AC
Rated operational power AC-5a	1125 W ($\cos \varphi = 0.45$), 2500 VA
Make-/break-current I_c (AC-5a)	30 A AC

AC-5b \otimes

Rated operational voltage U_e	230 V AC
Rated operational current I_e	8.8 A AC
Rated operational power AC-5b	2024 W
Make-/break-current I_c (AC-5b)	13.2 A AC

AC-7a (acc. to EN 61095) \blacksquare

Rated operational voltage U_e	250 V AC
Rated operational current I_e	16 A AC
Rated operational power AC-7a	3200 W ($\cos \varphi = 0.8$), 4000 VA
Make-/break-current I_c (AC-7a)	24 A AC

UTILIZATION CATEGORIES

2MU (3NO, 4NO)

AC-1 $\overline{\square}\square$

Rated operational voltage U_e	240/415 V AC
Rated operational current I_e	16 A AC
Rated operational power AC-1	3200 W ($\cos \varphi = 0.8$), 4000 VA
Make-/break-current I_c (AC-1)	24 A AC

AC-3 \odot

Rated operational voltage U_e	240/415 V AC
Rated operational current I_e	8 A AC
Rated operational power AC-3	900 W ($\cos \varphi = 0.45$), 2000 VA
Make-/break-current I_c (AC-3)	80 A AC / 64 A AC

AC-5a \otimes

Rated operational voltage U_e	240/415 V AC
Rated operational current I_e	10 A AC
Rated operational power AC-5a	1125 W ($\cos \varphi = 0.45$), 2500 VA
Make-/break-current I_c (AC-5a)	30 A AC

AC-5b \otimes

Rated operational voltage U_e	230/400 V AC
Rated operational current I_e	8.8 A AC
Rated operational power AC-5b	2024 W
Make-/break-current I_c (AC-5b)	13.2 A AC

AC-7a (acc. to EN 61095) \blacksquare

Rated operational voltage U_e	240/415 V AC
Rated operational current I_e	16 A AC
Rated operational power AC-7a	3200 W ($\cos \varphi = 0.8$), 4000 VA
Make-/break-current I_c (AC-7a)	24 A AC

AC-7b (acc. to EN 61095) \odot

Rated operational voltage U_e	240/415 V AC
Rated operational current I_e	10 A AC
Rated operational power AC-7b	1125 W ($\cos \varphi = 0.8$), 2500 VA
Make-/break-current I_c (AC-7b)	30 A AC

Lamp Types	Power W	Current A	Capacitor μ F	Z-SC max. number of lamps per current path at 230V, 50 Hz
Incandescent lamps	60	0,27		33
Low-voltage halogen lamps (12 or 24 V) with transformer / electronic transformer	20	0,09		55
	50	0,22		22
	75	0,33		14
	100	0,43		11
	150	0,65		7
	200	0,87		5
	300	1,3		3
Fluorescent tubes without compensation or with series comp.	11	0,16	1,3	62
	18	0,37	2,7	27
	24	0,35	2,5	27
	36	0,43	3,4	24
	58	0,67	5,3	15
	65	0,67	5,3	14
	85	0,8	5,3	12
	Fluorescent tubes lead-lag circuit	11	0,07	-
18		0,11	-	2 x 45
24		0,14	-	2 x 35
36		0,22	-	2 x 22
58		0,35	-	2 x 14
65		0,35	-	2 x 14
85		0,47	-	2 x 10
Fluorescent tubes with parallel comp.	11	0,16	3,0	34
	18	0,37	4,0	26
	24	0,35	4,0	26
	36	0,43	4,0	26
	58	0,67	7,0	14
	65	0,67	7,0	14
	85	0,8	8,0	13
	Fluorescent tubes with electronic ballast	18	0,09	-
36		0,16	-	16
58		0,25	-	12
2 x 18		0,17	-	2 x 16
2 x 36		0,32	-	2 x 8
2 x 58		0,49	-	2 x 6

Controlling & Switching

Block Diagram for Central, Group, and Local Control

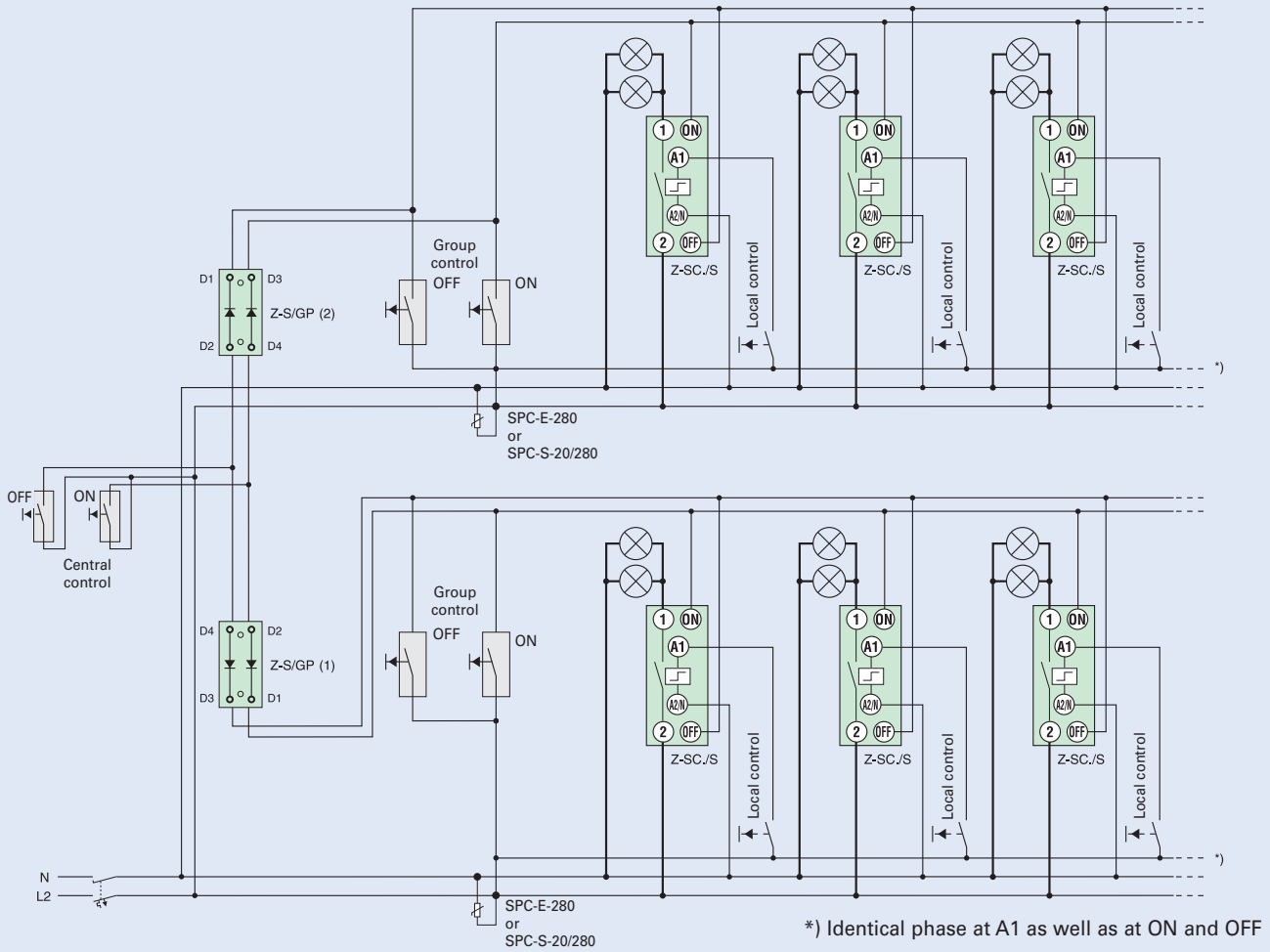

Compensation by Means of Capacitor Block

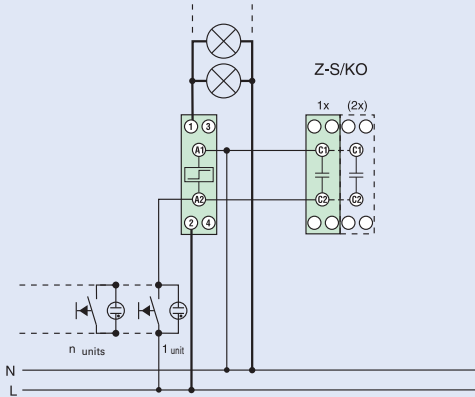

Controlling & Switching

Staircase Switch with switch-off warning and stop function TLE, TLK

- Automatic electronic staircase switch
- Switch-off warning can be switched off (type TLK)
- Subsequent switching is possible, programmable long-time function
- Power saving function, low switching noise
- Automatic 3-/4-wire circuit recognition
- Zero voltage safety thanks to memory function (type TLK)
- Central control function (type TLK)
- External voltage control input (type TLK)

Connection diagrams

e.g. 3 wire circuit TLE

e.g. 4 wire circuit with attic lighting TLK

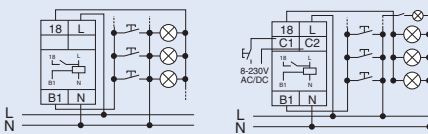

Technical Data

Electrical

Feed voltage	230 VAC
Rated voltage tolerance	-15%, +10%
Power consumption	6 VA (0.8 W)
Rated frequency	48-63 Hz
Duty	100%
Reset time	500 ms
Adjustment range	0,5 - 15 min.
Overvoltage category	III (in acc. with IEC 60664-1)
Rated surge voltage	4 kV

Output

Contact	1 NO (Terminals L-18)
Rated voltage	250 VAC
Constant current	16 A
Switch on peak current (20 ms)	80 A
Switching capacity AC	4000 VA / AC1, 384 W / DC
Maximum current	30 A / < 3s
Switching voltage	250 V AC1 / 24 V DC
Minimum switching capacity DC	500 mW
Output indication	yellow LED ()
Mechanical endurance	30 x 10 ⁶ switching operations
Electrical endurance (AC1)	10 x 10 ⁵ switching op. 16A/250V

Control input B1

Connection (carrying voltage)	Pushbutton T-N (3 wire circuit) Pushbutton T-L (4 wire circuit)
Glow lamps parallel to control keys	max. 100 mA
Overload protection	electronic
Control input C1-C2 (Type TLK)	8-230 V AC/DC

Mechanical

Frame size	45 mm
Device height	87 mm
Device width	17.5 mm (1MU)
Installation	quick fastening on DIN rail IEC/EN 60715
Protection class / Pollution degree	IP20 / 2
Type of connection	lift terminal acc. to VBG 4 (PZ1 required)
Terminal capacity	1x 0.5-4 mm ² 2x 0.5-2,5 mm ²
Tightening torque	max. 1 Nm
Temperature range	-25°C to +55°C
Operation position	any

Dimensions (mm)

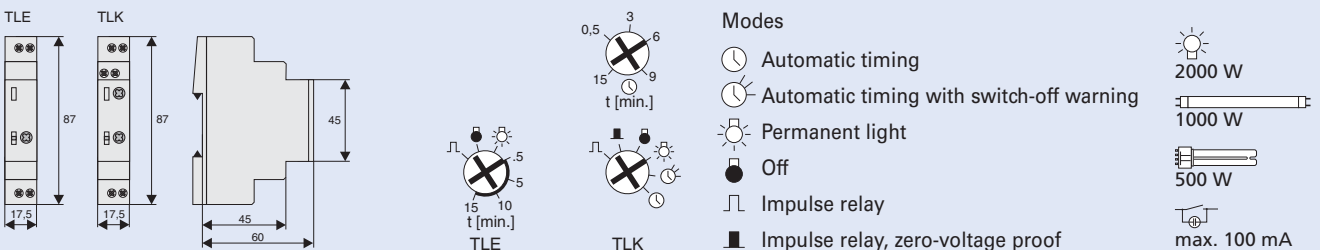



Functional Description

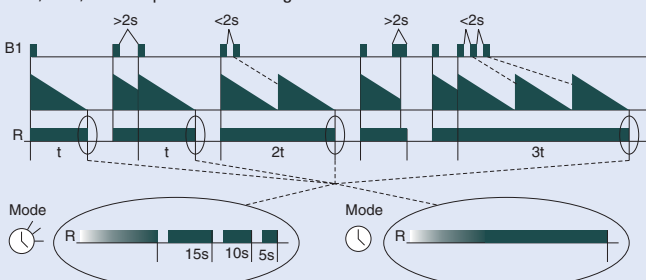

Automatic timing :

After pushing the button the output relay closes (terminals L-18) and the set time starts to run. If the button is pushed again before the time t has lapsed the time re-starts from zero (subsequent switching function in accordance with EN 60669-2-3). Repeated quick pressing of the pushbutton ("pumping") leads to the addition of 2, 3 or more time intervals up to 60 min. Pushing the button once for a long time (> 2 s) stops the running lighting period, and the relay switches off (power saving function). In the  function, the device generates short pulses (flickering) as a switch-off warning (according to DIN 18015-2), 15 s, 10 s, and 5 s prior to switching off.



The additional control input permits activating the staircase switch e.g. from an intercom system by means of a voltage from 8 to 230 V AC/DC in the modes  and . This input channel permits starting the lighting time, as well as subsequent switching. Switching off (power saving function) and programming of longer lighting periods ("pumping") is not possible via this input channel.

Impulse mode :

In the impulse mode each push of the button makes the output relay switch over. In the function  the output relay is always open after the feed voltage has been applied. In the function  the relay immediately picks up when the feed voltage is applied provided that it was closed prior to the power failure. By applying a short voltage pulse (< 2 s) to the additional control input C1-C2 the relay R is switched on (central ON). A longer voltage pulse (> 2 s) causes the relay R to switch off (central OFF).

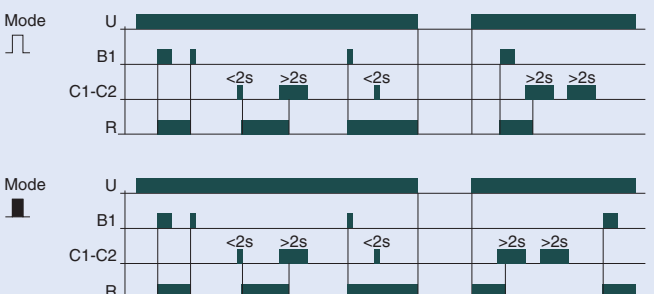

Controlling & Switching

Time Lag Relays ZR

Functions

• ZRER/W

- E ON delay
- R OFF delay

• ZRMF1/W, ZRMF2/WW

- E ON delay
- R OFF delay
- Ws Single shot leading edge with control input
- Wa Single shot trailing edge with control input
- Es ON delay with control input
- Wu Single shot leading edge voltage controlled
- Bp Flasher pause first

• ZRTAK/W

- Ip Asymmetric flasher pause first
- Ii Asymmetric flasher pulse first

Indicators:

ZRER/W, ZRMF1/W, ZRMF2/WW

- Green LED U/t ON: indication of supply voltage
- Green LED U/t flashes: indication of time period
- Yellow LED R ON/OFF: indication of output relay

ZRTAK/W

- Green LED U/t ON: indication of supply voltage
- Green LED U/t slow flashing: indication of time period t1
- Green LED U/t fast flashing: indication of time period t2
- Yellow LED R ON/OFF: indication of output relay

Connection diagram

Type ZRTAK/W

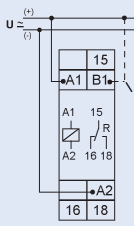

Type ZRER/W, ZRMF1/W

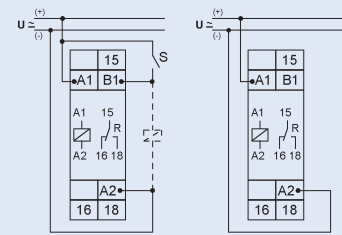

Type ZRMF2/WW

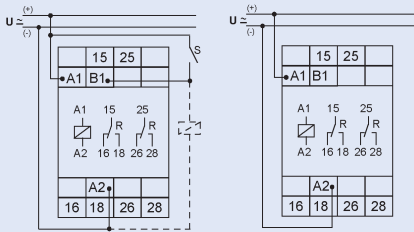

Time Ranges

Absolute time range	Setting range	
1s	50ms	1s
10s	500ms	10s
1min	3s	1min
10min	30s	10min
1h	3min	1h
10h	30min	10h
100h	5h	100h

Dimensions (mm)

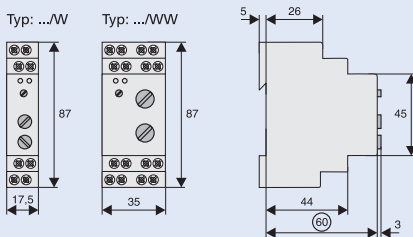

Technical Data

Electrical

Design according to	EN 60669
Basic accuracy	±1% (of scale end value)
Setting accuracy	<5% (of scale end value)
Repeating accuracy:	<0.5% or ±5ms
Effect of voltage	-
Effect of temperature	≤0.01% / °C

Input circuit:

Feed voltage	
Terminals A1-A2	24V to 240V AC/DC, 24V/-15% to 240V/+10%
Nominal frequency	48 to 63Hz

Nominal consumption

Type: .../W	4VA (1.5W)
Type: .../WW	6VA (2W)

Duty	100%
Operational again after	100ms
Residual ripple in case of DC	10%
Release voltage	>30% of min. feed voltage

Output circuit:

Switching capacity	potential-free CO
Fuse protection	2000 VA (8A / 250V AC)
Mechanical endurance	8A quick-acting
Electrical endurance	20 x 10 ⁶ operating cycles
at a resistive load of 1000 VA	2 x 10 ⁵ operating cycles
Switching frequency	
at a resistive load of 100 VA	max. 60/min,
at a resistive load of 1000 VA	max. 6/min
(in acc. with IEC 60947-5-1)	
Rated surge voltage	4kV
Overvoltage category	III (in acc. with IEC 60664-1)

Control contact:

Input carrying potential	Terminals A1-B1
loadable	yes
Maximum line length	10m
Minimum control pulse length	
DC	50ms
AC	100ms
Trigger level (sensitivity)	automatic adaption to supply voltage

Mechanical

Frame size	45 mm
Device height	87 mm
Device width	17.5 (/W) and 35 (/WW) mm
Degree of protection, built-in	IP40
Position of installation	optional
Upper and lower terminals	Bow terminal
Terminal protection	finger and hand touch safe, BGV A3, ÖVE-EN 6
Terminal capacity	
1 x 0,5-2,5 mm ²	with/without multicore cable end
1 x 4 mm ²	without multicore cable end
2 x 0,5-1,5 mm ²	with/without multicore cable end
2 x 2,5 mm ²	flexible without multicore cable end
Tightening torque	
of terminal screws	max. 1 Nm
Permitted relative humidity	15% to 85%
in acc. with IEC 60721-3-3 Class 3K3	
Ambient temperature	-25 to +55°C
in acc. with IEC 60068-1	
Storage and transport temperature	-25 to +70°C
Pollution degree	2
when built in	3

Controlling & Switching

Description of Functions

• ON delay (E)

When the supply voltage U is applied, the set interval t begins (green LED U/t flashes). After the interval t has expired (green LED U/t illuminated) the output relay R switches into on-position (yellow LED illuminated). This status remains until the supply voltage is interrupted. If the supply voltage is interrupted before the expiry of the interval t, the interval already expired is erased and is restarted when the supply voltage is next applied.



• OFF delay (R)

The supply voltage U must be constantly applied to the device (green LED U/t illuminated). When the control contact S is closed, the output relay R switches into on-position (yellow LED illuminated). If the control contact is opened, the set interval t begins (green LED flashes). After the interval t has expired (green LED U/t illuminated) the output relay switches into off-position (yellow LED not illuminated). If the control contact is closed again before the interval t has expired, the interval already expired is erased and is restarted.

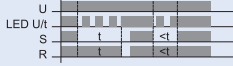

• Single shot leading edge with control input (Ws)

The supply voltage U must be constantly applied to the device (green LED U/t illuminated). When the control contact S is closed, the output relay R switches into on-position (yellow LED illuminated) and the set interval t begins (green LED U/t flashes). After the interval t has expired (green LED U/t illuminated) the output relay switches into off-position (yellow LED not illuminated). During the interval, the control contact can be operated any number of times. A further cycle can only be started when the cycle run has been completed.



• Single shot trailing edge with control input (Wa)

The supply voltage U must be constantly applied to the device (green LED U/t illuminated). Closing the control contact S has no influence on the condition of the output R. When the control contact is opened, the output relay switches into on-position (yellow LED illuminated) and the set interval t begins (green LED U/t flashes). After the interval t has expired (green LED U/t illuminated), the output relay switches into off-position (yellow LED not illuminated). During the interval, the control contact can be operated any number of times. A further cycle can only be started when the cycle run has been completed.



• ON delay with control input (Es)

The supply voltage U must be constantly applied to the device (green LED U/t illuminated). When the control contact S is closed, the set interval t begins (green LED U/t flashes). After the interval t has expired (green LED U/t illuminated) the output relay R switches into on-position (yellow LED illuminated). This status remains until the control contact is opened again. If the control contact is opened before the interval t has expired, the interval already expired is erased and is restarted with the next cycle.



• Single shot leading edge voltage controlled (Wu)

When the supply voltage U is applied, the output relay R switches into on-position (yellow LED illuminated) and the set interval t begins (green LED U/t flashes). After the interval t has expired (green LED U/t illuminated) the output relay switches into off-position (yellow LED not illuminated). This status remains until the supply voltage is interrupted. If the supply voltage is interrupted before the interval t has expired, the output relay switches into off-position. The interval already is erased and is restarted when the supply voltage is next applied.



• Flasher pause first (Bp)

When the supply voltage U is applied, the set interval t begins (green LED U/t flashes). After the interval t has expired, the output relay R switches into on-position (yellow LED illuminated) and the set interval t begins again. After the interval t has expired, the output relay switches into off-position (yellow LED not illuminated). The output relay is triggered at a ratio of 1:1 until the supply voltage is interrupted.

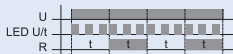

• Asymmetric flasher pause first (Ip)

When the supply voltage U is applied, the set interval t1 begins (green LED U/t flashes slowly). After the interval t1 has expired, the output relay R switches into on-position (yellow LED illuminated) and the set interval t2 begins (green LED U/t flashes fast). After the interval t2 has expired, the output relay switches into off-position (yellow LED not illuminated). The output relay is triggered at the ratio of t1:t2 until the supply voltage is interrupted.

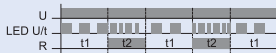

• Asymmetric flasher pulse first (Ii)

When the supply voltage U is applied, the output relay R switches into on-position (yellow LED illuminated) and the set interval t1 begins (green LED U/t flashes slowly). After the interval t1 has expired, the output relay switches into off-position (yellow LED not illuminated) and the set interval t2 begins (green LED U/t flashes fast). After the interval t2 has expired, the output relay switches into on-position (yellow LED illuminated). The output relay is triggered at the ratio of t1:t2 until the supply voltage is interrupted.



Controlling & Switching

Undervoltage Relay REUVM

- When the connection to the three phases and neutral conductor is made the relay is energized in case there is no fault and the green Power LED lights. If the monitored nominal voltage U_N drops under the switching voltage U_S , in one, two or all three phases the relay reverts to its de-energized position.
- Optical indication
 - Power...green LED
 - Fault in phases L1, L2, L3...red LED is flashing
 - Loss of Neutral conductor N...green Power LED is flashing
- Single-phase operation: bridge L1-L2-L3

Connection diagrams

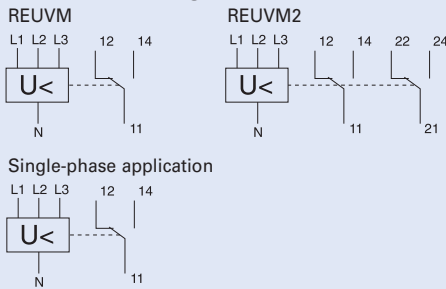

Technical Data

Electrical

Rated operational voltage U_N	230/400 V AC
Rated frequency	50-60 Hz
Switching voltage U_S	$U_N \times 0.85$ fix
Power consumption	< 1 VA
Switching time delay	approx. 500 ms
Switching contact	1 CO, 2 CO (potential-free)
Rated operational voltage / current	250 VAC / 5A $\cos \varphi = 1$ 30 VDC / 5A 300 VDC / 0,25A
Min. rated operational voltage	100 mV AC/DC
Min. rated operational current	10 mA AC/DC
Rated impulse withstand voltage	4 kV
Duty cycle	100%
Overvoltage category	III
Dielectric strength	
Coil – contact circuit	4 kV _{r.m.s}
Open circuit contact	1 kV _{r.m.s}

Mechanical

Frame size	45 mm
Device height	90 mm
Device width	17.8 mm
Weight	65 g, 73 g
Mounting	quick fastening on DIN rail IEC/EN 60715
Degree of protection, built-in	IP40
Upper and lower terminals	lift terminals
Terminal capacity	
rigid	1x4 mm ² , 2x1.5 mm ²
flexible	1x2.5 mm ²
Tightening torque of terminal screws	0.5-0.7 Nm
Resistance to climatic conditions	F / DIN 40040
Perm. ambient temperature range	-25 to +60°C
Flame class	V0, glow wire 960°C
Pollution degree	2
Comparative tracking index	CTI 600

Dimensions (mm)

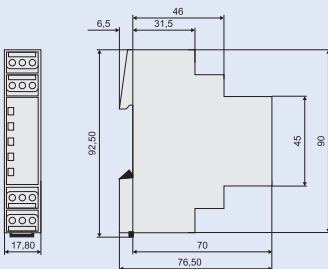

Functional diagram

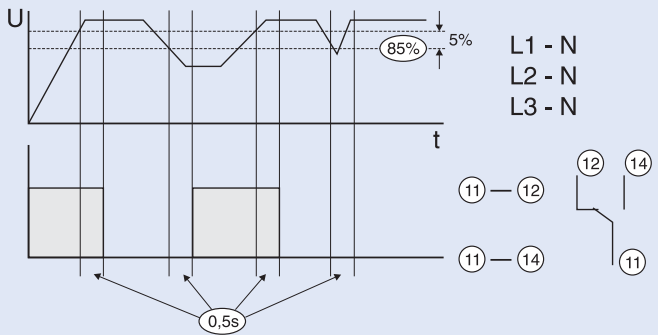

Optical indication and contact position

Operation

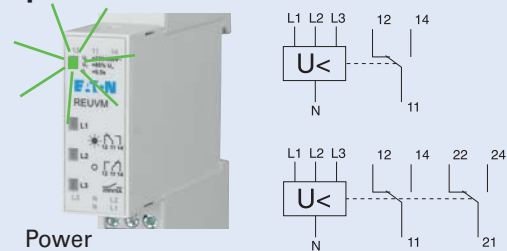

Fault

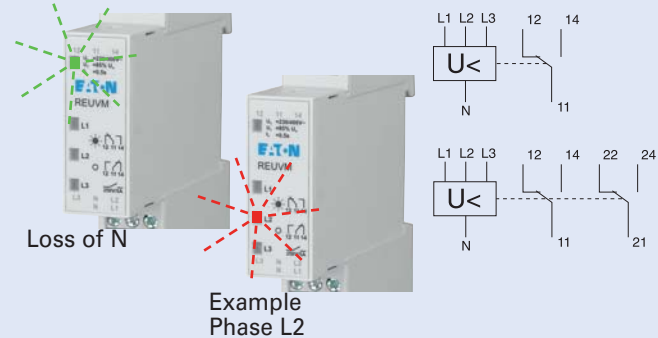

Controlling & Switching

Voltage Indication UVA

- When the connection to the three phases and neutral conductor is made, the green Power LED lights. If only two phases are connected, eg. L1 and L3, only these green LED's lights, even at loss of Neutral conductor N.
- For use as voltage return indication in manual operated Mains-Emergency-system operation
- Large operational voltage range 85-690 V AC/DC

Connection diagram

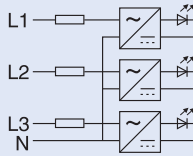

Technical Data

Electrical

Rated operational voltage U_N	230/400 V AC
Rated frequency	50-60 Hz
Rated operational voltage	85-690 V AC/DC
Power consumption	< 3x 23 mW
Max. permissible back-up fuse	16A gG (gL)
Duty cycle	100%
Rated impulse withstand voltage	6 kV
Overvoltage category	IV

Mechanical

Frame size	45 mm
Device height	90 mm
Device width	17.8 mm
Weight	42 g
Mounting	quick fastening on DIN rail IEC/EN 60715
Degree of protection, built-in	IP40
Upper and lower terminals	lift terminals
Terminal capacity	
rigid	1x4 mm ² , 2x1.5 mm ²
flexible	1x2.5 mm ²
Tightening torque of terminal screws	0.5 Nm
Resistance to climatic conditions	F / DIN 40040
Perm. ambient temperature range	-30 to +60°C
Flame class	V0, glow wire 960°C
Pollution degree	2
Comparative tracking index	CTI 600

Dimensions (mm)

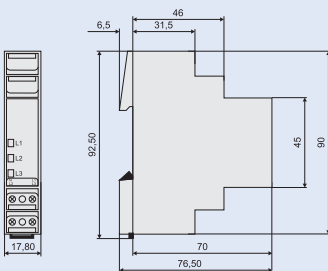

Application and optical indication

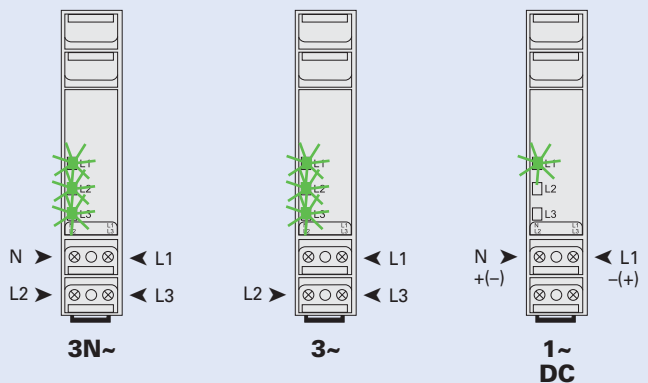

Controlling & Switching

Priority-(Current) Relay Z-LAR/

- For simple priority connection of important consumers
- For fast current increase
- Expensive peak loads are avoided efficiently (staggered heating)
- Integrated auxiliary switch, 1 NC or 1 NO or 1 CO contact
- NC and NO contact are potential free

Connection diagram

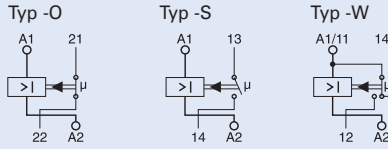

Technical Data

	Z-LAR/8	Z-LAR/16	Z-LAR/32
Electrical			
Nominal thermal current I_{th}	8 A	16 A	32 A
Rated voltage U	250V AC	250V AC	250V AC
Responding current I_{AN}	≥ 3 A	≥ 10 A	≥ 15 A
Release current I_A	≤ 1.8 A	≤ 4.2 A	≤ 7.4 A
Max. electrical switching frequency	3600/h	3600/h	3600/h
Rated insulation voltage U_i	440 V	440 V	440 V
Power loss at I_{th}			
Effective power	3.4 W	1.95 W	3.17 W
Apparent power	7.7 VA	4.66 VA	7.36 VA
Rated peak withstand voltage U_{imp}	4 kV	4 kV	4 kV
Back-up fuse line protection	max. 10 A	max. 16 A	max. 32 A
Switching contact:			
Function NC, NO, CO			
Back-up fuse	max. 1 A gL	max. 1 A gL	max. 1 A gL
Contact gap *)	< 3 mm (μ)	< 3 mm (μ)	< 3 mm (μ)
Switching capacity	1A/250V~	1A/250V~	1A/250V~
Minimum switching capacity	300 mW	300 mW	300 mW
Minimum operational voltage	12 V	12 V	12 V
Electrical endurance	100,000 operating cycles		
*) Do not use as the only means of isolating a device from the line voltage			
Mechanical			
Frame size	45 mm	45 mm	45 mm
Device height	80 mm	80 mm	80 mm
Device width	17.5 mm (1MU)	17.5 mm (1MU)	17.5 mm (1MU)
Mounting	quick fastening on DIN rail IEC/EN 60715		
Degree of protection, built-in	IP40	IP40	IP40
Upper and lower terminals	lift terminals	lift terminals	lift terminals
Terminal protection	finger and hand touch safe, according to BGV A3, ÖVE-EN 6		
Terminal capacity			
Main circuit	2 x 10 mm ²	2 x 10 mm ²	2 x 10 mm ²
Auxiliary circuit	2 x 2.5 mm ²	2 x 2.5 mm ²	2 x 2.5 mm ²
Fastening torque of terminal screws			
Main circuit	max. 2.4 Nm	max. 2.4 Nm	max. 2.4 Nm
Auxiliary circuit	max. 1 Nm	max. 1 Nm	max. 1 Nm

Dimensions (mm)

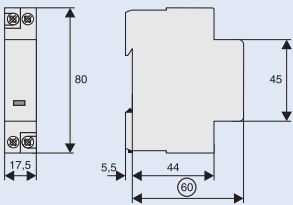

Connection Example - Operating Status

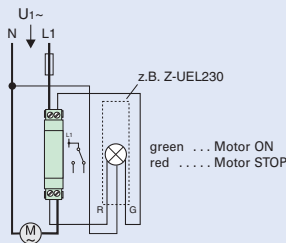

Connection Example - Priority for Pump

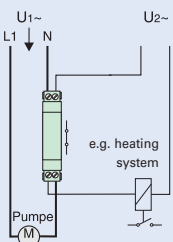

Connection Example - "OR" Circuit, Extraction System

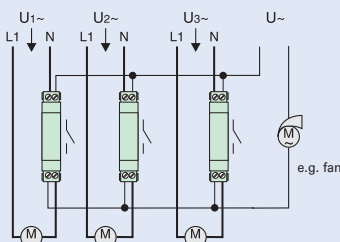

Controlling & Switching

Bioswitch FFS/16

- Line voltage LED
- AUTOMATIC ON/OFF switch
- All-pole disconnection
- 2 contacts NO
- Not suitable for consumers with electronic control

Connection diagram



Technical Data

Electrical

Rated voltage	230 V AC
Tolerance	-15% to +10%
Rated frequency	48 - 63 Hz
Rated consumption	11 VA (1.6 W)
Duration of operation	100%
Detecting voltage	200 - 250 mV DC
Current consumption	32 mA
Making current	5 - 200 mA
Breaking current	fix, approx. 70% of making current
Drop-out voltage	> 10% of the rated voltage
Tripping delay	fixed, approx. 6 s
Rise time	fixed, approx. 0.5 s
Base accuracy	±10% (of max. scale value)
Green LED ON:	indication of supply voltage
Yellow LED ON:	indication of relay output

Output circuit

Switching capacity	2 potentialfree contacts NO 4000 VA (16 A / 250 V AC)
Back-up fuse	16 A fast acting
Mechanical life	30 x 10 ⁶ operations
Electrical life	2 x 10 ⁵ operations at 1000 VA resistive load
Switching frequency	max. 60/min. at 100 VA resistive load max. 6/min. at 1000 VA resistive load (according to IEC 664-1)
Rated insulating voltage	250 V AC (according to IEC 664-1)
Rated surge voltage	4 kV, overvoltage cat. III (according to IEC 664-1)
Base load resistor Z-NKA...	if high-impedance consumers are connected to a "Bio-switch", the Z-NKA... is needed. By pressing the button, the Z-NKA... is activated for 5 minutes. As long as any consumer is still switched on, the automatic deactivating of the Z-NKA... will have no effect.

Mechanical

Frame size	45 mm
Device height	87 mm
Device width	35 mm
Mounting	quick fastening on DIN rail IEC/EN 60715
Degree of protection, built-in	IP40
Installation	in any position
Terminal protection	finger and hand touch safe, BGV A3, ÖVE-EN 6
Torque	max. 1 Nm
Terminal capacity	1 x 0.5-4 mm ² 2 x 0.5-2.5 mm ²
Ambient temperature	-25°C to +55°C
Storage temperature	-25°C to +70°C
Transport temperature	-25°C to +70°C
Relative humidity	15% to 85% (acc. to IEC 721-3-3 class 3K3)
Degree of pollution	2, if built-in 3 (acc. to IEC 664-1)

Dimensions (mm)

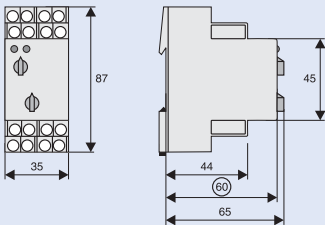

Connection Example

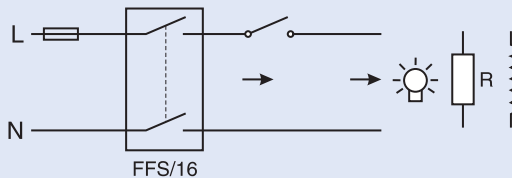

Controlling & Switching

Digital Time Switches with a Weekly Program, for DIN Rail, TSDW1CO, TSDW2CO

- Spring terminals
- Text-based user guidance on the display
- 56 memory cells
- Interface for memory card (PC programming)
- 10 years power backup (lithium battery)
- Zero-cross switching for a relay-saving way of switching and for high lamp loads
- ON-OFF switching times
- Pre-selected switching
- Permanent ON/OFF switching
- Integrated counter for operating hours
- Vacation program
- Display background lighting (can be switched off)
- PIN coding
- Automatic spring forward/fall back at daylight-saving start and end dates
- For type TSDW1CO: 1 channel
- For type TSDW2CO: 2 channels

Connection examples

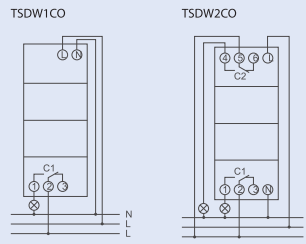

Technical Data

	TSDW1CO	TSDW2CO
Electrical		
Operating voltage	230–240 V AC	230–240 V AC
Frequency	50–60 Hz	50–60 Hz
Power backup	10 years	10 years
Switching capacity at 250 V AC, $\cos \varphi = 1$	16 A	16 A
Switching capacity at 250 V AC, $\cos \varphi = 0.6$	10 A	10 A
Incandescent/halogen lamp load	2600 W	2600 W
Min. switching capacity	approx. 10 mA	approx. 10 mA
Shortest switching time	1 min	
Accuracy	$\leq \pm 0.5$ s/day (quartz)	$\leq \pm 0.5$ s/day (quartz)
Stand-by power	0.8 W	0.8 W
Mechanical		
Frame size	45 mm	45 mm
Installation width	36 mm	36 mm
Mounting	DIN rail	DIN rail
Degree of protection	IP20	IP20
Protection class	II acc. to EN 60 730-1	II according to EN 60 730-1
Ambient temperature	-30 °C ... +55 °C	-30 °C ... +55 °C
Certification mark	V	V

Dimensions (mm)

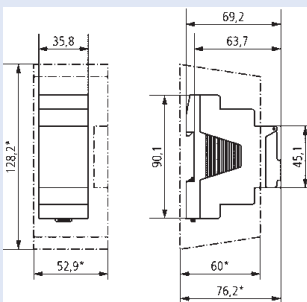

Controlling & Switching

Digital Time Switch with a Weekly Program TSDW1CODG

- Spring terminals
- Text-based operator guidance on the display
- 84 memory cells
- Interface for memory card (PC programming)
- 10 years power backup (lithium battery)
- Zero-cross switching for a relay-saving way of switching and for high lamp loads
- ON/OFF switching times
- Pulse program
- Cyclical program
- Pre-selected switching
- Permanent ON/OFF switching
- Expiry timer
- Integrated counter for operating hours
- Vacation program
- 2 random programs
- Display background lighting (can be switched off)
- PIN coding
- Automatic spring forward/fall back at daylight-saving start and end dates
- Time synchronization is possible by connecting an external aerial, e. g. a TSADCF or TSAGPSKIT aerial set
- 1 Channel
- External input

Connection example

TSDW1CODG

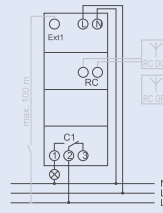

Technical Data

TSDW1CODG

Electrical

Operating voltage	230–240 V AC
Frequency	50–60 Hz
Power backup	10 years
Switching capacity at 250 V AC, $\cos \varphi = 1$	16 A
Switching capacity at 250 V AC, $\cos \varphi = 0.6$	10 A
Incandescent/halogen lamp load	2600 W
Min. switching capacity	approx. 10 mA
Shortest switching time	1 s
Accuracy	$\leq \pm 0.5$ s/day (quartz) or DCF77/GPS
Stand-by power	1.4 W

Mechanical

Frame size	45 mm
Installation width	36 mm
Mounting	DIN rail
Degree of protection	IP20
Protection class	II according to EN 60 730-1
Ambient temperature	-30 °C ... +55 °C
Certification mark	V

Dimensions (mm)

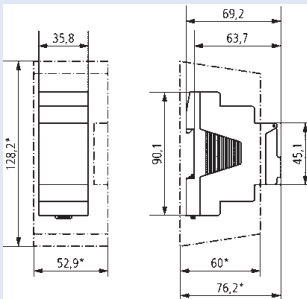

Controlling & Switching

Digital Time Switch with a Weekly Program TSDW1COMIN

- 1 Channel
- Screw-type terminals
- Text-based operator guidance on the display
- 28 memory cells
- 3 years power backup (exchangeable lithium battery)
- ON-OFF switching times
- Pre-selected switching
- Permanent ON/OFF switching
- PIN coding
- Automatic spring forward/fall back at daylight-saving start and end dates

Connection example

TSDW1COMIN

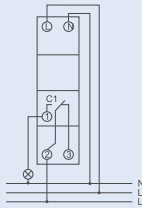

Technical Data

TSDW1COMIN

Electrical

Operating voltage	230 V AC
Frequency	50–60 Hz
Power backup	3 years
Switching capacity at 250 V AC, $\cos \varphi = 1$	16 A
Switching capacity at 250 V AC, $\cos \varphi = 0.6$	6 A
Incandescent/halogen lamp load	1000 W
Shortest switching time	1 min
Accuracy	$\leq \pm 1$ s/day (quartz)
Stand-by power	0.4 W

Mechanical

Frame size	45 mm
Installation width	17.5 mm
Mounting	DIN rail
Degree of protection	IP20
Protection class	II according to EN 60 730-1
Ambient temperature	-10 °C ... +55 °C
Certification mark	V

Dimensions (mm)

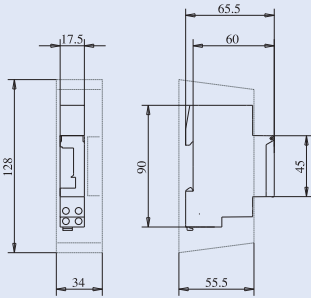

Controlling & Switching

Astro Time Switch with a Weekly Program TSDW1COA

- Astronomical switching function (automatic calculation of sunrise and sunset times for the entire year)
- Spring terminals
- Text-based operator guidance on the display
- Interface for memory card (PC programming)
- 10 years power backup (lithium battery)
- Zero-cross switching for a relay-saving way of switching and for high lamp loads
- Calculated astronomical switching times
- Programmable ON/OFF switching times
- Pre-selected switching
- Permanent ON/OFF switching
- Integrated counter for operating hours
- Vacation program
- Display background lighting (can be switched off)
- PIN coding
- Automatic spring forward/fall back at daylight-saving start and end dates
- 1 Channel
- 54 Memory cells

Connection example

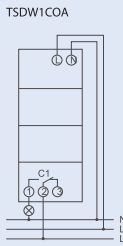

Technical Data

TSDW1COA

Electrical

Operating voltage	230–240 V AC
Frequency	50–60 Hz
Power backup	10 years
Switching capacity at 250 V AC, $\cos \varphi = 1$	16 A
Switching capacity at 250 V AC, $\cos \varphi = 0.6$	10 A
Incandescent/halogen lamp load	2600 W
Min. switching capacity	approx. 10 mA
Shortest switching time	1 min
Accuracy	$\leq \pm 0.5$ s/day (quartz)
Stand-by power	0.8 W

Mechanical

Frame size	45 mm
Installation width	36 mm
Mounting	DIN rail
Degree of protection	IP20
Protection class	II according to EN 60 730-1
Ambient temperature	-30 °C ... +55 °C
Certification mark	V

Dimensions (mm)

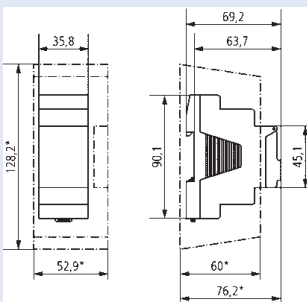

Controlling & Switching

Astronomical, digital Timer SA-TD/1W

- Design according to DIN EN 60730
- Digital timer in CMOS-technology
- Microprocessor and quartz control
- Programming by means of multi-function keys
- LCD display
- Programme data saved in case of power failure
- Optionally in each programme impulse time (switching interval 1-99 s) or fixed switching time (shortest switching interval 1 min) are possible
- Direct manual switching of relay ON/OFF
- Manual switching of relay to permanent operation ON/OFF (holiday operation)
- Automatic change to summer/winter time
- Automatic leap year adjustment
- Terminal covers which can be sealed with leads available as accessories

Block Diagram

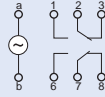

Technical Data

SA-TD/1W

General

Design according to	EN 60730-1, EN 60730-2-7
Rated voltage	230-240 V AC +10%/-15%
Rated frequency	50-60 Hz
Power consumption	max. 6 VA
Drive	Quartz
Accuracy at 20°C	1 s/day
Power reserve at 20°C	10 years
Type of battery	Li
Operating cycles	> 40,000
Degree of protection	IP20
Ambient temperature	-30°C...+55°C
Storage temperature	-30°C...+55°C
Protection class (acc. to EN 60 730-1) upon installation	II

Switching contacts

Type of switching contact	1 x change-over contact
Contact material	AgSnO ₂
Switching capacity at 250 V~, cosφ=1	16 A
Switching capacity at 250 V~, cosφ=0.6	10 A

Programme features

Switching period	Week
Number of channels	1
Min. switching time	1 min.
Max. programme steps in the memory	732

Size & Weight

Module units	2
Width	35 mm
Height	65.5 mm
Length	90 mm
Weight	170 g

Terminals

Terminal capacity - fine stranded wire	1.....2.5 mm ²
Terminal capacity - solid wire	1.....4 mm ²
Size of terminal screw	M3.5
Type of screw head	PZ size 1
Max. torque	0.8 Nm

Dimensions (mm)

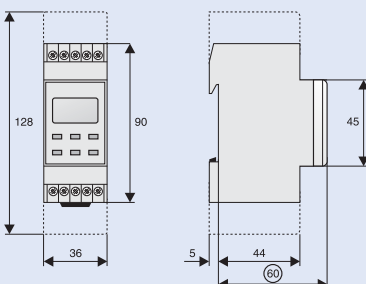

Controlling & Switching

Digital Timers Z-SDM

- Design according to DIN EN 60730
- Digital timers in CMOS-technology
- Microprocessor and quartz control
- Programming by means of multi-function keys
- LCD display
- Program data saved in case of power failure
- Optionally in each program impulse time (switching interval 1-99 s) or fixed switching time (shortest switching interval 1 min) are possible
- Direct manual switching of relay ON/OFF
- Manual switching of relay to permanent operation ON/OFF (holiday operation)
- Automatic change to summer/winter time
- Automatic leap year adjustment
- Terminal covers which can be sealed with leads available as accessories

Block Diagram

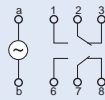

Technical Data

	Z-SDM/1K-TA	Z-SDM/1K-WO	Z-SDM/2K-WO
Electrical			
Rated voltage	230 V AC	230 V AC	230 V AC
Rated frequency	50/60 Hz	50/60 Hz	50/60 Hz
Current consumption	29mA, $\cos \varphi = 0,13$	29mA, $\cos \varphi = 0,13$	29mA, $\cos \varphi = 0,13$
Apparent power	6.6 VA	6.6 VA	6.6 VA
Reactive power	-6.5 VAR	-6.5 VAR	-6.5 VAR
Power loss	0.9 W	0.9 W	0.9 W
Switching contact (potential-free)	1 CO	1 CO	2 CO
Switching capacity			
Rated insulation voltage	250 V	250 V	250 V
Rated current	16 A μ	16 A μ	16 A μ
Resistive load	3000W, $\cos \varphi = 1$	3000W, $\cos \varphi = 1$	3000W, $\cos \varphi = 1$
Incandescent lamp load	1000W, $\cos \varphi = 1$	1000W, $\cos \varphi = 1$	1000W, $\cos \varphi = 1$
Inductive load	2A/250VAC $\cos \varphi = 0.6$	2A/250VAC $\cos \varphi = 0.6$	2A/250VAC $\cos \varphi = 0.6$
Power reserve	250 h	250 h	250 h
Power reserve storage	NiMH storage battery	NiMH storage battery	NiMH storage battery
Data saved by	EEPROM	EEPROM	EEPROM
Accuracy at 20°C	approx. 1 s per day	approx. 1 s per day	approx. 1 s per day
Switching accuracy	accurate to the second	accurate to the second	accurate to the second
Quartz frequency	32.768 MHz	32.768 MHz	32.768 MHz
Switching pairs freely programmable	20/day	20/week	20/week
Switching interval	1 min. or 1 s	1 min. or 1 s	1 min. or 1 s
Mechanical			
Frame size	45 mm	45 mm	45 mm
Device height	90 mm	90 mm	90 mm
Device width	36 mm	36 mm	36 mm
Weight	170 g	170 g	200 g
Mounting	quick fastening on DIN rail IEC/EN 60715		
Degree of protection, built-in	IP40	IP40	IP40
Upper and lower terminals	lift terminals	lift terminals	lift terminals
Terminal capacity			
one-wire	1.5-4 mm ²	1.5-4 mm ²	1.5-4 mm ²
fine wire	1-2.5 mm ²	1-2.5 mm ²	1-2.5 mm ²
Tightening torque of terminal screws	0.8 Nm	0.8 Nm	0.8 Nm
Permitted relative humidity	< 95%	< 95%	< 95%
Perm. ambient temperature range	0 to +55°C	0 to +55°C	0 to +55°C
Flame class acc. to EN 60730	D	D	D

Dimensions (mm)

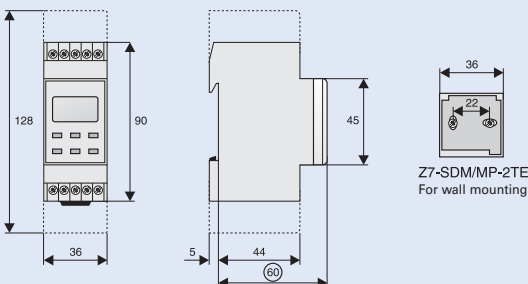

Controlling & Switching

Analog Time Switches TSQD1NO, TSSD1NO

- 1 MU
- 1 Channel
- Screw-type terminals
- Manual switch with 3 positions: Permanent ON/AUTO/Permanent OFF
- Switching status indication
- For type TSQD1NO: with power backup (exchangeable NiMH cell)
 - quartz-controlled
- For type TSSD1NO: Daily program
 - Without power backup
 - 96 switching segments
 - Mains-synchronized
 - Shortest switching time: 15 minutes

Connection example

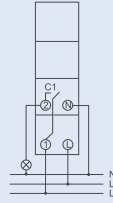

Technical Data

	TSQD1NO	TSSD1NO
Electrical		
Operating voltage	230–240 V AC	230 V AC
Frequency	50–60 Hz	50 Hz
Program	Daily program	Daily program
Power backup	3 days	–
Switching capacity at 250 V AC, $\cos \varphi = 1$	16 A	16 A
Switching capacity at 250 V AC, $\cos \varphi = 0.6$	4 A	4 A
Shortest switching time	15 min	15 min
Programmable	Every 15 min	Every 15 min
Accuracy	$\leq \pm 1$ s/day (quartz)	Mains-synchronized
Stand-by power	0.5 W	0.9 W
Mechanical		
Frame size	45 mm	45 mm
Installation width	17.5 mm	17.5 mm
Mounting	DIN rail	DIN rail
Degree of protection	IP20	IP20
Protection class	II acc. to EN 60 730-1	II according to EN 60 730-1
Ambient temperature	-10 °C ... +55 °C	-25 °C ... +50 °C
Certification mark	V	V

Dimensions (mm)

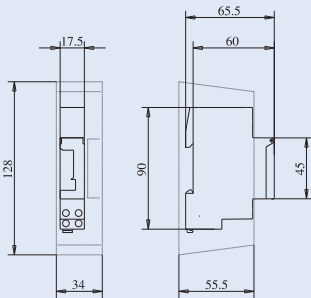

Controlling & Switching

Analog Time Switches TSQD1CO, TSSD1CO, TSQW1CO

- 3 MUs
- 1 Channel
- Spring terminals
- Pre-selected switching
- Manual switch with 3 positions: Permanent ON/AUTO/Permanent OFF
- Switching position indication
- Type TSQD1CO:
 - With power backup (NiMH cell)
 - Quartz-controlled
 - Clock-hands for time indication and 12h/24h recognition
 - Easy correction of spring forward/fall back at daylight-saving start and end
- Type TSQW1CO:
 - Weekly program
 - 84 Switching segments
 - Shortest switching time: 2 hours
- Type TSSD1CO:
 - Daily program
 - Without power backup
 - 96 Switching segments
 - Shortest switching time: 15 minutes
 - Clock-hands for time indication and 12h/24h recognition
 - Easy correction of spring forward/fall back at daylight-saving start and end

Connection example

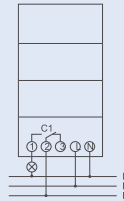

Technical Data

	TSQD1CO	TSSD1CO	TSQW1CO
Electrical			
Operating voltage	110–230 V AC	110–230 V AC	110–230 V AC
Frequency	50–60 Hz	50 Hz	50–60 Hz
Program	Daily program	Daily program	Weekly program
Power backup	200 hours, approx. 100 hours with 110 V	–	200 hours, approx. 100 hours with 110 V
Switching capacity at 250 V AC, $\cos \varphi = 1$	16 A	16 A	16 A
Switching capacity at 250 V AC, $\cos \varphi = 0.6$	4 A	4 A	4 A
Shortest switching time	15 min	15 min	2 h
Programmable	Every 15 min	Every 15 min	Every 2 h
Accuracy	$\leq \pm 1$ s/day (quartz)	Mains-synchronized	$\leq \pm 1$ s/day (quartz)
Stand-by power	0.5 W	0.9 W	0.5 W
Mechanical			
Frame size	45 mm	45 mm	
Installation width	52.5 mm	52.5 mm	52.5 mm
Mounting	DIN rail	DIN rail	DIN rail
Degree of protection	IP20	IP20	IP20
Protection class	II acc. to EN 60 730-1	II acc. to EN 60 730-1	II according to EN 60 730-1
Ambient temperature	-20 °C ... +55 °C	-20 °C ... +55 °C	-20 °C ... +55 °C
Certification mark	V	V	V

Dimensions (mm)

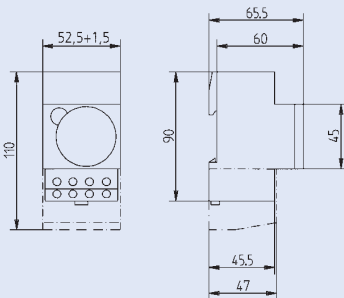

Controlling & Switching

Analogue Timers SU-T

- Design according to EN 60730-1, EN 60730-2-7
- Programming by means of switching slides

Block Diagram

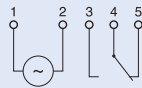

Technical Data

	SU-TS/TA	SU-TS/1W-TA	SU-TS/WO	SU-TQ/TA	SU-TQ/1W-TA, -WO	SU-TQ/2W-TW
General						
Design according to	EN 60730-1, EN 60730-2-7					
Rated voltage	230 V AC \pm 10 %	230 V AC \pm 10 %	230 V AC \pm 10 %	230 V AC \pm 10 %	230 V AC \pm 10 %	230 V AC \pm 10 %
Rated frequency	50 Hz	50 Hz	45-60 Hz	45-60 Hz	45-60 Hz	45-60 Hz
Power consumption	max. 2.5 VA	max. 2.5 VA	max. 2.5 VA	max. 2.5 VA	max. 2.5 VA	max. 2.5 VA
Drive	Mains	Mains	Mains	Quartz	Quartz	Quartz
Accuracy at 20°C	acc. to mains	acc. to mains	acc. to mains	$\leq \pm 1$ s/day	$\leq \pm 1$ s/day	$\leq \pm 1$ s/day
Power reserve at 20°C	-	-	-	>3 days	>3 days	>3 days
Type of battery	-	-	-	NiMH	NiMH	NiMH
Operating cycles	>10,000	>10,000	>10,000	>10,000	>10,000	>10,000
Degree of protection	IP20	IP20	IP20	IP20	IP20	IP20
Ambient temperature	-25 °C...+50 °C	-20 °C...+50 °C	-10 °C...+50 °C	-10 °C...+50 °C	-20 °C...+50 °C	-20 °C...+50 °C
Storage temperature	-25 °C...+50 °C	-20 °C...+50 °C	-10 °C...+50 °C	-10 °C...+50 °C	-20 °C...+50 °C	-20 °C...+50 °C
Protection class (acc. to EN 60 730-1) upon installation	II	II	II	II	II	II
Switching contacts						
Type of switching cont.	1 x NO	1 x CO	1 x NO	1 x NO	1 x CO	2 x CO
Contact material	Solid silver	Solid silver	Solid silver	Solid silver	Solid silver	Solid silver
Switching capacity at 250 V~, $\cos\phi=1$	16 A	16 A	16 A	16 A	16 A	16 A
Switching capacity at 250 V~, $\cos\phi=0.6$	4 A	4 A	4 A	4 A	4 A	4 A
Programme features						
Switching period	Day	Day	Week	Day	Day, Week	Week
Number of channels	1	1	1	1	1	2
Shortest switching interval	15 min.	15 min.	30 min.	2 hours	15 min.	30 min., 4 hours
Max. programme steps in the memory	96	48	84	96	48	32/day
Size & Weight						
Module units	1	3	1	1	3	3
Width	17.5 mm	52.5 mm	17.5 mm	17.5 mm	52.5 mm	52.5 mm
Height	65.5 mm	65.5 mm	65.5 mm	65.5 mm	65.5 mm	66.5 mm
Length	90 mm	90 mm	90 mm	90 mm	90 mm	90 mm
Weight	80 g	164 g	90 g	80 g	170 g, 172 g	175 g
Terminals						
Terminal capacity - fine stranded wire	1.....2.5 mm ²	1.....2.5 mm ²	1.....2.5 mm ²	1.....2.5 mm ²	1.....2.5 mm ²	1.....2.5 mm ²
Terminal capacity - solid wire	1.....4 mm ²	1.....4 mm ²	1.....4 mm ²	1.....4 mm ²	1.....4 mm ²	1.....4 mm ²
Size of terminal screws	M3.5	M3.5	M3.5	M3.5	M3.5	M3.5
Type of screw head	PZ size 1	PZ size 1	PZ size 1	PZ size 1	PZ size 1	PZ size 1
Max. torque	2 Nm	2 Nm	2 Nm	2 Nm	2 Nm	2 Nm

Dimensions (mm)

SU-TS/TA, SU-TS/WO, SU-TQ/TA

SU-TS/1W-TA, SU-TQ/1W-TA, SU-TQ/1W-WO, SU-TQ/2W-TW

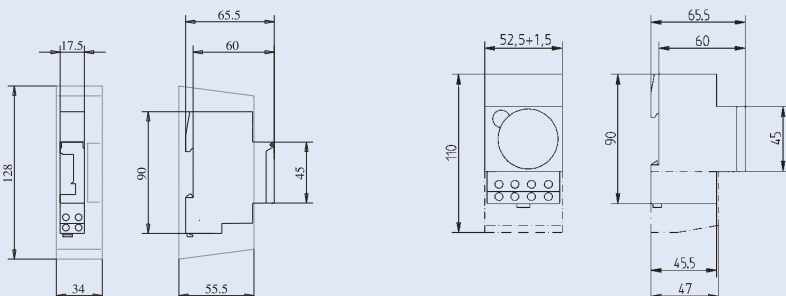

Controlling & Switching

Analog Twilight Switches, for DIN Rail, SRSD1NO, SRSD1COW

- Analog twilight switch
- External surface-mounted light sensor is incl. in the scope of delivery
- Indication of the channel and switching status
- Brightness level can be continuously adjusted
- Type SRSD1NO: fixed switch-on and switch-off delay
- Type SRSD1COW: Variable switch-on and switch-off delay
 - Spring terminals
 - Expanded brightness range and variable delay time
 - Five adjustable brightness ranges for easy setting of the lux value
 - Zero-cross switching
 - Permanent OFF and permanent ON function can be set at the potentiometer
 - Test function

Switching diagrams

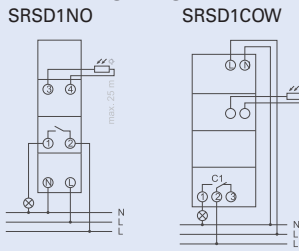

Technical Data

	SRSD1NO	SRSD1COW
Electrical		
Operating voltage	220–240 V AC	220–240 V AC
Frequency	50–60 Hz	50–60 Hz
Setting range for brightness	2–100 lx	2–2000 lx
Switch-on delay	20 s	60 s
Switch-off delay	80 s	60 s
Contact type	Make-contact	Change-over contact
Switch output	Potential-free	Potential-free, not suitable for SELV
Switching capacity at 250 V AC, $\cos \varphi = 1$	16 A	16 A
Switching capacity with fluorescent lamp load	10 AX	16AX
Min. switching capacity	–	<10 mA
Incandescent lamp load	2300 W	3600 W
Fluorescent lamp load (VVG - low-loss ballast)	2300 VA	3600 VA
non-compensated/series-compensated/ duo switching		
Energy saving lamps	9 x 7 W, 7 x 11 W, 7 x 15 W, 7 x 20 W, 7 x 23 W	34 x 7 W, 27 x 11 W, 24 x 15 W, 22 x 23 W
Stand-by power	0.8 W	1.3 W
Mechanical		
Frame size	45 mm	45 mm
Installation width	17.5 mm	54 mm
Mounting	DIN rail	DIN rail
Protection class	II	II
Ambient temperature	–25 °C ... +50 °C	–30 °C ... +55 °C
Certification mark	V	V
Max. line length to the sensor	25 m	100 m

Dimensions (mm)

SRSD1NO

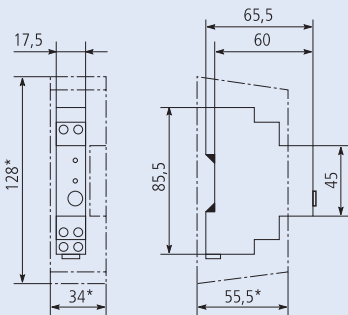

SRSD1COW

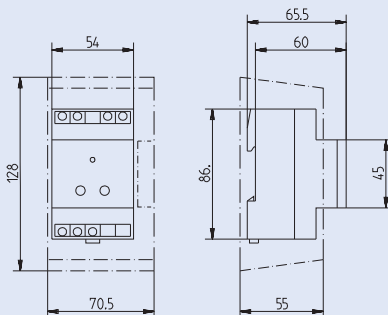

Controlling & Switching

Surface-Mounted Twilight Switch SRSW1NO

- Twilight switch with an integrated light sensor
- Cable entry is possible at the rear or from the bottom
- Large terminal area
- Setting the brightness value is possible from outside, without the need to open the device
- Wide angle of light incidence (approx. 180°)
- Test button
- Switch-on and switch-off delay can be adjusted
- Brightness level can be continuously adjusted
- Expanded brightness range

Switching diagram

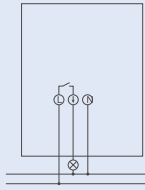

Technical Data

SRSW1NO

Electrical

Operating voltage	220–230 V AC
Frequency	50–60 Hz
Setting range for brightness	2–2000 lx
Switch-on delay	2–100 s
Contact type	Make-contact
Switch output	Not potential-free (230 V)
Switching capacity at 230 V AC, $\cos \varphi = 1$	16 A
Switching capacity at 230 V AC, $\cos \varphi = 0.3$	10 AX
Incandescent lamp load	2300 W
Fluorescent lamp load (VVG - low-loss ballast)	2300 VA
non-compensated/series-compensated/ duo switching	
Energy saving lamps	9 x 7 W, 7 x 11 W, 7 x 15 W, 7 x 20 W, 7 x 23 W
Stand-by power	0.6 W

Mechanical

Height	118.4 mm
Width	85 mm
Depth	49.4 mm
Degree of protection	IP55
Protection class	II
Ambient temperature	-35 °C ... +55 °C

Dimensions (mm)

SRSW1NO

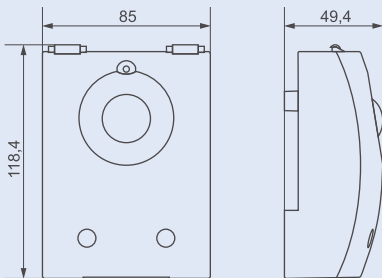

Controlling & Switching

Twilight Switch with Timer, for DIN Rail, SRCD1CO

- Twilight switch with an integrated weekly timer
- Adjustable switch-on and switch-off delay
- Brightness levels and switching-delay can separately be set for switch-on and switch-off
- Fixed times for ON and OFF (e.g. interruption during the night)
- DuoFix spring terminals
- Zero-cross switching to protect the relay contact and the lamp so as to increase their service life
- Interface for the OBELISK top2 memory card (PC programming)
- Light sensor included in the scope of delivery
- Permanent ON/OFF switching
- Test function
- Pre-selected switching
- Display background lighting
- PIN coding
- Counter for operating hours
- Display of the channel and switching status
- Vacation and holiday program with annual function for fixed date and variable date holidays (e.g. the ones that depend on Easter)
- Different rules can be selected for daylight-saving start and end or they can be freely selected
- For type SRCD1CO:
 - Analog twilight switch
 - 1 Channel
 - Analog setting of brightness levels

Switching diagram

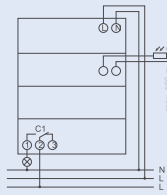

Technical Data

SRCD1CO

Electrical

Operating voltage	220–240 V AC
Frequency	50–60 Hz
Setting range for brightness	2–2000 lx
Switch-on delay	0–59 min
Contact type	Change-over contact
Switch output	Potential-free, not suitable for SELV
Switching capacity at 250 V AC, $\cos \varphi = 1$	16 A
Switching capacity at 250 V AC, $\cos \varphi = 0.6$	10 A
Switching capacity with fluorescent lamp load	10 AX
Min. switching capacity	approx. 10 mA
Incandescent lamp load	2600 W
Fluorescent lamp load (VVG - low-loss ballast)	2300 VA
	non-compensated/series-compensated/ duo-switching
Energy saving lamp	22 x 7 W, 18 x 11 W, 16 x 15 W, 16 x 20 W, 14 x 23 W
Stand-by power	1.3 W

Mechanical

Frame size	45 mm
Installation width	52.5 mm
Mounting	DIN rail
Protection class	II
Ambient temperature	-30 °C ... +55 °C
Max. line length to the sensor	100 m

Dimensions (mm)

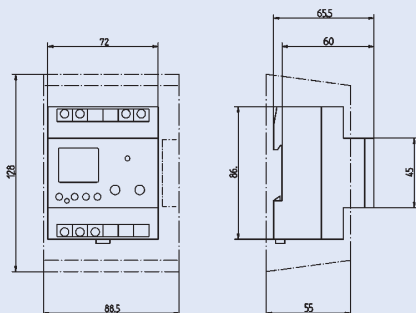

Controlling & Switching

Light Intensity Switch for support rail assembly DS-TA, DS-TD

- Device for automatic control of lighting systems
- For outdoor installation
- Wall mounting IP55
- With integrated light sensor
- Brightness range infinitely adjustable
- **Type DS-TA:** can be combined with timers for time and light-dependent control
- **Type DS-TA:** with integrated timer
- With make and break-time delay
- Suitable for street lighting, yard or general outdoor lighting

Connection diagram

DS-TA/WA

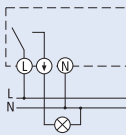

DS-TA/VWA

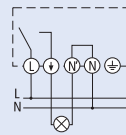

DS-TD/WA

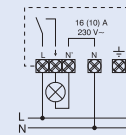

Technical Data

	DS-TA/WA	DS-TA/VWA	DS-TD/WA
General			
Design according to	EN 60669-1, EN 60669-2-1		
Rated voltage	230 V AC / 220 V~	230 V AC / 220 V~	230 V AC / 220 V~
Rated operating voltage tolerance	-10%....+10%	-10%....+10%	-10%....+10%
Rated frequency	50/60 Hz	50/60 Hz	50/60 Hz
Power consumption	3.5 VA	4.5 VA	2 VA
Brightness range	5 - 200 Lux	2 - 2000 Lux	2 - 200 Lux, digital
Max. cable length for sensor	-	-	-
Drive	-	-	Quartz
Accuracy at 20°C	-	-	-
Power reserve at 20°C	-	-	1.5 years
Type of battery	-	-	Lithium, replaceable
Operating cycles	40,000	40,000	40,000
Degree of protection	IP55	IP55	IP55
Ambient temperature	-35°C...+55°C	-35°C...+55°C	-35°C...+55°C
Ambient temperature - sensor	-	-	-
Storage temperature	-40 °C...+70 °C	-40 °C...+70 °C	-40 °C...+70 °C
Storage temperature - sensor	-40 °C...+70 °C	-40 °C...+70 °C	-40 °C...+70 °C
Protection class - device	II	II	II
Protection class - sensor	-	-	-
Switching contacts			
Type of switching contact	1 x NO	1 x NO	1 x NO
Contact material	Ag Sn O ₂	Ag Sn O ₂	Ag Sn O ₂
Switching capacity at 250V~cosφ=1	10 A	16 A	16 A
Switching capacity at 250 V~, cosφ=0.6	6 A	10 A	10 A
Switching capacity with lamps			
Incandescent lamps	1000 W	2300 W	2300 W
Halogen lamps	1000 W	2300 W	2300 W
Fluorescent lamps			
Non-compensated	1000 VA	2300 VA	2300 VA
Compensated in parallel	120 VA (18μF)	400 VA (42μF)	400 VA
Lead-lag circuit - compensated in series	1000 VA	2300 VA	2300 VA
Ballast - compensated	4 x 7W, 3 x 11W, 3 x 15W, 2 x 20W, 3 x 23W	9 x 7W, 7 x 11W, 7 x 15W, 7 x 20W, 7 x 23W	9 x 7W, 7 x 11W, 7 x 15W, 7 x 20W, 7 x 23W
Make-time delay	40 s	2-100 s	0-10 min, digital
Break-time delay	40 s	2-100 s	0-10 min, digital
Switching status indication	Yes	Yes	Yes
Non-delayed switching status indication	LED	LED	LED
Programme features			
Number of channels	1	1	1
Minimum switching time	-	-	1 min.
Max. programme steps in the memory	-	-	-
Programming via EEPROM or software	-	-	No
Automatic change of clock to summer/winter time	-	-	Yes
Random switching	-	-	No
Holiday programme	-	-	No
Impulse switching	-	-	No
Cycle-based programme	-	-	No
LCD background light	-	-	No

Controlling & Switching

	DS-TA/WA	DS-TA/VWA	DS-TD/WA
Size & weight			
Module units	-	-	-
Width	85 mm	85 mm	85 mm
Height	49.4 mm	49.4 mm	49.4 mm
Length	118.4 mm	118.4 mm	118.4 mm
Weight	202 g	247 g	320 g
Terminals			
Terminal capacity - fine stranded wire	1.....2.5 mm ²	1.....2.5 mm ²	1.....2.5 mm ²
Terminal capacity - solid wire	1.....4 mm ²	1.....4 mm ²	1.....4 mm ²
Size of terminal screws	M3	M3	M3
Type of screw head	Slotted, size 1	Slotted, size 1	Slotted, size 1
Max. torque	0.5 Nm	0.5 Nm	0.5 Nm

Dimensions (mm)

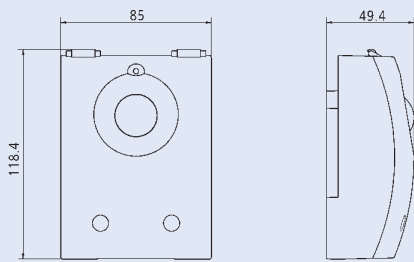

Controlling & Switching

Light Intensity Switch for wall mounting DS-TA, DS-TD

- Device for automatic control of lighting systems
- With external light sensor
- Brightness range infinitely adjustable
- **Type DS-TA:** can be combined with timers for time and light-dependent control
- **Type DS-TD:** with integrated timer for time and light-dependent control
- With make and break-time delay
- Supplied with light sensor IP65
- Spare sensors available

Connection diagrams

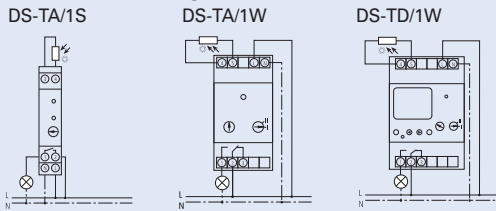

Technical Data

	DS-TA/1S	DS-TA/1W	DS-TD/1W
General			
Design according to	EN 60669-1, EN 60669-2-1		
Rated voltage	220-240 V AC	230 V AC	230 V AC
Rated operating voltage tolerance	-15%...+10%	-10%...+10%	-10%...+10%
Rated frequency	50-60 Hz	45-60 Hz	45-60 Hz
Power consumption	approx. 6 VA	approx. 5 VA	approx. 5 VA
Brightness range	2 - 100 Lux	2 - 2000 Lux	2 - 2000 Lux
Max. cable length for sensor	100 m	100 m	100 m
Drive	-	-	Quartz
Operating cycles	40,000	40,000	40,000
Degree of protection - control device	IP20	IP20	IP20
Degree of protection - sensor	IP54/IP65	IP54/IP65	IP54/IP65
Ambient temperature	-25 °C...+50 °C	-10 °C...+50 °C	-10 °C...+50 °C
Ambient temperature - sensor	-40 °C...+70 °C	-40 °C...+70 °C	-40 °C...+70 °C
Storage temperature	-25 °C...+50 °C	-25 °C...+50 °C	-25 °C...+50 °C
Storage temperature - sensor	-40 °C...+70 °C	-40 °C...+70 °C	-40 °C...+70 °C
Protection class - device	II	II	II
Protection class - sensor	II	III	III
Switching contacts			
Type of switching contact	1 x NO	1 x CO	1 x CO
Contact material	Ag Sn O ₂	Ag Sn O ₂	Ag Sn O ₂
Switching capacity at 250V~cosφ=1	16 A	10 A	10 A
Switching capacity at 250 V~, cosφ=0.6	10 A	6 A	6 A
Switching capacity with lamps			
Incandescent lamps	2300 W	2300 W	2300 W
Halogen lamps	2300 W	2300 W	2300 W
Fluorescent lamps			
Non-compensated	2300 VA	2300 VA	2300 VA
Compensated in parallel	400 VA (42 µF)	400 VA (42 µF)	400 VA (42 µF)
Lead-lag circuit - compensated in series	2300 VA	2300 VA	2300 VA
Ballast - compensated	4 x 7W, 3 x 11W, 3 x 15W, 2 x 20W, 3 x 23W	9 x 7W, 7 x 11W, 7 x 15W, 7 x 20W, 7 x 23W	9 x 7W, 7 x 11W, 7 x 15W, 7 x 20W, 7 x 23W
Make-time delay	20 s	40 s	80 s
Break-time delay	80 s	40 s	80 s
Switching status indication	Yes	Yes	Yes
Non-delayed switching status indication	LED	LED	LED
Programme features			
Number of channels	1	1	1
Minimum switching time	-	-	1 min.
Max. programme steps in the memory	-	-	42
Programming via EEPROM or software	-	-	No
Automatic change of clock to summer/winter time	-	-	Yes
Random switching	-	-	-
Holiday programme	-	-	Yes
Size & weight			
Module units	1	3	4
Width	17.5 mm	52,5 mm	72 mm
Height	65.5 mm	65.5 mm	65.5 mm
Length	90 mm	90 mm	90 mm
Weight	172 g	330 g	330 g

Controlling & Switching

	DS-TA/1S	DS-TA/1W	DS-TD/1W
Terminals			
Terminal capacity - fine stranded wire	1.....2.5 mm ²	1.....2.5 mm ²	1.....2.5 mm ²
Terminal capacity - solid wire	1.....4 mm ²	1.....4 mm ²	1.....4 mm ²
Size of terminal screws	M3.5	M3.5	M3.5
Type of screw head	PZ size 1	PZ size 1	PZ size 1
Max. torque	0.8 Nm	0.8 Nm	0.8 Nm

Dimensions (mm)

DS-TA/1S

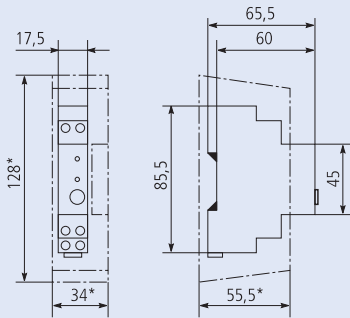

DS-TA/1W

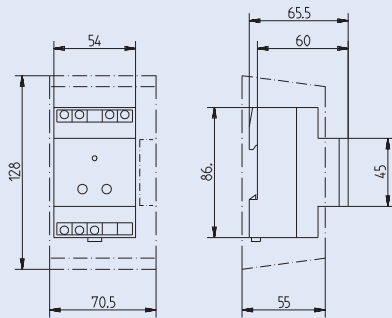

DS-TD/1W

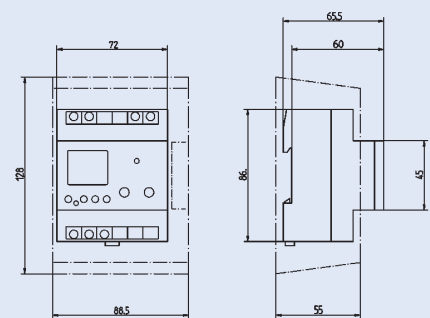

Controlling & Switching

Light Sensor Z-DS/S

Technical Data

	Z-DS/S-E	Z-DS/S-A
General		
Use	built-in	external
Design according to	EN 60669-1, EN 60669-2-1	
Max. cable length for sensor	100 m	100 m
Connection cable	1.5 m	-
Degree of protection	IP65	IP54
Ambient temperature - sensor	-40 °C...+70 °C	-40 °C...+70 °C
Storage temperature	-40 °C...+70 °C	-40 °C...+70 °C
Protection class	III	III
Size & Weight		
Module units	-	-
Width	20 mm	28 mm
Height	PG 9 (diameter of thread)	28 mm
Length	40.5 mm	85 mm
Weight	52 g	55 g
Terminals		
Terminal capacity - fine stranded wire	1.....1.5 mm ²	1.....1.5 mm ²
Terminal capacity - solid wire	1.....1.5 mm ²	1.....1.5 mm ²
Size of terminal screws	M2.5	M2.5
Type of screw heads	PZ size 1	PZ size 1
Max. torque	0.8 Nm	0.8 Nm

Dimensions (mm)

Z-DS/S-E

IP 65
- 40°C ... + 70°C

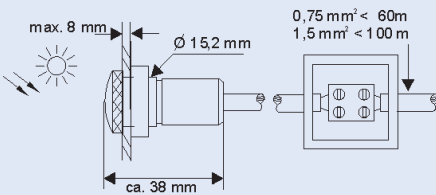

Z-DS/S-A

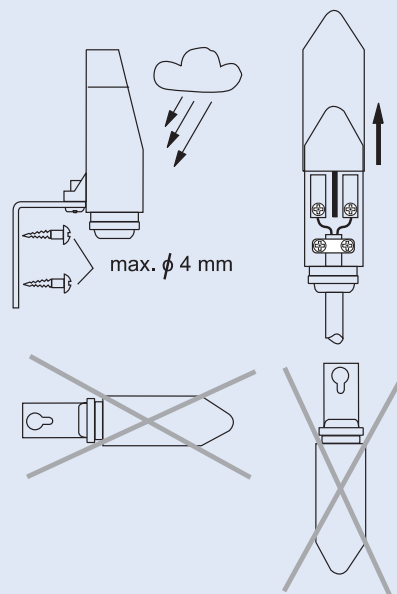

Controlling & Switching

Light Intensity Switch Z-LMS, Light Sensor Z7-LMS/SENSOR

- Device for automatic control of lighting systems
- With external light sensor
- Brightness range infinitely adjustable
- Can be combined with timers for time- and light-dependent control
- With make and break-time delay
- Supplied with light sensor IP54
- Spare sensors available (Z7-LMS/SENSOR)

Connection diagram

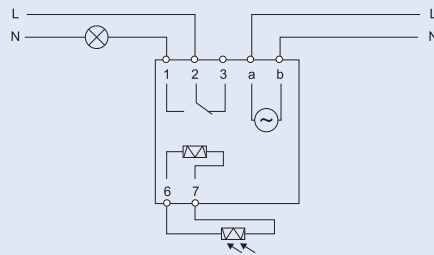

Technical Data

Electrical

Rated voltage	230 V AC +6% -10%
Rated frequency	50-60 Hz
Current consumption	9.5 mA
Power consumption	2.2 VA
Switching contact	1 CO (potential-free)
Rated insulation voltage	250 V
Rated current	16 A μ
Switching capacity	
Resistive load	3500W, $\cos \varphi = 1$
Incandescent lamp load	2300W, $\cos \varphi = 1$
Inductive load	3A / 250 V, $\cos \varphi = 0.8$
Make delay	8 s
Break time delay	38 s
Switch status	
Relay on	red LED
Switching point	green LED
Setting range	2-100 2-1000 2-10.000 Lux
Duty	100%

Mechanical

Frame size	45 mm
Device height	90 mm
Device width	36 mm
Weight	285 g
Mounting	quick fastening on DIN rail IEC/EN 60715
Degree of protection, built-in	IP40
Upper and lower terminals	lift terminals
Terminal capacity	0.5-2.5 mm ²
Tightening torque of terminal screws	0.5 Nm
Line length to the light sensor	max. 100m at 2 x 0.5 mm ²
Perm. ambient temperature range	0 to +55°C

Dimensions (mm)

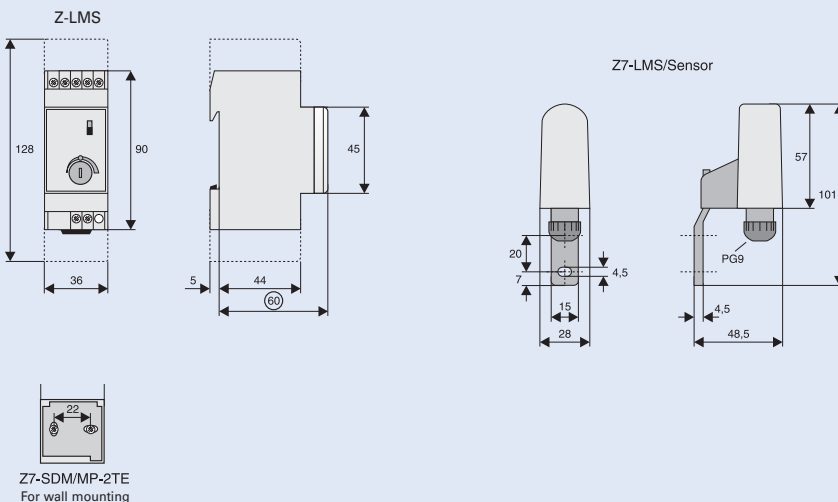

Controlling & Switching

xSystem EASY Control Relay

Technical data

		EASY512-..	EASY7..	EASY8..
General information				
Standards and regulations		EN 55011, EN 55022, EN 6100-4, IEC 60068-2-6, IEC 60068-2-27		
Dimensions (W x H x D)	mm	71.5 x 90 x 58 (4U)	107.5 x 90 x 72 (6U)	107.5 x 90 x 72 (6U)
Weight	kg	0.2	0.3	0.3
Mounting		DIN rail IEC/EN 60715, 35 mm or screw-mounting with device stands ZB4-101-GF1 (accessory)		
Terminal capacity				
Siolid	mm ²	0.2/4 (AWG 22-12)	0.2/4 (AWG 22-12)	0.2/4 (AWG 22-12)
Flexible with ferrule	mm ²	0.2/2.5 (AWG 22-12)	0.2/2.5 (AWG 22-12)	0.2/2.5 (AWG 22-12)
Slotted screwdriver	mm	3.5 x 0.8	3.5 x 0.8	3.5 x 0.8
Max. tightening torque	Nm	0.6	0.6	0.6
Climatic environmental conditions				
Ambient temperature of operation	°C	-25 to +55, cold acc. to IEC 60068-2-1, heat acc. to IEC 60068-2-2		
Exposure to dew		to be avoided through appropriate measures		
LCD-display (clear reading)	°C	0 to +55	0 to +55	0 to +55
Storage	°C	-40 to +70	-40 to +70	-40 to +70
Relative humidity, no exposure to dew (IEC/EN 60068-2-30)	%	5 - 95	5 - 95	5 - 95
Atmospheric pressure (operation)	hPa	795 - 1080	795 - 1080	795 - 1080
Corrosion resistance				
IEC/EN 60068-2-42 - 4 days SO ₂	cm ³ /m ³	10	10	10
IEC/EN 60068-2-43 - 4 days H ₂ S	cm ³ /m ³	1	1	1
Mechanical environmental conditions				
Pollution degree		2	2	2
Degree of protection (IEC/EN 60529)		IP20	IP20	IP20
Vibrations (IEC/EN 60068-2-6)				
Constant amplitude 0.15 mm	Hz	10 - 57	10 - 57	10 - 57
Constant acceleration 2 g	Hz	57 - 150	57 - 150	57 - 150
Shock resistance (IEC/EN 60068-2-27) half-sinusoidal 15g/11ms	shocks	18	18	18
Tipping over (IEC/EN 60068-2-31), height of fall	mm	50	50	50
Free fall, packaged (IEC/EN 60068-2-32)	m	1	1	1
Mounting position		horizontal/vertical	horizontal/vertical	horizontal /vertical

Dimensions (mm)

EASY512-..

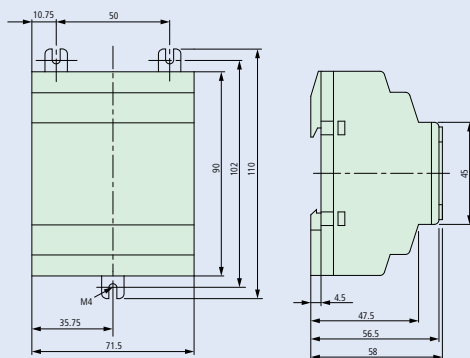

EASY7..

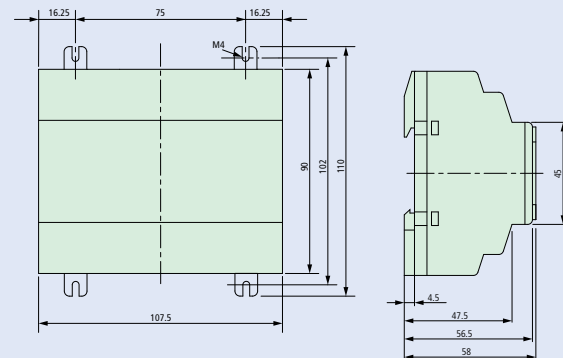

EASY8..

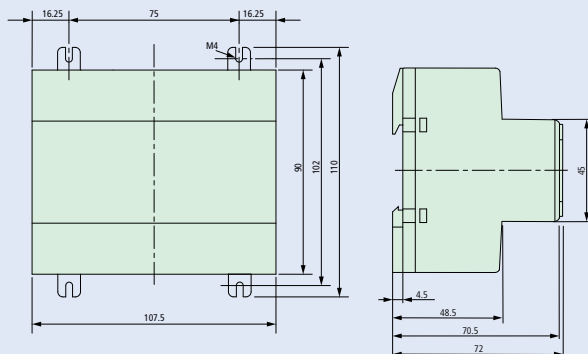

Controlling & Switching

xSystem Multifunction Display - MFD

Technical data

MFD-80..

General information

Standards and regulations		EN 61000-6-1/-2/-3/-4, IEC 60068-2-6, IEC 60068-2-27
Dimensions (W x H x D)	mm	86.5 x 86.5 x 21.5 (with keys) 86.5 x 86.5 x 20 (without keys)
Weight	kg	0.13
Mounting		2 x 22.5 mm, display fixed with 2 fastening rings

Climatic environmental conditions

Ambient temperature of operation	°C	-25 to +55, cold acc. to IEC 60068-2-1, heat acc. to IEC 60068-2-2
Exposure to dew		to be avoided through appropriate measures
LCD-display (clear reading)	°C	-5 to +50 -10 to 0 with background light switched on (permanent operation)
Storage	°C	-40 to +70
Relative humidity, no exposure to dew (IEC/EN 60068-2-30)	%	5 - 95
Atmospheric pressure (operation)	hPa	795 - 1080

Mechanical environmental conditions

Pollution degree		3
Degree of protection (IEC/EN 60529)		IP65
Vibrations (IEC/EN 60068-2-6)		
Constant amplitude 0.15 mm	Hz	10 - 57
Constant acceleration 2 g	Hz	57 - 150
Shock resistance (IEC/EN 60068-2-27) half-sinusoidal 15g/11ms	shocks	18
Tipping over (IEC/EN 60068-2-31), height of fall	mm	50
Free fall, packaged (IEC/EN 60068-2-32)	m	1
Mounting position		horizontal/vertical

Dimensions (mm)

MFD-80..

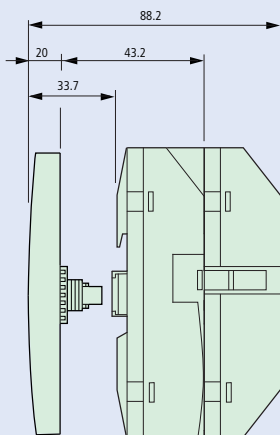
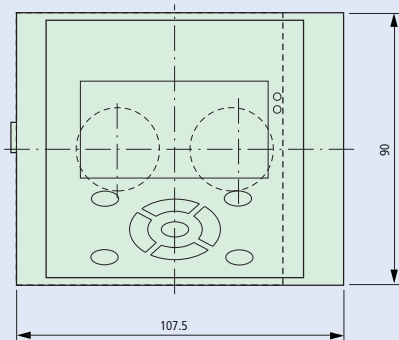

Controlling & Switching

Communication Center Z-CC/2CO

- Compact remote monitoring and controlling unit
- The Communication Center keeps you informed for example, when the RCD has tripped or when the room temperature in your weekend cottage is too low. Connect your alarm lines from fire detectors or security systems to the Communication Center directly. Switch pumps, heating systems or other devices with your mobile phone by SMS.
- The device can be fully configured via SMS (optionally it can be configured via the Web-Browser of a connected PC)
- Integrated quad-band GSM modem
- 4 Digital inputs
- 2 Relay outputs
- Activated inputs triggers sending of SMS messages and e-mails up to 3 phone numbers and one e-mail address
- Controlling outputs via SMS
- The current status can be checked by SMS anytime
- Compatible with SIM cards of all common mobile communication providers (no SIM lock)
- It is also possible to check the current credit available on prepaid phone cards
- Connection to customer's network is possible
- Permanent intern control of the modem - functions are shown on the front LEDs

Accessories:

Power supply unit	EASYPOW200	229424
Temperature sensor for serial interface	Z-CC/2CO-SE	119430
Cross-over patch cord CAT5e	DNW-PX/0200/RJ45/ RJ45/5E/CSUTP/GR/PV	237271

Technical Data

Electrical

Power supply	12-24 VDC (min. 10 VDC up to a max. of 30 VDC)
Power consumption	1.5 W up to a max. of 6 W
Temperature sensor	d = 15.8 mm, length 106mm, cable of 1.4 m length incl. 9-pole sub-D-plug for RS232 connector Measuring range -10°C to +50°C Accuracy: +/- 2°C
Outputs	2 potential-free relay outputs AC: 5 A at 250 VAC DC: 5 A up to 30 VDC, 0.3 A up to 110 VDC and 0.12 A up to 220 VDC Max. switching capacity AC15 at 230 VAC: 500 VA
Inputs	4; max. 12-24 VDC (2-4 mA), galvanically separated (optical coupler)
Ethernet interface	For parameterization via a PC (Web-Browser). Connection to the PC and Communication Center (Z-CC/2CO) by means of a cross-over network cable (DNW-PX/0200/RJ45/RJ45).
RS232 interface	9-pole sub-D-plug; for connecting an external temperature sensor
Green LED ON	Modem Status LED (LED flashes every 3 seconds during registration at the GSM-net)
Red LED ON	Modem Activity LED (LED flashes when a SMS is sended or received)

Mechanical

Frame size	45 mm
Device height	97 mm
Device width	105 mm
Mounting	Quick-fastening for DIN rail IEC/EN60715
Degree of protection, built-in	IP40

Dimensions (mm)

Communication Center Z-CC/2CO

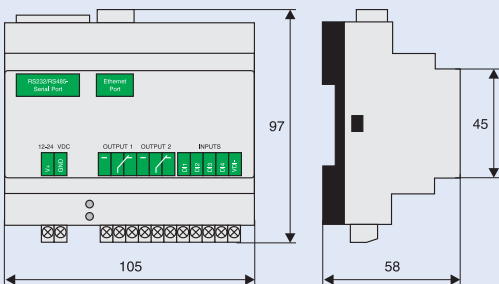

Temperature sensor Z-CC/2CO-SE

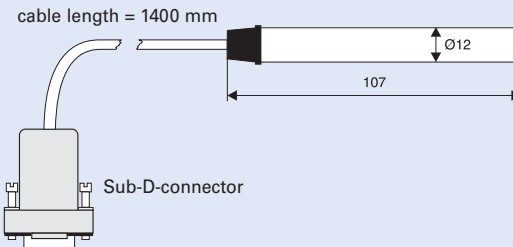

Controlling & Switching

Basic circuit

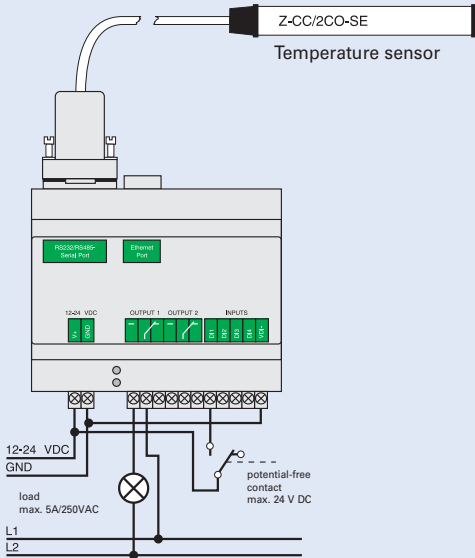

PC configuration

Message settings

Input 1 sends the following message: RCD has tripped!
 Input 2 sends the following message: Smoke detector alert!
 Input 3 sends the following message: Door contact alert!
 Input 4 sends the following message: Water detector alert!

The above-listed messages will be sent to the following phone numbers, for example (max. 3):
 +436501234567, +436761234567, +436641234567

The above-listed messages will be sent to the following e-mail address, for example:

john.smith@chello.at

Save

Application example

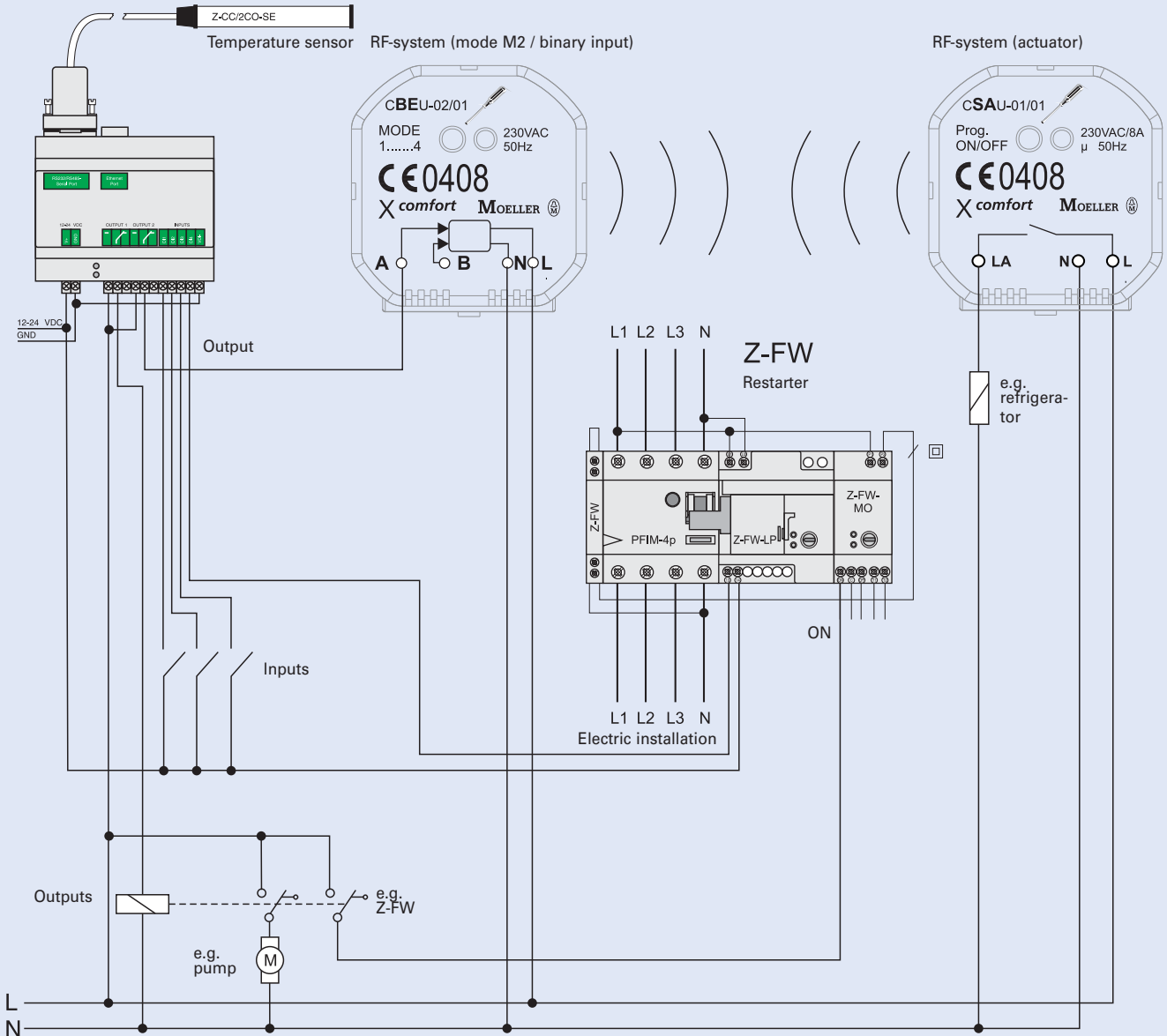

Controlling & Switching

Signalling Devices, Buzzer Z-SUM, Bell Z-GLO

Connection diagram

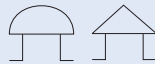

Technical Data

Electrical

Rated voltage	12, 24, 230 VAC ±10%
Frequency	50-60 Hz
Power loss	
12 V	5 VA
24 V, 230 V	10 VA
Duty	100% (5 min.)
Volume	
Bell Z-GLO	84 dB / 1 meter
Buzzer Z-SUM	80 dB / 1 meter

Mechanical

Frame size	45 mm
Device height	86 mm
Device width	17.5 mm (1MU)
Mounting	quick fastening on DIN rail IEC/EN 60715
Degree of protection	IP20
Upper and lower terminals	lift terminals
Terminal screws	captive screws
Terminal capacity	1-10 mm ²

Dimensions (mm)

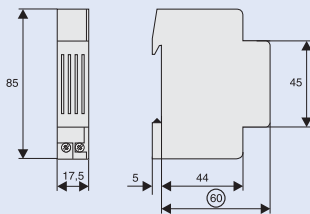

Controlling & Switching

Signal bell ASBELL, Buzzer ASBUZZ230

- Signal bells and buzzers are typically used in residential buildings and in functional buildings such as shops, offices, banks etc. They are either used to signalize alert conditions, or generally as audible sound signals.
- These devices are built-in devices installed in distribution cabinets. They are designed for short-time operation in compliance with the IEC 62080 standard.
- Space-saving design of one module unit only.
- Safe device protection thanks to PTC to avoid overloads and short-circuits.

Connection diagram

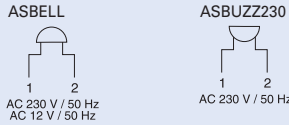

Technical Data

			ASBELL230 ASBUZZ230	ASBELL12
Standards			IEC 62080	IEC 62080
Rated operating voltage U_e	VAC	230	12	
Rated operating power P_s	VA	5,5	4	
Working range	at 50/60 Hz	$x U_c$	0,94 ... 1,06	0,94 ... 1,06
Rated frequency		Hz	50	50
Working range of frequency		Hz	45 ... 65	45 ... 65
Rated power loss P_v	In idle operation	W	0,83	0,83
Degree of pollution	acc. to EN 61010-1	-	2	2
Operating voltage	acc. to EN 61010-1	VAC	230	12
Insulating material group	acc. to EN 61010-1	-	II	II
Safe separation	Air gap	mm	≥ 3	$\geq 1,5$
	Creep distance within the device	mm	$\geq 2,5$	$\geq 1,5$
Test voltage	50 Hz, 1 min.	kv	1,25	1
Flammability		Class	V0	V0
Terminal capacity	rigid	mm ²	1 x 6 or 2 x 4	1 x 6 or 2 x 4
	flexible with wire end sleeve, min.	mm ²	0,75	0,75
Sound volume		dB	≥ 75	≥ 75
Allowed range of ambient temperature		°C	-10 ... +55	-10 ... +55
Degree of protection	acc. to DIN EN 60529	-	IP20, with conductors connected	IP20, with conductors connected
Protection class	acc. to DIN EN 61140 / VDE 0140		II	II

Dimensions (mm)

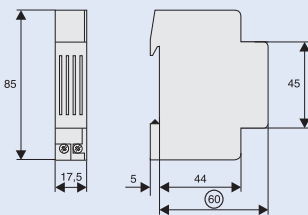

Controlling & Switching

Siren ASSIR24

Technical Data

	ASSIR24
Data in compliance with	EN 60669-1
Supply Voltage	24 VAC/DC
Voltage tolerance range	± 15%
Power dissipation	2.4 VA
AC Voltage test	2.5 kV
Sound level	105 dB
Operative Temperature	-10°C to +55°C
Storage Temperature	-25°C to +70°C
Degree of protection	IP20

Dimensions (mm)

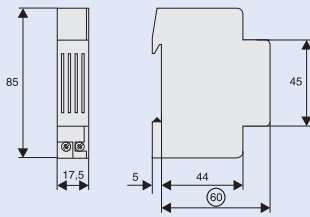

Controlling & Switching

Bell Transformers TR-G.

- Bell transformers with separate windings according to EN 61558
- Accessories: Surface Mounting Set (mounting plate, terminal covers)

Connection diagrams (e.g.)

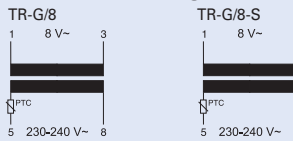

Technical Data

	TR-G/8	TR-G3/8	TR-G/8-S	TR-G3/18	TR-G2/24
Electrical					
Rated output	8 VA	8 VA	8 VA	18 VA	24 VA
Rated supply voltage range at terminals	230-240 V AC 5-8	230-240 V AC 5-8	230-240 V AC 5-8	230-240 V AC 5-8	230-240 V AC 5-8
Rated frequency	50 Hz	50 Hz	50 Hz	50 Hz	50 Hz
No-load current	25 mA	26 mA	25 mA	36 mA	24 mA
Rated supply current	69 mA	58 mA	69 mA	72/124/138 mA	155/160 mA
Primary resistance	616 Ω	667 Ω	616 Ω	229 Ω	616 Ω
Rated output voltage at terminals	8 VAC 1-3	4/8/12 VAC 2-3/1-2/1-3	8 VAC 1-3	4/8/12 VAC 2-3/1-2/1-3	12/24 VAC 1-2/1-3
No-load output voltage	13 V	4.9/12/16.8 V	13 V	5.9/12/17.8 V	16/31 V
Output voltage at rated output current	8.4 V 1 A	3.8/7.9/12.2 V 1-1-0.67 A	8.4 V 1 A	4.3/8.4/12.7 V 2-2-1.5 A	12.2/23.2 V 2-1 A
Secondary resistance	2 Ω	0.9/1.9/2.8 Ω	2 Ω	0.4/1/1.3 Ω	1/3 Ω
Power loss in no-load operation	1.4 W	1.4 W	1.4 W	1.8 W	1.9 W
Total power loss at nominal load	7.1 W	6.2 W	7.1 W	11.6 W	11.9 W
Short circuit proof	PTC	PTC	PTC	PTC	PTC
Test voltage (primary-secondary)	5 kV	5 kV	5 kV	5 kV	5 kV
Pollution degree	P2	P2	P2	P2	P2
Mechanical					
Frame size	45 mm	45 mm	45 mm	45 mm	45 mm
Device height	90 mm	90 mm	90 mm	90 mm	90 mm
Device width	36 mm	36 mm	36 mm	36 mm	54 mm
Weight	236 g	253 g	236 g	354 g	612 g
Mounting	quick fastening on DIN rail IEC/EN 60715				
Degree of protection, built-in	IP20	IP20	IP20	IP20	IP20
Upper and lower terminals	lift terminals	lift terminals	lift terminals	lift terminals	lift terminals
Terminal capacity	1 - 3x2.5 mm ²	1 - 3x2.5 mm ²	1 - 3x2.5 mm ²	1 - 3x2.5 mm ²	1 - 3x2.5 mm ²
Tightning torque of terminal screws	0.5 Nm	0.5 Nm	0.5 Nm	0.5 Nm	0.5 Nm
Permitted relative humidity	<95%	<95%	<95%	<95%	<95%
Rated ambient temperature	40°C	40°C	40°C	40°C	35°C
Temperature rise at intermittent duty (20 x 1min. 100% and 5min. 20%)	24 K	24 K	24 K	26 K	31 K
Insulation class	E	E	E	E	E
Glow wire-test	850°C	850°C	850°C	850°C	850°C

Dimensions (mm)

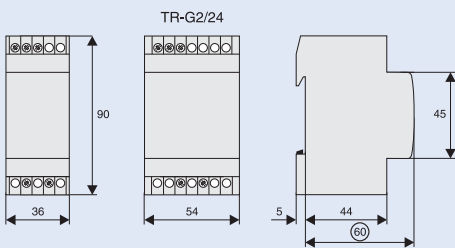

Practical Hint



Safety transformer
(Fail-safe = no danger in case of failure)



Bell transformer



Short circuit-proof transformer

According to EN 61558

Controlling & Switching

Safety Transformers TR-G./..-SF

- Safety transformers with separate windings according to EN 61558
- Accessories: Surface Mounting Set (mounting plate, terminal covers)

Connection diagrams (e.g.)

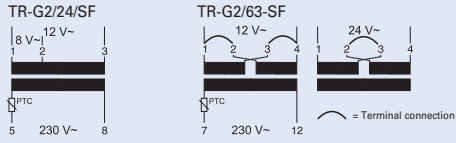

Technical Data

	TR-G2/24-SF	TR-G2/24-SF2	TR-G2/63-SF
Electrical			
Rated output	24 VA	24 VA	63 VA
Rated supply voltage range at terminals	230-240 V AC	230-240 V AC	230-240 V AC
Rated frequency	50 Hz	50 Hz	50 Hz
No-load current	22 mA	58 mA	60 mA
Rated supply current	100/150 mA	140/135 mA	340 mA
Primary resistance	133 Ω	92 Ω	41 Ω
Rated output voltage at terminals	8/12 VAC	12/24 VAC	12/24 VAC
No-load output voltage	9.9/15.6 V	13.3/26.8 V	13.6/27.3 V
Output voltage at rated output current	8.2/12.3 V	11.6/23.8 V	12/24.1 V
Secondary resistance	0.5/0.75 Ω	0.45/0.95 Ω	0.15/0.6 Ω
Power loss in no-load operation	1.8 W	4.3 W	4.1 W
Total power loss at nominal load	10.4 W	6.3 W	19.6 W
Duty	100%	100%	100%
Short circuit proof	inherently (PTC)	inherently (PTC)	inherently (PTC)
Test voltage (primary-secondary)	5 kV	5 kV	5 kV
Pollution degree	P2	P2	P2
Mechanical			
Frame size	45 mm	45 mm	45 mm
Device height	90 mm	90 mm	90 mm
Device width	54 mm	90 mm	90 mm
Weight	604 g	1087 g	1256 g
Mounting	quick fastening on DIN rail IEC/EN 60715		
Degree of protection, built-in	IP40	IP40	IP40
Upper and lower terminals	lift terminals	lift terminals	lift terminals
Terminal capacity	1 - 3x2,5 mm ²	1 - 3x2,5 mm ²	1 - 3x2,5 mm ²
Tightening torque of terminal screws	0,5 Nm	0,5 Nm	0,5 Nm
Permitted relative humidity	<95%	<95%	<95%
Rated ambient temperature	25°C	35°C	25°C
Temperature rise at uninterrupted duty	56 K	34 K	51 K
Insulation class	E	F	F
Glow wire-test	850°C	850°C	850°C

Dimensions (mm)

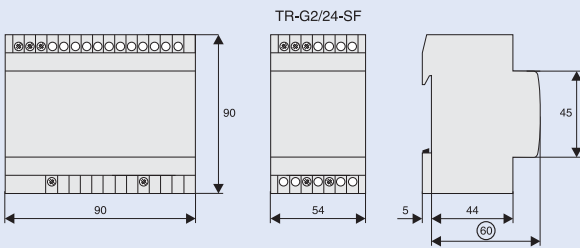

Practical Hint



Safety transformer
(Fail-safe = no danger in case of failure)



Bell transformer



Short circuit-proof transformer

According to EN 61558

Controlling & Switching

xCommand RMQ Titan® Command & Signalling Devices

Technical data

		Contact elements	LED-Elements ¹⁾	Luminous push-button Push-button
General information				
Standards and regulations		IEC/EN 60947, VDE 0660		
Mechanical lifespan	operations x 10 ⁶	> 5	–	>5
Operating frequency	operations/h	≤ 3600	–	≤ 3600
Operating force	N	≤ 5	–	≤ 5
Operating torque (screw terminals)	Nm	≤ 0.8	–	–
Degree of protection IEC/EN 60529		IP20	IP20	IP67, IP69K
Climatic resistance ²⁾		Humidity and heat, constant, according to IEC 60068-2-78		
		Humidity and heat, periodic, according to IEC 60068-2-30		
Ambient temperature ¹⁾ , open	°C	-25 to +70	-25 to +70	-25 to +70
Mounting position		any	any	any
Shock resistance according to IEC 60068-2-27, Shock duration 11 ms, half-sinusoidal		g	> 30	> 30
Terminal capacity				
Solid	mm ²	0.75 - 2.5	0.75 - 2.5	–
Stranded	mm ²	0.5 - 2.5	0.5 - 2.5	–
Current paths				
Rated peak withstand voltage U _{imp}		V AC	6000	6000
Rated insulation voltage U _i		V	500	500
Overvoltage category/Pollution degree		III/3	III/3	–
Circuit safety H _F				
at 24 V DC / 5 mA	failure rate	< 10 ⁻⁷ , < 1 failure to 10 ⁷ switching operations	–	–
at 5 V DC / 1 mA	failure rate	< 5 x 10 ⁻⁶ , < 1 failure to 5 x 10 ⁶ switching operations	–	–
Max. short-circuit protection				
Without fuse	Type	PKZM0-10/PLSM-B6	–	–
Fuse gG/gL	A	10		
Switching capacity				
Rated operating current I _e				
AC-15				
115 V	A	6	–	–
120 V	A	6	–	–
400 V	A	4	–	–
500 V	A	2	–	–
DC-13				
24 V	A	3	–	–
42 V	A	1.7	–	–
60 V	A	1.2	–	–
110 V	A	0.8	–	–
220 V	A	0.3	–	–
Electric lifespan				
AC-15				
230 V / 0.5 A	operations x 10 ⁶	1.6	–	–
230 V / 1 A	operations x 10 ⁶	1	–	–
230 V / 3 A	operations x 10 ⁶	0.7	–	–
DC-13				
12 V / 2.8 A	operations x 10 ⁶	1.2	–	–

¹⁾ > 200 V AC / 60 Hz: -25 to +55°C

²⁾ Indoor and protected outdoor position

Dimensions (mm)

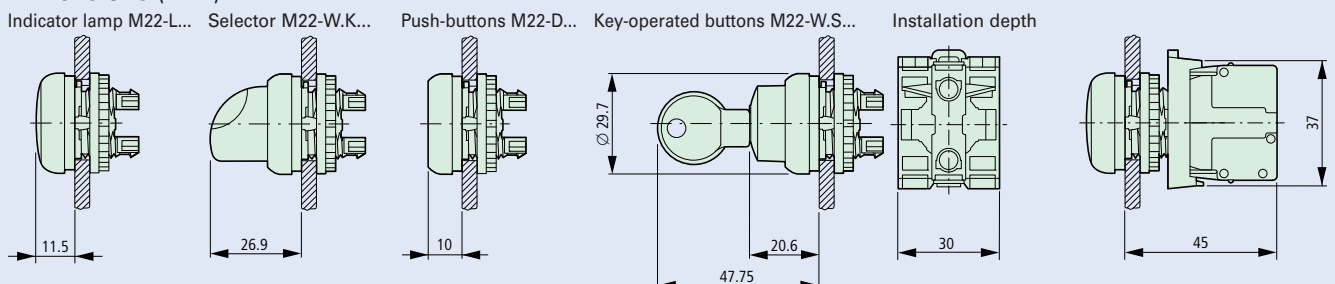

Controlling & Switching

xCommand LS-TITAN® Command & Signalling Devices

Technical data

Position switch LS-11

General information

Standards and regulations	IEC/EN 60947	
Climatic resistance	Humidity and heat, constant, according to IEC 60068-2-3 Humidity and heat, periodic, according to IEC 60068-2-30	
Ambient temperature	°C	-25 to +70
Mounting position	any	
Degree of protection	IP66	
Cage-Clamp ¹⁾ terminal capacity		
Solid	mm ²	1 x (0.5-2.5)
Flexible with ferrule according to DIN 46228	mm ²	1 x (0.5-1.5)

Current paths/Switching capacity

Rated peak withstand voltage U_{imp}	V AC	4000
Rated insulation voltage U_i	V	400
Overvoltage category/Pollution degree	III/3	
Rated operating current I_e		
AC-15		
24 V	A	6
230/240 V	A	6
400/415 V	A	4
DC-13		
24 V	A	10
110 V	A	1
220 V	A	0.5
Circuit safety H_F		
at 24 V DC / 5 mA	failure rate	$< 10^{-7}$, < 1 failure to 10^7 operations
at 5 V DC / 1 mA	failure rate	$< 5 \times 10^{-6}$, < 1 failure to 5×10^6 operations
Supply frequency	Hz	max. 400
Short-circuit resistance when closed (IEC/EN 60947-5-1)		
Without fuse	Type	PKZM0-10/PLSM-B6
Max. fuse gG/gL	A	10
Short-circuit resistance IEC/EN 60947-5-1		
Max. fuse gG/gL	A	6
Repetition accuracy	mm	± 0.02

Mechanical specifications

Lifespan		
Standard-action switch	operations x 10^6	8
Snap-action switch	operations x 10^6	8
Contact temperature of the actuating roller	°C	≤ 100
Shock resistance (half-sinusoidal shock 20 ms)		
Standard-action switch	g	25
Snap-action switch	g	2
Basic device	g	-
Operating frequency	operations/h	≤ 6000

¹⁾ Cage-Clamp is a registered trademark of Wago Kontakttechnik, D-32423 Minden

Dimensions (without actuation element) in mm

Position switch LS-11...

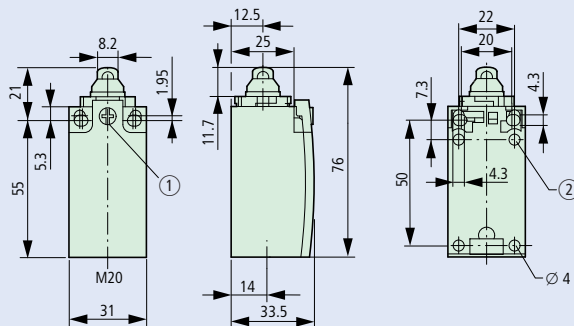

Controlling & Switching

xStart Contactors

Technical data

DILM, DILA, ZB

General information

Standards and regulations	IEC/EN 60947, VDE 0660, UL, CSA		
Mechanical lifespan			
AC-operated	operations x 10 ⁶	10	
DC-operated	operations x 10 ⁶	10	
Mechanical operating frequency			
AC-operated	operations/h	9000	
DC-operated	operations/h	9000	
Climatic resistance	Humidity and heat, constant, according to IEC 60068-2-78 Humidity and heat, periodical, according to IEC 60068-2-30		
Ambient temperature			
Open	°C	-25 to +60	
Hermetically enclosed	°C	-25 to +40	
Storage	°C	-40 to +80	
Mounting position	AC and DC-operated		

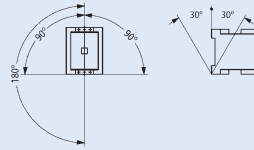

Shock resistance (IEC/EN 60068-2-27)

Half-sinusoidal shock 10 ms			
Main switching elements - make contact	g	10	
Auxiliary switching elements - make contact	g	7	
Auxiliary switching elements - break contact	g	5	

Degree of protection	IP20
Protection against accidental contact in case of vertical actuation from the front (VDE 0106 Section 100)	finger and hand touch safe

Main current paths

Rated peak withstand voltage U_{imp}	V AC	8000
Overvoltage category/Pollution degree		III/3
Rated insulation voltage U_i	V	690
Rated operating current U_e	V	690
Secure disconnection according to VDE 0106 Section 101 and Section 101/A1		
between coil and contacts	V AC	400
between the contacts	V AC	400
Making capacity $\cos \varphi$ according to IEC/EN 60947 up to 690 V	A	112

Dimensions (mm)

Contactors DILM7-DILM12

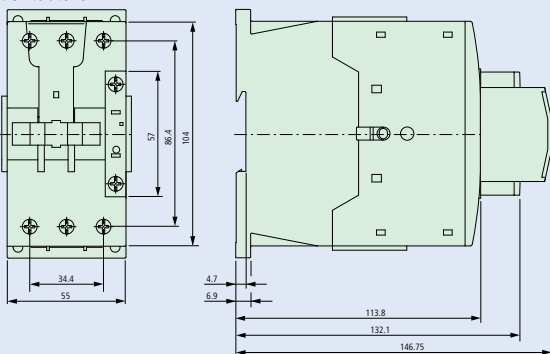

Contactors DILM17-DILM32

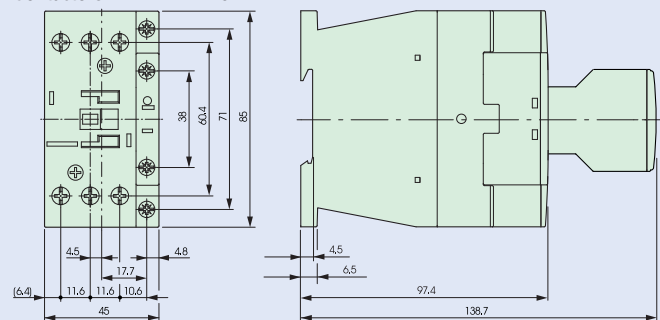

Contactors DILM40-DILM65

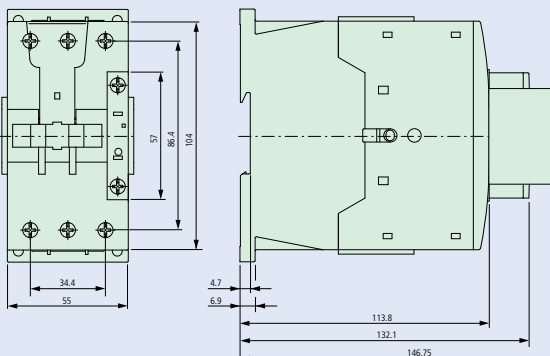

Motor-protective relay ZB12, ZB32

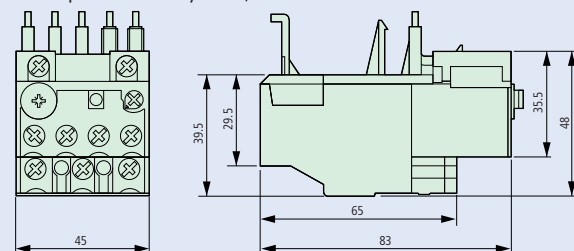

X-ON Electronics

Largest Supplier of Electrical and Electronic Components

Click to view similar products for [General Purpose Relays](#) category:

Click to view products by [Eaton](#) manufacturer:

Other Similar products are found below :

[PCN-105D3MH,000](#) [59641F200](#) [5JO-1000CD-SIL](#) [5X827E](#) [5X837F](#) [5X840F](#) [5X842F](#) [5X848E](#) [LY2N-AC120](#) [LY2-US-AC120](#) [M115C60](#)
[M115N010](#) [M115N0150](#) [603-12D](#) [60HE1-5DC](#) [60HE2S-12DC](#) [61211TOB4](#) [61212T400](#) [61222Q400](#) [61243B600](#) [61243C500](#) [61243Q400](#)
[61311BOA2](#) [61311BOA6](#) [61311BOA8](#) [61311C0A2](#) [61311COA1](#) [61311COA6](#) [61311F0A2](#) [61311QOA1](#) [61311QOA4](#) [61311T0D6](#)
[61311TOA6](#) [61311TOA7](#) [61311TOB3](#) [61311TOB4](#) [61311U0A6](#) [61312Q600](#) [61312T400](#) [61312T600](#) [61313U200](#) [61313U400](#) [61322T400](#)
[61332C400](#) [61343C200](#) [61343C600](#) [61343Q200](#) [61343T100](#) [61343T200](#) [61343T400](#)