

Product Data Sheet 6314/2MP

ebmpapst

Die Wahl der Ingenieure



6314/2MP

INDEX

1 General 3

2 Mechanics 3

 2.1 General 3

 2.2 Connections 3

3 Operating Data 4

 3.1 Operating Data - Electrical Interface - Input 4

 3.2 Electrical Operating Data 6

 3.3 Operating Data - Electrical Interface -Output 7

 3.4 Electrical Features 8

 3.5 Aerodynamic 9

 3.6 Sound Data 10

4 Environment 10

 4.1 General 10

 4.2 Climatic requirements*) 10

5 Safety 11

 5.1 Electrical Safety 11

 5.2 Approval Tests 11

6 Reliability 11

 6.1 General 11

1 General

Fan type	Fan	
Rotational direction looking at rotor	counterclockwise	
Airflow direction	Air outlet over struts	
Bearing system	Ball bearing	
Mounting position	any	

2 Mechanics

2.1 General

Depth	51,0 mm	
Diameter	172,0 mm	
Weight	0,800 kg	
Housing material	Metal	
Impeller material	Plastic	
Max. torque when mounted across both mounting flanges	wire outlet corner: 600 Ncm remaining corners: 600 Ncm	
Screw size	ISO 4762 - M4 degreased, without an additional brace and without washer	

2.2 Connections

Electrical connection	Wires	
Length of lead wire	L = 365 mm	
Tolerance	+ - 10,0 mm	
Length of tube	S = 10 mm	
Tolerance	+ - 2,0 mm	
Wire gauge (AWG)	22	
Insulation diameter	1,7 mm	
Contact	see drawing	

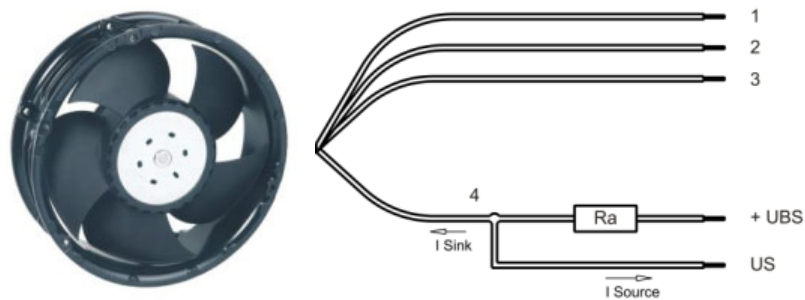

	Colour	Operation
Wire 1	red	+ UB
Wire 2	blue	- GND
Wire 3	violet	PWM
Wire 4	white	Tacho

The auxiliaries shown on the schematic diagram (which are required for the intended use) are not part of our delivery.

3 Operating Data

3.1 Operating Data - Electrical Interface - Input

Control input	PWM
---------------	-----

Features

Input type	Open collector	
PWM - Frequency		1 kHz - 20 kHz Typical: 2 kHz

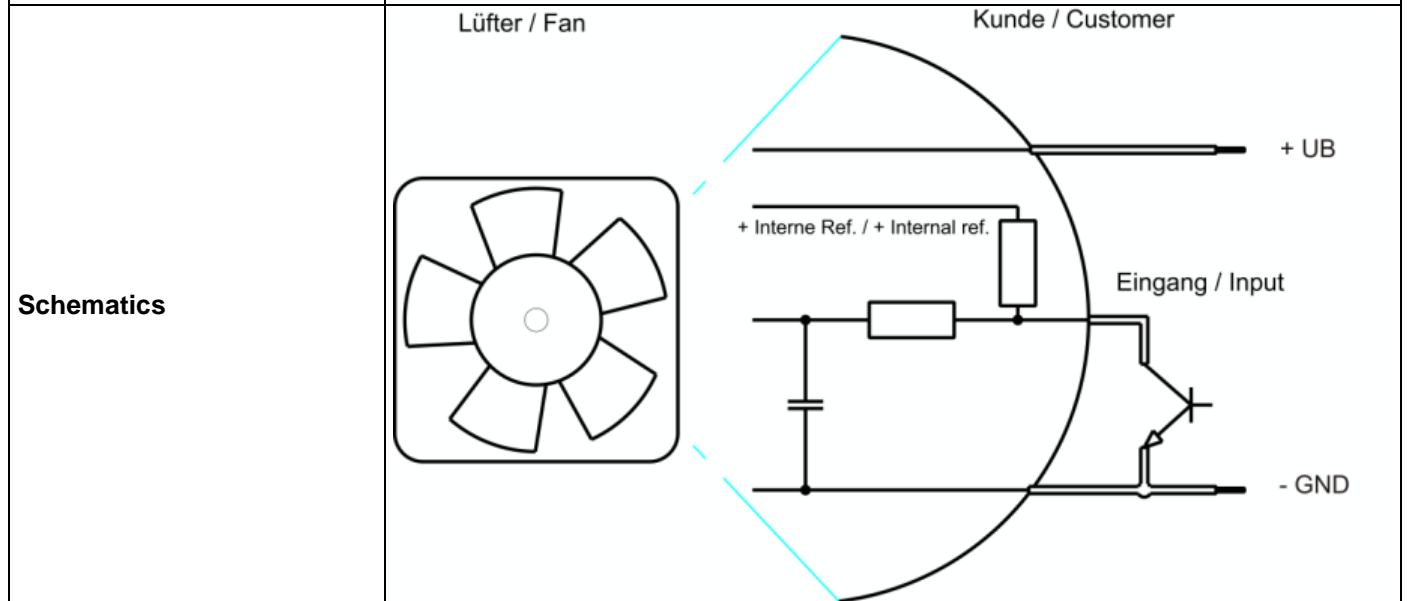
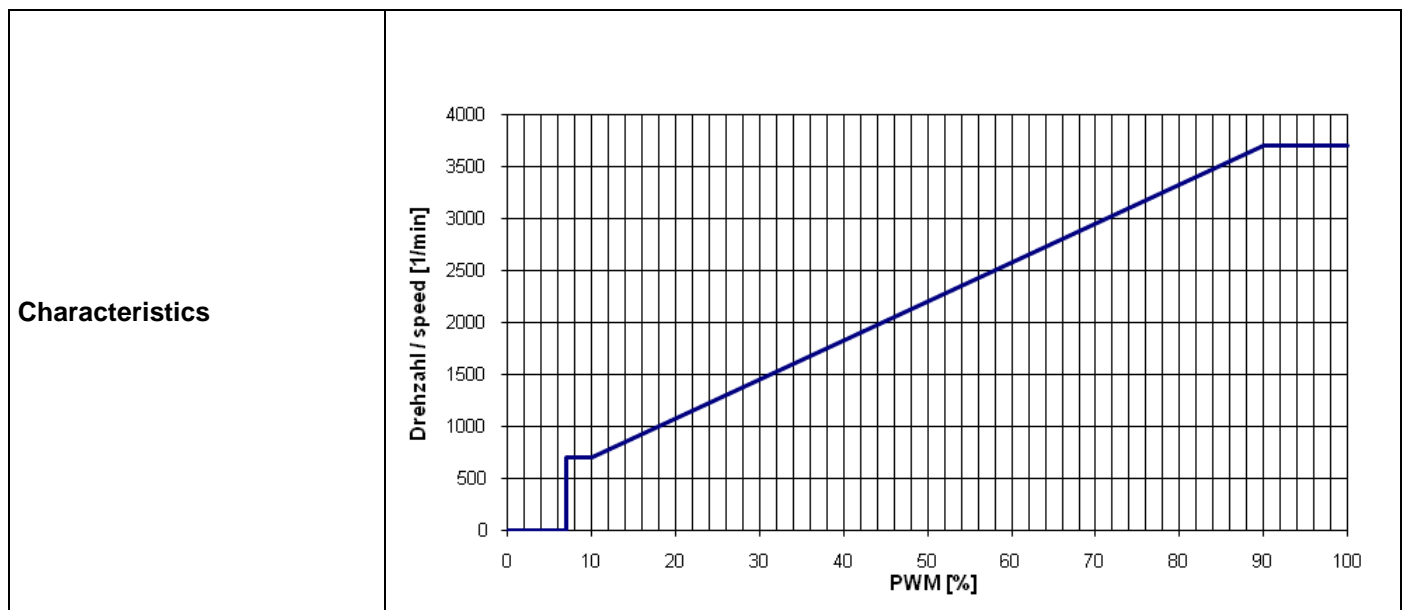

Transistor requirements:

Vce max. $\geq 12V$; Isink max. $\geq 5mA$

Vce sat. $\leq 0,15V$

Information to the curve:

0% - 7% PWM:	0 1/min
7% - 10% PWM:	700 1/min (corresponding to min. speed)
10% - 90% PWM:	linear increasing curve
90% - 100% PWM:	3.700 1/min (corresponding to max. speed)

3.2 Electrical Operating Data

Measurement conditions: Normal air density = 1,2 kg/m³; Temperature 23°C +/- 3°C; Motor axis horizontal; warm-up time before measuring 5 minutes (unless otherwise specified). In the intake and outlet area should not be any solid obstruction within 0,5 m.

$\Delta p = 0$: corresp. to free air flow (see section 3.5)
 I: corresp. to arithm. mean current value

Name	Condition
PWM 0001	PWM: 100 %; f: 2 kHz

Features	Condition	Symbol	Values		
Voltage range	$\Delta p = 0$	U	16,0 V		30,0 V
Nominal voltage	$\Delta p = 0$	U_N		24,0 V	
Power consumption Tolerance	$\Delta p = 0$ PWM 0001	P	6,1 W +/- 15,0 %	14,0 W +/- 20 %	15 W +/- 10,0 %
Current consumption Tolerance	$\Delta p = 0$ PWM 0001	I	390 mA +/- 15,0 %	570 mA +/- 17,5 %	510 mA +/- 10,0 %
Speed Tolerance	$\Delta p = 0$ PWM 0001	n	2.530 1/min +/- 10,0 %	3.700 1/min +/- 10 %	3.700 1/min +/- 5,0 %

Name	Condition
PWM 0002	PWM: 50 %; f: 2 kHz

Features	Condition	Symbol	Values		
Voltage range	$\Delta p = 0$	U	16,0 V		30,0 V
Nominal voltage	$\Delta p = 0$	U_N		24,0 V	
Power consumption Tolerance	$\Delta p = 0$ PWM 0002	P	4,4 W +/- 15 %	5,0 W +/- 12,5 %	5,2 W +/- 10,0 %
Current consumption Tolerance	$\Delta p = 0$ PWM 0002	I	290 mA +/- 15,0 %	210 mA +/- 12,5 %	176 mA +/- 10,0 %
Speed Tolerance	$\Delta p = 0$ PWM 0002	n	2.170 1/min +/- 7,5 %	2.170 1/min +/- 7,5 %	2.170 1/min +/- 7,5 %

3.3 Operating Data - Electrical Interface -Output

Tacho type	/2 (Open collector)
------------	---------------------

Signal-Ausgangsspannung / Signal output voltage

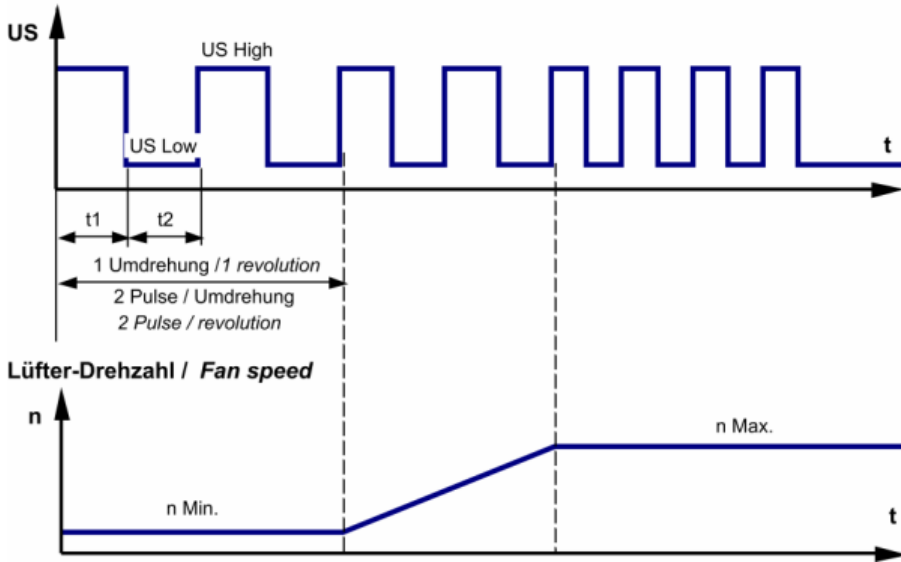

$$R_a = \frac{U_{BS} - US_{Low}}{I_{Sink}}$$

Features	Note	Values
Tacho operating voltage (UBS)		<= 32,0 V
Tacho signal Low	I sink: 2 mA	<= 0,4 V
Tacho signal High	I source: 0 mA	<= 32,0 V
Maximum sink current		<= 20 mA
External resistor	External resistor Ra from UBS to US required. All voltages measured to GND.	
Tacho frequency	(2 x n) / 60	
Tacho isolated from motor	No	
Slew rate		=> 0,5 V/us

Alarm type	None
------------	------

3.4 Electrical Features

Electronic function	Speed-Controlled	
Reversed polarity protection	Rectifying diode	
Max. residual current at Un	IF ≤ 5 mA	
Locked rotor protection	Auto restart	
Locked rotor current at Un	approx. 650 mA	
Clock signal t3/t4 at locked rotor	Typical: 0,5 s / 5,0 s	

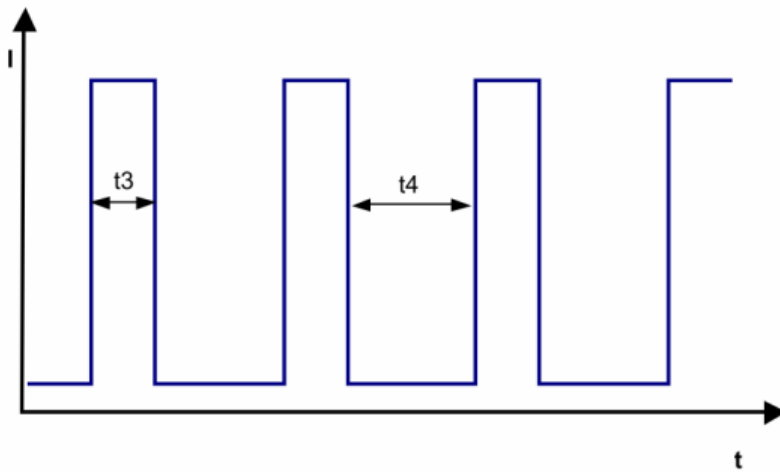

Internal Fuse:

Littlefuse NANO2(R) FUSE; Very fast acting 451 Series; 4 A

Note:

The internal electrolytic capacitor 470uF/35V has no resistor or inrush current limitation, essentially the power supply and the type and length of the connecting cable is limiting the Inrush current.

3.5 Aerodynamic

Measurement conditions: Measured with a double chamber intake rig acc. to DIN EN ISO 5801.
 Normal air density = 1,2 kg/m³; Temperature 23°C +/- 3°C;
 In the intake and outlet area should not be any solid obstruction within 0,5 m.
 The information is only valid under the specified test conditions and may be changed by the installation conditions. If there are deviations from the standard test conditions, the characteristic values must be checked under the installed conditions.

a.) Operation condition:

3.700 1/min at free air flow	PWM 100 %; f: 2 kHz		
------------------------------	---------------------	--	--

Max. free-air flow ($\Delta p = 0 / \dot{V} = \text{max.}$)	395,0 m ³ /h	
Max. static pressure ($\Delta p = \text{max.} / \dot{V} = 0$)	220 Pa	

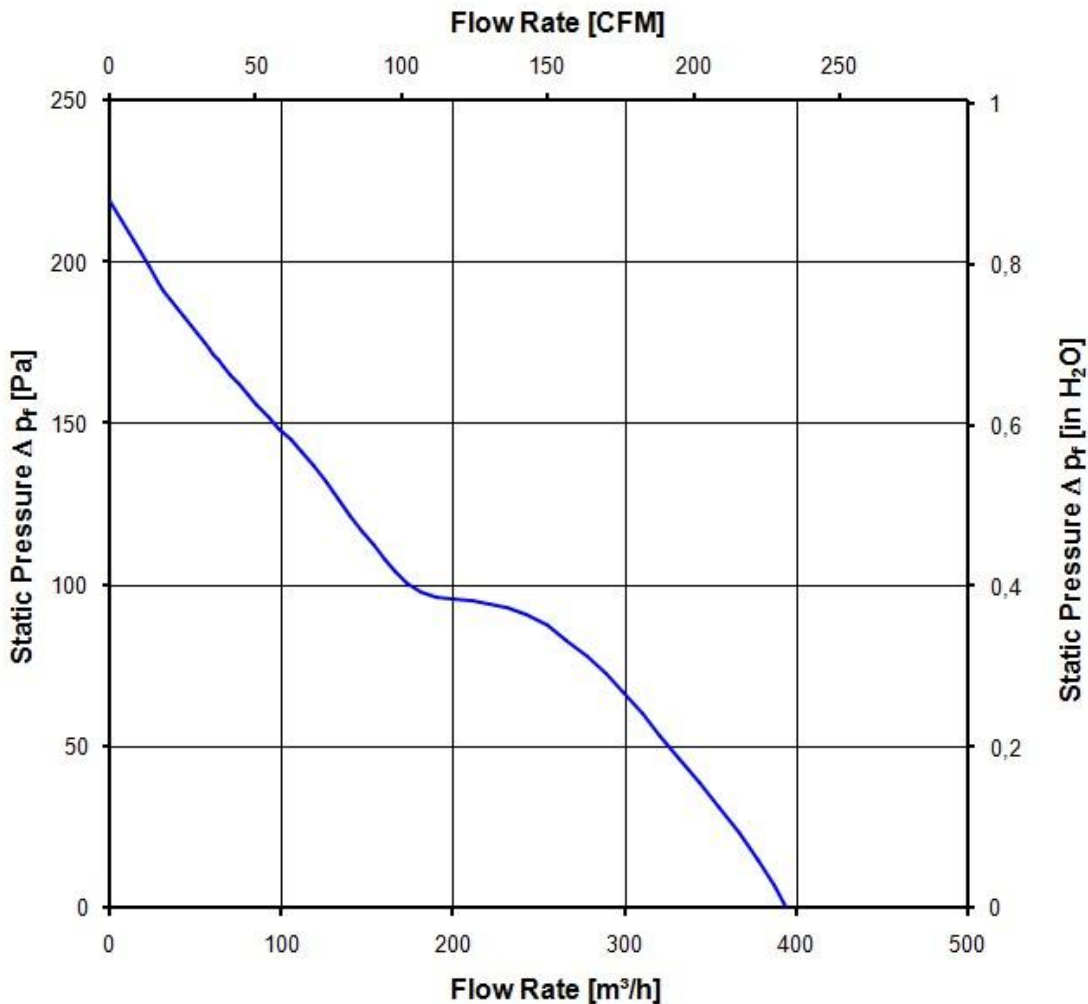

3.6 Sound Data

Measurement conditions: Sound pressure level: 1 Meter distance between microphone and the air intake.
 Sound power level: Acc. to DIN 45635 part 38 (ISO 10302)
 Measured in a semianchoic chamber with a background noise level of $L_p(A) < 5 \text{ dB}(A)$
 For further measurement conditions see section 3.5

a.) Operation condition:

3.700 1/min at free air flow	PWM 100 %; f: 2 kHz	PWM min.:	PWM max.:
------------------------------	---------------------	-----------	-----------

Optimal operating point	290,0 m3/h @ 66 Pa	
Sound power level at the optimal operating point	6,0 bel(A)	
Sound pressure level at free air flow, measured in rubber bands	51,0 dB(A)	

4 Environment

4.1 General

Min. permitted ambient temperature TU min.	-20 °C	
Max. permitted ambient temperature TU max.	75 °C	
Min. permitted storage temperature TL min.	-40 °C	
Max. permitted storage temperature TL max.	80 °C	

4.2 Climatic requirements *)

Humidity requirements	humid heat, constant; according to DIN EN 60068-2-78, 14 days	
Water exposure	None	
Dust requirements	None	
Salt fog requirements	None	

*) Permitted application area:

The product is intended for use in sheltered rooms with controlled temperature and controlled humidity. Directly exposure to water must be avoided.

Pollution degree 1 (according DIN EN 60664-1)

There is either no pollution or it occurs only dry, non-conductive pollution. The pollution has no negative impact. Please require severity levels and specification parameters from the responsible development departments

5 Safety

5.1 Electrical Safety

Dielectric strength DIN EN 60950 (VDE 0805) and DIN EN 60335 (VDE 0700) A.) Type test Measuring conditions: After 48h of storage at 95% R.H. and 25°C. No arcing or breakdown is allowed! All connections together to ground.	500 VAC / 1 Min.	
B.) Routine test Measuring conditions: At indoor climate. No arcing or breakdown is allowed! All connections together to ground.	500 VAC / 1 Sec.	
Isolation resistance Measuring conditions: After 48h of storage at 95% R.H. and 25°C measured with U=500 VDC for 1 min.	RI > 10 MOhm	
clearance / creepage distance	1,0 mm / 1,2 mm	
Protection class	III	

5.2 Approval Tests

CE	EC Declaration of Conformity	Yes
EAC	Eurasian Conformity	Yes
UL	Underwriters Laboratories	Yes / UL507, Electric Fans
VDE	Association for Electrical, Electronic and Information Technologies	Yes / Approval acc. to EN 60950 (VDE 0805) - Information technology equipment
CSA	Canadian Standards Association	Yes / C22.2 No. 113 Fans and Ventilators
CCC	China Compulsory Certification	No

6 Reliability

6.1 General

Life expectancy L10 at TU = 40 °C	82.500 h	
Life expectancy L10 at TU max.	32.500 h	

Copies of this technical drawing are subject to the responsibility of the issuing office. Any
 change of data without consulting the issuing office shall be considered as a change of order. The
 drawing is not to be used for the reproduction of similar parts or copies.

Maßstab nach DIN 1303 (ISO 1030) (Scale) /
 Scale to production: 1:1 (1:1)

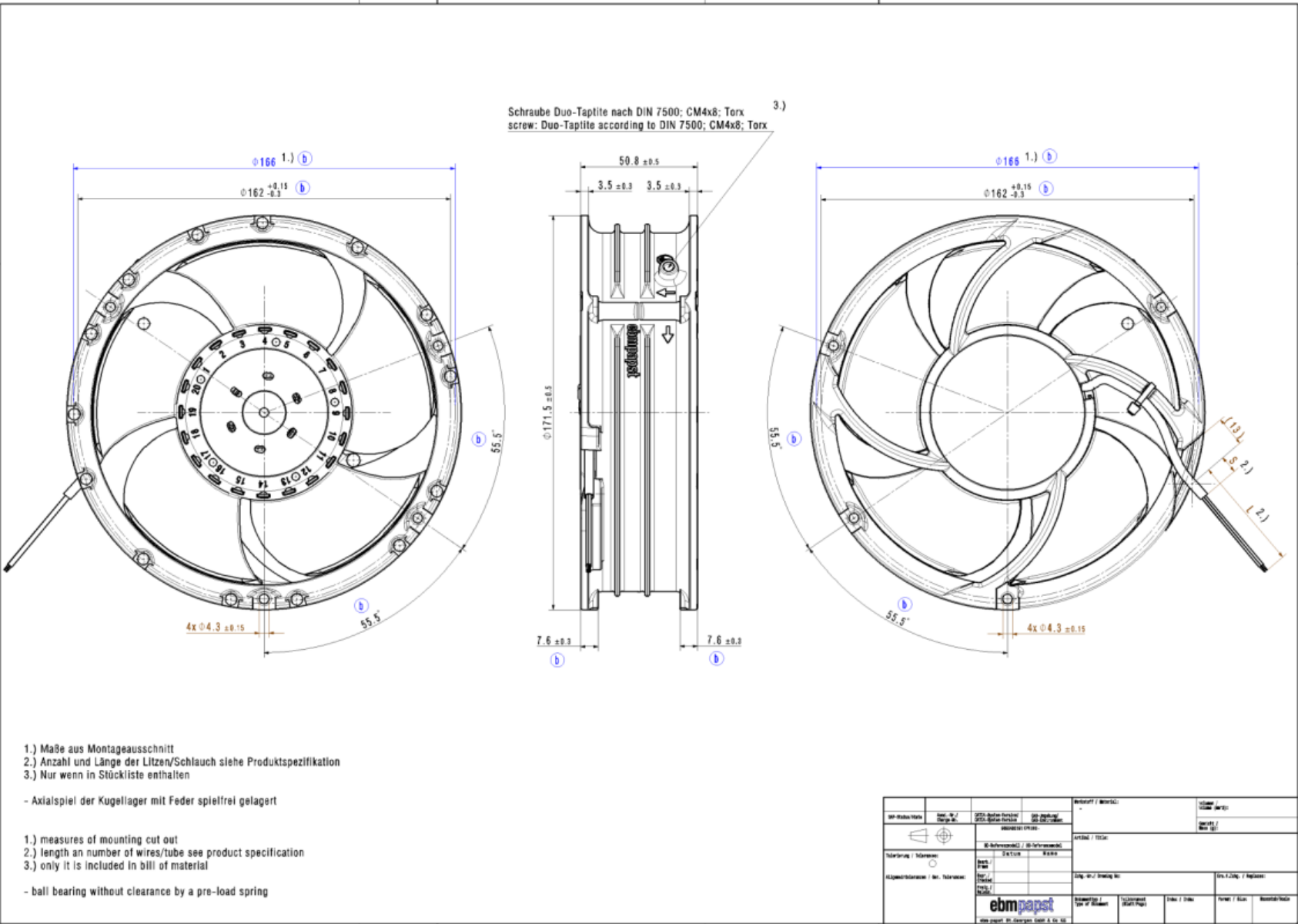

- 1.) Maße aus Montageausschnitt
- 2.) Anzahl und Länge der Litzen/Schlauch siehe Produktspezifikation
- 3.) Nur wenn in Stückliste enthalten

- Axialspiel der Kugellager mit Feder spielfrei gelagert

- 1.) measures of mounting cut out
- 2.) length an number of wires/tube see product specification
- 3.) only it is included in bill of material

- ball bearing without clearance by a pre-load spring

3D-Modell 		2D-Zeichnung 		Beschriftung / Markierung: (Blank area for labeling)	
Teilname / Name: (Blank area)		Material / Material: (Blank area)		Zeichnung / Drawing: (Blank area)	
Abgleichdimension / Abgleichdimension: (Blank area)		B-Beschreibung / B-Beschreibung: (Blank area)		Stück / Stück: (Blank area)	
Abgleichdimension / Abgleichdimension: (Blank area)		B-Beschreibung / B-Beschreibung: ebmpapst ebm papst - the German motor & fan co.		Stück / Stück: (Blank area)	

X-ON Electronics

Largest Supplier of Electrical and Electronic Components

Click to view similar products for [DC Fans](#) category:

Click to view products by [ebm papst](#) manufacturer:

Other Similar products are found below :

[F1238H24B-FHR](#) [F1238X24B1-FSR-TTL](#) [PMD1204PBB1-A \(2\).GN](#) [AUB0612L](#) [F6025X12B1-RHR](#) [G4020H05B2-RSR-EM](#) [4318/12T](#)
[AUB0912H-F00](#) [3412N/2ME](#) [W2G110-AM39-01](#) [USTF501005HW](#) [8412GLV](#) [8412NGL-12](#) [6448-384](#) [3258JH](#) [4114N/17-251](#) [4412F/2D](#)
[OD127AP-28HTB](#) [424JMU](#) [3110KL-05W-B50-G00](#) [1608KL-04W-B29-L00](#) [EF40101BX-1000U-G99](#) [4414/2HH](#) [512F/2P-549](#) [4112](#)
[N/12GL-175](#) [9GA0924L4021](#) [9GA0924M4021](#) [9GA0924M4011](#) [9GA0912M4D011](#) [9GA0924W4D01](#) [9GA0912F4021](#) [9GA0912H4D011](#)
[9GA0824L20021](#) [9GA0824L20011](#) [9GA0812A2002](#) [9GA0812B2D001](#) [9GA0812L20021](#) [9WP1248M1021](#) [9GA0812A2D001](#)
[9GA0824L2D001](#) [9GA0924W4D011](#) [9GA0912W402](#) [9GA0912M402](#) [9GA0824B2D001](#) [9GA0824A20021](#) [9GA0912W4021](#)
[9GA0924W402](#) [9GA0812L2D0011](#) [9GA0812A20021](#) [9GA0824L2001](#)