

Product Data Sheet 8452/2HHP

**ebmpapst**

The engineer's choice



8452/2HHP

INDEX

<b>1</b>	<b>General .....</b>	<b>3</b>
<b>2</b>	<b>Mechanics .....</b>	<b>3</b>
2.1	General .....	3
2.2	Connections .....	3
<b>3</b>	<b>Operating Data .....</b>	<b>5</b>
3.1	Electrical Interface - Input .....	5
3.2	Electrical Operating Data .....	6
3.3	Electrical Interface - Output .....	7
3.4	Electrical Features .....	8
3.5	Aerodynamics .....	9
3.6	Sound Data .....	10
<b>4</b>	<b>Environment .....</b>	<b>10</b>
4.1	General .....	10
4.2	Climatic Requirements .....	10
4.3	EMC .....	10
<b>5</b>	<b>Safety .....</b>	<b>12</b>
5.1	Electrical Safety .....	12
5.2	Approval Tests .....	12
<b>6</b>	<b>Reliability .....</b>	<b>12</b>
6.1	General .....	12

**1 General**

Fan type	Fan	
Rotating direction looking at rotor	Counterclockwise	
Airflow direction	Air outlet over struts	
Bearing system	Ball bearing	
Mounting position - shaft	Any	

**2 Mechanics****2.1 General**

Width	80,0 mm	
Height	80,0 mm	
Depth	25,0 mm	
Mass	0,110 kg	
Housing material	Plastic	
Impeller material	Plastic	
Max. torque when mounted across both mounting flanges Screw size	Wire outlet corner: 30 Ncm Remaining corners: 50 Ncm ISO 4762 - M4 degreased, without an additional brace and without washer	

**2.2 Connections**

Electrical connection	Wires	
Lead wire length	L = 310 mm	
Tolerance	+ - 10,0 mm	

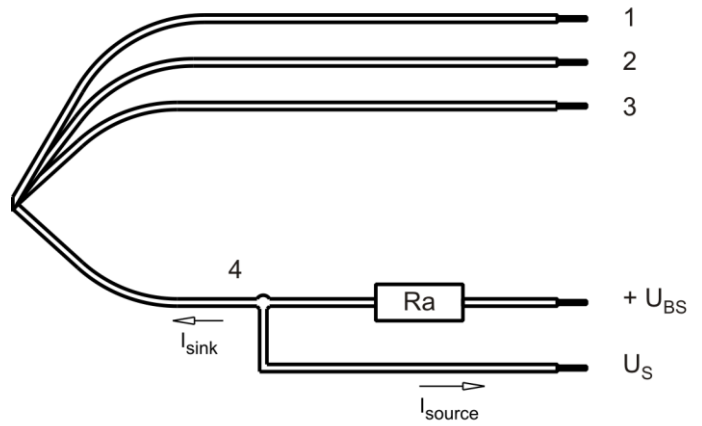

Wire	Color	Operation	Wire size	Insulation diameter
1	red	+ UB	AWG 24	1,55 mm
2	blue	- GND	AWG 24	1,55 mm
3	white	Tacho	AWG 24	1,55 mm
4	violet	PWM	AWG 24	1,55 mm

The auxiliaries shown on the schematic diagram (which are required for the intended use) are not part of our delivery.

### 3 Operating Data

#### 3.1 Electrical Interface - Input

Control input	PWM
---------------	-----

#### Features

Input type	Open collector	
PWM - Frequency		21 kHz - 28 kHz typical: 25 kHz
Max. voltage for logic "Low"		0,8 V
Max. voltage for logic "High"	Open circuit voltage	5,25 V
Maximum source current	short circuit current	5 mA
4 wire startup condition	PWM duty cycle	> 20 %
4 wire operation condition after startup	PWM duty cycle	15 % - 100 %
Shutdown condition	PWM duty cycle	< 1 %
Typical time until warm restart	After shutdown by PWM	1,2 s

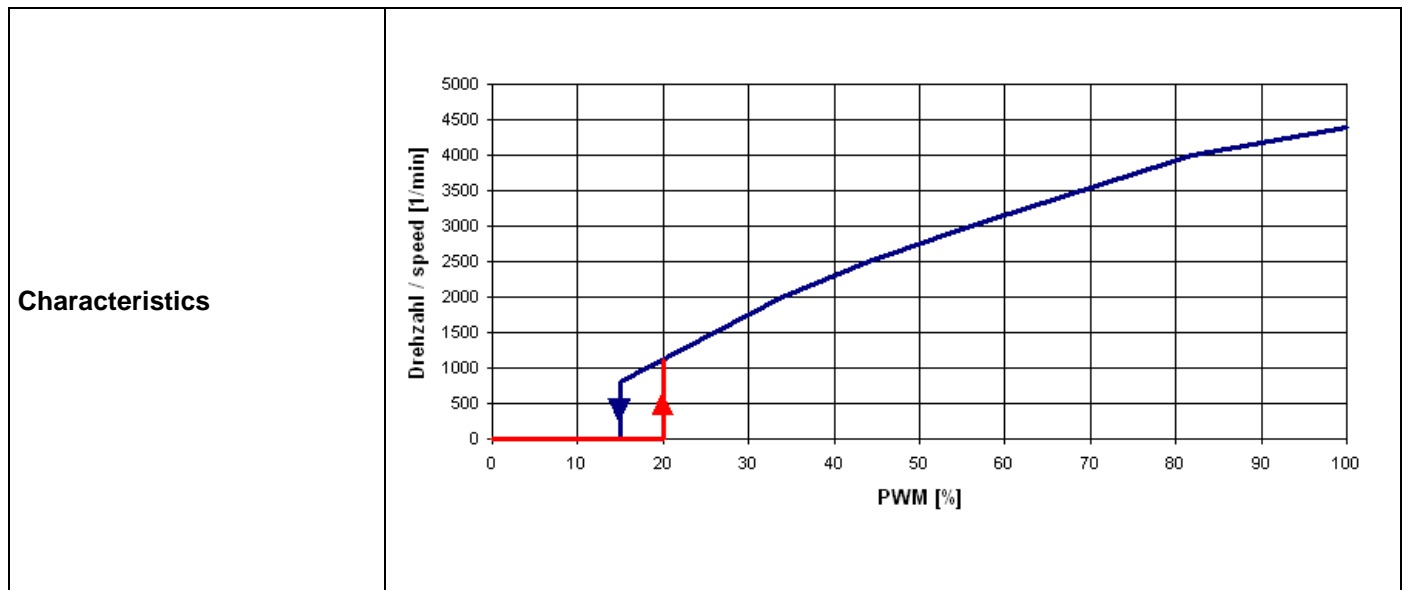

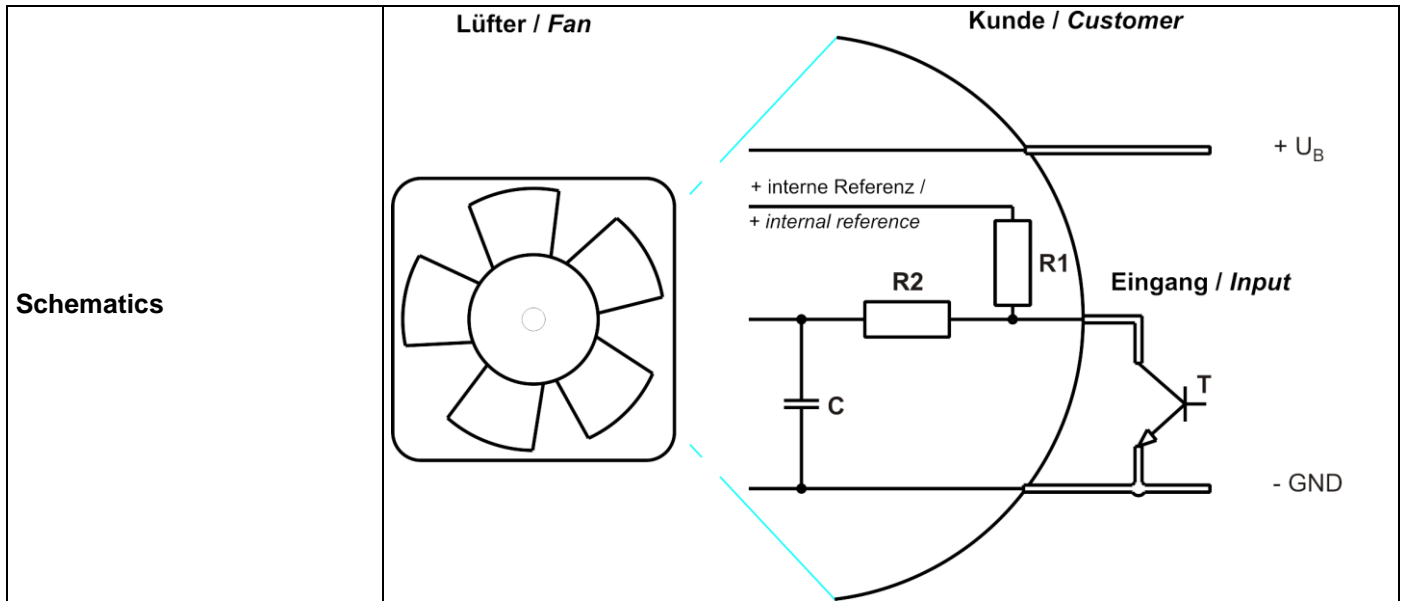

### 3.2 Electrical Operating Data

Measurement conditions: Normal air density = 1,2 kg/m<sup>3</sup>; Temperature 23°C +/- 3°C; Motor axis horizontal; warm-up time before measuring 5 minutes (unless otherwise specified). In the intake and outlet area should not be any solid obstruction within 0,5 m.

$\Delta p = 0$ : corresp. to free air flow (see chapter aerodynamics)  
 I: corresp. to arithm. mean current value

Name	Condition
PWM 0001	PWM: 100 %; f: 25 kHz

Features	Condition	Symbol	Values		
Voltage range		U	10,8 V		13,2 V
Nominal voltage		$U_N$		12,0 V	
Power consumption	$\Delta p = 0$	P	2,9 W	3,6 W	4,5 W
Tolerance	PWM 0010		+/- 17,5 %	+/- 12,5 %	+/- 15,0 %
Current consumption	$\Delta p = 0$	I	270 mA	300 mA	340 mA
Tolerance	PWM 0010		+/- 17,5 %	+/- 12,5 %	+/- 15,0 %
Speed	$\Delta p = 0$	n	4.050 1/min	4.400 1/min	4.650 1/min
Tolerance	PWM 0010		+/- 12,5 %	+/- 7,5 %	+/- 10,0 %
Starting current consumption				830 mA	

3.3 Electrical Interface - Output

Tacho type	/2 (open collector)
------------	---------------------

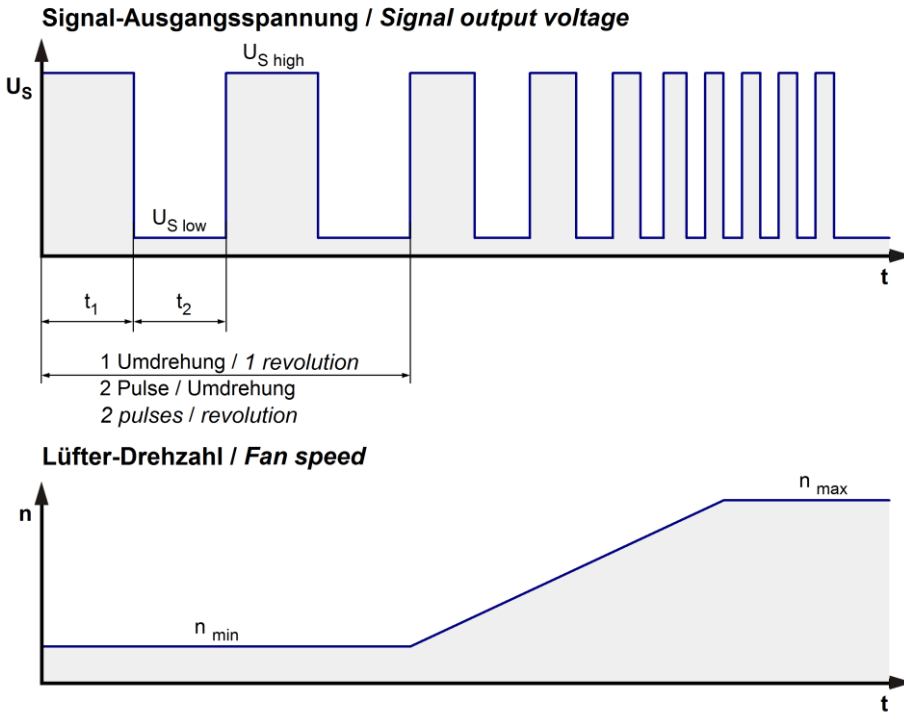

$$R_a = \frac{U_{BS} - U_{S\ low}}{I_{sink}}$$

Lüfter / Fan      Kunde / Customer

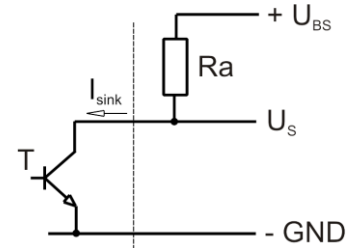

Features	Note	Values
Tacho operating voltage	$U_{BS}$	$\leq 28\text{ V}$
Tacho signal Low	$U_{S\ low}$	$\leq 0,4\text{ V}$
Tacho signal High	$U_{S\ high}$	$28\text{ V}$
Maximum sink current	$I_{sink}$	$\leq 4\text{ mA}$
External resistor	External resistor $R_a$ from $U_{BS}$ to $U_S$ required. All voltages measured to GND.	
Tacho frequency	$(2 \times n) / 60$	$120\text{ Hz}$
Tacho isolated from motor	No	
Slew rate		$\Rightarrow 0,5\text{ V/us}$

n = revolutions per minute (1/min)

### 3.4 Electrical Features

Electronic function	None	
Reversed polarity protection	Rectifying diode	
Max. residual current at $U_N$	$I_F \leq 10 \text{ mA}$	
Locked rotor protection	Auto restart	
Locked rotor current at $U_N$	$I_{\text{block}}$ approx. 850 mA	
Clock signal at locked rotor	$t_3 / t_4$ typical: 0,46 s / 2,76 s	

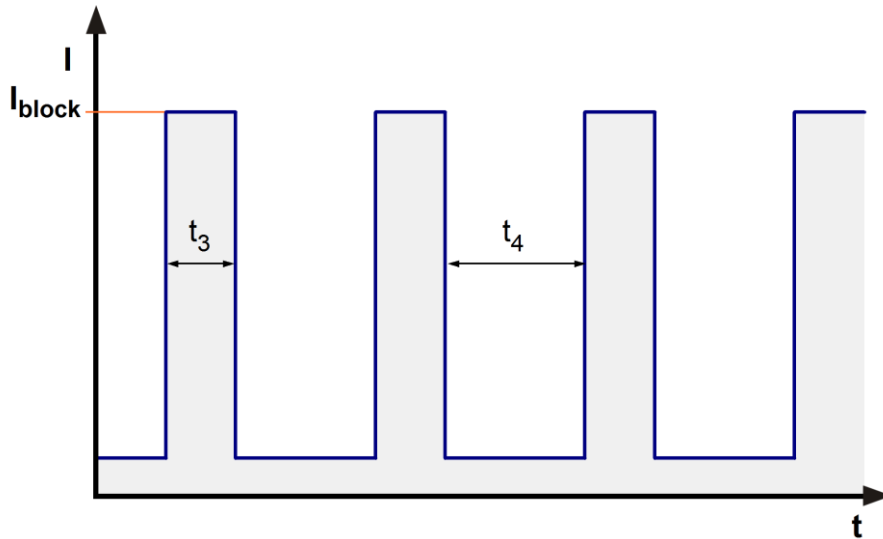



### 3.5 Aerodynamics

Measurement conditions:

Measured with a double chamber intake rig acc. to DIN EN ISO 5801.

Normal air density = 1,2 kg/m<sup>3</sup>; Temperature 23°C +/- 3°C;

In the intake and outlet area should not be any solid obstruction within 0,5 m. Motor shaft horizontal.

The information is only valid under the specified test conditions and may be changed by the installation conditions. If there are deviations from the standard test conditions, the characteristic values must be checked under the installed conditions.

a.) Operation condition:

4.400 1/min at free air flow	PWM 100 %; f: 25 kHz		
------------------------------	----------------------	--	--

Max. free-air flow ( $\Delta p = 0 / \dot{V} = \text{max.}$ )	82,0 m <sup>3</sup> /h	
Max. static pressure ( $\Delta p = \text{max.} / \dot{V} = 0$ )	70 Pa	

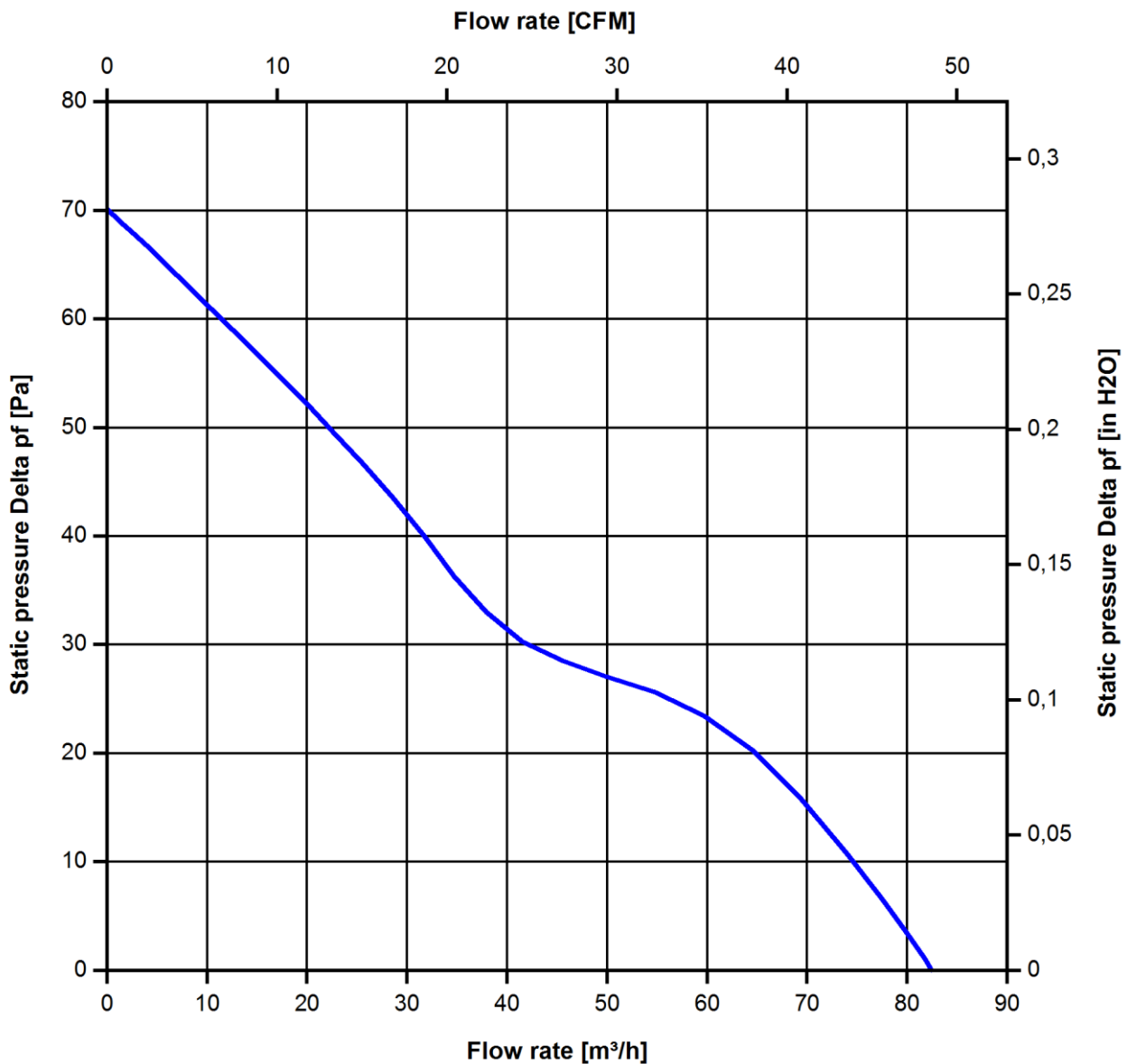

### 3.6 Sound Data

Measurement conditions: Sound pressure level: 1 meter distance between microphone and the air intake.  
 Sound power level: Acc. to DIN 45635 part 38 (ISO 10302)  
 Measured in a semianchoic chamber with a background noise level of  $L_p(A) < 5 \text{ dB(A)}$   
 For further measurement conditions see chapter aerodynamics.

a.) Operation condition:

4.400 1/min at free air flow	PWM 100 %; f: 25 kHz		
------------------------------	----------------------	--	--

Optimal operating point	56,0 m <sup>3</sup> /h @ 24 Pa		
Sound power level at the optimal operating point	5,5 bel(A)		
Sound pressure level at free air flow, measured in rubber bands	42,0 dB(A)		

## 4 Environment

### 4.1 General

Min. permitted ambient temperature TU min.	-20 °C		
Max. permitted ambient temperature TU max.	60 °C		
Min. permitted storage temperature TL min.	-40 °C		
Max. permitted storage temperature TL max.	80 °C		

### 4.2 Climatic Requirements

Humidity requirements	humid heat, constant; according to DIN EN 60068-2-78, 14 days		
Water exposure	None		
Dust requirements	None		
Salt fog requirements	None		

Permitted application area:

The product is intended for use in sheltered rooms with controlled temperature and controlled humidity. Directly exposure to water must be avoided.

Pollution degree 1 (according DIN EN 60664-1)

There is either no pollution or it occurs only dry, non-conductive pollution. The pollution has no negative impact.

Please require severity levels and specification parameters from the responsible development departments.

### 4.3 EMC

<b>Kind</b>	<b>Conducted Emission; Voltage; 150 kHz-30 MHz</b>
According	DIN EN 55022:2007-04
Check accuracy / Limit	Class B
Result	Below limit Class B

Accordinging	DIN EN 55022:2007-04
Check accuracy / Limit	Class B
Result	Below limit Class B

<b>Kind</b>	<b>Electrostatic Discharge Immunity Test</b>
Accordinging	DIN EN 61000-4-2:2001-12
Check accuracy / Limit	Contact Discharge +/- 4 kV; Air Discharge +/- 8 kV
Result	A: The monitored function operates as designed during and after exposure to a disturbance.

<b>Kind</b>	<b>Electromagnetic Field Immunity Test</b>
Accordinging	DIN EN 61000-4-3:2006-12
Check accuracy / Limit	10 V/m; 80 - 1000 MHz; m = 0,8; f = 1 kHz; 1%; t = 3 s
Result	A: The monitored function operates as designed during and after exposure to a disturbance.

<b>Kind</b>	<b>Electrical Fast Transient / Burst Immunity Test</b>
Accordinging	DIN EN 61000-4-4:2005-07
Check accuracy / Limit	+/- 2 kV on Power Lines; Coupling: POS, NEG, {PE}, ALL, 5 kHz and 100 kHz; 1 min
Result	A: The monitored function operates as designed during and after exposure to a disturbance.

<b>Kind</b>	<b>Immunity to Conducted Disturbances, Induced by RF-Fields</b>
Accordinging	DIN EN 61000-4-6:2001-12
Check accuracy / Limit	10 Vrms; 150 kHz - 80 MHz; m = 0,8; f = 1 kHz; 1%; t = 3 s
Result	A: The monitored function operates as designed during and after exposure to a disturbance.

## 5 Safety

### 5.1 Electrical Safety

Dielectric strength DIN EN 60950 (VDE 0805) and DIN EN 60335 (VDE 0700) A.) Type test Measuring conditions: After 48h of storage at 95% R.H. and 25°C. No arcing or breakdown is allowed! All connections together to ground.	500 VAC / 1 Min.	
B.) Routine test Measuring conditions: At indoor climate. No arcing or breakdown is allowed! All connections together to ground.	850 VDC / 1 Sec.	
Isolation resistance Measuring conditions: After 48h of storage at 95% R.H. and 25°C measured with U=500 VDC for 1 min.	RI > 10 MOhm	
Clearance / creepage distance	1,0 mm / 1,2 mm	
Protection class	III	

### 5.2 Approval Tests

CE	EC Declaration of Conformity	Yes
EAC	Eurasian Conformity	Yes
UL	Underwriters Laboratories	Yes / UL audited by CSA according to UL507, Electric Fans
VDE	Association for Electrical, Electronic and Information Technologies	Yes / Approval acc. to EN 60950 (VDE 0805) - Information technology equipment
CSA	Canadian Standards Association	Yes / C22.2 No. 113 Fans and Ventilators
CCC	China Compulsory Certification	Not applicable

## 6 Reliability

### 6.1 General

Life expectancy L10 at TU = 40 °C	65.000 h	
Life expectancy L10 at TU max.	40.000 h	
Life expectancy L10 acc. to IPC 9591 at TU = 40 °C	110.000 h	

Copying of this document, and giving it others and the use or communication of  
forbiden without express authority. Offenders are liable to the payment of dan  
in the event of the grant of a patent or the registration of a utility model or

Schutzvermerk nach DIN ISO 16016 beachten !  
Refer to protection notice DIN ISO 16016 !

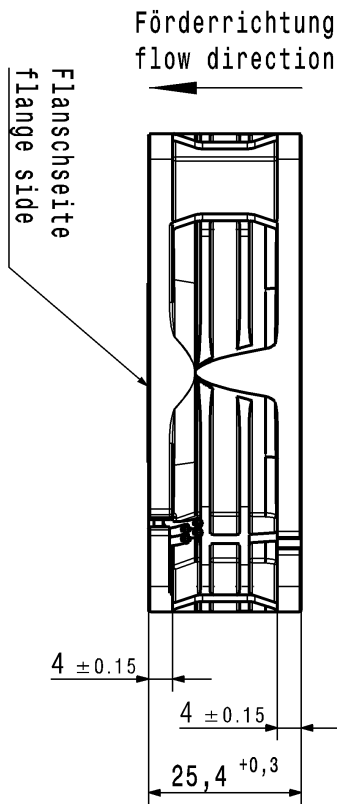
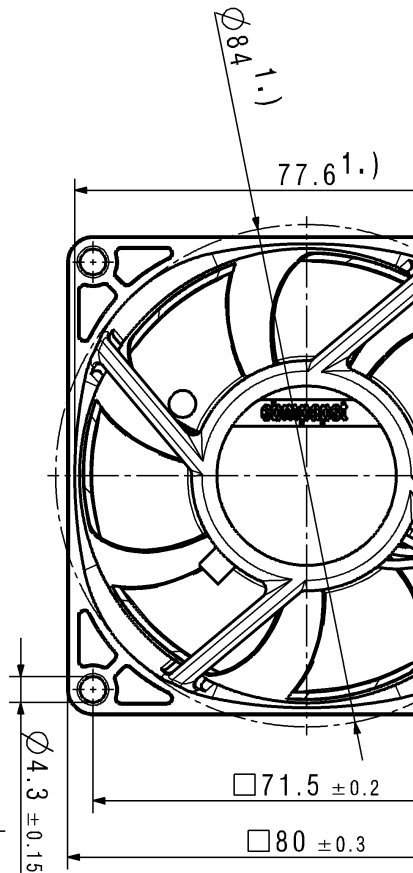

1.) Maße für Montagewand  
1.) dimension for workshop mounting  
Laenge und Anzahl der Litzen siehe Produktspezifikation.  
Length and number of the wires, look at the product specification.  
Kein Axialspiel bei Kugellager durch Federausgleich.  
No axial clearance of ball bearings conditional on a pre-load spring.

SPZ-Status/State		Arnd.-Nr. / Change-No.		CADIA-System-Version/ CADIA-System-Version		QdL-Lagebung/ QdL-Environment	
Datum				Name			
Tolerierung / Tolerances:		Reich / Depth		Repr. / Checked		Freig. / Released	
Allgemeintoleranzen / gen. Tolerances:							
				<b>em-papst</b>			
Hersteller / Material:		Zug-Nr. / Drawing No:		Volumen / Volume (mm <sup>3</sup> ):		Gewicht / Mass (g):	
Artikel / Title:		Dokumenttyp / Type of document		Teildokument (Blatt/Page)		Index / Index	
Ers.f.Zug. / Repl.ass:		Format / Size:		Massstab/Scale			

## X-ON Electronics

Largest Supplier of Electrical and Electronic Components

*Click to view similar products for [DC Fans](#) category:*

*Click to view products by [ebm papst](#) manufacturer:*

Other Similar products are found below :

[614R](#) [AUB0612L](#) [AFB0948HH-S687](#) [G2E085-AA05-10](#) [4318/12T](#) [AUB0912H-F00](#) [3412N/2ME](#) [W2G110-AM39-01](#) [8412GLV](#) [8412NGL-12](#) [6448-384](#) [4114N/17-251](#) [622/2N](#) [4318/2R](#) [4412F/2D](#) [424JMU](#) [4414/2HH](#) [4112 N/12GL-175](#) [9GA0912F402](#) [9GA0812B20011](#) [AFB0824SHBAV1](#) [DV5214/2NP-230](#) [9GA0912H4021](#) [THC1548MGDJJ](#) [GFB1224SHG](#) [8500NU](#) [DC0401012V2B-3T0](#) [3254J/2HPU](#) [9A0612G402](#) [AD5012HB-C71](#) [AD5012MB-C71](#) [EF92251S3-1000U-A99](#) [PF80251B3-000U-Q99](#) [026758A](#) [3258J/2H3PU????](#) [412/2H](#) [4292](#) [MF60152V1-1000U-G99](#) [3610KL-04W-B50-D00](#) [EE92251B1-000U-G99](#) [8218J/2H4P](#) [4318NN](#) [4318NH3](#) [4314NL](#) [4312NM](#) [MITX-CORE-HTSNK](#) [ME45101V1-000U-A99](#) [OD1238-24HBIP55](#) [4312NHH](#) [612N/2GH](#)