

VARIODRIVE and VARIODRIVE Compact motors

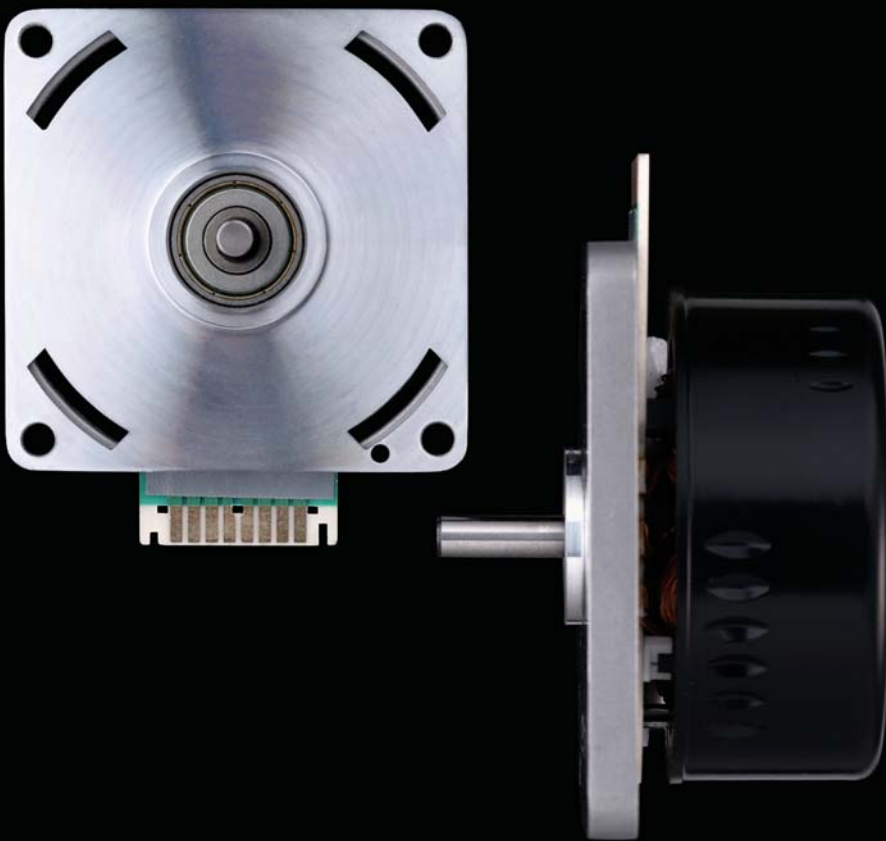

VARIODRIVE

VARIODRIVE Compact



Technical Information

VARIODRIVE

VARIODRIVE offers you the extensive power range and dynamics of a modern EC drive with a price-performance ratio that has so far been deemed inconceivable. The motors and motor electronics of this product line originated essentially from the basic elements of the renowned ebm-papst DC fans. Production processes and material procurement profit from the millions of fans produced. This formed the basis for 5 sizes of 1- and 3-phase EC external rotor motors in an extensive performance range.

With high operating efficiency – in other words – with low energy consumption and high motor performance, these motors are a convincing solution, offering a wide speed range and excellent control characteristics. High torque constancy, no vibration and virtually noiseless running are further advantages of these motors.

VARIODRIVE Compact

This is total integration – with a 3-phase electronically commutated DC motor and the control electronics all in a single package: Unrivalled in this performance class. The extremely compact drive unit with microprocessor-controlled motor manager and FET power stage has an internal closed-loop speed control compatible with all standard industrial interfaces. This means: just connect it up and off you go!

VARIODRIVE Compact is ultraflexible. The motor can be speed controlled and the desired speed selected via a set value voltage. Via 2 control inputs the direction of rotation can be selected, the motor can be enabled or a motor brake function can be activated. An open collector frequency output for monitoring the actual speed is also available.

Data and facts VARIODRIVE

- 1- and 3-phase external rotor motors in 5 different sizes.
- EC technology for long service life and silent running.
- Power range: 3 to 100 Watt.
- Precision ball bearings.
- Spur gears in different gear reduction stages for a variety of applications.

Data and facts VARIODRIVE Compact

- 3-phase, electronically commutated external rotor motor.
- Excellent control response over the entire speed range due to digital 4-Q PI controller.
- High operating efficiency due to FET power stage and special control process.
- Excellent speed stability, silent running, long service life.
- Motor manager: Safe operation in all working point by speed-dependent current limiting and by stall protection pulsing.
- ACTUAL speed output.
- Motor electronics optimally adapted to motor characteristic.
- Spur gears and planetary gears in different gear reduction stages for a variety of applications.
- Winding insulation as per insulation class E.
- Standard protection class IP 00, for VDCS-3-54.14 and VDC 3-54.32 in IP 40.
- Customer-specific winding layout and motor part sets available on request (e.g. fixed speed, direction of rotation).

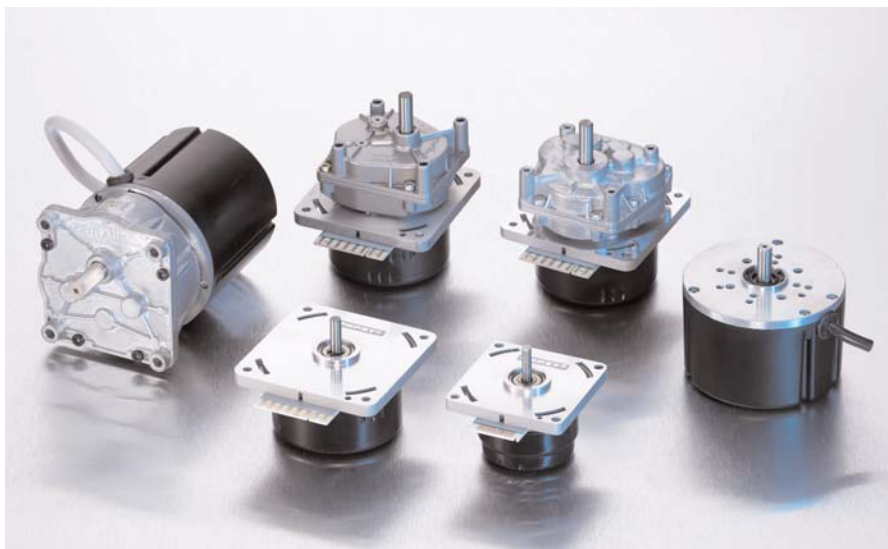

The 1- and 3-phase brushless outer rotor motor design has proven its reliability in millions of ebmpapst fan products. Based on this quality and experience VARIODRIVE and VARIODRIVE Compact motors offer excellent speed stability, silent running and a safe and long service life.



VARIODRIVE-Motor	
– Commutation	4
<hr/>	
VARIODRIVE 1-phase external rotor motors	
– VD-1-27.08	5
– VD-1-27.15	6
– VD-1-35.05	7
– VD-1-43.10	8
– VD-1-54.14	9
<hr/>	
VARIODRIVE 3-phase external rotor motors	
– VD-3-25.07	10
– VD-3-35.06	11
– VD-3-43.10	12
– VD-3-54.14	13
<hr/>	
VARIODRIVE Compact motors	
– VDC-3-43.10	14
– VDC-3-54.14	16
– VD-CS-3-54.14	18
– VDC-3-54.32	20
<hr/>	
VARIODRIVE Compact gear motors	
– VDC-3-43.10	22
– VDC-3-54.14	26
– VDC-3-54.32	30
<hr/>	
DRIVECONTROL VT-A	33
<hr/>	
Accessories	35
<hr/>	
Addresses	37
<hr/>	

VARIODRIVE

Commutation

The following diagram illustrates the sequence of the Hall signals and the corresponding drive sequence with the relevant colours and / or pin assignment that apply to self-developed products and / or to purchased electronics. It also illustrates the phase position of these signals to the induced motor voltage.

Commutation sequences

Commutation sequences

Chronological signal sequence of integrated Hall sensors (= RLG) at the corresponding connections.

Switching sequences of the power output stage

Required relationship between the signal change from RLG and the relevant change for the switching status of the power transistors in relation to the phase lead to the motor.

Induced voltages

Idealized illustration of the sequence of the induced voltages between the relevant connections.

Total of induced voltages

Supply voltage for Hall sensor

Hall-IC A 3187 LUA

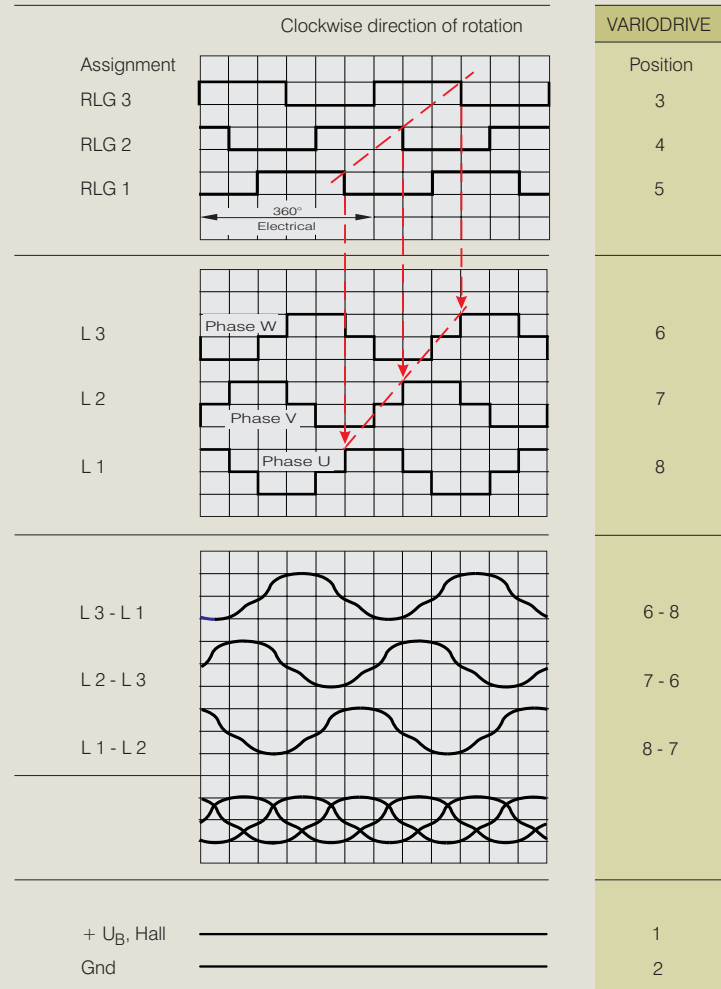

Hall-IC

Supply voltage range:

$V_{CC} = 4.5 \dots 24 \text{ V}$

Signal output: Open Collector

Max. output voltage: $V_o = 24 \text{ V}$

Max. output current: $I_o = 20 \text{ mA}$

Plug

Electrical connection via 8-pole motor plug
(not included in scope of delivery)

AMP-Edge 5 mm: No. 829-213-8 = VD-3-54.14

AMP-Duoplug: Type 2.5 No. 3-82 98 68-8
optional

Lumberg-Duomodul: Type 3 21 08K30 = VD-3-35.06
and VD-3-43.10

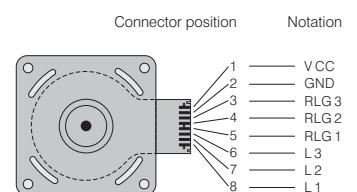

VARIODRIVE-Motor

VD-1-27.08



- 1-phase, 2-core reluctance motor as external rotor version.
- EC technology.
- Dynamically balanced rotor with 4-pole, plastic-bonded ferrite magnet.
- Determination of rotor position via Hall sensor.
- Commutation electronics fully integrated in the motor.
- Load-dependent speed setting via connection voltage.
- Customer-specific winding layout and / or motor part sets available on request.

Nominal Data

Type	VD-1-27.08	
Nominal voltage (U_{BN})	V DC	24 (16 ... 28)
Nominal speed (n_N)	min ⁻¹	4 500
Nominal torque (M_N)	mNm	5.70
Nominal current (I_{BN})	A	0.25
Nominal output power (P_N)	W	2.7
Free-running speed (n_L)	min ⁻¹	6 800
Free-running current (I_{BL})	A	0.10
Induced voltage (U_{imax})	V/1000min ⁻¹	3.25
Average starting torque	mNm	14
Max. starting current	A	0.60
Rotor moment of inertia (J_R)	kgm ² x10 ⁻⁶	11.0
Thermal resistance (R_{th})	K/W	14
Protection class		IP 00
Ambient temperature range (T_U)	°C	0 ... +40
Motor mass (m)	kg	0.12
Order No.	Clockwise rotation	937 2708 500
Order No.	Counterclockwise rotation	937 2708 550

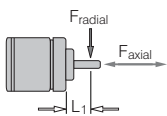

F_{axial} 4 N
 F_{radial} 10 N L_1 10 mm

Permissible shaft load at nominal speed and life expectancy L_{10} at 20 000 h.

Electrical connection:

Electrical connection via 2 single leads, AWG 24, TR 64, 300 mm long with stripped and tinned ends.

+ = red - = blue

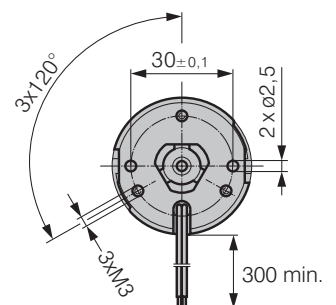
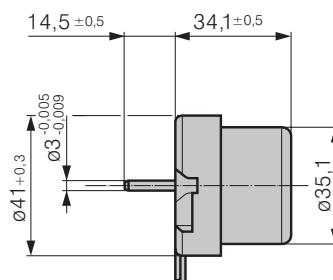
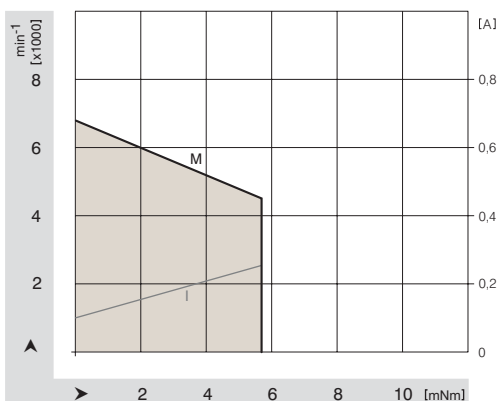

VARIODRIVE-Motor

VD-1-27.15



- 1-phase, 2-core reluctance motor as external rotor version.
- EC technology.
- Dynamically balanced rotor with 4-pole, plastic-bonded ferrite magnet.
- Determination of rotor position via Hall sensor.
- Commutation electronics fully integrated in the motor.
- Load-dependent speed setting via connection voltage.
- Customer-specific winding layout and / or motor part sets available on request.

Nominal Data

Type		VD-1-27.15
Nominal voltage (U_{BN})	V DC	24 (16 ... 28)
Nominal speed (n_N)	min ⁻¹	4 200
Nominal torque (M_N)	mNm	8.6
Nominal current (I_{BN})	A	0.32
Nominal output power (P_N)	W	3.8
Free-running speed (n_L)	min ⁻¹	6 400
Free-running current (I_{BL})	A	0.12
Induced voltage (U_{imax})	V/1000min ⁻¹	3.50
Average starting torque	mNm	24
Max. starting current	A	0.80
Rotor moment of inertia (J_R)	kgm ² x10 ⁻⁶	15.0
Thermal resistance (R_{th})	K/W	8
Protection class		IP 00
Ambient temperature range (T_U)	°C	0 ... +40
Motor mass (m)	kg	0.15
Order No.	Clockwise rotation	-
Order No.	Counterclockwise rotation	937 2715 550

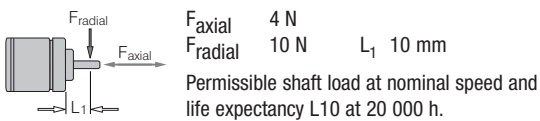

Electrical connection:

Electrical connection via 2 single leads, AWG 24, TR 64, 300 mm long with stripped and tinned ends.

+ = red - = blue

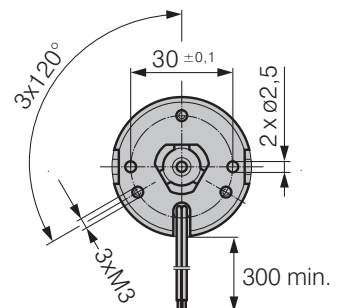
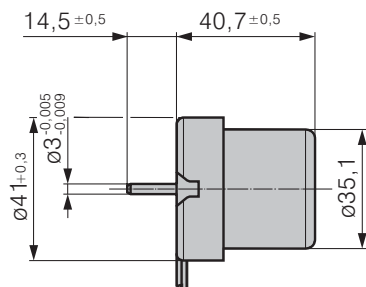
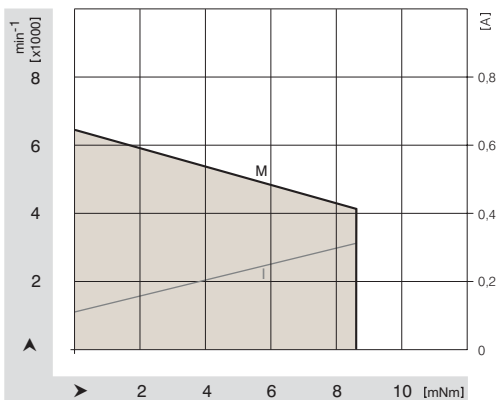

VARIODRIVE-Motor

VD-1-35.05



- 1-phase, 2-core reluctance motor as external rotor version.
- EC technology.
- Dynamically balanced rotor with 4-pole, plastic-bonded ferrite magnet.
- Determination of rotor position via Hall sensor.
- Commutation electronics fully integrated in the motor.
- Load-dependent speed setting via connection voltage.
- Customer-specific winding layout and / or motor part sets available on request.

Nominal Data

Typ		VD-1-35.05
Nominal voltage (U_{BN})	V DC	24 (12 ... 28)
Nominal speed (n_N)	min ⁻¹	5 000
Nominal torque (M_N)	mNm	3.4
Nominal current (I_{BN})	A	0.31
Nominal output power (P_N)	W	1.8
Free-running speed (n_L)	min ⁻¹	6 000
Free-running current (I_{BL})	A	0.20
Induced voltage (U_{imax})	V/1000min ⁻¹	2.40
Average starting torque	mNm	19
Max. starting current	A	0.20
Rotor moment of inertia (J_R)	kgm ² x10 ⁻⁶	16.0
Thermal resistance (R_{th})	K/W	6.60
Protection class		IP 00
Ambient temperature range (T_U)	°C	0 ... +40
Motor mass (m)	kg	0.12
Order No.	Clockwise rotation	937 3505 500
Order No.	Counterclockwise rotation	937 3505 550

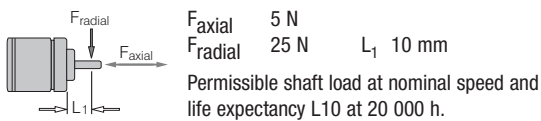

Electrical connection:

Electrical connection via 2 single leads, AWG 24, TR 64, 300 mm long with stripped and tinned ends.

+ = red - = blue

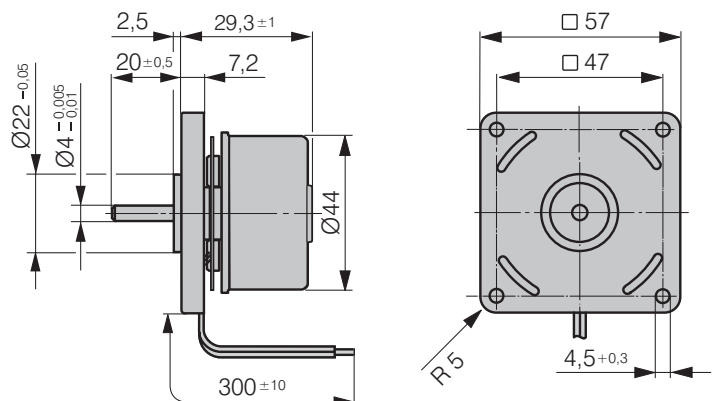
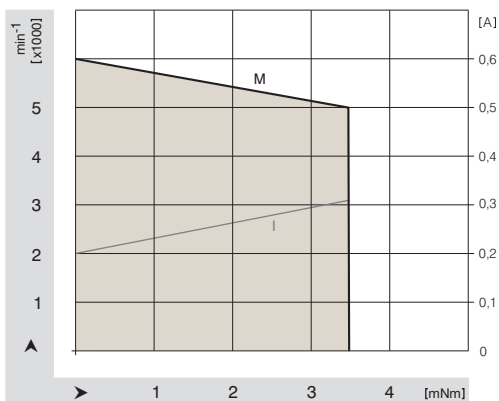

VARIODRIVE-Motor

VD-1-43.10



- 1-phase, 2-core reluctance motor as external rotor version.
- EC technology.
- Dynamically balanced rotor with 4-pole, plastic-bonded ferrite magnet.
- Determination of rotor position via Hall sensor.
- Commutation electronics fully integrated in the motor.
- Load-dependent speed setting via connection voltage.
- Customer-specific winding layout and / or motor part sets available on request.

Nominal Data

Type		VD-1-43.10	...504	...508
Nominal voltage (U_{BN})	V DC	24 (12 ... 28)	12	24 (12 ... 25)
Nominal speed (n_N)	min ⁻¹	4 000	3 800	3 450
Nominal torque (M_N)	mNm	18	11	19.5
Nominal current (I_{BN})	A	0.55	0.7	0.5
Nominal output power (P_N)	W	7.5	4.4	7.0
Free-running speed (n_I)	min ⁻¹	7 000	5 250	6 300
Free-running current (I_{BL})	A	0.18	0.3	0.15
Induced voltage (U_{imax})	V/1000min ⁻¹	3.7	2.19	4.0
Average starting torque	mNm	70	50	50
Max. starting current	A	2.5	3.0	1.5
Rotor moment of inertia (J_R)	kgm ² x10 ⁻⁶	40	40	40
Thermal resistance (R_{Th})	K/W	4.5	5,0	5,0
Protection class		IP 00	IP 00	IP 00
Ambient temperature range (T_U)	°C	0 ... +40	0 ... +40	0 ... +40
Motor mass (m)	kg	0.24	0.24	0.24
Order No.	Clockwise rotation	937 4310 500	937 4310 504	937 4310 508
Order No.	Counterclockwise rotation	937 4310 550	-	-

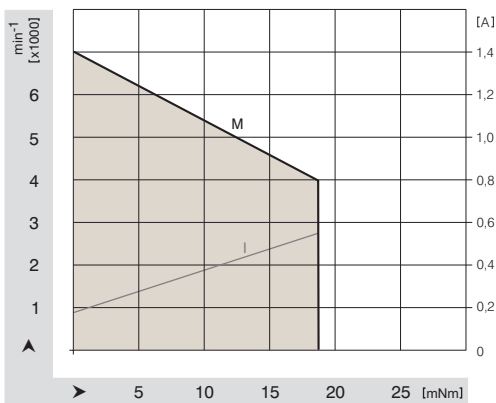
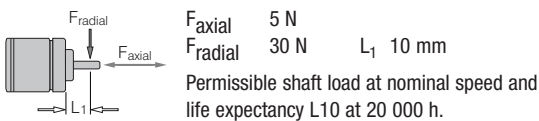

Electrical connection:
 Electrical connection via 2 single leads, AWG 22, TR 64, 300 mm long with stripped and tinned ends.
 + = red - = blue

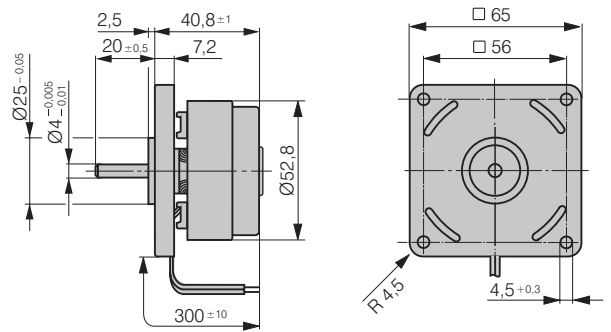

Type 504 / 508: VARIODRIVE with round flange

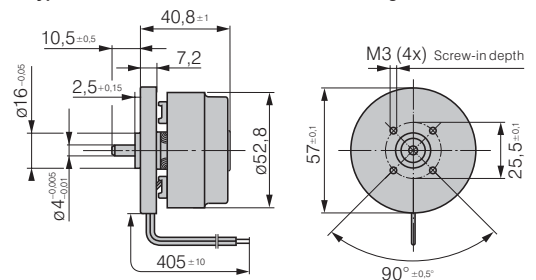

VARIODRIVE-Motor

VD-1-54.14



- 1-phase, 2-core reluctance motor as external rotor version.
- EC technology.
- Dynamically balanced rotor with 4-pole, plastic-bonded ferrite magnet.
- Determination of rotor position via Hall sensor.
- Commutation electronics fully integrated in the motor.
- Load-dependent speed setting via connection voltage.
- Customer-specific winding layout and / or motor part sets available on request.

Nominal Data

Type		VD-1-54.14	...550
Nominal voltage (U_{BN})	V DC	24 (12 ... 28)	24 (20 ... 28)
Nominal speed (n_N)	min ⁻¹	4 000	3 300
Nominal torque (M_N)	mNm	62	40
Nominal current (I_{BN})	A	1.75	0.95
Nominal output power (P_N)	W	26	14
Free-running speed (n_L)	min ⁻¹	8 000	5 400
Free-running current (I_{BL})	A	0.70	0,55
Induced voltage (U_{imax})	V/1000min ⁻¹	4.2	5.6
Average starting torque	mNm	100	100
Max. starting current	A	2.7	2.0
Rotor moment of inertia (J_R)	kgm ² x10 ⁻⁶	200	200
Thermal resistance (R_{th})	K/W	3.2	3.5
Protection class		IP 00	IP 00
Ambient temperature range (T_U)	°C	0 ... +40	0 ... +40
Motor mass (m)	kg	0.52	0.52
Order No.	Clockwise rotation	937 5414 502	-
Order No.	Counterclockwise rotation	-	937 5414 550

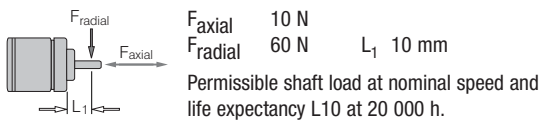

Electrical connection:

Electrical connection via 2 single leads, AWG 24, TR 64, 300 mm long with stripped and tinned ends.

+ = red - = blue

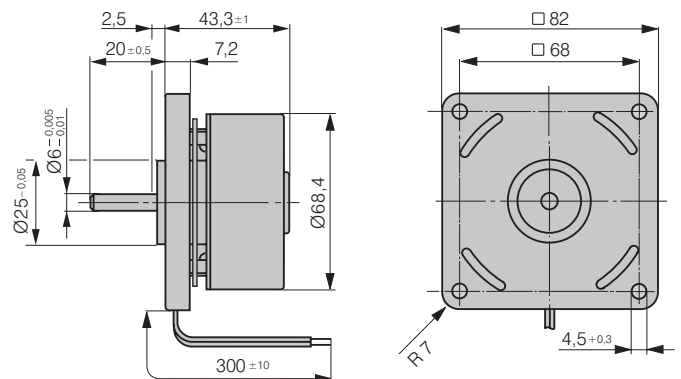
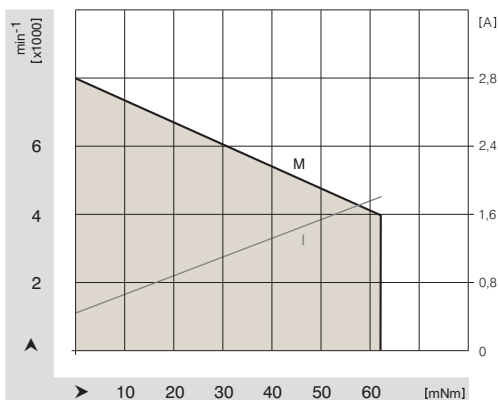

VARIODRIVE-Motor

VD-3-25.07



- 3-phase, 6-pulse external rotor motor.
- EC technology.
- Dynamically balanced rotor with 4-pole, plastic-bonded ferrite magnet.
- Determination of rotor position via 3 Hall sensors.
- Motor supply and control via external operating electronics.
- Customer-specific winding layout and / or motor part sets available on request.

Nominal Data

Type	VD-3-25.07	
Nominal voltage (U_{BN})	V DC	24
Nominal speed (n_N)	min ⁻¹	6 000
Nominal torque (M_N)	mNm	8.0
Nominal current (I_{BN})	A	0.4
Nominal output power (P_N)	W	5
Free-running speed (n_U)	min ⁻¹	8 500
Free-running current (I_{BL})	A	0.095
Permanent stall torque (M_{BNO})	mNm	7.0
Permissible eff. stall current, motor lead (I_{N0eff})	A	0.32
Permissible permanent input power at stall (P_{BNO})	W	2.0
Short-term permiss. peak torque (M_{max})	mNm	40
Permiss. peak current, motor lead (I_{max})	A	1.8
Induced voltage (U_{imax})	V/1000min ⁻¹	2.78
Terminal resistance	Ω	14.8
Terminal inductance	mH	8
Rotor moment of inertia (J_R)	kgm ² x10 ⁻⁶	4.3
Thermal resistance (R_{th})	K/W	16.7
Protection class		IP 00
Ambient temperature range (T_U)	°C	0 ... +40
Motor mass (m)	kg	0.055
Order No.		937 2507 000

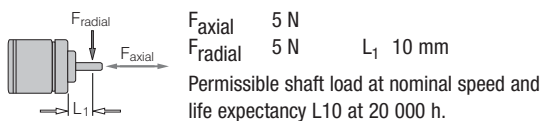

Operating electronics:

Adapted operating electronics
DRIVECONTROL VT-A on request.

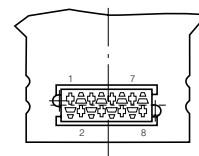

Pin position	Connection
1	GND
2	PS3
3	+Ub
4	PS2
5	PS1
6	U
7	V
8	W

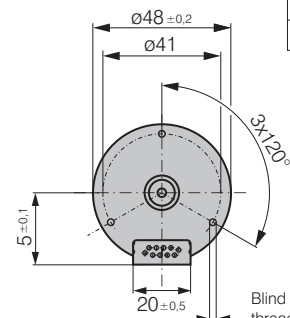
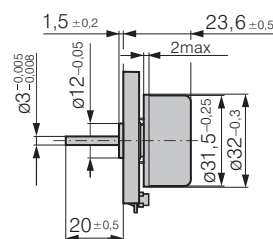
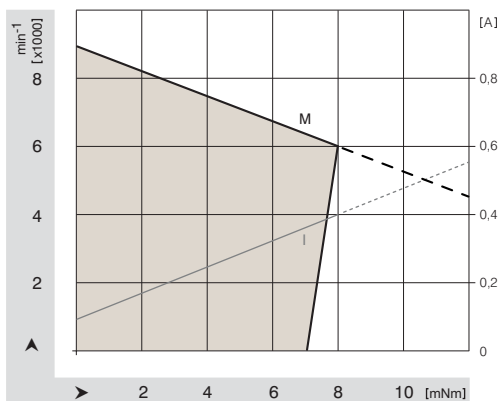

Blind holes for self threading screws with nominal diameter of 3,0 mm.

VARIODRIVE-Motor

VD-3-35.06



- 3-phase, 6-pulse external rotor motor.
- EC technology.
- Dynamically balanced rotor with 4-pole, plastic-bonded ferrite magnet.
- Determination of rotor position via 3 Hall sensors.
- Motor supply and control via external operating electronics.
- Customer-specific winding layout and / or motor part sets available on request.

Nominal Data

Type		VD-3-35.06	...010
Nominal voltage (U_{BN})	V DC	24	24
Nominal speed (n_N)	min ⁻¹	7 500	3 700
Nominal torque (M_N)	mNm	20	20
Nominal current (I_{BN})	A	1.25	0.8
Nominal output power (P_N)	W	16	8
Free-running speed (n_L)	min ⁻¹	11 000	7 100
Free-running current (I_{BL})	A	0.25	0.16
Permanent stall torque (M_{BN0})	mNm	16	16
Permissible eff. stall current, motor lead (I_{n0eff})	A	1.0	0.6
Permissible permanent input power at stall (P_{BN0})	W	5.0	5.0
Short-term permiss. peak torque (M_{max})	mNm	69	69
Permiss. peak current, motor lead (I_{max})	A	4.0	2.5
Induced voltage (U_{imax})	V/1000min ⁻¹	2.19	3.52
Terminal resistance	Ω	3,7	9.4
Terminal inductance	mH	2.5	6.4
Rotor moment of inertia (J_R)	kgm ² x10 ⁻⁶	16	16
Thermal resistance (R_{th})	K/W	5.2	7.0
Protection class		IP 00	IP 00
Ambient temperature range (T_U)	°C	0 ... +40	0 ... +40
Motor mass (m)	kg	0.120	0.120
Order No.		937 3506 000	937 3506 010

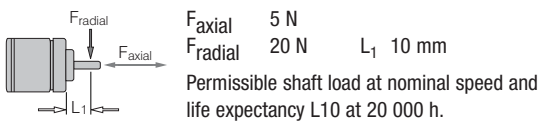

Operating electronics for speed-controlled operation:

for Order No. 937 3506 000 = DRIVECONTROL VT-A / Order No. 937 1201 001
 for Order No. 937 3506 010 = DRIVECONTROL VT-A / Order No. 937 1201 002

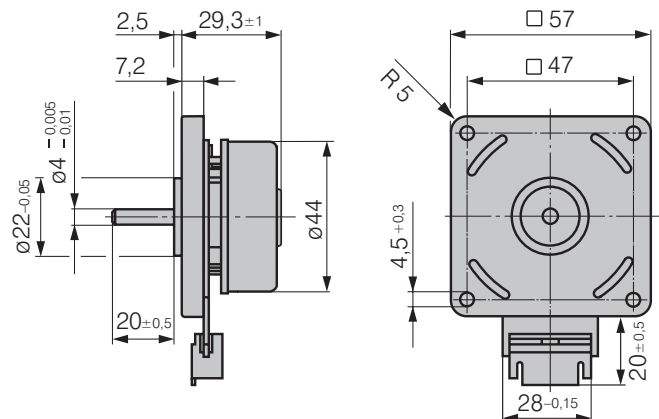
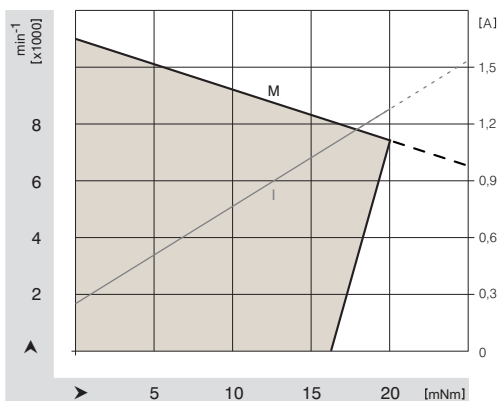

VARIODRIVE-Motor

VD-3-43.10



- 3-phase, 6-pulse external rotor motor.
- EC technology.
- Dynamically balanced rotor with 4-pole, plastic-bonded ferrite magnet.
- Determination of rotor position via 3 Hall sensors.
- Motor supply and control via external operating electronics.
- Customer-specific winding layout and / or motor part sets available on request.

Nominal Data

Type		VD-3-43.10	...010
Nominal voltage (U_{BN})	V DC	24	24
Nominal speed (n_N)	min ⁻¹	7 900	3 700
Nominal torque (M_N)	mNm	53	54
Nominal current (I_{BN})	A	2.7	1.6
Nominal output power (P_N)	W	44	21
Free-running speed (n_L)	min ⁻¹	10 200	8 000
Free-running current (I_{BL})	A	0.27	0.18
Permanent stall torque (M_{BN0})	mNm	50	49
Permissible eff. stall current, motor lead (I_{n0eff})	A	2.7	1.8
Permissible permanent input power at stall (P_{BN0})	W	10	10
Short-term permiss. peak torque (M_{max})	mNm	110	110
Permiss. peak current, motor lead (I_{max})	A	6.5	4.2
Induced voltage (U_{imax})	V/1000min ⁻¹	2.03	3.07
Terminal resistance	Ω	0.96	2.3
Terminal inductance	mH	1.55	3.5
Rotor moment of inertia (J_R)	kgm ² x10 ⁻⁶	40	40
Thermal resistance (R_{th})	K/W	4.11	4.75
Protection class		IP 00	IP 00
Ambient temperature range (T_U)	°C	0 ... +40	0 ... +40
Motor mass (m)	kg	0.24	0.24
Order No.		937 4310 000	937 4310 010

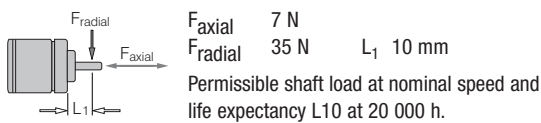

Operating electronics for speed-controlled operation:

for Order No. 937 4310 000 = DRIVECONTROL VT-A / Order No. 937 1401 001
 for Order No. 937 4310 010 = DRIVECONTROL VT-A / Order No. 937 1401 002

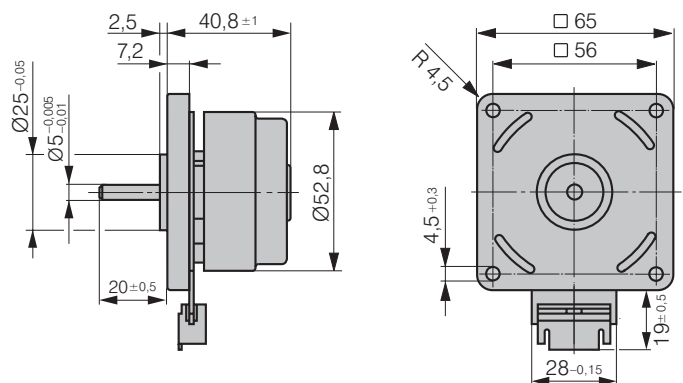
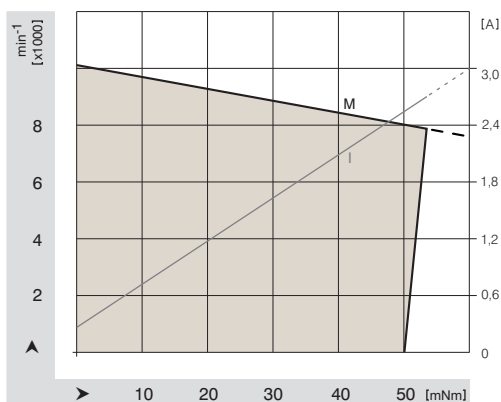

VARIODRIVE-Motor

VD-3-54.14



- 3-phase, 6-pulse external rotor motor.
- EC technology.
- Dynamically balanced rotor with 4-pole, plastic-bonded ferrite magnet.
- Determination of rotor position via 3 Hall sensors.
- Motor supply and control via external operating electronics.
- Customer-specific winding layout and / or motor part sets available on request.

Nominal Data

Type		VD-3-54.14	...010	...005
Nominal voltage (U_{BN})	V DC	24	24	24
Nominal speed (n_N)	min ⁻¹	5 600	3 700	6 200
Nominal torque (M_N)	mNm	150	150	150
Nominal current (I_{BN})	A	5.1	3.6	5.7
Nominal output power (P_N)	W	88	57	97
Free-running speed (n_I)	min ⁻¹	7 100	5 200	7 250
Free-running current (I_{BI})	A	0.41	0.26	0.43
Permanent stall torque (M_{BN0})	mNm	115	115	135
Permissible eff. stall current, motor lead (I_{n0eff})	A	4.4	3.1	5.4
Permissible permanent input power at stall (P_{BN0})	W	13	13	13
Short-term permiss. peak torque (M_{max})	mNm	400	400	440
Permiss. peak current, motor lead (I_{max})	A	15	10	20
Induced voltage (U_{imax})	V/1000min ⁻¹	3.06	4.38	2.95
Terminal resistance	Ω	0.49	0.96	0.33
Terminal inductance	mH	1.00	2.00	0.72
Rotor moment of inertia (J_R)	kgm ² x10 ⁻⁶	145	145	165
Thermal resistance (R_{th})	K/W	2.5	3.0	2.4
Protection class		IP 00	IP 00	IP 00
Ambient temperature range (T_U)	°C	0 ... +40	0 ... +40	0 ... +40
Motor mass (m)	kg	0.52	0.52	0.52
Order No.		937 5414 000	937 5414 010	937 5414 005

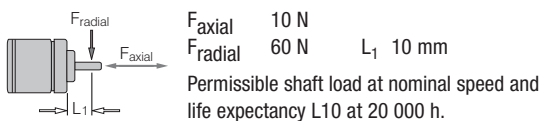

Operating electronics for speed-controlled operation:

for Order No. 937 5414 000 = DRIVECONTROL VT-A / Order No. 937 2501 001
 for Order No. 937 5414 010 = DRIVECONTROL VT-A / Order No. 937 2501 002
 for Order No. 937 5414 005 = DRIVECONTROL VT-D on request

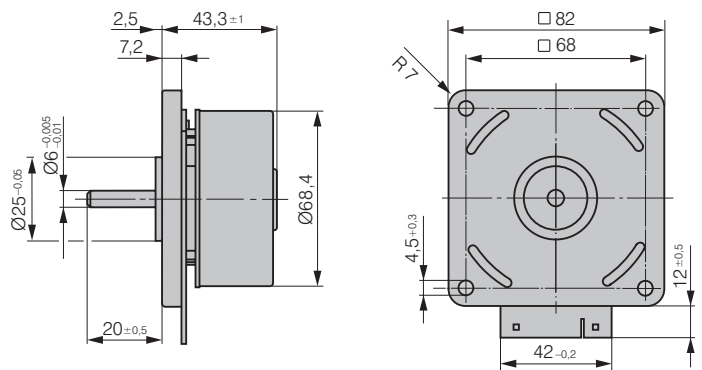
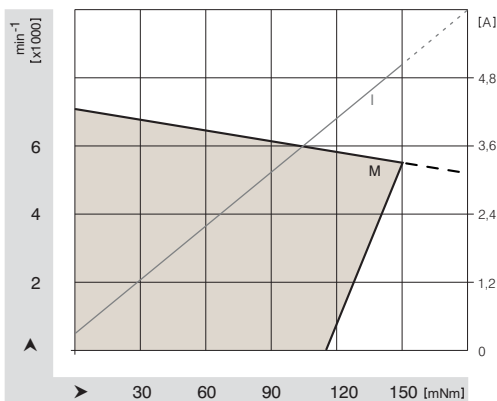

VARIODRIVE Compact-Motor

VDC-3-43.10



- 3-phase external rotor motor in EC technology.
- Dynamically balanced rotor with 4-pole, plastic-bonded ferrite magnet.
- Integrated operating electronics with powerful microcontroller.
- Excellent control response due to digital 4-Q PI controller.
- High operating efficiency due to FET power stage.
- Analogue set value.
- Operating mode selection (direction of rotation, braking and motor enable) via 2 control inputs.
- Protection against overload due to integrated, speed-dependent current limiting.
- Customer-specific version possible based on software and hardware adaption (e.g. fixed speed, direction of rotation).

Nominal Data

Type		VDC-3-43.10	...610
Nominal voltage (U_{BN})	V DC	24 (18 ... 28)	24 (18 ... 28)
Nominal speed (n_N)	min ⁻¹	6 800	4 000
Nominal torque (M_N)	mNm	45	45
Nominal current (I_{BN})	A	2.0	1.25
Nominal output power (P_N)	W	32	18.8
Free-running speed (n_U)	min ⁻¹	10 200	4 080
Free-running current (I_{BL})	A	0.4	0.14
Max. reverse voltage	V DC	40	40
Set value input	V	0 ... 10	0 ... 10
Desired speed	min ⁻¹	0 ... 10 000	0 ... 4 000
Recommended speed control range	min ⁻¹	300 ... n_{max}	300 ... n_{max}
Function for motor protection at stall		yes	yes
by stall protection pulsing		$T_{on} 0.8 / T_{off} 2.5$ s	$T_{on} 0.8 / T_{off} 2.5$ s
Overload protection		yes	yes
Average starting torque	mNm	67	67
Rotor moment of inertia (J_R)	kgm ² x10 ⁻⁶	40	40
Thermal resistance (R_{th})	K/W	3.6	4.1
Protection class		IP 00	IP 00
Ambient temperature range (T_U)	°C	0 ... +40	0 ... +40
Motor mass (m)	kg	0.24	0.24
Order No.		937 4310 600	937 4310 610

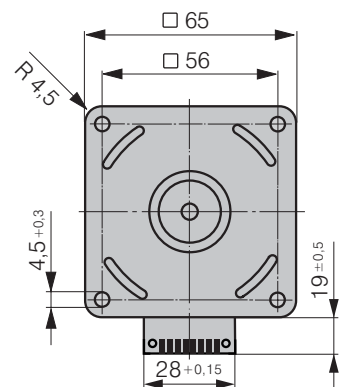
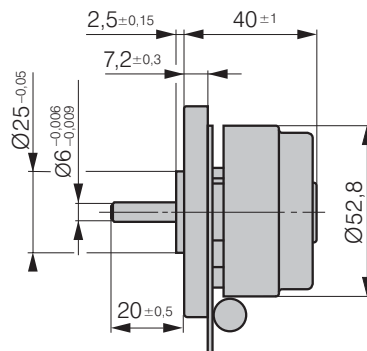
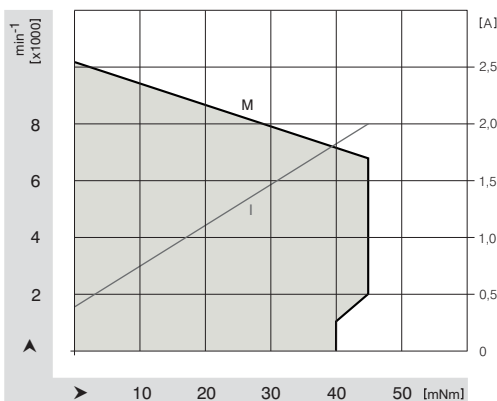
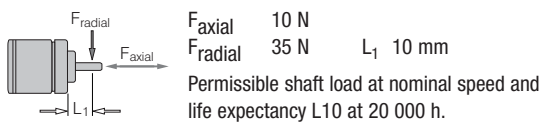

Permissible S1 operating characteristics

Order No. 937 4310 600

Speed n (min^{-1})	300	1000	2000	4000	5000
Torque M (mNm)	40	40	46	45	45
Input power $P_{S1 \text{ max}}$ (W)	7	11	19	30	45

Order No. 937 4310 610

Speed n (min^{-1})	300	1000	2000	4000
Torque M (mNm)	40	45	45	45
Input power $P_{S1 \text{ max}}$ (W)	10	15	20	30

Pin connection

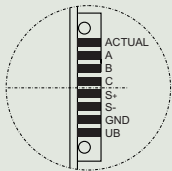

ACTUAL	ACTUAL Speed value
A	Input A
B	Input B
C	Not connected

S+	Set value
S-	Ground set value
GND	Ground
+UB	Supply voltage

1. Control inputs

A	B	
0	0	Power stage disabled
0	1	Counterclockwise rotation
1	0	Clockwise rotation
1	1	Brake function*

low (0) 0 ... 0.8 V
high (1) 2.4 ... 30 V

* Brake function:
The braking function serves to slow down the motor only. It has no holding brake function for static duty.

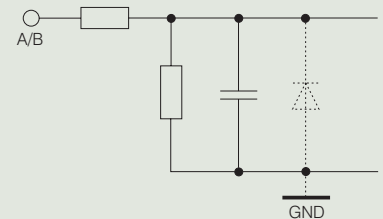

2. Actual speed value output

Version:

Open Collector
 $U_{\text{ext. max}} = 30 \text{ V}$
 $U_{\text{CESAT}} = 0.5 \text{ V}$
 $I_{\text{CMAX}} = 5 \text{ mA}$

Output signal

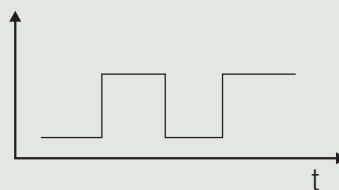

100 Hz = 1000 min^{-1}

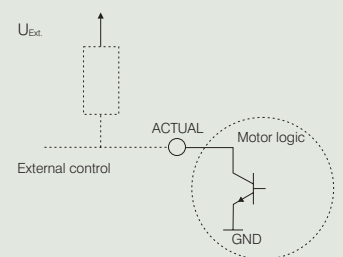

3. Set value

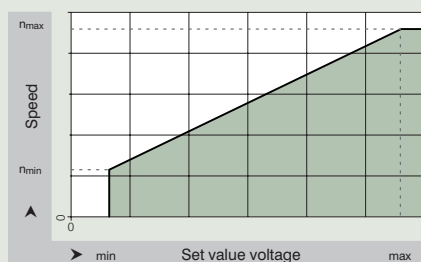

Speed setting for speed control via set value voltage (interface 0 ... 10 V DC).

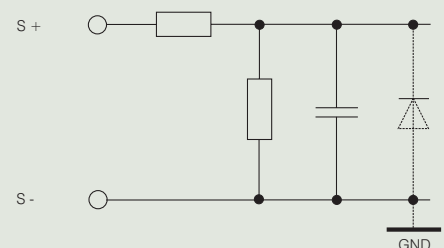

For detailed information, please refer to the corresponding specification data sheets. The instructions and safety notes in the operating manual must be kept at all times.

VARIODRIVE Compact-Motor

VDC-3-54.14



- 3-phase external rotor motor in EC technology.
- Dynamically balanced rotor with 4-pole, plastic-bonded ferrite magnet.
- Integrated operating electronics with powerful microcontroller.
- Excellent control response due to digital 4-Q PI controller.
- High operating efficiency due to FET power stage.
- Analogue set value.
- Operating mode selection (direction of rotation, braking and motor enable) via 2 control inputs.
- Protection against overload due to integrated, speed-dependent current limiting.
- Customer-specific version possible based on software and hardware adaption (e.g. fixed speed, direction of rotation).

Nominal Data

Type		VDC-3-54.14	...620
Nominal voltage (U_{BN})	V DC	24 (18 ... 28)	24 (18 ... 28)
Nominal speed (n_N)	min ⁻¹	6 000	3 500
Nominal torque (M_N)	mNm	100	100
Nominal current (I_{BN})	A	3.6	2.8
Nominal output power (P_N)	W	62.8	47.6
Free-running speed (n_U)	min ⁻¹	8 000	4 000
Free-running current (I_{BL})	A	0.51	0.21
Max. reverse voltage	V DC	40	40
Set value input	V	0 ... 10	0 ... 10
Desired speed	min ⁻¹	0 ... 10 000	0 ... 4 000
Recommended speed control range	min ⁻¹	300 ... n_{max}	300 ... n_{max}
Function for motor protection at stall		yes	yes
by stall protection pulsing		$T_{on} 0.8 / T_{off} 2.5$ s	$T_{on} 0.8 / T_{off} 2.5$ s
Overload protection		yes	yes
Average starting torque	mNm	120	120
Rotor moment of inertia (J_R)	kgm ² x10 ⁻⁶	145	145
Thermal resistance (R_{Th})	K/W	2.5	3.0
Protection class		IP 00	IP 00
Ambient temperature range (T_U)	°C	0 ... +40	0 ... +40
Motor mass (m)	kg	0.52	0.52
Order No.		937 5414 622	937 5414 620

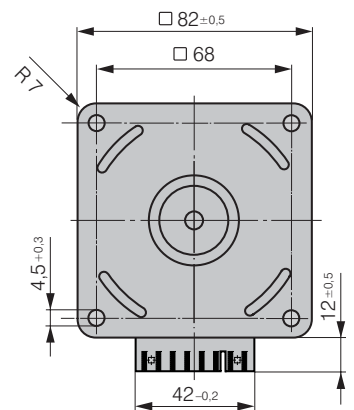
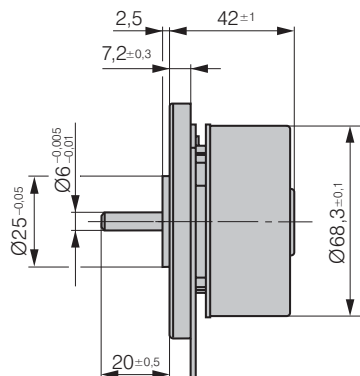
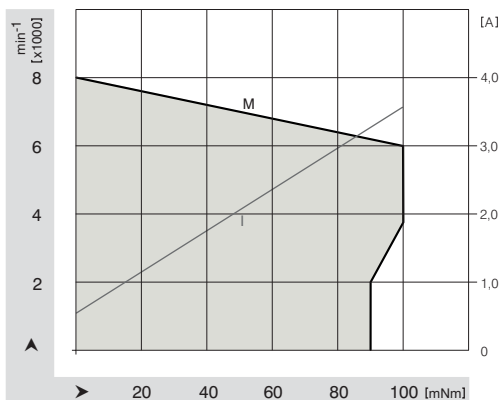
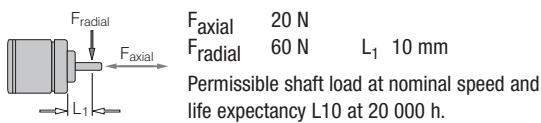

Permissible S1 operating characteristics

Order No. 937 5414 622

Speed n (min^{-1})	300	1000	2000	4000	6000
Torque M (mNm)	90	90	90	100	100
Input power $P_{S1 \text{ max}}$ (W)	14	22	33	63	88

Order No. 937 5414 620

Speed n (min^{-1})	300	1000	2000	4000
Torque M (mNm)	110	110	120	130
Input power $P_{S1 \text{ max}}$ (W)	14	23	40	70

Pin connection

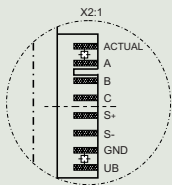

ACTUAL	ACTUAL Speed value	S+	Set value
A	Input A	S-	Ground set value
B	Input B	GND	Ground
C	Not connected	+UB	Supply voltage

1. Control inputs

A	B	
0	0	Power stage disabled
0	1	Counterclockwise rotation
1	0	Clockwise rotation
1	1	Brake function*

low (0) 0 ... 0.8 V
high (1) 2.4 ... 3.0 V

* Brake function:
The braking function serves to slow down the motor only. It has no holding brake function for static duty.

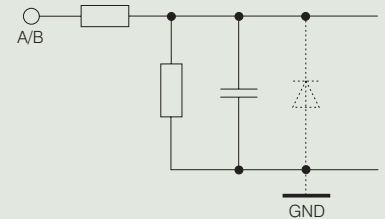

2. Actual speed value output

Version:
Open Collector
 $U_{\text{ext. max}} = 30 \text{ V}$
 $U_{\text{CESAT}} = 0.5 \text{ V}$
 $I_{\text{CMAX}} = 5 \text{ mA}$

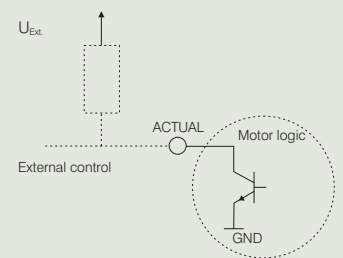
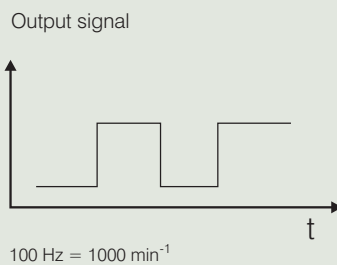

3. Set value

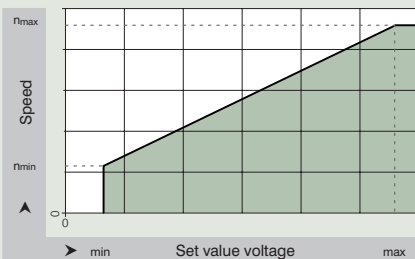

Speed setting for speed control via set value voltage (interface 0 ... 10 V DC).

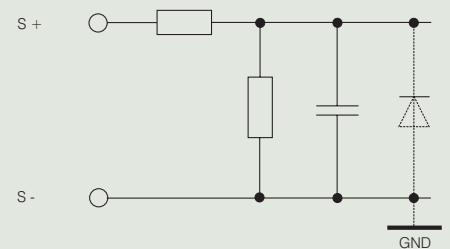

For detailed information, please refer to the corresponding specification data sheets. The instructions and safety notes in the operating manual must be kept at all times.

VARIODRIVE Compact Small-Motor

VDCS-3-54.14

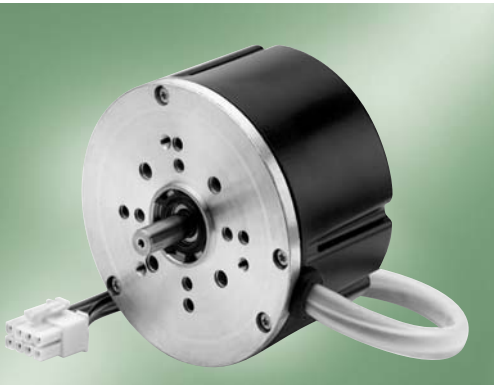

- 3-phase external rotor motor in EC technology.
- Dynamically balanced rotor with 4-pole, plastic-bonded ferrite magnet.
- Integrated operating electronics for open loop speed-controlled operation.
- Analogue set value for open loop speed control.
- Direction of rotation setting via control input.
- Protection against overload due to integrated, speed-dependent current limiting.

Nominal Data

Type	VDCS-3-54.14	
Nominal voltage (U_{BN})	V DC	24 (18 ... 28)
Nominal speed (n_N)	min ⁻¹	6 000
Nominal torque (M_N)	mNm	90
Nominal current (I_{BN})	A	3.3
Nominal output power (P_N)	W	56.5
Free-running speed (n_L)	min ⁻¹	7 800
Free-running current (I_{BL})	A	0.51
Max. reverse voltage	V DC	-
Set value input	V	0 ... 10
Function for motor protection at stall		optional
Overload protection		yes
Average starting torque	mNm	80
Rotor moment of inertia (J_R)	kgm ² x10 ⁻⁶	145
Thermal resistance (R_{th})	K/W	-
Protection class		IP 40
Ambient temperature range (T_U)	°C	0 ... +40
Motor mass (m)	kg	0.72
Order No.		937 5414 800

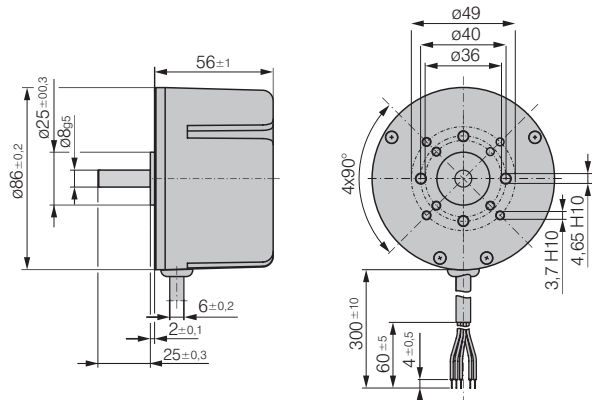
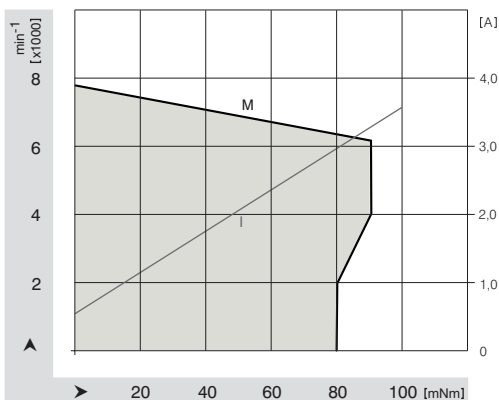
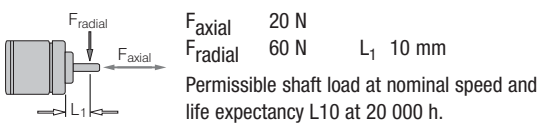

Permissible S1 operating characteristics

Order No. 937 5414 800

Speed n (min^{-1})	300	1000	2000	4000	5000
Torque M (mNm)	80	80	80	90	90
Input power $P_{S1 \text{ max}}$ (W)	12	19	29	56	80

Pin connection

Yellow	Ist	ACTUAL Speed value
White	A	Input A
Green	S+	Set value input
Black	GND	Ground
Red	+Ub	Supply voltage

1. Control inputs

A	
0	Counterclockwise rotation*
1	Clockwise rotation*
low (0)	0 ... 0.8 V
high (1)	2.4 ... 30 V

*Change in direction of rotation only allowed at standstill!

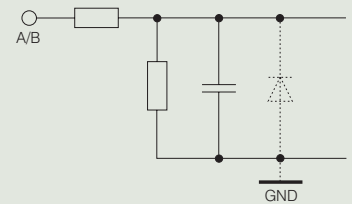

2. Actual speed value output

Version:

Open Collector
 $U_{\text{ext. max}} = 30 \text{ V}$
 $U_{\text{CESAT}} = 0.5 \text{ V}$
 $I_{\text{CMAX}} = 5 \text{ mA}$

Output signal

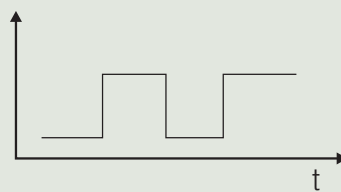

100 Hz = 1000 min^{-1}

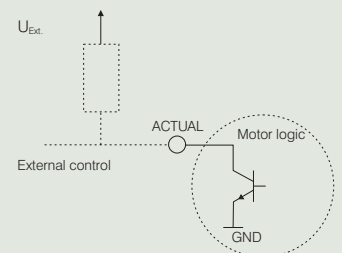

3. Set value input

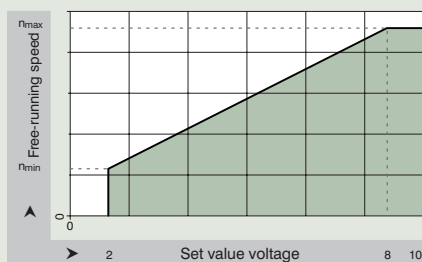

Speed setting for open loop speed control via control voltage (0 ... 10 V DC).

interface:

< 2 V = 0% PWM
 8 V = 100% PWM

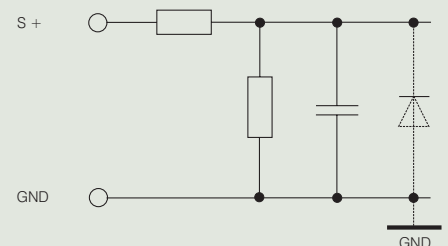

For detailed information, please refer to the corresponding specification data sheets. The instructions and safety notes in the operating manual must be kept at all times.

VARIODRIVE Compact-Motor

VDC-3-54.32



- 3-phase external rotor motor in EC technology.
- Dynamically balanced rotor with 4-pole, plastic-bonded ferrite magnet.
- Integrated operating electronics with powerful microcontroller.
- Excellent control response due to digital 4-Q PI controller.
- High operating efficiency due to FET power stage.
- Analogue set value.
- Operating mode selection (direction of rotation, braking and motor enable) via 2 control inputs.
- Protection against overload due to integrated, speed-dependent current limiting.
- Customer-specific version possible based on software and hardware adaption (e.g. fixed speed, direction of rotation).

Nominal Data

Type	VDC-3-54.32	
Nominal voltage (U_{BN})	V DC	24 (18 ... 28)
Nominal speed (n_N)	min ⁻¹	3 300
Nominal torque (M_N)	mNm	240
Nominal current (I_{BN})	A	4.3
Nominal output power (P_N)	W	83
Free-running speed (n_U)	min ⁻¹	4 100
Free-running current (I_{BL})	A	0.5
Max. reverse voltage	V DC	40
Set value input	V	0 ... 10
Desired speed	min ⁻¹	0 ... 4 000
Recommended speed control range	min ⁻¹	300 ... n_{max}
Function for motor protection at stall		yes
by stall protection pulsing		$T_{on} 0.8 / T_{off} 2.5$ s
Overload protection		yes
Average starting torque	mNm	280
Rotor moment of inertia (J_R)	kgm ² x10 ⁻⁶	500
Thermal resistance (R_{th})	K/W	2.15
Protection class		IP 40
Ambient temperature range (T_U)	°C	0 ... +40
Motor mass (m)	kg	1.1
Order No.		937 5432 610

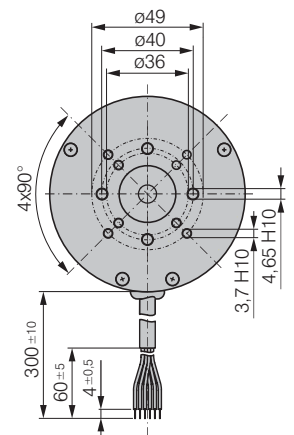
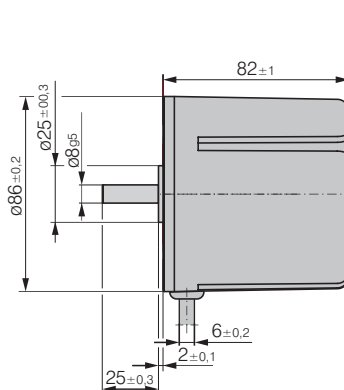
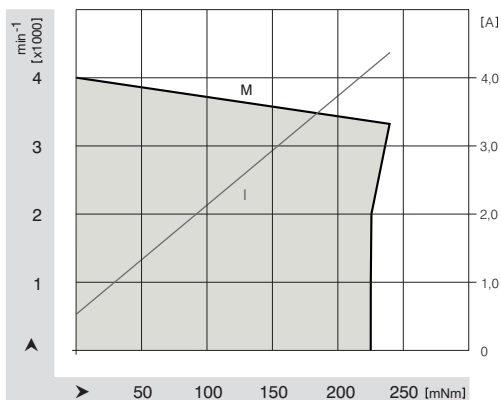
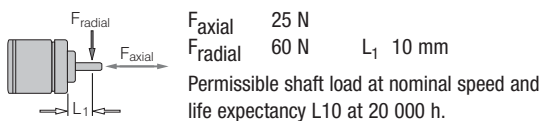

Permissible S1 operating characteristics

Order No. 937 5432 610

Speed n (min^{-1})	300	1000	2000	3300
Torque M (mNm)	225	225	225	240
Input power $P_{s1 \text{ max}}$ (W)	31	50	70	115

Pin connection

Yellow	ACTUAL	ACTUAL Speed value
White	A	Input A
Grey	B	Input B
–	C	Not connected

Green	S+	Set value
–	S-	Ground set value
Black	GND	Ground
Red	+Ub	Supply voltage

1. Control inputs

A	B	
0	0	Power stage disabled
0	1	Counterclockwise rotation
1	0	Clockwise rotation
1	1	Brake function*

low (0)	0 ... 0.8 V
high (1)	2.4 ... 30 V

* Brake function:
The braking function serves to slow down the motor only. It has no holding brake function for static duty.

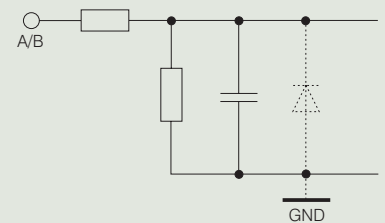

2. Actual speed value output

Version:

Open Collector
 $U_{\text{ext. max}} = 30 \text{ V}$
 $U_{\text{CESAT}} = 0.5 \text{ V}$
 $I_{\text{CMAX}} = 5 \text{ mA}$

Output signal

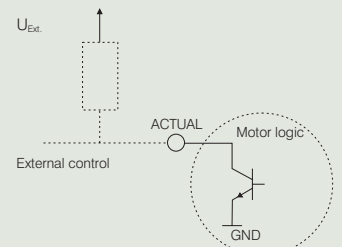
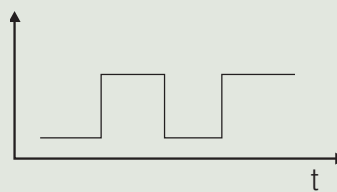

3. Set value

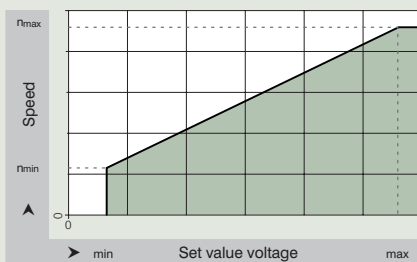

Speed setting for speed control via set value voltage (interface 0 ... 10 V DC).

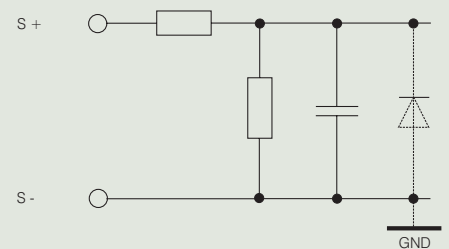

For detailed information, please refer to the corresponding specification data sheets. The instructions and safety notes in the operating manual must be kept at all times.

VARIODRIVE Compact

Gear motor VDC-3-43.10-C

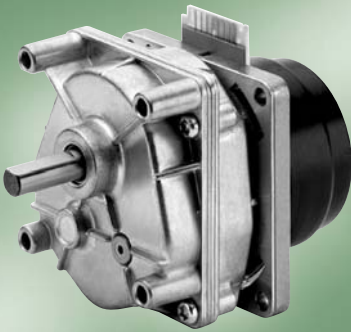

- 3-phase external rotor motor in EC technology for gear applications.
- Dynamically balanced rotor with 4-pole, plastic-bonded ferrite magnet.
- Integrated operating electronics with powerful microcontroller.
- Excellent control response due to digital 4-Q PI controller.
- Analogue set value.
- Available in various reduction ratios.
- Motor mass 0.55 kg.

Nominal Data	Gear ratio	Nominal torque	Speed range	Order No.
Type VDC	i	Nm	min ⁻¹	
VDC-3-43.10-C 16	16.0 : 1	0.6	19 ... 250	947 4310 600
VDC-3-43.10-C 22	22.9 : 1	0.8	13 ... 175	947 4310 601
VDC-3-43.10-C 32	32.0 : 1	1.2	9 ... 125	947 4310 602
VDC-3-43.10-C 45	45.4 : 1	1.5	7 ... 88	947 4310 603
VDC-3-43.10-C 58	57.8 : 1	1.9	5 ... 69	947 4310 604
VDC-3-43.10-C 79	79.1 : 1	2.6	4 ... 51	947 4310 605
VDC-3-43.10-C 122	121.6 : 1	4.0	2 ... 33	947 4310 606

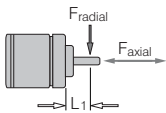

F_{axial} 40 N
 F_{radial} 120 N L_1 17 mm
 Permissible shaft load at nominal speed.

Gear type C

Multi-stage spur gear in zinc diecast body.
 Grease lubrication for maintenance-free continuous operation.
 Shaft output with combined sleeve / needle bearing.
 Reversible direction of rotation.

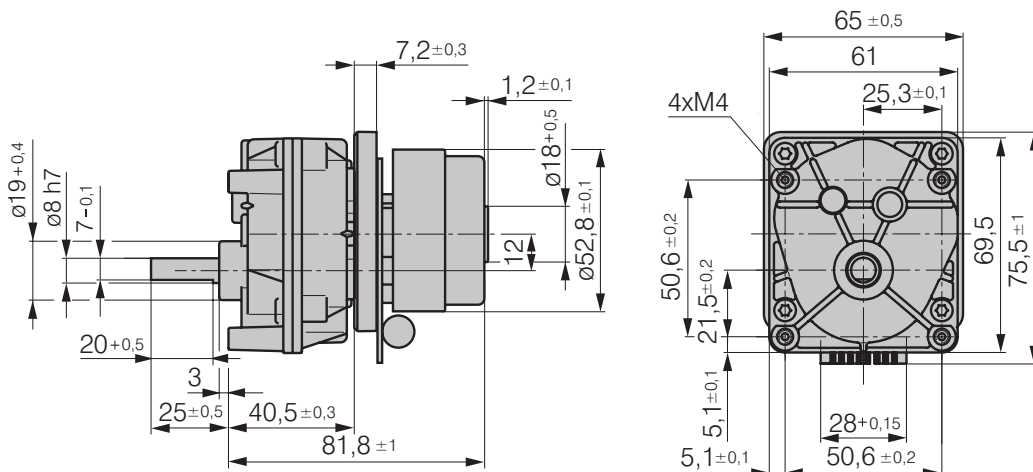

Gear motor VD-3-43.10-C

Motor variation with external operating electronics

- 3-phase, 6-pulse external rotor motor for gear applications.
- EC technology.
- Dynamically fine-balanced rotor with 4-pole, plastic-bonded ferrite magnet.
- Determination of rotor position via 3 Hall sensors.
- Motor supply and control via external operating electronics.

Nominal Data	Gear ratio	Nominal torque	Speed range	Order No.
Type VD	i	Nm	min ⁻¹	
VD-3-43.10-C 16	16 : 1	0.8	22 ... 215	947 4310 000
VD-3-43.10-C 22	22.9 : 1	1.1	15 ... 150	947 4310 001
VD-3-43.10-C 32	32 : 1	1.0	11 ... 110	947 4310 002
VD-3-43.10-C 45	45.4 : 1	2.0	8 ... 77	947 4310 003
VD-3-43.10-C 58	57.8 : 1	2.5	6 ... 60	947 4310 004
VD-3-43.10-C 79	79.1 : 1	3.4	5 ... 44	947 4310 005
VD-3-43.10-C 122	121.6 : 1	5.3	3 ... 28	947 4310 006

Operating electronics:

DRIVECONTROL VT-A / Order No. 937 1401 002

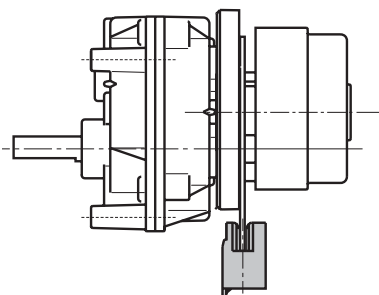

Type VD-3-43.10 with AMP-plug (see basic motor page 12). Dimensional drawing for gear motor see page 22.

VARIODRIVE Compact

Gear motor VDC-3-43.10-D



- 3-phase external rotor motor in EC technology for gear applications.
- Dynamically balanced rotor with 4-pole, plastic-bonded ferrite magnet.
- Integrated operating electronics with powerful microcontroller.
- Excellent control response due to digital 4-Q PI controller.
- Analogue set value.
- Available in various reduction ratios.
- Motor mass 0.62 kg.

Nominal Data	Gear ratio	Nominal torque	Speed range	Order No.
Type VDC	i	Nm	min ⁻¹	
VDC-3-43.10-D 11	11.3 : 1	0.4	27 ... 354	947 4310 610
VDC-3-43.10-D 13	13.2 : 1	0.5	23 ... 303	947 4310 611
VDC-3-43.10-D 16	15.9 : 1	0.6	19 ... 252	947 4310 612
VDC-3-43.10-D 26	26.4 : 1	1.0	11 ... 152	947 4310 613
VDC-3-43.10-D 38	38.6 : 1	1.4	8 ... 104	947 4310 614

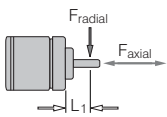

F_{axial} 50 N
 F_{radial} 150 N L_1 17 mm
 Permissible shaft load at nominal speed.

Gear type D

Multi-stage spur gear in zinc diecast body.
 Grease lubrication for maintenance-free continuous operation.
 Shaft output with combined sleeve / needle bearing.
 Reversible direction of rotation.

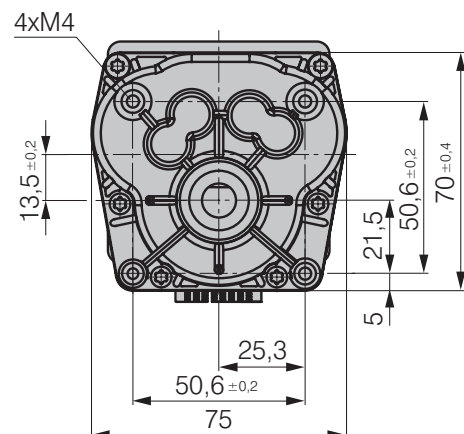
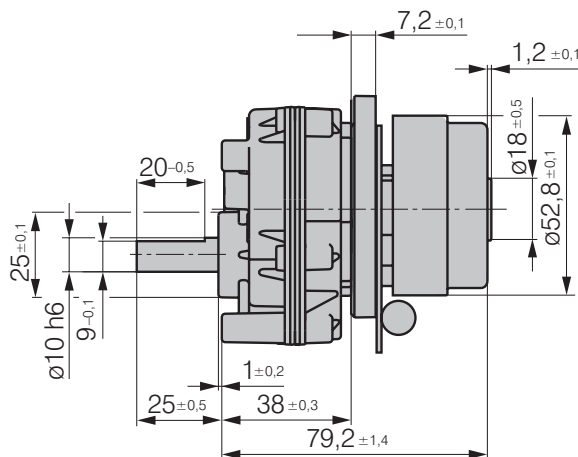

Gear motor VD-3-43.10-D

Motor variation with external operating electronics

- 3-phase, 6-pulse external rotor motor for gear applications.
- EC technology.
- Dynamically fine-balanced rotor with 4-pole, plastic-bonded ferrite magnet.
- Determination of rotor position via 3 Hall sensors.
- Motor supply and control via external operating electronics.

Nominal Data	Gear ratio	Nominal torque	Speed range	Order No.
Type VD	i	Nm	min ⁻¹	
VD-3-43.10-D 11	11.3 : 1	0.5	31 ... 310	947 4310 010
VD-3-43.10-D 13	13.2 : 1	0.6	27 ... 265	947 4310 011
VD-3-43.10-D 16	15.9 : 1	0.8	22 ... 220	947 4310 012
VD-3-43.10-D 26	26.4 : 1	1.3	13 ... 130	947 4310 013
VD-3-43.10-D 38	38.6 : 1	1.9	9 ... 90	947 4310 014

Operating electronics:

DRIVECONTROL VT-A / Order No. 937 1401 002

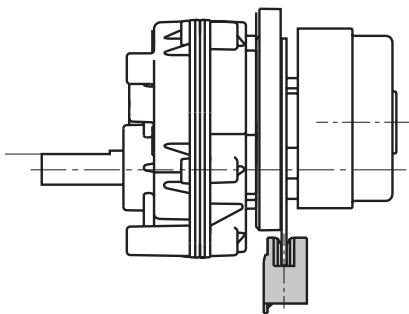

Type VD-3-43.10 with AMP-plug (see basic motor page 12). Dimensional drawing for gear motor see page

VARIODRIVE Compact

Gear motor VDC-3-54.14-C



- 3-phase external rotor motor in EC technology for gear applications.
- Dynamically balanced rotor with 4-pole, plastic-bonded ferrite magnet.
- Integrated operating electronics with powerful microcontroller.
- Excellent control response due to digital 4-Q PI controller.
- Analogue set value.
- Available in various reduction ratios.
- Motor mass 0.83 kg.

Nominal Data	Gear ratio	Nominal torque	Speed range	Order No.
Type VDC	i	Nm	min ⁻¹	
VDC-3-54.14-C 16	16.0 : 1	1.7	19 ... 250	947 5414 600
VDC-3-54.14-C 22	22.9 : 1	2.4	13 ... 175	947 5414 601
VDC-3-54.14-C 32	32.0 : 1	3.4	9 ... 125	947 5414 602
VDC-3-54.14-C 45	45.4 : 1	4.3	7 ... 88	947 5414 603
VDC-3-54.14-C 58	57.8 : 1	5.5	5 ... 69	947 5414 604
VDC-3-54.14-C 79	79.1 : 1	7.0*	4 ... 51	947 5414 605
VDC-3-54.14-C 122	121.6 : 1	7.0*	2 ... 33	947 5414 606

*Monitor torque limitation at max. 7.0 Nm on output side.

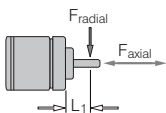

F_{axial} 40 N
 F_{radial} 120 N L_1 17 mm
 Permissible shaft load at nominal speed.

Gear type C

Multi-stage spur gear in zinc diecast body.

Grease lubrication for maintenance-free continuous operation.

Shaft output with combined sleeve / needle bearing.

Reversible direction of rotation.

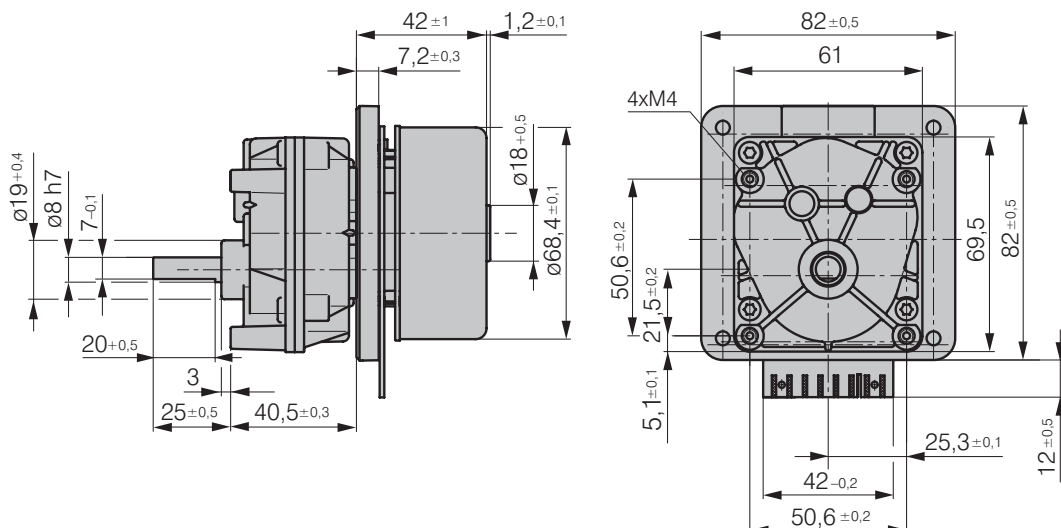

Gear motor VD-3-54.14-C

Motor variation with external operating electronics

- 3-phase, 6-pulse external rotor motor for gear applications.
- EC technology.
- Dynamically fine-balanced rotor with 4-pole, plastic-bonded ferrite magnet.
- Determination of rotor position via 3 Hall sensors.
- Motor supply and control via external operating electronics.

Nominal Data	Gear ratio	Nominal torque	Speed range	Order No.
Type VD	i	Nm	min ⁻¹	
VD-3-54.14-C 16	16.0 : 1	1.8	22 ... 215	947 5414 000
VD-3-54.14-C 22	22.9 : 1	2.6	15 ... 150	947 5414 001
VD-3-54.14-C 32	32.0 : 1	3.6	11 ... 110	947 5414 002
VD-3-54.14-C 45	45.4 : 1	4.6	8 ... 77	947 5414 003
VD-3-54.14-C 58	57.8 : 1	5.9	6 ... 60	947 5414 004
VD-3-54.14-C 79	79.1 : 1	7.0**	5 ... 44	947 5414 005
VD-3-54.14-C 122	121.6 : 1	7.0**	3 ... 28	947 5414 006

**Monitor torque limitation at max. 7.0 Nm output based on current limiting on operating electronics.
DRIVECONTROL VT-A, series 2400.

Operating electronics:

DRIVECONTROL VT-A / Order No. 937 2501 002

DRIVECONTROL VT-A / Order No. 937 2401 002

Dimensions on page 26 dimensional drawing.

VARIODRIVE Compact

Gear motor VDC-3-54.14-D



- 3-phase external rotor motor in EC technology for gear applications.
- Dynamically balanced rotor with 4-pole, plastic-bonded ferrite magnet.
- Integrated operating electronics with powerful microcontroller.
- Excellent control response due to digital 4-Q PI controller.
- Analogue set value.
- Available in various reduction ratios.
- Motor mass 0.90 kg.

Nominal Data	Gear ratio	Nominal torque	Speed range	Order No.
Type VDC	i	Nm	min ⁻¹	
VDC-3-54.14-D 11	11.3 : 1	1.2	27 ... 354	947 5414 610
VDC-3-54.14-D 16	15.9 : 1	1.7	19 ... 252	947 5414 611
VDC-3-54.14-D 26	26.4 : 1	2.8	11 ... 152	947 5414 612
VDC-3-54.14-D 39	38.6 : 1	4.1	8 ... 104	947 5414 613

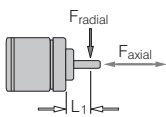

F_{axial} 50 N
 F_{radial} 150 N L_1 17 mm
 Permissible shaft load at nominal speed.

Gear type D

Multi-stage spur gear in zinc diecast body.
 Grease lubrication for maintenance-free continuous operation.
 Shaft output with combined sleeve / needle bearing.
 Reversible direction of rotation.

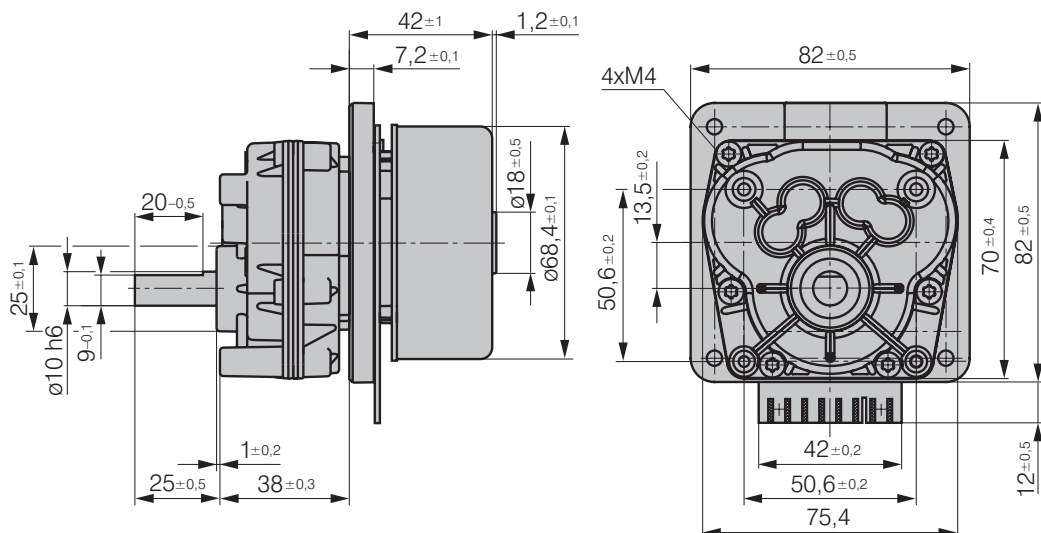

Gear motor VD-3-54.14-D

Motor variation with external operating electronics

- 3-phase, 6-pulse external rotor motor for gear applications.
- EC technology.
- Dynamically fine-balanced rotor with 4-pole, plastic-bonded ferrite magnet.
- Determination of rotor position via 3 Hall sensors.
- Motor supply and control via external operating electronics.

Nominal Data	Gear ratio	Nominal torque	Speed range	Order No.
Type VD	i	Nm	min ⁻¹	
VD-3-54.14-D 11	11.3 : 1	1.3	31 ... 310	947 5414 010
VD-3-54.14-D 16	15.9 : 1	1.8	22 ... 220	947 5414 011
VD-3-54.14-D 26	26.4 : 1	3.0	13 ... 130	947 5414 012
VD-3-54.14-D 39	38.6 : 1	4.4	9 ... 90	947 5414 013

Operating electronics:

DRIVECONTROL VT-A / Order No. 937 2501 002

Dimensions on page 28 dimensional drawing.

VARIODRIVE Compact

Gear motor VDC-3-54.32-D



- 3-phase external rotor motor in EC technology for gear applications.
- Dynamically balanced rotor with 4-pole, plastic-bonded ferrite magnet.
- Integrated operating electronics with powerful microcontroller.
- Excellent control response due to digital 4-Q PI controller.
- Analogue set value.
- Available in various reduction ratios.
- Motor mass 1.39 kg.

Nominal Data	Gear ratio	Nominal torque	Speed range	Order No.
Type	i	Nm	min ⁻¹	
VDC-3-54.32-D 9	9.2 : 1	2.0	38 ... 330	947 5432 610
VDC-3-54.32-D 18	18.4 : 1	3.5	19 ... 163	947 5432 611

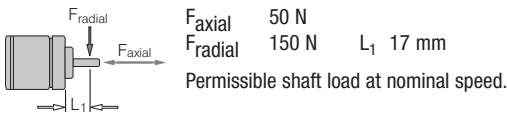

Gear type D

Multi-stage spur gear in zinc diecast body.
 Grease lubrication for maintenance-free continuous operation.
 Shaft output with combined sleeve / needle bearing.
 Reversible direction of rotation.

Color	ACTUAL	ACTUAL Speed value
White	A	Input A
Grey	B	Input B
-	C	Not connected
Green	S+	Set value
-	S-	Ground set value
Black	GND	Ground
Red	+Ub	Supply voltage

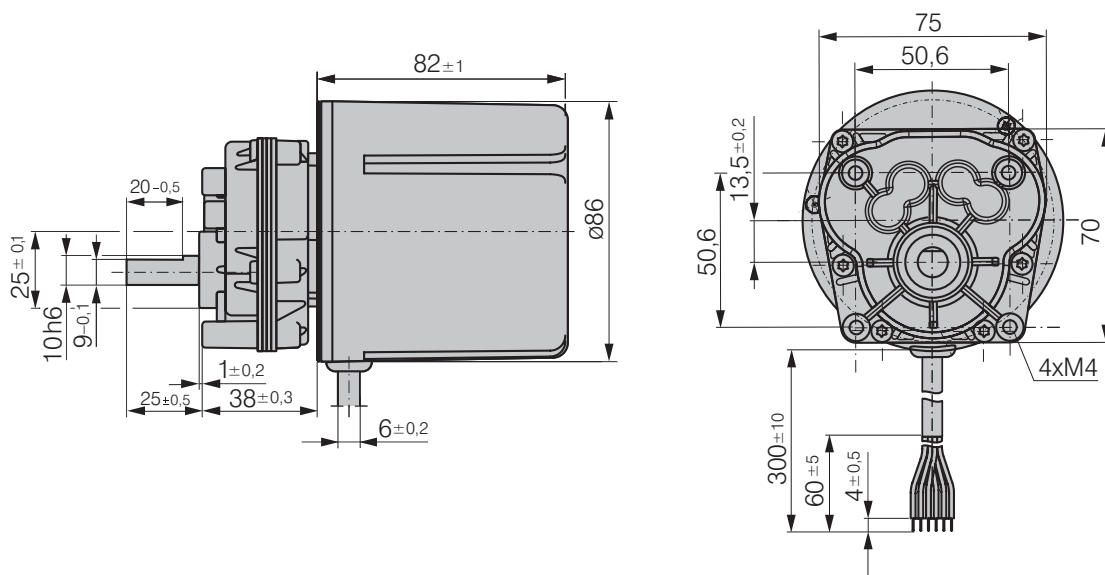

VARIODRIVE Compact

Gear motor VDC-3-54.32-E

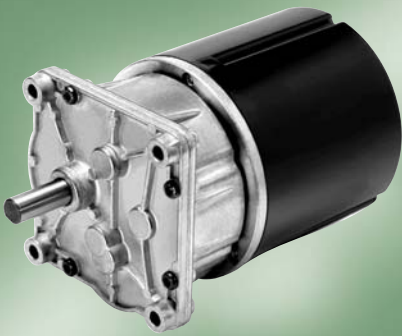

- 3-phase external rotor motor in EC technology for gear applications.
- Dynamically balanced rotor with 4-pole, plastic-bonded ferrite magnet.
- Integrated operating electronics with powerful microcontroller.
- Excellent control response due to digital 4-Q PI controller.
- Analogue set value.
- Available in various reduction ratios.
- Motor mass 1.48 kg.

Nominal Data	Gear ratio	Nominal torque	Speed range	Order No.
Type	i	Nm	min ⁻¹	
VDC-3-54.32-E 31	31.1 : 1	5.9	11 ... 97	947 5432 620
VDC-3-54.32-E 70	70.4 : 1	11.8	5 ... 43	947 5432 621

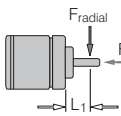

F_{axial} 50 N
 F_{radial} 150 N L_1 17 mm
 Permissible shaft load at nominal speed.

Gear type E

Multi-stage spur gear in zinc diecast body.
 Grease lubrication for maintenance-free continuous operation.
 Shaft output with combined sleeve / needle bearing.
 Reversible direction of rotation.

Yellow	ACTUAL	ACTUAL Speed value
White	A	Input A
Grey	B	Input B
-	C	Not connected
Green	S+	Set value
-	S-	Ground set value
Black	GND	Ground
Rot	+Ub	Supply voltage

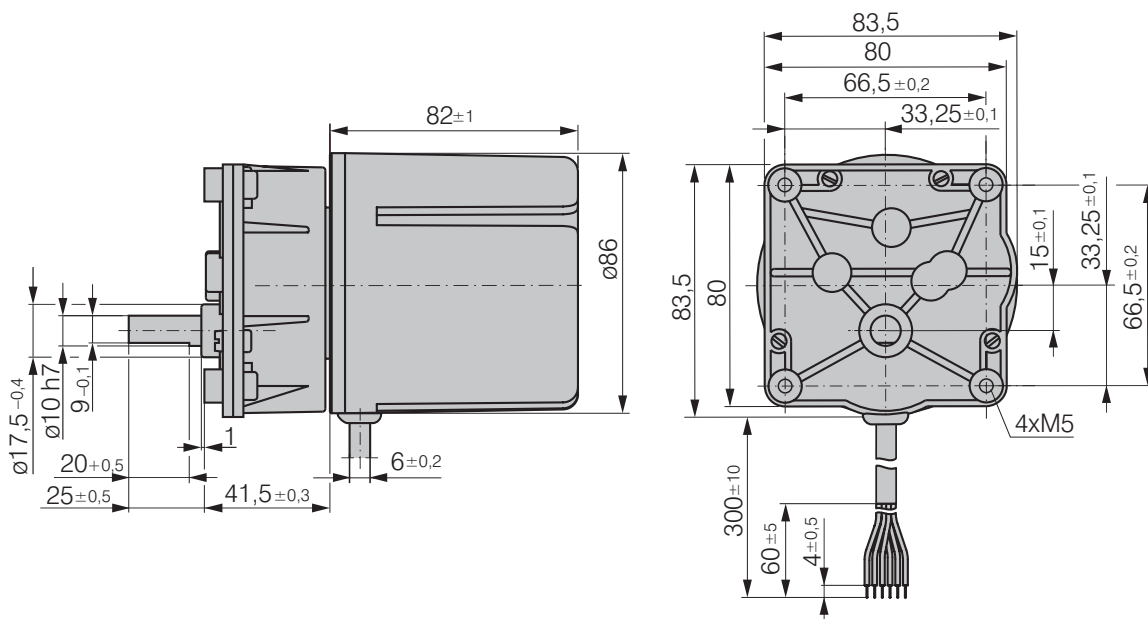

VARIODRIVE Compact

Gear motor VDC-3-54.32-PX



- 3-phase external rotor motor in EC technology for gear applications.
- Dynamically balanced rotor with 4-pole, plastic-bonded ferrite magnet.
- Integrated operating electronics with powerful microcontroller.
- Excellent control response due to digital 4-Q PI controller.
- Analogue set value.
- Available in various reduction ratios.
- Motor mass one stage = 1.5 kg, two stages = 1.7 kg.

Nominal Data	Gear ratio	Gear stages	Nominal torque	Speed range	Order No.
Type	i		Nm	min ⁻¹	
VDC-3-54.32-PX 5	5 : 1	1	1.1	60 ... 660	on request
VDC-3-54.32-PX 30	30 : 1	2	5.8	10 ... 110	on request

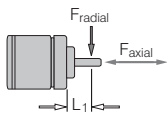

F_{axial} 500 N
 F_{radial} 350 N
 Permissible shaft load at nominal speed and life expectancy L_{10} von 5 000 h.

Gear type PX 52

1 to 2-stage planetary gearbox in zinc diecast housing. Grease lubrication for maintenance free operation. Output shaft with combined needle- / ball bearings.

Optimized helical gearing for long service life and silent running in the first level.

Yellow	ACTUAL	ACTUAL Speed value
White	A	Input A
Grey	B	Input B
-	C	Not connected
Green	S+	Set value
-	S-	Ground set value
Black	GND	Ground
Red	+Ub	Supply voltage

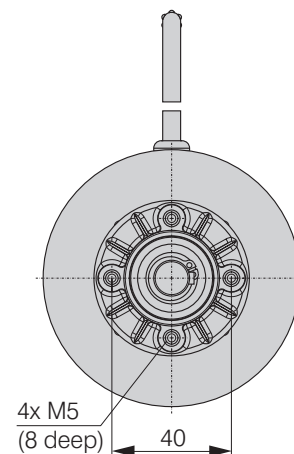
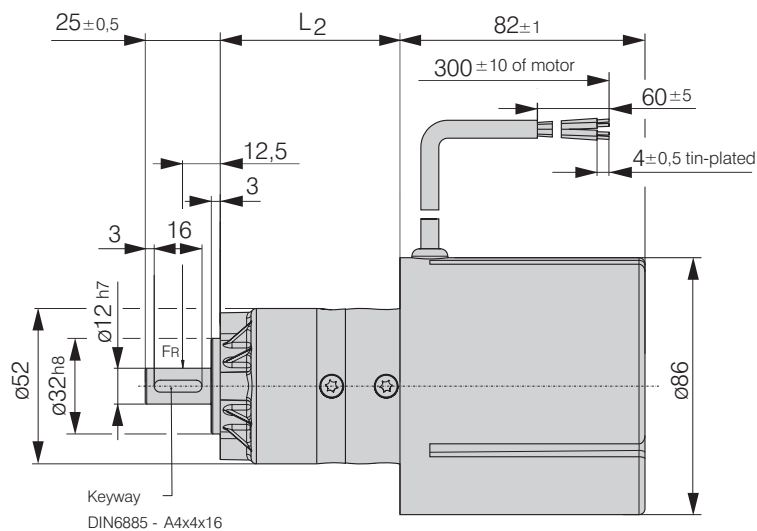

DRIVECONTROL

VT-A series



Operating electronics for driving 3-phase motors of the VARIODRIVE series. Simple OEM electronics for use in series applications. The DRIVECONTROL VT-A is available in 4 different performance levels for speed-controlled or voltage-controlled operation. Only one supply voltage is required for motor and electronics.

Nominal Data

Data	Unit	Voltage controlled	Speed controlled
Nominal voltage	V	24	24
Nominal voltage Range	V	10 ... 30	14 ... 28
Max. output voltage	V	UB - 2 V	UB - 2 V
Output current, peak	A	2 - 5	2 - 5
Set value input	V DC	0 ... 10	0 ... 10
Speed control range	min ⁻¹	–	300 ... 4 000 / 300 ... 10 000
Speed control	Type	–	P
ACTUAL speed value		–	yes
Operating temperature range	°C	0 ... 40 °C	0 ... 40 °C
Temperature monitoring		no	no
Mass	kg	0.2	0.2
Protection class		IP 00	IP 00

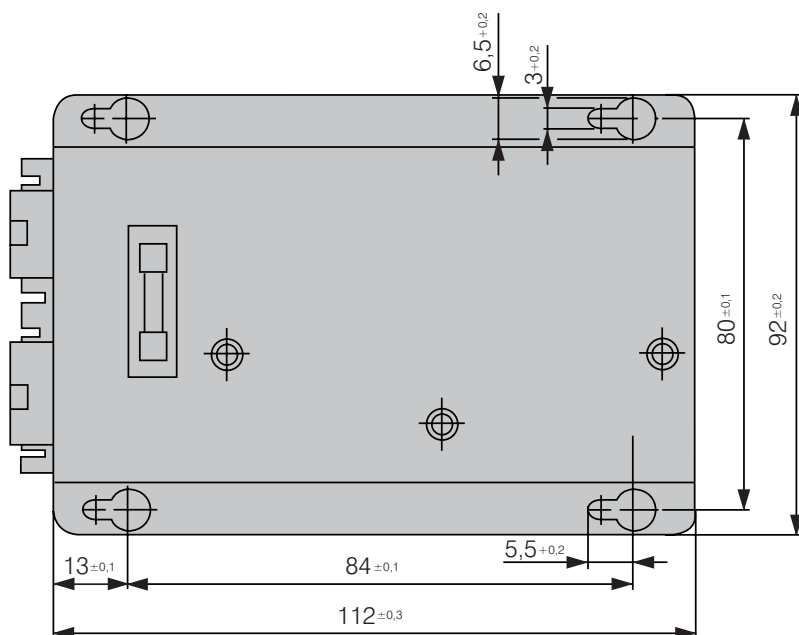

MOLEX-Plug

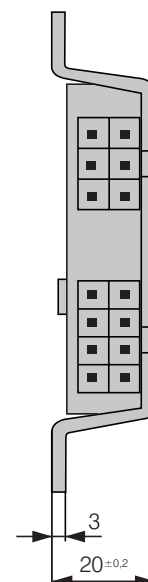

AMP-Plug

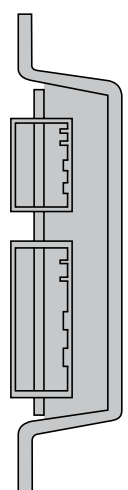

Functions and performance features

- 1 quadrant controller. Positive set value alterations are adjusted by acceleration. Negative set value alterations cause short-circuit braking via the motor winding (increase in intermediate circuit voltage possible!).
- Speed setting via set value input (interface 0...10 V DC).
- Setting of operating modes via 2 control inputs.
- Speed-controlled version with evaluation of Hall signals for ACTUAL speed value monitoring via MF-pin.
- With voltage-controlled (= uncontrolled) version, no braking function and ACTUAL speed value monitoring.
- Fixed limits for current and voltage.
- Voltage supply with input filter, filtering and generation of auxiliary voltage.
- Equipped with PCB plug or Molex plug depending on type of motor.

Pin connection

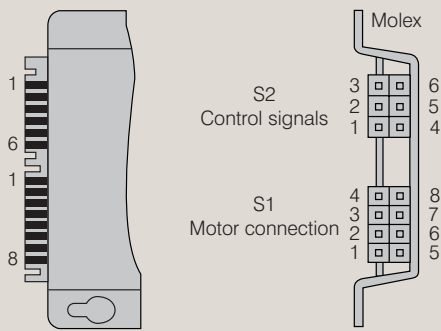

Plug S2

Pin	Type MOLEX	Type AMP
1	GND	MF-Pin
2	A	B
3	ncommand	A
4	+U _B	ncommand
5	B	Gnd
6	MF-Pin	+U _B

Plug S1

Pin	Type MOLEX	Type AMP
1	L 3	+U _{Hall}
2	+U _{Hall}	Gnd _{Hall}
3	RLG 2	RLG 3
4	RLG 1	RLG 2
5	L 2	RLG 1
6	L 1	L 3
7	Gnd _{Hall}	L 2
8	RLG 3	L 1

Voltage controlled version

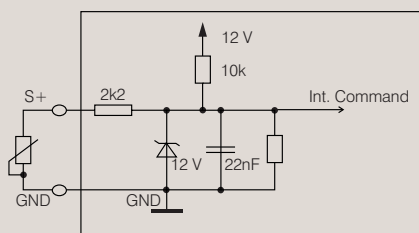

Typical wiring of the reference input with the voltage controlled version. Special features are described in the relevant data sheets.

1. Control inputs

Speed controlled Version

A	B		A	
0	0	Power stage disabled	0	Counterclockwise rotation
0	1	Counterclockwise rotation	1	Clockwise rotation
1	0	Clockwise rotation		Input B is not connected
1	1	Brake function*		

low (0) 0 ... 0.8 V
high (1) 2.4 ... 30 V

* Brake function:

The braking function serves to slow down the motor only. It has no holding brake function for the static duty.

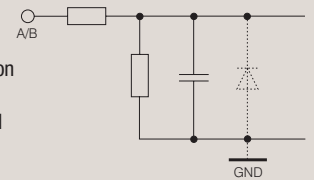

2. Actual speed value output (MF-Pin)

Only with speed-controlled version, open collector that transmits a short pulse at every flange edge of the motor Hall signals!

The illustrated signal sequence for standard assembly is the speed value output.

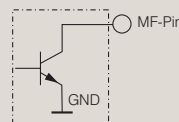
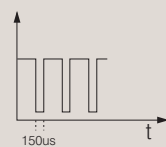

Voltage range U _{CE} :	< 30 V
Max. current I _C :	10 mA
Pull-up resistor:	> 2000 Ohm by 24 V
Puls length:	150 µs
U _{CEsat} :	< 0.8 V

3. Set value

The speed selection is normally made externally with a voltage in the range of 0...10 V DC. A voltage of 10 V is equivalent to the maximum speed determined internally.

With the voltage controlled version of the VT-A, the set value is internally fixed at the maximum value. For reducing the set value an external potentiometer can be connected or an external set value voltage can be applied.

Speed controlled version

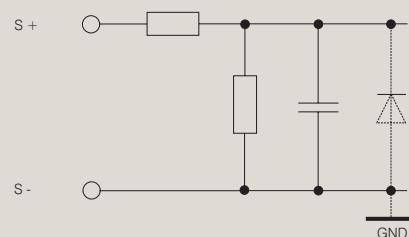

The interpretation of the set value and the corresponding level are described in the relevant data sheet.

For detailed information, please refer to the corresponding specification data sheets. The instructions and safety notes in the operating manual must be kept at all times.

Accessories



Electrical connection

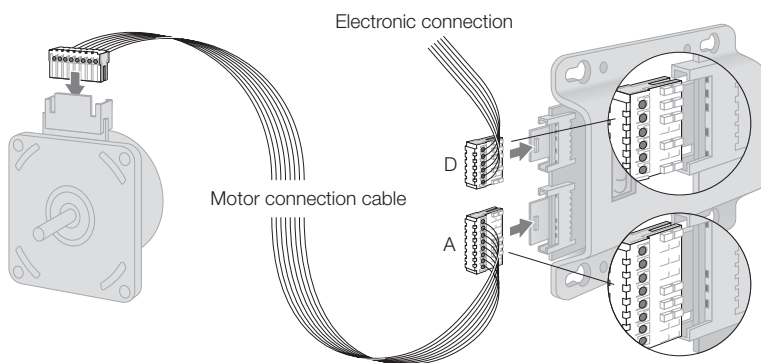

Type 194 0010 000

Motor connection cable for VARIODRIVE motors VD-3-35.06 / VD-3-43.10 and DRIVECONTROL VT-A with Molex-plugs.

Plug A

AMP Duoplug 2.5 - 8-pole grey
No. : 3-829 868-8 (when encoding)
Alternative:
Lumerg 35 21 08K30 (when encoding)

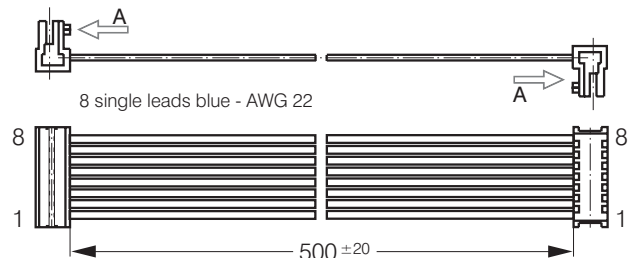

Type 194 0012 000

Motor connection cable for VARIODRIVE motors VD-3-54.14 and DRIVECONTROL VT-A with Molex-plugs.

Plug B

Molex 39-01-2085 Mini-Fit, Jr.

Plug C

AMP-Edge 5 mm - 8-pole
No. 829 213-8 (when encoding)

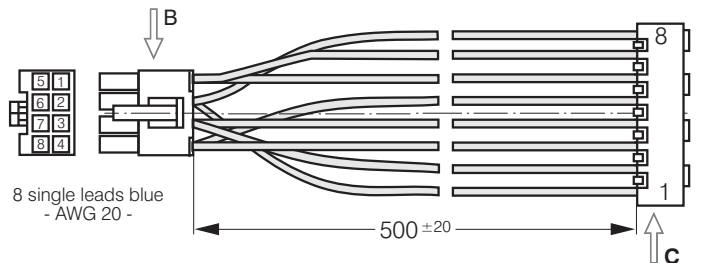

Type 194 0011 000

Electronic connection cable for DRIVECONTROL VT-A with AMP-plugs (motors VD-3-35.06 / VD-3-43.10).

Plug D (when encoding)

AMP Duoplug 2.5 - 6-pole grey
No. 3-829 868-6
or Lumerg 35 21 06K30

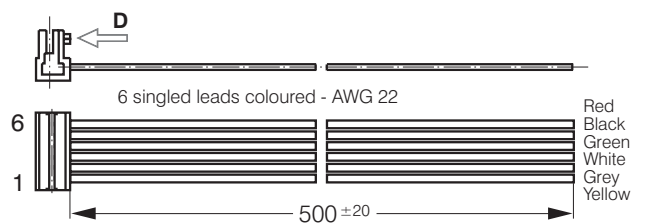

Type 194 0013 000

Electronic connection cable for DRIVECONTROL VT-A with Molex-plugs (motors VD-3-54.14).

Plug E

Molex 39-01-2065 Mini-fit, Jr.

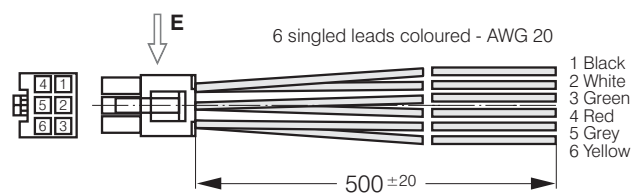

Type 194 0009 000

Motor connection cable for VARIODRIVE Compact motors VDC-3-43.10.

Plug F

Lumberg Duomodul - connector 2.5 mm 10-pole, Lumberg Order No. 35 15 10 K05 S01

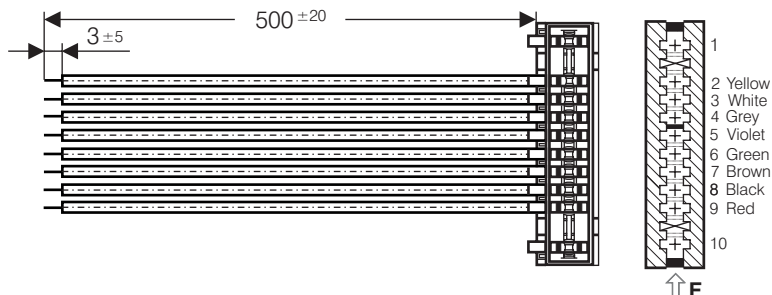

Type 194 0014 000

Motor connection cable for VARIODRIVE Compact motors VDC-3-54.14.

Plug G

MT-Edge 5 mm - 8 pole natural for 0.5 mm contact with 2 i.p.c.d. Order No. AMP 829 213-8

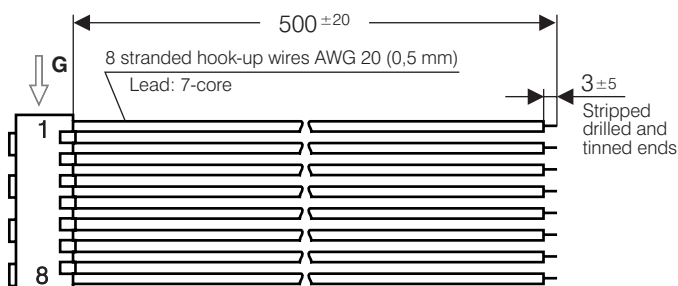

Rotor protective cap

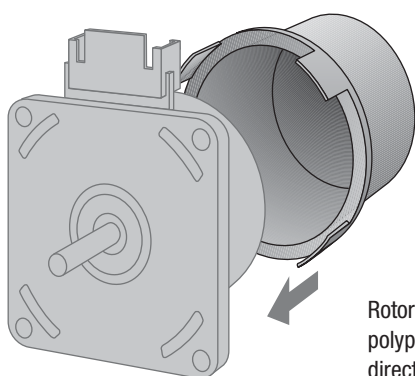



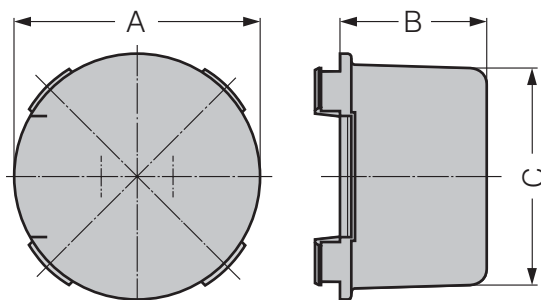

Rotor protective cap made of black polypropylene (PP). The cap is fitted directly onto the motor flange and sealed with a rubber seal.



The protective cap cannot be mounted with motor VDC-3-43.10! When using the protective cap, the motor performance must be reduced due to the decreased heat dissipation from the motor.

	VARIODRIVE VD ... 35.0X 194 3506 000	VARIODRIVE VD ... 43.10 194 4310 000	VARIODRIVE VD ... 54.14 194 5414 000
Dimension A	57	65	82
B	27.4	38.8	42
C	49.5	57.4	74.4

-  Motors Distributors
-  spec. Motors Distributors
-  Fans Distributors
-  Ventilator Distributors

Distributors of ebm-papst

Germany

ebm-papst St. Georgen GmbH & Co. KG

Hermann-Papst-Straße 1
D-78112 St. Georgen
Phone +49 (0) 77 24 / 81 - 0
Fax +49 (0) 77 24 / 81 - 13 09
info2@de.ebmpapst.com

www.ebmpapst.com

ebm-papst Mulfingen GmbH & Co. KG

Bachmühle 2
D-74673 Mulfingen
Phone +49 (0) 79 38 / 81 - 0
Fax +49 (0) 79 38 / 81 - 110
info1@de.ebmpapst.com

www.ebmpapst.com





ebm-papst Landshut GmbH

Hofmark-Aich-Straße 25
D-84030 Landshut
Phone +49 (0) 8 71 / 707 - 0
Fax +49 (0) 8 71 / 707 - 465
info3@de.ebmpapst.com

www.ebmpapst.com

Agencies

Berlin

-  Dipl.-Ing. (TH) Jens Duchow
-  Händelstraße 7
-  16341 Panketal
-  Phone +49 (0) 30 / 94 41 49 62
- Fax +49 (0) 30 / 94 41 49 63
- Jens.Duchow@de.ebmpapst.com

Dortmund

-  Dipl.-Ing. (FH) Hans-Joachim Pundt
-  Auf den Steinern 3
-  59519 Möhnesee-Völlinghausen
-  Phone +49 (0) 29 25 / 80 04 07
- Fax +49 (0) 29 25 / 80 04 08
- Hans-Joachim.Pundt@de.ebmpapst.com





Frankfurt

-  Dipl.-Ing. Christian Kleffmann
-  Dr. Hermann-Krause Straße 23
-  63452 Hanau
-  Phone +49 (0) 61 81 / 18 98 12
- Fax +49 (0) 61 81 / 18 98 13
- Christian.Kleffmann@de.ebmpapst.com





Halle

-  Dipl.-Ing. (TU) Michael Hanning
-  Lerchenweg 4
-  06120 Lieskau
-  Phone +49 (0) 3 45 / 5 51 24 56
- Fax +49 (0) 3 45 / 5 51 24 57
- Michael.Hanning@de.ebmpapst.com

Hamburg

-  Ingenieurbüro Breuell GmbH
-  Elektro.-Ing. Dirk Kahl
-  Grützmühlenweg 40
-  22339 Hamburg
- Phone +49 (0) 40 / 53 80 92 10
- Fax +49 (0) 40 / 53 80 92 84
- Dirk.Kahl@de.ebmpapst.com

Kassel

-  Dipl.-Ing. (FH) Ralph Brück
-  Hoherainstraße 3 b
-  35075 Gladenbach
-  Phone +49 (0) 64 62 / 40 71 10
- Fax +49 (0) 64 62 / 40 71 11
- Ralph.Brueck@de.ebmpapst.com





Koblenz

-  Winfried Schaefer
-  Hinter der Kirch 10
-  56767 Uersfeld
-  Phone +49 (0) 26 57 / 16 96
- Fax +49 (0) 26 57 / 16 76
- Winfried.Schaefer@de.ebmpapst.com





München

-  Dipl.-Wirt.-Ing. (FH) Jens Peter
-  Steinbergweg 6
-  82285 Hattenhofen
-  Phone +49 (0) 81 45 / 80 92 25
- Fax +49 (0) 81 45 / 80 92 26
- Jens.Peter@de.ebmpapst.com





Nürnberg

-  Friedrich Klein
-  Adlerstraße 49/1
-  73540 Heubach
-  Phone +49 (0) 71 73 / 49 83
- Fax +49 (0) 71 73 / 80 53
- Friedrich.Klein@de.ebmpapst.com





Offenburg

-  Dipl.-Ing (FH) Ralf Braun
-  Hubeneck 21
-  77704 Oberkirch
-  Phone +49 (0) 78 02 / 98 22 52
- Fax +49 (0) 78 02 / 98 22 53
- Ralf.Braun@de.ebmpapst.com





Paderborn

-  Wolf-Jürgen Weber
-  Niehausweg 13
-  33739 Bielefeld
-  Phone +49 (0) 5206 / 91 73 231
- Fax +49 (0) 5206 / 91 73 235
- wolf-juergen.weber@de.ebmpapst.com

Stuttgart

-  Dipl.-Ing. (FH) Rudi Weinmann
-  Mühlhaldenweg 13
-  73207 Plochingen
-  Phone +49 (0) 71 53 / 92 89 80
- Fax +49 (0) 71 53 / 92 89 81
- Rudi.Weinmann@de.ebmpapst.com

Ulm





-  Günter Wilhelm
-  Allgäuer Str. 7
-  89269 Vöhringen
-  Phone +49 (0) 73 06 / 92 46 08
- Fax +49 (0) 73 06 / 92 46 48
- Guenter.Wilhelm@de.ebmpapst.com

External Support Manager drive engineering

Office East

Dipl.-Ing. (TU) Michael Hanning
Lerchenweg 4
06120 Lieskau bei Halle
Phone +49 (0) 3 45 / 5 51 24 56
Fax +49 (0) 3 45 / 5 51 24 57
Michael.Hanning@de.ebmpapst.com





Office North

-  Ingenieurbüro Breuell GmbH
-  Elektro.-Ing. Dirk Kahl
-  Grützmühlenweg 40
-  22339 Hamburg
- Phone +49 (0) 40 / 53 80 92 56
- Fax +49 (0) 40 / 53 80 92 84
- Dirk.Kahl@breuell.de

Office West

-  Matthias Bembenek
-  Prozessionsweg 39
-  46286 Dorsten
-  Phone +49 (0) 23 69 / 20 82 05
- Fax +49 (0) 23 69 / 20 82 07
- Matthias.Bembenek@de.ebmpapst.com

Office South-West





-  Thomas Schrag
-  Mahlbergstr. 37/1
-  75210 Keltern
-  Phone +49 (0) 72 36 / 98 24 07
- Fax +49 (0) 72 36 / 98 24 09
- Thomas.Schrag@de.ebmpapst.com

Office South-Ost

-  Jürgen Sopejstal
-  Kirchhoffstr. 26
-  90552 Röthenbach
-  Phone +49 (0) 9 11 / 5 44 38 15
- Fax +49 (0) 9 11 / 5 44 38 16
- Juergen.Sopejstal@de.ebmpapst.com



Express Service-Center





Service and Consulting Center for sales of small quantities

-  Breuell + Hilgenfeldt GmbH
-  Grützmühlenweg 40
-  22339 Hamburg
-  Phone +49 (0) 40 / 53 80 92 20
- Fax +49 (0) 40 / 53 80 92 84
- ebmpapst@breuell.de

Europe

Austria

-  ebm-papst Motoren & Ventilatoren GmbH
-  Westbahnstr. 5
-  A-4490 St. Florian
-  Phone +43 / 7224 / 66 011-0
- Fax +43 / 7224 / 66 011-20
- info@at.ebmpapst.com; www.ebmpapst.at

-  Motors Distributors
-  spec. Motors Distributors
-  Fans Distributors
-  Ventilator Distributors

Distributors of ebm-papst

 **next system**
Vertriebsges. m.b.H.
Dresdner Str. 68/1/3
A-1200 Wien
Phone +43 / 1 / 33 166-0
Fax +43 / 1 / 33 166-100
office@nextsystem.at; www.nextsystem.at

 **Belarus**
ebm-papst Bel AgmbH
 Prospekt Nesavisimosti 11/2
Suite 325, 512
 BY-220050 Minsk
Phone +3 75 / 17 / 2 09 95 61
Fax. +375 / 17 / 2 09 95 61
info@by.ebmpapst.com; www.ebmpapst.ru

 **Belgium**
VIBO Benelux B. V.
 Sales office Belgium-Luxemburg
Romeinsestraat 6/0101
 Research Park Haasrode
B-3001 Heverlee-Leuven
Phone +32 / 16 / 39 62 00
Fax +32 / 16 / 39 62 20
info@vibobenelux.com
www.vibobenelux.com

Bulgaria see also Romania

Croatia see also Hungary

 **Czech Republic / Slovakia**
ebm-papst CZ s.r.o.
 Krátká 379
CZ-66461 Rajhradice u Brna
 Phone +4 20 / 5 / 47 23 26 16
Fax +4 20 / 5 / 47 23 26 22
info@ebmpapst.cz; www.ebmpapst.com

 **Denmark**
Jenk ApS
 Vallensbækvej 21
DK-2605 Brøndby
 Phone +45 / 43 63 11 11
Fax +45 / 43 63 05 05
jenk@jenk.dk; www.jenk.dk

 **Finland**
ebm-papst OY
 Puistotie 1
FIN-02760 Espoo
 Phone +358 / 9 / 88 70 22 0
Fax +358 / 9 / 88 70 22 13
mailbox@ebmpapst.fi; www.ebmpapst.fi

 **France**
ebm-papst sarl
 BP 62
F-67212 Obernai-Cedex
 Phone +33 / 820 326 266
Fax +33 / 3 / 88 67 38 83
info@ebmpapst.fr; www.ebmpapst.fr

 **Great Britain**
ebm-papst UK Ltd.
 Chelmsford Business Park
GB-Chelmsford Essex CM2 5EZ
 Phone +44 / 12 45 / 46 85 55
Fax +44 / 12 45 / 46 63 36
sales@uk.ebmpapst.com; www.ebmpapst.co.uk



 **ebm-papst Automotive & Drives (UK) Ltd**
 The Smithy, Fidlers Lane
East Ilsley, Newbury
Berkshire RG20 7LG
Phone +44 / 87 07 / 66 51 70
Fax +44 / 87 07 / 66 51 80
A&DSales@uk.ebmpapst.com; www.ebmpapst.co.uk

 **Greece**
Helcoma
 Th. Rotas & Co OE
Davaki 65
 GR-17672 Kallithea-Attiki
Phone +30 / 2 10 / 9 51 37 05
Fax +30 / 2 10 / 9 51 34 90
contact@helcoma.gr; www.helcoma.gr

 **Hungary**
ebm-papst Industries Kft.
 Mátyás u. 1/A
H-2220 Vecsés
 Phone +36 / 29 / 55 01 90
Fax +36 / 29 / 55 01 94
office@hu.ebmpapst.com; www.ebmpapst.hu

 **Iceland**
RJ Engineers
 Stangarhyl 1A
IS-110 Reykjavik
 Phone +354 / 567 80 30
Fax +354 / 567 80 15
rj@rj.is; www.rj.is

 **Ireland**
ebm-papst Ltd.
 Portlaoise Business & Technology Park
Mountrath Road
 IRL-Portlaoise, Co. Laois
Phone +353 / 8 66 43 43
Fax +353 / 8 66 43 46
sales@ie.ebmpapst.com; www.ebmpapst.ie

 **Italy**
ebm-papst S.r.l.
 Via Cornaggia 108
I-22076 Mozzate (Co)
 Phone +39 / 03 31 / 83 62 01
Fax +39 / 03 31 / 82 15 10
info@it.ebmpapst.com; www.ebmpapst.it

 **Macedonia**
ebm-papst Industries Kft.
 Mátyás u. 1/A
H-2220 Vecsés
 Phone +36 / 29 / 55 01 90
Fax +36 / 29 / 55 01 94
office@hu.ebmpapst.com; www.ebmpapst.hu

 **Netherlands**
VIBO Benelux B. V.
 Engelseweg 127
Postbus 230
 NL-5705 AC Helmond
Phone +31 / 4 92 / 50 29 00
Fax +31 / 4 92 / 50 29 50
verkoop@vibobenelux.com;
www.vibobenelux.com





 **Norway**
ebm-papst AS
 Nordasveien 5
N-1203 Oslo
 Phone +47 / 22 / 76 33 40
Fax +47 / 22 / 61 91 73
mailbox@ebmpapst.no; www.ebmpapst.no

 **Poland**
ebm-papst Polska Sp. z o.o.
 ul. Annopol 4A
PL-03-236 Warszawa
 Phone +48 / 22 / 675 78 19
Fax +48 / 22 / 676 95 87
office@ebmpapst.pl; www.ebmpapst.pl





















 **Portugal**
ebm-papst (Portugal), Lda
 Av. Marechal Gomes da Costa, 35 e
Rua Conselheiro Emidio Navarro
P-1800-255 Lisboa
 Phone +351 / 21 / 839 48 80
Fax +351 / 21 / 839 47 59
info@pt.ebmpapst.com; www.ebmpapst.pt

 **Romania**
ebm-papst Romania S.R.L.
 Str. Tirnavei No. 20
RO-500327 Brasov
 Phone +40 / 2 68 / 31 28 05
Fax +40 / 2 68 / 31 28 05
dudaasludovic@xnet.ro

 **Russia**
ebm-papst Ural GmbH
 Posadskaya 23
4. Floor, Suite 403
RUS-620102 Jekaterinburg
 Phone +7 / 343 / 233 77 85
Fax +7 / 343 / 233 77 99
Konstantin.Molokov@ru.ebmpapst.com
www.ebmpapst.ur.ru

-  Motors Distributors
-  spec. Motors Distributors
-  Fans Distributors
-  Ventilators Distributors

Distributors of ebm-papst

-  ebm-papst Rus GmbH
 Nizhegorodskaya 32, str. 15 office 420
 RU-109029 Moskau
 Phone +7 / 4 95 / 6 71 53 93
 Fax +7 / 4 95 / 6 71 53 95
 info@ebmpapst.ru; www.ebmpapst.ru
-  ebm-papst Rus
 Saint-Petersburg's Filial
 Zastavskaya 7
 RU-196084 Sankt-Petersburg
 Phone +7 / 8 12 / 4 49 96 07
 Fax +7 / 8 12 / 4 49 96 07
 spb@ru.ebmpapst.com
- Serbia & Montenegro**
 ebm-papst Industries Kft.
 Mátyás u. 1/A
 H-2220 Vecsés
 Phone +36 / 29 / 55 01 90
 Fax +36 / 29 / 55 01 94
 office@hu.ebmpapst.com; www.ebmpapst.hu
- Spain**
 ebm-papst Ibérica S.L.
 Avda. del Sistema Solar, 29
 C/Monton de Trigo, Nr. 3
 E-28830 San Fernando
 de Henares (Madrid)
 Phone +34 / 91 / 6 78 08 94
 Fax +34 / 91 / 6 78 15 30
 ventas@ebmpapst.es
- Sweden**
 ebm-papst AB
 Äggelundavägen 2
 S-17562 Järfälla
 Phone +46 / 8 / 7 61 94 00
 Fax +46 / 8 / 36 23 06
 info@ebmpapst.se; www.ebmpapst.se
- Switzerland**
 ebm-papst AG
 Rütisbergstraße 1
 CH-8156 Oberhasli
 Phone +41 / 44 / 732 20 70
 Fax +41 / 44 / 732 20 77
 verkauf@ebmpapst.ch; www.ebmpapst.ch
-  Omni Ray AG
 Im Schörl 5
 CH-8600 Dübendorf
 Phone +41 / 44 / 8 02 28 80
 Fax +41 / 44 / 8 02 28 28
 r.borner@omniray.ch; www.omniray.ch



- Turkey**
 Akantel Elektronik San. Tic. LTD. Sti.
 Atatürk Organize Sanayi
 Bölgesi 10007 SK. No.:6
 TR-35620 Cigli-Izmir
 Phone +90 / 2 32 / 32 82 090 -91
 Fax +90 / 2 32 / 32 80 270
 akantel@akantel.com.tr; www.akantel.com.tr
- Ukraine**
 ebm-papst Ukraine GmbH
 Lepse Boulevard 4, House 47 Floor 5
 UA-03067 Kiev
 Phone +38 / 0 44 / 2 06 30 91
 Fax +38 / 0 44 / 2 06 30 91
 mail@ebmpapst.ua; www.ebm-papst.ua

Americas

- Argentina**
 ebm-papst de Argentina S.A.
 Hernandarias 148 Lomas del Mirador
 1752 Buenos Aires
 Phone +54 / 11 46 57-61 35
 Fax +54 / 11 46 57-20 92
 ventas@ar.ebmpapst.com
- Brazil**
 ebm-papst Motores Ventiladores Ltda.
 Rua Francisco D'Amico, 155
 Bairro Pirajussara
 BR-06707-100 Taboão da Serra-SP
 Phone +55 / 11 / 31 64 89 00
 Fax +55 / 11 / 41 38 50 86
 vendas@br.ebmpapst.com;
 www.ebmpapst.com.br
- Canada**
 ebm-papst Canada Inc.
 1800 Ironstone Manor, Unit 2
 CDN-Pickering, Ontario, L1W3J9
 Phone +1 / 905 / 420 / 35 33
 Fax +1 / 905 / 420 / 37 72
 sales@ca.ebmpapst.com; www.ebmpapst.ca
- Mexico**
 ebm Industrial S.de R.L. de C.V.
 Paseo de Tamarindos 400-A-5to Piso
 Col. Bosques de las Lomas
 MEX-Mexico 05120, D.F.
 Phone +52 / 55 / 50 91 44 44
 Fax +52 / 55 / 50 91 44 43
 sales@mx.ebmpapst.com;
 www.ebmpapst.com.mx

- USA**
 ebm-papst Inc.
 100 Hyde Road
 USA-Farmington, CT 06034
 Phone +1 / 860 / 674 15 15
 Fax +1 / 860 / 674 85 36
 sales@us.ebmpapst.com; www.ebmpapst.us
-  ebm-papst Automotive and Drives, Inc.
 3200 Greenfield, Suite 255
 Dearborn, MI 48120
 Phone +1 / 313 / 406 80 80
 Fax +1 / 313 / 406 80 81
 automotive@us.ebmpapst.com;
 www.ebmpapst-automotive.us

África

- South Africa**
 ebm-papst South Africa (Pty) Ltd.
 P.O. Box 3124
 1119 Yacht Ave.
 ZA-2040 Honeydew Ext. 20
 Phone +27 / 11 / 794 57 06
 Fax +27 / 11 / 794 50 20
 info@za.ebmpapst.com; www.ebmpapst.co.za

Asia

- China**
 ebm-papst Ventilator (Shanghai) Co., Ltd.
 No. 418, Hua Jing Road
 Wai Gao Qiao Free Trade Zone
 No. 2001, Yang Gao (N) Road
 200131 Shanghai, P.R. of China
 Phone +86 / 21 / 50 46 01 83
 Fax +86 / 21 / 50 46 11 19
 sales@cn.ebmpapst.com;
 www.ebmpapst.com.cn/
- Hong Kong**
 ebm-papst Ventilator (Shanghai) Co., Ltd.
 Hong Kong Representative Office
 Unit Nos. 13-15, 9/F, Technology Park
 18 On Lai Street, Sha Tin
 N.T. Hong Kong, P.R. of China
 Phone +852 / 21 45 / 86 78
 Fax +852 / 21 45 / 76 78
 chenghong@cn.ebmpapst.com

ebm-papst
St. Georgen GmbH & Co. KG

Hermann-Papst-Straße 1
D-78112 ST. GEORGEN
Germany
Phone +49 (0) 7724 / 81-0
Fax +49 (0) 7724 / 81-1309
info2@de.ebmpapst.com

www.ebmpapst.com

X-ON Electronics

Largest Supplier of Electrical and Electronic Components

Click to view similar products for [Motor Drives](#) category:

Click to view products by [ebm papst](#) manufacturer:

Other Similar products are found below :

[R7DBP02L](#) [1300920283](#) [ST10-Plus](#) [ST10-S](#) [GMA11](#) [GMA20](#) [R88DUA03LAAC100V30W](#) [R88DUA12HA](#) [R88DUP03LAAC100V30W](#)
[STR2](#) [VFD002EL11A](#) [1302263150](#) [1300920078](#) [R88D-GN04H-ML2](#) [R88D-KT01H](#) [R7D-BP01H](#) [R88D-KN04L-ECT](#) [70354063](#) [79294435](#)
[27358015](#) [15275008](#) [ST5-Q-EN](#) [1SFA896103R1100](#) [1SFA896112R1100](#) [1SFA896114R7000](#) [R88D-GP08H](#) [GNCF8-11](#) [KLC35BE](#) [ST10-](#)
[Q-RN](#) [1302263161](#) [SV2D10-Q-AE](#) [VX5A1300](#) [R88A-CA1C005SF-E](#) [R88A-CR1B005NF-E](#) [R88D-GT08H](#) [SEH 71-4B](#) [U-](#)
[PKZ0\(400V50HZ\)](#) [LUCC12BL](#) [LUCC12FU](#) [LU9BN11L](#) [LULC08](#) [GV2P01](#) [UDS1UR6M50CANCZ183](#) [LC1D09M7](#) [103H7823-1741](#)
[111.3761.20.00E](#) [111.3761.30.00E](#) [808070RAT250](#) [FMJ7201FB1](#) [FMJ7201FJ1](#)