

Fan filter guard grilles

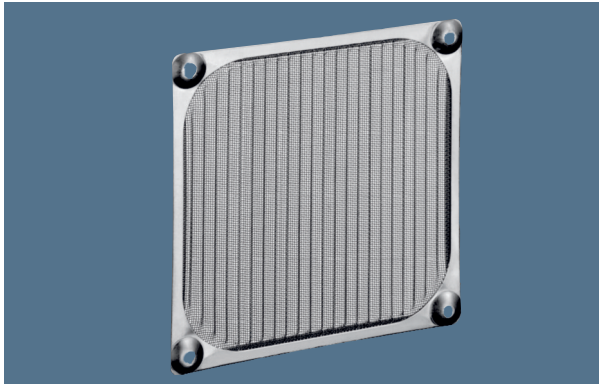

- Filter guard grilles consist of a mounting plate, filter and screen.
- Screen LZ40 N made of black, fibreglass-reinforced plastic with inserted wire netting LZ60.
- Filter LZ60 made of Nirosta stainless steel wire netting.
- Mounting plate LZ40-1 for installation.

Fan series DC	Fan series AC
4400 F	AC 4300
4400 FN	9900
4300	4000 N
4300 N	4000 Z
4400	
4200	
4100 N	

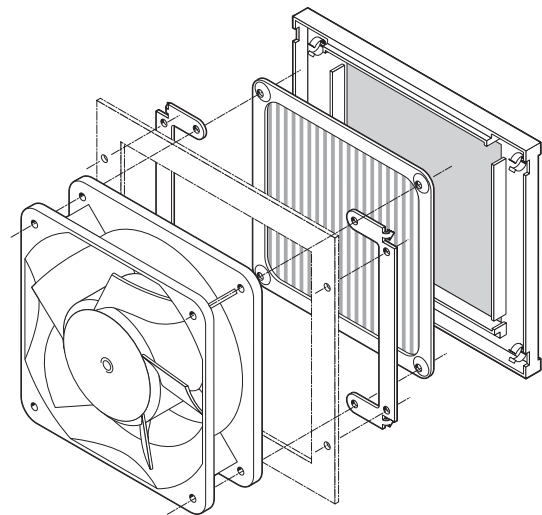

LZ40N

Screen

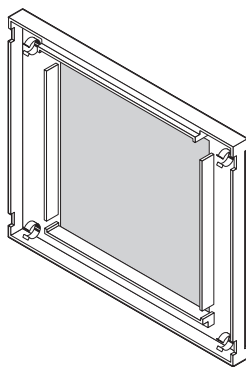

LZ40-1

Bracket

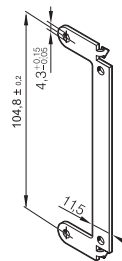
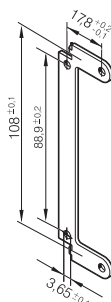

LZ60

Filter

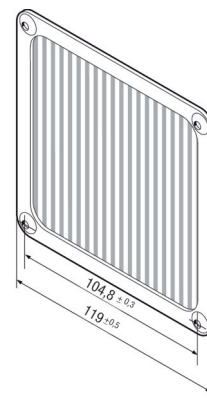

Fan filter guard grilles



- Filter guard grille suitable for attachment to axial fan series of size 60 mm, 80 mm, 92 mm, 119 mm, \varnothing 172 mm. All filter units fit directly onto the existing installation holes of the fans.
- Filter guard grille consisting of 3 parts: outer grille barrier, inner fastening plate and replaceable filter mat.
- Grille barrier made of moulded polycarbonate (PC), with matted surface.
- Fast and easy exchange of filter mat via a quick release on the grille barrier.
- Fastening plate made of wire netting, with black powder coating.
- Filter mat can be replaced while the fan is running, protection provided by welded wire netting.
- Filter mat made of white, synthetically bonded fibres.

Protection filter	Fan size	A	B	C	D	Replacement filter*
FF60	60 x 60 mm	65	65	13,5	50,0	RF 60
FF80	80 x 80 mm	85	85	14,0	71,5	RF 80
FF92	92 x 92 mm	125	105	17,5	82,5	RF 92
FF119	119 x 119 mm	162	136	18,5	104,5	RF 119
FF172	\varnothing 172 mm	226	190	19,5	162,0	RF 172

* Replacement filters only in packs of 5.

FF60 / FF80

Fan size: 60 x 60 mm
80 x 80 mm

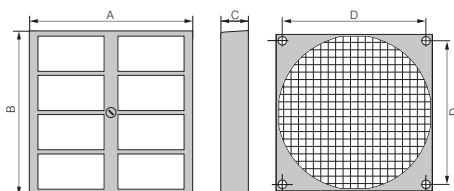

FF92 / FF 119

Fan size: 92 x 92 mm
119 x 119 mm

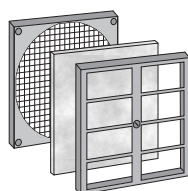
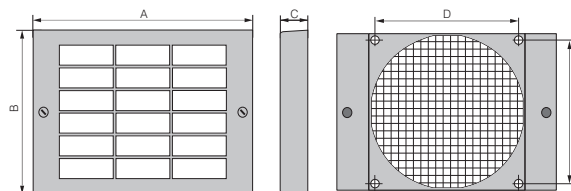

FF 172

Fan size: \varnothing 172 mm

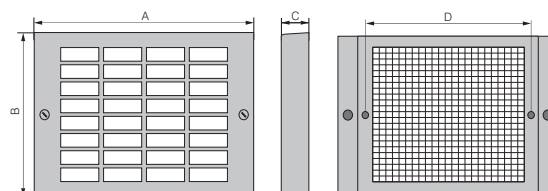

Filter capacity

A fan filter guard filters out up to 75% of dust particles up to a size of 5-10 microns and withstands temperatures of up to 100°C. Flame retardant in accordance with DIN 53438, grade F1. For installed, clean filters, an air flow reduction of 20 – 30% can be assumed.

X-ON Electronics

Largest Supplier of Electrical and Electronic Components

Click to view similar products for [Fan Accessories](#) category:

Click to view products by [ebm papst](#) manufacturer:

Other Similar products are found below :

[LZ31](#) [LZ32P-1](#) [63070-2-4013](#) [64442-1-7612](#) [71882-2-4053](#) [73816-2-3634](#) [854589-1](#) [95778-1-5171](#) [99485901](#) [1247-4-6254](#) [RF119](#) [2151-4-7320](#) [27453.32262](#) [95779-1-5171](#) [9614-2-4013](#) [99485906](#) [F92-B](#) [FG92-W2](#) [2170-4-7320](#) [27453.32241](#) [R88ACPU001M1](#) [R88ACPU001M2](#) [31570-2-4013](#) [LZ215](#) [LZ22-2](#) [LZ24-1](#) [LZ24B](#) [LZ30-9](#) [450-20-0021](#) [450-20-0025](#) [525-00-0009](#) [420-05-0276](#) [450-20-0017](#) [450-20-0020](#) [04.846.1353.0](#) [04.846.1453.0](#) [055032](#) [08121](#) [08188](#) [08195](#) [08196](#) [09576-2-4013](#) [54476-2-4013](#) [71883-2-4053](#) [52545-2-4037](#) [63071-2-4013](#) [52544-2-4037](#) [64445-1-7612](#) [66786-4-7320](#) [88601-2-2929](#)