

Square shaded-pole motors (Q-motors)

Standard design	302
Multi-function design	304
Frigo design	305
Plug terminal design	306
UL and CSA design	307
Air performance curves	308



Table of options		Standard	Multi-function	Frigo	Plug terminal	UL and CSA
		Page 302	Page 304	Page 305	Page 306	Page 307
	 = available ex stock					
Foot measure	18 mm (height 48 mm)		●	●		
	26 mm (height 51 mm)	●	●		●	●
Mount	A side (3 x M4, Ø 71.4 mm)		●			
	B side (3 x M4, Ø 71.4 mm)		●	●		
	Thread ends, A side (4 x M4)	●	●	●	●	●
Electr. terminals	Jacketed cable (3 x 0.5 mm ²)	450 mm	1500 mm	1500 mm		
	Plug terminal (3 x 0.5 mm ²)				●	
	UL jacketed cable (3 x AWG20)					450 mm



Valid for all designs:

- **Material:** Housing made of die-cast aluminium
Stator pack: Coated in black
- **Direction of air flow:** "V" or "A" (depending on axial impeller used)
- **Direction of rotation:** Counter-clockwise, seen on shaft end
- **Insulation class:** "B"
- **Mounting position:** Any, preferably horizontal
- **Condensate discharges:** None
- **Mode of operation:** Continuous operation (S1)
- **Bearing:** Self-adjusting calotte sleeve bearing (mean service life of 30,000 hours in horizontal installation position)
- **Motor protection:** Impedance protection (combination A-C) or thermal overload protector internally switched (combination D-H)
- **Protection class:** I
- **Mounting:** Guard grille and wall ring are mounted onto the protruding thread ends of the A side. The Q-motor can also be screwed on via the mounting flanges (integrated in the bearing shields).
- **Axial impeller mounting:** Mounted to the motor shaft using a plastic adapter with pulling peg and an M4 screw (combination A-D) or M5 (combination E-H) screw.
- **Power specifications:** At 60 Hz, the blade angle of the axial impellers must be reduced by 6° each.

Axial impellers		Blade angle 22° ± 1°30'				Blade angle 28° ± 1°30'				Blade angle 34° ± 1°30'			
Ø D	H	F	G	C	m³/h ⁽²⁾	F	G	C	m³/h ⁽²⁾	F	G	C	m³/h ⁽²⁾
154	90	61	56	27.5	60	56	59	32.0	100	54	62	37.0	140
172	103	58	57	31.0	120	55	59	36.0	180	53	63	42.0	230
200	123	58	58	32.0	190	55	60	37.5	300	—	—	—	—
200	123	65	58	32.0	190	62	60	37.5	300	59	64	45.0	400
230	123	64	62	35.0	500	—	—	—	—	—	—	—	—
230	123	64	62	35.0	500	60	65	43.0	630	52	68	50.0	820
254	135	64	62	37.0	580	—	—	—	—	—	—	—	—
254	135	70	62	37.0	580	65	66	45.0	840	—	—	—	—
254	135	76	74	37.0	580	72	78	45.0	840	67	80	52.0	1070
300	160	75	79	43.0	1000	—	—	—	—	—	—	—	—
300	160	75	79	43.0	1000	67	81	53.5	1400	—	—	—	—
300	160	86	84	43.0	1000	77	86	53.5	1400	—	—	—	—
300	160	108	104	43.0	1000	104	106	53.5	1400	95	112	61.0	1700

⁽²⁾ established at counterpressure of 20 Pa

Square shaded-pole motors

Multi-function design



- **Foot mounting:** Track dimension 26 mm (height 51 mm) or 18 mm (height 48 mm) possible
- **Bearing shields:** A and B-sides, tapped holes 3 x M4, diameter of pitch circle 71.4 mm; mounting of guard grille and wall ring on A-side bearing shield; opposite M4 are securely installed in the feet (knurled hex nuts are not included in delivery scope)
- **Type of protection:** IP 42
- **Electrical connection:** Jacketed cable 3 x 0.5 mm² with brass lead tips
- **Product conforming to standard:** CE
- **Approvals:** VDE
- **Curves:** Page 308

Nominal data	Combination: Motor axial impeller	Curve	Nominal voltage	Frequency	Speed/rpm	Power output	Power input	Current draw	Perm. amb. temp.	Mass	Dimensions				
											Type	p.302	VAC	Hz	rpm
M4Q045-BD01 -75	A	Ⓐ	1~ 230	50	1300	5	29	0.19	-30 to +40	0.9	43	76	43.5	12	15.0
		Ⓑ	1~ 230	60	1550	5	26	0.17	-30 to +40						
M4Q045-CA01 -75	B	Ⓒ	1~ 230	50	1300	7	31	0.20	-30 to +40	1.1	49	82	43.5	10	15.0
		Ⓓ	1~ 230	60	1550	8	30	0.20	-30 to +40						
M4Q045-CA03 -75	C	Ⓔ	1~ 230	50	1300	10	36	0.25	-30 to +40	1.2	49	82	43.5	10	15.0
		Ⓕ	1~ 230	60	1550	9	34	0.22	-30 to +40						
M4Q045-CF01 -75	D	Ⓖ	1~ 230	50	1300	16	60	0.42	-30 to +40	1.3	54	87	43.5	10	15.0
		Ⓗ	1~ 230	60	1550	16	58	0.36	-30 to +40						
M4Q045-DA01 -75	E	Ⓙ	1~ 230	50	1300	18	70	0.48	-30 to +40	1.6	59	93	43.5	10	15.0
		Ⓚ	1~ 230	60	1550	18	62	0.42	-30 to +40						
M4Q045-DA05 -75	F	Ⓛ	1~ 230	50	1300	23	86	0.62	-30 to +40	1.6	59	93	43.5	10	15.0
		Ⓛ	1~ 230	60	1550	25	80	0.55	-30 to +40						
M4Q045-EA01 -75	G	Ⓜ	1~ 230	50	1300	25	90	0.62	-30 to +40	2.0	69	103	44.0	10	15.5
		Ⓝ	1~ 230	60	1550	26	80	0.55	-30 to +40						
M4Q045-EF01 -75	H	Ⓞ	1~ 230	50	1300	34	110	0.75	-30 to +40	2.2	92	125	61.0	10	33.0
		Ⓟ	1~ 230	60	1550	34	100	0.65	-30 to +40						

subject to alterations

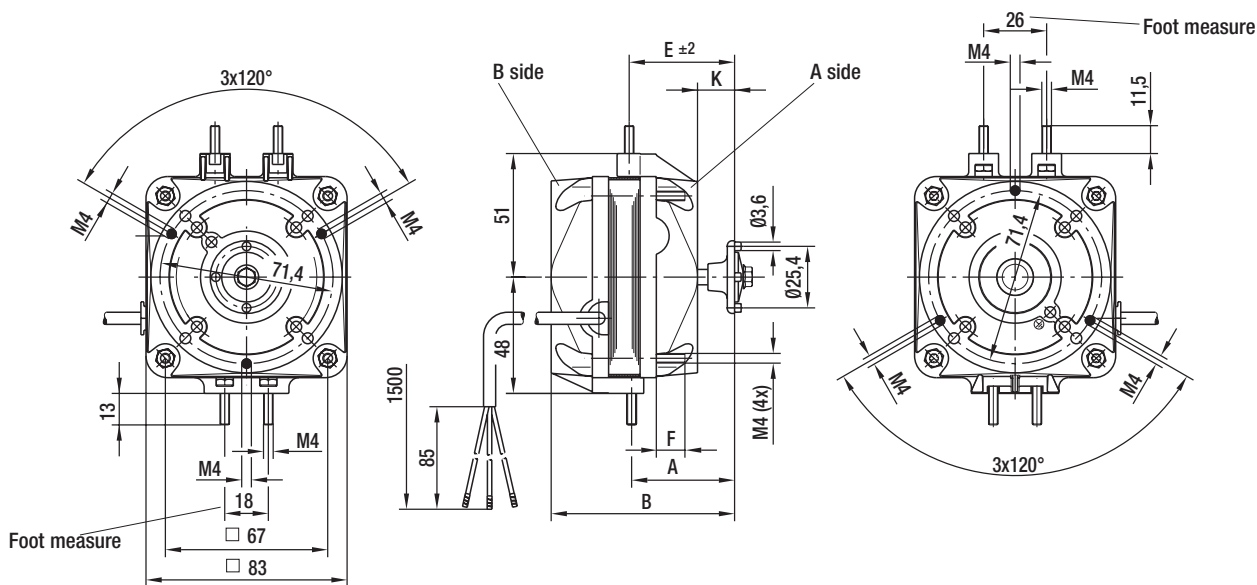

Square shaded-pole motors

Frigo design (specially for spare parts requirements)



- **Foot mounting:** Track dimension 18 mm (height 48 mm)
- **Bearing shields:** B-side, tapped holes 3 x M4, diameter of pitch circle 71.4 mm; mounting of guard grille and wall ring on A-side bearing shield; M4 knurled hex nuts (2x) are enclosed in loose form
- **Type of protection:** IP 42
- **Electrical connection:** Jacketed cable 3 x 0.5 mm² with brass lead tips
- **Product conforming to standard:** CE
- **Approvals:** VDE
- **Curves:** Page 308

Nominal data	Combination: Motor axial impeller	Curve	Nominal voltage	Frequency	Speed/rpm	Power output	Power input	Current draw	Perm. amb. temp.	Mass	Dimensions			
											Type	p.302	VAC	Hz
M4Q045-BD01 -A4	A	(A) (B)	1~ 230 1~ 230	50 60	1300 1550	5 5	29 26	0.19 0.17	-30 to +40 -30 to +40	0.9	48.5	76	12	15
M4Q045-CA01 -N4	B	(C) (D)	1~ 230 1~ 230	50 60	1300 1550	7 8	31 30	0.20 0.20	-30 to +40 -30 to +40	1.1	48.5	82	10	15
M4Q045-CA03 -A4	C	(E) (F)	1~ 230 1~ 230	50 60	1300 1550	10 9	36 34	0.25 0.22	-30 to +40 -30 to +40	1.2	48.5	82	10	15
M4Q045-CF01 -A4	D	(G) (H)	1~ 230 1~ 230	50 60	1300 1550	16 16	60 58	0.42 0.36	-30 to +40 -30 to +40	1.3	48.5	87	10	15
M4Q045-DA01 -A4	E	(I) (J)	1~ 230 1~ 230	50 60	1300 1550	18 18	70 62	0.48 0.42	-30 to +40 -30 to +40	1.6	48.5	93	10	15
M4Q045-DA05 -A4	F	(K) (L)	1~ 230 1~ 230	50 60	1300 1550	23 25	86 80	0.62 0.55	-30 to +40 -30 to +40	1.6	48.5	93	10	15
M4Q045-EA01 -A4	G	(M) (N)	1~ 230 1~ 230	50 60	1300 1550	25 26	90 80	0.62 0.55	-30 to +40 -30 to +40	2.0	49.0	103	10	16
M4Q045-EF01 -A4	H	(O) (P)	1~ 230 1~ 230	50 60	1300 1550	34 34	110 100	0.75 0.65	-30 to +40 -30 to +40	2.2	66.0	125	10	33

subject to alterations

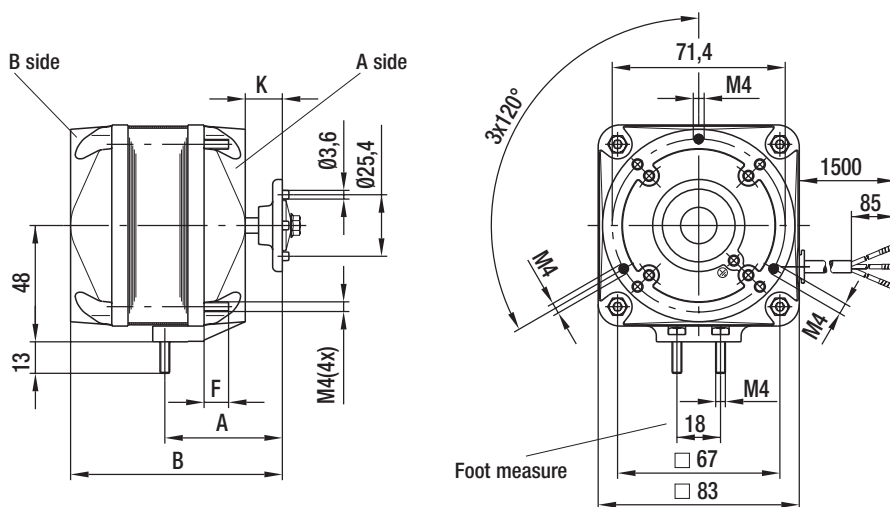

Square shaded-pole motors

Plug terminal design

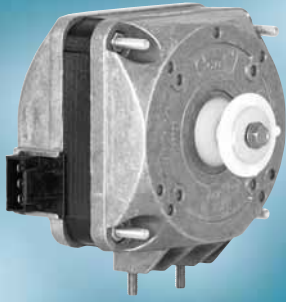

- **Foot mounting:** Track dimension 26 mm (height 51 mm)
- **Type of protection:** IP 42
- **Electrical connection:** Rast 5.6 mm terminal connector, 2.8 x 0.5 mm blade terminal; connection lines available in 420 mm to 4970 mm lengths
- **Product conforming to standard:** CE
- **Approvals:** VDE (put into operation with ebm-papst connection line only!)
- **Curves:** Page 308

Nominal data	Combination: Motor axial impeller	Curve	Nominal voltage	Frequency	Speed/rpm	Power output	Power input	Current draw	Perm. amb. temp.	Mass	Dimensions			
											Type	p.302	VAC	Hz
M4Q045-BD01 -08	A	Ⓐ Ⓑ	1~ 230 1~ 230	50 60	1300 1550	5 5	29 26	0.19 0.17	-30 to +40 -30 to +40	0.9	76	43.5	12	15
M4Q045-CA01 -08	B	Ⓒ Ⓓ	1~ 230 1~ 230	50 60	1300 1550	7 8	31 30	0.20 0.20	-30 to +40 -30 to +40	1.1	82	43.5	10	15
M4Q045-CA03 -08	C	Ⓔ Ⓕ	1~ 230 1~ 230	50 60	1300 1550	10 9	36 34	0.25 0.22	-30 to +40 -30 to +40	1.2	82	43.5	10	15
M4Q045-CF01 -08	D	Ⓖ Ⓗ	1~ 230 1~ 230	50 60	1300 1550	16 16	60 58	0.42 0.36	-30 to +40 -30 to +40	1.3	87	43.5	10	15
M4Q045-DA01 -52 ⁽¹⁾	E	Ⓘ Ⓝ	1~ 230 1~ 230	50 60	1300 1550	18 18	70 62	0.48 0.42	-30 to +40 -30 to +40	1.6	93	43.5	10	15
M4Q045-DA05 -52 ⁽¹⁾	F	Ⓚ Ⓛ	1~ 230 1~ 230	50 60	1300 1550	23 25	86 80	0.62 0.55	-30 to +40 -30 to +40	1.6	93	43.5	10	15
M4Q045-EA01 -52 ⁽¹⁾	G	Ⓜ Ⓝ	1~ 230 1~ 230	50 60	1300 1550	25 26	90 80	0.62 0.55	-30 to +40 -30 to +40	2.0	103	44.0	10	16
M4Q045-EF01 -52 ⁽¹⁾	H	Ⓞ Ⓟ	1~ 230 1~ 230	50 60	1300 1550	34 34	110 100	0.75 0.65	-30 to +40 -30 to +40	2.2	125	61.0	10	33

subject to alterations

(1) Foot mounting possible on A or B side

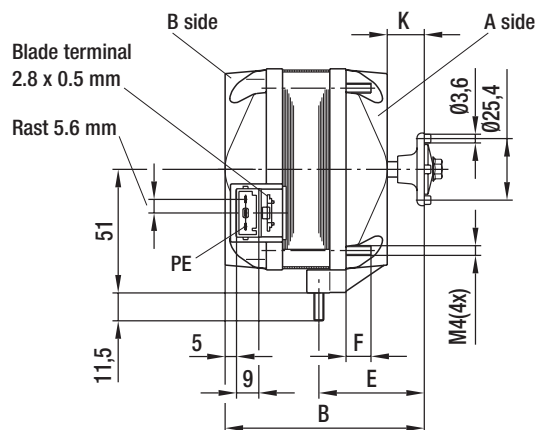
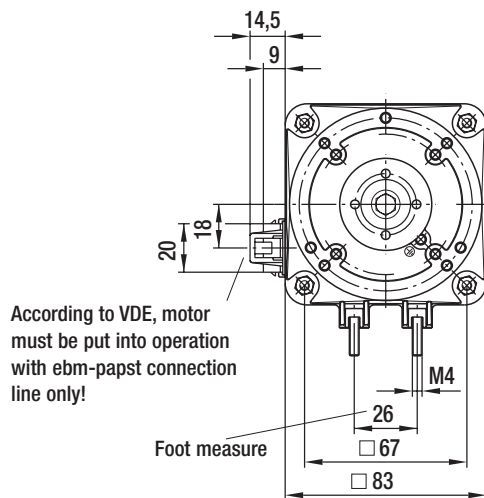

Square shaded-pole motors

UL and CSA design



- **Description:** Designs with UL/CSA approvals; connection lines, temperature monitor and dynamo wire are UL/CSA-approved components
- **Foot mounting:** Track dimension 26 mm (height 51 mm)
- **Type of protection:** IP 42
- **Electrical connection:** Jacketed cable 3 x AWG20 with brass lead tips
- **Product conforming to standard:** UL547, UL1004, CSA C22.2 No. 100, CSA C22.2 No. 77, CE
- **Approvals:** UL, CSA
- **Curves:** Page 308
- **Drawing:** See standard design on page 302

Nominal data		Combination: Motor axial impeller	Curve	Nominal voltage	Frequency	Speed/rpm	Power output	Power input	Current draw	Perm. amb. temp.	Mass	Dimensions		
Type	p.302											VAC	Hz	rpm
M4Q045-BD03 -04 (2)	A	(A) (B)	1~ 115 1~ 115	50 60	1300 1550	5 5	29 26	0.38 0.35	-30 to +40 -30 to +40	0.9	76	42	15	
M4Q045-BD01 -04 (2)	A	(A) (B)	1~ 230 1~ 230	50 60	1300 1550	5 5	29 26	0.19 0.17	-30 to +40 -30 to +40	0.9	76	42	15	
M4Q045-CA17 -04 (2)	B	(C) (D)	1~ 115 1~ 115	50 60	1300 1550	7 8	31 30	0.40 0.40	-30 to +40 -30 to +40	1.1	82	42	15	
M4Q045-CA01 -04 (2)	B	(C) (D)	1~ 230 1~ 230	50 60	1300 1550	7 8	31 30	0.20 0.20	-30 to +40 -30 to +40	1.1	82	42	15	
M4Q045-CA27 -04 (2)	C	(E) (F)	1~ 115 1~ 115	50 60	1300 1550	10 9	36 34	0.50 0.45	-30 to +40 -30 to +40	1.2	82	42	15	
M4Q045-CA25 -04 (2)	C	(E) (F)	1~ 230 1~ 230	50 60	1300 1550	10 9	36 34	0.25 0.22	-30 to +40 -30 to +40	1.2	82	42	15	
M4Q045-CF07 -04 (2)	D	(G) (H)	1~ 115 1~ 115	50 60	1300 1550	16 16	60 58	0.80 0.74	-30 to +40 -30 to +40	1.3	87	42	15	
M4Q045-CF01 -04 (2)	D	(G) (H)	1~ 230 1~ 230	50 60	1300 1550	16 16	60 58	0.42 0.36	-30 to +40 -30 to +40	1.3	87	42	15	
M4Q045-DA11 -04 (1)(3)	E	(I) (J)	1~ 115 1~ 115	50 60	1300 1550	18 18	70 62	0.98 0.87	-30 to +40 -30 to +40	1.6	93	54	15	
M4Q045-DA01 -04 (1)(3)	E	(I) (J)	1~ 230 1~ 230	50 60	1300 1550	18 18	70 62	0.48 0.42	-30 to +40 -30 to +40	1.6	93	54	15	
M4Q045-DA13 -04 (1)(3)	F	(K) (L)	1~ 115 1~ 115	50 60	1300 1550	23 25	86 80	1.25 1.10	-30 to +40 -30 to +40	1.6	93	54	15	
M4Q045-DA05 -04 (1)(3)	F	(K) (L)	1~ 230 1~ 230	50 60	1300 1550	23 25	86 80	0.62 0.55	-30 to +40 -30 to +40	1.6	93	54	15	
M4Q045-EA03 -04 (1)(3)	G	(M) (N)	1~ 115 1~ 115	50 60	1300 1550	25 26	90 80	1.25 1.10	-30 to +40 -30 to +40	2.0	103	59	16	
M4Q045-EA01 -04 (1)(3)	G	(M) (N)	1~ 230 1~ 230	50 60	1300 1550	25 26	90 80	0.62 0.55	-30 to +40 -30 to +40	2.0	103	59	16	
M4Q045-EF03 -04 (1)(3)	H	(O) (P)	1~ 115 1~ 115	50 60	1300 1550	34 34	110 100	1.50 1.35	-30 to +40 -30 to +40	2.2	125	79	33	
M4Q045-EF01 -04 (1)(3)	H	(O) (P)	1~ 230 1~ 230	50 60	1300 1550	34 34	110 100	0.75 0.65	-30 to +40 -30 to +40	2.2	125	79	33	

subject to alterations

(1) A and B-side foot mounting possible

(2) File No. E 171165

(3) File No. E 76226

Square shaded-pole motors

Air performance curves (measured in wall ring)

M4Q045-BD01-**, Ø 154, 50 Hz

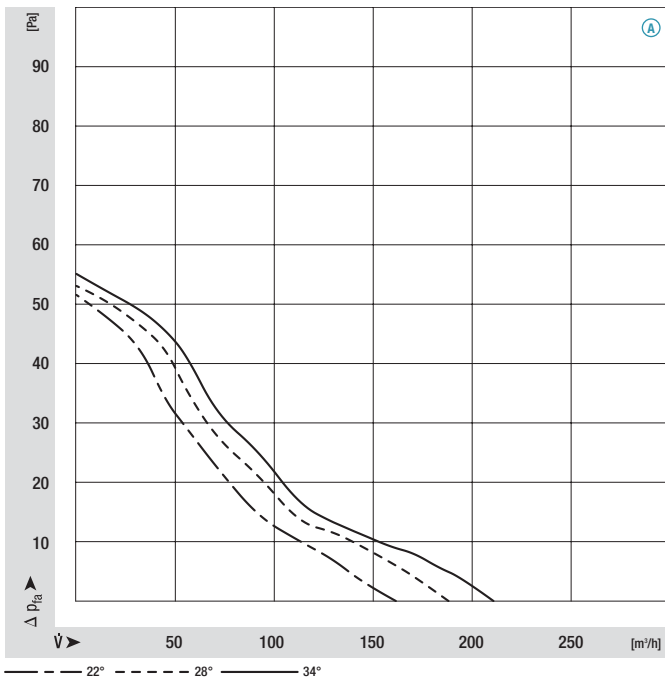

M4Q045-BD01-**, Ø 154, 60 Hz

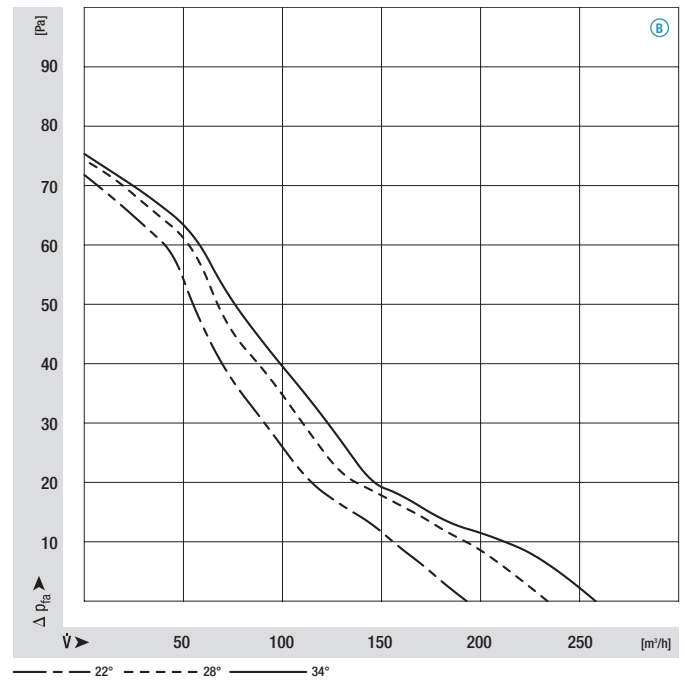

M4Q045-BD01-**, Ø 172, 50 Hz

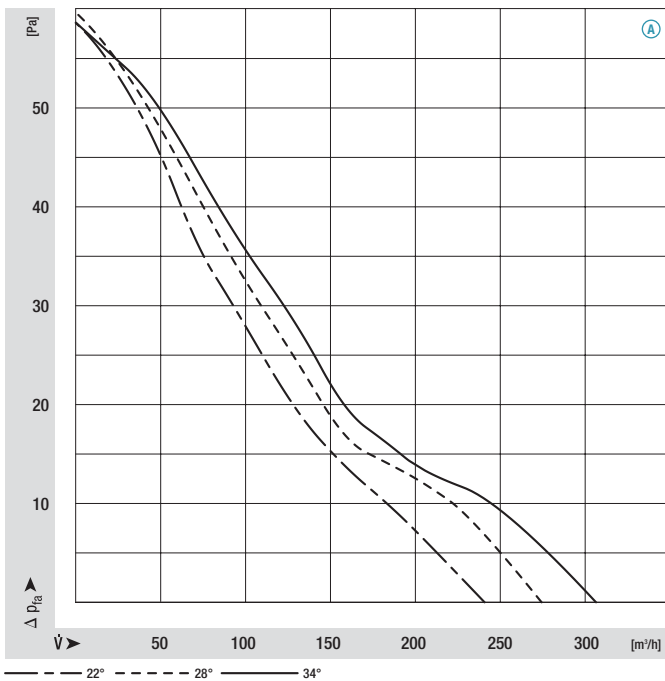

M4Q045-BD01-**, Ø 172, 60 Hz

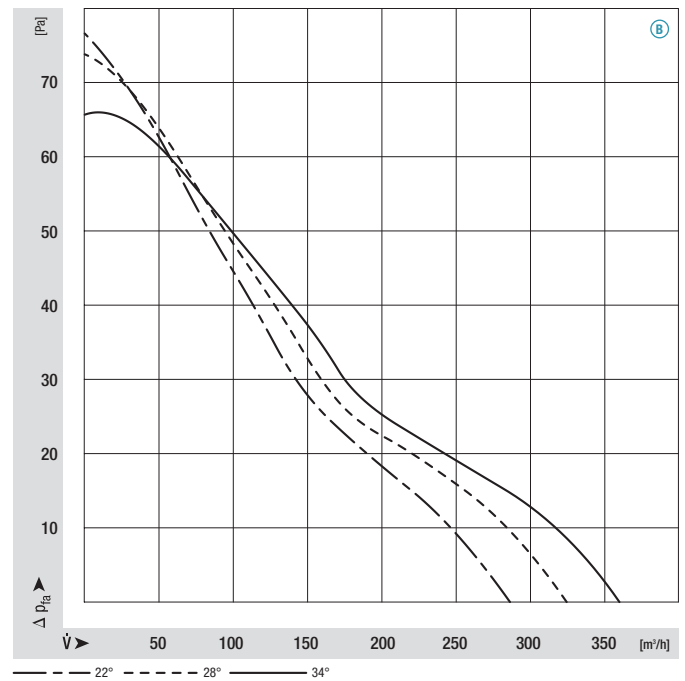

M4Q045-BD01-**, Ø 200, 50 Hz

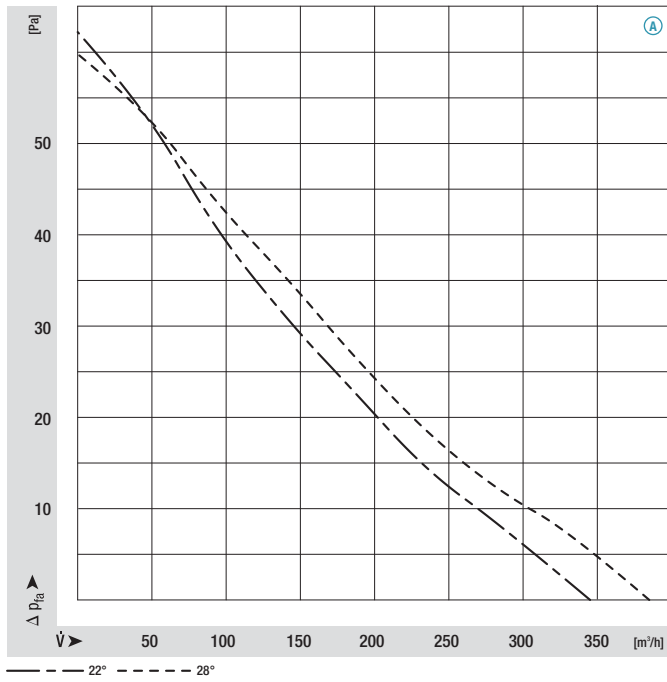

M4Q045-BD01-**, Ø 200, 60 Hz

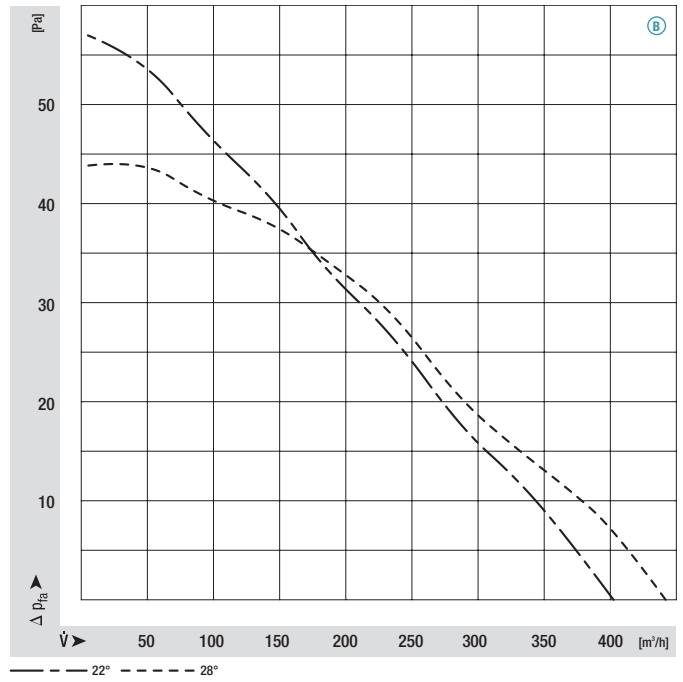

M4Q045-CA01-**, Ø 200, 50 Hz

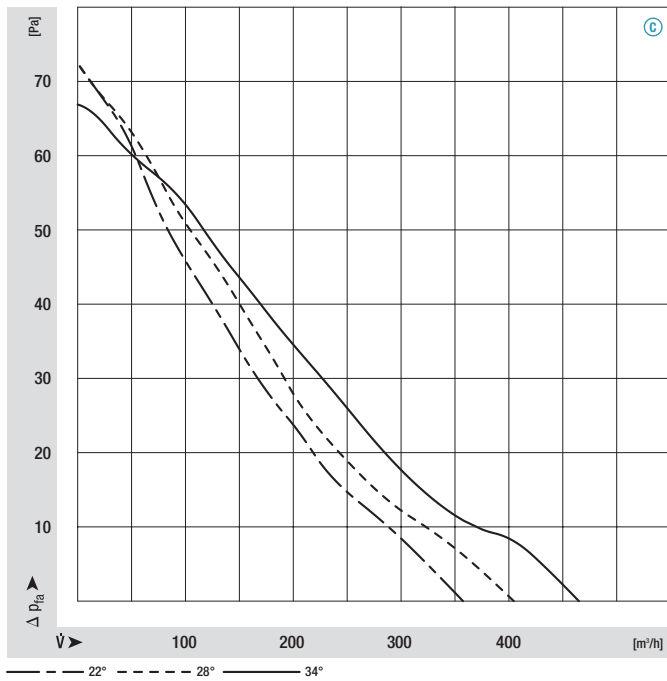

M4Q045-CA01-**, Ø 200, 60 Hz

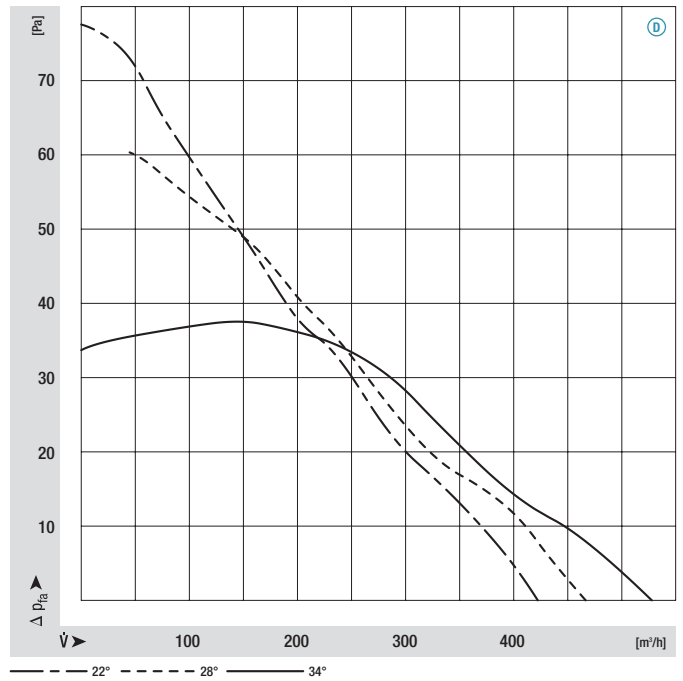

Square shaded-pole motors

Air performance curves (measured in wall ring)

M4Q045-CA01-**, Ø 230, 50 Hz

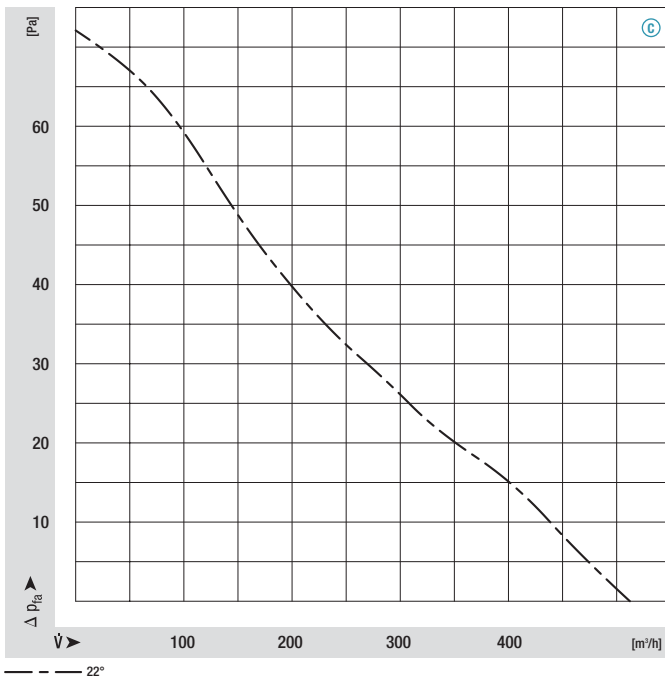

M4Q045-CA01-**, Ø 230, 60 Hz

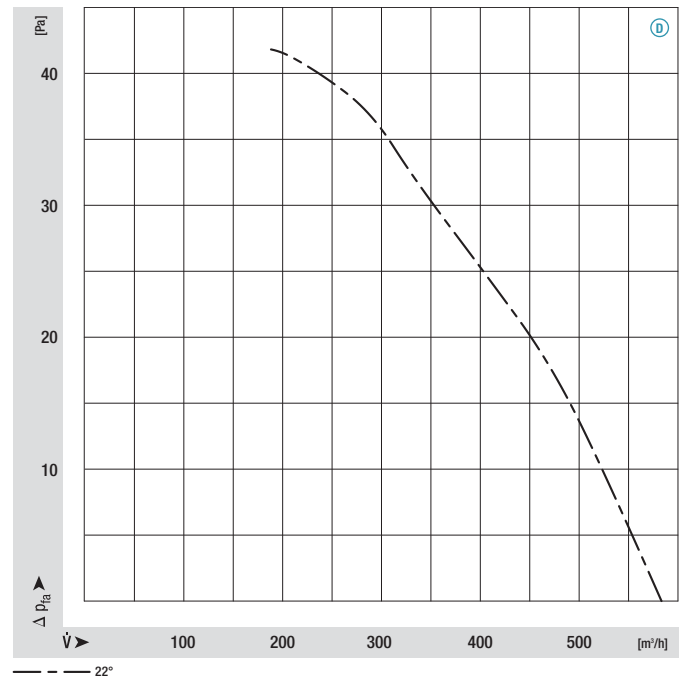

M4Q045-CA03-**, Ø 230, 50 Hz

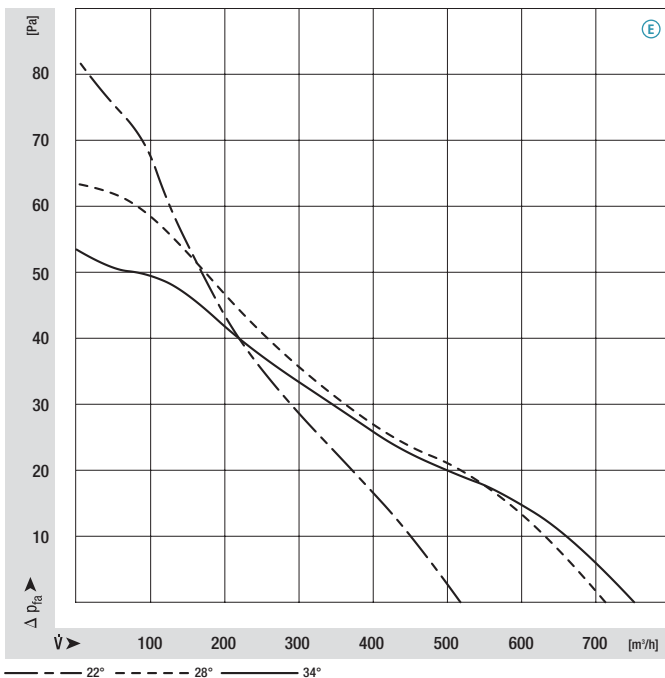

M4Q045-CA03-**, Ø 230, 60 Hz

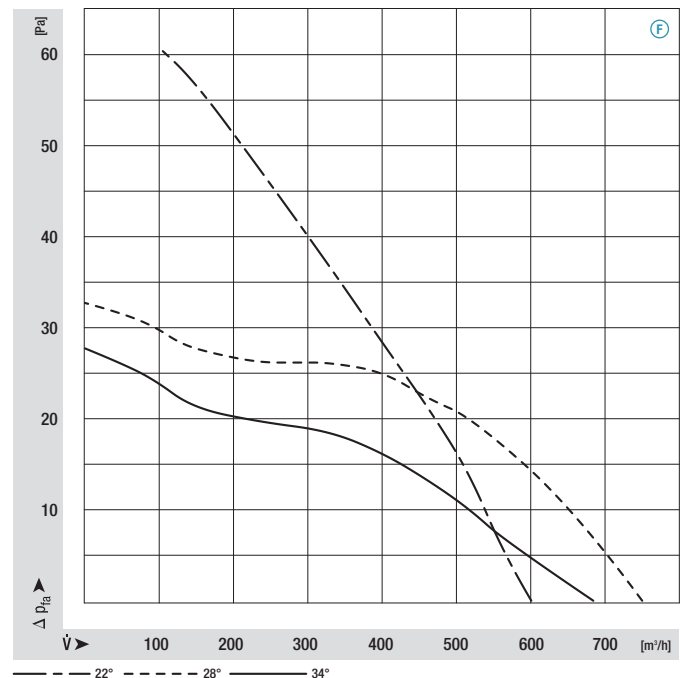

M4Q045-CA03-**, Ø 254, 50 Hz

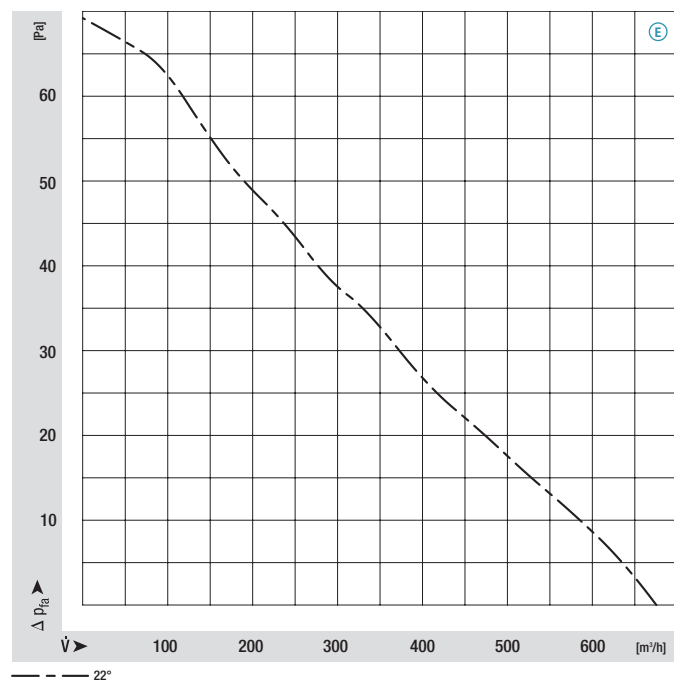

M4Q045-CA03-**, Ø 254, 60 Hz

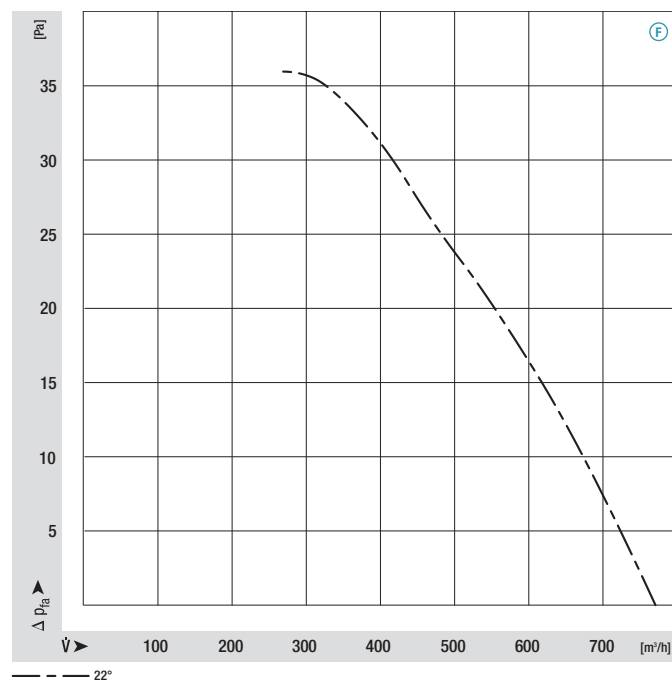

M4Q045-CF01-**, Ø 254, 50 Hz

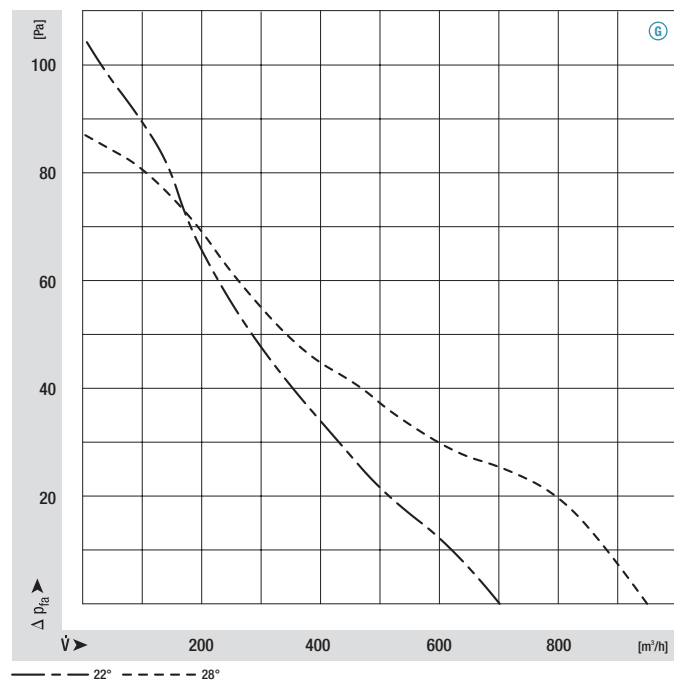

M4Q045-CF01-**, Ø 254, 60 Hz

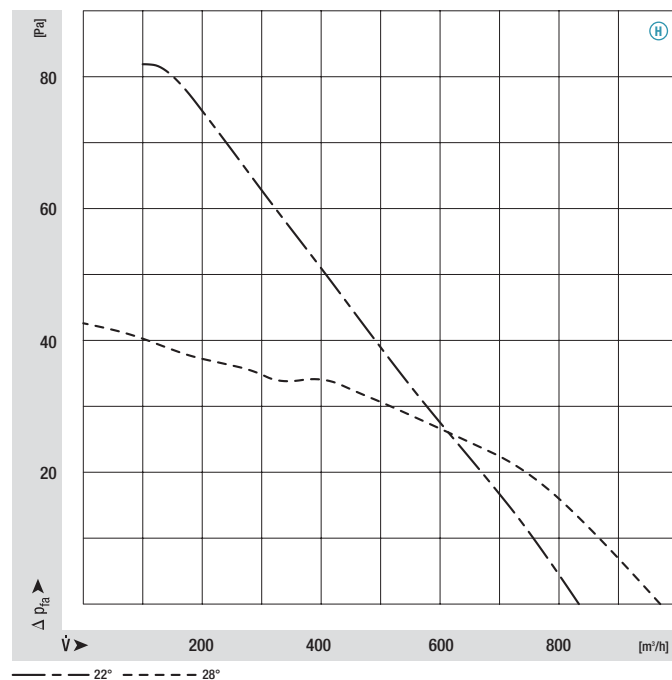

Square shaded-pole motors

Air performance curves (measured in wall ring)

M4Q045-DA01-**, Ø 254, 50 Hz

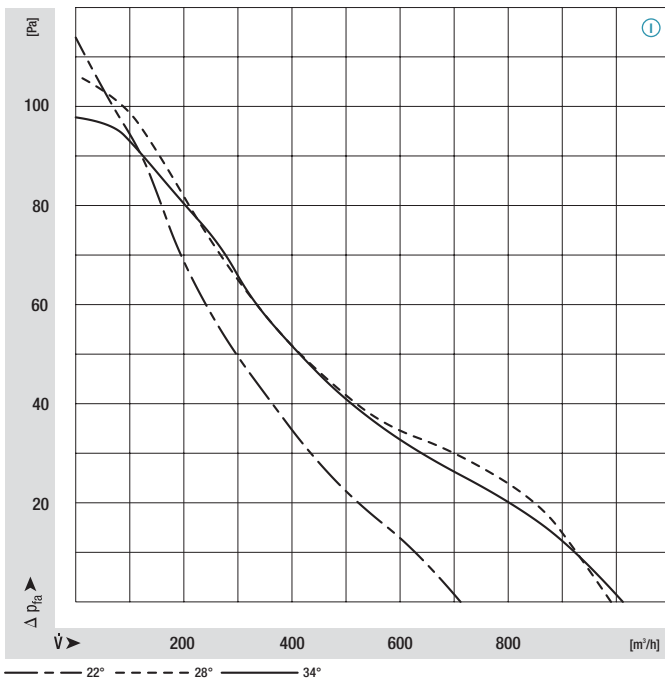

M4Q045-DA01-**, Ø 254, 60 Hz

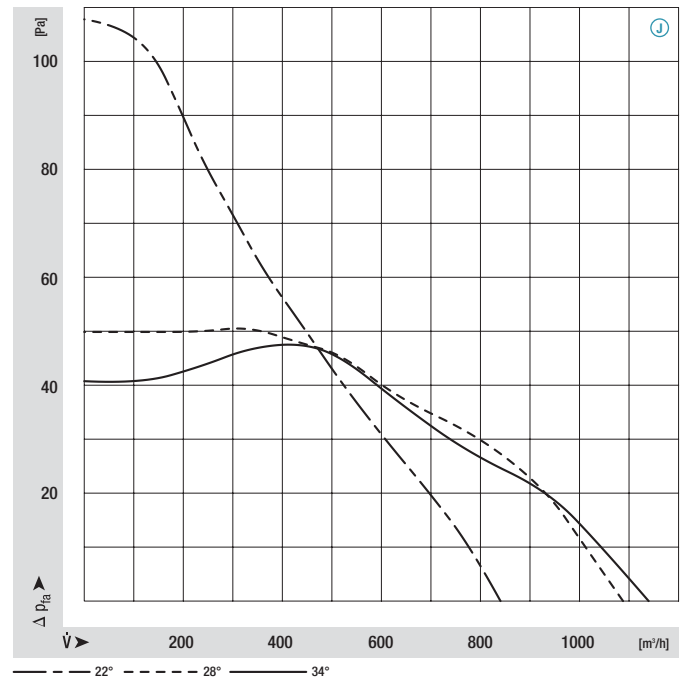

Ⓛ M4Q045-DA01-** / Ⓚ -DA05-**, Ø 300, 50 Hz

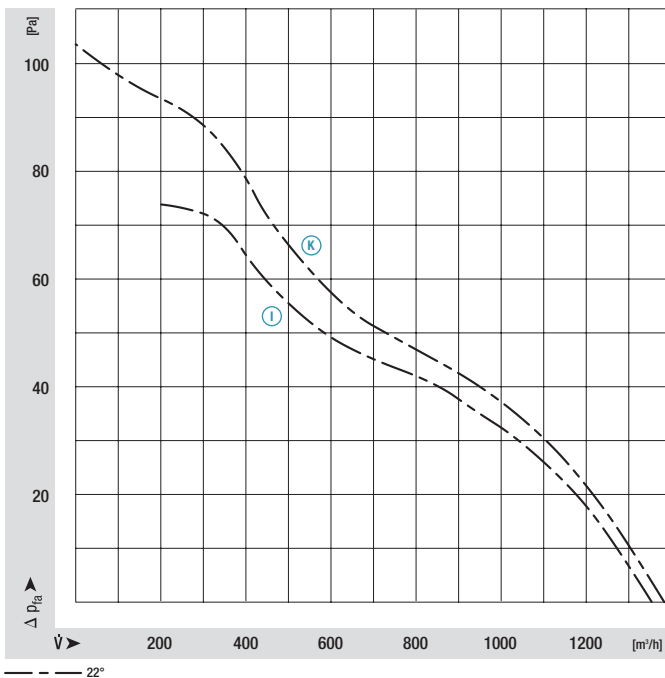

Ⓜ M4Q045-DA01-** / Ⓛ -DA05-**, Ø 300, 60 Hz

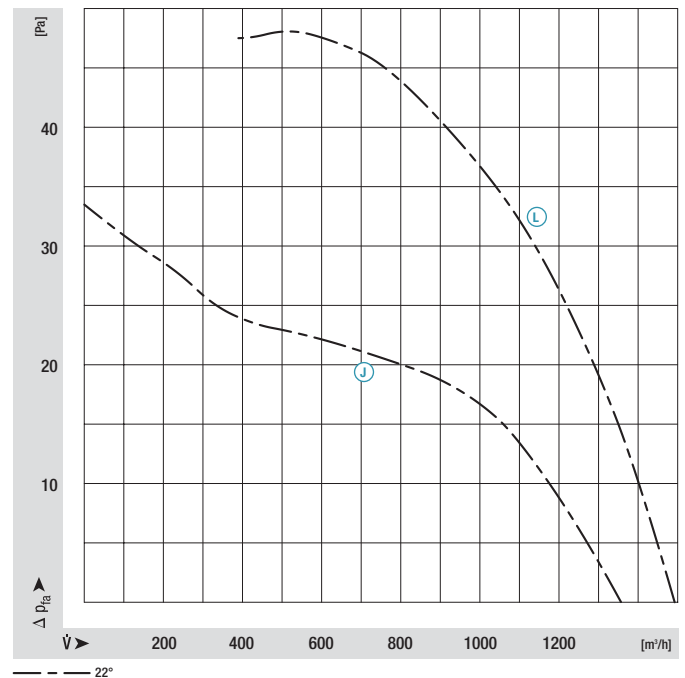

M4Q045-EA01-**, Ø 300, 50 Hz

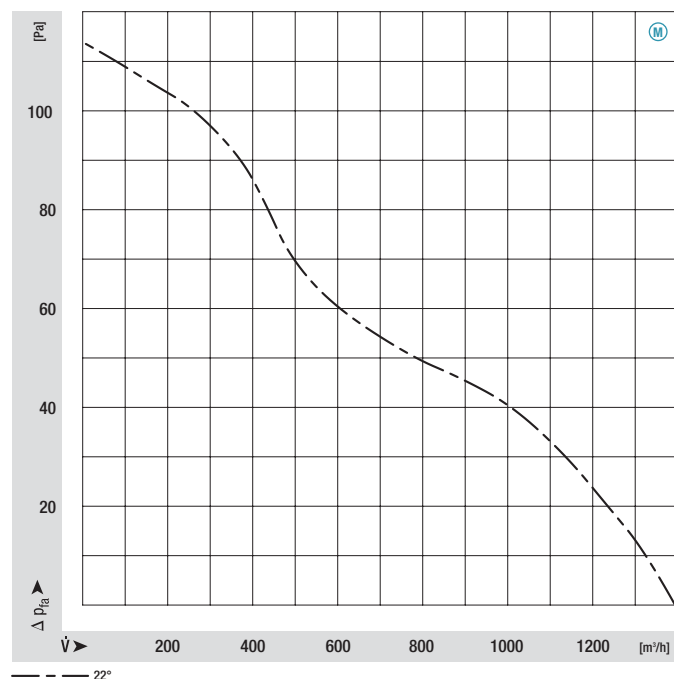

M4Q045-EA01-**, Ø 300, 60 Hz

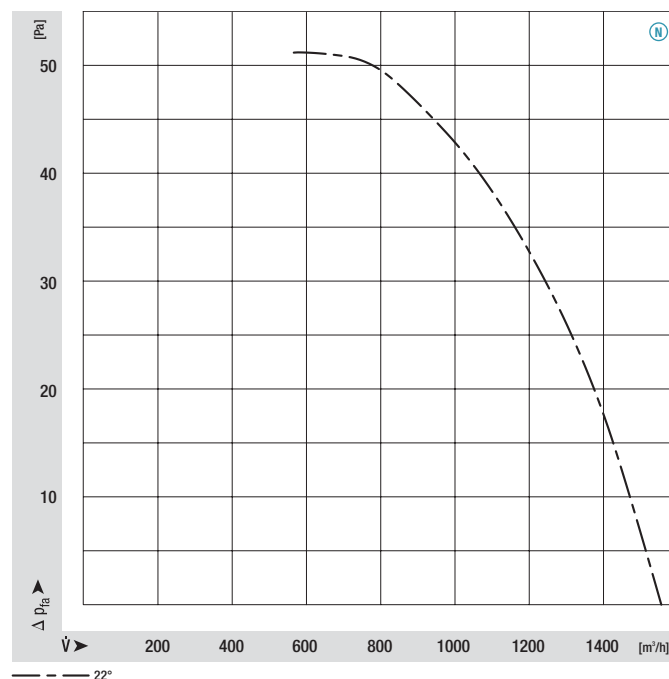

M4Q045-EF01-**, Ø 300, 50 Hz

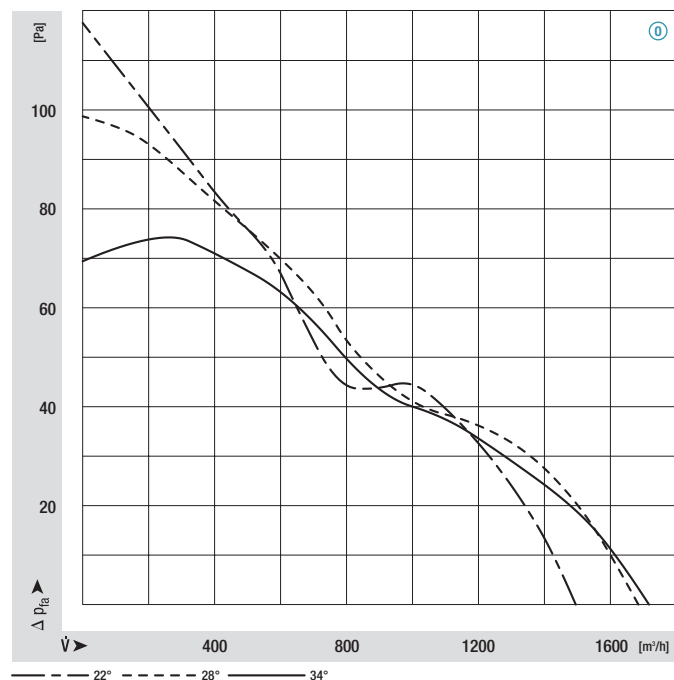

M4Q045-EF01-**, Ø 300, 60 Hz

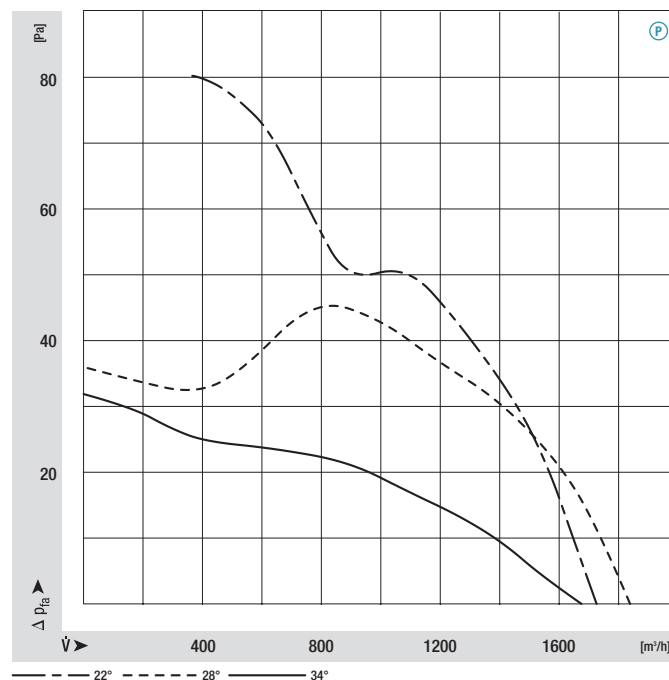



X-ON Electronics

Largest Supplier of Electrical and Electronic Components

Click to view similar products for [AC, DC & Servo Motors](#) category:

Click to view products by [ebm papst](#) manufacturer:

Other Similar products are found below :

[M2E068-DF13-79](#) [79207644](#) [805470B40040MY](#) [80807028](#) [808070Y01125Z](#) [808550Y00049Z](#) [823055C10001MWY](#) [82520405](#) [82664024](#)
[82802504](#) [R88MK10030H](#) [HG16-240-AB-00](#) [M4E068-EC03-01](#) [M4E068-CF01-01](#) [79265119](#) [80510503](#) [805470A40040MY](#)
[805470B40020MY](#) [80627003](#) [808070Y00250Y](#) [808070Y83.33Y](#) [823055A20001MW](#) [825140A40010MP](#) [825290C43.75MX](#) [82714023](#)
[82800003](#) [82830009](#) [82810017](#) [R88M-K90010F-S2](#) [R88M-K1K030H-S2](#) [89830012](#) [82840003](#) [82840004](#) [82869011](#) [82524021](#) [82862202](#)
[82869006](#) [82861013](#) [80803009](#) [80547015](#) [82862205](#) [R88M-K40030T-B](#) [80527006](#) [82330514](#) [81021118](#) [82524004](#) [89800008](#) [82867009](#)
[82662564](#) [82662515](#)