



# 516 SERIES

## RACK AND PANEL CONNECTOR (PLUG AND RECEPTACLE)



- **FEATURES:**
- .150" (3.81mm) Contact Spacing x .130" (3.30mm) or .150" (3.81mm) Row Spacing with staggered Grid
- Plug and Receptacle in 20, 38, 56, 90 and 120 Contact Sizes
- Edacon Hermaphroditic Contact Mating Design
- Contact Termination Options include Crimp, P.C. Tail, Wire Hole and Wire Wrap
- Mating and Unmating Simplified with use of Actuating Screws
- Optional Covers with Side or Top Entry Cable Clamp in Plastic or Metal material Available for all Connector Sizes
- Versatile Metal Cover Design permits Assembly or Disassembly After Cabling is Complete plus Cable Entry Style Flexibility
- Actuating Screws, Locknuts, Polarizing Hardware, Covers and Contacts Suitable for either Plug or Receptacle
- Polarizing Hardware Adjustable for 288 Mating Combinations
- Tools Available for Contact Installation, Removal and Crimping and Polarizing Changes
- RoHS Compliant & UL Certified

### Specifications:

Insulator Material	Diallyl Phthalate, Thermoplastic Polyester or Polycarbonate UL 94V-0
Color	Green or Grey
Contact Material	Copper Alloy
Contact Plating	Gold Plating over Nickel over entire contact
Current Rating	8.5 Amperes
Contact Resistance	10 milliohms maximum
Withstanding Voltage	2000 V AC rms at sea level
Insulation Resistance	5000 Megaohms minimum
Operating Temp	-40°C to +125°C (Diallyl Phthalate Only)
Operating Temp	-40°C to +105°C
Insertion & Withdrawal Force	2 to 16 Oz (0.56 to 4.45N) per contact position

Example Part Number:

**516-038-500-212**

Series \_\_\_\_\_  
 Total Number of Contacts \_\_\_\_\_  
 Contact Code \_\_\_\_\_  
 Style and Material \_\_\_\_\_  
 Cover Code \_\_\_\_\_  
 Hardware Code \_\_\_\_\_

**Cover Code** 4, 5, 6, 7

**Description**

0	No Cover Assembly
1	Plastic Cover, Top Entry Standard Clamp
2	Plastic Cover, Side Entry Standard Clamp
3	Plastic Cover, Top Entry Large Clamp
4	Plastic Cover, Side Entry Large Clamp
5	Metal Cover, Side Entry
6	Metal Cover, Top Entry

**Series** 516

**Total Number of Contacts** 020, 038, 056, 090 or 120

Contact Code 1,2	Description & Tail Size	Tail Length "G"
000	No Contacts Assembled	-----
500	Wire Hole .110 x .024 (2.79 x 0.61)	.245 (6.22)
520	P.C. Tail .25 x .024 (0.64 x 0.61)	.215 (5.46)
540	Wire Wrap .050 x .024 (1.27 x 0.61)	.600 (15.24)
541	Wire Wrap .026 x .024 (0.66 x 0.61)	.620 (15.70)
542	Wire Wrap .050 x .024 (1.27 x 0.61)	.790 (20.07)

**Hardware Code** 8

**Description**

0	No Hardware
1	Actuating Screw & Polarizing Hardware
2	Locknut & Polarizing Hardware
5	Actuating Screw with No Polarizing Hardware
6	Locknut with No Polarizing Hardware

**Style & Material** 3

**Style**

**Insulator Material**

1	Plug	Green Diallyl Phthalate
2	Receptacle	Green Diallyl Phthalate
3	Plug	Grey Polycarbonate
4	Receptacle	Grey Polycarbonate
5	Plug	Green Polyester
6	Receptacle	Green Polyester

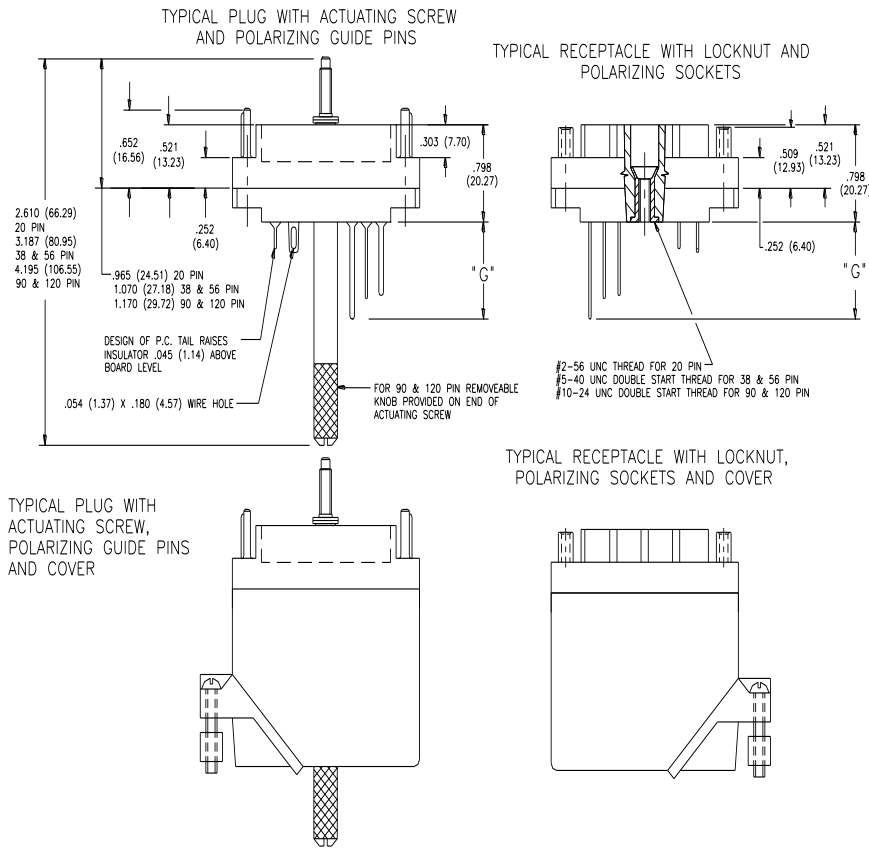

#### Ordering Code Notes

1) Crimp contacts are also available for 516 series connectors. Contacts may be ordered separately for pre-wired or select position assembly.

Part Number	Description	Silhouette
516-290-500	Wire Hole	
516-290-501	Taper Tail	
516-290-520	P.C. Tail	
516-290-540	Wire Wrap	
516-290-541	Wire Wrap	
516-290-542	Wire Wrap	
516-290-590	Crimp (Loose)	
516-294-571	Crimp - 1800 Contact Per Reel	

- For contact installation, removal and crimping tools, Please contact EDAC.
- Grey Polycarbonate and Polyester insulator material are not available for 120 pin size connector.
- 120 pin size connector can only be supplied in DAP (Green and Grey). 120 pin part number ends with 3XX or 4XX are supplied in grey DAP.
- The 20 pin connector cover will not accept the length of the wire wrap contacts
- Plastic covers with large clamps are only available for 38 and 56 pin sizes only
- Metal covers with side entry may be converted to top entry by removing side plate and changing clamp orientation
- Covers may be ordered separately
- Insulator design prevents improper mating of individual plug and receptacle. Polarizing hardware enables specific plug and receptacle combinations

#### Crimp Characteristics

- Contacts and Crimp Tool Accommodate from 28AWG to 18AWG, Solid or Stranded Conductor Diameters from .012 (0.30) to .049 (1.25) and an Insulation diameter up to 0.074 (1.88)
- Multiple Smaller Gauge Wires may be Crimped Together
- Crimp Resistance from 0.5 Milliohms (18AWG) to 1.5 Milliohms(28AWG)
- Crimp Tensile Strength for Wire Sizes
 

18AWG - 40 lbs (178 N)	20AWG - 25 lbs (111 N)
22AWG - 15 lbs (67 N)	24AWG - 10 lbs (44 N)
26AWG - 5 lbs (22 N)	28AWG - 3 lbs (13 N)

#### Polarizing Codes

- Polarizing Hardware Changes allow 288 Mating Combinations
- Standard Code Supplied for Plugs PG1G1, for Receptacle RS1S1.
- Connectors with Special Polarizing Codes Available upon Special Request

Example Polarizing Code:

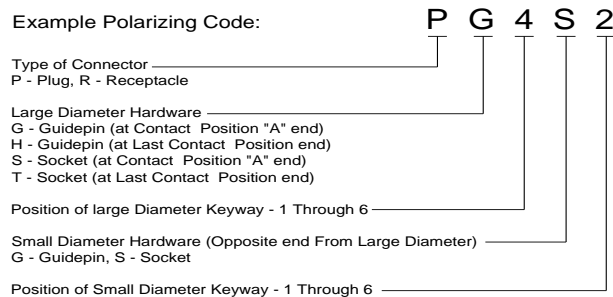

This Example mates with Code RS4G2

#### CONNECTOR MATING FACE VIEWS

DIMENSIONS INDICATED FOR EACH SIZE APPLY TO BOTH PLUG AND RECEPTACLE

20 PIN PLUG

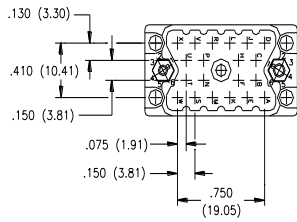

20 PIN RECEPTACLE

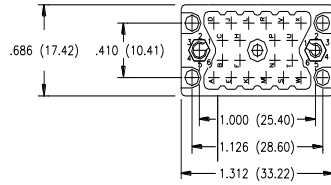

38 PIN PLUG

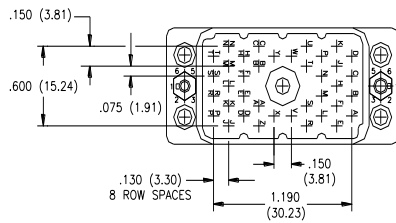

38 PIN RECEPTACLE

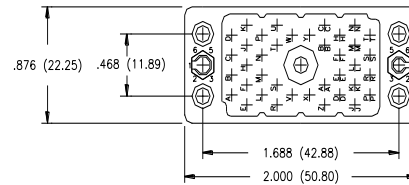

56 PIN PLUG

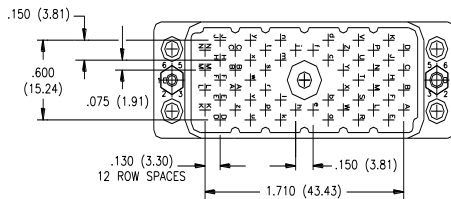

56 PIN RECEPTACLE

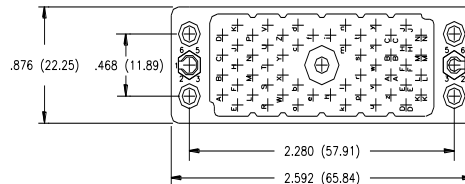

90 PIN PLUG

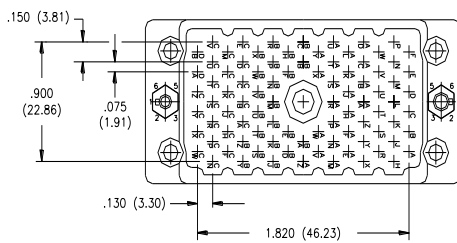

90 PIN RECEPTACLE

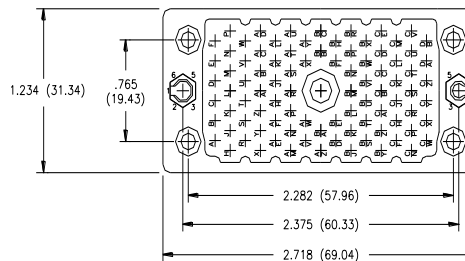

120 PIN PLUG

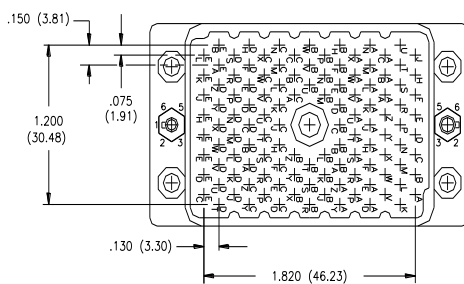

120 PIN RECEPTACLE

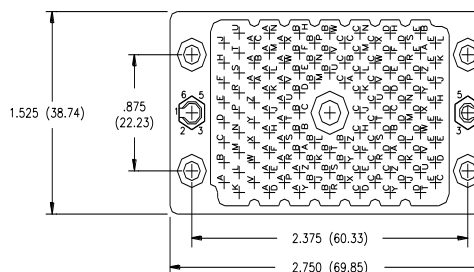



# 516 SERIES

## METAL AND PLASTIC COVERS

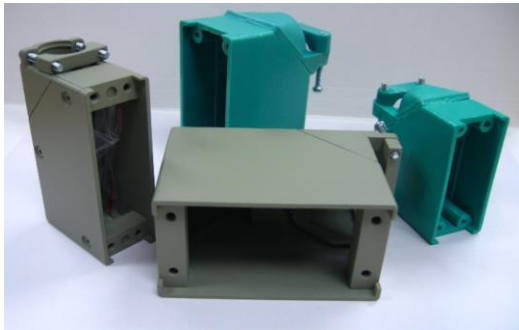

- **FEATURES:**
- Available in Metal (Die-Cast Zinc Finished with Grey enamel Paint) or Plastic (Green polycarbonate) Material
- Covers with Top and Side Entry Cable Clamp. Orientation of Clamp on Metal Covers may be changed by the Customer
- Versatile Metal Cover Design Permits Assembly or Disassembly after Cabling is Complete
- Screws for Securing Cover to 516 or 519 Series Connectors Supplied.
- RoHS Compliant & UL Certified

Example Part Number: **516-230-556**

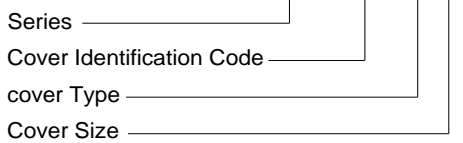

**Series** 516

**Cover Identification Code** 230

Cover Type 1, 2	Description
1	Plastic Cover, Side Entry Standard Clamp
2	Plastic Cover, Top Entry Standard Clamp
3	Plastic Cover, Side Entry Large Clamp
4	Plastic Cover, Top Entry Large Clamp
5	Metal Cover, Side Entry
6	Metal Cover, Top Entry
7	Metal Cover, Large Clamp

Cover Size	Fits Connector
12	516 Series 120 Pin
20	516 Series 20 Pin and 519 Series 14 Pin
38	516 Series 38 Pin and 519 Series 36 Pin
56	516 Series 56 Pin
90	516 Series 90 Pin

### Ordering Code Notes

- 1) Plastic Covers with Large Clamps are only Available for 38 and 56 Pin Connectors.
- 2) Metal Covers with side entry may be converted to top entry by removing side plate and changing clamp orientation.
- 3) For 90 pin size top entry plastic cover must use P/N:516-230-890.

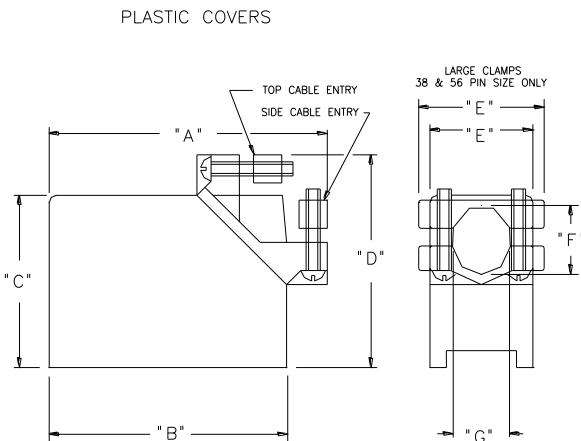
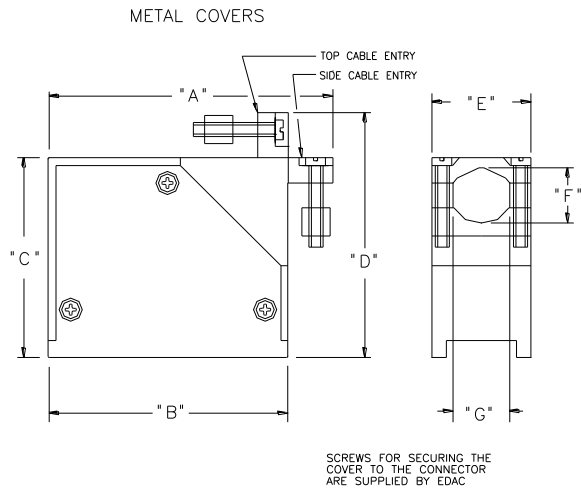

COVER FOR CONNECTOR	COVER MATERIAL	CLAMP SIZE	"A" Inch (mm)	"B" Inch (mm)	"C" Inch (mm)	"D" Inch (mm)	"E" Inch (mm)	"F" Inch (mm)	"G" Inch (mm)
20 PIN	PLASTIC	STANDARD	1.605(40.77)	1.325(33.66)	.906(23.01)	1.190(30.23)	.715(18.16)	.450(11.43)	.450(11.43)
	METAL	STANDARD	1.539(39.09)			1.120(28.45)	.686(17.42)	.446(11.33)	.490(12.45)
38 PIN	PLASTIC	STANDARD	2.460(62.48)	2.010(51.05)	1.530(38.86)	1.985(50.42)	.910(23.11)	.650(16.51)	.500(12.70)
	PLASTIC	LARGE	2.460(62.48)		1.530(38.86)	1.985(50.42)	1.110(28.19)	.650(16.51)	.608(15.44)
	METAL	STANDARD	2.206(56.03)		1.566(39.78)	1.766(44.86)	.875(22.23)	.720(18.29)	.575(14.61)
56 PIN	PLASTIC	STANDARD	3.052(77.52)	2.602(66.09)	1.530(38.86)	1.985(50.42)	.910(23.11)	.650(16.51)	.500(12.70)
	PLASTIC	LARGE	3.052(77.52)		1.530(38.86)	1.985(50.42)	1.110(28.19)	.650(16.51)	.608(15.44)
	METAL	STANDARD	2.802(71.17)		1.566(39.78)	1.766(44.86)	.875(22.23)	.720(18.29)	.575(14.61)
90 PIN	PLASTIC	STANDARD	3.124(79.35)	2.718(69.04)	1.775(45.09)	2.181(55.40)	1.250(31.75)	.800(20.32)	.800(20.32)
	METAL	STANDARD	3.118(79.20)			2.175(55.25)	1.234(31.34)	.880(22.35)	.900(22.86)
120 PIN	PLASTIC	STANDARD	3.156(80.16)	2.750(69.85)	2.020(51.31)	2.426(61.62)	1.530(38.86)	.800(20.32)	.800(20.32)
	METAL	STANDARD	3.175(80.65)			2.445(62.10)	1.531(38.89)	.890(22.61)	1.080(27.43)



# 516 SERIES CRIMP MACHINE AND TOOLS

## FEATURES:

### CONTACT CRIMP MACHINE

- Tooling part numbers: 516-280-700 (electric press) & 516-280-750 (contact applicator)
- Crimp-style contact part number: 516-294-571 (supplied on 1800 pcs reels, ordered separately)
- Guarded for operator safety
- Quick access to the crimp setting adjustment mechanism
- Foot switch operation
- Cycle counter on the front panel
- Each cycle crimps a contact, cuts the contact from the carrier strip and feeds a new contact into position
- Adjustment settings for conductor and insulation
- Crimp settings for common wires between 16 and 28 AWG (confirm application with factory before purchase)
- Mounts to any flat surface
- Electrically operated, specify requirements when ordering: 115V or 230V & 50HZ or 60HZ
- Shipping weight: 450 lbs/204 kg gross

### CONTACT HAND CRIMP TOOL

- Part number 516-280-201
- Crimps contact part number 516-290-590
- Precise tool for hand crimping loose contacts
- Built-in ratchet to prevent under crimping



Part number: 516-280-750



Part number: 516-280-201

### CONTACT EJECTION TOOL

- Part number 516-280-300
- For use with all 516 series contact styles
- Provides easy positive ejection without damage to the insulator

### CRIMP CONTACT INSERTION TOOL

- Part number 516-280-400
- For installing 516-290-590 & -591, 516-294-571 crimp contacts
- Wire groove locates the tool onto the end of the crimp form

### POLARIZING HARDWARE ROUND NUT DRIVER

- Part number 516-280-500
- For removing and tightening round nuts when changing orientation of metal polarizing guide pins and sockets

### WIRE WRAP & P.C. TAIL CONTACT INSERTION TOOL

- Part number 516-280-600
- For installing 516-290-520, -540, -541, -542, -501, and -521 contacts
- Slender tube protects contact tail during insertion without interfering with adjacent contacts



# 516 SERIES RECOMMENDED PCB LAYOUT

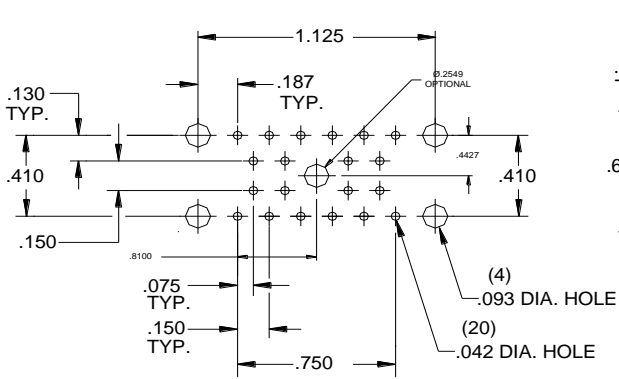

20 PINS

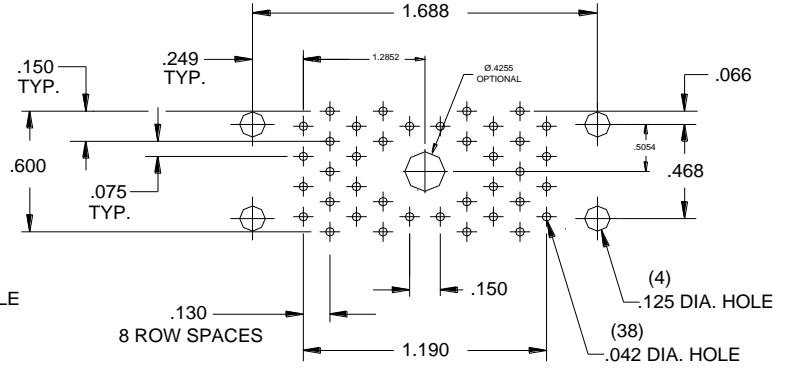

38 PINS

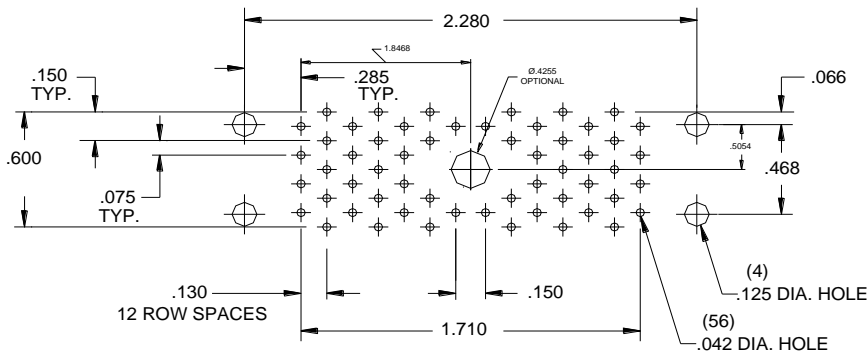

56 PINS

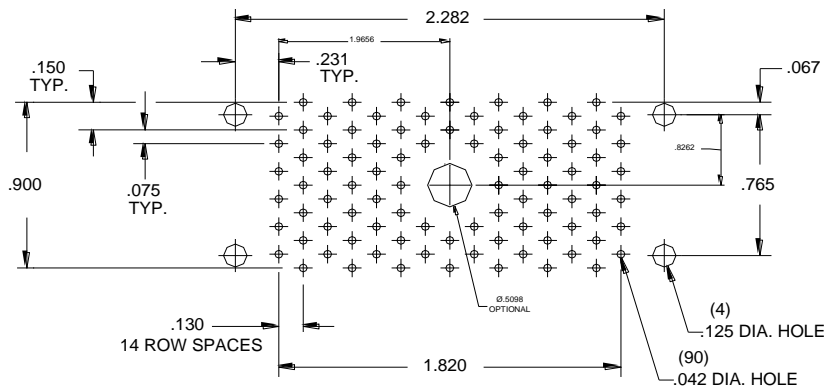

90 PINS

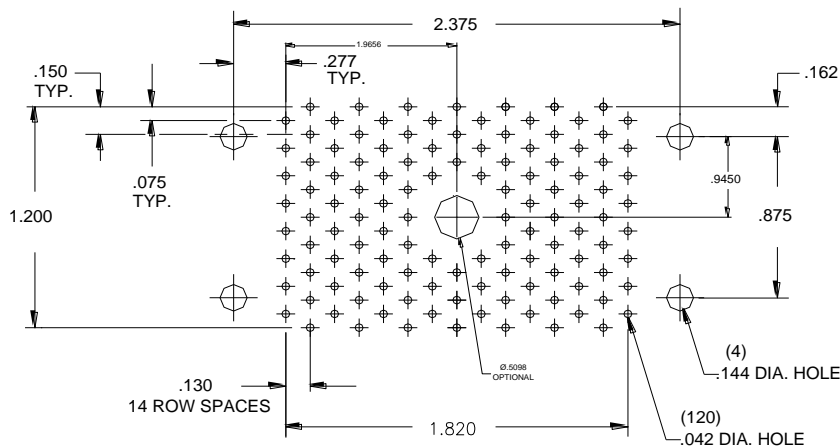

120 PINS

### INSULATOR PLUG 20 CONTACTS

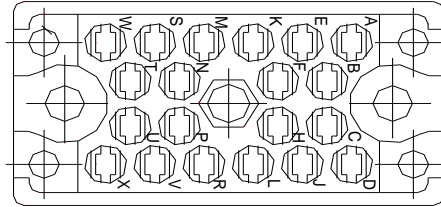

### INSULATOR PLUG 38 CONTACTS

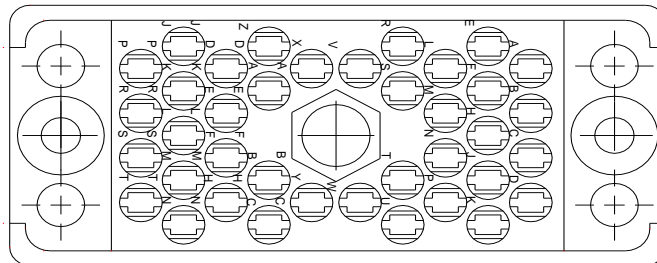

### INSULATOR PLUG 56 CONTACTS

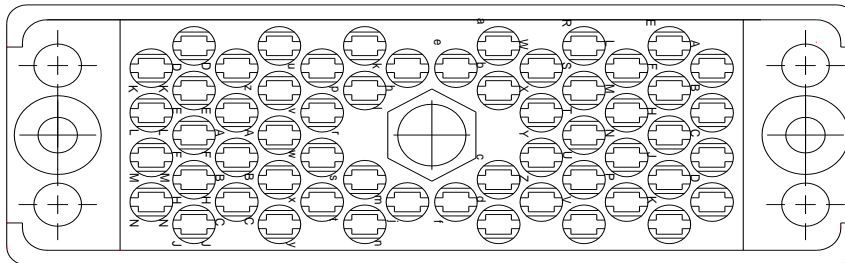

### INSULATOR PLUG 90 CONTACTS

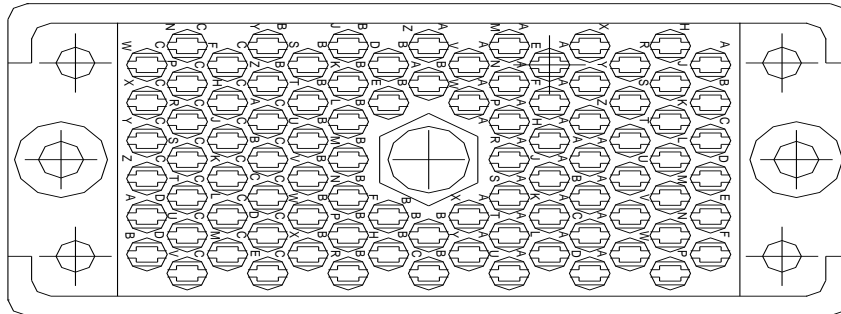

### INSULATOR PLUG 120 CONTACTS

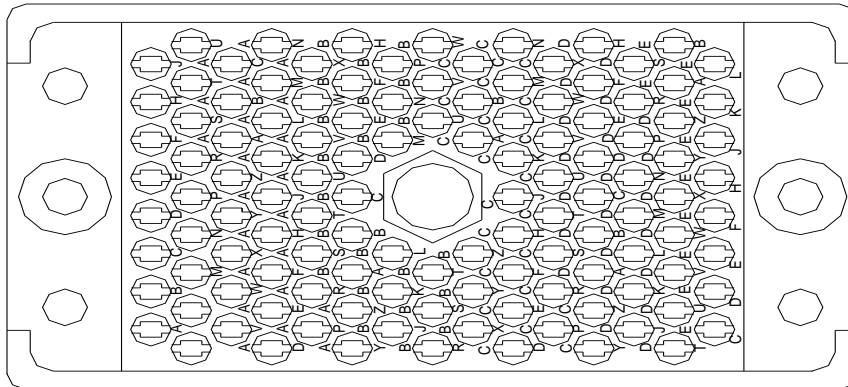



### INSULATOR RECEPTACLE 20 CONTACTS

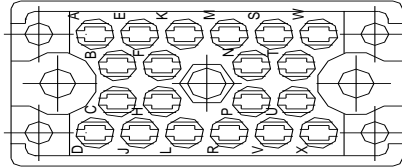

### INSULATOR RECEPTACLE 38 CONTACTS

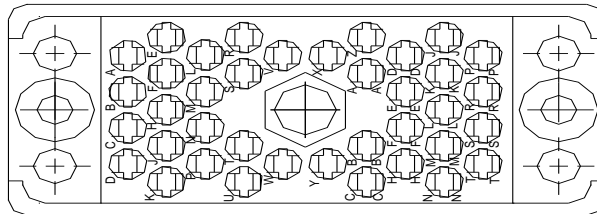

### INSULATOR RECEPTACLE 56 CONTACTS

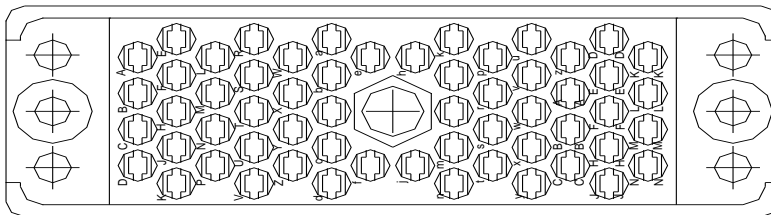

### INSULATOR RECEPTACLE 90 CONTACTS

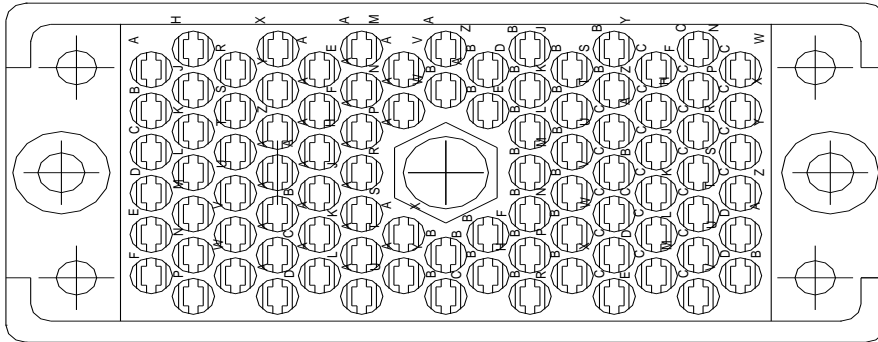

### INSULATOR RECEPTACLE 120 CONTACTS

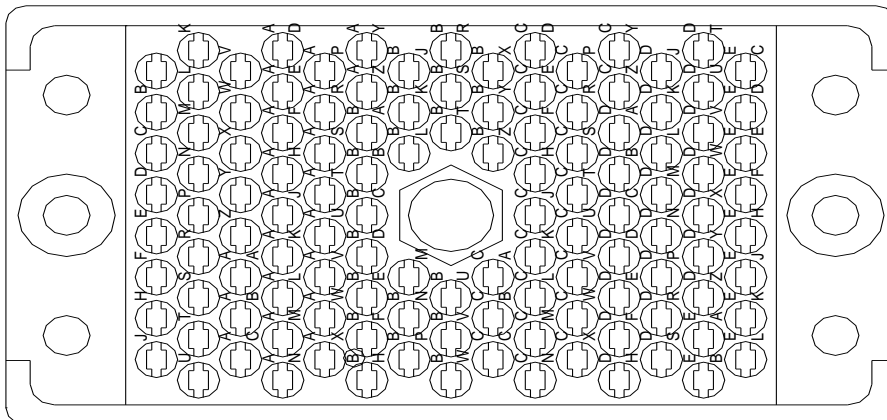

## X-ON Electronics

Largest Supplier of Electrical and Electronic Components

*Click to view similar products for [Extraction, Removal & Insertion Tools](#) category:*

*Click to view products by [EDAC](#) manufacturer:*

Other Similar products are found below :

[M8196914-08](#) [768211-2](#) [809-131](#) [844751-2](#) [8-59558-2](#) [91018-1](#) [12014013](#) [12093647](#) [1-21048-0](#) [R282867020](#) [12093078](#) [12180559](#) [1-21048-6](#) [12121897](#) [DCF.91.405.5LT](#) [1322](#) [13549852](#) [15314260](#) [15313892](#) [15350698](#) [15350707](#) [15430130](#) [1643916-1](#) [1-679532-0](#) [1976593-3](#) [OUTEXT-0321](#) [2-1579008-3](#) [2-1579008-4](#) [229694-7](#) [231106-1](#) [241469](#) [91040-3](#) [91040-7](#) [965004-000](#) [965069-000](#) [1738219-1](#) [ET-JL05-16](#) [FG 0300 146 3000](#) [FIT-6](#) [210S048](#) [2-1579007-9](#) [231879-1](#) [CF-008025-000](#) [312138-3](#) [RJ11FODE](#) [356-162](#) [M8196914-10](#) [4-1579018-0](#) [483249-1](#) [5-1579007-2](#)