

Top View of Assembly

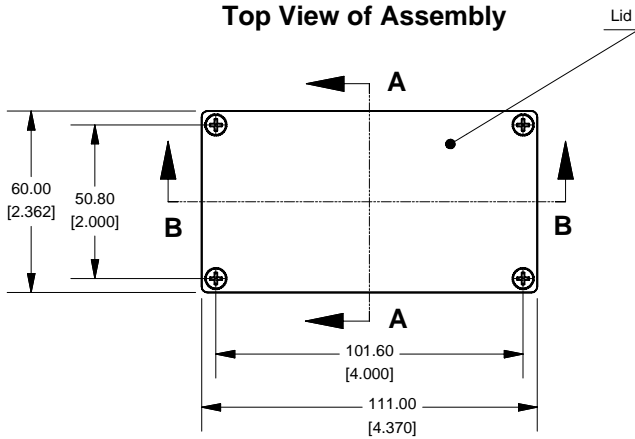

SECTION A-A End View of Assembly

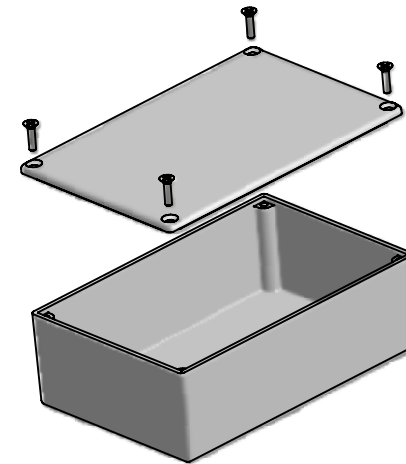
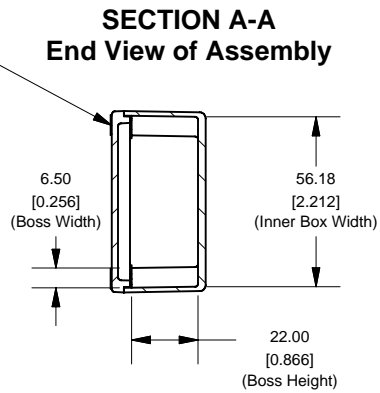

SECTION B-B Side View of Assembly

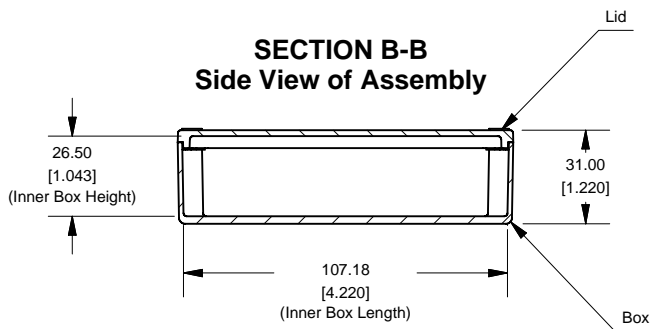

Lid

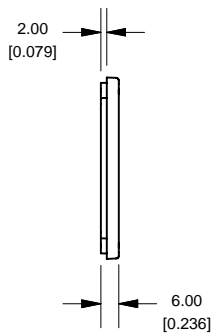
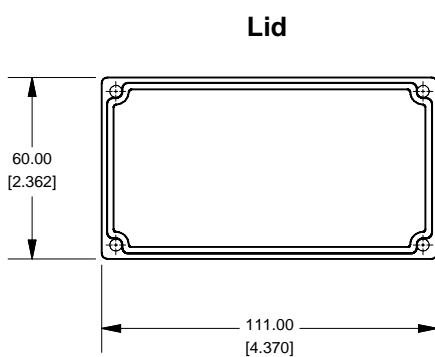

Enclosures can be Factory Modified (Milling, Drilling, Printing etc.)
 Solid models of this enclosure available in STEP or IGES.
 Contact Factory jelkins@hammond-electronics.co.uk

NOTE	
Purchased assembly includes Lid, Box and 4 cover screws.	

Eddystone 27134PSLA	
PART INFORMATION	
Part Number:	27134PSLA
Material:	LM2 / LM24 Diecast Aluminum Alloy
Cover Screw Type:	M3.5 x 10mm Countersunk (Screw Torque 75 oz f.in or 55 cN. m)

**HAMMOND
MANUFACTURING™**

27134PSLA
www.hammondmfg.com

X-ON Electronics

Largest Supplier of Electrical and Electronic Components

Click to view similar products for [eddystone](#) manufacturer:

Other Similar products are found below :

[70011](#) [11130PSLA](#) [26357PSLA](#) [10758PSLA](#) [26908PSLA](#) [29830PSLA](#) [27134PSLA](#)