

1SMB5913B - 1SMB5956B

SILICON ZENER DIODES

V_Z : 3.3 - 200 Volts

P_D : 3.0 Watts

FEATURES :

- * Complete Voltage Range 3.3 to 200 Volts
- * High peak reverse power dissipation
- * Flat handling surface for accurate placement
- * Low leakage current
- * **Pb / RoHS Free**

MECHANICAL DATA

- * Case : SMB Molded plastic
- * Epoxy : UL94V-0 rate flame retardant
- * Lead : Lead Formed for Surface Mount
- * Polarity : Color band denotes cathode end
- * Mounting position : Any
- * Weight : 0.108 gram

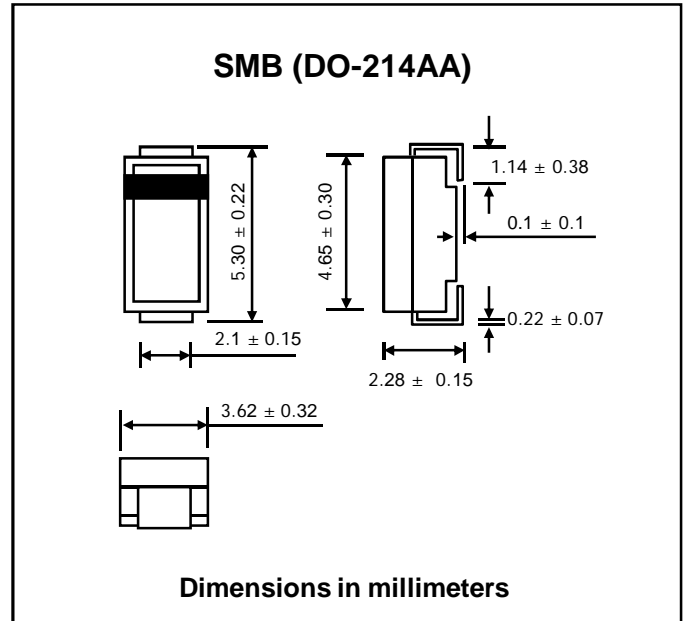

MAXIMUM RATINGS

Rating	Symbol	Value	Unit
Maximum Steady State Power Dissipation at T _L = 75°C, Measured at Zero Lead Length Derate Above 75 °C	P _D	3.0	W
Thermal Resistance From Junction to Lead	R _{θJL}	40	mW/°C
Maximum Steady State Power Dissipation at Ta = 25 °C Measured at Zero Lead Length Derate Above 25 °C	P _D	25	°C/W
Thermal Resistance From Junction to Ambient	R _{θJA}	4.4	mW/°C
Maximum Forward Voltage at I _F = 200 mA	V _F	226	°C/W
Junction Temperature Range	T _J	1.5	Volts
Storage Temperature Range	T _{stg}	- 65 to + 150	°C
		- 65 to + 150	°C

ELECTRICAL CHARACTERISTICS

Rating at $T_L = 30\text{ }^\circ\text{C}$ unless otherwise specified

TYPE	Nominal Zener Voltage		Maximum Zener Impedance			Maximum Reverse Leakage Current		Maximum DC Zener Current
	$V_Z @ I_{ZT}$	I_{ZT}	$Z_{ZT} @ I_{ZT}$	$Z_{ZK} @ I_{ZK}$	I_{ZK}	$I_R @ V_R$		I_{ZM}
	(V)	(mA)	(Ω)	(Ω)	(mA)	(μA)	(V)	(mA)
1SMB5913B	3.3	113.6	10	500	1.0	100	1.0	454
1SMB5914B	3.6	104.2	9.0	500	1.0	75	1.0	416
1SMB5915B	3.9	96.1	7.5	500	1.0	25	1.0	384
1SMB5916B	4.3	87.2	6.0	500	1.0	5.0	1.0	348
1SMB5917B	4.7	79.8	5.0	500	1.0	5.0	1.5	319
1SMB5918B	5.1	73.5	4.0	400	1.0	5.0	2.0	294
1SMB5919B	5.6	66.9	2.0	300	1.0	5.0	3.0	267
1SMB5920B	6.2	60.5	2.0	200	1.0	5.0	4.0	241
1SMB5921B	6.8	55.1	2.5	200	1.0	5.0	5.2	220
1SMB5922B	7.5	50.0	3.0	400	0.5	5.0	6.0	200
1SMB5923B	8.2	45.7	3.5	400	0.5	5.0	6.5	182
1SMB5924B	9.1	41.2	4.0	500	0.5	5.0	7.0	164
1SMB5925B	10	37.5	4.5	500	0.25	5.0	8.0	150
1SMB5926B	11	34.1	5.5	550	0.25	1.0	8.4	136
1SMB5927B	12	31.2	6.5	550	0.25	1.0	9.1	125
1SMB5928B	13	28.8	7.0	550	0.25	1.0	9.9	115
1SMB5929B	15	25.0	9.0	600	0.25	1.0	11.4	100
1SMB5930B	16	23.4	10	600	0.25	1.0	12.2	93
1SMB5931B	18	20.8	12	650	0.25	1.0	13.7	83
1SMB5932B	20	18.7	14	650	0.25	1.0	15.2	75
1SMB5933B	22	17.0	17.5	650	0.25	1.0	16.7	68
1SMB5934B	24	15.6	19	700	0.25	1.0	18.2	62
1SMB5935B	27	13.9	23	700	0.25	1.0	20.6	55
1SMB5936B	30	12.5	26	750	0.25	1.0	22.8	50
1SMB5937B	33	11.4	33	800	0.25	1.0	25.1	45
1SMB5938B	36	10.4	38	850	0.25	1.0	27.4	41
1SMB5939B	39	9.6	45	900	0.25	1.0	29.7	38
1SMB5940B	43	8.7	53	950	0.25	1.0	32.7	34
1SMB5941B	47	8.0	67	1000	0.25	1.0	35.8	31
1SMB5942B	51	7.3	70	1100	0.25	1.0	38.8	29
1SMB5943B	56	6.7	86	1300	0.25	1.0	42.6	26
1SMB5944B	62	6.0	100	1500	0.25	1.0	47.1	24
1SMB5945B	68	5.5	120	1700	0.25	1.0	51.7	22
1SMB5946B	75	5.0	140	2000	0.25	1.0	56.0	20
1SMB5947B	82	4.6	160	2500	0.25	1.0	62.2	18
1SMB5948B	91	4.1	200	3000	0.25	1.0	69.2	16
1SMB5949B	100	3.7	250	3100	0.25	1.0	76.0	15
1SMB5950B	110	3.4	300	4000	0.25	1.0	83.6	13
1SMB5951B	120	3.1	380	4500	0.25	1.0	91.2	12
1SMB5952B	130	2.9	450	5000	0.25	1.0	98.8	11
1SMB5953B	150	2.5	600	6000	0.25	1.0	114.0	10
1SMB5954B	160	2.3	700	6500	0.25	1.0	121.6	9.0
1SMB5955B	180	2.1	900	7000	0.25	1.0	136.8	8.0
1SMB5956B	200	1.9	1900	9990	0.25	1.0	152.0	7.0

Note :

(1) Suffix " B " indicates $\pm 5\%$ tolerance, suffix " A " indicates $\pm 10\%$ tolerance.

RATING AND CHARACTERISTIC CURVES (1SMB5913B - 1SMB5956B)

FIG. 1 - POWER TEMPERATURE DERATING CURVE

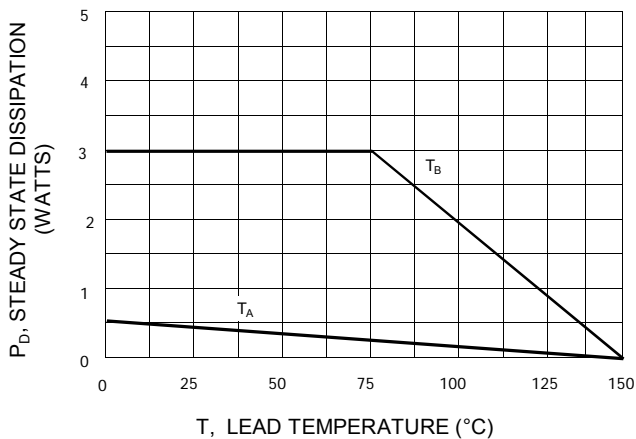

FIG. 3 - MAXIMUM SURGE POWER

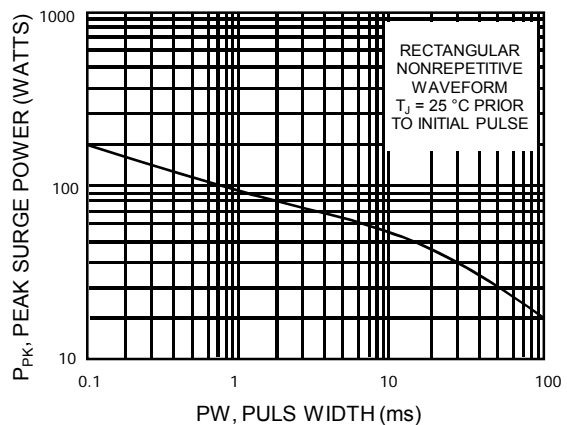

FIG. 5 - TEMPERATURE COEFFICIENT RANGES UNITS TO 12 VOLTS

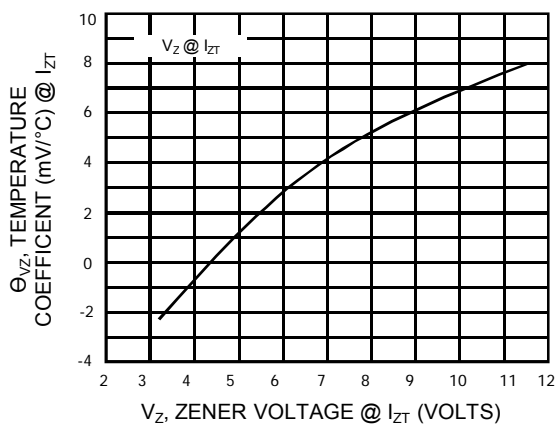

FIG. 6 - TEMPERATURE COEFFICIENT RANGES UNITS 10 TO 400 VOLTS

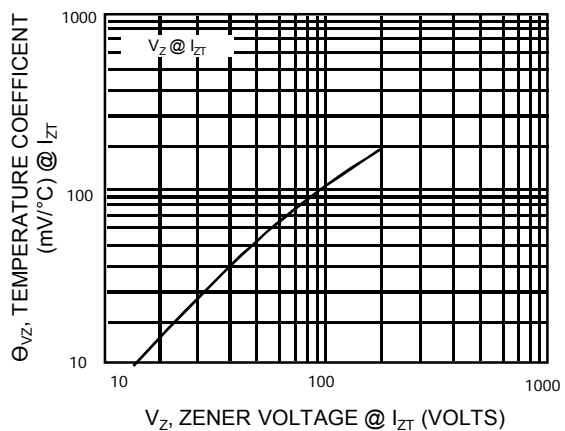

FIG. 7 - ZENER VOLTAGE VS. ZENER CURRENT V_Z = 3.3 thru 10 VOLTS

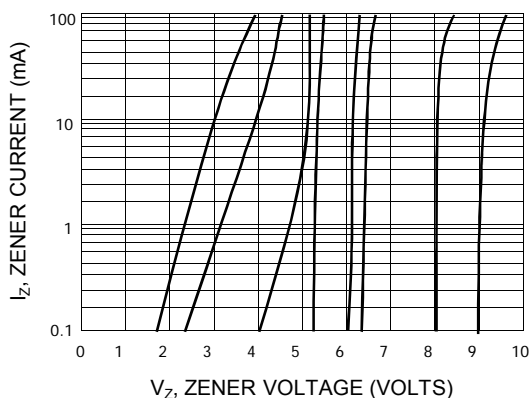
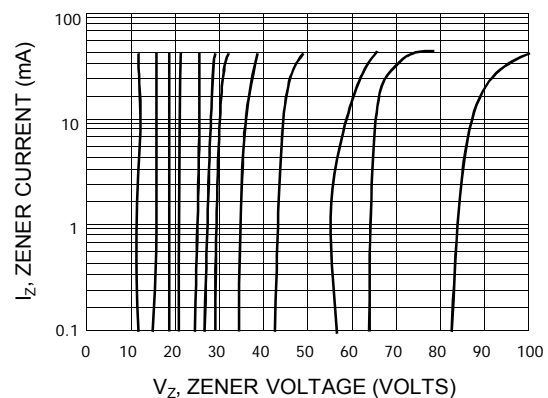

FIG. 8 - ZENER VOLTAGE VS. ZENER CURRENT V_Z = 12 thru 82 VOLTS



X-ON Electronics

Largest Supplier of Electrical and Electronic Components

Click to view similar products for [Zener Diodes](#) category:

Click to view products by [EIC Semiconductor](#) manufacturer:

Other Similar products are found below :

[RKZ13B2KG#P1](#) [DL5234B](#) [EDZTE6113B](#) [1N4682](#) [1N4691](#) [1N4693](#) [1N4732A](#) [1N4736A](#) [1N4750A](#) [1N4759ARL](#) [1N5241B](#) [1N5365B](#)
[1N5369B](#) [1N747A](#) [1N959B](#) [1N964B](#) [1N966B](#) [1N968B](#) [1N972B](#) [NTE5121A](#) [NTE5147A](#) [NTE5152A](#) [NTE5155A](#) [NTE5164A](#)
[JANS1N4974US](#) [JANTX1N5907](#) [1N4692](#) [1N4700](#) [1N4702](#) [1N4704](#) [1N4711](#) [1N4714](#) [1N4737A](#) [1N4745ARL](#) [1N4752A](#) [1N4752ARL](#)
[1N4760ARL](#) [1N5221B](#) [1N5231B-TR](#) [1N5236B](#) [1N5241BTR](#) [1N5242BTR](#) [1N5350B](#) [1N5352B](#) [1N961BRR1](#) [1N964BRL](#) [RKZ5.1BKU#P6](#)
[3SMAJ5946B-TP](#) [3SMAJ5950B-TP](#) [3SMBJ5925B-TP](#)