

LIGHT EMITTING DIODE SPECIFICATION

| | |
|--------------|-----------------|
| DESCRIPTION: | E6C1205VGAC1UDA |
| REVISION: | V2.2 |
| ISSUE DATE: | 2022-01-18 |

Contains trade secret information which is the property of Ekinglux and shall not be made available to, or copied or used by anyone outside Ekinglux without its written authorization. Copyright © 2017 Ekinglux Optoelectronics Technology Co., Ltd. All rights reserved

Features:

- RoHS compliant
- Long operating life
- Ideal for backlight and indicator
- Various Colors brightness Available
- Moisture sensitivity level: 3

Application:

- Backlight
- Decoration lighting
- motormeter
- Indicator

| Part Number | Dice Material | Emitted Color | Lens Color |
|-----------------|---------------|---------------|-------------|
| E6C1205VGAC1UDA | InGaN | Green | Water Clear |

Electro-Optical Characteristics ($T_a=25^{\circ}\text{C}$, @20mA)

| Parameter | Symbol | Min. | Typ. | Max. | Unit |
|---------------------|-----------------|------|------|------|------|
| Luminous Intensity | IV | 400 | 600 | 1000 | mcd |
| Radiation Bandwidth | $\Delta\lambda$ | - | 35 | - | nm |
| Forward Voltage | VF | 2.90 | 3.00 | 3.40 | v |
| Peak Wavelength | λ_p | - | 518 | - | nm |
| Dominant Wavelength | λ_d | 517 | 525 | 535 | nm |
| CIE Coordinates CIE | x,y | - | - | - | - |
| Color Temperature | Tc | - | - | - | k |
| Viewing Angle | $2\theta_{1/2}$ | - | 120 | - | deg |
| Reverse Current | IR | - | - | 10 | uA |

Absolute Maximum Ratings ($T_a=25^{\circ}\text{C}$)

| Parameter | Symbol | Max. | Unit |
|--|--------|-----------------------------------|--------------------|
| Power Dissipation | Pd | 85 | mW |
| Peak Forward Current(1/10 Duty Cycle, 0.1ms Pulse Width) | IFP | 100 | mA |
| Forward Current | IF | 25 | mA |
| Reverse Voltage | VR | 5 | v |
| Electrostatic Discharge | ESD | 2000 | v |
| Operating Temperature Range | Topr | -40to+85 | $^{\circ}\text{C}$ |
| Storage Temperature Range | Tstg | -40to+90 | $^{\circ}\text{C}$ |
| Reflow Soldering | Tsld | 260 $^{\circ}\text{C}$ for 10secs | |



Optical & Electrical Characteristics

Relative Intensity vs.Wavelength

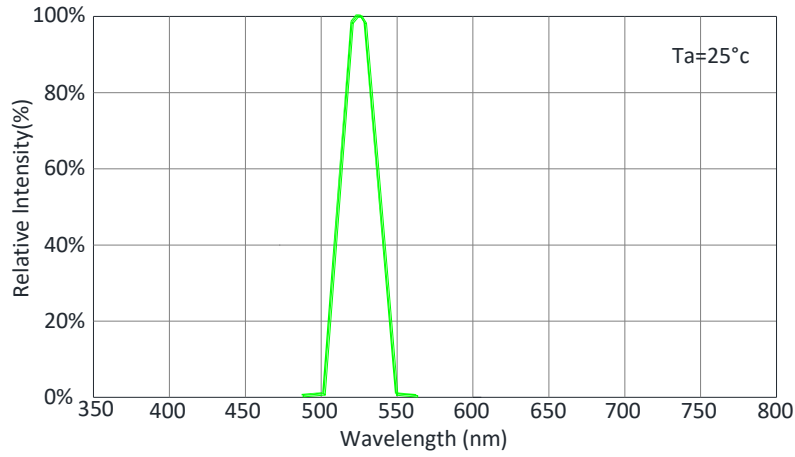

Forward Current vs.Forward Voltage

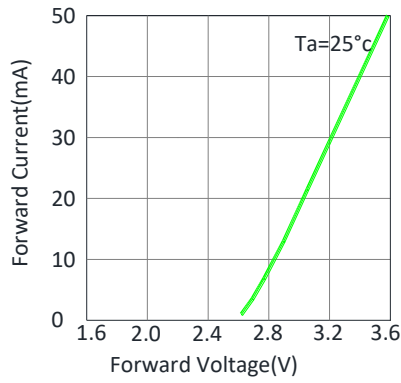

Maximum Driving Forward DC Current vs.Ambient Temperature(De-rating based on Tj max.=115°C)

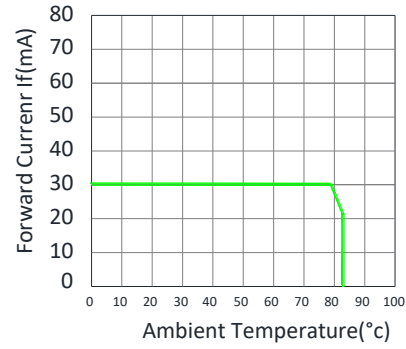

Relative Intensity vs.Forward Current

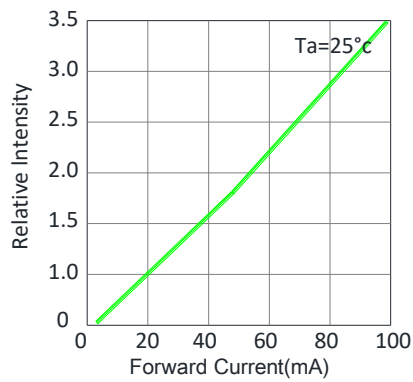

Relative Intensity vs.Ambient Temperature

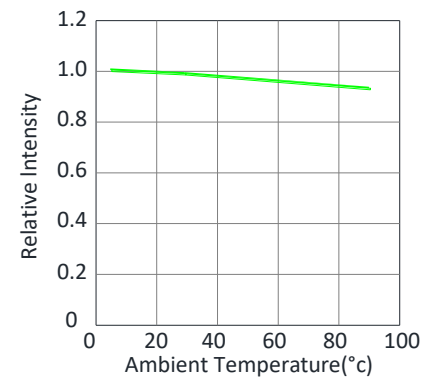

Radiation Pattern

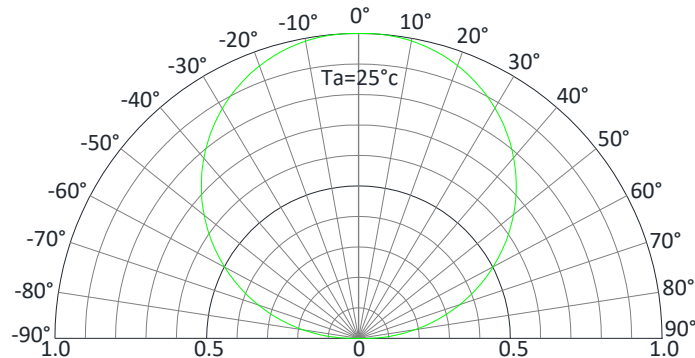



Bin Limits

Bin Range Of Luminous Intensity (Unit:mcd)

| Bin Code | Min | Max | Condition |
|----------|-----|------|-----------|
| L1 | 400 | 600 | IF=20mA |
| L2 | 600 | 800 | |
| L3 | 800 | 1000 | |

Bin Range Of Forward Voltage (Unit:V)

| Bin Code | Min | Max | Condition |
|----------|-----|-----|-----------|
| V1 | 2.9 | 3.0 | IF=20mA |
| V2 | 3.0 | 3.1 | |
| V3 | 3.1 | 3.2 | |
| V4 | 3.2 | 3.3 | |
| V5 | 3.3 | 3.4 | |

Bin Range Of Wavelength (Unit:nm)

| Bin Code | Min | Max | Condition |
|----------|-----|-----|-----------|
| G1 | 517 | 520 | IF=20mA |
| G2 | 520 | 523 | |
| G3 | 523 | 526 | |
| G4 | 526 | 529 | |
| G5 | 529 | 532 | |
| G6 | 532 | 535 | |

Notes:

- 1.Tolerance of Luminous Intensity ±10%
- 2.Tolerance of Forward Voltage ±0.1V

**Reliability Test Items And Conditions**

| Test Items | Reference | Test Conditions | Time | Quantity | Criterion |
|---|----------------------------|---------------------------------|---------------|----------|-----------|
| Thermal Shock | MIL-STD-202G | -40°C (30min) -100°C (30min) | 100 Cycles | 22 | 0/22 |
| Temperature And Humidity Cyclic | JEITA ED-4701 200 203 | -10°C~65°C ; 0%~90%RH | 10cycles | 22 | 0/22 |
| High Temperature Storage | JEITA ED -4071 200 201 | Ta=100°C | 1000H | 22 | 0/22 |
| Low Temperature Storage | JEITA ED -4071 200 202 | Ta=-40°C | 1000H | 22 | 0/22 |
| High Temperature High Humidity Storage | JEITA ED -4071 100 103 | Ta=60°C ; RH=90% | 1000H | 22 | 0/22 |
| High Temperature Life Test | JESD22-A108D | Ta=80°C | 1000H | 22 | 0/22 |
| Life Test | JESD22-A108D | Ta=25°C IF=20mA | 1000H | 22 | 0/22 |
| Resistance to Sodering Heat | GB/T 4937, II , 2.2&2.3 | Tsol*=(240±5) °C 10secs | 2 times | 22 | 0/22 |

Criteria For Judging Damage

| Test Items | Symbol | Test Conditions | Criteria For Judging Damage |
|---------------------------------|----------------|---------------------------------|---|
| Forward Voltage | V _F | I _F =I _{FT} | Initial Data±10% |
| Recerse Current | I _R | V _R =5V | I _R ≤10uA |
| Luminous Intensity | I _V | I _F =I _{FT} | Average I _V degradation≤30% ; Single LED I _V degradation≤50% |
| Resistance to Soldering Heat | - | - | Meterial without internal cracks,no meterial between stripped,no deaded light |

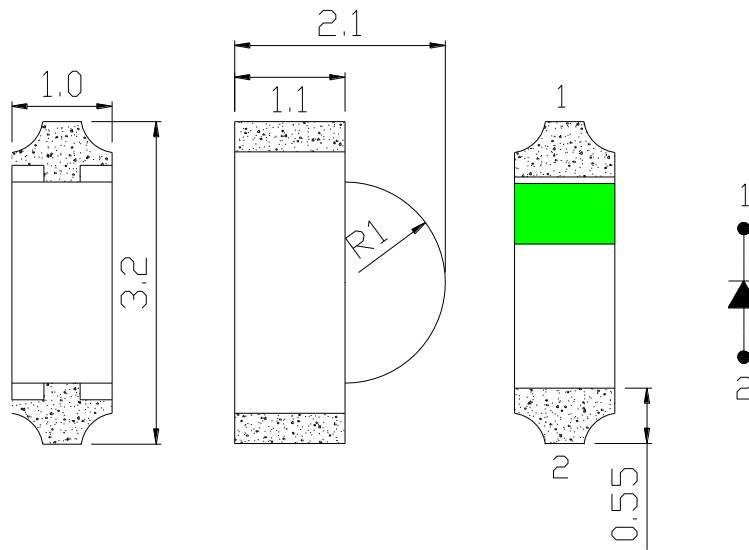
Product size (Unit:mm)

NOTES :

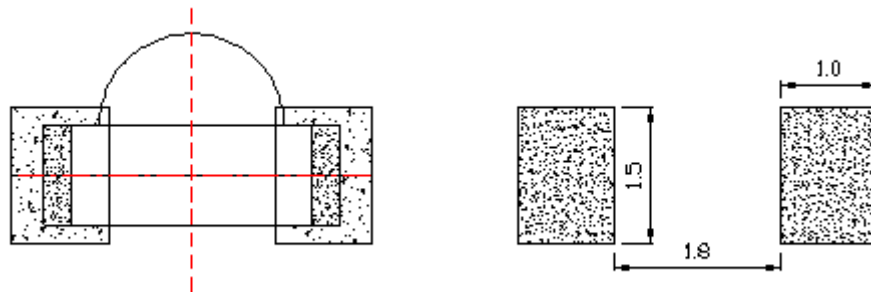
1. All dimensions are in millimeters (inches)
2. Tolerances are $\pm 0.2\text{mm}$ (0.008inch) unless otherwise noted

Recommended Soldering Pad Design (Unit:mm)

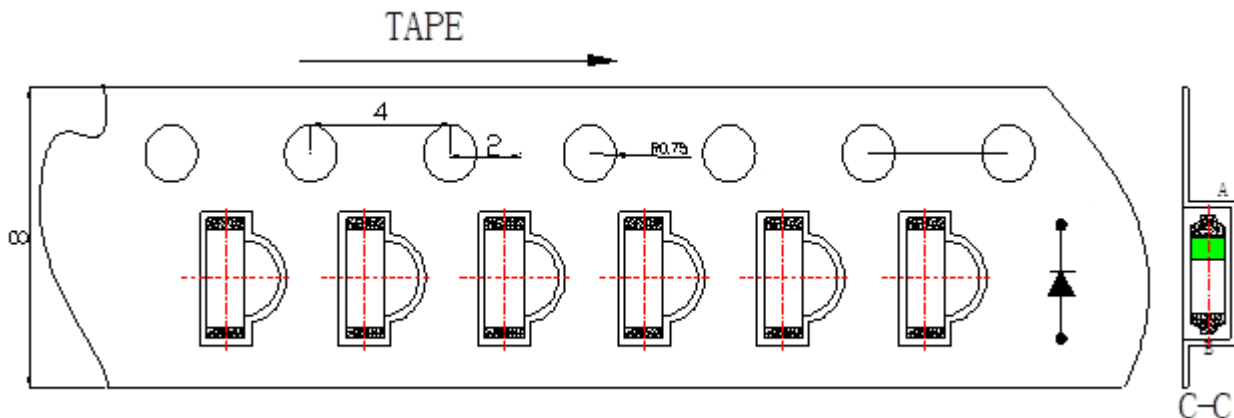
Taping and package Spec

- Tape Specification:3,000pcs Per Reel

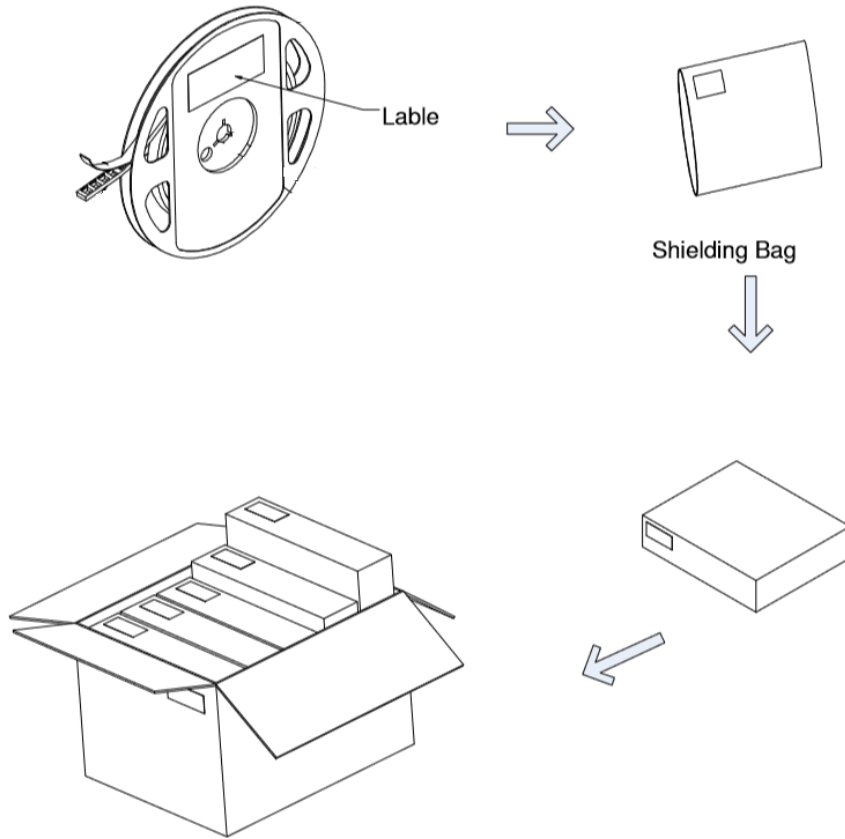

Packaging



LabelStyle

EKIINGLUX OPTOELECTRONICS(SHANGHAI) CO.,LTD
 TEL:86 21 59909181 Sales@ekingluxs.com

 P/N:XXXXXXXXXXXXXXXXXX

Emitting Color: XXXX
 HUE: XXX-XXX nm
 IV : XXX-XXX mcd *example*
 VF: XX-XX V
 QTY: XX PCS



 BIN Code: XX
 DATE: XXXX/XX/XX

 LOT NO.:XXXXXXX

Table of Classification Reflow Profiles

| Profile Feature | Sn-Pb Eutectic Assembly | Pb-Free Assembly |
|--|-------------------------|------------------|
| Preheat & Soak | 100 °C | 150 °C |
| Temperature min (T _{smin}) | 150°C | 200 °C |
| Temperature max (T _{smax}) | 60-120 seconds | 60-120 seconds |
| Time (T _{smin} to T _{smax}) (t _s) | | |
| Average ramp-up rate (T _{smax} to T _p) | 3 °C/second max | 3 °C/second max |
| Liquidous temperature (T _L) | 183 °C | 217 °C |
| Time at liquidous (t _L) | 60-150 seconds | 60-150 seconds |
| Peak package body temperature (T _p)* | 230 °C ~235 °C | 255 °C ~260 °C |
| Classification temperature (T _c) | 235 °C | 260 °C |
| Time (t _p) within 5 °C of the specified Classification temperature (T _c) | 20 seconds | 30 seconds |
| Average ramp-down rate (T _p to T _{smax}) | 6 °C/second max | 6 °C/second max |
| Time 25 °C to peak temperature | 6 minutes max | 8 minutes max |

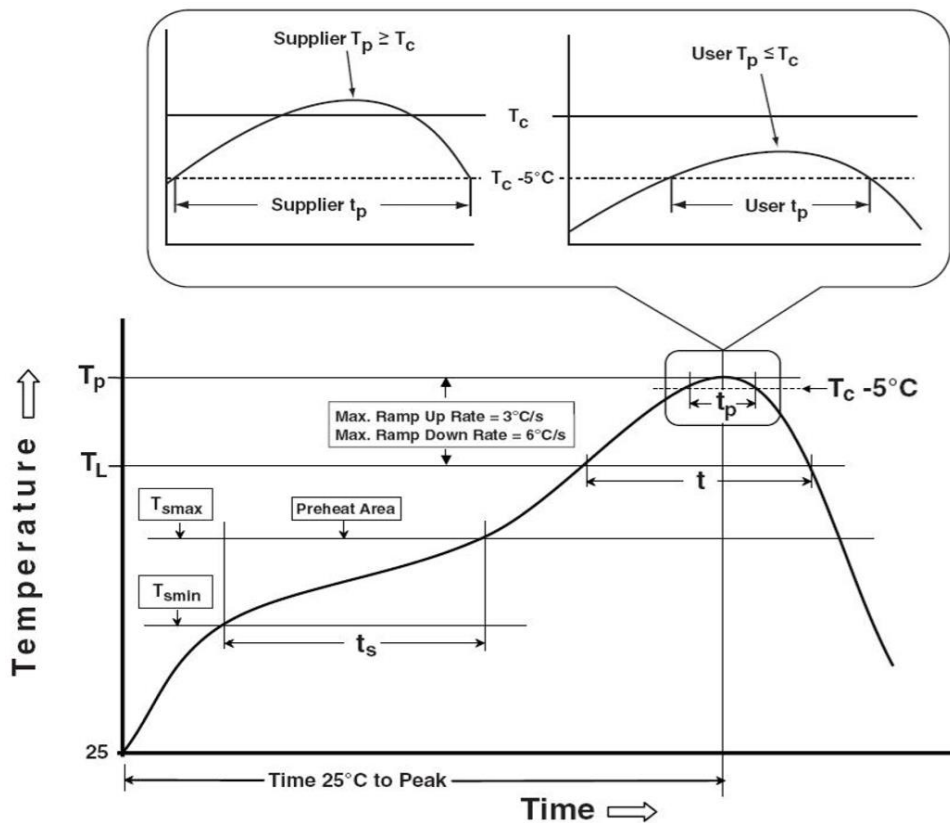
1. Tolerance for peak profile temperature (T_p) is defined as a supplier minimum and a user maximum.
2. Tolerance for time at peak profile temperature (t_p) is defined as a supplier minimum and a user maximum.



Precautions

1. Storage:

- Moisture proof and anti-electrostatic package with moisture absorbent material is used, to keep moisture to a minimum.
- Before opening the package, the product should be kept at 30°C or less and humidity less than 60% RH, and be used within a year.
- After opening the package, the product should be stored at 30°C or less and humidity less than 10%RH. It is recommended that the product be operated at the workshop condition of 30°C or less and humidity less than 60%RH.
- If the moisture absorbent material has faded away or the LEDs have exceeded the storage time, baking treatment should be performed based on the following condition: (70±5)°C for 24 hours.

2. Static Electricity:

Static electricity or surge voltage damages the LEDs. Damaged LEDs will show some unusual characteristics such as the forward voltage becoming lower, or the LEDs do not light at the low current, even not light.

All devices, equipment and machinery must be properly grounded. At the same time, it is recommended that wrist bands or anti-electrostatic gloves, anti-electrostatic containers be used when dealing with the LEDs.

3. Vulcanization:

LED curing is due to sulfur being in brackets and the +1 price of silver in the chemical reaction generated Ag₂S in the process. It will lead to the capacity of reflecting of silver layer reducing, light color temperature drift and serious decline, seriously affecting the performance of the product. So we should take corresponding measures to avoid vulcanization, such as to avoid using sulphur volatile substances and keeping away from high sulphur content of the material.

X-ON Electronics

Largest Supplier of Electrical and Electronic Components

Click to view similar products for [Standard LEDs - SMD category](#):

Click to view products by [EKINGLUX manufacturer](#):

Other Similar products are found below :

[LTST-C190KYKT](#) [LTST-C19GD2WT](#) [LTST-N683GBEW](#) [LTW-170ZDC](#) [LTW-M140SZS40](#) [598-8110-100F](#) [598-8170-100F](#) [598-8610-202F](#) [91-21SURC/S530-A3/TR10](#) [AAAF5060QBFSEEZGS](#) [ALMD-LB36-SV002](#) [APT1608QGW](#) [EAST2012YA0](#) [EASV1803BA0](#) [91-21UYC/S530-A3/TR10](#) [SML-512VWT86A](#) [SML-LX0606SISUGC/A](#) [SML-LXL1307SRC-TR](#) [SML-LXR851SIUPGUBC](#) [LT1ED53A](#) [AM27ZGC03](#) [APB3025SGNC](#) [APFA3010SURKCGKQBDC](#) [APHK1608VGCA](#) [APT2012QGW](#) [CLX6D-FKB-CN1R1H1BB7D3D3](#) [LTST-008BGEW](#) [LTST-C250KGKT](#) [LTW-010DCG](#) [LTW-020ZDCG](#) [LTW-21TS5](#) [LTW-220DS5](#) [42-21UYC/S530-A3/TR8](#) [598-8330-117F](#) [SML-LX0402IC-TR](#) [CMDA20AYAA7D1S](#) [CMDA16AYDR7A1X](#) [91-21SYGD/S530-E2/TR7](#) [598-8040-100F](#) [598-8070-100F](#) [598-8140-100F](#) [598-8610-200F](#) [EAST2012GA0](#) [EAPL3527GA5](#) [SML-LXL1209SYC/ATR](#) [EAST2012RA0](#) [EAST1608RGBA0](#) [LTW-008RGB2-PH1](#) [CMD91-21VRC/TR7](#) [SML-LXR851SGSIC-TR](#)