



# LIGHT EMITTING DIODE SPECIFICATION

CUSTOMER NAME:

DESCRIPTION: EL302YGD

REVISION: V2.2

ISSUE DATE: 2018-07-25

Contains trade secret information which is the property of Ekinglux and shall not be made available to, or copied or used by anyone outside Ekinglux without its written authorization. Copyright © 2017 Ekinglux Optoelectronics Technology Co., Ltd. All rights reserved

**Features:**

- Long operating life
- Low Power Consumption
- Low voltage DC operated
- RoHS Compliant

**Application:**

- Status indicator
- Industrial control panel
- Sensor status indication
- Wearable and portable devices

Part Number	Dice Material	Emitted Color	Lens Color
EL302YGD	AlGaInP	Yellow Green	Green Diffused

**Electro-Optical Characteristics** (Ta=25°C, @20mA)

Parameter	Symbol	Min.	Typ.	Max.	Unit
Luminous Intensity	IV	20	-	50	mcd
Radiation Bandwidth	$\Delta\lambda$	-	30	-	nm
Forward Voltage	VF	1.90	2.00	2.40	v
Luminous Flux	$\Phi$	-	-	-	Lm
Dominant Wavelength	$\lambda d$	567	570	575	nm
CIE Coordinates CIE	x,y	-	-	-	-
Color Temperature	Tc	-	-	-	k
Viewing Angle	2 $\theta$ 1/2	-	80	-	deg
Reverse Current	IR	-	-	10	uA

**Absolute Maximum Ratings** (Ta=25°C)

Parameter	Symbol	Max.	Unit
Peak Forward Current(1/10 Duty Cycle, 0.1ms Pulse Width)	IPF	100	mA
Forward Current	IF	20	mA
Reverse Voltage	VR	5	v
Electrostatic Discharge	ESD	2000	v
Operating Temperature Range	Topr	-40to+90	°C
Storage Temperature Range	Tstg	-40to+90	°C
Reflow Soldering	Tsld	260°C for 10secs	

## Optical & Electrical Characteristics

Relative Intensity vs.Wavelength

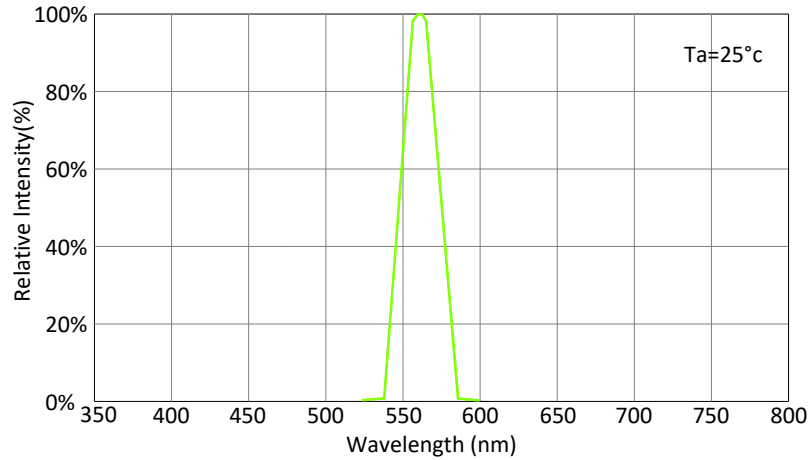

Forward Current vs.Forward Voltage

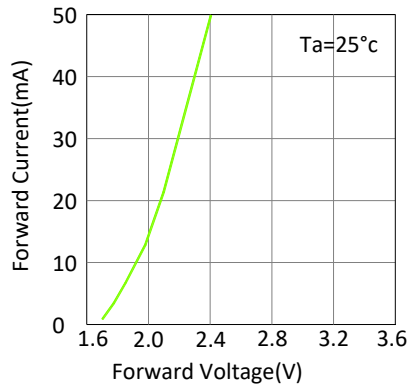

Forward Current vs.Ambient Temperature

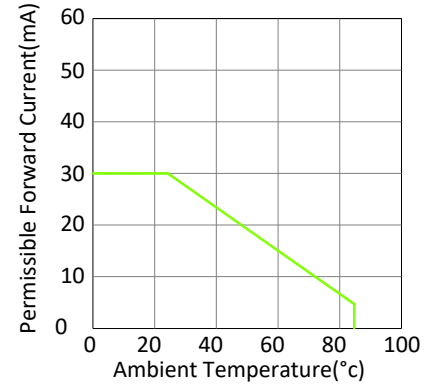

Relative Intensity vs.Forward Current

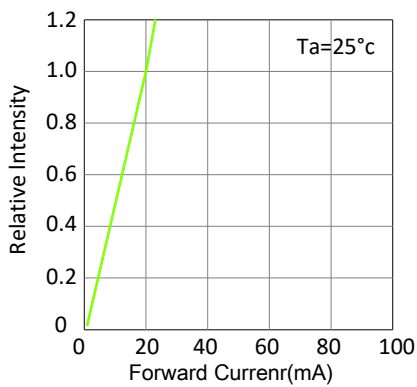

Relative Intensity vs.Ambient Temperature

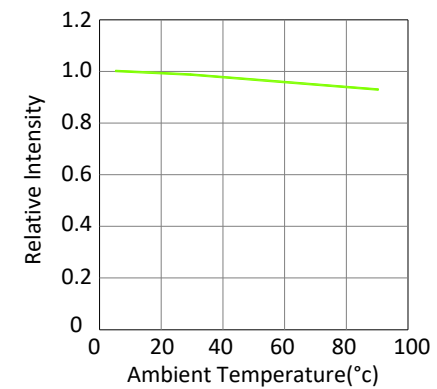

Radiation Pattern

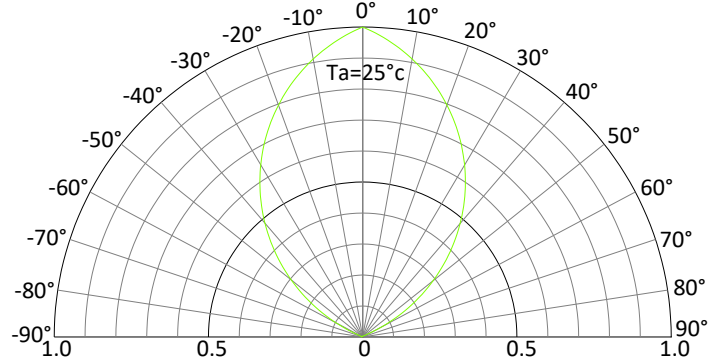

## Bin Limits

### Bin Range Of Luminous Intensity (Unit:mcd)

Bin Code	Min	Max	Condition
L1	20	50	IF=20mA
L2	-	-	
L3	-	-	

### Bin Range Of Forward Voltage (Unit:V)

Bin Code	Min	Max	Condition
V1	1.9	2.0	IF=20mA
V2	2.0	2.1	
V3	2.1	2.2	
V4	2.2	2.3	
V5	2.3	2.4	

### Bin Range Of Wavelength (Unit:nm)

Bin Code	Min	Max	Condition
YG1	567	569	IF=20mA
YG2	569	571	
YG3	571	573	
YG4	573	575	
YG5	-	-	

#### Notes:

- 1.Tolerance of Luminous Intensity  $\pm 10\%$
- 2.Tolerance of Forward Voltage  $\pm 0.1V$

**Reliability Test Items And Conditions**

Test Items	Reference	Test Conditions	Time	Quantity	Criterion
Thermal Shock	MIL-STD-202G	-40°C (30min) -100°C (30min)	100 Cycles	22	0/22
Temperature And Humidity Cyclic	JEITA ED-4701 200 203	-10°C~65°C ; 0%~90%RH	10cycles	22	0/22
High Temperature Storage	JEITA ED -4071 200 201	Ta=100°C	1000H	22	0/22
Low Temperature Storage	JEITA ED -4071 200 202	Ta=-40°C	1000H	22	0/22
High Temperature High Humidity Storage	JEITA ED -4071 100 103	Ta=60°C ; RH=90%	1000H	22	0/22
High Temperature Life Test	JESD22-A108D	Ta=80°C	1000H	22	0/22
Life Test	JESD22-A108D	Ta=25°C IF=20mA	1000H	22	0/22
Resistance to Sodering Heat	GB/T 4937, II , 2.2&2.3	Tsol*=(240±5) °C 10secs	2 times	22	0/22

**Criteria For Judging Damage**

Test Items	Symbol	Test Conditions	Criteria For Judging Damage
Forward Voltage	V <sub>F</sub>	I <sub>F</sub> =I <sub>FT</sub>	Initial Data±10%
Recerse Current	I <sub>R</sub>	V <sub>R</sub> =5V	I <sub>R</sub> ≤10uA
Luminous Intensity	I <sub>V</sub>	I <sub>F</sub> =I <sub>FT</sub>	Average I <sub>V</sub> degradation≤30% ; Single LED I <sub>V</sub> degradation≤50%
Resistance to Soldering Heat	-	-	Material without internal cracks,no material between stripped,no deaded light

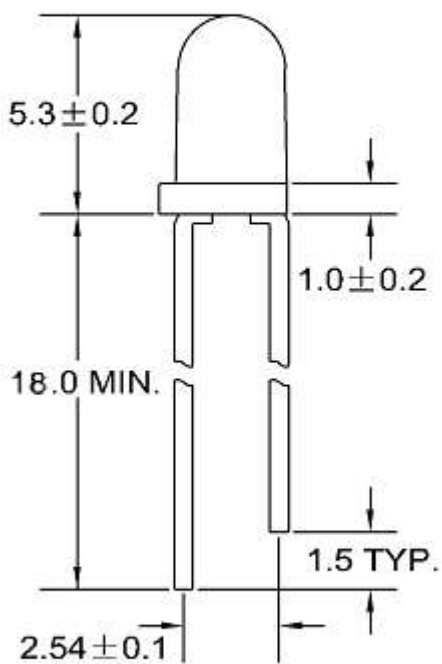
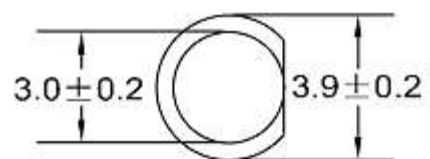
**Product size (Unit:mm)**

□ 0.5 SQUARE\*2



**Notes:**

1. All dimensions are in millimeters (inches).
2. Tolerance is  $\pm 0.25(0.01")$  unless otherwise noted.
3. Lead spacing is measured where the leads emerge from the package.

## LabelStyle

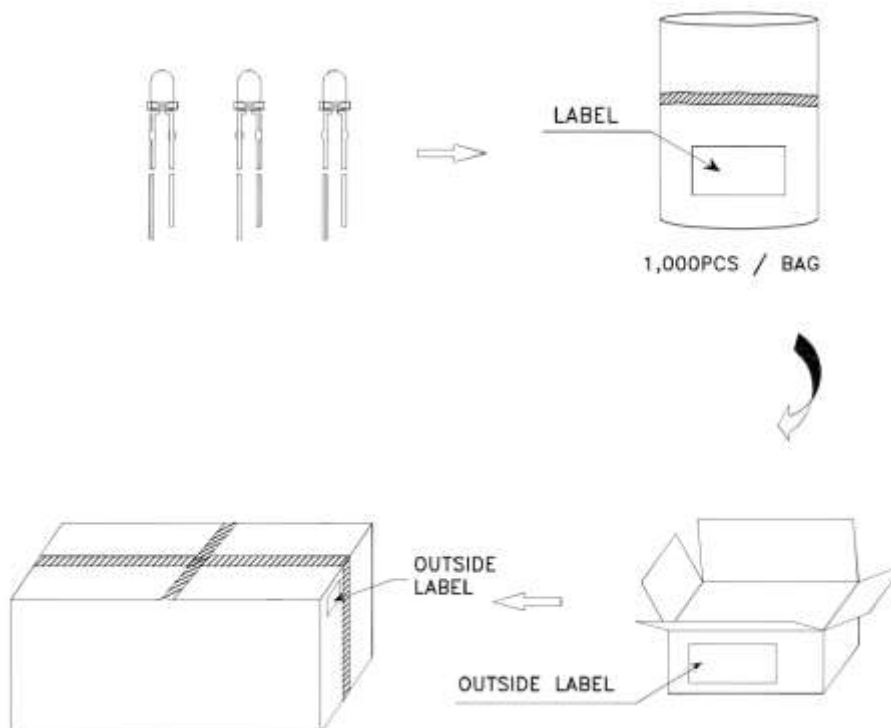

## Packaging



## Precautions

### 1. Lead Forming

- 1.1 During lead formation, the leads should be bent at a point at least 3mm from the base of the epoxy bulb.
- 1.2 Lead forming should be done before soldering.
- 1.3 Avoid stressing the LED package during leads forming. The stress to the base may damage the LED's characteristics or it may break the LEDs.
- 1.4 Cut the LED lead frames at room temperature. Cutting the lead frames at high temperatures may cause failure of the LEDs.
- 1.5 When mounting the LEDs onto a PCB, the PCB holes must be aligned exactly with the lead position of the LED. If the LEDs are mounted with stress at the leads, it causes deterioration of the epoxy resin and this will degrade the LEDs.

### 2. Storage

- 2.1 The LEDs should be stored at 30°C or less and 70%RH or less after being shipped from Everlight and the storage life limits are 3 months. If the LEDs are stored for 3 months or more, they can be stored for a year in a sealed container with a nitrogen atmosphere and moisture absorbent material.
- 2.2 Please avoid rapid transitions in ambient temperature, especially, in high humidity environments where condensation can occur.

### 3. Soldering

- 3.1 Careful attention should be paid during soldering. When soldering, leave more than 3mm from solder joint to epoxy bulb, and soldering beyond the base of the tie bar is recommended.
- 3.2 Recommended soldering conditions:

Hand Soldering		DIP Soldering	
Temp. at tip of iron	300°C Max. (30W Max.)	Preheat temp.	100°C Max. (60 sec Max.)
Soldering time	3 sec Max.	Bath temp. & time	260 Max., 5 sec Max
Distance	3mm Min. (From solder joint to epoxy bulb)	Distance	3mm Min. (From solder joint to epoxy bulb)

### 3.3 Recommended soldering profile

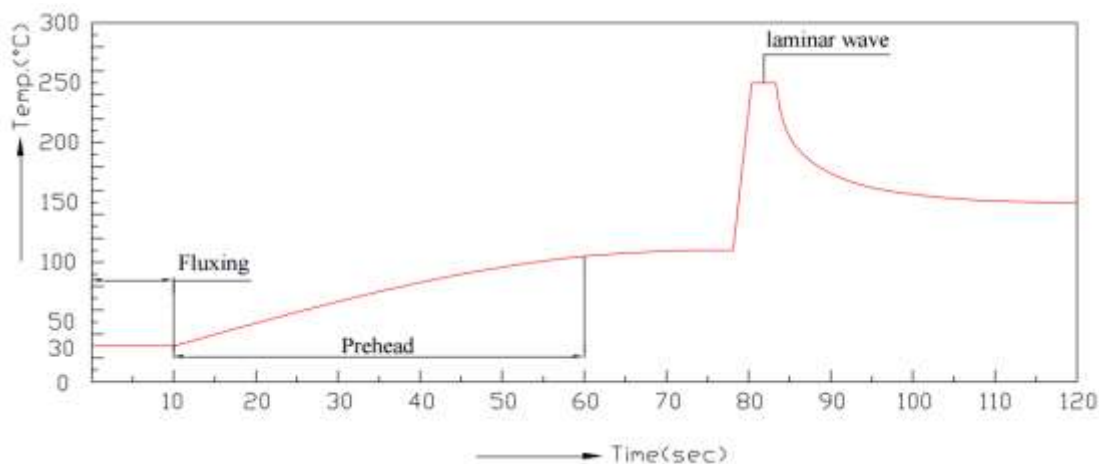



- 3.4 Avoiding applying any stress to the lead frame while the LEDs are at high temperature particularly when soldering.
- 3.5 Dip and hand soldering should not be done more than one time
- 3.6 After soldering the LEDs, the epoxy bulb should be protected from mechanical shock or vibration until the LEDs return to room temperature.
- 3.7 A rapid-rate process is not recommended for cooling the LEDs down from the peak temperature.
- 3.8 Although the recommended soldering conditions are specified in the above table, dip or hand soldering at the lowest possible temperature is desirable for the LEDs.
- 3.9 Wave soldering parameter must be set and maintain according to recommended temperature and dwell time in the solder wave.

#### **4. Cleaning**

- 4.1 When necessary, cleaning should occur only with isopropyl alcohol at room temperature for a duration of no more than one minute. Dry at room temperature before use.
- 4.2 Do not clean the LEDs by the ultrasonic. When it is absolutely necessary, the influence of ultrasonic cleaning on the LEDs depends on factors such as ultrasonic power and the assembled condition. Ultrasonic cleaning shall be pre-qualified to ensure this will not cause damage to the LED

## X-ON Electronics

Largest Supplier of Electrical and Electronic Components

*Click to view similar products for [Standard LEDs - SMD category](#):*

*Click to view products by [EKINGLUX manufacturer](#):*

Other Similar products are found below :

[LTST-C190KYKT](#) [LTST-C19GD2WT](#) [LTST-N683GBEW](#) [LTW-170ZDC](#) [LTW-M140SZS40](#) [LTW-M140ZVS](#) [598-8110-100F](#) [91-21SUBCS400-A6TR7](#) [AAAF5060QBFSEEZGS](#) [APT1608QGW](#) [EAST2012YA0](#) [99-213/R6C-AR2T1B/2C](#) [SML-LX0606SISUGC/A](#) [SML-LXR851SIUPGUBC](#) [LT1ED53A](#) [AM27ZGC03](#) [APFA3010SURKCGKQBDC](#) [APHK1608VGCA](#) [APT2012QGW](#) [LTST-008BGEW](#) [LTW-010DCG](#) [LTW-020ZDCG](#) [LTW-21TS5](#) [LTW-220DS5](#) [LO T67F-V1AB-24-1](#) [598-8330-117F](#) [CMDA20AYAA7D1S](#) [95-21SURCS530-A3TR10](#) [HSMQ-C177](#) [598-8040-100F](#) [598-8070-100F](#) [598-8140-100F](#) [598-8610-200F](#) [SML-LXL1209SYC/ATR](#) [CMD91-21VRC/TR7](#) [SML-512PWT86A](#) [SMF-2432GYC-TR](#) [EASV3015RGYA0](#) [LTST-C190KFKT-5A](#) [LTST-C194TBKT-5A](#) [CLX6E-FKC-CH1M1D1BB7C3D3](#) [SML-LXL0805USBC-TR](#) [SML-LX2835SYSUGCTR](#) [LTW-M670ZVS-M5](#) [APA2106ZGC/G](#) [CLMXB-FKA-CbcfghjnpACBB79463](#) [VFA1101W-5AY3B2-TR](#) [LCB P473-P2R2-3J7L-1-Z](#) [HSMR-C197](#) [LW A67C-S2U1-FK0KM0](#)