

SuperMOS – SOT-23 -20V BV_{DSS} , 90m Ω $R_{DS(on)}$, P-channel MOSFET

1. Description

The AO3401CI-ES is P-Channel enhancement MOS Field Effect Transistor. Uses advanced trench technology and design to provide excellent $R_{DS(ON)}$ with low gate charge. Device is suitable for use in DC-DC conversion, power switch and charging circuit. Standard Product AO3401CI-ES is Pb-free.

2. Features

- -20V, $R_{DS(ON)}$ =90m Ω (TYP.) @ V_{GS} =-4.5V
- $R_{DS(ON)}$ =110m Ω (TYP.) @ V_{GS} =-2.5V
- Fast Switching
- High density cell design for low $R_{DS(on)}$
- Material: Halogen free
- Reliable and rugged
- Avalanche Rated
- Low leakage current

3. Applications

- PWM applications
- Load switch
- Power management in portable/desktop PCs
- DC/DC conversion

4. Ordering Information

| Part Number | Package | Marking | Material | Packing | Quantity per reel | Flammability Rating | Reel Size |
|-------------|---------|---------|--------------|-------------|-------------------|---------------------|-----------|
| AO3401CI-ES | SOT-23 | 2301 | Halogen free | Tape & Reel | 3,000 PCS | UL 94V-0 | 7inches |

Table-1 Ordering information

5. Pin Configuration and Functions

| Pin | Function | Outline | Circuit Diagram |
|-----|----------|---|---|
| 1 | Gate |  |  |
| 2 | Source | | |
| 3 | Drain | | |

Table-2 Pin configuration

6. Specification

Absolute Maximum Rating & Thermal Characteristics

Ratings at 25 °C ambient temperature unless otherwise specified.

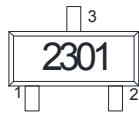
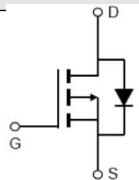
| Parameter | Symbol | Limit | Unit |
|--------------------------------|------------|------------------------|------------------|
| Drain-Source Voltage | BV_{DSS} | -20 | V |
| Gate-Source Voltage | V_{GS} | ± 8 | V |
| Continuous Drain Current | I_D | $T_A=25^\circ\text{C}$ | 2.3 |
| | | $T_A=75^\circ\text{C}$ | 1.7 |
| Maximum Power Dissipation | P_D | $T_A=25^\circ\text{C}$ | 1.4 |
| | | $T_A=75^\circ\text{C}$ | 0.84 |
| Pulsed Drain Current | I_{DM} | 9.2 | A |
| Operating Junction Temperature | T_J | 150 | $^\circ\text{C}$ |
| Storage Temperature Range | T_{stg} | -55 to +150 | $^\circ\text{C}$ |

Thermal resistance ratings

| Single Operation | | | |
|--|-----------------|---------|--------------------|
| Parameter | Symbol | Typical | Unit |
| Junction-to-Ambient Thermal Resistance | $R_{\theta JA}$ | 90 | $^\circ\text{C/W}$ |

Electrical Characteristics

At TA = 25°C unless otherwise specified

| Parameter | Symbol | Test Conditions | Min. | Typ. | Max. | Unit |
|--|--------------|--|------|------|-----------|------------|
| OFF CHARACTERISTICS | | | | | | |
| Drain-to-Source Breakdown Voltage | BV_{DSS} | $V_{GS}=0V, I_D=-250\mu A$ | -20 | | | V |
| Zero Gate Voltage Drain Current | I_{DSS} | $V_{DS}=-20V, V_{GS}=0V$ | | | -1 | μA |
| Gate-to-source Leakage Current | I_{GSS} | $V_{DS}=0V, V_{GS}=\pm 8V$ | | | ± 100 | nA |
| ON CHARACTERISTICS | | | | | | |
| Gate Threshold Voltage | $V_{GS(TH)}$ | $V_{GS}=V_{DS}, I_D=-250\mu A$ | -0.4 | -0.7 | -1.0 | V |
| Drain-to-source On-resistance | $R_{DS(on)}$ | $V_{GS}=-4.5V, I_D=-2.3A$ | | 90 | 112 | m Ω |
| | | $V_{GS}=-2.5V, I_D=-2A$ | | 110 | 142 | |
| Forward trans conductance(a) | gfs | $V_{DS}=-5V, I_D=-2.3A$ | | 6.5 | | S |
| CHARGES, CAPACITANCES AND GATE RESISTANCE | | | | | | |
| Input Capacitance | C_{ISS} | $V_{GS}=0V, V_{DS}=-10V,$ $f=1MHz$ | | | 405 | pF |
| Output Capacitance | C_{OSS} | | | | 75 | |
| Reverse Transfer Capacitance | C_{RSS} | | | | 55 | |
| Gate Resistance | R_g | $f=1MHz$ | | 6 | | Ω |
| Total Gate Charge | $Q_{G(TOT)}$ | $V_{GS}=-2.5V, V_{DS}=-10V,$ $I_D=-2.3A$ | | 3.3 | 6 | nC |
| Gate-to-Source Charge | Q_{GS} | | | 0.7 | | |
| Gate-to-Drain Charge | Q_{GD} | | | 1.3 | | |
| SWITCHING CHARACTERISTICS | | | | | | |
| Turn-On Delay Time | $t_{d(ON)}$ | $V_{GS}=-4.5V, V_{DS}=10V,$ $R_L=10\Omega, I_D=-1A,$ $R_G=1\Omega$ | | 11 | 20 | ns |
| Rise Time | t_r | | | 35 | 60 | |
| Turn-Off Delay Time | $t_{d(OFF)}$ | | | 30 | 50 | |
| Fall Time | t_f | | | 10 | 20 | |
| BODY DIODE CHARACTERISTICS | | | | | | |
| Forward Voltage | V_{SD} | $V_{GS}=0V, I_S=-1.0A$ | | -0.8 | -1.5 | V |

7. Typical Characteristic

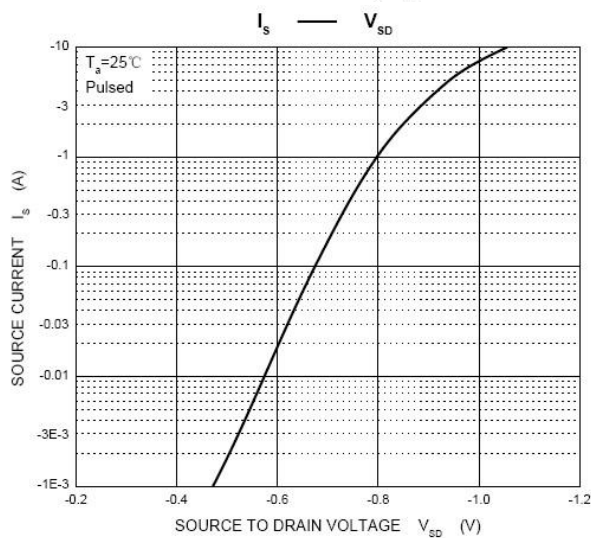
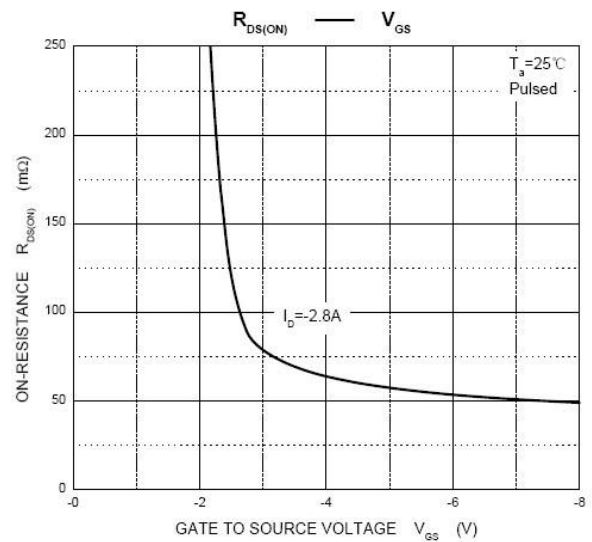
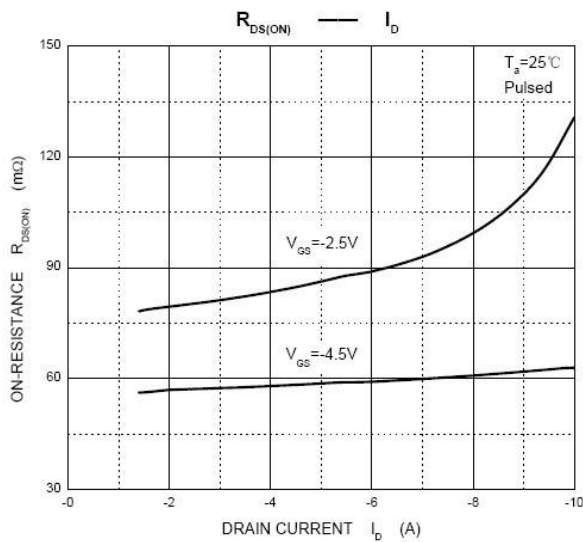
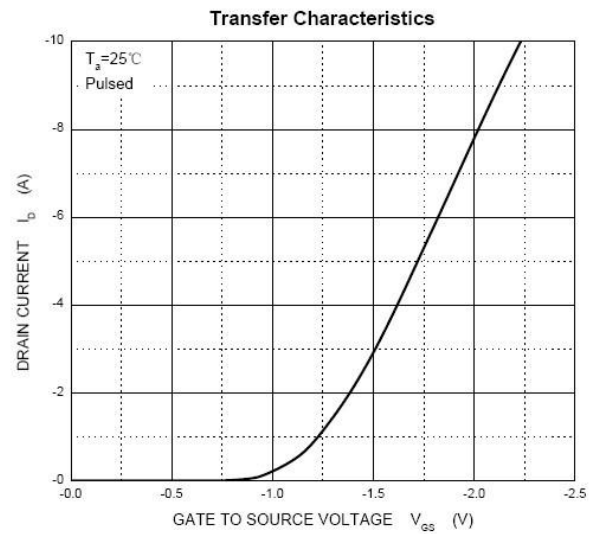
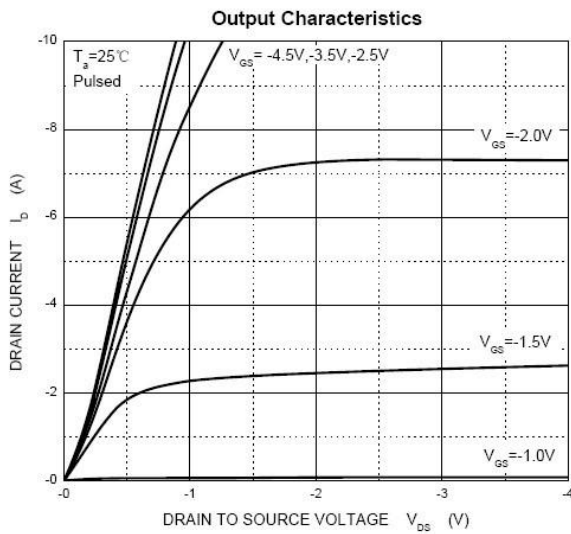

8. Dimension (SOT-23)

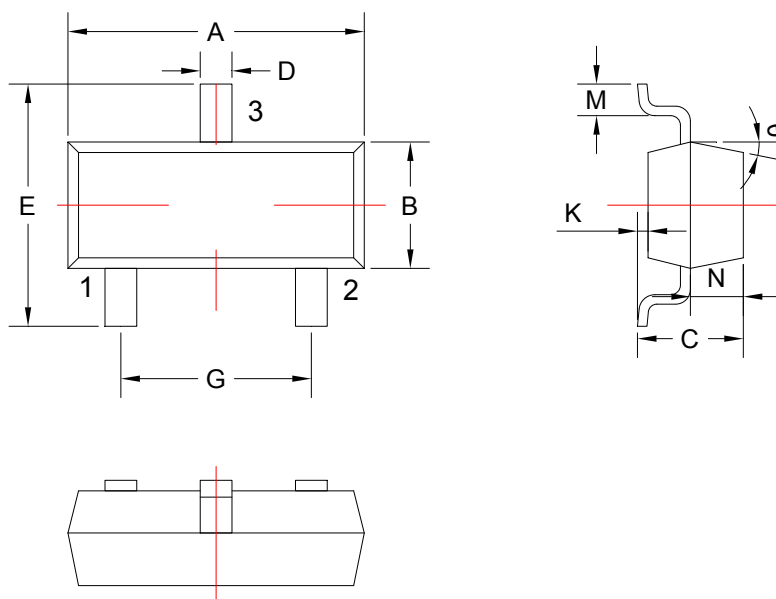

| COMMON DIMENSIONS CUNITS MEASURE=MILLIMETER | | | | | |
|---|------|------|--------|------|------|
| SYMBOL | MIN | MAX | SYMBOL | MIN | MAX |
| A | 2.85 | 3.04 | G | 1.80 | 2.00 |
| B | 1.20 | 1.40 | K | 0 | 0.10 |
| C | 0.90 | 1.10 | M | 0.20 | - |
| D | 0.40 | 0.50 | N | 0.50 | 0.70 |
| E | 2.25 | 2.55 | θ | 5° | 9° |

DISCLAIMER

ELECSUPER PROVIDES TECHNICAL AND RELIABILITY DATA (INCLUDING DATASHEETS), DESIGN RESOURCES (INCLUDING REFERENCE DESIGNS), APPLICATION OR OTHER DESIGN ADVICE, SAFETY INFORMATION, AND OTHER RESOURCES “AS IS” AND WITH ALL FAULTS, AND DISCLAIMS ALL WARRANTIES, EXPRESS AND IMPLIED, INCLUDING WITHOUT LIMITATION ANY IMPLIED WARRANTIES OF MERCHANTABILITY, FITNESS FOR A PARTICULAR PURPOSE OR NON-INFRINGEMENT OF THIRD PARTY INTELLECTUAL PROPERTY RIGHTS.

These resources are intended for skilled developers designing with ElecSuper products. You are solely responsible for

- (1) selecting the appropriate ElecSuper products for your application;
- (2) designing, validating and testing your application;
- (3) ensuring your application meets applicable standards, and any other safety, security, or other requirements.

These resources are subject to change without notice. ElecSuper grants you permission to use these resources only for development of an application that uses the ElecSuper products described in the resource. Other reproduction and display of these resources are prohibited. No license is granted to any other ElecSuper intellectual property right or to any third party intellectual property right. ElecSuper disclaims responsibility for, and you will fully indemnify ElecSuper and its representatives against, any claims, damages, costs, losses, and liabilities arising out of your use of these resources. ElecSuper's products are provided subject to ElecSuper's Terms of Sale or other applicable terms available either on www.elecsuper.com or provided in conjunction with such ElecSuper products. ElecSuper's provision of these resources does not expand or otherwise alter ElecSuper's applicable warranties or warranty disclaimers for ElecSuper products.

X-ON Electronics

Largest Supplier of Electrical and Electronic Components

Click to view similar products for [MOSFET](#) category:

Click to view products by [ElecSuper](#) manufacturer:

Other Similar products are found below :

[IRFD120](#) [JANTX2N5237](#) [BUK455-60A/B](#) [MIC4420CM-TR](#) [VN1206L](#) [NDP4060](#) [SI4482DY](#) [IPS70R2K0CEAKMA1](#) [SQD23N06-31L-GE3](#)
[TK16J60W,S1VQ\(O](#) [2SK2614\(TE16L1,Q\)](#) [DMN1017UCP3-7](#) [DMN1053UCP4-7](#) [SQJ469EP-T1-GE3](#) [NTE2384](#) [DMC2700UDMQ-7](#)
[DMN2080UCB4-7](#) [DMN61D9UWQ-13](#) [US6M2GTR](#) [DMN31D5UDJ-7](#) [DMP22D4UFO-7B](#) [DMN1006UCA6-7](#) [DMN16M9UCA6-7](#)
[STF5N65M6](#) [IRF40H233XTMA1](#) [STU5N65M6](#) [DMN6022SSD-13](#) [DMN13M9UCA6-7](#) [DMTH10H4M6SPS-13](#) [DMN2990UFB-7B](#)
[IPB80P04P405ATMA2](#) [2N7002W-G](#) [MCAC30N06Y-TP](#) [MCQ7328-TP](#) [BXP7N65D](#) [BXP4N65F](#) [AOL1454G](#) [WMJ80N60C4](#) [BXP2N20L](#)
[BXP2N65D](#) [BXT1150N10J](#) [BXT1700P06M](#) [TSM60NB380CP](#) [ROG](#) [RQ7L055BGTCR](#) [DMNH15H110SK3-13](#) [SLF10N65ABV2](#)
[BSO203SP](#) [BSO211P](#) [IPA60R230P6](#) [IPA60R460CE](#)