

**SuperMOS –SOP8 45V  $V_{DSS}$  17m $\Omega$   $R_{DS(on)}$  9.6A  $I_D$ , N-channel MOSFET**

**1. Description**

The AO4884 is N-Channel enhancement MOS Field Effect Transistor. Uses advanced trench technology and design to provide excellent  $R_{DS(ON)}$  with low gate charge. Device is suitable for use in DC-DC conversion, power switch and charging circuit. Standard Product AO4884 is Pb-free.

**2. Features**

- 45V,  $R_{DS(ON)}=17m\Omega(Typ)$ ,  $V_{GS}=10V$
- $R_{DS(ON)}=22m\Omega(Typ)$ ,  $V_{GS}=4.5V$
- Use trench MOSFET technology
- High density cell design for low  $R_{DS(on)}$
- Material: Halogen free
- Reliable and rugged
- Avalanche Rated
- Low leakage current

**3. Applications**

- PWM applications
- Load switch
- Power management in portable/desktop PCs
- DC/DC conversion

**100% UIS TESTED**

**4. Ordering Information**

Part Number	Package	Marking	Material	Packing	Quantity per reel	Flammability Rating	Reel Size
AO4884	SOP8	ES4884/lot	Halogen free	Tape & Reel	3,000 PCS	UL 94V-0	13 inches

Table-1 Ordering information

**5. Pin Configuration and Functions**

Pin	Function	Outline	Circuit Diagram
1	Source1		
2	Gate1		
7/8	Drain1		
3	Source2		
4	Gate2		
5/6	Drain2		

Table-2 Pin configuration

## 6. Specification

### Absolute Maximum Rating & Thermal Characteristics

Ratings at 25 °C ambient temperature unless otherwise specified.

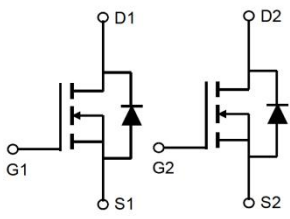
Parameter	Symbol	Limit	Unit	
Drain-Source Voltage	$BV_{DSS}$	45	V	
Gate-Source Voltage	$V_{GS}$	±20	V	
Continuous Drain Current	$I_D$	$T_A=25^{\circ}C$	9.6	A
		$T_A=75^{\circ}C$	7.5	
Maximum Power Dissipation	$P_D$	$T_A=25^{\circ}C$	3.2	W
		$T_A=75^{\circ}C$	1.9	
Pulsed Drain Current <sup>a</sup>	$I_{DM}$	38	A	
Operating Junction Temperature	$T_J$	150	°C	
Lead Temperature	$T_L$	260	°C	
Storage Temperature Range	$T_{stg}$	-55 to 150	°C	

#### Thermal resistance ratings

Single Operation					
Parameter		Symbol	Typical	Maximum	Unit
Junction-to-Ambient Thermal Resistance <sup>a</sup>	$t \leq 10$ s	$R_{\theta JA}$	32	40	°C/W

Note:

a: Surface mounted on FR4 Board using 1 square inch pad size, 1oz copper

## Electrical Characteristics

At TA = 25°C unless otherwise specified

Parameter	Symbol	Test Conditions	Min.	Typ.	Max.	Unit
<b>OFF CHARACTERISTICS</b>						
Drain-to-Source Breakdown Voltage	$BV_{DSS}$	$V_{GS}=0V, I_D=250\mu A$	45			V
Zero Gate Voltage Drain Current	$I_{DSS}$	$V_{DS}=45V, V_{GS}=0V$			1.0	$\mu A$
Gate-to-source Leakage Current	$I_{GSS}$	$V_{DS}=0V, V_{GS}=\pm 20V$			$\pm 100$	nA
<b>ON CHARACTERISTICS</b>						
Gate Threshold Voltage	$V_{GS(TH)}$	$V_{GS}=V_{DS}, I_D=250\mu A$	1.0	1.4	1.8	V
Drain-to-source On-resistance	$R_{DS(on)}$	$V_{GS}=10V, I_D=8A$		17	22	m $\Omega$
		$V_{GS}=4.5V, I_D=6A$		22	30	
Forward Trans conductance	$g_{FS}$	$V_{DS}=5.0V, I_D=8A$			80	S
<b>CHARGES, CAPACITANCES AND GATE RESISTANCE</b>						
Input Capacitance	$C_{ISS}$	$V_{GS}=0V, f=1MHz, V_{DS}=15V$		1500		pF
Output Capacitance	$C_{OSS}$			215		
Reverse Transfer Capacitance	$C_{RSS}$			140		
Total Gate Charge	$Q_{G(TOT)}$	$V_{GS}=4.5V, V_{DS}=15V, I_D=8A$		28		nC
Gate-to-Source Charge	$Q_{GS}$			4.5		
Gate-to-Drain Charge	$Q_{GD}$			6.6		
<b>SWITCHING CHARACTERISTICS</b>						
Turn-On Delay Time	$t_{d(ON)}$	$V_{GS}=10V, V_{DS}=15V, R_L=1.5\Omega, R_{GEN}=3\Omega$		6.5		ns
Rise Time	$t_r$			17.6		
Turn-Off Delay Time	$t_{d(OFF)}$			19.8		
Fall Time	$t_f$			16.6		
<b>BODY DIODE CHARACTERISTICS</b>						
Forward Voltage	$V_{SD}$	$V_{GS}=0V, I_S=1.0A$	0.45		1.2	V

7. Typical Characteristic

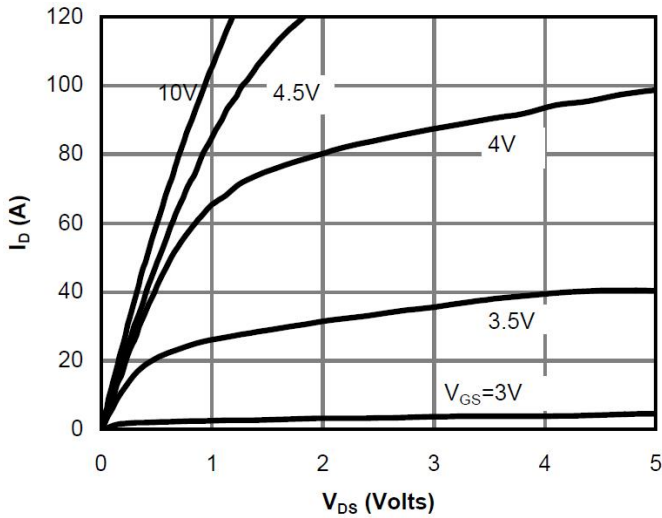

Fig 1: On-Region Characteristics

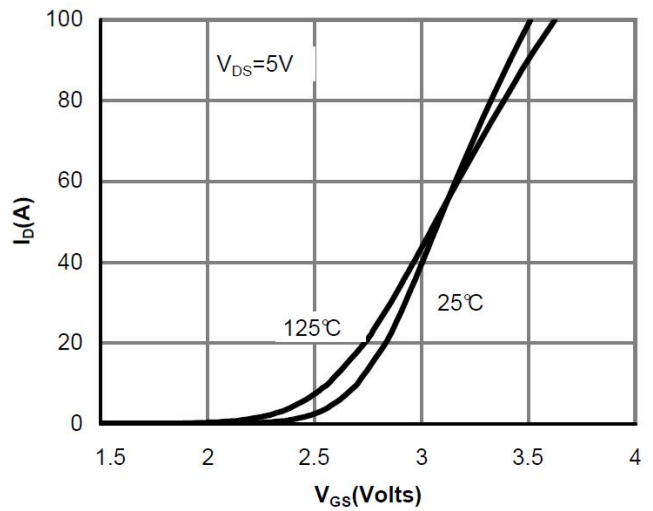

Figure 2: Transfer Characteristics

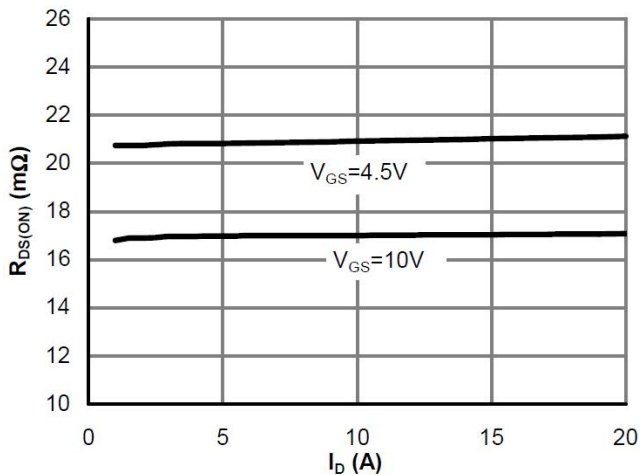

Figure 3: On-Resistance vs. Drain Current and Gate Voltage

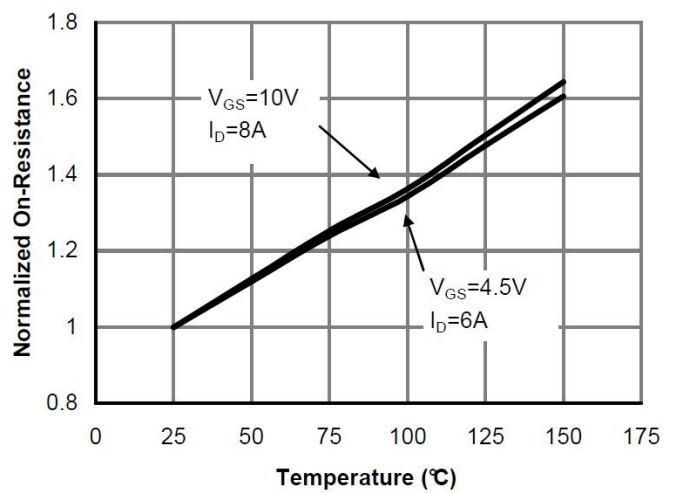

Figure 4: On-Resistance vs. Junction Temperature

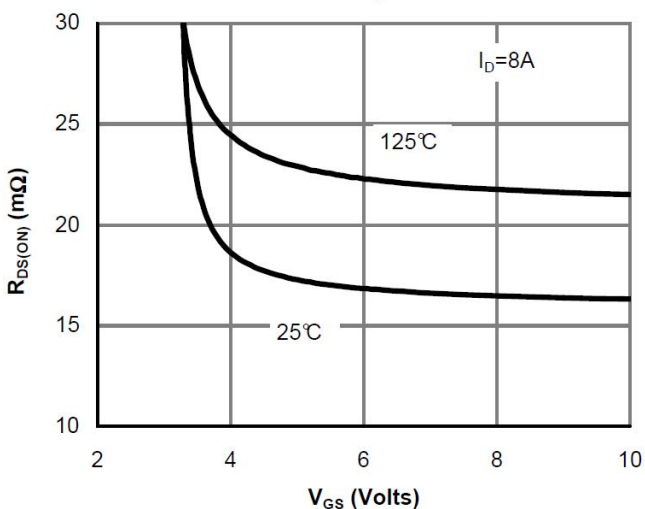

Figure 5: On-Resistance vs. Gate-Source Voltage

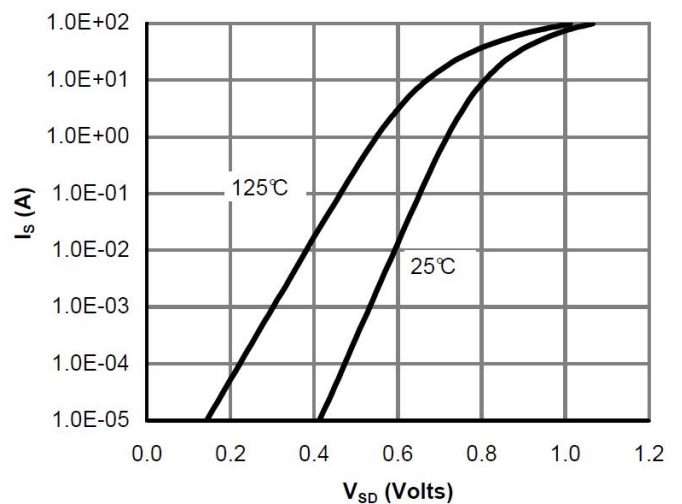

Figure 6: Body-Diode Characteristics

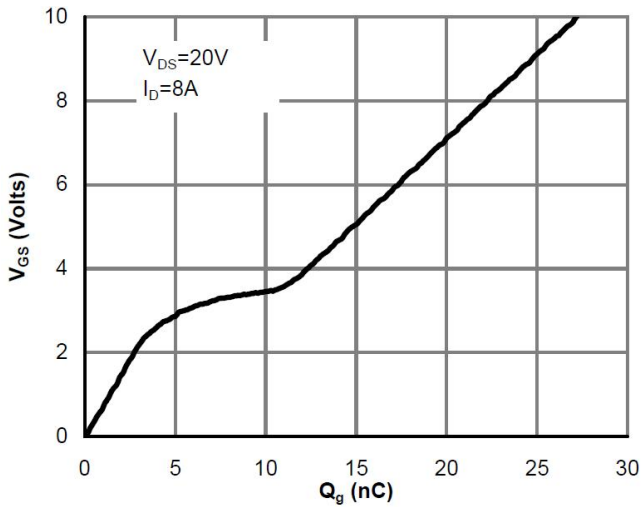

Figure 7: Gate-Charge Characteristics

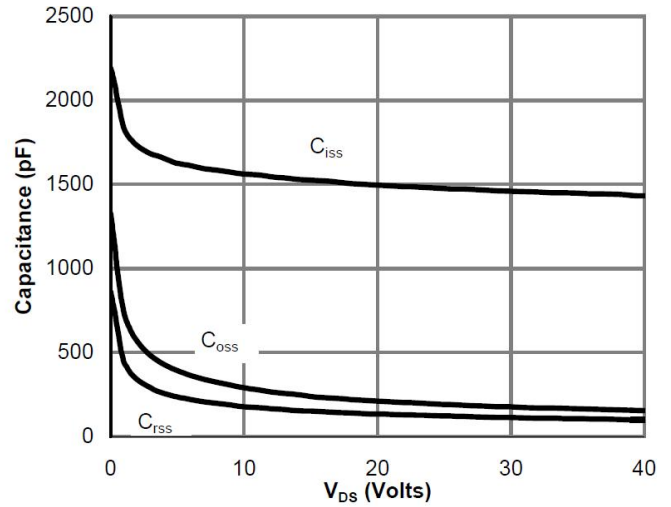

Figure 8: Capacitance Characteristics

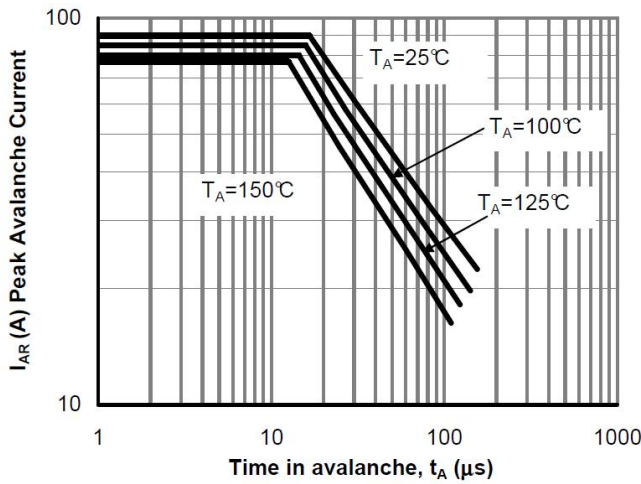

Figure 9: Single Pulse Avalanche capability

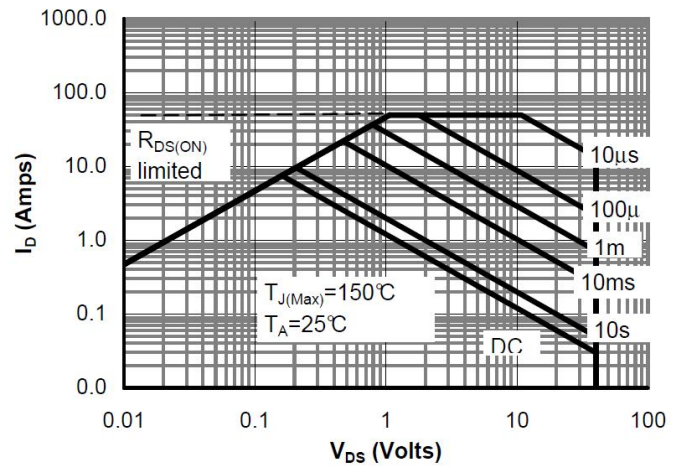

Figure 10: Maximum Forward Biased Safe Operating Area

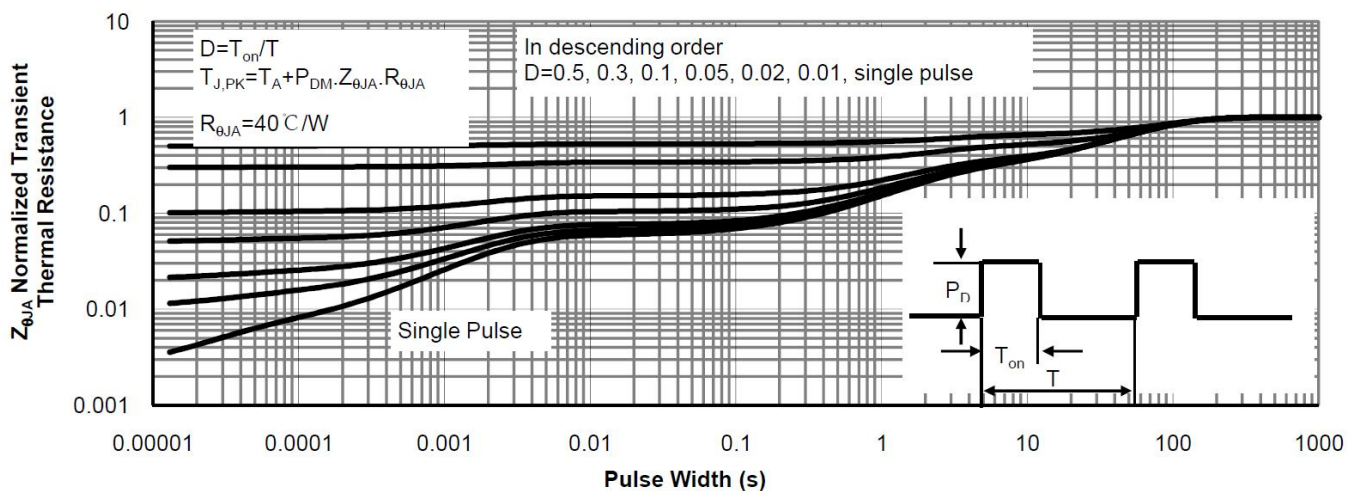
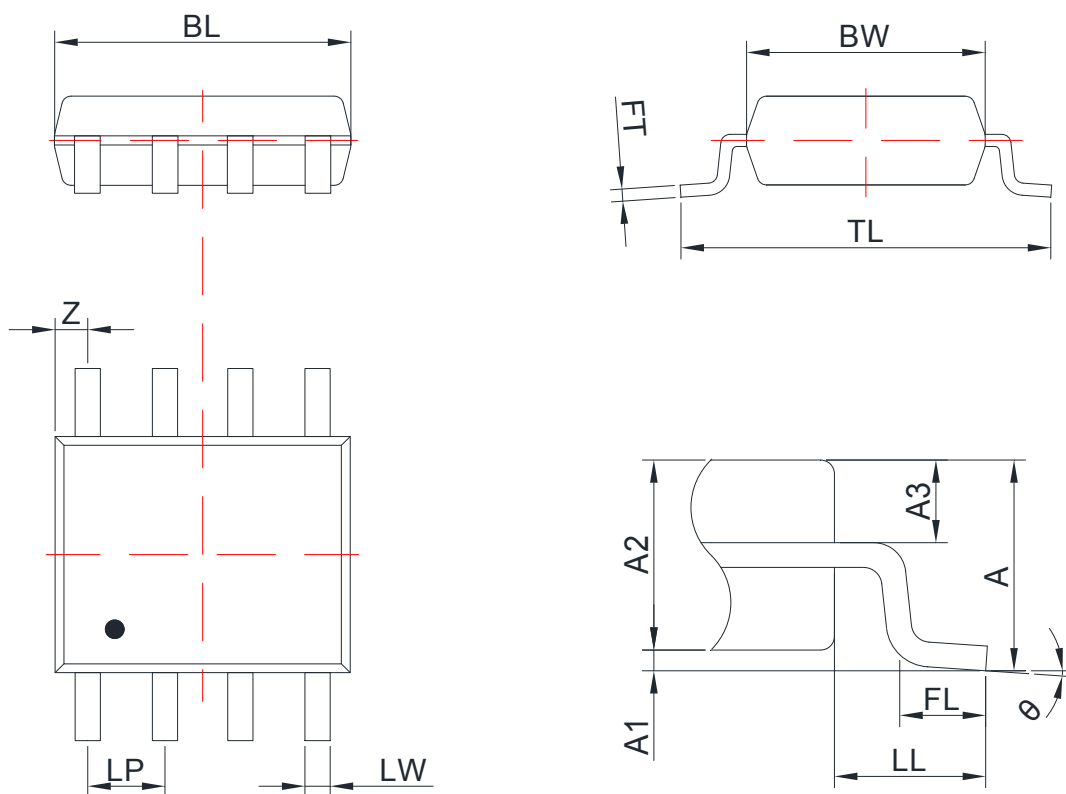

Figure 11: Normalized Maximum Transient Thermal Impedance



**8. Dimension (SOP8)**



**COMMON DIMENSIONS: UNITS OF MEASURE=MILLIMETER**

Symbol	Dimensions		Symbol	Dimensions	
	Min.	Max.		Min.	Max.
A	1.75		FL	0.50	0.80
A1	0.05	0.15	LP	1.25	1.30
A2	1.40	1.50	LL	1.1 BSC	
A3	0.623 BSC		LW	0.38	0.43
BL	4.92	5.80	TL	5.90	6.10
BW	3.70	4.10	Z	0.54	
FT	0.20	0.21	theta	0°	8°

**DISCLAIMER**

ELECSUPER PROVIDES TECHNICAL AND RELIABILITY DATA (INCLUDING DATASHEETS), DESIGN RESOURCES (INCLUDING REFERENCE DESIGNS), APPLICATION OR OTHER DESIGN ADVICE, SAFETY INFORMATION, AND OTHER RESOURCES "AS IS" AND WITH ALL FAULTS, AND DISCLAIMS ALL WARRANTIES, EXPRESS AND IMPLIED, INCLUDING WITHOUT LIMITATION ANY IMPLIED WARRANTIES OF MERCHANTABILITY, FITNESS FOR A PARTICULAR PURPOSE OR NON-INFRINGEMENT OF THIRD PARTY INTELLECTUAL PROPERTY RIGHTS.

These resources are intended for skilled developers designing with ElecSuper products. You are solely responsible for

- (1) selecting the appropriate ElecSuper products for your application;
- (2) designing, validating and testing your application;
- (3) ensuring your application meets applicable standards, and any other safety, security, or other requirements.

These resources are subject to change without notice. ElecSuper grants you permission to use these resources only for development of an application that uses the ElecSuper products described in the resource. Other reproduction and display of these resources are prohibited. No license is granted to any other ElecSuper intellectual property right or to any third party intellectual property right. ElecSuper disclaims responsibility for, and you will fully indemnify ElecSuper and its representatives against, any claims, damages, costs, losses, and liabilities arising out of your use of these resources. ElecSuper's products are provided subject to ElecSuper's Terms of Sale or other applicable terms available either on [www.elecsuper.com](http://www.elecsuper.com) or provided in conjunction with such ElecSuper products. ElecSuper's provision of these resources does not expand or otherwise alter ElecSuper's applicable warranties or warranty disclaimers for ElecSuper products.



## X-ON Electronics

Largest Supplier of Electrical and Electronic Components

*Click to view similar products for [MOSFET](#) category:*

*Click to view products by [ElecSuper](#) manufacturer:*

Other Similar products are found below :

[IRFD120](#) [JANTX2N5237](#) [BUK455-60A/B](#) [MIC4420CM-TR](#) [VN1206L](#) [NDP4060](#) [SI4482DY](#) [IPS70R2K0CEAKMA1](#) [SQD23N06-31L-GE3](#)  
[TK16J60W,S1VQ\(O](#) [2SK2614\(TE16L1,Q\)](#) [DMN1017UCP3-7](#) [DMN1053UCP4-7](#) [SQJ469EP-T1-GE3](#) [NTE2384](#) [DMC2700UDMQ-7](#)  
[DMN2080UCB4-7](#) [DMN61D9UWQ-13](#) [US6M2GTR](#) [DMN31D5UDJ-7](#) [DMP22D4UFO-7B](#) [DMN1006UCA6-7](#) [DMN16M9UCA6-7](#)  
[STF5N65M6](#) [IRF40H233XTMA1](#) [STU5N65M6](#) [DMN6022SSD-13](#) [DMN13M9UCA6-7](#) [DMTH10H4M6SPS-13](#) [DMN2990UFB-7B](#)  
[IPB80P04P405ATMA2](#) [2N7002W-G](#) [MCAC30N06Y-TP](#) [MCQ7328-TP](#) [NTMC083NP10M5L](#) [BXP7N65D](#) [BXP4N65F](#) [AOL1454G](#)  
[WMJ80N60C4](#) [BXP2N20L](#) [BXP2N65D](#) [BXT1150N10J](#) [BXT1700P06M](#) [TSM60NB380CP](#) [ROG](#) [RQ7L055BGTGR](#) [DMNH15H110SK3-13](#)  
[SLF10N65ABV2](#) [BSO203SP](#) [BSO211P](#) [IPA60R230P6](#)